

# Gateway

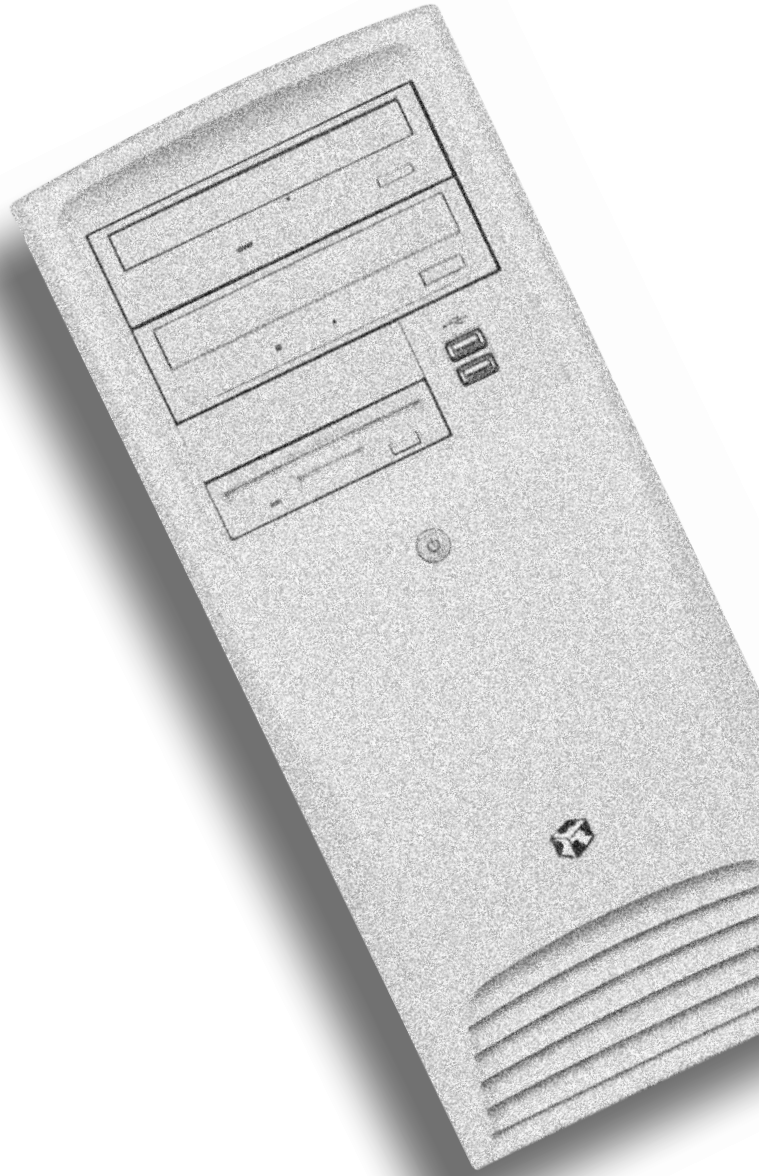

## **Gateway® E-4650 System Manual**



# Contents

<b>Preface</b> .....	<b>v</b>
Conventions used in this manual .....	v
Getting additional information .....	vi
<b>1 Checking Out Your Gateway Computer</b> .....	<b>1</b>
Gateway Mid-Tower front .....	2
Gateway Mid-Tower back .....	4
Heceta IV hardware management .....	7
<b>2 System Setup</b> .....	<b>9</b>
Setting up your computer .....	9
Starting your computer .....	10
Understanding the Power-On Self-Test .....	11
Setting up the operating system .....	11
Turning off your computer .....	12
Restarting your computer .....	13
<b>3 Working with the Gateway Mid-Tower case</b> .....	<b>15</b>
Preventing static electricity discharge .....	15
Opening and closing .....	17
Adding or replacing drives .....	21
Preparing to add or replace a drive .....	21
Drive cabling information .....	22
Adding or replacing drives .....	22
Replacing expansion cards .....	30
Replacing the power supply .....	33
Replacing the system board .....	35
Installing memory .....	37
Installing or replacing RIMM memory .....	37
Replacing the battery .....	42
<b>4 Using the BIOS Setup Utility</b> .....	<b>45</b>
About the BIOS Setup utility .....	45
Updating the BIOS .....	48
Setting the BIOS configuration jumper .....	49
<b>5 Managing Your Computer</b> .....	<b>51</b>
Protecting against power source problems .....	51

Surge suppressors .....	51
Line conditioners .....	52
Uninterruptible power supplies .....	52
Power management .....	53
Using Standby mode .....	54
Changing power settings .....	55
Changing the power scheme .....	55
Changing advanced power settings .....	57
Activating Hibernate mode .....	58
Installing an Uninterruptible Power Supply in Windows XP .....	59
Protecting your computer from viruses .....	61
Managing hard drive space .....	63
Checking hard drive space .....	63
Using Disk Cleanup .....	64
Checking the hard drive for errors .....	65
Defragmenting the hard drive .....	67
Backing up files .....	69
Using the Scheduled Task Wizard .....	70
Cleaning your computer .....	71
Cleaning the exterior .....	71
Cleaning the keyboard .....	72
Cleaning the screen .....	72
Cleaning the mouse .....	72
Checking system health with LANDesk .....	74
System recovery .....	75
Creating a startup diskette .....	75
Keeping a record of system configuration .....	75
Using your System Restoration CD .....	75
<b>6 Troubleshooting .....</b>	<b>77</b>
Introduction .....	77
Troubleshooting checklist .....	77
Verifying your configuration .....	77
Troubleshooting guidelines .....	78
Battery installation problems .....	78
CD drive problems .....	80
Computer problems .....	82
Diskette drive problems .....	84
Hard drive problems .....	85
Memory problems .....	86
Modem problems .....	87
Peripheral/adaptor problems .....	88
Printer problems .....	89

Video problems .....	90
Error messages .....	92
Beep codes .....	94
<b>A Reference Data .....</b>	<b>97</b>
Intel 850 ATX System Board Technical Reference .....	97
Features .....	97
System board layout .....	98
BIOS configuration jumper settings .....	103
Specifications .....	104
<b>B Safety, Regulatory, and Legal Information .....</b>	<b>107</b>
<b>Index .....</b>	<b>119</b>



# Preface

## Conventions used in this manual

Throughout this manual, you will see the following conventions:

Convention	Description
ENTER	Keyboard key names are printed in small capitals.
CTRL+ALT+DEL	A plus sign means to press the keys at the same time.
<b>Setup</b>	Commands to be entered, options to select, and messages that appear on your monitor are printed in bold.
<i>User's Guide</i>	Names of publications are printed in italic.
Viewpoint	All references to front, back, left, or right on the computer are based on the computer being in a normal, upright position, as viewed from the front.

### Important



A note labeled important informs you of special circumstances.

### Caution



A caution warns you of possible damage to equipment or loss of data.

### Warning



A warning indicates the possibility of personal injury.

# Getting additional information

Log on to the technical support area of [www.gatewayatwork.com](http://www.gatewayatwork.com) to find information about your computer or other Gateway products. Some types of information you can access are:

- Hardware driver and program updates
- Technical tips
- Service agreement information
- Technical documents and component information
- Frequently asked questions (FAQs)
- Documentation for peripherals or optional components
- Online technical support



# Checking Out Your Gateway Computer

# 1





This chapter provides basic information about your Gateway computer. Read this chapter to find out:

- Where components and connectors are located
- What accessories are available

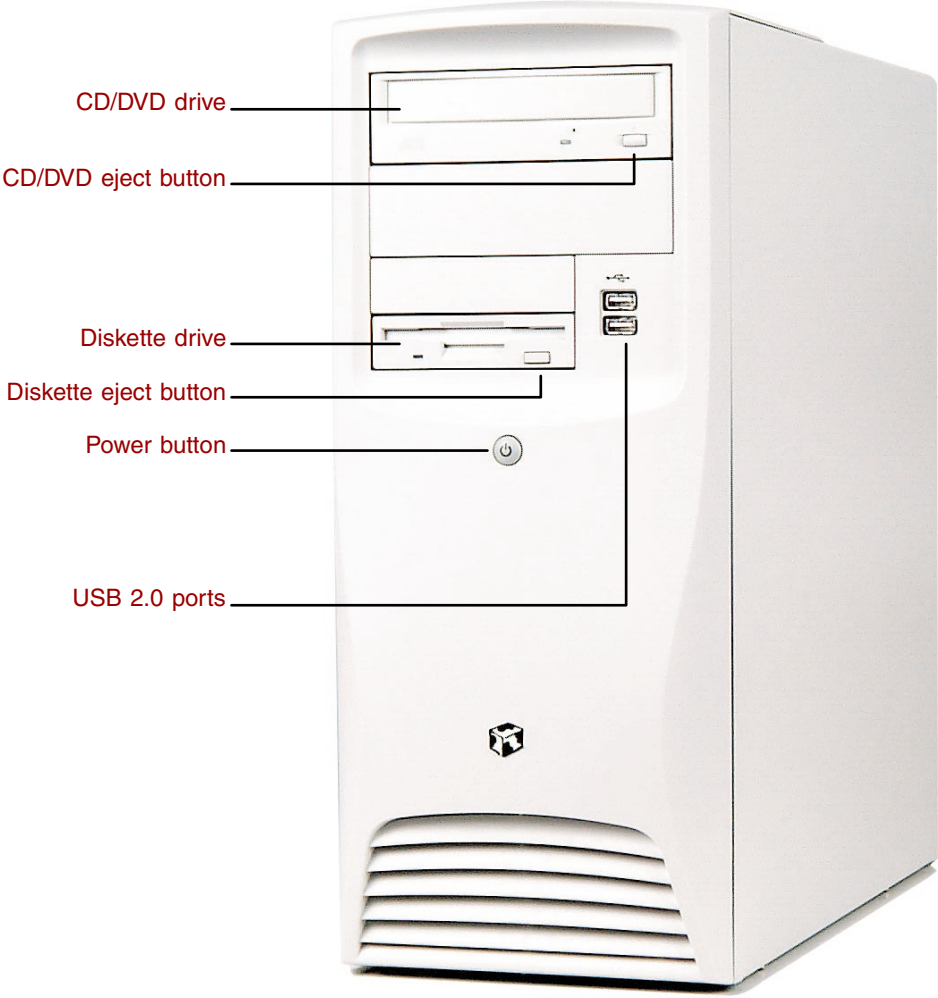
These illustrations show typical computer systems. Your computer system may not look exactly the same.







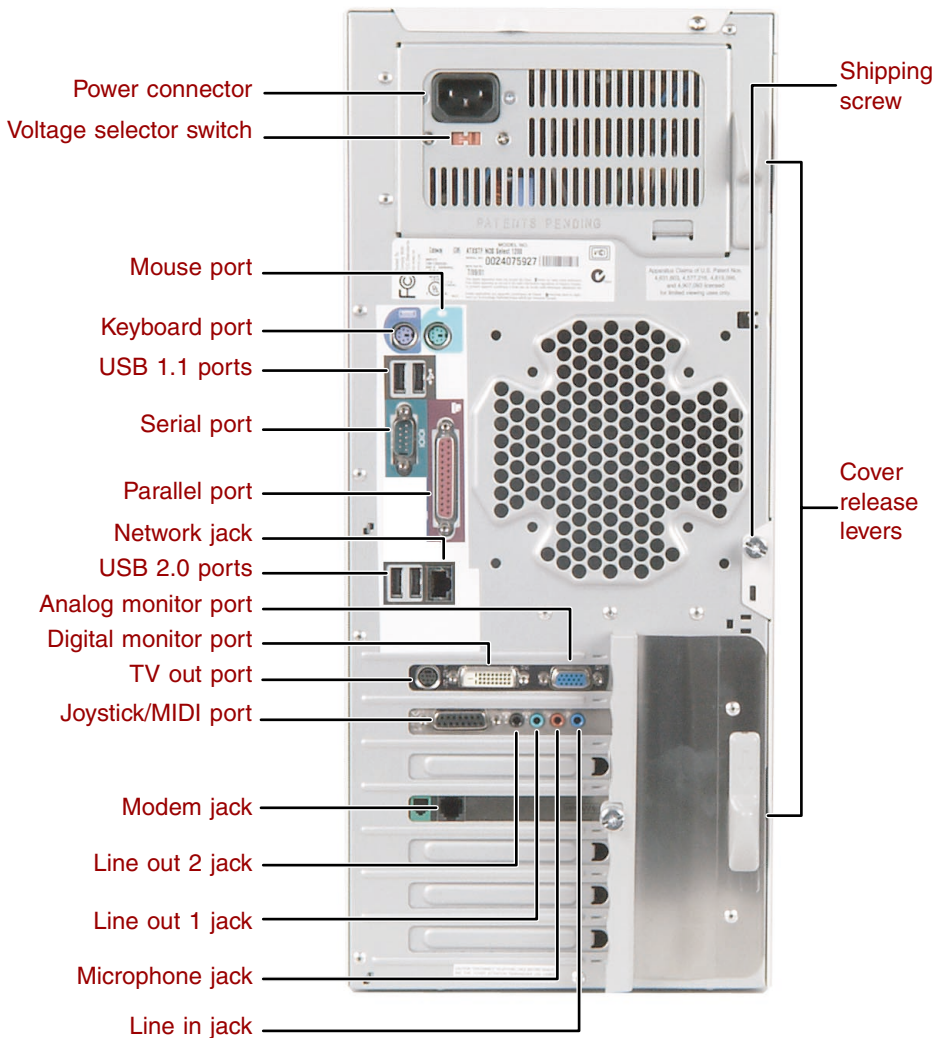

# Gateway Mid-Tower front









Component	Icon	Description
CD/DVD drive	  	<p>Use a CD drive for installing software programs, playing audio CDs, and accessing data.</p> <p>Use a DVD drive for installing software programs, playing audio CDs and DVDs, and accessing data.</p>
CD/DVD eject button		Press this button to open the CD/DVD drive tray.
Diskette drive		Use this drive to store smaller files on diskettes.
Diskette eject button		Press this button to eject an inserted diskette.
Power button		Press this button to turn the power on or off. You can also configure the power button to operate in Standby/Resume mode or Hibernate mode. For more information on changing power button settings, see "Power management" on page 53.
USB 2.0 ports		<p>Plug USB (Universal Serial Bus) devices (such as a USB Iomega™ Zip™ drive, scanner, or camera) into these ports.</p> <p>Legacy support for USB keyboards and mice require that they be plugged into a USB 1.1 port. Plug USB keyboards or mice into the USB 1.1 ports located on the back of the computer.</p>

# Gateway Mid-Tower back



Component	Icon	Description
Power connector		Plug the power cable into this connector.
Voltage selector switch		Before turning on the computer, make sure that the switch is in the proper position for the correct power available. In the United States, the utility power is supplied at a nominal 115 volts at 60 Hz. The power supply is always set to this when the computer is operating in the United States. In other areas of the world, such as Europe, the utility power is supplied at 230 volts at 50 Hz. If the computer is operating in an environment such as this, the voltage selector switch needs to be moved to 230.
Mouse port		Plug a Personal System/2® (PS/2) mouse into this port.
Keyboard port		Plug a PS/2 keyboard into this port.
USB 1.1 ports		Plug USB (Universal Serial Bus) devices (such as a USB keyboard, scanner, or camera) into these ports. Legacy support for USB keyboards and mice require that they be plugged into a USB 1.1 port. Plug USB keyboards or mice into the USB 1.1 ports.
Serial port		Plug a serial device (such as a digital camera) into this port.
Parallel port		Plug a parallel device (such as a printer) into this port.
Network jack		Plug an Ethernet 10/100 network cable into this jack.
USB 2.0 ports		Plug USB (Universal Serial Bus) devices (such as a USB keyboard, scanner, or camera) into these ports. Legacy support for USB keyboards and mice require that they be plugged into a USB 1.1 port. Plug USB keyboards or mice into the USB 1.1 ports located on the back of the computer.
Analog monitor port		Plug an external analog monitor into this port.
Digital monitor port		Plug an external digital monitor into this port.
TV out port		Plug a television into this port.

Component	Icon	Description
Joystick/MIDI port		Plug a joystick or MIDI device into this port.
Modem jack		Plug a modem cable into this jack.
Line out 2 (rear out) jack		Rear Out. Plug powered speakers or an external amplifier into this jack. This jack is color-coded black.
Line out 1 (speakers) jack		Speakers. Plug powered speakers, an external amplifier, or headphones into this jack. This jack is color-coded green.
Microphone jack		Plug a microphone into this jack. This jack is color-coded red.
Line in jack		Plug an external audio input source (such as a stereo) into this jack so that you can record sound on your computer. This jack is color-coded blue.
Shipping screw		Remove the shipping screw prior to using the cover release levers to open the side panel. For more information on opening your case, see “Opening and closing” on page 17.
Cover release levers		Use the cover release levers to open the side panel for access to the inside of the case. For more information on opening your case, see “Opening and closing” on page 17.

# Heceta IV hardware management

Heceta IV is an integrated data acquisition system that lets you monitor the status of your system hardware. Monitored information includes internal temperature, fan speed, voltage, and chassis intrusion (to alert you in the event of case cover removal). The features of the hardware management system can be accessed through LANDesk® Client Manager, which also provides a quick system health indicator.





# System Setup

# 2

## Setting up your computer

Use the instructions on the Setup Poster that came with your computer to assemble your computer.

You should prepare a safe working environment before assembling your computer by following these guidelines:

- Use a clean, flat, and stable surface for your computer. Allow at least 6 inches at the rear of the computer for cabling and air circulation.
- Obtain a grounded (three-prong) AC surge-protected power strip. A surge-protected power strip helps protect against AC power fluctuations.
- Protect your computer from extreme temperature and humidity. Do not expose your computer to direct sunlight, heater ducts, or other heat-generating objects.
- Keep your computer away from equipment that generates magnetic fields, such as unshielded stereo speakers. Even a telephone placed too close to the computer may cause interference.
- Plug the computer into a wall outlet or power strip that is easily accessible.

### Important



Keep the computer boxes and packing material in case you need to send the computer to Gateway for repairs. If you return your computer in different packaging, your warranty may be voided.

# Starting your computer

Before you start your computer for the first time:

- Make sure that the voltage selector switch on the back of the computer is set to the correct voltage for your area. This switch is set at the factory to the correct voltage (see “Gateway Mid-Tower back” on page 4 for the voltage selector switch location).
- Make sure all cables are firmly connected to the proper ports on the back panel of the computer.

## Caution



Make sure your computer and peripherals are turned off and unplugged from the power outlet when you connect peripherals to the computer, or you might damage the computer or the peripherals.

- Make sure the computer and monitor are plugged into an AC outlet or power strip and that the power strip is turned on.



## To start the computer:

- 1 If you have connected the computer components to a power strip, make sure all the computer components are turned off, then turn on the power strip.
- 2 Turn on the monitor.
- 3 Turn on any other components connected to the computer, such as speakers, a printer, or a scanner.
- 4 Turn on the computer.

If nothing happens when you turn on the computer:

- Make sure that the power cables are securely plugged in and that your power strip (if you are using one) is plugged in and turned on.
- Make sure the monitor is connected to the computer, plugged into the power strip or AC outlet, and turned on. You may also need to adjust the brightness and contrast controls on the monitor.



# Understanding the Power-On Self-Test

When you turn on your computer, the Power-On Self-Test (POST) routine checks the computer memory and components. To see this information on the screen, press **TAB** during POST.

## Important



The computer starts very quickly. If your monitor requires time to warm up, you may not see the messages. If you are having problems, you may need to wait for the monitor to warm up and then restart the computer. If you are trying to enter Setup, press **F1** before the monitor warms up.

The computer displays error messages if POST finds any problems. Write down any error messages that you see. If you continue to have problems, these error messages may help Gateway Technical Support diagnose the cause.

# Setting up the operating system

The first time you start your computer, the operating system takes a few minutes to set up.

Refer to your operating system documentation for specific questions regarding the operating system.



## To complete the operating system setup:

- 1 After the computer starts, the start-up wizard opens. Continue by clicking **Next**.
- 2 Type the requested information in the appropriate text boxes. When you have finished typing the information, continue by clicking **Next**.

## Important



Any ID or key numbers requested to complete the operating system setup are either on a sticker attached to the computer or in the documentation provided.

- 3 Continue following the instructions and selecting options in the start-up wizard dialog boxes, clicking **Next** to move through the dialog boxes, until the wizard tells you to restart the computer.

If you need to return to the previous dialog box to change any of your entries, click **Back**.

- 4 Restart your computer. The setup is complete.



## Turning off your computer



### To turn off your computer:

- In Windows XP, click **Start**, then click **Turn Off Computer**, then **Turn Off**. Windows shuts down and turns off your computer.

- OR -

In Windows Me, Windows 2000, Windows 98, or Windows NT, click **Start**, then select **Shut Down**. In the Shut Down Windows dialog box, select **Shut Down**, then click **OK**.

#### Important



If for some reason you cannot use the Turn Off Computer or Shut Down option in Windows to shut down your computer, press and hold the power button for about five seconds.



# Restarting your computer

If your computer does not respond to keyboard or mouse input, you may have to close programs that are not responding. If closing unresponsive programs does not restore your computer to normal operation, you may have to restart the computer.



## To close unresponsive programs and restart your computer:

- 1 Press CTRL+ALT+DEL. A window opens that lets you close a program that is not responding.
- 2 In Windows XP, Windows Me, Windows 2000, or Windows 98, select the program that is not responding.  
- OR -  
In Windows NT, click **Task Manager**, then select the program that is not responding.
- 3 Close the program by clicking **End Task**.
- 4 If the computer does not respond, turn off the computer power, wait ten seconds and turn the power on again.

### Important



If the computer does not turn off immediately, you may need to press and hold the power button for about five seconds.

As a part of the regular startup process, a program to check the disk status runs automatically. When the checks are finished, Windows starts.





# Working with the Gateway Mid-Tower case

# 3

## Preventing static electricity discharge

The components inside your computer are extremely sensitive to static electricity, also known as *electrostatic discharge* (ESD).

### Caution



ESD can permanently damage electrostatic discharge sensitive components in the computer. Prevent ESD damage by following ESD guidelines every time you open the computer case.

### Warning



To avoid exposure to dangerous electrical voltages and moving parts, turn off your computer and unplug the power cord and modem cable before opening the case.

Before opening the computer case, follow these guidelines:

- Turn off the computer power.
- Wear a grounding wrist strap (available at most electronics stores) and attach it to a bare metal part of the computer.

### Warning



To prevent risk of electric shock, do not insert any object into the vent holes of the power supply.

- Touch a bare metal surface on the back of the computer.
- Unplug the power cord and modem cable.

Before working with computer components, follow these guidelines:

- Avoid static-causing surfaces such as carpeted floors, plastic, and packing foam.
- Remove components from their antistatic bags only when you are ready to use them. Do not lay components on the outside of antistatic bags because only the inside of the bags provide electrostatic protection.
- Always hold expansion cards by their edges or their metal mounting brackets. Avoid touching the edge connectors and components on the cards. Never slide expansion cards or components over any surface.



# Opening and closing

The Gateway Mid-Tower case provides toolless access to internal components.

## Warning



To avoid exposure to dangerous electrical voltages and moving parts, turn off your computer, then unplug the power and modem cords before opening the case.



## To open the Gateway Mid-Tower case:

- 1 Turn off the computer.
- 2 Following all static electricity discharge precautions, disconnect the power cord and all other cables.
- 3 Drain any residual power from the computer by pressing the power button.
- 4 For stability, place the computer on its side.
- 5 Remove the shipping screw, then push the cover release levers away from each other.



6 Swing the side panel away from the case.

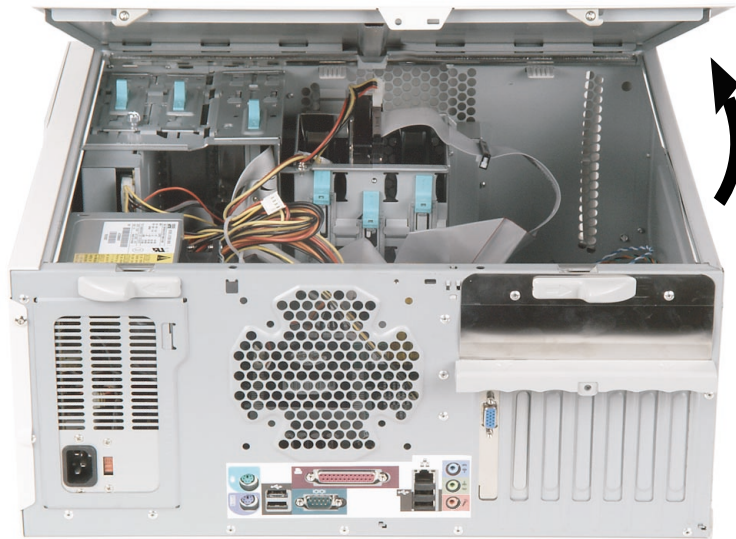



## To close the Gateway Mid-Tower case:

- 1 For more stability, place the computer on its side.
- 2 Make sure all of the internal cables are arranged inside the case so they will not be pinched when you close the case.

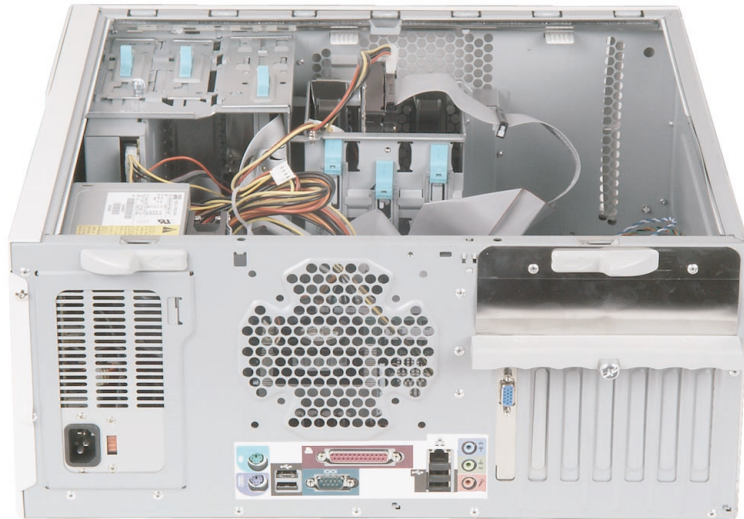

- 3 Align the door tabs into the case notches.
- 4 Swing the side panel toward the case until the release levers lock.

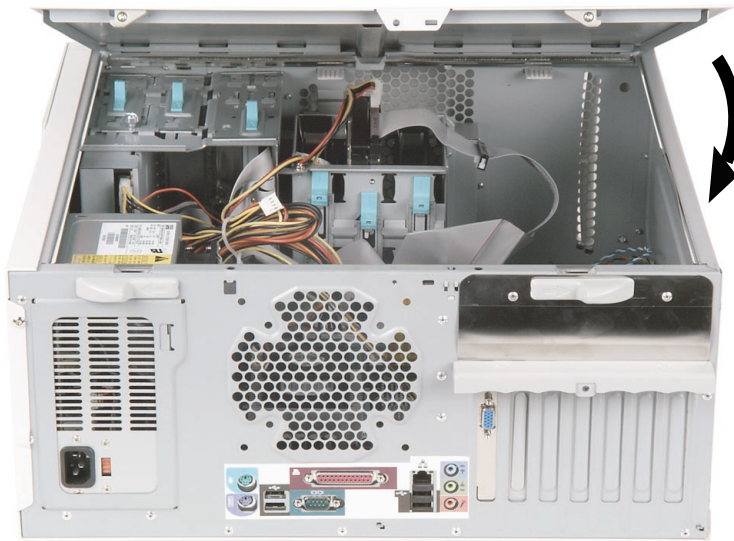

- 5 Return the computer to its upright position.
- 6 Reconnect the cables and power cord.



# Adding or replacing drives

## Preparing to add or replace a drive

One 3.5-inch diskette drive, one 3.5-inch hard drive, and one CD drive are included with your computer. You can add one additional half-height 3.5-inch tape storage or disk storage device.

As you prepare to install drives, keep the following in mind:

- To remove and install drives, use an antistatic wrist strap.
- If you remove a drive, place it in an antistatic bag or container.
- Before you install a drive, see the drive documentation for information on configuring the drive, setting any jumpers on the drive, and attaching cables to the drive.
- If you are installing a drive that requires a controller card, install the card before you install the drive.
- IDE cables automatically assign master/slave positions to the drives they connect. You can override these assignments using the jumpers on the drives.
- IDE hard drives can be configured as single, master, or slave. IDE CD drives can be configured as master or slave. Configure the drives by using the drive-select jumpers located on the drives.
- You may need to configure the drives you install using the BIOS Setup utility. Press F1 at start up to open the BIOS Setup utility.

# Drive cabling information

Your computer includes three different types of drive cables. Each drive cable is clearly labeled, indicating cable-type and showing which end is connected to the appropriate connector on the system board and which end is connected to the drive.

Use the diskette drive connector cable to connect the diskette drive. Use the standard IDE connector cable to connect IDE devices such as CD drives and standard IDE hard drives. Use the 80-conductor IDE cable to connect DMA-100-compatible hard drives.

## Important



The CD drive may be connected to the primary IDE controller and the hard drive may be connected to the secondary IDE controller. Drive assignments will reflect the correct configuration from the factory.

# Adding or replacing drives

Use these procedures to replace 5.25-inch drives such as CD/DVD drives, 3.5-inch drives such as diskette drives, and hard drives.



## To add or replace a CD/DVD or diskette drive:

- 1 Open the case by following the procedure “To open the Gateway Mid-Tower case:” on page 17.
- 2 Return the case to its upright position.

- 3** If you are adding a new drive, press in on the two bezel release tabs, then swing open the front bezel.

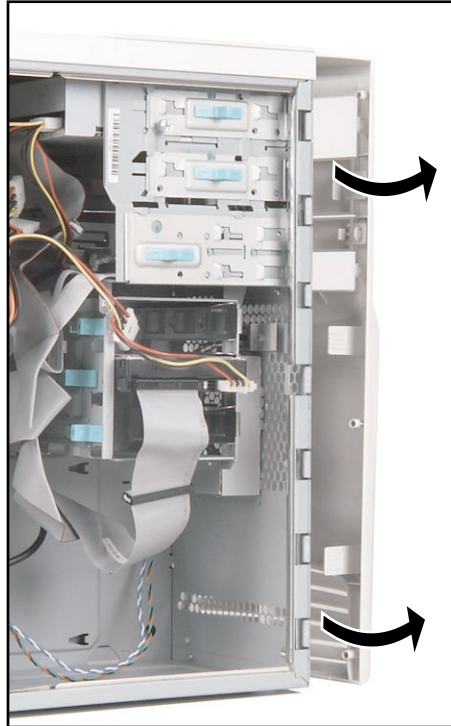
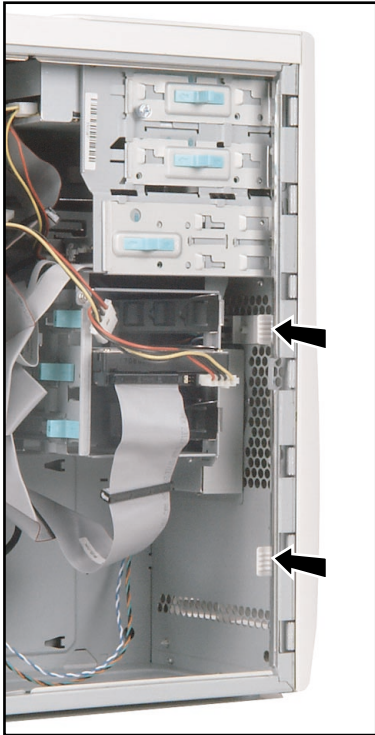

- 4** If you are adding a new drive, remove the drive bay bezel cover for the bay into which you are installing the new drive.

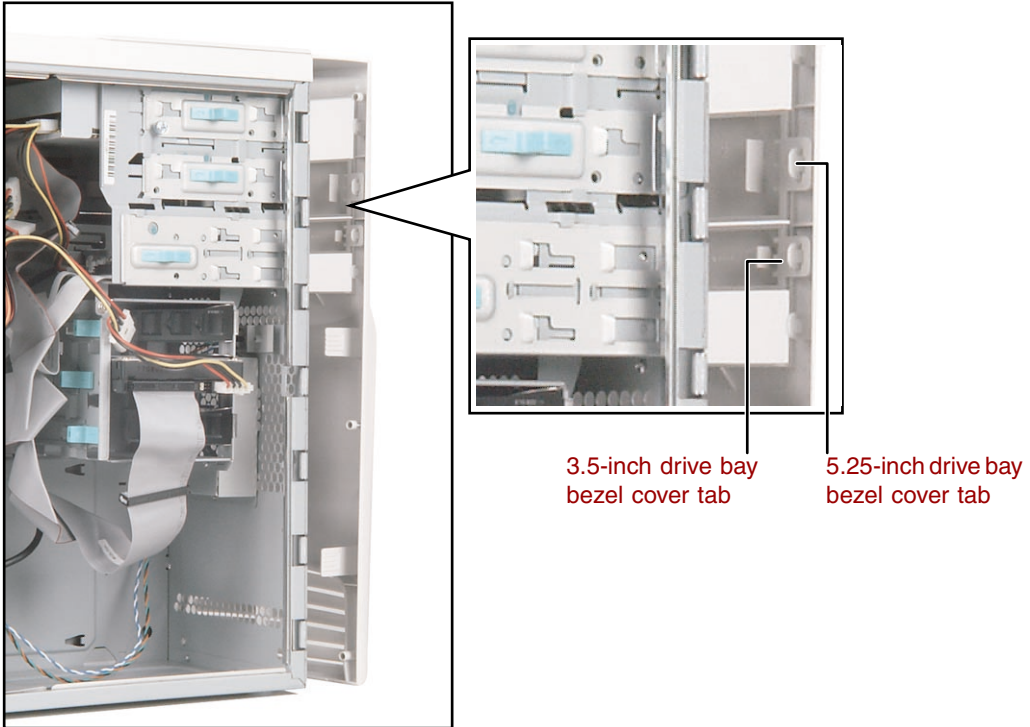



- 5 If you are adding a new drive, remove the EMI shield for the bay into which you are installing the new drive.



- 6 If you are replacing a drive, disconnect the drive cables, noting their locations and orientation. (You will reconnect the cables after you install the new drive.)

- 7** If there is a shipping screw installed next to the release lever, remove the screw, then unlock the drive bay by sliding the release lever back toward the back of the case.

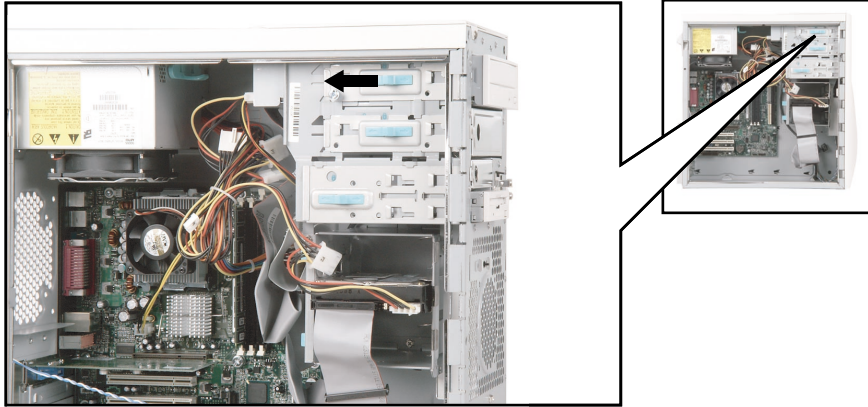

- 8** If you are replacing a drive, remove the old drive by sliding it forward and out of the drive bay.

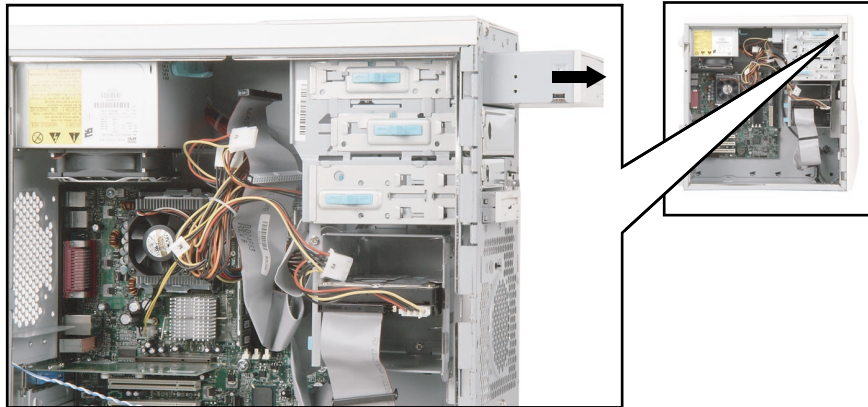

- 9** Set any jumpers on the new drive. See the drive manual for further instructions.
- 10** Slide the new drive into the drive bay until it settles into the indentation, then lock it into place by sliding the release lever toward the front of the case.
- 11** Connect the drive cables according to the instructions in the drive manual.
- 12** Close the case by following the procedure “To close the Gateway Mid-Tower case:” on page 19.





### To replace a hard drive:

- 1 Open the case by following the procedure “To open the Gateway Mid-Tower case:” on page 17.
- 2 Return the case to its upright position.
- 3 Disconnect the drive cables, noting their locations and orientation. (You will reconnect the cables after you install the new drive.) See the drive manual for further instructions.

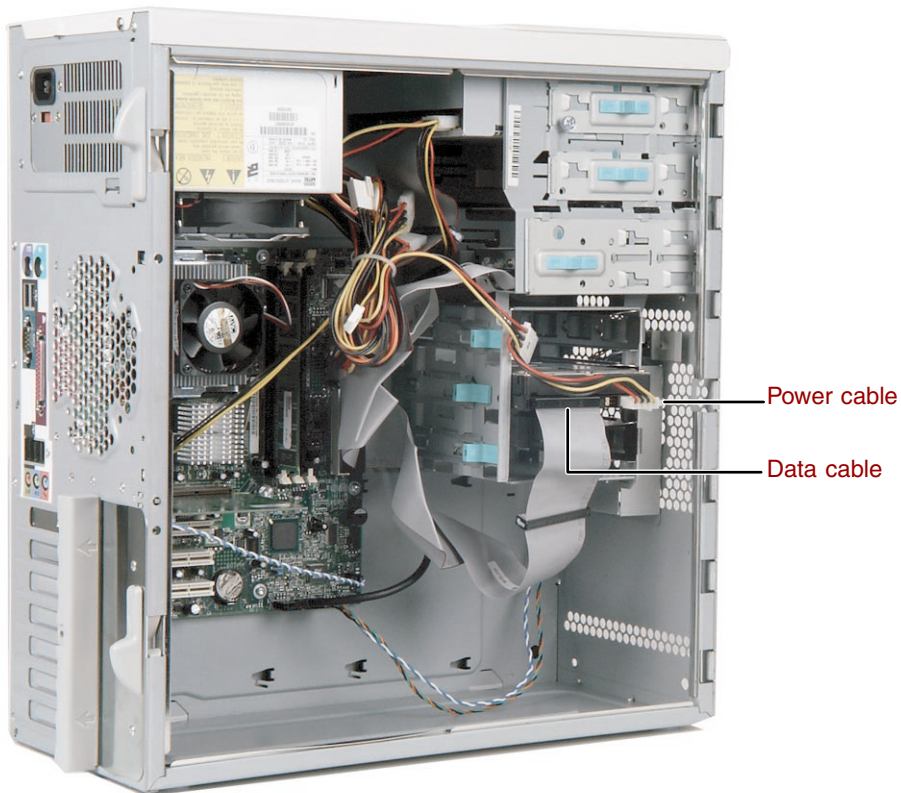

- 4 Slide the green release lever out toward the open side of the case, then remove the drive by sliding it out of the drive bay.



- 5 Set any jumpers on the new drive. See the drive manual for further instructions.
- 6 Slide the new drive in and lock it into place by sliding the release lever toward the inside of the case.
- 7 Connect the drive cables according to the instructions in the drive manual.
- 8 Close the case by following the procedure "To close the Gateway Mid-Tower case:" on page 19.



# Replacing expansion cards

An expansion card is a card used in the computer to add functionality to the system. Use the following procedures to replace, add, or reseal an expansion card.



## To replace, add, or reseal an expansion card:

- 1 Open the case by following the procedure “To open the Gateway Mid-Tower case:” on page 17.
- 2 For more stability, place the computer on its side.
- 3 Disconnect any cables that are attached to the card, noting their locations and orientation. (You will reconnect the cables after you install the new card.)
- 4 Remove the card retention cover thumb-screw that secures the card retention cover to the case.



Card retention cover thumb-screw

- 5 While holding the expansion card retention cover open, remove the expansion card.

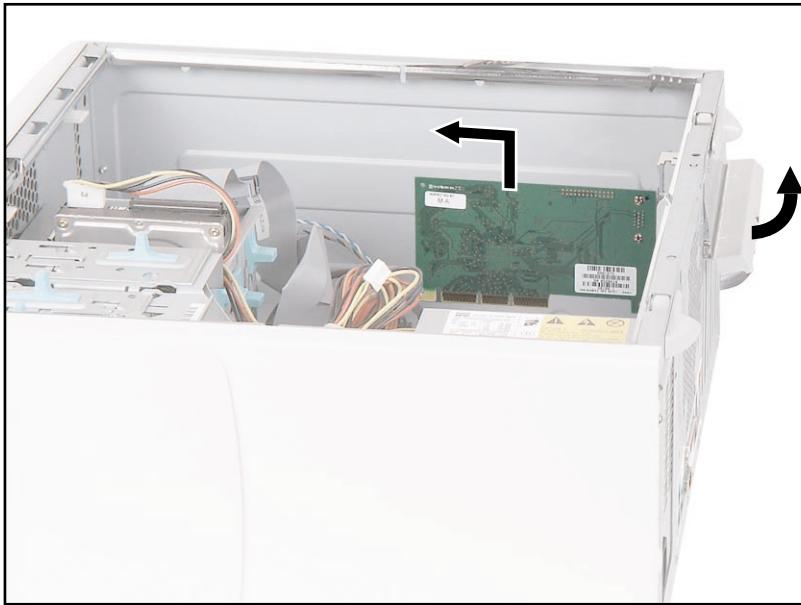

You can slightly seesaw the card end-to-end to loosen the card, but do not bend the card sideways.

**Caution**



Do not touch the contacts on the bottom part of the expansion card. Touching the contacts can cause electrostatic damage to the card.

- 6 While holding the retention cover open, install the new card into the expansion slot.

You can slightly seesaw the card end-to-end to help insert the card, but do not bend the card sideways.

- 7** Lock the card in place by pushing the expansion card retention cover inward, then secure the expansion card retention cover with the card retention cover thumb-screw.
- 8** Reconnect any cables to the card.
- 9** Close the case by following the procedure “To close the Gateway Mid-Tower case:” on page 19.
- 10** Refer to the guide that came with the card for any special software installation instructions.





# Replacing the power supply



## To replace a Gateway Mid-Tower case power supply:

- 1 Open the case by following the procedure “To open the Gateway Mid-Tower case:” on page 17.
- 2 Return the computer to its upright position.
- 3 Disconnect the power supply cables from all components, noting their locations and orientation. (You will reconnect the cables after you install the new power supply.)
- 4 Flip the power supply retention clip out.

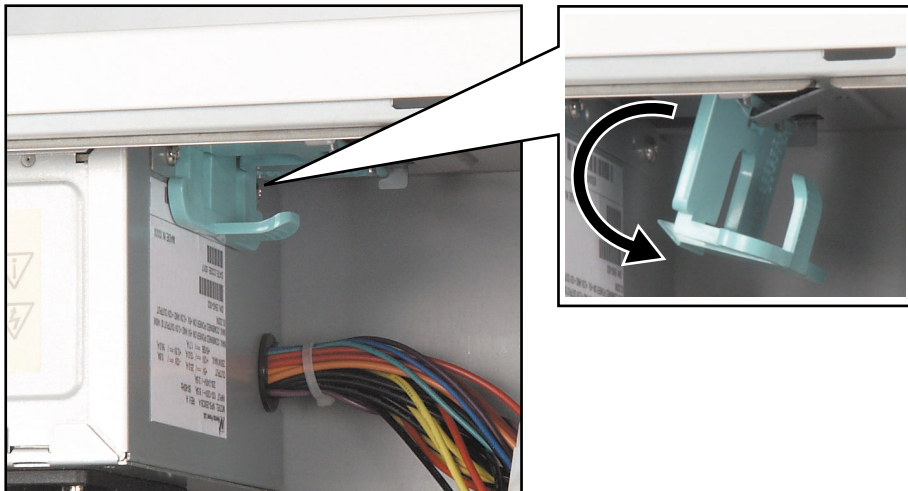

- 5 While supporting the power supply with your hand, remove the power supply by sliding it toward the front of the case, then outward.

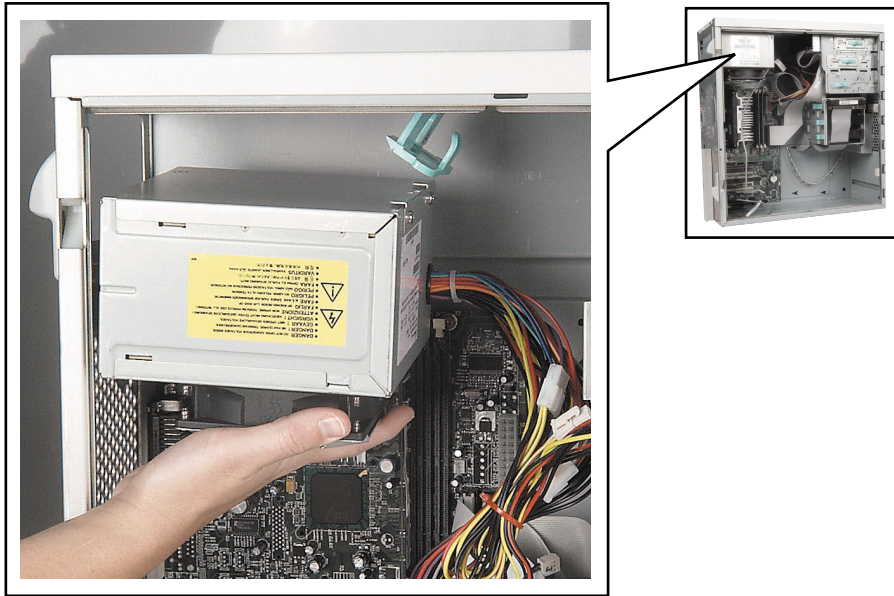

- 6 Install the new power supply into the case by reversing the actions you took in Step 4, then lock the new power supply into place by flipping the power supply retention clip in.
- 7 Reconnect the power supply cables.
- 8 Close the case by following the procedure “To close the Gateway Mid-Tower case:” on page 19.



# Replacing the system board



## To replace the system board:

- 1 Open the case by following the procedure “To open the Gateway Mid-Tower case:” on page 17.
- 2 Remove all of the expansion cards by following the procedure “To replace, add, or reseal an expansion card:” on page 30.
- 3 Disconnect the power and data cables from the system board, noting their locations and orientation. (You will reconnect the cables after you install the new board.)
- 4 Remove the thumb screw using a screwdriver, coin, or your fingers.



Thumb screw

- 5 Remove the system board by sliding the board toward the front of the case. The system board standoffs slide out of the keyhole slots.

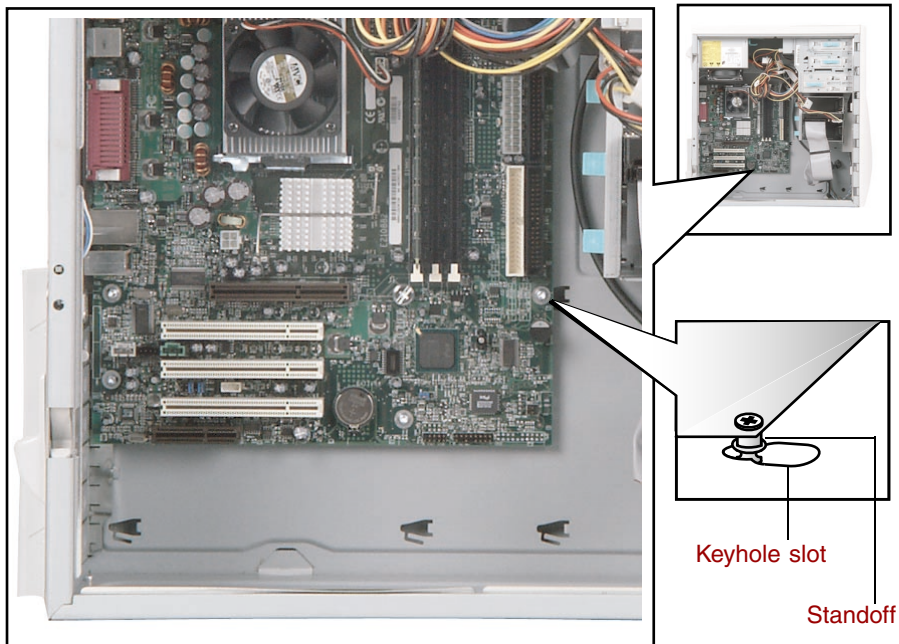

- 6 Slide the new system board into the keyhole slots and lock it into place with the thumbscrew.

**Important**



The new system board must have special standoffs (*pem studs*) mounted on the bottom of the board. If necessary, use the standoffs from the original system board.

- 7 Connect the power and data cables.
- 8 Install the expansion cards by following the procedure in “To replace, add, or reseat an expansion card:” on page 30.
- 9 Close the case by following the procedure “To close the Gateway Mid-Tower case:” on page 19.



# Installing memory

When you upgrade your computer memory, make sure that you install the correct type of memory module for your computer. For more information about your computer's memory type, see "Specifications" on page 104.

## Installing or replacing RIMM memory

You need to use a combination of Rambus Interface Memory Modules (RIMMs) and Continuity-RIMMs (C-RIMMs). All memory slots must be filled with either a RIMM or a C-RIMM.

### RIMMs

RIMM memory has a metal cover on one or both sides of the module.

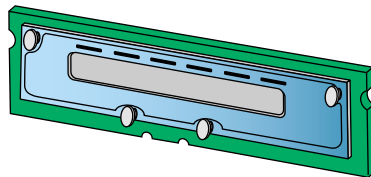

### C-RIMMs

C-RIMMs are placeholders that let the memory modules work. A C-RIMM does not have a metal cover on either side of the module.

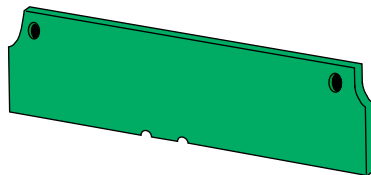

## Tips & Tricks Identifying identical RIMM modules



Identical RIMM modules must share the same five specifications shown in the example below.

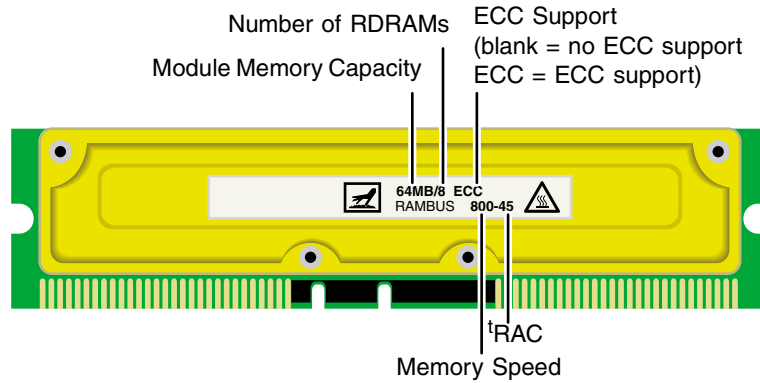

### To install or replace RIMM or C-RIMM memory:

- 1 Open the case by following the procedure "Opening and closing" on page 17. Make sure that you remove all external cables and the power cord.
- 2 Find the memory module banks, sometimes called expansion slots, on your system board.

- 3** If you are removing a RIMM module from the memory module bank, gently pull the plastic tabs away from the sides of the memory module and remove it.

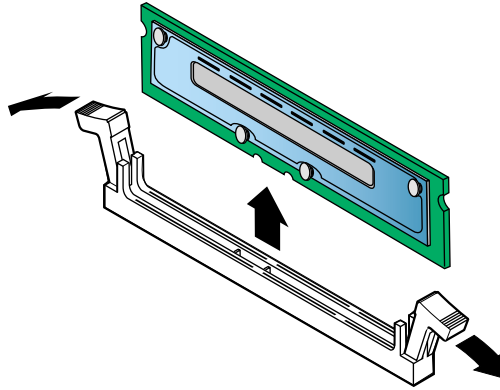

- OR -

If you are removing a C-RIMM module from the memory module bank, gently pull the plastic tabs away from the sides of the module and remove it.

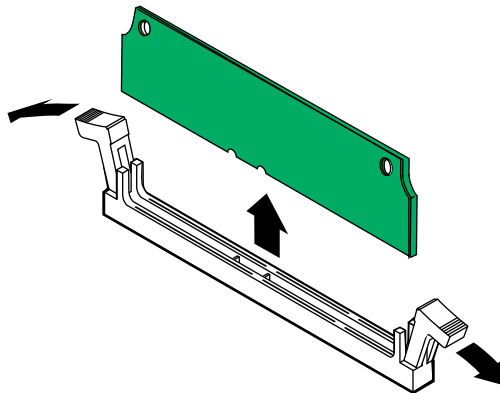

- 4 If you are installing two memory modules into one **dual-channel** (two slots per bank) bank (RIMM BANK 0), install two *identical* RIMMs in RIMM BANK 0 and two C-RIMMs in RIMM BANK 1 on the system board.

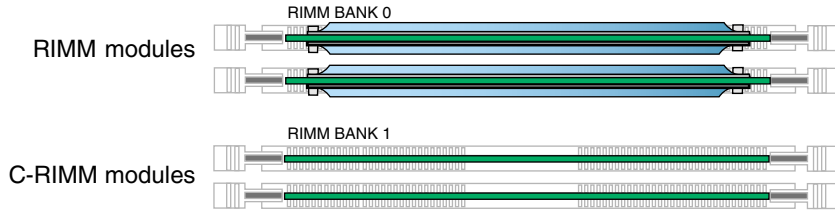

- OR -

If you are installing four memory modules into two **dual-channel** banks (RIMM BANK 0 and RIMM BANK 1), install two *identical* RIMMs in RIMM BANK 0 and two *identical* RIMMs in RIMM BANK 1 on the system board.



Make sure that you align the notches on the RIMM and C-RIMM with the notches on the memory module bank and press firmly into the bank.

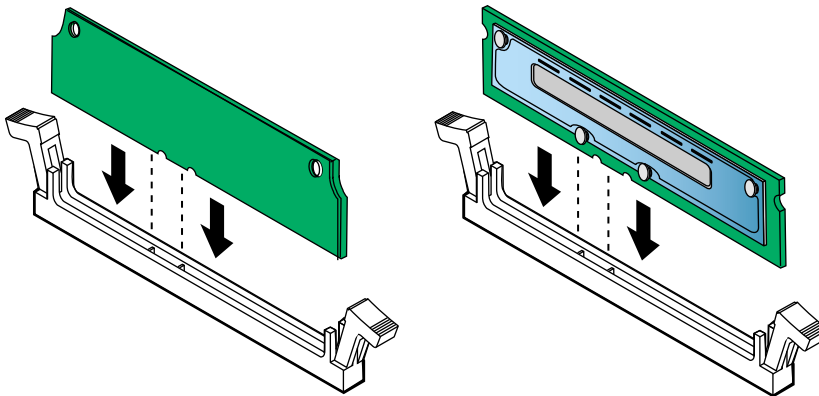



- 5 Make sure that the tabs on the sides of the RIMM and C-RIMM secure the memory module in the slot. When the module is secure, you will hear a click as both tabs lock.
- 6 Close the case by following the procedure “To close the Gateway Mid-Tower case:” on page 19.
- 7 Turn on the computer. Windows starts and the Windows desktop appears.
- 8 In Windows XP, click **Start**, then select **Control Panel, Performance and Maintenance**, then **System**. The amount of memory in your computer is shown at the bottom of the System Properties window in the **General** tab.

- OR -

In Windows Me, Windows 2000, or Windows 98, right-click the **My Computer** icon, then select **Properties**. The amount of memory in your computer is shown at the bottom of the System Properties window in the **General** tab.



# Replacing the battery

The battery provides power for the computer real-time clock and CMOS memory, which stores the computer configuration information.

If your battery is failing you may notice your computer clock slowing down and giving you the incorrect time. If so, open the BIOS Setup utility and make note of any custom values in the various menus before replacing the battery. Replacing the battery resets the BIOS Setup utility to its default values.

## Warning



There is a danger of explosion if the battery is incorrectly replaced. Replace the battery only with the same or equivalent type recommended by the manufacturer. Dispose of used batteries according to the manufacturer's instructions.

## Attention



Il y a danger d'explosion s'il y a remplacement incorrect de la batterie.  
Remplacer uniquement avec une batterie du même type ou d'un type équivalent recommandé par le constructeur.  
Mettre au rebut les batteries usagées conformément aux instructions du fabricant.

When disposing of used batteries, check local and national laws regarding disposal of toxic or dangerous waste.



## To replace the battery:

- 1 Restart the computer and start the BIOS Setup utility by pressing F1 when you are prompted to do so.
- 2 Verify that all your settings are currently correct, then from the **Exit** menu, select **Save Custom BIOS Settings**. For more information about the BIOS Setup utility program, see “Using the BIOS Setup Utility” on page 45.
- 3 Turn off the computer and disconnect the power cord, modem cable (if installed), and all external peripheral devices.
- 4 Remove the cover. (See “Opening and closing” on page 17 and “Preventing static electricity discharge” on page 15.)

- 5 Locate the battery on the system board (see “System board layout” on page 98). The battery is circular and has the positive pole mark (+) on the top.
- 6 Place the edge of a small flat-head screwdriver under the battery and lift it up until it pops out of the socket.

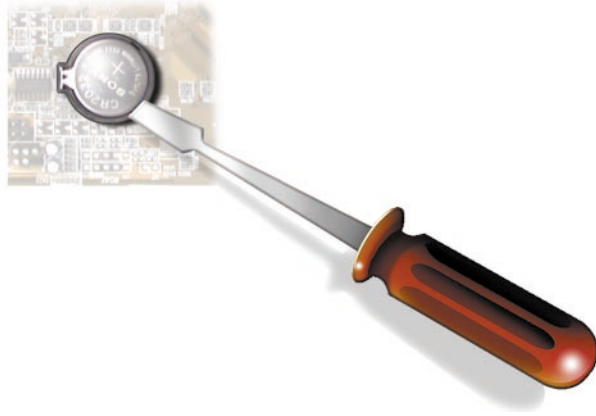

- 7 Press the new battery in the socket with the positive pole up. Make sure you have pressed the battery down far enough for it to contact the base of the socket (it should snap into place).
- 8 Close the case by following the procedure “To close the Gateway Mid-Tower case:” on page 19.
- 9 Open the BIOS Setup utility, then select **Load Custom BIOS Settings** from the **Exit** menu.





# Using the BIOS Setup Utility

# 4

## About the BIOS Setup utility

The computer's BIOS has a built-in setup utility that lets you configure several basic computer characteristics. The settings are stored in battery-backed RAM and are retained even when the power is off.

### Important



The computer starts very quickly. If your monitor requires time to warm up, you may not see the messages. If you are having problems, you may need to wait for the monitor to warm up and then restart the computer. If you are trying to enter Setup, press F1 before the monitor warms up.

Start the BIOS Setup utility by restarting the computer, then pressing F1 when the Gateway logo screen appears during startup. The Main BIOS Setup utility screen opens. It may not look exactly like the screen shown below.

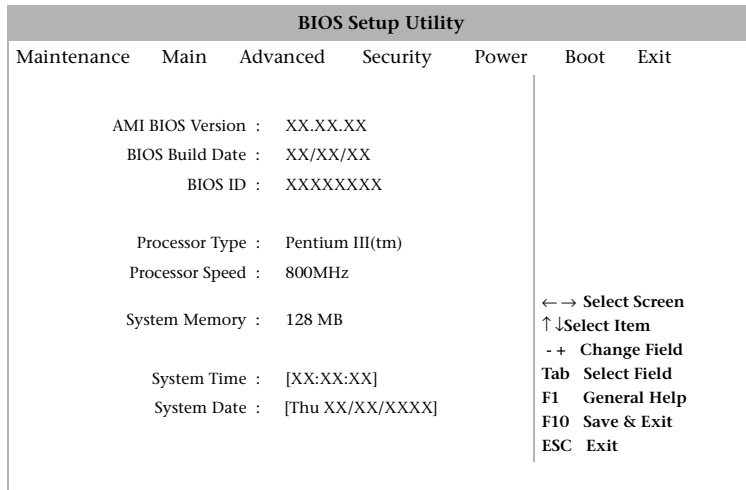

As you select items on the Main menu or in submenus, you see specific information related to the current selection in the Item Specific Help box.

The command bar shows the keystrokes necessary to access help, navigate through the menus, and perform other functions.

- F1 opens the Help screen, providing general help for using the BIOS Setup utility.
- The ↑ (up arrow) and ↓ (down arrow) keys select items in the menu.
- The ← (left arrow) and → (right arrow) keys move you between the menus.
- ENTER either moves you to a submenu screen when a selected item is preceded by > or activates a selected field.
- ESC closes the screen you are in and returns you to the previous screen or opens a dialog box allowing you to exit from the BIOS Setup utility.
- F10 opens a screen that lets you save all settings, then exit the BIOS Setup utility.

The main screen has the following menu selections at the top of the screen:

- **Maintenance** lets you clear Setup passwords and enable extended configuration mode. The maintenance menu is only displayed when the BIOS configuration jumper is set to configure (see “Setting the BIOS configuration jumper” on page 49 for more information).
- **Main** gives you access to basic information and settings related to your computer hardware and configuration.
- **Advanced** gives you access to information and settings for computer resources, hardware, and computer configuration.
- **Security** gives you access to settings related to computer access passwords and security settings.
- **Power** gives you access to information and settings for power management features.
- **Boot** gives you access to information and settings for boot features and boot sequences.
- **Exit** gives you access to options for exiting the BIOS Setup utility.

Refer to the Help box on the right side of the BIOS Setup screens for information about menu items.

# Updating the BIOS

If you need a new version of the BIOS, you can download the BIOS update from technical support area on the Gateway Web site ([www.gatewayatwork.com](http://www.gatewayatwork.com)) and install the new version from a diskette.

To update the BIOS you need to perform the following tasks in sequence:

- 1** Create a bootable diskette
- 2** Save the current BIOS settings
- 3** Create the BIOS update diskette
- 4** Update the BIOS
- 5** Load the BIOS settings

Follow the detailed instructions for updating the BIOS that are included in the self-extracting file that you can download from the technical support area of Gateway's Web site.



# Setting the BIOS configuration jumper

The system board has a configuration jumper related to the BIOS. Place a jumper on specific pins to reset the CMOS settings to the BIOS defaults or to erase a misplaced or forgotten password. For more information on the location and use of the configuration jumper, see “BIOS configuration jumper settings” on page 103.

## Caution



Moving a jumper while the power is on can damage your computer. Always turn off the computer and unplug the power cord from the computer before changing jumper settings.



# Managing Your Computer

# 5

## Protecting against power source problems

Surge suppressors, line conditioners, and uninterruptible power supplies can help protect your computer against power source problems.

### Surge suppressors

During a power surge, the voltage level of electricity coming into your computer can increase to far above normal levels and cause data loss or system damage. Protect your computer and peripheral devices by connecting them to a *surge protector*, which absorbs voltage surges and helps prevent them from reaching your computer.

#### Warning



High voltages can enter your computer through both the power cord and the modem connection. Help protect your computer by using a surge protector. If you have a telephone modem, use a surge protector that has a modem jack. If you have a cable modem, use a surge protector that has an antenna/cable TV jack. During an electrical storm, unplug both the surge protector and the modem.

When purchasing a surge suppressor:

- Make sure the surge suppressor meets the appropriate product safety certification for your location, such as Underwriters Laboratories (UL).
- Check the maximum amount of voltage the suppressor allows to pass through the line. The lower the voltage that the suppressor allows to pass through, the better the protection for your computer.
- Check the energy absorption (*dissipation*) rating. The higher the energy absorption rating, the better the protection for your computer.
- Check for line-conditioner capabilities. A line conditioner smooths out some of the normal line noise (small voltage fluctuations) of an electrical supply.

## Line conditioners

A line conditioner protects your computer from the small fluctuations in voltage from an electrical supply. Most computers can handle this variation, called *line noise*, without problems. However, some electrical sources include more line noise than normal. Line noise can also be a problem if your computer is located near, or shares a circuit with, a device that causes electromagnetic interference, such as a television or a motor.

Some surge suppressors and uninterruptible power supplies include simple line-conditioning capabilities.

## Uninterruptible power supplies

Use a standby uninterruptible power supply (UPS) to protect your computer from data loss during a total power failure. A UPS uses a battery to keep your computer running temporarily during a power failure and lets you save your work and shut down your computer. You cannot run your computer for an extended period of time while using only the UPS.

# Power management

Computer equipment can account for a significant portion of energy use in the home and office environment. You may not want to shut down your computer each time you leave it, especially if you plan to be away for only a short time. Windows lets you use the following modes to conserve energy when the system is not in use:

- *Standby* - while your computer is in Standby mode, it switches to a low power state where devices, such as the monitor and drives, turn off and the entire system uses less power.
- *Hibernate* - (also called *save to disk*) writes all current memory (RAM) information to the hard drive, then turns the computer completely off. The next time you turn on the computer, it reads the memory information from the hard drive and opens the programs and documents that were open when you activated Hibernate mode.

# Using Standby mode

Always save your work before using the Standby mode. Once in Standby mode, your computer reduces or turns off the power to most devices except memory. However, the information in the memory is not saved to the hard drive. If power is interrupted, the information is lost.

The table below shows how to use Standby mode.

If your computer is...	...and you want to...	...then
Off	Start up	Press the power button.
On	Enter Standby mode	In Windows XP, click <b>Start</b> , then click <b>Turn Off Computer</b> , then click <b>Stand By</b> . - OR - In Windows Me, Windows 2000, or Windows 98, click <b>Start</b> , then select <b>Shut Down, Stand By</b> , then click <b>OK</b> .
On	Enter Hibernate mode (must be enabled)	In Windows XP, click <b>Start</b> , then click <b>Turn Off Computer</b> , press and hold <b>SHIFT</b> , then click <b>Hibernate</b> . - OR - In Windows 2000, click <b>Start</b> , then select <b>Shut Down, Hibernate</b> , then click <b>OK</b> .
In Standby or Hibernate mode	Exit Standby or Hibernate mode	Move the mouse or press any key on the keyboard.
On	Shut down	Click <b>Start</b> , then click <b>Turn off computer</b> or <b>Shut Down</b> , then click <b>Turn off</b> or <b>Shut Down</b> .

## Important



If for some reason you cannot use the Turn Off Computer or Shutdown options in Windows to shut down your computer, press the power button for about five seconds.

# Changing power settings

You can change power management settings, such as the power button function and power-saving timers, by changing power settings in Windows. You can also adjust power schemes and adjust advanced power settings.

*Power schemes* (groups of power settings) let you change power saving options such as when the monitor or hard drive is automatically turned off. You can also select one of the defined power schemes or create a custom power scheme.

*Advanced power settings* let you assign different power saving modes to the power button.

**Help and Support**



For more information on changing power settings, click **Start**, then select **Help and Support** or **Help**.

## Changing the power scheme



### To change the power scheme:

- 1 In Windows XP, click **Start**, then select **Control Panel**. Click **Performance and Maintenance**. The Performance and Maintenance window opens.

- OR -

In Windows Me, Windows 2000, or Windows 98, click **Start**, then select **Settings**, then **Control Panel**. The Control Panel window opens. If you do not see the **Power Options** or **Power Management** icon, click **view all Control Panel options**.

- 2 Click/Double-click the **Power Options** or **Power Management** icon. The Power Options Properties dialog box opens.

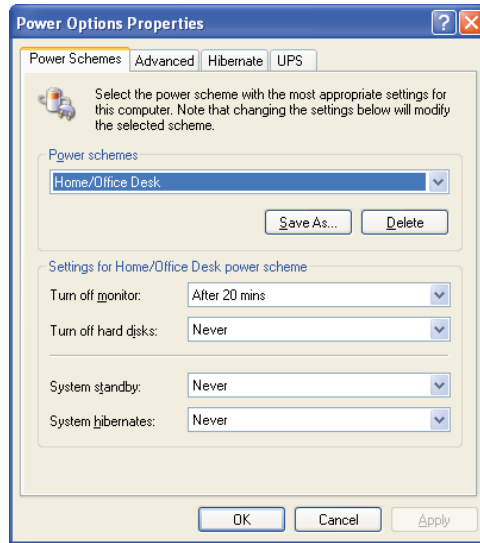

- 3 Select a power scheme from the **Power Scheme** list.

- OR -

Set the timers for **System standby**, **Turn off monitor**, and **Turn off hard disks**, then save your custom power scheme by clicking **Save As** and typing a name for the scheme.

- 4 Save the changes by clicking **OK**.





# Changing advanced power settings



## To change advanced power management settings:

**1** In Windows XP, click **Start**, then select **Control Panel**. Click **Performance and Maintenance**. The Performance and Maintenance window opens.

- OR -

In Windows Me, Windows 2000, or Windows 98, click **Start**, then select **Settings**, then **Control Panel**. The Control Panel window opens. If you do not see the **Power Options** or **Power Management** icon, click **view all Control Panel options**.

**2** Click/Double-click the **Power Options** or **Power Management** icon. The Power Options Properties dialog box opens.

**3** Click the **Advanced** tab.

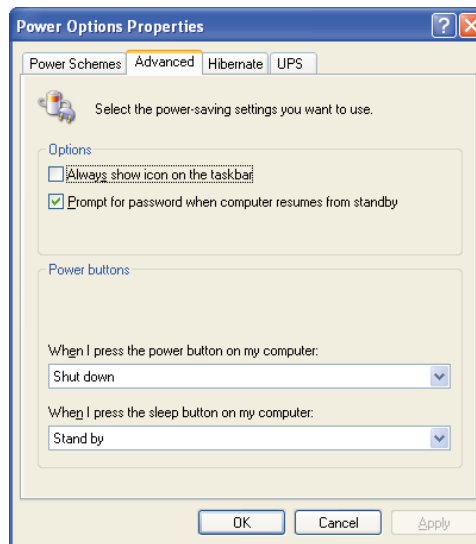

**4** Change the settings, then save them by clicking **OK**.



# Activating Hibernate mode



## To activate Hibernate mode:

- 1 In Windows XP, click **Start**, then select **Control Panel**. Click **Performance and Maintenance**. The Performance and Maintenance window opens.  
- OR -  
In Windows Me, Windows 2000, or Windows 98, click **Start**, then select **Settings**, then **Control Panel**. The Control Panel window opens. If you do not see the **Power Options** or **Power Management** icon, click **view all Control Panel options**.
- 2 Click/Double-click the **Power Options** or **Power Management** icon. The Power Options Properties dialog box opens.
- 3 Click the **Hibernate** tab.

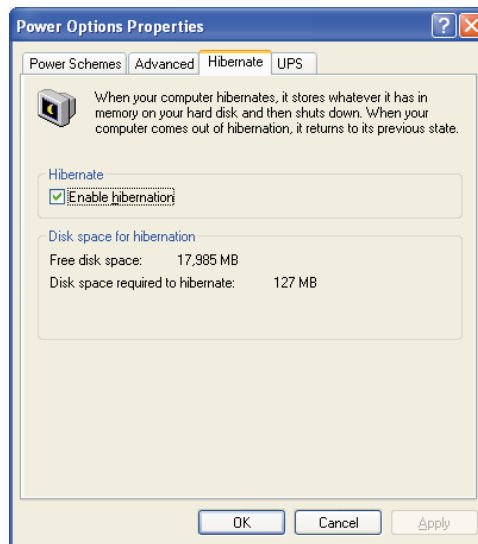

- 4 Select the **Enable hibernation** check box, then click **Apply**. Hibernate mode is now an option you can select in the Power Schemes and Advanced tabs.
- 5 Click **OK**.





## To place your computer into hibernation:

- To use hibernation as a power savings mode, open the Power Options dialog box, click the **Power Schemes** or **Advanced** tab, select **Hibernate** as one of the power settings, then save the changes by clicking **OK**.
- To manually place your computer into hibernation:
  - In Windows XP, click **Start**, then click **Turn off computer**, then hold the Shift key down while clicking **Standby**.
  - OR -
  - In Windows Me, Windows 2000, or Windows 98, click **Start**, then **Shut Down**, **Hibernate**, then **OK**.



# Installing an Uninterruptible Power Supply in Windows XP



## To install an Uninterruptible Power Supply in Windows XP:

- 1 Click **Start**, then select **Control Panel**. Click **Performance and Maintenance**. The Performance and Maintenance window opens.
- 2 Click the **Power Options** icon. The Power Options Properties dialog box opens.

3 Click the **UPS** tab.

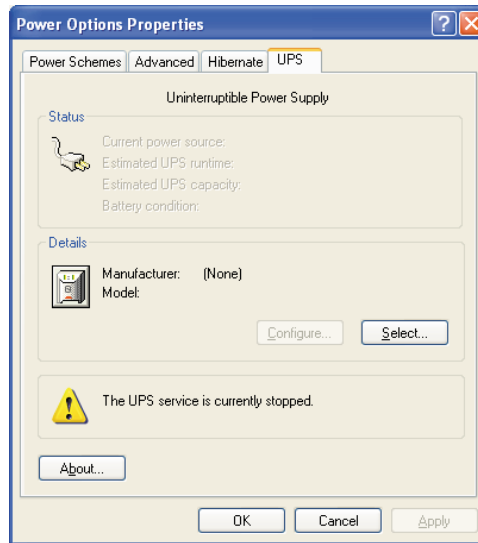

4 Click **Select**. The UPS Selection dialog box opens.

5 Select the manufacturer and model of the UPS device.

6 Click the serial port where the UPS device is attached.

7 Click **Finish**.

8 Click **OK**.



# Protecting your computer from viruses

A *virus* is a program that attaches itself to a file on a computer, then spreads from one computer to another. Viruses can damage data or cause your computer to malfunction. Some viruses go undetected for a period of time, because they are activated on a certain date.

Protect your computer from a virus by:

- Using your Norton® AntiVirus program to check files and programs that are on diskettes, attached to e-mail messages, or downloaded from the Internet.
- Checking all programs for viruses before installing them.
- Disabling macros on suspicious Microsoft Word and Excel files. These programs will warn you if a document that you are opening contains a macro that might have a virus.
- Periodically updating your Norton AntiVirus program to protect against the latest viruses.

**Help and Support**



For more information on protecting your computer from viruses, click **Start**, then select **Help and Support** or **Help**.



## To scan for viruses:

- 1 Click **Start**, then select **All Programs**, **Norton AntiVirus**, then **Norton AntiVirus 2002**. Norton AntiVirus opens.
- 2 Click **Scan for Viruses**.
- 3 Select the type of scan you want to make in the Scan area, then under Actions, click **Scan**.





### To remove a virus:

- 1 Find and remove the virus immediately using Norton AntiVirus.
- 2 Turn off your computer and leave it off for at least 30 seconds.
- 3 Turn on the computer and rescan for the virus.



### To update Norton AntiVirus:

- 1 Click **Start**, then select **All Programs, Norton AntiVirus**, then **LiveUpdate - Norton AntiVirus**. The LiveUpdate wizard opens.
- 2 Follow the on-screen instructions to update your Norton AntiVirus program with the latest virus protection files.
- 3 When the program has finished, click **Finish**.



# Managing hard drive space

Windows provides several utilities you can use to manage your hard drive.

## Checking hard drive space

Help and Support



For more information on checking hard drive space, click **Start**, then select **Help and Support** or **Help**.



### To check hard drive space:

1 In Windows XP, click **Start**, then select **My Computer**.

- OR -

In Windows Me, Windows 2000, or Windows 98, double-click the **My Computer** icon.

2 Right-click the drive that you want to check for available file space, then select **Properties**. Drive space information appears.

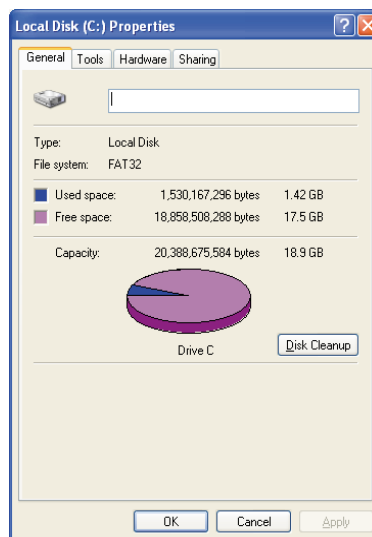

# Using Disk Cleanup

Delete unneeded files, such as temporary Windows files, to free hard drive space.

## Help and Support



For more information on using Disk Cleanup, click **Start**, then select **Help and Support** or **Help**.



## To use the Windows Disk Cleanup program:

- 1 In Windows XP, click **Start**, then select **My Computer**. The My Computer window opens.  
- OR -  
In Windows Me, Windows 2000, or Windows 98, double-click the **My Computer** icon. The My Computer window opens.
- 2 Right-click the hard drive that you want to delete files from, then select **Properties**. The System Properties dialog box opens at the **General** tab.

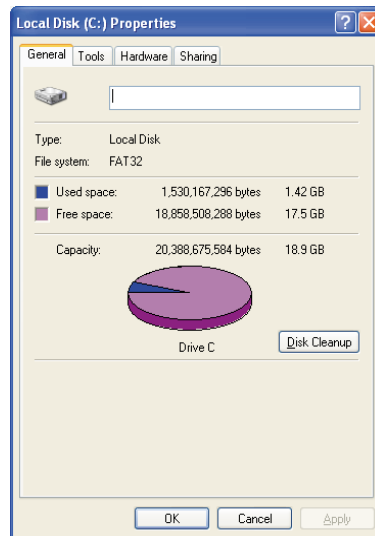

- 3 Click **Disk Cleanup**. The Disk Cleanup dialog box opens.



- 4 Select the check box beside each file type you want to delete. For more information about file types you can delete, read the descriptions in the Disk Cleanup dialog box.
- 5 Click **OK**, then click **Yes**.



## Checking the hard drive for errors

The Error-checking program in Windows XP and Windows 2000 or ScanDisk program in Windows Me and Windows 98 examines the hard drive for physical flaws and file and folder problems. These programs correct file and folder problems and mark flawed areas on the hard drive so that Windows does not use them.

If you use your computer several hours every day, you probably want to run Error-checking or ScanDisk once a week. If you use your computer less frequently, once a month may be adequate. Also use Error-checking or ScanDisk if you encounter hard drive problems.

### Help and Support



For more information on checking the hard drive for errors, click **Start**, then select **Help and Support** or **Help**.



### To checking the hard drive for errors:

- 1 In Windows XP, click **Start**, then select **My Computer**.  
- OR -  
In Windows Me, Windows 2000, or Windows 98, double-click the **My Computer** icon.
- 2 Right-click the hard drive that you want to check for errors, then select **Properties**. The System Properties dialog box opens.

- 3 Click the **Tools** tab.

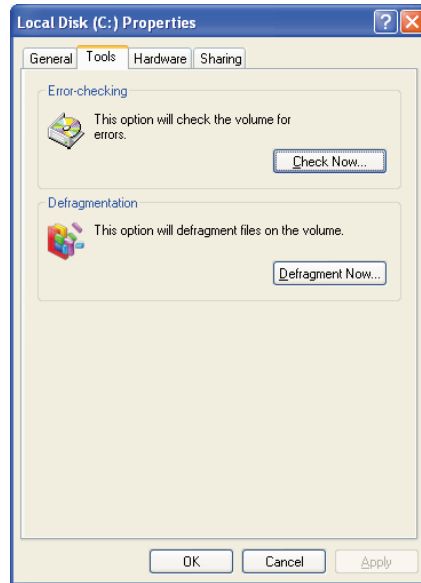

- 4 Click **Check Now**.
- 5 Select the options to use, then click **Start**. For help, press F1. Windows checks the drive for errors. This process may take several minutes.
- 6 Correct any problems that are found by following the on-screen instructions. After Windows has finished checking the drive for errors, it provides a summary of the problems that it found.
- 7 Click **OK**.



# Defragmenting the hard drive

When working with files, sometimes Windows divides the file information into pieces and stores them in different places on the hard drive. This is called *fragmentation*, and it is normal. In order for the computer to use a file, Windows must search for the pieces of the file and put them back together. This process slows the hard drive performance.

The Disk Defragmenter program organizes the data on the drive so that each file is stored as one unit rather than as multiple pieces scattered across different areas of the drive. Defragmenting the information stored on the drive can improve hard drive performance.

While the Disk Defragmenter program is running, do not use your keyboard or mouse because using them may continuously stop and restart the defragmenting process. Also, if you are connected to a network, log off before starting Disk Defragmenter. Network communication may stop the defragmentation process and cause it to start over.

## Help and Support



For more information on defragmenting your hard drive, click **Start**, then select **Help and Support** or **Help**.



## To run Disk Defragmenter:

**1** In Windows XP, click **Start**, then select **My Computer**.

- OR -

In Windows Me, Windows 2000, or Windows 98, double-click the **My Computer** icon.

**2** Right-click the hard drive that you want to defragment, then select **Properties**. The System Properties dialog box opens.

- 3 Click the **Tools** tab.

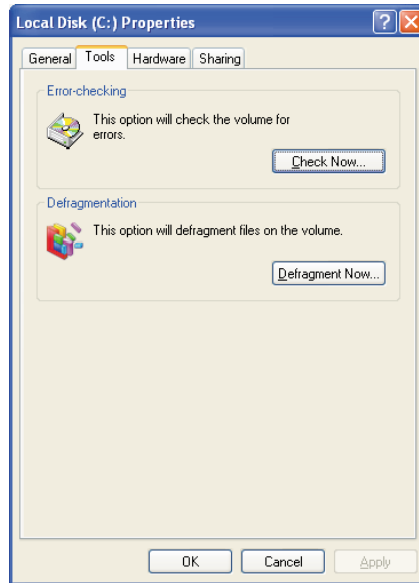

- 4 Click **Defragment Now**.
- 5 If Disk Defragmenter does not start automatically, click **Start** or **Defragment**.
- 6 Disk Defragmenter shows its progress on the screen. When finished, Disk Defragmenter asks if you want to quit the program.
- 7 Click **Close** or **Yes**.



# Backing up files

Backing up files and removing them from the hard drive frees space for new files on the hard drive. It also protects you from losing important information if the hard drive fails or you accidentally delete files.

You should back up your files regularly to a writable CD (if you have a CD-R or CD-RW drive) or to diskettes. Use a backup device, such as a CD-R, CD-RW, or Zip drive, to do a complete hard drive backup. If you do not have a high-capacity backup device and you want to purchase one, you can contact Gateway's Add-on Sales department or visit our Web site at [www.gateway.com](http://www.gateway.com).

**Help and Support**



For more information on backing up files, click **Start**, then select **Help and Support** or **Help**.

# Using the Scheduled Task Wizard

The Scheduled Task Wizard lets you schedule maintenance tasks such as running Disk Defragmenter and Error-checking or ScanDisk.

## Help and Support



For more information on using the Scheduled Task Wizard, click **Start**, then select **Help and Support** or **Help**.



## To start the Scheduled Task Wizard:

- 1 Click **Start**, then select **All Programs**, **Accessories**, **System Tools**, then **Scheduled Tasks**. The Scheduled Tasks window opens.
- 2 Double-click **Add Scheduled Task**. The Scheduled Tasks Wizard opens.



- 3 Click **Next**, then select the Scheduled Task Wizard option you want to create and follow the screen prompts to customize the task.

## Important



Your computer must be on during scheduled tasks.



# Cleaning your computer

Keeping your computer clean and the vents free from dust helps keep your system performing at its best. You may want to gather these items and put together a computer cleaning kit:

- A soft cloth
- Window cleaner (not for use on LCD panels)
- An aerosol can of air that has a narrow, straw-like extension
- Isopropyl alcohol
- Cotton swabs
- A CD/DVD drive cleaning kit

## Cleaning the exterior

### Warning



When you shut down your computer, the power turns off, but some electrical current still flows through the computer. To avoid possible injury from electrical shock, unplug the power cord and modem cable from the wall outlets.

Always turn off the computer and other peripherals before cleaning any components.

Use a damp, lint-free cloth to clean the computer and other parts of your system. Do not use abrasive or solvent cleaners because they can damage the finish on components.

Your computer is cooled by air circulated through the vents on the case, so keep the vents free of dust. With the computer turned off and unplugged, brush the dust away from the vents with a damp cloth. Be careful not to drip any water into the vents. Do not attempt to clean dust from the inside the computer.

## Cleaning the keyboard

You should clean the keyboard occasionally by using an aerosol can of air with a narrow, straw-like extension to remove dust and lint trapped under the keys.

If you spill liquid on the keyboard, turn off the computer and turn the unit upside down. Let the liquid drain, then let the keyboard dry before trying to use it again. If the keyboard does not work after it dries, you may need to replace it.

## Cleaning the screen

If your computer screen is an LCD panel, use a soft cloth and water to clean the screen. Squirt a little water on the cloth (never directly on the screen), and wipe the screen with the cloth.

### Caution



An LCD screen is made of specially coated glass and can be scratched or damaged by abrasive or ammonia-based window cleaners.

- OR -

If your computer screen is not an LCD panel, use a soft cloth and window cleaner to clean the monitor screen. Squirt a little cleaner on the cloth (never directly on the screen), and wipe the screen with the cloth.

## Cleaning the mouse

If you have a mouse and the mouse pointer begins moving erratically across the screen or becomes difficult to control precisely, then cleaning the mouse will likely improve its accuracy.

### Help and Support



For a video demonstration on cleaning the mouse, click **Start**, then select **Help and Support** or **Help**.





## To clean your mouse:

- 1 Turn the mouse upside down.
- 2 Rotate the retaining ring on the bottom of the mouse counter-clockwise.



- 3 Remove the retaining ring and mouse ball.



- 4 Remove any dust, lint, or dirt from the mouse ball with a soft cloth.
- 5 Clean the mouse rollers with a cotton swab dipped in isopropyl alcohol.



- 6 Replace the mouse ball and lock the retaining ring into place.



# Checking system health with LANDesk

LANDesk® Client Manager is a desktop management interface (DMI) that lets you monitor the health of your system components. Through LANDesk, you can view software and hardware properties. You can also set LANDesk to notify you when system resources reach certain levels.



## To install LANDesk Client Manager:

- 1 In the C:\DMI folder on your hard drive, double-click the **Setup** icon to launch the install wizard.
- 2 Follow the instructions that appear on the screen. If you are prompted for a password during the installation process, type **lowtco**.



LANDesk Client Manager comes with complete electronic documentation and online help. Refer to these documents and the program's Help for more information.

If you need to restore LANDesk from the System Restoration CD and are prompted for a password, type **lowtco** and press **ENTER**.

# System recovery

Take advanced precautions that will allow you to restart your system and recover damaged files in the event that your hard drive is damaged, or your BIOS or system files get corrupted.

## Creating a startup diskette

If your computer hard drive is damaged, you may not be able to start the computer from the hard drive. A *startup diskette* is a bootable diskette that enables you to start the computer and attempt to fix the problem.

Some operating systems prompt you to create a startup diskette as part of the setup process and some will allow you to create one at any time. Refer to the software documentation or see the online help for your operating system for specific instructions.

## Keeping a record of system configuration

Some operating systems allow you to print a summary of the configuration of your system and the memory allocation. This printed summary can provide information to reset your system configuration properly if the information is lost or help you troubleshoot your system. Refer to the software documentation or see the online help for your operating system for specific instructions.

## Using your System Restoration CD

The System Restoration CD included with your system can be used to:

- Install hardware drivers
- Reinstall selected software applications, such as LANDesk Client Manager
- Reinstall the operating system

Instructions for each operating system are provided with the System Restoration CD.



# Troubleshooting

## Introduction

If your computer does not operate correctly, re-read the instructions for the procedures you have performed. If an error occurs within a program, consult the documentation supplied with the program. This section identifies solutions to some possible problems.

## Troubleshooting checklist

Before turning on the computer, make sure that:

- The power cord is connected to the AC power-in connector and an AC outlet.
- The AC outlet is supplying power.
- If a power strip is used, it is turned on, and the circuit breaker is set.
- The voltage selection switch on the computer power supply reflects the proper voltage.

## Verifying your configuration

If your computer is not operating correctly, the BIOS may contain an invalid configuration parameter. Open the BIOS Setup utility and check your configuration settings. (See “About the BIOS Setup utility” on page 45.)

# Troubleshooting guidelines

As you troubleshoot your computer, keep the following guidelines in mind:

- Never remove the case cover while the computer is turned on.
- Do not attempt to open the monitor. Even if the power is disconnected, stored energy in the monitor components can inflict a painful or harmful shock.
- If a peripheral does not work, make sure that all of the connections are secure.
- If you see an error message on the screen, write it down, word for word. You may be asked about it when calling Gateway Technical Support.
- Only qualified personnel should open the computer for maintenance.
- If you are qualified to maintain the computer yourself, make sure you are properly grounded before opening the computer case. For more information on preventing electrostatic damage to the computer, see “Preventing static electricity discharge” on page 15 if you have a Gateway Mid-Tower case.

## Battery installation problems

If you have problems after installing the new battery, try each of the items listed below:

- Turn off the computer and make sure that all exterior cables are attached and secured to the correct connectors.
- Make sure that all power switches are on. If the computer is plugged into a power strip or surge protector, make sure it is turned on also.
- Enter the BIOS Setup utility and compare the settings on the screen with your notes or the computer hardware manuals. Correct any discrepancies.

- Turn off the computer, remove the cover, and make sure that all cables inside the case are attached securely. Also, make sure that the colored cable edges are aligned correctly and that the connectors do not miss any pins. Disconnect and reconnect the cables. Close the case as described on page 17, then turn on the computer.
- Turn off the computer, remove the cover and, if you have the proper test equipment, make sure that the new battery has power. (Although unlikely, your new battery may be defective.) Close the case as described on page 17, then turn on the computer.

# CD drive problems

## An audio CD produces no sound.

Probable cause	Solution
The CD is loaded incorrectly	Make sure the label is facing up, then try again.
The speakers are not connected	Make sure the speaker cables are connected properly and securely.
The speaker volume is turned down	Check the volume control and turn it up if necessary.
The speakers may be muted through the Multimedia volume control	<p>Make sure mute controls are turned off. To make sure mute is turned off:</p> <p>In Windows XP, click <b>Start</b>, then select <b>Control Panel</b>. Click <b>Sounds, Speech, and Audio Devices</b>, then <b>Adjust the system volume</b>. Make sure that the Mute check box is not selected.</p> <p>In Windows Me, Windows 2000, Windows 98, and Windows NT, double-click the speaker icon in the lower right corner of the taskbar and make sure that the <b>Master Out, CD Audio, MIDI, Digital</b>, and <b>Wave Mute</b> check boxes are not selected.</p>
The speakers may be faulty	Connect a set of headphones to the line out jack to test the output. If they work, replace the speakers.
The sound card may not be installed correctly	Open the computer, then reseal the sound card. Make sure the cables are connected properly. Some computers do not have sound cards because sound capabilities are built into the system board.
The CD drive audio cable may be installed incorrectly	Open the computer and make sure the cables are connected properly. Some computers do not have sound cards because sound capabilities are built into the system board.



## An audio CD will not play.

Probable cause	Solution
The CD is loaded incorrectly	Make sure the label is facing up, then try again.
The CD is scratched or dirty	Try cleaning the CD with a lint-free cloth. Make sure the CD is not scratched.

## The computer does not recognize the CD drive.

Probable cause	Solution
The CD is not intended for PC use	Make sure the CD is PC-compatible.
The CD drive needs to be added as new hardware	In the Control Panel window, double-click <b>Add New Hardware</b> . Follow the on-screen instructions for adding the drive.
The secondary IDE device may be disabled	Restart your computer, then press F1 to open the BIOS Setup utility program. From the <b>Advanced   IDE Configuration</b> menu, set the <b>IDE Controller</b> to <b>Both</b> and the <b>Secondary IDE Master</b> to <b>Auto</b> .
The CD cables are not installed correctly	Open the computer and make sure all cables between the CD controller and the CD drive are connected correctly.
The CD drive may be defective	Replace the CD drive.

# Computer problems

## The computer will not start up.

Probable cause	Solution
The computer is not connected to an AC outlet	Make sure the power cable(s) are connected correctly to an operating AC power source.
The voltage selection switch is not set correctly	Make sure the voltage selection switch is set correctly for your area.

## The computer is non-responsive.

Probable cause	Solution
An error occurred while running a program or your computer may be out of memory	Restart your computer. If the computer is still non-responsive, press and hold in the power button for 5 seconds to turn the computer off. Turn the computer back on and follow the on-screen instructions.
The heatsink is not properly seated on the processor.	Reseat the heatsink.

## The keyboard does not work.

Probable cause	Solution
A key was pressed while the computer was starting up	Clear the stuck key, then turn off the computer, wait for a few seconds, then turn the computer back on.
The keyboard is not plugged in or connected properly	Make sure the cable is plugged in correctly.
Something spilled into the keyboard	Turn off the computer. Turn the keyboard upside down to drain, then turn it over and let it dry before using the keyboard again.
The keyboard is defective	Try a keyboard you know is working.

## The mouse does not work.

---

<b>Probable cause</b>	<b>Solution</b>
The mouse is not plugged in or connected properly	Make sure the cable is plugged in correctly.
The mouse driver did not load when the computer started	Load the appropriate mouse driver manually or contact Gateway Technical Support.
The mouse is defective	Try a mouse that you know is working.

# Diskette drive problems

## The computer does not recognize the diskette drive.

Probable cause	Solution
The diskette drive may be configured incorrectly	Restart your computer, then press F1 to open the BIOS Setup utility. In the <b>Advanced I Diskette Configuration</b> menu, make sure that the diskette drive parameters are set correctly.
The drive cables are not connected properly	Open the computer and make sure all cables are correctly connected to the system board.

## The diskette drive will not read, write, or format.

Probable cause	Solution
The diskette is not IBM-formatted	Make sure the diskette you are trying to use is IBM-compatible. If it is, try reformatting it. If it is not, get a compatible diskette.
The diskette is corrupted	Check the diskette for errors. If you have detected and corrected errors, try accessing the diskette again.
The diskette is write-protected	Make sure the write-protection window on the upper-right corner of the diskette is closed (unprotected).

## The diskette drive LED illuminates continuously.

Probable cause	Solution
The diskette is corrupt	Remove the diskette from the drive. If the light remains on, try restarting the computer.
The cable to the drive is not connected properly	Open the computer and make sure the cable is connected properly between the diskette drive and its controller. Make sure the pins are not bent or misaligned.

# Hard drive problems

## The computer does not recognize the IDE drive.

Probable cause	Solution
The primary IDE device may be configured incorrectly	Restart your computer, then press F1 to open the BIOS Setup utility. From the <b>Advanced I IDE Configuration</b> menu, set the <b>IDE Controller to Both</b> and the <b>Primary IDE Master to Auto</b> .
The drive may not be configured properly	Consult the hard drive user's guide for instructions on how to configure the drive. Configure the drive correctly.
The drive cables are not connected properly	Open the computer and make sure all cables to the controller card are connected correctly. Some computers do not have IDE controller cards because the IDE controller is built into the system board.
The drive controller is not seated properly	Open the computer and reseal the drive controller. Some computers do not have IDE controller cards because the IDE controller is built into the system board.

# Memory problems

The computer detected memory errors during start up.

<b>Probable cause</b>	<b>Solution</b>
Memory was added or removed, and the new configuration was not saved in BIOS Setup utility	Open the BIOS Setup utility and save the new memory configuration.
The memory was installed incorrectly	Make sure the memory is seated and oriented correctly.
A memory chip is faulty	Replace the card with the faulty chip. Third-party diagnostic programs can help determine which chip or memory segment is failing.

# Modem problems

**The computer does not recognize the modem.**

<b>Probable cause</b>	<b>Solution</b>
The modem has not been added as new hardware	Add the modem as new hardware.
The modem is not connected to a live phone jack	Make sure the line connected to the modem is working and plugged into the appropriate port on the modem (line port).
The phone jack is in use	If the modem shares the jack with another device, make sure the other device does not have the port open (for example, someone is on the phone, or another modem is in use).

# Peripheral/adapter problems

**The computer does not recognize an adapter card.**

<b>Probable cause</b>	<b>Solution</b>
The interrupt or I/O address is set incorrectly	Check the address configuration of the adapter card and make sure that it does not conflict with another card in the computer.
The card was not configured through the software	Configure the card with the appropriate software.
The card was not installed correctly	Make sure that the jumpers are configured correctly, then reseal the card.



# Printer problems

## The printer will not turn on.

Probable cause	Solution
The printer is not plugged in	Make sure the power cable is plugged into a working power source.
The printer is not turned on	Make sure the printer's power switch is pressed or set to the On position. If the printer is turned on, the green power LED should be illuminated.
The printer is defective	Try another printer, if one is available.

## The printer is turned on but will not print.

Probable cause	Solution
The printer is not connected to the computer	Make sure the data cable is properly connected between the printer and the computer. Check the connector and cable for bent or broken pins.
The printer is not designated as the default printer	If the printer that you are trying to print to is not the default printer, make sure you have selected it through the program's printer setup function.
The printer has not been added to the computer.	In the Printers window, double-click <b>Add Printer</b> . Follow the on-screen instructions for adding the new printer.
The printer is not on-line (ready)	Make sure the on-line or ready light is on, or the display indicates "Ready."

## The printer prints garbled text.

Probable cause	Solution
The wrong driver is being used for the selected printer	In the Printers window, click to select the printer, click <b>File</b> , then select <b>Properties</b> . Make sure the printer is using the correct printer driver. If not, install the correct one.

# Video problems

## The computer is running but the screen is blank.

Probable cause	Solution
The monitor is not turned on	Make sure the monitor is plugged in and turned on. If the monitor is turned on, the green power LED should illuminate.
The monitor's data cable is not connected	Make sure the monitor data cable is connected to the video controller on the back of the computer.
The connector or cable is damaged	Check the connector and cable for bent or damaged pins.
The monitor brightness and contrast controls are turned down	Adjust the brightness and contrast knobs to the center position.
System board memory is not seated properly - indicated by a beep	Open the computer and reseat the system board memory.
The monitor is defective	Connect a working monitor to the computer.

## The image on the screen is dim or difficult to read.

Probable cause	Solution
The monitor brightness and contrast controls are turned down	Adjust the brightness and contrast knobs until the text becomes clear.
Light is glaring off the display	Position the monitor away from the sun or other light source.
The monitor may be old	Replace the monitor.

## The color monitor displays everything in black and white.

Probable cause	Solution
The computer was turned on before the monitor	Make sure the monitor is turned on, then restart the computer.
The display type is set incorrectly	In the Control Panel window, double-click <b>Display</b> , set the display to the appropriate video type and resolution, then restart the computer.

## The displayed characters are garbled.

Probable cause	Solution
The video cable is damaged	Make sure the cable and connectors are in good condition (no bent pins or broken wires).
The display setup is incorrect	In the Control Panel window, double-click <b>Display</b> and check the settings. The correct video type should be selected, along with a supported resolution. Check your monitor and video controller documentation for details.

## The video is distorted.

Probable cause	Solution
The monitor controls are not properly adjusted	Adjust the monitor controls until the text becomes clear. (See your monitor documentation for more information.)
The connector or cable is damaged	Make sure the cable and connectors are in good condition (no bent pins or broken wires).
The surge protector or UPS is damaged	Disconnect the monitor power cable and connect it directly to the power source.
The monitor is too close to a source of electrical interference	Move the monitor away from sources of electrical interference, such as televisions, unshielded speakers, microwave ovens, fluorescent lights, and metal beams or shelves.
The monitor needs to be degaussed	Turn off the computer and monitor for at least a half hour, then restart the computer.

# Error messages

This section lists common error messages that you may see. These messages often indicate procedural errors such as an incorrect keystroke or a write-protected diskette. Some messages, however, may indicate a problem that requires you to consult the troubleshooting section of this manual.

Error message	Description
GA20 Error	An error occurred with Gate A20 when switching to protected mode during the memory test.
Pri Master HDD Error Pri Slave HDD Error Sec Master HDD Error Sec Slave HDD Error	Could not read sector from corresponding drive.
Pri Master Drive - ATAPI Incompatible Pri Slave Drive - ATAPI Incompatible Sec Master Drive - ATAPI Incompatible Sec Slave Drive - ATAPI Incompatible	Corresponding drive is not an ATAPI device. Run Setup to make sure device is selected correctly.
A: Drive Error	No response from diskette drive.
Cache Memory Bad	An error occurred when testing L2 cache. Cache memory may be bad.
CMOS Battery Low	The battery may be losing power. Replace the battery soon.
CMOS Display Type Wrong	The display type is different than what has been stored in CMOS. Check the BIOS Setup utility to make sure the type is correct.
CMOS Checksum Bad	The CMOS checksum is incorrect. CMOS memory may have been corrupted. Run the BIOS Setup utility to reset values.
CMOS Settings Wrong	CMOS values are not the same as the last boot. These values have either been corrupted or the battery has failed.
CMOS Date/Time Not Set	The time and/or date values stored in CMOS are invalid. Run the BIOS Setup utility to set correct values.
DMA Error	Error during read/write test of DMA controller.

<b>Error message</b>	<b>Description</b>
FDC Failure	Error occurred trying to access diskette drive controller.
HDC Failure	Error occurred trying to access hard disk controller.
Memory Size Decreased	Memory size has decreased since the last boot. If no memory was removed, then memory may be bad.
Memory Size Increased	Memory size has increased since the last boot. If no memory was added, there may be a problem with the system.
Memory Size Changed	Memory size has changed since the last boot. If no memory was added or removed, then memory may be bad.
No Boot Device Available	System did not find a device to boot from.
Off Board Parity Error	A parity error occurred on an expansion card. This error is followed by an address.
On Board Parity Error	A parity error occurred in system board main memory. This error is followed by an address.
Parity Error	A parity error occurred in system board main memory at an unknown address.
No Keyboard Found	No keyboard was found. Check the keyboard connection. For more information, see "The keyboard does not work." on page 82.
No Mouse Found	No mouse was found. Power down and check the mouse connection. For more information, see "The mouse does not work." on page 83.
S.M.A.R.T. Indicates An Imminent Hard Drive Failure	A problem with the hard drive has been detected. For more information, see "Hard drive problems" on page 85.
No CD-ROM / DVD Drive Found	The CD-ROM drive was not found. For more information, see "CD drive problems" on page 80.
No Hard Drive Found	The hard drive was not found. For more information, see "Hard drive problems" on page 85.

# Beep codes

Whenever a recoverable error occurs during POST, the BIOS displays an error message describing the problem. The BIOS also issues a beep code (one long tone followed by two short tones) during POST if the video configuration fails (a faulty video card or no card installed) or if an external ROM module does not properly checksum to zero.

An external ROM module (for example, a video BIOS) can also issue audible errors, usually consisting of one long tone followed by a series of short tones. For more information on the beep codes issued, check the documentation for that external device.

There are several POST routines that issue a POST terminal error and shut down the system if they fail. Before shutting down the system, the terminal-error handler issues a beep code signifying the test point error. This beep code consists of one long tone and a series of short tones.

If POST completes normally, the BIOS issues one short beep before passing control to the operating system.

<b>Short Beeps</b>	<b>Description</b>
1	Refresh failure
2	Parity cannot be reset
3	First 64 KB memory failure
4	Timer not operational
5	Not used
6	8042 GateA20 cannot be toggled
7	Exception interrupt error
8	Display memory R/W error
9	Not used
10	CMOS shutdown register test error
11	Invalid BIOS (for example, POST module not found)





# Reference Data



## Intel 850 ATX System Board Technical Reference

### Features

This FC-PGA2 system board uses the Intel® 850 chipset. The system board supports:

- Direct RAMBUS® RDRAM RIMM system memory
- Intel® Pentium® 4 processors
- Ultra ATA 33/66/100 drives
- 100 MHz Front Side Bus (FSB) (400 MHz Data Bus)
- 4x AGP
- ACPI 1.0b power management
- Integrated Intel 802.3 10/100 Mbit/sec LAN

# System board layout

The following illustration shows the system board divided into two sections:

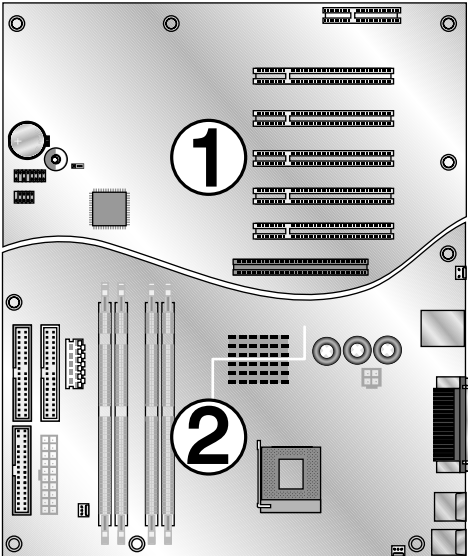

## Section 1

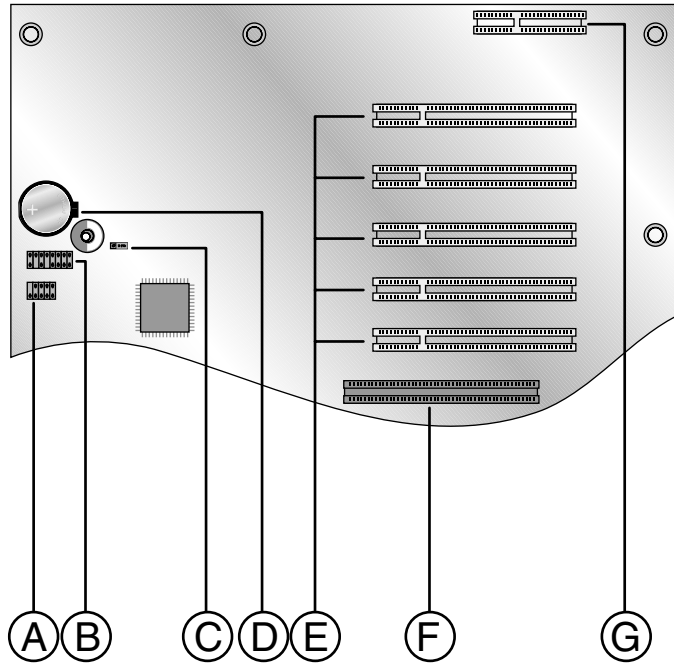

- A** USB front panel header (2.0)
- B** Front panel header
- C** BIOS configuration jumper
- D** Battery
- E** PCI expansion slots
- F** AGP expansion slot
- G** CNR expansion slot (not supported)

## Section 2

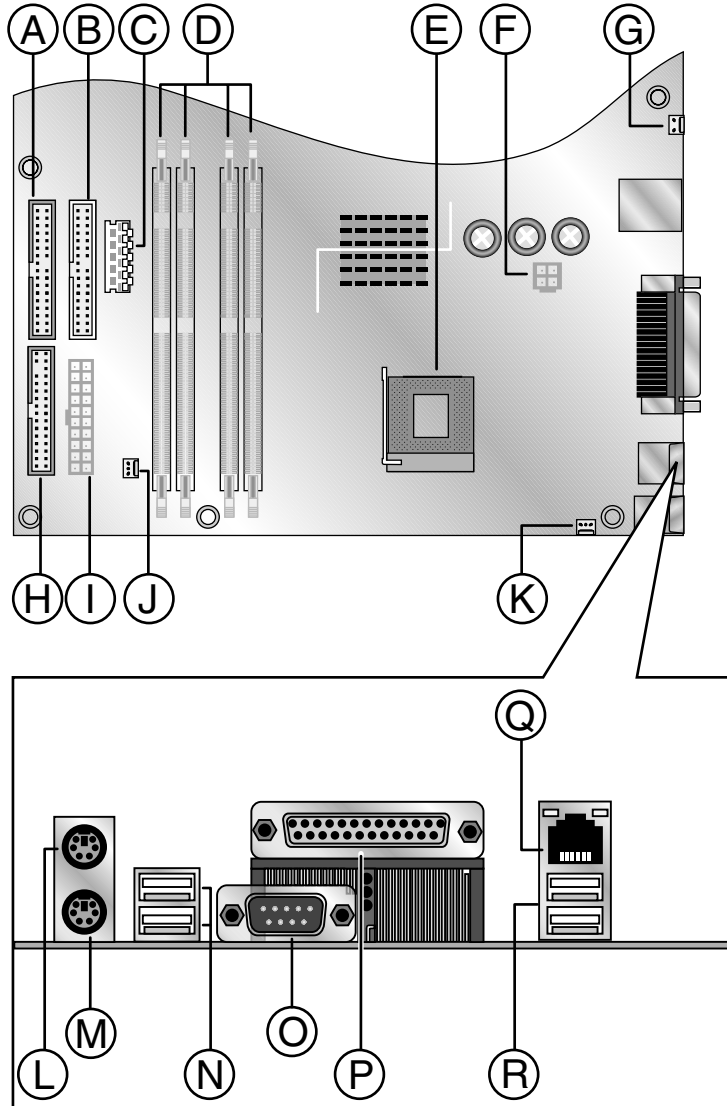

- A** Primary IDE cable connector
- B** Secondary IDE cable connector
- C** Auxiliary power connector
- D** Memory expansion slots
- E** Processor socket
- F** Auxiliary power connector
- G** Intruder header
- H** Diskette drive cable connector
- I** Main power connector
- J** Auxiliary fan connector
- K** Processor fan connector
- L** Personal System/2™ (PS/2) mouse port
- M** PS/2 keyboard port
- N** USB ports (1.1)
- O** Serial (COM) connector
- P** Parallel (LPT) printer connector
- Q** Network jack
- R** USB ports (2.0)

# BIOS configuration jumper settings

The BIOS configuration jumper lets you clear passwords or recover your BIOS if it becomes corrupted. For information about the location of this jumper, see “Section 1” on page 99.

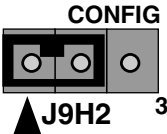
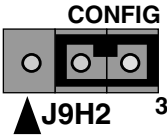
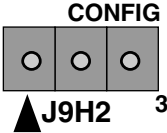
Setting	Jumper placement	When used
Normal	 <p>The diagram shows a three-pin jumper labeled 'CONFIG' and 'J9H2' with a '3' to its right. A black jumper is placed over the first two pins (pins 1 and 2).</p>	For normal operation (1-2 position)
Configure	 <p>The diagram shows a three-pin jumper labeled 'CONFIG' and 'J9H2' with a '3' to its right. A black jumper is placed over the second and third pins (pins 2 and 3).</p>	For clearing passwords (2-3 position)
Recover	 <p>The diagram shows a three-pin jumper labeled 'CONFIG' and 'J9H2' with a '3' to its right. No jumper is present, and all three pins are open.</p>	For recovering the BIOS (no jumper)

# Specifications

The following specifications are for the standard configuration. Your system may contain optional equipment. All specifications are subject to change without notice or obligation.

<b>Supported processors</b>	Intel® Pentium® 4 processors utilizing 478-pin FC-PGA2 connector
<b>Chipset</b>	Intel 850
<b>Memory</b>	184-pin, 2.5V, PC800 Direct Rambus Interface Memory Modules (RIMMs). Two channels. Four slots. Expandable to 2 GB (with 512 Mb technology).
<b>BIOS</b>	AMI BIOS. Flash BIOS for easy updates from diskette.
<b>Hard drive interface</b>	Supports four IDE devices using two on-board PCI IDE connectors with PIO, Bus Master, and Ultra DMA33/66/100 operation modes. Automatic drive type selection for easy setup.
<b>Diskette drive interface</b>	A diskette drive controller is integrated on the system board. Support is available for a single diskette drive.
<b>Universal Serial Bus (USB)</b>	4 USB 2.0 ports, 2 USB 1.1 ports <ul style="list-style-type: none"><li>▪ 4 rear ports (2 USB 2.0, 2 USB 1.1)</li><li>▪ 2 front panel ports (USB 2.0)</li></ul>
<b>Mouse</b>	PS/2 mouse port
<b>Keyboard</b>	PS/2 keyboard port
<b>Input/Output connectors</b>	One parallel (LPT) port and one serial (COM) port. Settings are configurable from the system setup program. No jumper changes required.
<b>LAN Subsystem</b>	Integrated Intel 802.3 10/100 Mbit/sec LAN
<b>Battery</b>	2032-style
<b>AGP expansion slot</b>	1
<b>PCI expansion slots</b>	5
<b>CNR expansion slot</b>	1 (not supported)



**Environment**

Operating temperature: 10°C to 35°C (50°F to 95°F)

Humidity: 20% to 80%

Altitude: -60.96 m to 3048 m

CPU clearance: >10.16 mm after installation, top and sides

Many products for Gateway and its subsidiaries are custom engineered by our suppliers to Gateway specifications and may vary from similarly marketed products.



# Safety, Regulatory, and Legal Information

# B

## Important safety information

Your Gateway system is designed and tested to meet the latest standards for safety of information technology equipment. However, to ensure safe use of this product, it is important that the safety instructions marked on the product and in the documentation are followed.

### Warning



Always follow these instructions to help guard against personal injury and damage to your Gateway system.

### Setting up your system

- Read and follow all instructions marked on the product and in the documentation before you operate your system. Retain all safety and operating instructions for future use.
- Do not use this product near water or a heat source such as a radiator.
- Set up the system on a stable work surface.
- The product should be operated only from the type of power source indicated on the rating label.
- If your computer has a voltage selector switch, make sure that the switch is in the proper position for your area. The voltage selector switch is set at the factory to the correct voltage.
- Openings in the computer case are provided for ventilation. Do not block or cover these openings. Make sure you provide adequate space, at least 6 inches (15 cm), around the system for ventilation when you set up your work area. Never insert objects of any kind into the computer ventilation openings.

- Some products are equipped with a three-wire power cord to make sure that the product is properly grounded when in use. The plug on this cord will fit only into a grounding-type outlet. This is a safety feature. If you are unable to insert the plug into an outlet, contact an electrician to install the appropriate outlet.
- If you use an extension cord with this system, make sure that the total ampere rating on the products plugged into the extension cord does not exceed the extension cord ampere rating.
- If your system is fitted with a TV Tuner, cable, or satellite receiver card, make sure that the antenna or cable system is electrically grounded to provide some protection against voltage surges and buildup of static charges.

### Care during use

- Do not walk on the power cord or allow anything to rest on it.
- Do not spill anything on the system. The best way to avoid spills is to avoid eating and drinking near your system.
- Some products have a replaceable CMOS battery on the system board. There is a danger of explosion if the CMOS battery is replaced incorrectly. Replace the battery with the same or equivalent type recommended by the manufacturer. Dispose of batteries according to the manufacturer's instructions.
- When the computer is turned off, a small amount of electrical current still flows through the computer. To avoid electrical shock, always unplug all power cables and modem cables from the wall outlets before cleaning the system.
- Unplug the system from the wall outlet and refer servicing to qualified personnel if:
  - The power cord or plug is damaged.
  - Liquid has been spilled into the system.
  - The system does not operate properly when the operating instructions are followed.
  - The system was dropped or the cabinet is damaged.
  - The system performance changes.

### Replacement parts and accessories

Use only replacement parts and accessories recommended by Gateway.

#### Important



Do not use Gateway products in areas classified as hazardous locations. Such areas include patient care areas of medical and dental facilities, oxygen-laden environments, or industrial facilities.

#### Caution



To reduce the risk of fire, use only No. 26 AWG or larger telecommunications line cord.

# Regulatory compliance statements

## United States of America

### Federal Communications Commission (FCC) Unintentional emitter per FCC Part 15

This device has been tested and found to comply with the limits for a Class B digital device, pursuant to Part 15 of the FCC rules. These limits are designed to provide reasonable protection against harmful interference in a residential installation. This equipment generates, uses, and can radiate radio frequency energy and, if not installed and used in accordance with the instructions, may cause harmful interference to radio or television reception. However, there is no guarantee that interference will not occur in a particular installation. If this equipment does cause interference to radio and television reception, which can be determined by turning the equipment off and on, the user is encouraged to try to correct the interference by one or more of the following measures:

- Reorient or relocate the receiving antenna
- Increase the separation between the equipment and receiver
- Connect the equipment to an outlet on a different circuit from that to which the receiver is connected
- Consult the dealer or an experienced radio/TV technician for help.

**Compliance Accessories:** The accessories associated with this equipment are: shielded video cable when an external monitor is connected. These accessories are required to be used in order to ensure compliance with FCC rules.

### FCC declaration of conformity

#### Responsible party:

Gateway Companies, Inc.  
610 Gateway Drive, North Sioux City, SD 57049  
(605) 232-2000 Fax: (605) 232-2023

#### Product:

- Gateway E-4650

For unique identification of the product configuration, please submit the 10-digit serial number found on the product to the responsible party.

This device complies with Part 15 of the FCC Rules. Operation of this product is subject to the following two conditions: (1) this device may not cause harmful interference, and (2) this device must accept any interference received, including interference that may cause undesired operation.

#### Caution



Changes or modifications not expressly approved by Gateway could void the FCC compliance and negate your authority to operate the product.

### Telecommunications per FCC part 68

### **(applicable to products fitted with USA modems)**

Your modem complies with Part 68 of the Federal Communications Commission (FCC) rules. On the computer or modem card is a label that contains the FCC registration number and Ringer Equivalence Number (REN) for this device. If requested, this information must be provided to the telephone company.

An FCC-compliant telephone line cord with a modular plug is required for use with this device. The modem is designed to be connected to the telephone network or premises wiring using a compatible modular jack which is Part 68-compliant. See installation instructions for details.

The Ringer Equivalence Number (REN) is used to determine the number of devices which may be connected to the telephone line. Excessive RENs on a telephone line may result in the devices not ringing in response to an incoming call. In most areas, the sum of RENs should not exceed five (5.0). To be certain of the number of devices that may be connected to a line, as determined by the total RENs, contact the local telephone company.

If this device causes harm to the telephone network, the telephone company will notify you in advance that temporary discontinuance of service may be required. The telephone company may request that you disconnect the equipment until the problem is resolved.

The telephone company may make changes in its facilities, equipment, operations, or procedures that could affect the operation of this equipment. If this happens, the telephone company will provide advance notice in order for you to make necessary modifications to maintain uninterrupted service.

This equipment cannot be used on telephone company-provided coin service. Connection to party line service is subject to state tariffs. Contact the state public utility commission or public service commission for information.

When programming or making test calls to emergency numbers:

- Remain on the line and briefly explain to the dispatcher the reason for the call.
- Perform such activities in the off-peak hours such as early morning or late evenings.

The United States Telephone Consumer Protection Act of 1991 makes it unlawful for any person to use a computer or other electronic device to send any message via a telephone fax machine unless such message clearly contains, in a margin at the top or bottom of each transmitted page or on the first page of the transmission, the date and time it is sent, an identification of the business, other entity, or other individual sending the message, and the telephone number of the sending machine or such business, other entity, or individual. Refer to your fax communication software documentation for details on how to comply with the fax-branding requirement.

# Canada

## Industry Canada (IC)

### Unintentional emitter per ICES-003

This digital apparatus does not exceed the Class B limits for radio noise emissions from digital apparatus as set out in the radio interference regulations of Industry Canada.

Le présent appareil numérique n'émet pas de bruits radioélectriques dépassant les limites applicables aux appareils numériques de Classe B prescrites dans le règlement sur le brouillage radioélectrique édicté par Industrie Canada.

### Telecommunications per DOC notice (for products fitted with an IC-compliant modem)

The Industry Canada label identifies certified equipment. This certification means that the equipment meets certain telecommunications network protective, operation, and safety requirements. The Department does not guarantee the equipment will operate to the users' satisfaction.

Before installing this equipment, users should make sure that it is permissible to be connected to the facilities of the local telecommunications company. The equipment must also be installed using an acceptable method of connection. In some cases, the inside wiring associated with a single-line individual service may be extended by means of a certified connector assembly. The customer should be aware that compliance with the above conditions may not prevent degradation of service in some situations.

Repairs to certified equipment should be made by an authorized Canadian maintenance facility designated by the supplier. Any repairs or alterations made by the user to this equipment, or equipment malfunctions, may give the telecommunications company cause to request the user to disconnect the equipment.

Users should make sure, for their own protection, that the electrical ground connections of the power utility, telephone lines, and internal metallic water pipe system, if present, are connected together. This precaution may be particularly important in rural areas.

#### Warning



To avoid electrical shock or equipment malfunction do not attempt to make electrical ground connections by yourself. Contact the appropriate inspection authority or an electrician, as appropriate.

The **Ringer Equivalence Number** (REN) assigned to each terminal device provides an indication of the maximum number of terminals allowed to be connected to a telephone interface. The termination on an interface may consist of any combination of devices subject only to the requirement that the sum of the Ringer Equivalence Numbers of all the devices does not exceed 5.

# European Union

The following information is only applicable to systems labeled with the CE mark .

## European directives

This Information Technology Equipment has been tested and found to comply with the following European directives:

- EMC Directive 89/336/EEC with amending directives 92/31/EEC & 93/68/EEC as per
  - EN 55022 Class B
  - EN 61000-3-2
  - EN 61000-3-3
  - EN 55024
- Low Voltage Directive (Safety) 73/23/EEC as per EN 60950(A1/A2/A3/A4/A11)
- Radio and Telecom Terminal Equipment Directive 199/5/EC as per CTR21 (if fitted with a modem device)

## European telecommunication information (for products fitted with EU-approved modems)

Marking by the symbol  indicates compliance of this equipment to the Radio and Telecom Terminal Equipment Directive 1999/5/EC. Such marking is indicative that this equipment meets or exceeds the following technical standards:

CTR 21 – Attachment requirements for pan-European approval for connection to the analogue Public Switched Telephone Networks (PSTNs) of TE (excluding TE supporting voice telephony services) in which network addressing, if provided, is by means of Dual Tone Multi-Frequency (DTMF) signaling.

### Warning



Although this equipment can use either loop disconnect (Pulse) or DTMF (Tone) signaling, only the performance of the DTMF signaling is subject to regulatory requirements for correct operation. It is therefore strongly recommended that the equipment is set to use DTMF signaling for access to public or private emergency services. DTMF signaling also provides faster call setup.

This equipment has been approved to Council Decision 98/482/EEC—“CTR 21” for Pan-European single terminal connection to the Public Switched Telephone Network (PSTN). However, due to differences between the individual PSTNs provided in different countries, the approval does not, of itself, give an unconditional assurance of successful operation on every PSTN termination point. In the event of problems, you should contact Gateway Technical Support.



# Japan

## VCCI statement

This equipment is in the Class B category (Information Technology Equipment to be used in a residential area or an adjacent area thereto) and conforms to the standards set by the Voluntary Control Council for Interference by Information Technology Equipment aimed at preventing radio interference in such residential areas. When used near a radio or TV receiver, it may become the cause of radio interference. Read instructions for correct handling.

### 電波障害について

この装置は、情報処理装置等電波障害自主規制協議会（VCCI）の基準に基づくクラスB情報技術装置です。この装置は、家庭環境で使用することを目的としていますが、この装置がラジオやテレビジョン受信機に近接して使用されると、受信障害を引き起こすことがあります。

取扱説明書に従って正しい取り扱いをして下さい。

# Australia and New Zealand

## EMI statement

This device has been tested and found to comply with the limits for a Class B digital device, pursuant to the Australian/New Zealand standard AS/NZS 3548 set out by the Australian Communications Authority and the Radio Spectrum Management Agency.

## New Zealand telecommunication statement (for products fitted with Telepermit-approved modems)

The grant of a Telepermit for any item of terminal equipment indicates only that Telecom has accepted that the item complies with minimum conditions for connection to its network. It indicates no endorsement of the product by Telecom, nor does it provide any sort of warranty. Above all, it provides no assurance that any item will work correctly in all respects with another item of Telepermitted equipment of a different make or model, nor does it imply that any product is compatible with all of Telecom's network services.

This equipment shall not be set up to make automatic calls to the Telecom '111' Emergency Service.

### Important



Under power failure conditions, this telephone may not operate. Make sure that a separate telephone, not dependent on local power, is available for emergency use.

Some parameters required for compliance with Telecom's Telepermit requirements are dependent on the equipment (PC) associated with this device. The associated equipment shall be set to operate within the following limits for compliance with Telecom's specifications:

- (a) There shall be no more than 10 calls to the same number within any 30-minute period for any single manual call initiation, and
- (b) The equipment shall go on-hook for a period of not less than 30 seconds between the end of one attempt and the beginning of the next attempt.

The equipment shall be set to make sure that automatic calls to different numbers are spaced such that there is no less than 5 seconds between the end of one call attempt and the beginning of another.

The equipment shall be set to make sure that calls are answered between 3 and 30 seconds of receipt of ringing.

# Laser safety statement

All Gateway systems equipped with CD and DVD drives comply with the appropriate safety standards, including IEC 825. The laser devices in these components are classified as “Class 1 Laser Products” under a US Department of Health and Human Services (DHHS) Radiation Performance Standard. Should the unit ever need servicing, contact an authorized service location.

## **Warning**



Use of controls or adjustments or performance of procedures other than those specified in this manual may result in hazardous radiation exposure. To prevent exposure to laser beams, do not try to open the enclosure of a CD or DVD drive.

# Television antenna connectors protection (for systems fitted with TV/cable TV tuner cards)

## External television antenna grounding

If an outside antenna or cable system is to be connected to your Gateway PC, make sure that the antenna or cable system is electrically grounded to provide some protection against voltage surges and static charges.

Article 810 of the National Electrical Code, ANSI/NFPA 70, provides information with regard to proper grounding of the mast and supporting structure, grounding of the lead-in wire to an antenna discharge unit, size of grounding conductors, location of antenna discharge unit, connection to grounding electrodes, and requirements for the grounding electrode.

## Lightning protection

For added protection of any Gateway product during a lightning storm or when it is left unattended or unused for long periods of time, unplug the product from the wall outlet and disconnect the antenna or cable system.

## Power lines

Do not locate the antenna near overhead light or power circuits, or where it could fall into such power lines or circuits.

**Warning**



When installing or realigning an outside antenna system, extreme care should be taken to keep from touching such power lines or circuits. Contact with them could be fatal.

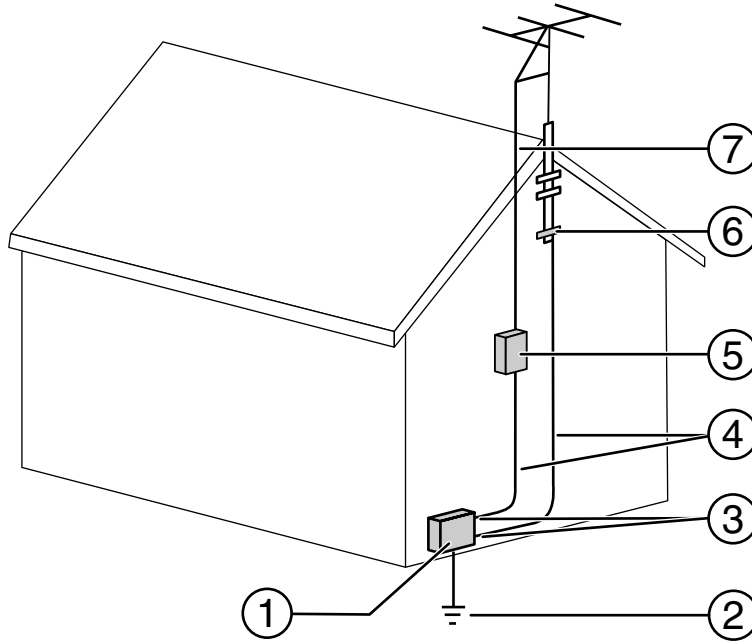

**Antenna and satellite grounding**

Reference	Grounding component
1	Electric service equipment
2	Power service grounding electrode system (NEC Art 250, Part H)
3	Ground clamps
4	Grounding conductors (NEC Section 810-21)
5	Antenna discharge unit (NEC Section 810-20)
6	Ground clamp
7	Antenna lead-in wire

# Notices

Copyright © 2001 Gateway, Inc.  
All Rights Reserved  
4545 Town Centre Court  
San Diego, CA 92121 USA

## All Rights Reserved

This publication is protected by copyright and all rights are reserved. No part of it may be reproduced or transmitted by any means or in any form, without prior consent in writing from Gateway.

The information in this manual has been carefully checked and is believed to be accurate. However, changes are made periodically. These changes are incorporated in newer publication editions. Gateway may improve and/or change products described in this publication at any time. Due to continuing system improvements, Gateway is not responsible for inaccurate information which may appear in this manual. For the latest product updates, consult the Gateway Web site at [www.gateway.com](http://www.gateway.com). In no event will Gateway be liable for direct, indirect, special, exemplary, incidental, or consequential damages resulting from any defect or omission in this manual, even if advised of the possibility of such damages.

In the interest of continued product development, Gateway reserves the right to make improvements in this manual and the products it describes at any time, without notices or obligation.

## Trademark Acknowledgments

1-800-GATEWAY, ActiveCPR, ALR, AnyKey, black-and-white spot design, CrystalScan, Destination, DestiVu, EZ Pad, EZ Point, Field Mouse, Gateway 2000, Gateway Country, gateway.net, Gateway stylized logo, Perfect Scholar, Solo, TelePath, Vivitron, stylized "G" design, and "You've got a friend in the business" slogan are registered trademarks and black-and-white spotted box logo, GATEWAY, Gateway Astro, Gateway@Work, Gateway Connected touch pad, Gateway Connected music player, Gateway Cyber:)Ware, Gateway Education:)Ware, Gateway Flex Case, Gateway Gaming:)Ware, Gateway GoBack, Gateway Gold, Gateway Learning:)Ware, Gateway Magazine, Gateway Micro Server, Gateway Money:)Ware, Gateway Music:)Ware, Gateway Networking Solutions, Gateway Online Network (O.N.) solution, Gateway Photo:)Ware, Gateway Professional PCs, Gateway Profile, Gateway Solo, green stylized GATEWAY, green stylized Gateway logo, Gateway Teacher:)Ware, Gateway Video:)Ware, HelpSpot, InforManager, Just click it!, Learn@Gateway, Kids BackPack, SERVE-TO-ORDER, Server Watchdog, SpotShop, Spotshop.com, and Your:)Ware are trademarks of Gateway, Inc. Intel, Intel Inside logo, and Pentium are registered trademarks and MMX is a trademark of Intel Corporation. Microsoft, MS, MS-DOS, and Windows are trademarks or registered trademarks of Microsoft Corporation. All other product names mentioned herein are used for identification purposes only, and may be the trademarks or registered trademarks of their respective companies.

## Macrovision statement

**If your computer has a DVD drive and an analog TV Out port, the following paragraph applies:**

This product incorporates copyright protection technology that is protected by method claims of certain U.S. patents and other intellectual property rights owned by Macrovision Corporation and other rights owners. Use of this copyright protection technology must be authorized by Macrovision Corporation, and is intended for home and other limited viewing uses only unless otherwise authorized by Macrovision Corporation. Reverse engineering or disassembly is prohibited.

# Index

## Numerics

- 3.5-inch device
  - cabling information 22
  - installing 21
  - preparing to install 21
  - removing 21
  - replacing 21

## A

- AC power connector 5
- accessories
  - safety precautions 108
- adapter card
  - installing 30
  - removing 30
  - replacing 30
  - troubleshooting 88
- add-in card
  - installing 30
  - removing 30
  - replacing 30
  - troubleshooting 88
- additional information vi
- adjusting the monitor 10
- advanced menu
  - BIOS Setup utility 47
- air circulation
  - providing space 9

## B

- back features 4
- backing up files 69
- battery
  - installing 42
  - removing 42
  - replacing 42
  - troubleshooting 78
  - warnings 42
- beep codes 94
- BIOS

- updating 48
- BIOS Setup utility 45
  - menus 47
  - navigating through 46
  - saving system configuration information 45
- boot menu
  - BIOS Setup utility 47

## C

- cabling
  - drives 22
  - providing space 9
- case
  - closing 17
  - opening 17
- CD/DVD drive 3
  - cabling information 22
  - eject button 3
  - installing 21
  - preparing to install 21
  - removing 21
  - replacing 21
  - troubleshooting 80
- checking system health with LANDesk 74
- conditioner
  - line 52
- configuration
  - jumper settings 49
- connecting system power 9
- connections
  - Ethernet 5
  - external audio 6
  - external microphone 6
  - external speakers 6
  - game 6
  - headphones 6
  - joystick 6
  - line in 6

- line out 6
- MIDI 6
- modem 6
- monitor (VGA) 5
- network 5
- parallel 5
- power 5
- PS/2 keyboard 5
- PS/2 mouse 5
- serial 5
- speaker out 6
- USB 3, 5

cover

- removing 17
- replacing 17

cover release lever 6

creating startup diskettes 75

## D

- deleting files and folders 64
- Disk Cleanup 64
- Disk Defragmenter 67
- diskette drive 3
  - cabling information 22
  - eject button 3
  - installing 21
  - preparing to install 21
  - removing 21
  - replacing 21
  - troubleshooting 84
- drive
  - cabling information 22
  - CD/DVD 3
  - diskette 3
  - preparing to install 21
  - replacing 3.5-inch 21
  - replacing CD/DVD 21
  - replacing diskette 21
  - replacing hard 21
  - supported types 21

## E

- electrostatic discharge (ESD) 15

- error messages 92
- Error-checking 65
- Ethernet jack 5
- exit menu
  - BIOS Setup utility 47
- expansion card
  - installing 30
  - removing 30
  - replacing 30
  - troubleshooting 88
- external audio jack 6

## F

- FAQ (frequently asked questions),
  - accessing vi
- features
  - back 4
  - front 2
- files
  - backing up 69
  - deleting 64
- fragmentation 67
- front bezel
  - removing 23
  - replacing 23
- front features 2

## G

- game port 6

## H

- hard drive
  - cabling information 22
  - checking for errors on 65
  - checking for free space 63
  - defragmenting 67
  - installing 21
  - preparing to install 21
  - removing 21
  - replacing 21
  - scanning for errors on 65
  - troubleshooting 85
- hardware management



- LANDesk Heceta IV 7
- Hibernate mode 3, 53, 58, 59
- humidity
  - protecting the computer 9

## I

- installing
  - 3.5-inch device 21
  - adapter card 30
  - add-in card 30
  - battery 42
  - bezel 23
  - case cover 17
  - CD/DVD drive 21
  - diskette drive 21
  - expansion card 30
  - hard drive 21
  - LANDesk Client Manager 74
  - main board 35
  - memory 37
  - power supply 33
  - system board 35
- interference
  - avoiding magnetic 9

## J

- jacks
  - Ethernet 5
  - external audio 6
  - external microphone 6
  - external speakers 6
  - headphones 6
  - line in 6
  - line out 6
  - modem 6
  - network 5
  - speaker out 6
- joystick port 6
- jumper
  - configuration 49
  - settings 49

## K

- keyboard
  - cleaning 72
  - port 5
  - troubleshooting 82

## L

- LANDesk Client Manager
  - installing 74
  - restoring 74
- line conditioners 52
- line in jack 6
- line out jack 6

## M

- magnetic fields
  - protecting your computer 9
- main board
  - installing 35
  - removing 35
  - replacing 35
- main menu
  - BIOS Setup utility 47
- maintenance
  - cleaning component exteriors 71
  - cleaning the case 71
  - cleaning the keyboard 72
  - cleaning the mouse 73
  - cleaning the screen 72
  - defragmenting 67
  - using Scheduled Task Wizard 70
- maintenance menu
  - BIOS Setup utility 47
- manual conventions v
- memory
  - installing RIMM 37
  - troubleshooting 86
- microphone jack 6
- MIDI port 6
- modem
  - jack 6
  - troubleshooting 87
- monitor

- adjusting 10
- port 5
- troubleshooting 90

mouse

- cleaning 73
- port 5
- troubleshooting 83

## N

- network jack 5
- Norton Antivirus 61

## O

- opening the case 17
- operating system
  - setting up 11

## P

- parallel port 5
- peripheral devices
  - troubleshooting 88
- ports
  - game 6
  - joystick 6
  - MIDI 6
  - monitor 5
  - parallel 5
  - PS/2 keyboard 5
  - PS/2 mouse 5
  - serial 5
  - USB 3, 5

- POST (power-on self-test) 11

- power
  - advanced settings 55, 57
  - BIOS Setup utility menu 47
  - button 3, 10, 12, 13
  - changing advanced settings 57
  - changing modes 54
  - changing schemes 55
  - changing settings 55
  - connecting 9
  - connector 5
  - Hibernate mode 53, 58

- LED 10
- line conditioners 52
- management 53
- schemes 55
- source problems 51
- Standby mode 53, 56
- surge suppressors 51
- uninterruptible power supply (UPS) 52
- power button 3, 54
- power supply
  - installing 33
  - removing 33
  - replacing 33
- printer
  - parallel port 5
  - troubleshooting 89
- protecting computer against power
  - source problems 51

## R

- recovery
  - system 75
- removing
  - 3.5-inch device 21
  - adapter card 30
  - add-in card 30
  - battery 42
  - case cover 17
  - CD/DVD drive 21
  - diskette drive 21
  - expansion card 30
  - files and folders 64
  - front bezel 23
  - hard drive 21
  - main board 35
  - power supply 33
  - system board 35
- replacing
  - 3.5-inch device 21
  - adapter card 30
  - add-in card 30
  - battery 42

- case cover 17
- CD/DVD drive 21
- diskette drive 21
- expansion card 30
- front bezel 23
- hard drive 21
- main board 35
- memory 37
- power supply 33
- system board 35
- resetting the computer 13
- restoring
  - LANDesk Client Manager 74
  - system 75
- Resume mode 3
- RIMM memory 37

**S**

- safety
  - battery warnings 42
  - general precautions 107
- saving system configuration settings 75
- ScanDisk 65
- Scheduled Tasks Wizard 70
- security menu
  - BIOS Setup utility 47
- serial port 5
- setting up
  - computer 9
  - operating system 11
  - safety precautions 107
  - Windows 11
- Setup utility
  - see BIOS Setup utility
- speakers jack 6
- Standby mode 3, 53, 56
- starting
  - computer 3, 10
- startup diskette
  - creating 75
- static electricity 15
- surge protector 51
- surge suppressors 51

- system board
  - configuration jumper 49
  - installing 35
  - removing 35
  - replacing 35
- system configuration
  - recording 75
- system recovery 75
- System Restoration CD 75

**T**

- temperature
  - protecting the computer 9
- troubleshooting
  - adapters 88
  - adjusting the monitor 10
  - battery 78
  - beep codes 94
  - CD/DVD drive 80
  - checklist 77
  - computer 82
  - diskette drive 84
  - error messages 92
  - frequently asked questions (FAQ) vi
  - guidelines 78
  - hard drive 84, 85
  - heat sources 9
  - humidity 9
  - keyboard 82
  - magnetic interference 9
  - memory 86
  - modem 87
  - monitor 90
  - mouse 83
  - overheating 9
  - peripherals 88
  - power connections 9
  - power source problems 51
  - printer 89
  - processor 86
  - video 90
- turning off computer 12

## U

- uninterruptible power supply (UPS) 52, 59
- updating the BIOS 48
- USB port 3, 5
- utility software
  - BIOS Setup utility 45

## V

- video
  - troubleshooting 90
- virus 61
  - protecting against 61
  - removing with Norton AntiVirus 61
- voltage selector switch 5

## W

- warning
  - battery 42
- Windows
  - resetting the computer 13
  - setup 11





MAN US E4650 SYS GDE R0 10/01



8508355