

845D-AV Mainboard

SOCKET 478 DDR ATX
Mainboard

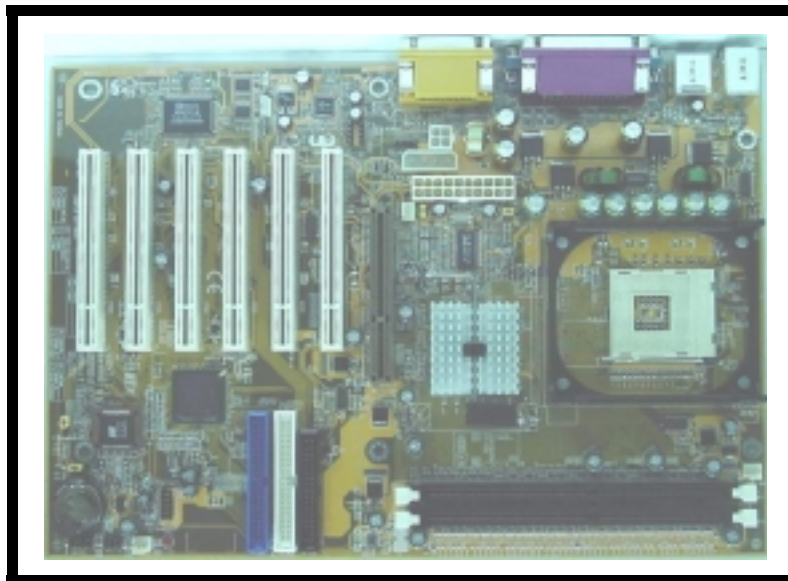

Version 3.0
UM-845DAV-E3
Rev 3.0V
Creation Date: 10 January 2003

User's Notice

Copyright

This publication contains information that is protected by copyright. No part of it may be reproduced in any form or by any means or used to make any transformation adaptation without prior written permission from the copyright holders. This publication is provided for informational purposes only. The manufacturer makes no representations or warranties with respect to the contents or use of this manual and specifically disclaims any express or implied warranties of merchantability or fitness for any particular purpose. The user will assume the entire risk of the use or the results of the use of this document. The manufacturer reserves the right to revise this publication and make changes to its contents at any time, without prior notice.
2001. All Rights Reserved.

Trademarks

Microsoft®, MS-DOS®, Windows™, Windows®95 and Windows®98 are registered trademarks of Microsoft Corporation. Intel® Pentium™ 4 is a registered trademark of Intel corporation. Phoenix Award is the registered trademark of Phoenix Award Software, Inc. Other trademarks and registered trademarks of products appearing in this publication are the properties of their respective holders.

Package Checklist

This package contains the following items:

- Mainboard
- Users manual
- One IDE cable
- One 34-pin floppy disk drive cable
- One Driver Utility CD

If any of these items are damaged or missing, please contact your dealer or sales representative for assistance.

Technical Support

If you require additional information or assistance during installation please contact your dealer. Your dealer will be able to provide the latest information.

Table Of Contents

Chapter 1:- Introduction *Page 5*

1.1. Mainboard and PC99 External Connector Layout	5
1.2. Overview	6
1.2.1. The 845D-AV Mainboard.....	6
1.2.2. Mainboard Dimensions.....	6
1.2.3. Environmental Limitations.....	6
1.3. Features and Specifications	6
1.4. System Health Monitor Functions	9
1.4.1. Hardware Monitoring System Utility.....	9
1.4.2. Installation.....	9
1.5. System Intelligence	9

Chapter 2:- Hardware Installation *Page 10*

2.1. Installation Checklist	10
2.2. Installation Steps	11
2.3. Expansion Slots, Jumpers and Internal Connectors	12
2.4. CPU, Memory and Expansion Slots	13
2.4.1. Installation of the CPU.....	13
2.4.2. Memory Modules	13
2.4.3. PCI Slots.....	14
2.4.4. AGP (Accelerated Graphics Port) Slot.....	14
2.5. Internal Connectors	15
2.5.1. Floppy Disk Connector (FDC)	15
2.5.2. Primary and Secondary IDE Connectors.....	15
2.5.3. CPU and Chassis Fan Connectors.....	15
2.5.4. ATX Power Supply Connectors	16
2.5.5. WOL (Wake-On-LAN) Connector	16
2.5.6. CD Audio-In/VIDEO-In/AUX-In Connectors	17
2.5.7. USB 3 and USB 4 Connectors	17
2.6. System Panel Buttons and LED Connectors	18
2.6.1. PW: Power On / Off and External Suspend Switch Connector	18
2.6.2. IDE HDD LED Connector	18
2.6.3. Reset Button Connector	18
2.7. Speaker and Power LED Connector	19
2.7.1. Speaker Connector	19
2.7.2. Front Panel Power LED	19

Table Of Contents

2.8. External Connectors	19
2.8.1. PS/2 Keyboard Connector	19
2.8.2. PS/2 Mouse Connector.....	19
2.8.3. COM 1 and COM 2 Connectors	19
2.8.4. Parallel Port Connector	20
2.8.5. USB 1 and USB 2 Connectors	20
2.8.6. Audio Game Port Connector	20
2.9. Jumper Settings	21
2.9.1. JP1: KB/MS PWR-ON	21
2.9.2. JP2: CPU FSB Clock Select	21
2.9.3. JP4: Clears CMOS Memory	22
2.9.4. JP5: Clear Password	22
2.9.5. JP6: Check AGP Card.....	22

Chapter 3:- Managing The PC BIOS *Page 23*

3.1. Phoenix-Award BIOS CMOS Setup Utility	23
3.2. Main Menu	23
3.3. Standard CMOS Setup	24
3.4. Advanced BIOS Features	26
3.5. Advanced Chipset Features	29
3.6. Integrated Peripherals	30
3.7. Power Management Setup	34
3.8. PNP/PCI Configuration	36
3.9. PC Health Status	37
3.10. Frequency/Voltage Control	38
3.11. Load Optimized Defaults	39
3.12. Set Supervisor Password	40
3.13. Set User Password	41
3.14. SAVE & EXIT SETUP/EXIT WITHOUT SAVING	42

Appendix A: AGP Card Identification *Page 43*

Introduction

Chapter 1 - Introduction

1.1. Mainboard And PC99 ATX External Connector Layout

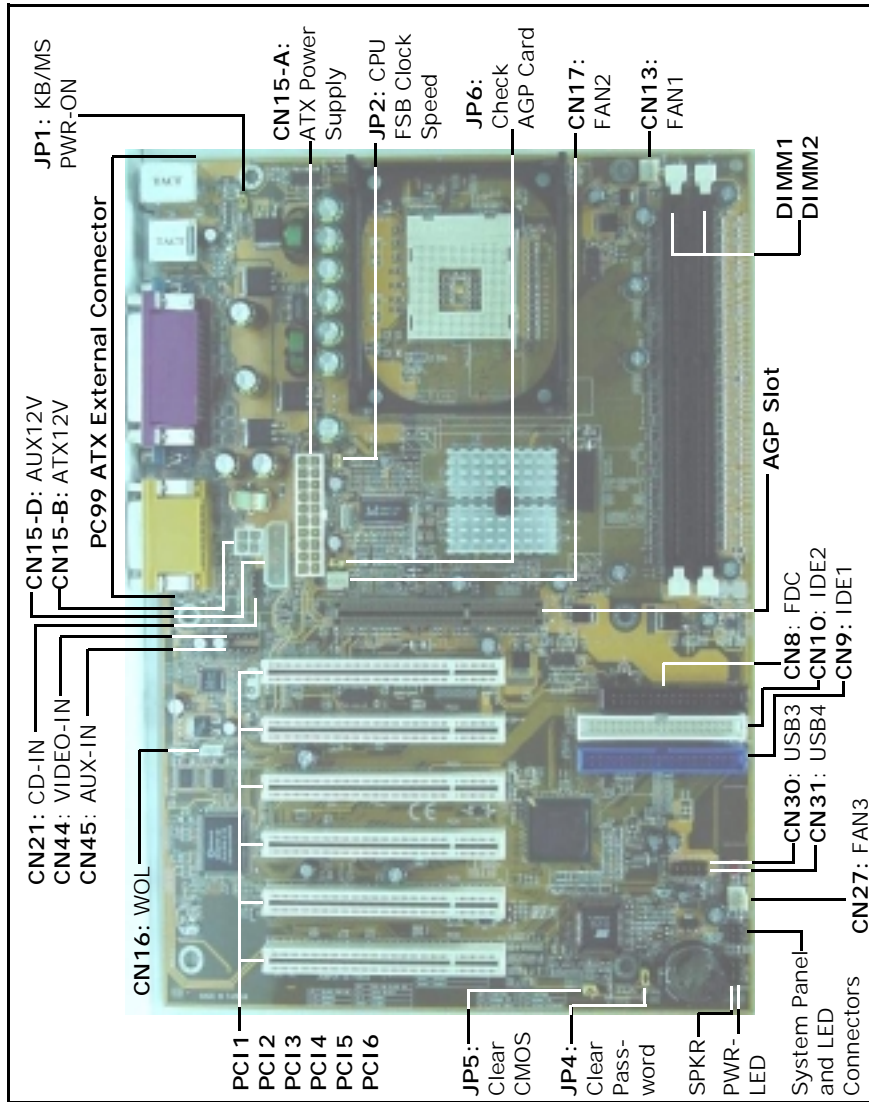

Introduction

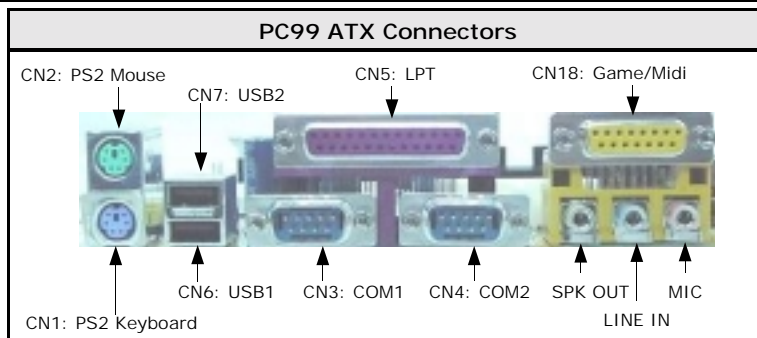

1.2. Overview

1.2.1. The 845D-AV Mainboard

The **845D-AV** mainboard is a Pentium™ 4 DDR platform. It supports a maximum memory of 2GB and comes with 4 USB ports. Onboard it has six PCI slots and a 1x/2x/4x AGP slot (which only supports **1.5V** AGP cards). The **845D-AV** mainboard also comes with three fan connectors (for additional thermal protection) and three power supply connectors. It also has a WOL (Wake-On-Lan) connector that enables it to be “woken up” from a soft-off power state when it receives a signal from the LAN. Other onboard connectors include Aux-IN, Video-IN and CD-IN connectors.

1.2.2. Mainboard Dimensions

Width	305 mm
Length	210 mm

1.2.3. Environmental Limitations

Operating Temperature:	10°C to 40°C (50°F to 104°F)
Required Airflow:	50 linear feet per minute across the CPU
Storage Temperature:	-40°C to 70°C (-40°F to 158°F)
Humidity:	0 to 90% non-condensing
Altitude:	0 to 10 000 feet

1.3. Features and Specifications

Processor

The **845D-AV** mainboard supports **Socket 478 Intel® Pentium™ 4** CPUs.

Chipset

Northbridge Core Chipset:	Intel® RG82845
Southbridge Core Chipset:	Intel® FW82801

I/O Chipset

Winbond W83627HF-AW

Introduction

CPU Switching Voltage regulator

This mainboard is equipped with a switching voltage regulator that automatically detects a DC power supply from +1.10V to +1.85V.

System Memory

The **845D-AV** mainboard uses Double Data Rate Dual Inline Memory Modules (DDR DIMM). Each mainboard has two 184-pin DIMM sockets. These sockets support 2.5V (power level) single-sided or double sided PC1600 (DDR200) or PC2100(DDR266) DDR DIMM modules. The maximum memory supported by these mainboards is 2 GB.

Note: The system memory supports 64MB, 128MB, 256MB and 512MB technologies for x8 and x16 devices. (Double Sided x16 devices are not supported)

Expansion Slots

These mainboards are equipped with six dedicated PCI slots and one (1.5V) 1x/2x/4x AGP slot.

Onboard Audio Features

Supports Microsoft DirectSound/ DirectSound 3D and AC97 Full Duplex.

Word Size

- Data Path: 8-bit, 16-bit, 32-bit, 64-bit
- Address Path: 32-bit

Front Side Bus Frequency (FSB)

Supports P4 Socket 478 CPU [533 or 400 MHz FSB(133 or 100 MHz QDR)].

BIOS

- Award BIOS, Windows 95/98 Plug and Play (PnP) compatible.
- Supports SCSI sequential boot-up.
- Flash EPROM for easy BIOS upgrades.
- Supports DMI 2.0 function

Desktop Management Interface (DMI)

The mainboard comes with DMI 2.0 built into the BIOS. The DMI utility in the BIOS will automatically record different information about your system configuration and store this information in the DMI pool, which is a part of the system board's Plug and Play BIOS. DMI, along with the appropriately networked software, is designed for easy inventory, maintenance and the simplified troubleshooting of computer systems.

WOL (Wake-On-LAN) Port

One WOL connector supports Wake-On-LAN functionality.

Introduction

USB Ports

USB allows data exchange between your computer and a wide range of simultaneously accessible external Plug and Play peripherals. The **845D-AV** mainboard is equipped with four USB connectors. USB 1 and USB 2 are external connectors. They can be found on the PC 99 ATX connector. The other USB connectors are internal connectors and can be used to connect other USB devices. (Cables for the internal connectors are sold separately).

***Note:** The internal USB connectors (CN30 and CN31) are non-standard. When you purchase the cable please ensure that the connector on one side of the cable is compatible with the internal USB connector and the connector on the other side of the cable is a standard USB connector.*

Connectors

- Two IDE connectors.
- One floppy drive interface supports up to two 2.88MB floppy drives.
- One 20-pin ATX power supply connector.
- One 4-pin (2x2) 12V ATX power supply connector
- One 4-pin (1x4) ATX Auxiliary power supply connector
- CPU and chassis fan connectors.
- One CD audio-IN connector.
- One Video-IN connector.
- One Aux-IN connector

ATX Double Deck Ports (PC 99 color-coded connectors)

- Two USB ports.
- Two external DB-9 serial port connector: **COM 1** and **COM 2** (UART).
- One SPP/ECP/EPP DB-25 parallel port.
- One mini-DIN-6 PS/2 mouse port.
- One mini-DIN-6 PS/2 keyboard port.
- One game/MIDI port.
- Three audio jacks: speak-out, line-in and mic-in.

PCI Bus Master IDE Controller

- Two PCI IDE interfaces support up to four IDE devices.
- The **845D-AV** mainboard supports ATA/33, ATA/66 and ATA/100 hard drives.
- PIO Mode 3 and Mode 4 Enhanced IDE (data transfer rate up to 16.6MB/sec.).
- Bus mastering reduces CPU utilization during disk transfer.
- Supports ATAPI CD-ROM, LS-120 and ZIP.

Introduction

1.4. System Health Monitor Functions

The mainboard is capable of monitoring the following health conditions of your system:

1. Processor temperature. It has an overheat alarm.
2. VCORE/3.3V/5V/12V/-12V voltages and failure alarm.
3. Processor and chassis fan speeds. It has a failure alarm for these fans.
4. Read back capability that displays temperature, voltage and fan speed.

1.4.1. Hardware Monitoring System Utility

The **845D-AV** mainboard comes with the Hardware Monitoring System utility contained on the CD. It is capable of monitoring the system's hardware conditions such as the temperature of the processor, voltage, and the speed of both the CPU and chassis fans. You are allowed to manually set a range to the items being monitored. If the values are over or under the set range a warning message will automatically pop up. We recommend that you use the Default Settings, which are the ideal settings that will maintain the system in a good working condition.

1.4.2. Installation

To install this utility, please insert the CD into the CD-ROM drive. The auto run screen (Driver Utility) will automatically appear. Click the Hardware Monitoring button, choose the chipset, model number and the OS that is installed. Please refer to the CD "Readme" file for further installation instructions.

Note: Only use this utility in Windows® 95 or Windows® 98 operating systems.

1.5. System Intelligence

Dual Function Power Button

Depending on the setting in the Soft-Off By Power-Button field of the Power Management Setup, this switch allows the system to enter the Soft-Off or Suspend mode.

RTC Timer to Power-on the System

The RTC installed on the system board allows your system to automatically power-on at a set date and time.

Wake-On-LAN Ready

The Wake-On-LAN function allows the network to remotely wake up a Soft Power Down (Soft-Off) PC. Your LAN card must support the remote wakeup function. The 5V SB power source of your power supply must be at least 720mA.

ACPI Ready

The mainboard is designed to meet the ACPI (Advanced Configuration and Power Interface) specification. ACPI has energy saving features that support OS Direct Power Management (OSPM) for round the clock PC operation.

Hardware Installation

Chapter 2 - Hardware Installation

2.1. Installation Checklist

The following is a checklist of all the expansion slots, jumpers and connectors that should be configured on your mainboard before you can run your pc.

Installation Checklist		
Expansion Slots and Sockets		
CPU Socket	Socket 478 Intel® Pentium™ 4 CPUs.	
DIMM Slots	Two 184 pin slots that supports up to 2GB of DDR SDRAM .	
PCI Slots	Six 32 bit PCI Slots.	
AGP Slot	One 1.5V Accelerated Graphics Port Slot	
Internal Connectors		
CN8	Floppy Disk Drive	FDC
CN9	Primary IDE	IDE1
CN10	Secondary IDE	IDE2
CN13	CPU Fan 1	Fan1
CN15-A	ATX Power Supply	ATX
CN15-B	ATX 12V Power Supply	ATX12V
CN15-D	Auxiliary ATX 12V Power Supply	Aux12V
CN16	Wake On Lan	WOL
CN17	Chassis Fan 2	FAN2
CN21	CD Audio In	CD-IN
CN27	Chassis Fan 3	FAN3
CN30	Universal Serial Bus 3	USB3
CN31	Universal Serial Bus 4	USB4
CN44	Video In	Video-IN
CN45	Auxiliary In	Aux-IN
External Connectors		
CN1	PS/2 Keyboard Connector	PS/2 KB
CN2	PS/2 Mouse Connector	PS/2 MS
CN3	Serial Port 1	COM1
CN4	Serial Port 2	COM2
CN5	Parallel Port	LPT
CN6	Universal Serial Port 1	USB1
CN7	Universal Serial Port 2	USB2
CN18	Game/Audio Port	Audio/Game

Hardware Installation

Installation Checklist (Continued)

System Panel Buttons and LED Connectors

PW	Power On/Off and Suspend Switch Connector.
HL	HDD LED Connector
RS	Reset Button Connector

Speaker and Power LED Connector

PWR-LED	Power LED
SPK	Speaker Connector

Jumpers and Switches

JP1	KB/MS Power On
JP2	CPU FSB Clock Select
JP4	Clear CMOS
JP5	Clear Password
JP6	Check AGP Card

2.2. Installation Steps

You need to complete the following installation steps before you can use your PC.

- Check and Set the Mainboard Settings.
- Install the Central Processing Unit (CPU).
- Install the Memory Modules.
- Install the Expansion Cards.
- Connect the Ribbon Cables, Panel Wires and the Power Supply.
- Setup the system BIOS

***Note:** Before you start installing your mainboard we strongly recommend that you use a grounded anti-static mat. We further recommend that you attach an anti-static wristband, which is grounded at the same location as the mat to your wrist.*

Hardware Installation

2.3. Expansion Slots, Jumpers and Internal Connectors

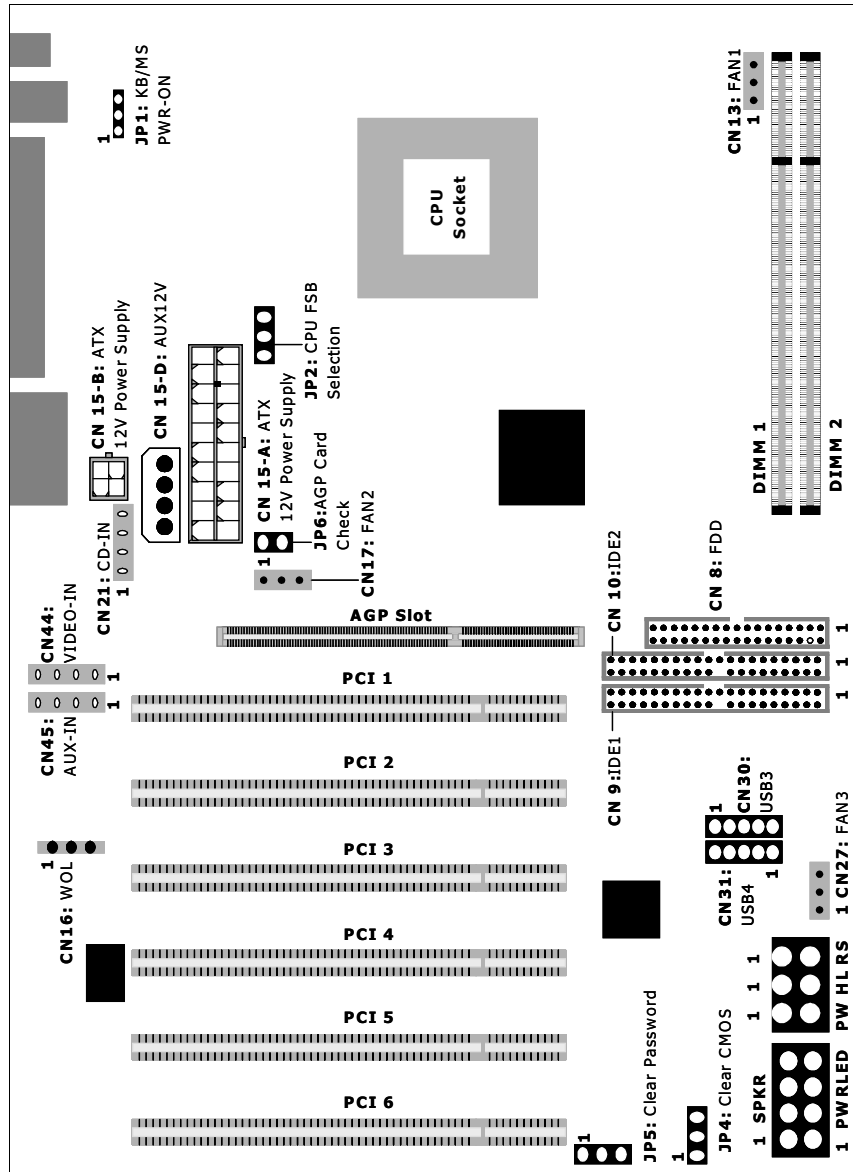

Hardware Installation

2.4. CPU, Memory and Expansion Slots

2.4.1. Installation of the CPU

To install your processor, please complete the following set of instructions

1. Locate a small dot marked on the top of the CPU. This mark indicates Pin 1 of the CPU.
2. Locate Pin 1 for the Socket on the mainboard.
3. There is a lever on the side of the socket. First push this lever side-ways and then lift it to a 90-degree angle.
4. Insert the CPU into the Socket. Please make sure that Pin 1 for the CPU is inserted into Pin 1 of the Socket.
5. When the CPU is installed correctly push the lever back into place.
6. **Install a proper heat sink with cooling fan** for proper heat dissipation. Failing to install a heat sink with cooling fan may cause overheating which will burnout your CPU and damage your mainboard.

IMPORTANT: CPU COOLING FAN

Please ensure that you have an approved heat sink with cooling fan. Without a proper heat sink with cooling fan you will damage both the mainboard and the CPU.

2.4.2. Memory Modules

The **845D-AV** mainboard has two 184-pin DDR DIMM slots and are able to support a maximum memory of 2 GB. The DDR DIMM slots are located on the right hand side of the board. To install the DIMM's into these slots, make sure the white lever at each side of the slot has been pulled down to an angle of approximately 45°. Make sure that the DIMM is in the correct orientation. Place the DIMM on the slot and push down firmly. The white levers will come back up and lock the module in place.

The system memory supports 64MB, 128MB, 256MB and 512MB technologies for x8 and x16 devices. (**Double Sided x16 devices are not supported**)

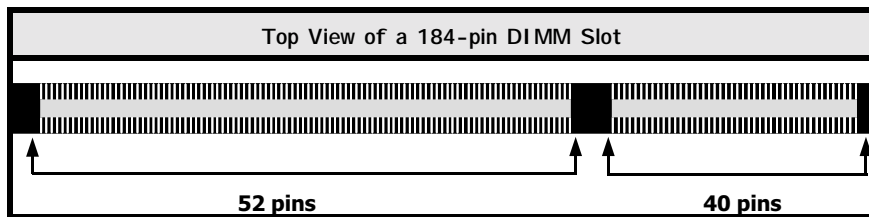

Important: The DIMM's can only be fitted into the slots in one orientation. Make sure that the DIMM's are in the correct orientation and the pins are correctly aligned before you insert them.

Hardware Installation

NOTE: "Out Of Memory" Error Message

If you have installed more than 512 MB of RAM and are running Microsoft Windows Millennium Edition, Windows 98 Second Edition, Windows 98 or Windows 95 you may experience memory problems. Two symptoms of these problems are being unable to run an MS-DOS session while you are running Windows or the computer may stop responding while Windows is starting.

There are three possible solutions to this problem:

- 1) Reduce the amount of memory Vcache uses to 512 MB or less by altering the Max-FileCache setting in the System.ini file.
- 2) Use the System Configuration Utility to reduce the amount of memory Windows uses to 512 MB or less.
- 3) Reduce the memory installed on your computer to 512 MB or less.

This problem can also occur if an Advanced Graphic Port (AGP) video adapter is used.

2.4.3. PCI Slots

The **845D-AV** mainboard comes with six PCI slots. They are located on the left hand side of the board. Both PCI and PCI expansion cards may require IRQ's. This mainboard complies with Plug and Play (PnP) specifications. Whenever a PnP compliant card is added the system will automatically be configured and the IRQ's will be assigned automatically.

When you are inserting your PCI card make sure that the pins are correctly aligned. When the pins are properly aligned with the hole's in the slot, push down gently.

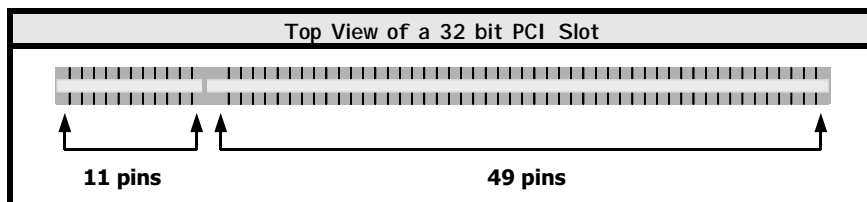

2.4.4. AGP (Accelerated Graphics Port) Slot

AGP is a dedicated bus slot. It operates at 66 MHz and transfers data at a rate up to 1066 MB/s. This allows 3D applications to run more smoothly. The **845D-AV** mainboard comes with a **1.5V** AGP slot. This slot is able to support 1x, 2x and 4x AGP cards.

Note: Only 1.5 volt AGP graphics cards are supported by the Intel® 845 chipset motherboards. If a 3.3 volt AGP card is used in an Intel® 845 chipset based motherboard there is a high probability of damaging the chipset, the mainboard and the CPU. (Please see Appendix A)

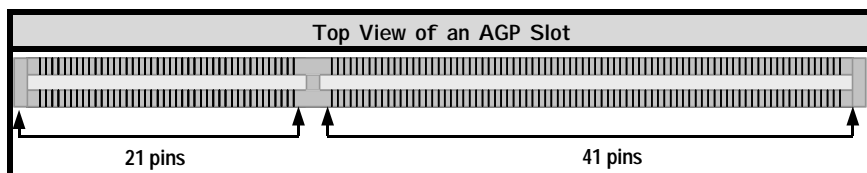

Hardware Installation

2.5. Internal Connectors

2.5.1. Floppy Disk Drive (FDD)

Connector: CN 8
Type: 34 pin block

The FDD connector can support two Floppy drives. It is located at the front of the mainboard. To connect, use the ribbon-cable that has been provided. **Make sure** that the red strip is connected to **PIN 1** of the connector.

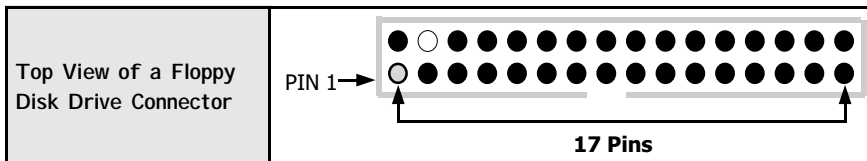

2.5.2. Primary and Secondary IDE connectors

Connector: CN 9 (primary)/ CN 10 (secondary)
Type: 40 pin blocks

The **845D-AV** mainboard all have two IDE connectors: a primary and secondary. Each IDE connector can support two IDE drives. These mainboards can therefore support up to four IDE devices each. If you install two hard drives, you need to configure the second drive to **slave** mode in the BIOS setup. Please refer to your hard drive manual for the appropriate jumper settings.

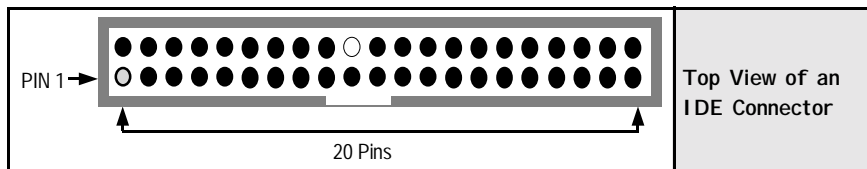

2.5.3. CPU Fan and Chassis Fan Connectors

Connector: CN13 (FAN1)/CN17 (FAN2)/CN27 (FAN3)
Type: 3 pin

The cooling fans must be connected to their respective power connectors. If you have installed the hardware-monitoring feature you will be able to monitor the rotating speed of the CPU cooling fan in your Windows operating system.

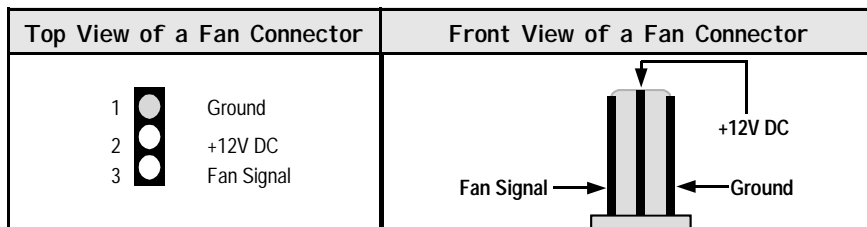

Hardware Installation

2.5.4. ATX Power Supply Connectors (CN15-D optional)

Connector: CN 15-A/ CN15-B/ CN15-D
Type: 2x10/2x2/1x4

The **845D-AV** mainboard comes with three onboard power supply connectors labeled CN15-A, CN15-B and CN15-D. CN15-A and CN15-B are regular ATX power supply connectors. The auxiliary power supply connector (CN15-D) is for a +12V and +5V power supply. These increased power supplies are necessary to provide extra power for the slot. The ATX 12V power supplies are all downward compatible with standard ATX power supplies.

ATX Power Supply Connector

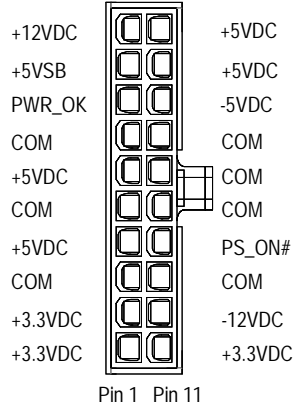

ATX12V Power Supply Connector

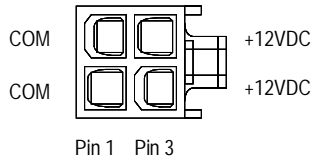

Auxiliary Power Supply Connector

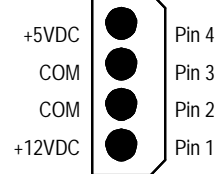

2.5.5. WOL (Wake On LAN) Connector

Connector: CN 16 (WOL)
Type: 3 pin

The **845D-AV** mainboard has a WOL (Wake-On-LAN) connector. This connector must be connected to a LAN card that has Wake-On-LAN (WOL) output. This connector powers up the system when a wakeup packet or signal is received through the LAN card.

In order to use the WOL LAN card to trigger the power on the PC system, the switching power supply must have the ability to provide a driving current of at least 720 mA and be connected to a "5V standby" voltage.

Top View of a WOL Connector



Front View of a WOL Connector

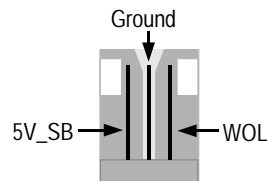

Hardware Installation

2.5.6. CD-IN/VIDEO-IN/AUX-IN Connector

Connector: CN 21 (CD-IN)/ CN 44 (VIDEO-IN) / CN 45 (AUX-IN)
Type: 4 pin un-housed

This **845D-AV** mainboard has one CD-IN connector, AUX-IN connector and VIDEO-IN connector. The **CD-IN** connector is used to connect the CD ROM audio out and allows the system to receive audio input from the CD ROM. The **AUX-IN** connector allows the system to receive signals from other audio devices like a radio or tape. The **VIDEO-IN** connector allows the system to receive signals from devices like TV tuners, Video machines and Video cameras.

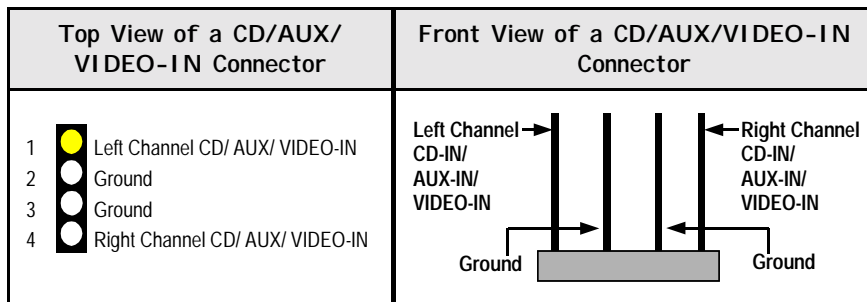

2.5.7. USB 3 and USB 4

Connector: CN 30 (USB 3)/CN 31 (USB 4)
Type: 5 pin

You already have two USB ports available, USB 1 and 2 (see external connectors). The internal USB connectors allow you to add on an optional kit to expand the total number of USB ports available. The **845D-AV** has two internal USB connectors (**CN30** and **CN31**). This enables you to use an extra two USB devices. Cable for these additional connectors needs to be purchased separately.

Note: These are not the standard USB connectors you find on the ATX PC99 connector. To connect USB devices you need to use an expansion cable (purchased separately) that ends in a standard USB connector. Ask your retailer for more details.

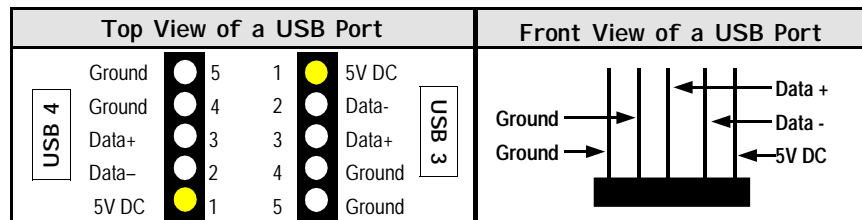

Hardware Installation

2.6. System Panel Buttons and LED Connectors

The following System Panel Buttons and LED Connectors (2 x 3 pins) can be found at the front of the mainboard on the left hand side.

PW = Power On/Off and Suspend Switch Connector
HL = HDD LED Connector
RS = Reset Button Connector

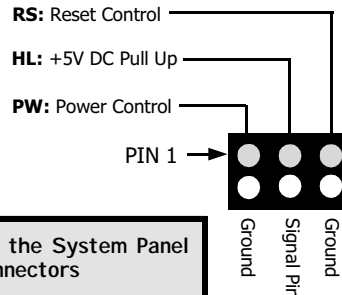

2.6.1. PW: Power On / Off and External Suspend Switch Connector

The Power On/Off connector has two functions. It can be the Power Switch or Suspend Switch of your PC system. You can either choose "**Delay 4 Sec**" or "**Instant OFF**" (Please refer to the BIOS setup instructions in Chapter 3).

Option 1: If you choose "**Delay 4 Sec.**" In the BIOS CMOS Setup, the function of "PW" will be:

- A. When the system power is "OFF", press this switch, the system will power on.
- B. When system power is "ON", you can select two different modes: -

Mode 1: Press and hold the Power ON button for less than 4 seconds and then release it. The system will be turned into Suspend mode (turned into the GREEN mode) When the system is in the Suspend mode: -

- Press the Power on button (less than 4 seconds), the system will return to Full-ON mode.
- Press and hold the Power On Button for more than 4 seconds, the system will be powered off.

Mode 2: Press and hold the Power ON button for more than 4 seconds, the system will be completely powered off.

Option 2: If you choose "**Instant OFF.**" In the BIOS CMOS Setup, the power switch will operate like a normal ON / OFF Power button.

2.6.2. HL: HDD LED Connector

Any read and write activity by the HDD will turn this LED on.

2.6.3. RS: Reset Button Connector

If you connect this connector, you will be able to reset you computer by pressing the reset button at the front of the chassis.

Hardware Installation

2.7. Speaker and Power LED Connectors

2.7.1. Speaker Connector

Connect your chassis speaker to this four pin connector. It allows you to hear systems beeps and warnings sound.

2.7.2. Front Panel Power LED

The chassis Power LED connector can be connected to the four pin connector. When you turn your system on, this LED will also be turned on.

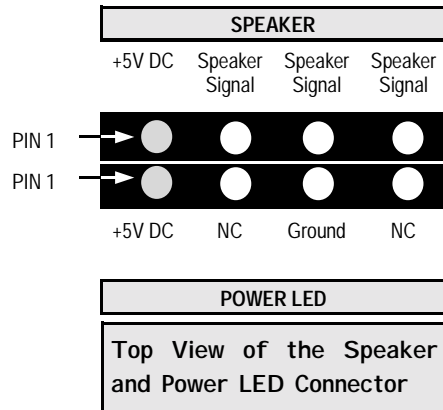

2.8. External Connectors

2.8.1. PS/2 Keyboard connector.

Connector: CN 1
Type: 6 pin female



This connector only supports a PS/2 keyboard plug. If you have a standard AT size (large DIN) keyboard plug, you need to use a mini DIN adapter.

2.8.2. PS/2 Mouse Connector.

Connector: CN 2
Type: 6 pin female



This connector only supports a PS/2 mouse plug. If a PS/2 mouse is detected then IRQ 12 will be directed to CN 2.

2.8.3. Serial Port 1 (COM 1) and Serial Port 2 (COM 2)

Connector: CN 3 (COM 1)
Type: 9 pin male

One serial port is available for a mouse and other serial devices. (I/O addresses used are 3F8H/2F8H/3E8H/2E8H and IRQ3/IRQ4, selected by CMOS setup.)

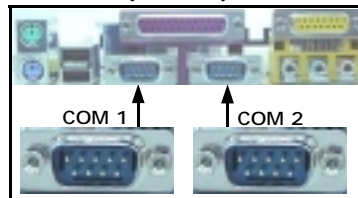

Hardware Installation

2.8.4. Parallel Port Connector (LPT)

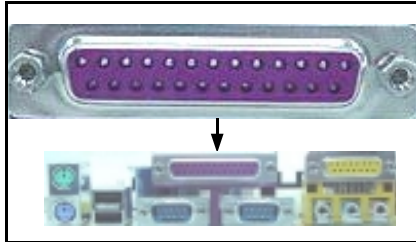

Connector: CN 5
Type: 25 pin female.

This parallel port is used by printers which support the SPP, EPP and ECP modes IRQ7 or IRQ5 can be selected. The ECP mode will use either DMA 3 or DMA 1 (which can be selected by the BIOS setup program).

2.8.5. Universal Serial Bus (USB) Port 1 & 2

Connector: CN 6 (USB 1)/ CN 7 (USB 2)
Type: 4 pin female

Two USB ports are available for connecting USB devices. The mainboard is also equipped with an expansion connector that supports two additional USB external connectors. (The USB cable is not included with the mainboard).

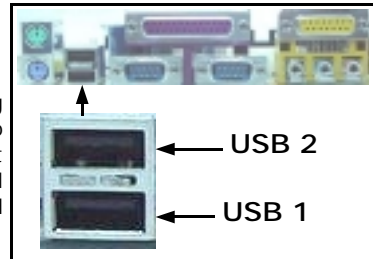

2.8.6. Audio/Game Port Connector

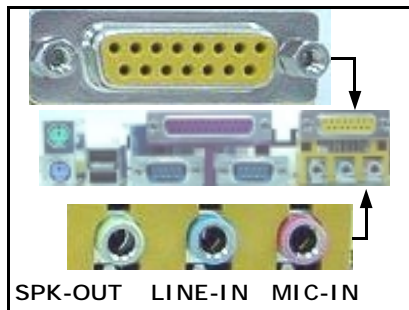





Connector: CN 18
Type: 15 pin female

The Game/MIDI port connector is a dual purpose connector. It can either be used to connect a joystick to the computer for game participation, or it can be used to attach an external MIDI device. All these motherboards have 3D audio interfaces onboard.

Hardware Installation

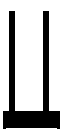
2.9. Jumper Settings

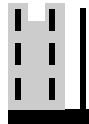
Jumpers are built on the mainboard to allow the user flexibility to configure the mainboard settings to meet their specific requirements. When there is no jumper cap inserted into the jumper it is called "OPEN." When a cap is inserted into the jumper it is known as a "SHORT." Below is an example of a short setting on a jumper.

Two Pin Jumpers		Three Pin Jumpers		
		<div style="display: flex; justify-content: space-around;"> <div style="text-align: center;"> PIN: 1 2 3  </div> <div style="text-align: center;"> PIN: 1 2 3  </div> </div>		
Open	Short	SHORT	PIN 1/PIN 2	PIN2/PIN 3

2.9.1. JP1: Keyboard/Mouse Power On

Type: 3 pin
 Default: Pin 1 and Pin 2 Short

This jumper allows you to Power On your system using your mouse or keyboard. If you short Pin 1 and Pin 2 then the "Keyboard/Mouse Power On" function will be disabled. If Pin 2 and Pin 3 are short then the "Keyboard/Mouse Power On" function will be enabled. If you choose to enable this option then you need to enable the **POWER ON** field in the **Integrated Peripherals** Menu of the BIOS setup.

2.9.2. JP2: CPU FSB Clock Selection

Type: 3 pin
 Default: Pin 1 and Pin 2 short

This jumper allows you to select the CPU FSB Clock speed. If Pin 1 and Pin 2 are left in the default settings (pin 1 and pin 2 short) then the mainboard will automatically detect the FSB Clock speed. If Pin 2 and Pin 3 are short then the FSB will be forced to be 400 MHz. If all the pins are left open then the FSB will be forced to be 533MHz.

Pins	Frequency
Pin 1 and Pin 2 Short	Auto Detect FSB Clock Speed
Pin 2 and Pin 3 Short	400MHz
OPEN	533MHZ

Hardware Installation

2.9.3. JP4: Clear CMOS

Type: 3 pin
Default: Pin 1 and Pin 2 short

If you have made an improper setting in the BIOS setup and your computer is not functioning, or if you have forgotten your password, you can use this jumper, JP4, to clear the CMOS and to reconfigure your system. page:

To clear the CMOS, please follow these instructions:

1. Turn the system power "OFF" and unplug your computer.
2. Insert the jumper cap on Pin 2 and Pin 3 for 3 ~ 5 seconds.
3. Pull out the jumper cap and replace it on Pin 1 and Pin 2.
4. Turn your PC on and run the BIOS setup program.

2.9.4. JP5: Clear Password

Type: 3 pin
Default: 1 and 2 short

If you forget your keyboard power-on password you can use JP5 to clear it from the I/O chip (where it is stored). To do this you must:

To clear the Keyboard power-on password, please follow these instructions:

1. Turn the system power "OFF" and unplug your computer.
2. Insert the jumper cap on Pin 2 and Pin 3 for 3 ~ 5 seconds.
3. Pull out the jumper cap and replace it on Pin 1 and Pin 2.
4. Turn your PC on and run the BIOS setup program.

2.9.5. JP6: Check AGP Card

Type: 2 pin
Default: short

This jumper can be used to check if your AGP card is 1.5V or 3.3V. If you **short** this jumper then the system will check to see what type of AGP card you are using. If a 3.3V card is detected your system will not boot. **Note:** The jumper must be made **short** after the AGP card has been inserted into the slot. If this jumper remains **open** the system will boot with both a 1.5V and 3.3V AGP card. **Note:** if you are using a 3.3V AGP card you can damage your system.

Managing The PC BIOS

Chapter 3 - Managing the PC BIOS

3.1. Phoenix-Award BIOS CMOS Setup Utility

Once you have installed the mainboard you still need to setup the BIOS before you can run your PC. The EEPROM on the mainboard stores the AWARD BIOS CMOS Setup Utility, which allows you to configure your system. When you want to configure or make any changes to the configuration of your system BIOS you must run the BIOS CMOS Setup Utility.

GETTING STARTED

Every time you start your computer, the system provides you with an opportunity to run the BIOS CMOS Setup Utility. As soon as you turn on your system, press the <Delete> button to activate the BIOS CMOS Setup Utility.

If your computer finishes the POST (Power-On-Self-Test) the BIOS CMOS Setup Utility will **not be** activated. If your computer completes the POST you need to restart the system to activate the BIOS CMOS Setup Utility. To restart the system, you can either turn the power off, press the reset button on your chassis or press the <Ctrl> + <Alt> + <Delete> button. In all three cases the system will restart and, to activate the BIOS CMOS Setup Utility, you must immediately press the <Delete> button.

3.2. Main Menu

Once you have called up the BIOS CMOS Setup Utility, the following screen will appear:

Phoenix - AwardBIOS CMOS Setup Utility	
<ul style="list-style-type: none">▶ Standard CMOS Features▶ Advanced BIOS Features▶ Advanced Chipset Features▶ Integrated Peripherals▶ Power Management Setup▶ PNP/PCI Configuration▶ PC Health Status	<ul style="list-style-type: none">▶ Frequency/Voltage ControlLoad Optimized DefaultsSet Supervisor PasswordSet User PasswordSave & Exit SetupExit Without Saving
Esc : Quit F9 : Menu in BIOS ← ↑ ↓ → : Select Item	
F10 : Save and Exit Setup	
Time, Date, Hard Disk Type ...	

Note: BIOS software is continuously updated therefore the BIOS menus and the descriptions that are given in this manual are for reference purposes only.

Managing The PC BIOS

Navigation Keys

You will notice a legend bar at the bottom of the main menu. The keys in this legend bar show you how to navigate through the setup menus. The table below lists the control keys with their corresponding functions: -

Control Key	Function
Up Arrow	Moves to the previous item.
Down Arrow	Moves to the next item.
Left Arrow	Moves to the item on the left.
Right Arrow	Moves to the item on the right.
Enter	Selects the desired item.
F1	Displays the help screen for the selected feature.
Esc key	Exits to the previous screen.
PgUp(-)/PgDn(+)	Modifies or changes the content of the highlighted item.
F5	Restores the previous CMOS values to the current page setup. This will not restore the previous values for any other pages.
F7	Loads the SETUP default values from BIOS default table, (only the current page setup will be loaded).
F10	Saves changes to the CMOS and exits the setup.

3.3. Standard CMOS Setup (*This menu is on next page*)

Date (mm : dd : yy)

Sets your system to the date that you specify (usually the current date). The format is month, day, and year. Press the right or left arrow key to move to the desired field (month, date, year). Press the PgUp or PgDn key to increment the setting, or type the desired value into the field.

Time (hh : mm : ss)

Sets your system to the time you specify (usually the current time). The format is hour, minute, second. The time format is based on the 24-hour military-time clock. For example, 1 p.m. is 13:00:00. Press the right or left arrow key to move to the desired field. Press the PgUp or PgDn key to increment the setting, or type the desired value into the field.

IDE Primary / Secondary Master / Slave

This mainboard supports four IDE Hard Drives. These fields allow you to set your Hard Drive parameters. Move the selection bar to the IDE Hard Drive you want to configure. Press the "ENTER" key. If you select "AUTO" the system BIOS will detect the HDD type automatically.

Managing The PC BIOS

Phoenix - AwardBIOS CMOS Setup Utility Standard CMOS Features

Date (mm : dd : yy)	Thu, January 9, 2003	Item Help
Time (hh : mm : ss)	11 : 19 : 52	
▶ IDE Primary Master	[QUANTUM FIREBALL PKA]	Menu Level ▶ Change the day, month, year and century
▶ IDE Primary Slave	[Pioneer DID-ROM ATAPI]	
▶ IDE Secondary Master	[None]	
▶ IDE Secondary Slave	[None]	
Drive A	[1.44, 3.5 in]	
Drive B	[None]	
Floppy 3 mode support	[Disabled]	
Video	[EGA/VGA]	
Halt On	[All Errors]	
Base Memory	640K	
Extended Memory	261124K	
Total Memory	261124K	

Drive A / B

The **845D-AV** mainboard can support up to two floppy disk drives. These two selection fields allow you to select the floppy drives that are installed on your computer. Select the correct specifications for the diskette drive(s) installed on your computer.

Diskette Drive	Type of Disk Drive	Capacity
None	No diskette drive installed	
360K 5.25 in	5-1/4 inch PC-type standard drive	360 KB
1.2M 5.25 in	5-1/4 inch AT-type high-density drive	1.2 MB
720K 3.5 in	3-1/2 inch single-sided drive	720 KB
1.44M 3.5 in	3-1/2 inch double-sided drive	1.44 MB
2.88M 3.5 in	3-1/2 inch double-sided drive	2.88 MB

Floppy 3 Mode Support

If you have installed a 3.5 inch high capacity floppy disk drive you need to enable this option. If you have not installed one of these drives use the default setting.

Video

This field selects the type of primary video subsystem that is on your computer. The BIOS CMOS Setup Utility will automatically detect the correct video type (see the next page for detailed options).

Managing The PC BIOS

Monitors	
EGA/VGA	Enhanced Graphics Adapter/Video Graphics Array. For EGA, VGA , SEGA, SVGA or VGA monitor adapters
CGA 40	Color Graphics Adapter power up in 40 column mode
CGA 80	Color Graphics Adapter power up in 80 column mode
MONO	Monochrome adapter includes high resolution monochrome adapters

Halt On

This field allows you to decide which errors, detected during the Power On Self Test (POST), will halt the system.

Base Memory / Extended Memory / Total Memory

This field displays the amount of memory detected by the system during boot up. This is a display only field. You cannot make any changes to this field.

Base Memory: Indicates the memory installed below the conventional 1MB space.

Extended Memory: Indicates the memory installed above the 1MB space.

Total Memory: Indicates the total memory installed in the PC system.

3.4. Advanced BIOS Features (*This menu is on next page*)

Virus Warning

When you enable the virus warning you will receive a warning message whenever a program (specifically, a virus) attempts to write to the boot sector or the partition table of the hard disk drive. If you receive such a message you should immediately run an anti-virus program. Keep in mind that this feature **only** protects the boot sector and not the entire hard drive.

Note: Disk diagnostic programs that access the boot sector table can trigger the virus-warning message. If you run such a program, recommend that you first disable the virus warning.

CPU L1 & L2 Cache Internal Cache / External Cache

This BIOS setting can be used to enable or disable the CPU's L1 (primary) and L2 (secondary) cache.

Quick Power On Self Test

If enabled the amount of time required to run the power-on self-test (POST) will decrease. A quick POST skips certain steps. We recommend that you disable quick POST. It is better to find a problem during POST than to lose data during your work.

Managing The PC BIOS

Phoenix - AwardBIOS CMOS Setup Utility Advanced BIOS Features

		Item Help
Virus Warning	[Disabled]	Menu Level ▶ Allows you to choose the VIRUS warning feature for IDE Hard disk boot sector protection. If this function is enabled and someone attempts to write data into this area, BIOS will show a warning message on screen and alarm beep.
CPU L1 & L2 Cache	[Enabled]	
Quick Power On Self Test	[Enabled]	
First Boot Device	[Floppy]	
Second Boot Device	[HDD-0]	
Third Boot Device	[LS120]	
Boot Other Device	[Enabled]	
Swap Floppy Drive	[Disabled]	
Boot Up Floppy Seek	[Enabled]	
Boot Up NumLock Status	[On]	
Gate A20 Option	[Fast]	
Typematic Rate Setting	[Disabled]	
X Typematic Rate (Chars/Sec)	6	
X Typematic Delay (Msec)	250	
Security Option	[Setup]	
OS Select For DRAM > 64 MB	[Non-OS2]	
HDD S.M.A.R.T. Capability	[Disabled]	
Report No FDD For WIN 95	[No]	

First / Second / Third Boot Device

These fields allow you to decide the boot sequence of your bootable devices such as Floppy Drive, Hard Drive, CD ROM...etc

Boot Other Device

When this field is enabled you will be able Boot your computer from a another device, not your HDD or FDD.

Swap Floppy Drive

This field is effective only in systems with two floppy drives. When Enabled is selected physical drive B is assigned to logical drive A, and physical drive A is assigned to logical drive B.

Boot Up Floppy Seek

When enabled, the BIOS tests (seeks) floppy drives to determine whether they have 40 or 80 tracks. Only 360-KB floppy drives have 40 tracks; drives with 720 KB, 1.2 MB, and 1.44 MB capacity all have 80 tracks. Very few modern PCs have 40-track floppy drives so we therefore recommend that you set this field to Disabled to save time.

Boot Up NumLock Status

This controls the state of the NumLock key when the system boots. This field is toggled between On or Off. When it is on the numeric keypad generates numbers instead of controlling the cursor operations. When it is off the numeric keypad controls cursor operations and does not generate numbers.

Managing The PC BIOS

Gate A20 Option

Gate A20 is a signal that gives the system access to addresses higher than A19. If you select Fast the chipset will control this signal. If you select normal a pin in the keyboard controller will control the signal.

Typematic Rate Setting

The keyboard controller determines the rate at which the keystrokes from the keyboard are repeated. If you enable this option then the typematic rate and the typematic delay can be selected.

Typematic Rate

This is the rate a character will repeat itself on the screen when you hold down a key.

Typematic Delay

This is the delay time (Msec) before the repetition of characters starts.

Security Option

This field allows you to select the "Setup" or "System" security option. It works concurrently with the "Set Supervisor Password" in the main menu.

When the "Setup" option is selected, you will be prompted to enter your "Password" before you can start the BIOS CMOS Setup Utility. When you select "System" option, you will be prompted to enter your password in order to load the Operating System.

***TIP:** Forgot your password then clear the RTC RAM
If you happen to forget your password you can use Jumper 5 (JP5) to clear the password by erasing the CMOS Real Time Clock (RTC) Ram. Please see section 2.9.4. on page 22.*

OS Select For DRAM > 64MB

Only select OS2 if you are running an OS/2 operating system with a RAM greater than 64 Mb. Otherwise, for all other operating systems, use the default setting "Non-OS2".

HDD S.M.A.R.T Capability

You may "enable" this option if your Hard Drive supports the S.M.A.R.T. technology (Self Monitoring Analysis Reporting Technology) feature. S.M.A.R.T. will monitor and report your Hard Drive health status. Ask your Hard Drive Vendor for further information.

***Note :** Using this feature may decrease system performance*

Report No FDD For WIN95

If you are not using a floppy disk this option allows you to release IRQ6. To do this set this option to Yes. You should then also disable the onboard FDC Controller in the Integrated Peripherals Screen.

Managing The PC BIOS

3.5. Advanced Chipset Features

Phoenix - AwardBIOS CMOS Setup Utility Advanced Chipset Features

DRAM Timing Selectable	[By SPD]	Item Help
CAS Latency Time	[3]	Menu Level ▶
Active to Precharge Delay	[6]	
DRAM RAS# to CAS# Delay	[3]	
DRAM RAS# Precharge	[3]	
DRAM Data Integrity Mode	[Non-ECC]	
Memory Frequency For	[Auto]	
DRAM Read Thermal Mgmt	[Disabled]	
System BIOS Cacheable	[Enabled]	
Video BIOS Cacheable	[Disabled]	
Video RAM Cacheable	[Disabled]	
AGP Aperture Size (MB)	[64]	
Delay Prior to Thermal	[16 Min]	

DRAM Timing Selectable

This field determines the DRAM read/write timing. The performance parameters of the memory chips (DRAM) you have installed will determine the value in this field. Do not change the value from the factory setting unless you install new memory that has a different performance rating than the original DRAMs.

CAS Latency Time

The time delay (in clock cycles, CLKS) that passes before the SDRAM starts to carry out a read command after it has been received. The number of CLKS that occur before the first part of a burst transfer is completed is also determined by this field.

DRAM RAS# to CAS# Delay

When the DRAM is refreshed, both rows and columns are addressed separately. This setup allows you to determine the timing of the transition from Row Address Strobe (RAS) to Column Address Strobe (CAS).

DRAM RAS# Precharge Time

If the DRAM is not continually refreshed its data will be lost. DRAM is normally refreshed as a result of a single request. This field lets you select the number of CLKS allocate for the RAS to accumulate its charge before the DRAM is refreshed. If there is not sufficient time then the refresh may be incomplete and some of the data can be lost.

DRAM Data Integrity Mode

Error Checking and Correction (ECC) should only be used in conjunction with a special 72-bit ECC RAM. If you are using ECC RAM you should select **ECC**. This feature will enable the system to detect and correct single-bit errors and detect (not correct) double-bit errors. If you do not have ECC RAM then select **Non-ECC** (the default mode).

Managing The PC BIOS

Memory Frequency For

This field allows you to manually select the frequency of the memory modules you are using. This mainboard supports both DDR200 and DDR266 modules. If you run the FSB at 533MHz the only default option for this field is DDR266, or if the FSB is at 400MHz the option for this field can be AUTO, DDR266 or DDR200. If you do not know what the frequency of your memory modules is then select auto and the system will automatically decide.

System BIOS \ Video BIOS \ Video RAM Cacheable

These fields enable (disable) the caching of the **System BIOS**, the **Video BIOS** and the **Video RAM**. The **System BIOS** is cached at F0000h-FFFFh, the **Video BIOS** is cached at C0000h-C7FFFh, and the **Video RAM** is cached at A0000h-AFFFFh. All three are cached via the L2 cache. If these options are enabled, access to the system BIOS may speed up **BUT** if any other program tries to write to the memory locations specified above then the system will crash. We recommend that you disable these options. **Note** The System/Video BIOS can only be cached when the System BIOS/Video BIOS has been shadowed.

AGP Aperture Size

This field selects the size of the Accelerated Graphics Port (AGP) aperture. The aperture is a portion of the PCI memory address range dedicated for graphics memory address space. Host cycles that hit the aperture range are forwarded to the AGP without any translation. The default is 64MB. You may increase this memory when you need to have faster access for 3D graphics applications (e.g. games).

3.6. Integrated Peripherals (*This menu is on next page*)

On-Chip Primary PCI IDE/On-Chip Secondary PCI IDE

These two options (option 1 and option 6) allow you to enable or disable the onboard IDE Interface.

Primary/Secondary, Master/Slave PIO

The four IDE PIO (Programmed Input/Output) fields let you set a PIO mode (0-4) for each of the four IDE devices that the onboard IDE interface supports. Modes 0 through 4 provide successively increased performance. In Auto mode, the system automatically determines the best mode for each device.

Primary/Secondary, Master/Slave UDMA

Ultra DMA/66 implementation is possible only if your IDE hard drive supports it and the operating environment includes a DMA driver (Windows 98 OSR2 or a third-party IDE bus master driver). If your hard drive and your system software both support Ultra DMA/66, select Auto to enable BIOS support.

USB Controller

This field allows you to enable or disable the onboard USB Controller.

Managing The PC BIOS

Phoenix - AwardBIOS CMOS Setup Utility Integrated Peripherals

		Item Help
On-Chip Primary PCI IDE	[Enabled]	Menu Level ▶
IDE Primary Master PIO	[Auto]	
IDE Primary Slave PIO	[Auto]	
IDE Primary Master UDMA	[Auto]	
IDE Primary Slave UDMA	[Auto]	
On-Chip Secondary PCI IDE	[Enabled]	
IDE Secondary Master PIO	[Auto]	
IDE Secondary Slave PIO	[Auto]	
IDE Secondary Master UDMA	[Auto]	
IDE Secondary Slave UDMA	[Auto]	
USB Controller	[Enabled]	
USB Keyboard Support	[Disabled]	
AC97 Audio	[Auto]	
Init Display First	[AGP]	
IDE HDD Block Mode	[Enabled]	
POWER ON Function	[BUTTON ONLY]	
KB Power ON Password	[ENTER]	
Hot Key Power ON	[Ctrl-F1]	
Onboard FDC Controller	[Enabled]	
Onboard Serial Port 1	[3F8/IRQ4]	
Onboard Serial Port 2	[2F8/IRQ3]	
UART Mode Select	[Normal]	
RxD, TxD Active	[Hi,Lo]	
IRA Transmission Delay	[Enabled]	
UR2 Duplex Mode	[Half]	
Use IR Pins	RxD2, TxD2	
Onboard Parallel Port	[378/IRQ7]	
Parallel Port Mode	[SPP]	
EPP Mode Select	[EPP1.7]	
ECP Mode Use DMA	[3]	
PWRON After PWR Fail	[Off]	
Game Port Address	[201]	
Midi Port Address	[330]	
Midi Port IRQ	[10]	

USB Keyboard Support

If you are using an older (legacy) operating system (such as MS-DOS) and you're installing a USB keyboard you must **enable** this Field. For PnP O/S like Windows 98, Windows 2000, Windows ME etc you should retain the default setting.

AC97 Audio

If you want to enable the on-chip audio capabilities of your system you need use the default setting "Auto". If you install an add on sound card you must disable this field.

Init Display First

When both an AGP and PCI VGA card are installed on a mainboard, this field can be used to determine the display loading priority during System Startup.

Managing The PC BIOS

IDE HDD Block Mode

Block Mode is also called Block Transfer, Multiple Commands, or Multiple Sector Read/Write. If your IDE hard drive supports Block Mode (most new drives do) then this field should be enabled. If this field is enabled then the optimal number of block read/writes per sector the drive can support will be determined automatically.

POWER ON Function

The POWER ON Function allows you to select different ways to power on your PC System.

KB Power ON Password

When you select KB Power ON Password to power ON the PC system in the previous field, you may enter your personal password into this field. When you are finished, you may use the password to power on your PC system. If you forget your password refer to **section 2.9.5**.

Hot Key Power On

When you select Hot Key Power On to Power ON the PC System in the previous selection field, you may select a set of "Hot Key" in this field. When finished you may use the hot key combination to power on your PC System.

Onboard FDC Controller

Select Enabled if your system has a floppy disk controller (FDC) installed on the system board and you want to use it. If you install an add-in FDC or the system has no floppy drive, select Disabled in this field.

Onboard Serial Port 1/Port 2

These two selection fields allow you to select the I/O address and corresponding interrupts for the first and second serial ports.

UART Mode Select

Your system may offer a variety of infrared modes on the second serial port. The options are Standard, HPSIR or ASKIR.

RxD, TxD Active

This field allows you to set the IR reception/transmission polarity as high or low. To determine which polarity is appropriate you must refer to the documentation for your IR peripheral.

This field is usually found under the Onboard Serial Port 2 option. If you disable the Onboard Serial Port 2 option then you will probably not be able to configure this field.

IR Transmission Delay

This field allows you to "Enable" or "Disable" the IR Transmission Delay.

UR2 Duplex Mode

This Field allows you to select the IR half or full duplex function.

Managing The PC BIOS

Use IR Pins

To determine the correct settings for the TxD and RxD signals of your IR peripheral component, you need to consult the components manual.

Onboard Parallel Port

This item allows you to determine the I/O address and the IRQ for the onboard parallel port. The default settings are adequate and should not give you any problems. If they do you can try to change them.

Parallel Port Mode

This field allows you to select an operating mode for the onboard parallel (printer) port. Select Normal, Compatible, or SPP unless you are certain your hardware and software both support one of the other available modes.

EPP Mode Select

This field allows you to choose the EPP version you want to use. We recommend that you use EPP 1.9 for the best performance but if you do you may have some connection problems so try setting it to EPP 1.7.

ECP Mode Use DMA

This item allows you to select a DMA channel for the parallel port for use during ECP.

PWRON After PWR Fail

See the following table for all the options.

Off:	When the power returns after an AC power failure the system's power is off. You must press the Power button to power-on the system
On:	When the power returns after an AC power failure, the system will automatically power-on.
Former-Sts:	When power returns after an AC power failure, the system will return to the state where you left off before the power failure occurred. If the system's power is off when the AC power failure occurred, it will remain off when the power returns. If the system's power is on when the AC power failure occurred, the system will power-on when the power returns.

Game Port Address

This field allows you to select the I/O address for the onboard game port. Default is 201.

Midi Port Address

This field allows you to select the I/O address for the onboard MIDI port. Default is 330.

Midi Port IRQ

This field allows you to select the IRQ for the onboard MIDI port. Default is 10.

Managing The PC BIOS

3.7. Power Management Setup

Phoenix - AwardBIOS CMOS Setup Utility Power Management Setup			
ACPI Function	[Enabled]	Item Help	
ACPI Suspend Type	[S1(POS)]	Menu Level ▶	
Power Management	[User Define]		
Video Off Method	[Blank Screen]		
Video Off In Suspend	[Yes]		
Suspend Type	[Stop Grant]		
Suspend Mode	[Disabled]		
HDD Power Down	[Disabled]		
Soft-Off by PWR-BTTN	[Instant-Off]		
CPU THRM-Throttling	[50.0%]		
Wake On LAN	[Disabled]		
Resume by Alarm	[Disabled]		
x Date (of Month) Alarm	0		
x Time (hh:mm:ss) Alarm	0 : 0 : 0		
** Reload Global Timer Events**			
Primary IDE 0	[Disabled]		
Primary IDE 1	[Disabled]		
Secondary IDE 0	[Disabled]		
Secondary IDE 1	[Disabled]		
FDD, COM, LPT Port	[Disabled]		
PCI PIRQ[A-D]#	[Disabled]		

ACPI function

This item allows you to enable/disable the Advanced Configuration and Power Management (ACPI).

ACPI Suspend Type

This mainboard supports one suspended state: **S1 (POS)**: Power On Suspend.

Power Management

This category allows you to select the degree of power saving. The choices are shown in the menu below.

Power Management	
Min. Saving	Minimum power management. Suspend Mode = 1 hr.
Max. Saving	Maximum power management. Suspend Mode = 1 min.
User Defined	Allows you to set each mode individually. When not disabled, each of the ranges are from 1 min. to 1 hr. except for HDD Power Down which ranges from 1 min. to 15 min. and disable.

Video Off Method

This field determines how a monitor is made blank. See the following table on next page.

Managing The PC BIOS	
V/H SYNC+Blank	This selection will cause the system to turn off the vertical and horizontal synchronization ports and write blanks to the video buffer.
Blank Screen	This option only writes blanks to the video buffer.
DPMS Support	Select this option if your monitor supports the Display Power Management Signaling (DPMS) standard of the Video Electronics Standards to select video power management values.

Video Off In Suspend

This field has two options: **Yes** or **No**. These options allows you to determine the way in which the monitor is switched off.

Suspend Type

This field allows you to select the status of the CPU when the system goes into the suspend mode. If you select by Stop Grant the CPU stops running completely, by "PWRON Suspend" keeps the CPU.

Suspend Mode

When enabled, after the set time of system inactivity, all devices except the CPU will be shut off.

HDD Power Down

If this field is enabled, after a set time of system inactivity, the hard disk will be powered down while all the other devices remain active.

Soft-Off by PWRBTN

Pressing the power button for more than 4 seconds forces the system to enter the Soft-Off state when the system has "hung".

CPU THRM-Throttling

This field allows you to select the CPU Throttle rate. When the CPU temperature is too high, the onboard hardware monitoring will tell the CPU to reduce it's processing speed to the throttling speed to protect the CPU . This function will not work when the **CPU Warning Temperature** is Disabled.

Wake On LAN

An input signal from the LAN will wake up the system from a soft off state.

Resume By Alarm

This field allows you to wake up the system at a predetermined date in the future. If you select Enabled then you need to enter the date and the time at which you want the system to "wake up."

****Reload Global Timer Events****

When Enabled, an event occurring on each device listed below will restart the global time for the standby mode.

- Primary IDE 0
- Primary IDE 1
- Secondary IDE 0
- Secondary IDE 1
- FDD, COM, LPT Port
- PCI PIRQ[A-D]

Managing The PC BIOS

3.8. PNP/PCI Configuration

Phoenix - AwardBIOS CMOS Setup Utility PNP/PCI Configurations

Reset Configuration Data	[Disabled]	Item Help
Resources Controlled By × IRQ Resources	[Auto(ESCD)] [Press Enter]	Menu Level ▶
PCI/VGA Palette Snoop	[Disabled]	Default is Disabled. select Enabled to Reset Extended System Configuration Data (ESCD)when you exit Setup if you have installed a new add-on and the system has caused such a serious conflict that the OS cannot boot

Reset Configuration Data

Normally, you leave this field Disabled. If you have installed a new add-on and the system reconfiguration has caused such a serious conflict that the operating system cannot boot then select Enabled. Selecting Enabled will reset the Extended System Configuration Data (ESCD).

Resources controlled By

Award Plug and Play BIOS has the capacity to automatically configure all of the boot and Plug and Play compatible devices. However, this capability means absolutely nothing unless you are using a Plug and Play operating system such as Windows 98.

IRQ Resources

When resources are controlled manually, assign each system interrupt a type, depending on the type of device using the interrupt

PCI /VGA Palette Snoop

Some display cards are non-standard VGA card (such as graphics accelerator or MPEG Card) which may not display color properly on your screen. "Enable" the setting in this field may correct this problem. Leave it "Disabled" as the default setting shown above if you are using the normal display card.

Managing The PC BIOS

3.9. PC Health Status

Phoenix - AwardBIOS CMOS Setup Utility PC Health Status		
CPU Warning Temperature	[Disabled]	Item Help
Current CPU Temperature	22°C/71°F	Menu Level ▶
Current FAN1 Speed	4821 RPM	
Current FAN2 Speed	0 RPM	
Current FAN3 Speed	0 RPM	
VccCore (V)	1.74 V	
2.5(V)	2.51 V	
3.3(V)	3.10 V	
+ 5 V	4.75 V	
+ 12 V	12.09 V	
- 12 V	-12.11 V	
VBAT (V)	3.23 V	
5VSB (V)	5.26 V	
Shutdown Temperature	[Disabled]	

The PC Health Status menu allows you to monitor the health status of your PC system .You can select a field of interest and monitor it's status.

CPU Warning Temperature

This field allows you to select an operating temperature range for your CPU. If the CPU temperature moves out of this range, any warning mechanism you have programmed into your system will be activated.

Current CPU Temp.

This field shows the current temperature for CPU.

Current FAN1/FAN2/FAN3 Speed

This field shows you the speeds of the three cooling fans on the mainboard.

Vcc Core

This field and the fields below it show you the current system voltage

Shutdown Temperature

When the system reaches a certain maximum temperature the system will automatically shutdown.

Managing The PC BIOS

3.10. Frequency/Voltage Control

Phoenix - AwardBIOS CMOS Setup Utility Frequency/Voltage Control

CPU Clock Ration	[10 x]	Item Help
Auto Detect PCI Clk	[Enabled]	Menu Level ▶
Spread Spectrum	[Disabled]	
CPU Clock	[100MHz]	

CPU Clock Ratio

This field allows you to select the CPU clock ratio. Most CPU clock ratios are fixed inside the CPU by the manufacturers that prohibit you to make any changes. In this case, the setting in this field will make no change to the CPU clock ratio since it locks and is automatically determined.

Auto Detect PCI Clk

When "Enabled" is selected, the mainboard will detect the presence of devices on PCI slots. When there is no device present on some of the PCI connectors, the clock on the related PCI slot will be disabled to reduce the Electro-Magnetic Interference (EMI).

Spread Spectrum

When Spread Spectrum is enabled, the EMI radiation on this mainboard will be reduced.

Managing The PC BIOS	
3.11. Load Optimized Defaults	
CMOS Setup Utility – Copyright (C) 1984 - 2001 Award Software	
<ul style="list-style-type: none"> ▶ Standard CMOS Features ▶ Advanced BIOS Features ▶ Advanced Chipset Features ▶ Integrated Peripherals ▶ Power Management Setup ▶ PNP/PCI Configuration ▶ PC Health Status 	<ul style="list-style-type: none"> ▶ Frequency/Voltage Control <li style="background-color: black; color: white; padding: 2px;">▶ Load Optimized Defaults ▶ Set Supervisor Password ▶ Set User Password ▶ Save & Exit Setup ▶ Exit Without Saving
ESC : Quit ← ↑ ↓ → : Select Item F10 : Save & Exit Setup	
Load Optimal Settings except Standard CMOS SETUP	

There is CMOS memory on the mainboard that can be used to store the system settings. If you don't know how to use the Award BIOS CMOS Setup Utility to select the settings, you may use this field to load the optimized defaults which are defined in the system BIOS. **Our engineer recommends the Optimized Defaults.** If this option is selected it will give a series of parameters that will ensure the reliability and performance of your PC.

If you lose your CMOS data or you don't know how to complete the setup procedure, you may use this option to load the Optimized default values from the BIOS default table.

If the CMOS data is corrupted, or if you selected some CMOS settings and find that the PC system becomes very unstable, you should try to load the optimized default values first and then re-configure the BIOS.

Managing The PC BIOS	
3.12. Set Supervisor Password	
CMOS Setup Utility – Copyright (C) 1984 - 2001 Award Software	
<ul style="list-style-type: none"> ▶ Standard CMOS Features ▶ Advanced BIOS Features ▶ Advanced Chipset Features ▶ Integrated Peripherals ▶ Power Management Setup ▶ PNP/PCI Configuration ▶ PC Health Status 	<ul style="list-style-type: none"> ▶ Frequency/Voltage Control Load Optimized Defaults Set Supervisor Password Set User Password Save & Exit Setup Exit Without Saving
ESC : Quit F10 : Save & Exit Setup	← ↑ ↓ → : Select Item
Change / Set / Disable Password	

The "SUPERVISOR PASSWORD" is for you to control unauthorized access to your BIOS CMOS Setup or Booting into the your PC system. The Supervisor Password option is used together with the Security Option in section 3.4.

When "Setup" is selected in the Security Option:

If you want to change any BIOS setting, you will have to key-in the Supervisor Password so that you can start the BIOS CMOS Setup Utility and change the system setting.

When "System" is selected in Security Option:

Whenever you turn on the PC, it will request the user to enter the Password in order to boot up your system. Without the correct password, the PC system will stop and the operating system will not be loaded.

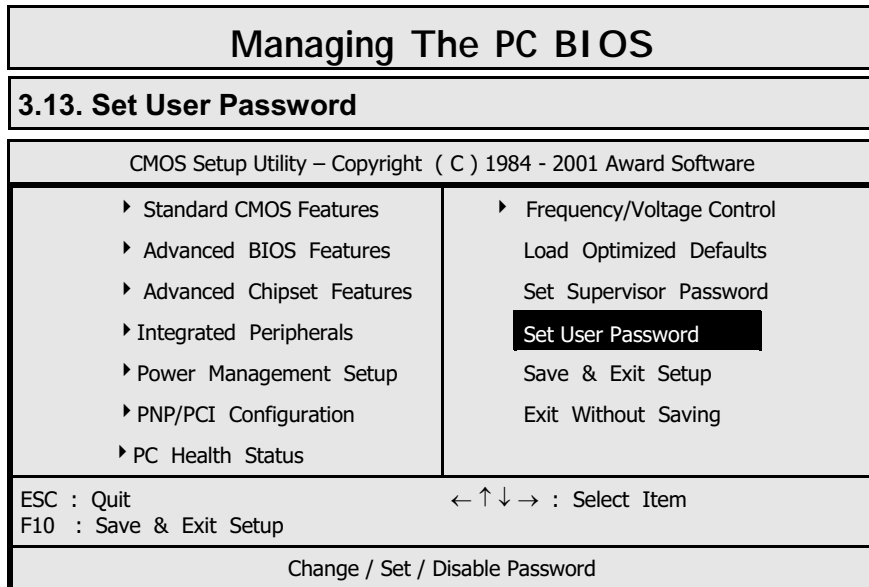

The User Password can be used to check the user's authority. However, this password entry is different from the "SUPERVISOR PASSWORD". The User Password has a different function to the "Supervisor Password" and the "Security Option" setup in Section 3.4.:

A. When there is the password stored in the "SUPERVISOR PASSWORD"

1. When "Setup" is selected in the Security Option:

When you use the "User Password" to log into the BIOS setup program, you can only view the BIOS settings, but you cannot change any settings. The only setting you can change is the "User Password" and you can also select "SAVE & EXIT SETUP" and "EXIT WITHOUT SAVING" from the main menu. (If you use the Supervisor Password to log into the PC system, you will have the complete rights to all the BIOS settings.)

2. When "System" is selected in Security Option:

When you turn on the PC system, it will request that you enter the Password. Without the correct password, the PC system will stop and the operating system won't be loaded.

B. When there is no password stored in the "SUPERVISOR PASSWORD"

1. When "Setup" is selected in Security Option:

Users can use the "User Password" to log into the BIOS setup program, and they can change any of the BIOS settings.

2. When "System" is selected in Security Option:

When you turn on your PC, you will be requested to enter the Password. Without the correct password, the PC system will stop and the operation system will not be loaded.

Managing The PC BIOS

3.14. Save & Exit Setup / Exit Without Saving

CMOS Setup Utility – Copyright (C) 1984 - 2001 Award Software	
<ul style="list-style-type: none">▶ Standard CMOS Features▶ Advanced BIOS Features▶ Advanced Chipset Features▶ Integrated Peripherals▶ Power Management Setup▶ PNP/PCI Configuration▶ PC Health Status	<ul style="list-style-type: none">▶ Frequency/Voltage ControlLoad Optimized DefaultsSet Supervisor PasswordSet User PasswordSave & Exit SetupExit Without Saving
ESC : Quit	← ↑ ↓ → : Select Item
F10 : Save & Exit Setup	
Save Data to CMOS & Exit SETUP / Abandon all Data & Exit SETUP	

Save & Exit Setup

This option will save all the setup values to CMOS RAM and exit the SETUP utility. Move the selection bar to "SAVE & EXIT SETUP" and press the "Enter" key, then type "Y" and press the "Enter" key again. The values you have entered will be saved and all the information stored in the CMOS memory.

Exit Without Saving

This option will exits the setup utility without saving any of the values you changed in the CMOS RAM. If you do not want to save any of the changes, or settings you selected in the BIOS SETUP utility, move the selection bar to the "EXIT WITHOUT SAVING" option. Press the "Enter" key. Then press "Y"

Appendix A

Appendix A: AGP Card Identification

Introduction

This mainboard uses the Intel® 845 chipset and therefore only a **1.5 volt** AGP card can be used. There are two methods of determining whether the AGP card you are using is a **1.5 volt** or a **3.3 volt** card. The first method is a physical check of the card and the second is a simple measurement.

Method 1: Physical Check of the AGP Card

The first method of determining whether you have a **1.5 volt** AGP card or a **3.3 volt** AGP card is to see if **Pin 2**, on the **Solder Side (or Side A)**, is connected to the card itself. If there is a connection from **Pin 2** to the AGP card then it is a **1.5 volt** AGP card and can be used on an Intel® 845 mainboard.



Pic 1a: 1.5V AGP Card (Side A)

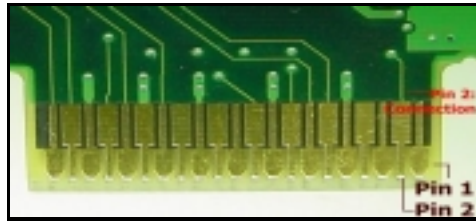

Pic 1b: 1.5V AGP Card Pin 2 connection (Side A)

In **Pic 1b** a narrow line can be seen protruding from **Pin 2**. This line, which ends in a circle, is the connection from **Pin 2** to the AGP card. If **Pin 2** on your AGP card has this "thread" then it is a **1.5 volt** AGP card.

If there is no connection from **Pin 2** on the **Solder Side (Side A)** of the card then it is a **3.3 volt** AGP card and cannot be used on an Intel® 845 mainboard.

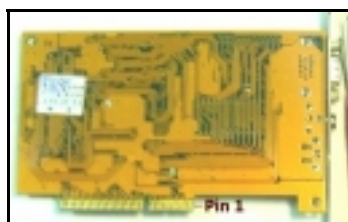

Pic 2a: 3.3V AGP (Side A)

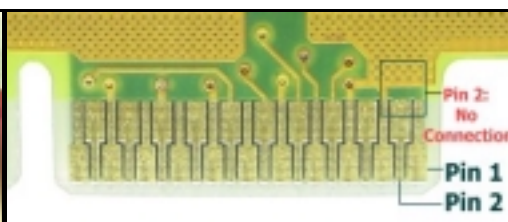

Pic 2b: 3.3V AGP Card Pin 2 No connection (Side A)

If you look at the top of **Pin 2** in **Pic 2b** you will see that there is no connection to the AGP card. This means that this is a **3.3 volt** AGP card and can therefore not be used on an Intel® 845 mainboard.

Appendix A

Method 2: Measurement

The second method of checking whether an AGP card is **1.5 volt** or **3.3 volt** is by taking a simple measurement with a Ohmmeter. Connect one pin of the Ohmmeter to **Pin 2** on the **Solder Side** (or **Side A**) of the card and the other end of the Ohmmeter to any ground point on the AGP card. If no measurement is seen then it implies there is no connection and the it is a **3.3 volt** card. If there is a small reading (which should be close to 0 ohms) then there is a connection between **Pin 2** and the ground point of the card and it is therefore a **1.5 volt** AGP card.

The picture on the right shows how to take the measurement on **Pin 2**. The reading on the Ohmmeter is nearly zero. This means that there is a connection between **Pin 2** and the ground point AGP card. The AGP card is therefore a **1.5 volt** AGP Card and can be used on Intel® 845 mainboards.

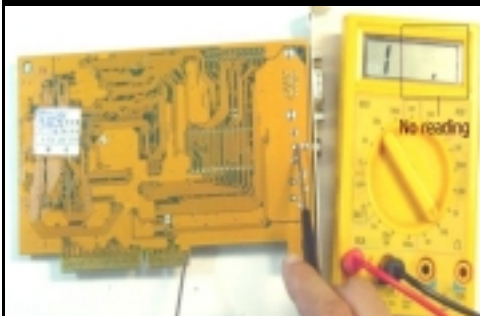
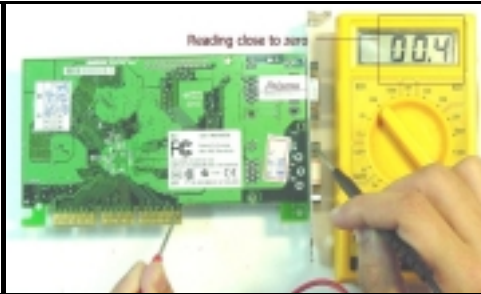

The picture on the left shows a second measurement on a different AGP Card. There is no reading on the Ohmmeter. This means that there is no connection between **Pin 2** and the ground point on the AGP card. The AGP card is therefore a **3.3 volt** AGP Card and cannot be used on Intel® 845 mainboards.

Conclusion

It is important that you only use a **1.5 volt** AGP Card on an Intel® 845 mainboard. If there is a connection from **Pin 2** of the AGP card to the ground point of the card then it is a **1.5 volt** card. There are two methods to determine if there is a connection or not. The first method is a physical check and the second method is a simple measurement between Pin 2 (**on Side A**) and any ground point on the card. The second method is the recommended method but both methods SHOULD suffice.