



User Guide

**XFx nForce 790i Ultra  
3-Way SLI Motherboard**



# Table of Contents

User Guide .....	i
XFX nForce 790i Ultra 3-Way SLI Motherboard .....	i
Before You Begin... ..	ix
Inside the 780i 3-Way SLI Installation CD .....	ix
Parts NOT in the Kit .....	x
Intentions of the Kit .....	xi
XFX nForce 790i Ultra SLI Motherboard.....	1
Motherboard Specifications.....	1
Unpacking and Parts Descriptions.....	3
Unpacking .....	3
Equipment.....	3
XFX nForce 790i Ultra SLI Motherboard.....	4
Hardware Installation .....	7
Safety Instructions.....	7
Preparing the Motherboard .....	8
Installing the CPU .....	8
Installing the CPU Fan .....	9
Installing Memory DIMMs.....	9
Installing the Motherboard.....	10
Installing the I/O Shield .....	10
Securing the Motherboard into the Chassis.....	11
Connecting Cables and Setting Switches .....	11

Power Connections .....	12
24-pin ATX Power (PWR1) .....	13
8-pin ATX 12V Power (PWR2).....	14
Connecting IDE Hard Disk Drives .....	14
Connecting Serial ATA Cables.....	15
Connecting Internal Headers .....	16
Front Panel Header .....	16
IEEE 1394a .....	17
USB Headers .....	18
Audio .....	19
Fan Connections .....	20
COM1 .....	21
FDD Connector .....	22
Expansion Slots .....	22
PCI Slots .....	23
PCI Express x1 Slots .....	23
PCI Express x16 Slots .....	23
Jumper Settings .....	24
Clear CMOS Jumper: CLR_CMOS.....	24
Configuring the BIOS .....	25
Enter BIOS Setup.....	26
Main Menu.....	26
Standard CMOS Features Menu .....	29
Date and Time.....	30
IDE Channel and SATA Channel.....	30
Drive A.....	32
Halt On .....	32
Memory .....	33

Advanced BIOS Features ..... 34

- Removable Device Priority ..... 35
- Hard Disk Boot Priority ..... 35
- Network Boot Priority ..... 35
- CPU Internal Cache ..... 35
- Quick Power On Self Test ..... 36
- First/Second/Third Boot Device ..... 36
- Boot Other Device ..... 36
- Boot Up NumLock Status ..... 36
- Security Option ..... 37
- APIC Mode ..... 37
- MPS Version Control For OS ..... 37
- Full Screen LOGO Show ..... 37

Advanced Chipset Features ..... 38

- System Clocks ..... 39
  - Frequency Settings ..... 40
  - HT Multiplier ..... 41
  - Spread Spectrum ..... 41
- FSB & Memory Config ..... 42
- CPU Configuration ..... 46
- System Voltages ..... 48
- NVMEM Memory Test ..... 50
- Load Timing/Voltage Set ..... 50
- Save Timing/Voltage Set ..... 51
- System BIOS Cacheable ..... 51
- HPET Function ..... 51
- NVIDIA GPU Ex ..... 51

Integrated Peripherals Menu ..... 52

IDE Function Setup .....	53
RAID Config .....	54
USB Config.....	54
MAC Config .....	55
IEEE1394 controller .....	55
HD Audio .....	55
IDE HDD Block Mode.....	55
Onboard FDC Controller .....	55
Onboard Serial Port 1 .....	56
Power Management Setup Menu .....	56
ACPI Function .....	57
ACPI Suspend Type.....	57
Soft-Off by PBNT .....	57
WOL(PME#) From Soft-Off .....	57
Power On by Alarm .....	57
POWER ON Function .....	58
PnP/PCI Configuration Menu .....	59
Init Display First.....	59
Reset Configuration Data .....	60
Resources Controlled By .....	60
IRQ Resources.....	61
PCI/VGA Palette Snoop .....	61
Maximum Payload Size.....	61
System Monitor Menu .....	62
Dynamic Fan Control .....	63
Installing Drivers and Software .....	65
Windows XP Drivers Install .....	66
Using the NVIDIA Software.....	67

NVIDIA Performance Group of NVIDIA Control Panel .....	68
Device Settings .....	69
Current Hardware Settings.....	70
Dynamic BIOS Access .....	76
View System Information .....	77
Profile Policies.....	78
Manage Your System BIOS .....	79
NVIDIA System Monitor .....	80
Appendix A. POST Codes for Tritium Platform.....	85
Appendix B. Configuring an SLI Configuration .....	95
ForceWare Driver.....	96
Enabling 3-Way SLI .....	98
Verifying 3-way SLI is Active.....	100
Index.....	101

## List of Figures

Figure 1.	XFX nForce 790i Ultra SLI Motherboard Layout.....	5
Figure 2.	Chassis Backpanel Connectors .....	6
Figure 3.	Power Supply Connectors .....	12
Figure 4.	PWR1 Motherboard Connector .....	13
Figure 5.	BIOS CMOS Setup Utility Main Menu .....	27
Figure 6.	Standard CMOS Features Menu.....	29
Figure 7.	Advanced BIOS Features Menu.....	34
Figure 8.	Advanced Chipset Features .....	38
Figure 9.	System Clocks Menu.....	39
Figure 10.	FSB & Memory Config Menu.....	42
Figure 11.	CPU Configuration Menu .....	46
Figure 12.	System Voltages Menu .....	48
Figure 13.	Integrated Peripherals Menu .....	52
Figure 14.	Power Management Setup Menu.....	56
Figure 15.	PnP/PCI Configuration Menu .....	59
Figure 16.	System Monitor Menu .....	62
Figure 17.	3-Way SLI Using GeForce 8800 Ultra.....	95
Figure 18.	3-way NVIDIA SLI connector.....	96
Figure 19.	Windows Vista Device Manager.....	97
Figure 20.	NVIDIA Control Panel, Set SLI Configuration .....	98
Figure 21.	SLI Visual Indicators Operating in 3DMark2006 .....	99



## Before You Begin...

---

### Inside the 780i 3-Way SLI Installation CD

The following tools and drivers are in the 790i 3-Way SLI Installation CD:

- ❑ Motherboard Drivers for:
  - Windows XP
  - Windows XP 64-bit
  - Windows Vista
  - Windows Vista 64-bit
- ❑ Onboard Audio Drivers
  - ❑ Windows XP
  - ❑ Windows XP 64-bit
  - ❑ Windows Vista
  - ❑ Windows Vista 64-bit
- ❑ Adobe Acrobat Reader 8.0
- ❑ Raid Setup Floppy Disk Creator
- ❑ Motherboard Manual NVIDIA Software
  - NVIDIA MediaShield Storage
  - NVIDIA System Monitor

---

## Parts NOT in the Kit

This kit contains all the hardware necessary to install and connect your new NVIDIA® nForce® 790i Ultra SLI motherboard. However, it does not contain the following items that must be purchased separately to make the motherboard functional.

❑ **Intel microprocessor:**

Intel Core 2 Extreme, Intel Core 2 Quad, Intel Core 2 Duo Pentium EE, Pentium D, Pentium

❑ Cooling fan for the microprocessor

❑ **System memory support:**

Supports dual channel DDR3 800/1066/1333, and up to 2000 MHz SLI-Ready Memory. Supports up to 8 GBs DDR3 memory.

❑ **Graphics Card**

This motherboard supports 3-way SLI with three x16 PCI Express slots.

❑ **Power Supply**

The power supply requirement is dependent upon the power and the number of the GPUs you install. If you are going to SLI two graphics cards, you are going to require more power. As a rule, for one GPU you need a minimum of a 300 W power supply. If you have two GPUs in an SLI configuration, you will need a minimum of a 500 W power supply. If you have three GPUs in an SLI configuration, you will need a minimum of a 1000 W power supply. To calculate the power you are going to require for your specific configuration, go to [www.slizone.com](http://www.slizone.com).

These instructions tell you how to install each of the parts listed so you can have a functioning motherboard. As you go through the installation instructions, we are assuming you have purchased the necessary parts.

---

## Intentions of the Kit

This kit provides you with the motherboard and all connecting cables necessary to install the motherboard into a PC cabinet. If you are *building* a PC, you will use most of the cables provided in the kit. If however, you are *replacing* a motherboard, you will not need many of the cables.

When *replacing* a motherboard in a PC cabinet, you will need to reinstall an operating system even though the current drives have an operating system.



# XFx nForce 790i Ultra SLI Motherboard

Thank you for buying the XFX NFORCE 790i Ultra SLI Motherboard. This motherboard offers the tools and performance PC users' demand. When combined with two or three SLI-Ready XFX GeForce graphics cards, you get innovative NVIDIA SLI Technology for enhanced system performance.

---

## Motherboard Specifications

- ❑ Size
  - ATX form factor of 12 inch x 9.6 inch
- ❑ Microprocessor support
  - Intel Core 2 Extreme, Intel Core 2 Quad, Intel Core 2 Duo, Pentium EE, Pentium D, Pentium
- ❑ Operating systems:
  - Supports Windows XP 32bit/64bit and Windows Vista 32bit/64bit
- ❑ Contains NVIDIA nForce 790i Ultra SLI MCP and SPP
- ❑ System Memory support
  - Supports dual channel JEDEC DDR3-1333 and SLI-Ready memory up to 2000 MHz. Supports up to 8 GBs DDR3 memories.
- ❑ Ten USB 2.0 Ports
  - Supports hot plug
  - Ten USB 2.0 ports (six rear panel ports, four onboard USB headers)
  - Supports wake-up from S1 and S3 mode
  - Supports USB 2.0 protocol up to 480 Mbps transmission rate

- ❑ Onboard Serial ATA II
  - 300MBps data transfer rate
  - Six Serial ATA II connectors
  - NVIDIA MediaShield RAID with support for RAID 0, RAID 1, RAID 0+1, RAID 5, and JBOD
  - Supports hot plug and NCQ (Native Command Queuing)
- ❑ Onboard LAN
  - Dual LAN interface built-in onboard
  - Supports 10/100/1000 Mbit/sec Ethernet
- ❑ Onboard 1394
  - Support hot plug
  - Two 1394a ports (one rear panel port, one onboard header) with rate of transmission at 400 Mbps
- ❑ Onboard Audio
  - Azalia High-Definition audio
  - Supports 8-channel audio
  - Supports S/PDIF output
  - Supports Jack-Sensing function
- ❑ Triple PCI Express x16 Support
  - 2 x16 PCI Express 2.0
  - 1 x16 PCI Express 1.0
  - Supports 4 GB/sec (8 GB/sec concurrent) bandwidth
  - Low power consumption and power management features
- ❑ Green Function
  - Supports ACPI (Advanced Configuration and Power Interface)
  - Supports S0 (normal), S1 (power on suspend), S3 (suspend to RAM), S4 (Suspend to disk - depends on OS), and S5 (soft - off)
- ❑ Expansion Slots
  - Two PCI slots
  - One PCI Express x1 slot
  - Three PCI Express x16 Graphics slots

# Unpacking and Parts Descriptions

---

## Unpacking

The XFX nForce 790i Ultra SLI motherboard comes with all the necessary cables for adding a motherboard to a new chassis. If you are replacing a motherboard, you may not need many of these cables.

Be sure to inspect each piece of equipment shipped in the packing box. If anything is missing or damaged, contact your reseller.

All parts shipped in this kit are RoHS-compliant (lead-free) parts.

---

## Equipment

The following equipment is included in the XFX nForce 790i Ultra SLI motherboard box.



**XFX nForce 790i Ultra SLI Motherboard**  
This PCI Express motherboard contains the NVIDIA nForce 790i Ultra SLI SPP and MCP and is SLI-ready.



**I/O Shield**  
Installs in the chassis to block radio frequency transmissions, protect internet components from dust and foreign objects and aids in proper airflow within the chassis.



**Floppy Cable**  
Used to attach a floppy drive to the motherboard.

## XFX nForce 790i Ultra 3-Way SLI Motherboard



2-Port SATA Power Cable (Qty Three)



1394 Cable  
Provides two additional 1394 ports to either the front or back panels of the chassis.



USB 2.0 4-Port Cable  
Provides four additional USB ports to either the front or back panels of the chassis.



SATA Signal Cable (Qty Six)  
Used to support the Serial ATA protocol and each one connects a single drive to the motherboard



IDE-ATA 133 HDD Cable



SLI Bridge (use for two graphics cards in SLI)



3-Way SLI Bridge (use for three graphics cards in SLI)

## XFX nForce 790i Ultra SLI Motherboard

The XFX nForce 790i Ultra SLI motherboard with the NVIDIA nForce 790i Ultra SLI SPP and MCP processors is a PCI Express, SLI-ready motherboard. Figure 1 shows the motherboard and Figures 2 shows the back panel connectors.



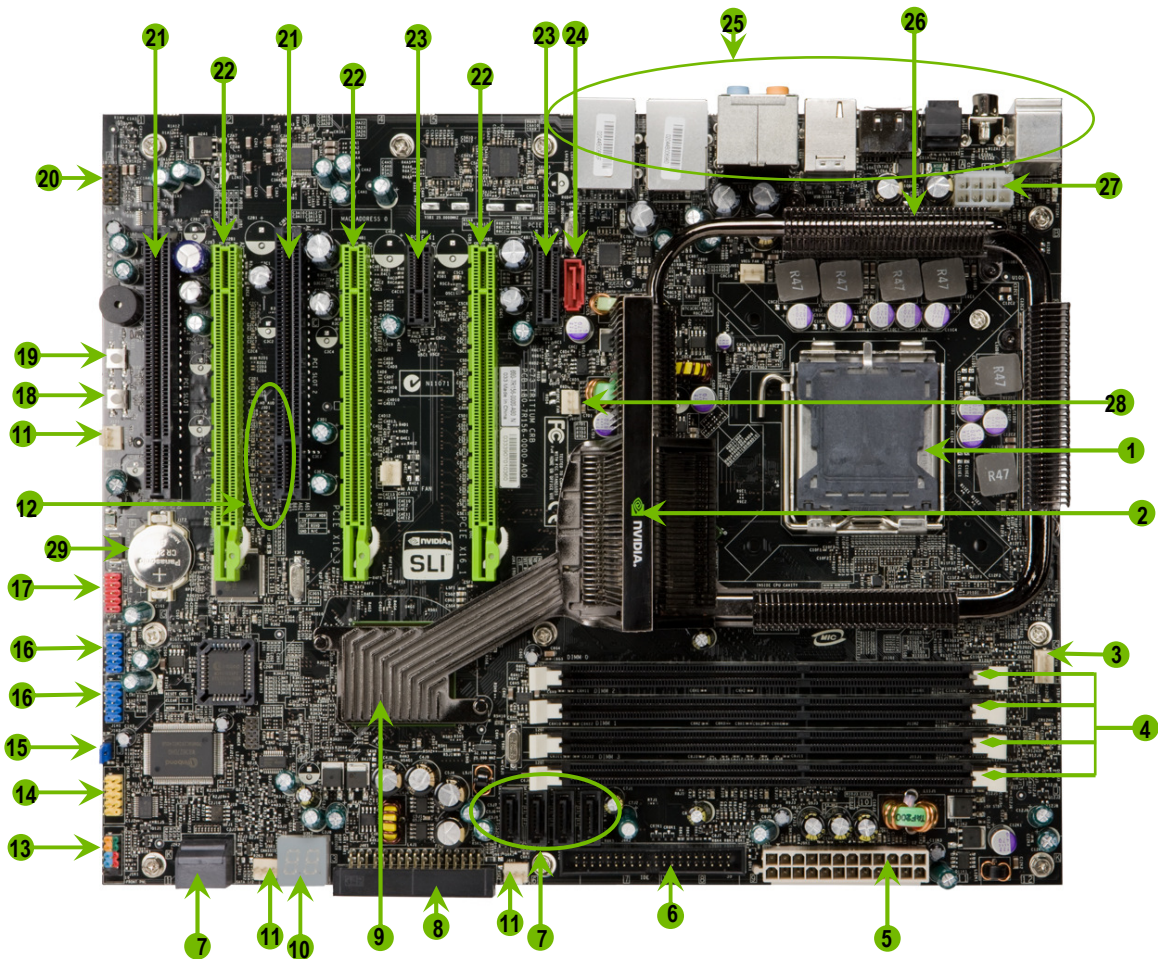

1. CPU Socket	11. Fan connectors	21. PCI slots
2. nForce 790i Ultra SLI heatpipe	12. HDA and SPDIF connector	22. PCI Express x16 slots (SLI)
3. CPU fan connector	13. Front panel connector	23. PCI Express x1 slot
4. DDR3 DIMM slots 0 - 3	14. Serial connector	24. SATA connector
5. 24-pin ATX power connector	15. Clear CMOS Jumper	25. Backpanel connectors (Figure 2)
6. IDE connector	16. USB headers	26. Heat dissipater
7. Serial-ATA (SATA) connectors	17. 1394a connector	27. 8-pin ATX_12V power connector
8. FDD connector	18. Power button	28. MCP/SPP fan connector
9. NVIDIA MCP (passive heat sink)	19. Reset Button	29. Motherboard battery
10. Diagnostic code display	20. Front panel Audio connector	

Figure 1. XFX nForce 790i Ultra SLI Motherboard Layout

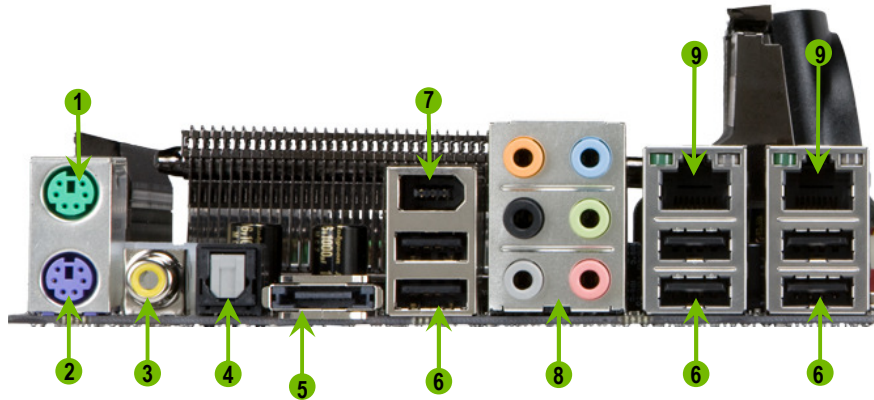

1. PS/2 Mouse Port
2. PS/2 Keyboard Port
3. Coaxial SPDIF
4. SPDIF output
5. eSATA
6. USB 2.0 ports (SIX)
7. 1394a (Firewire) Port

8. Port	2-Channel	4-Channel	6-Channel/8-Channel
Blue	Line-In	Line-In	Line-In
Green	Line-Out	Front Speaker Out	Front Speaker Out
Pink	Mic In	Mic In	Mic In
Orange			Center/Subwoofer
Black		Rear Speaker Out	Rear Speaker Out
Grey			

9. Lan Port with LEDs to indicate status.
  - Yellow/Light Up/Blink = 10 Mbps/Link/Activity
  - Yellow and Green/Light Up/Blink = 100 Mbps/link/Activity
  - Green/Light Up/Blink = 1000 Mbps/Link/Activity

Figure 2. Chassis Backpanel Connectors

# Hardware Installation

This section will guide you through the installation of the motherboard. The topics covered in this section are:

- ❑ Preparing the motherboard
  - Installing the CPU
  - Installing the CPU fan
  - Installing the memory
- ❑ Installing the motherboard
- ❑ Connecting cables and setting switches

---

## Safety Instructions

**To reduce the risk of fire, electric shock, and injury, always follow basic safety precautions.**

**Remember to remove power from your computer by disconnecting the AC main source before removing or installing any equipment from/to the computer chassis.**

---

## Preparing the Motherboard

The motherboard shipped in the box does **not** contain a CPU or memory. You need to purchase these to complete this installation.

### Installing the CPU

Be very careful when handling the CPU. Make sure not to bend or break any pins on the back. Hold the processor only by the edges and do not touch the bottom of the processor.

Use the following procedure to install the CPU onto the motherboard.

1. Unhook the socket lever by pushing *down* and *away* from the socket.
2. Lift the load plate. There is a protective socket cover on the load plate to protect the socket when there is no CPU installed.
3. Remove the protective socket cover from the load plate.
4. Remove the processor from its protective cover, making sure you hold it only by the edges. It is a good idea to save the cover so that whenever you remove the CPU, you have a safe place to store it.
5. Align the notches in the processor with the notches on the socket.
6. Lower the processor straight down into the socket with out tilting or sliding it into the socket

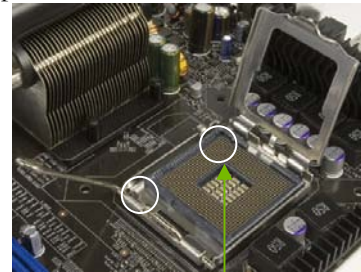
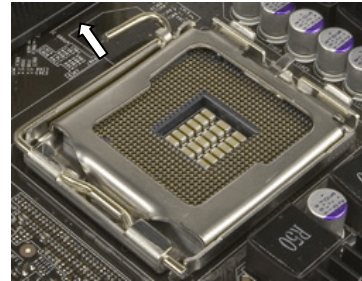

Align notches with notches on the CPU

**Note:** Make sure the CPU is fully seated and level in the socket.



7. Close the load plate over the CPU and press down while you close and engage the socket lever.

## Installing the CPU Fan

There are many different fan types that can be used with this motherboard. Follow the instruction that came with you fan assembly. Be sure that the fan orientation is correct for your chassis type and your fan assembly.

## Installing Memory DIMMs

Your new motherboard has four 240-pin slots for DDR3 memory. These slots support 256 Mb, 512 Mb and 1 Gb DDR3 technologies for x8 and x16 devices. There must be at least one memory bank populated to ensure normal operation. Use the following the recommendations for installing memory. (See Figure 1 on page 5 for the location of the memory slots.)

- ❑ **One DIMM:** Install into slot 0. You can install the DIMM into any slot, however, slot 0 is preferred.
- ❑ **Two DIMMs:** Install into either slots 0 and 1 or 2 and 3. The idea is to not have the DIMMs in adjacent slots.
- ❑ **Four DIMMS:** Install into slots 0, 1, 2, and 3.

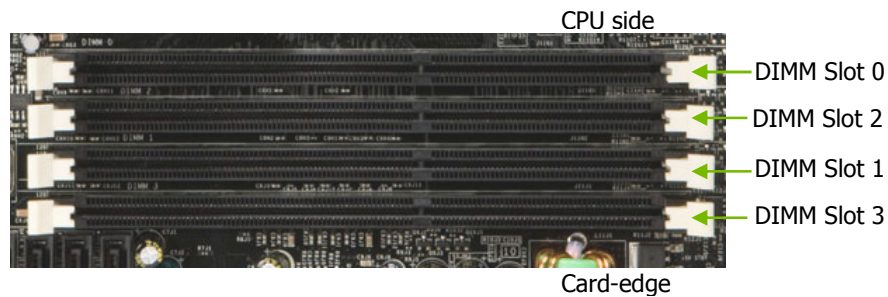

Use the following procedure to install memory DIMMs. Note that there is only one gap near the center of the DIMM slot. This slot matches the slot on the memory DIMM to ensure the component is installed properly.

1. Unlock a DIMM slot by pressing the module clips outward.
2. Align the memory module to the DIMM slot, and insert the module vertically into the DIMM slot. The plastic clips at both sides of the DIMM slot automatically lock the DIMM into the connector.

---

## Installing the Motherboard

The sequence of installing the motherboard into the chassis depends on the chassis you are using and if you are replacing an existing motherboard or working with an empty chassis. Determine if it would be easier to make all the connections prior to this step or to secure the motherboard and then make all the connections. It is normally easier to secure the motherboard first.

Use the following procedure to install the I/O shield and secure the motherboard into the chassis.

**Note:** Be sure that the CPU fan assembly has enough clearance for the chassis covers to lock into place and for the expansion cards. Also make sure the CPU Fan assembly is aligned with the vents on the covers.

## Installing the I/O Shield

The motherboard kit comes with an I/O shield that is used to block radio frequency transmissions, protects internal components from dust and foreign objects, and promotes correct airflow within the chassis.

Before installing the motherboard, install the I/O shield from the *inside* of the chassis. Press the I/O shield into place and make sure it fits securely. If the I/O shield does not fit into the chassis, you would need to obtain the proper size from the chassis supplier.

## Securing the Motherboard into the Chassis

Most computer chassis have a base with mounting studs or spacers to allow the mother board to be secured to the chassis and help to prevent short circuits. If there are studs that do not align with a mounting hole on the motherboard, it is recommended that you remove that stud to prevent the possibility of a short circuit. In most cases, it is recommended to secure the motherboard using a minimum of nine (9) spacers.

1. Carefully place the motherboard onto the studs/spacers located inside the chassis.
2. Align the mounting holes with the studs/spacers.
3. Align the connectors to the I/O shield.
4. Ensure that the fan assembly is aligned with the chassis vents according to the fan assembly instruction.
5. Secure the motherboard with a minimum of eight-to-ten screws.

---

## Connecting Cables and Setting Switches

This section takes you through all the connections and switch settings necessary on the motherboard. This will include:

- Power Connections
  - 24-pin ATX power (**PWR1**)
  - 8-pin ATX 12V power (**PWR2**)
- Internal Headers
  - Front panel
  - IEEE 1394a
  - USB Headers
  - Audio
  - Speaker
  - COM

- ❑ FDD
- ❑ IDE
- ❑ Serial ATA II
- ❑ Chassis Fans
- ❑ Rear panel USB 2.0 Adapter
- ❑ Expansion slots
- ❑ CMOS jumper settings

See Figure 1 on page 5 to locate the connectors and jumpers referenced in the following procedure.

## Power Connections

To support 3-way SLI, this motherboard has the following specific power supply requirements:

- Minimum 1000 W peak power
- Six 6-pin (3x2) PCI-E power connectors (see Figure 3):

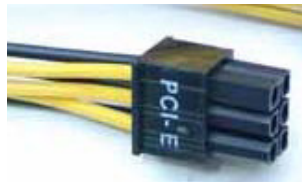

6-pin (3x2) PCI-E connector

### Figure 3. Power Supply Connectors

Make sure you have enough power to cover all the expansion cards you will be installing. To determine what your power requirements are for your specific configuration or a certified power supply vendor, refer to [www.slizone.com](http://www.slizone.com).



## 24-pin ATX Power (PWR1)

**PWR1** is the main power supply connector located along the edge of the board next to the DIMM slots. Make sure that the power supply cable and pins are properly aligned with the connector on the motherboard. Firmly plug the power supply cable into the connector and make sure it is secure.

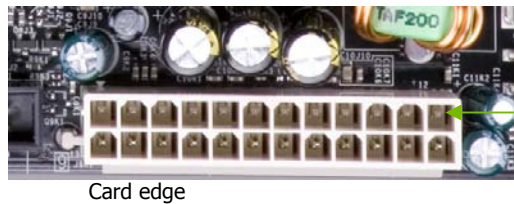

**PWR1** connector  
Plug power cable from system power supply to PWR1

Figure 4. PWR1 Motherboard Connector

Table 1. PWR1 Pin Assignments

Connector	Pin	Signal	Pin	Signal
	1	+3.3V	13	+3.3V
	2	+3.3V	14	-12V
	3	GND	15	GND
	4	+5V	16	PS_ON
	5	GND	17	GND
	6	+5V	18	GND
	7	GND	19	GND
	8	PWROK	20	RSVD
	9	+5V_AUX	21	+5V
	10	+12V	22	+5V
	11	+12V	23	+5V
	12	+3.3V	24	GND

## 8-pin ATX 12V Power (PWR2)

**PWR2**, the 8-pin ATX 12V power connection, is used to provide power to the CPU. Align the pins to the connector and press firmly until seated.

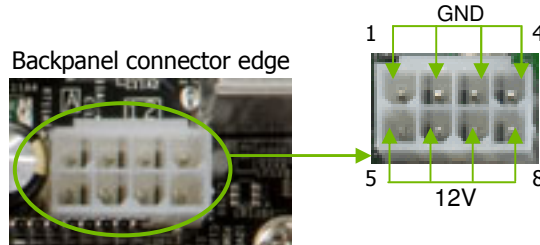

## Connecting IDE Hard Disk Drives

The IDE connector supports Ultra ATA 133/100/66 IDE hard disk drives.

1. Connect the blue connector (the cable end with a single connector) to the motherboard.
2. Connect the black connector (the cable with the two closely spaced black and gray connectors) to the Ultra ATA master device.
3. Connect the gray connector to a slave device.

If you install two hard disk drives, you must configure the second drive as a slave device by setting its jumper accordingly. Refer to the hard disk documentation for the jumper settings.

**Note:** If an ATA-66/100 disk drive and a disk drive using any other IDE transfer protocol are attached to the same cable, the maximum transfer rate between the drives may be reduced to that of the slowest drive.

## Connecting Serial ATA Cables

The Serial ATA II connector is used to connect the Serial ATA II device to the motherboard. These connectors support the thin Serial ATA II cables for primary storage devices. The current Serial ATA II interface allows up to 300MB/s data transfer rate.

There are six serial ATA connectors on the motherboard that support RAID 0, RAID 1, RAID 5, RAID 0+1 and JBOD configurations.

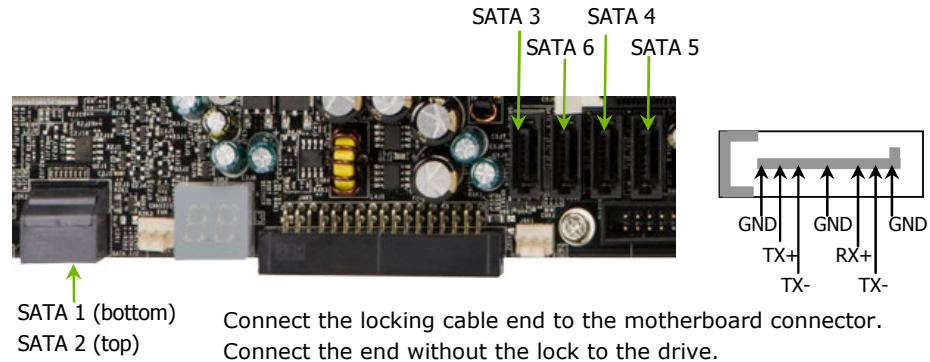

## Connecting Internal Headers

### Front Panel Header

The front panel header on this motherboard is one connector used to connect the following four cables

(see Table 2 for pin definitions):

❑ **PWRLED**

Attach the front panel power LED cable to these two pins of the connector. The Power LED indicates the system's status. When the system is in S0 status, the LED is on. When the system is in S1, S3, S4, S5 status, the LED is off.

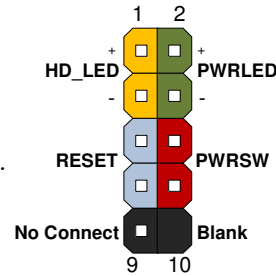

**Note:** Some chassis do not have all four cables. Be sure to match the name on the connectors to the corresponding pins.

❑ **PWRSW**

Attach the power button cable from the case to these two pins. Pressing the power button on the front panel turns the system on and off rather than using the power supply button.

❑ **HD\_LED**

Attach the hard disk drive indicator LED cable to these two pins. The HDD indicator LED indicates the activity status of the hard disks.

❑ **RESET**

Attach the Reset switch cable from the front panel of the case to these two pins. The system restarts when the **RESET** switch is pressed.

Table 2. Front Panel Header Pins

	Pin	Signal	In/Out	Description
<b>HD_LED</b>	1	HD_PWR	Out	Hard disk LED pull-up to +5V
	3	HDA#	Out	Hard disk active LED
<b>PWRLED</b>	2	HDR_BLNK_GRN	Out	Front panel green light
	4	HDR_BLNK_YEL	Out	Front panel yellow light
<b>RESET</b>	5	GND		Ground
	7	FP_RESET#	In	Reset switch
<b>PWRSW</b>	6	SWITCH_ON#	In	Power switch
	8	GND		Ground
<b>No Connect</b>	9	No Connect		
<b>Empty</b>	10	Empty		

## IEEE 1394a

The IEEE 1394 expansion cable bracket is provided in the box but if you do not require the additional external connections, you do not need to install it.

1. Secure the bracket to either the front or rear panel of your chassis (not all chassis are equipped with the front panel option).
2. Connect the two ends of the cables to the IEEE 2394 connectors on the motherboard.

Table 3. IEEE 1394a Connector Pins

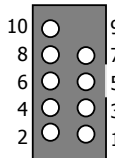
Connector	Pin	Signal
IEEE 1394a Connector  	1	TPA+
	2	TPA-
	3	GND
	4	GND
	5	TPB+
	6	TPB-
	7	+12V
	8	+12V
	9	Empty
	10	GND

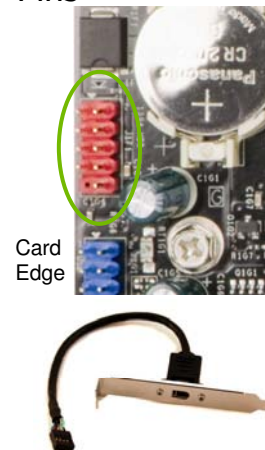

## USB Headers

This motherboard contains six (6) USB 2.0 ports that are exposed on the rear panel of the chassis (Figure 2). The motherboard also contains two 10-pin internal header connectors onboard that can be used to connect an optional external bracket containing four (4) more USB 2.0 ports.



1. Secure the bracket to either the front or rear panel of your chassis (not all chassis are equipped with the front panel option).
2. Connect the two ends of the cables to the USB 2.0 headers on the motherboard.

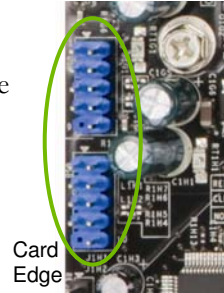

Table 4. USB 2.0 Header Pins

Connector	Pin	Signal
	1	5V_DUAL
	3	D-
	5	D+
	7	GND
	9	Empty
	<b>Pin</b>	<b>Signal</b>
	2	5V_DUAL
	4	D-
	6	D+
	8	GND
10	No Connect	

## Audio

The audio connector supports HD audio standard and provides two kinds of audio output choices: the Front Audio, the Rear Audio. The front Audio supports re-tasking function.

Table 5. Front Audio and SPDIF Connector

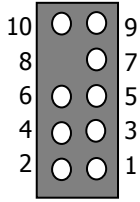
Connector	Pin	Signal
Front Audio Connector 	1	Mic (Input)
	2	Ground (Mic.)
	3	Mic-P (Pulse)
	4	Not Used
	5	PORT2_R (Right Channel Out)
	6	SENSE1_RETURN (Right Channel Ground)
	7	Not Used
	8	Empty
	9	PORT2_L (Left Channel Out)
	10	SENSE2_RETURN (Left Channel Ground)

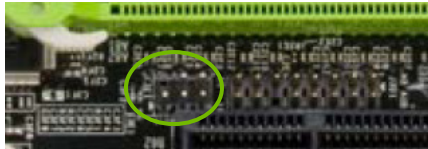
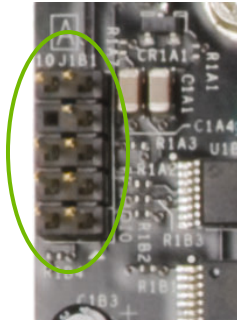

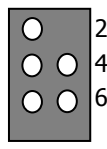
Connector	Pin	Signal
SPDIF Connector 	1	+5V
	2	Empty
	3	Audio Out
	4	Audio In
	5	Ground
	6	Not Used

## Fan Connections

There are five fan connections on the motherboard. The fan speed can be detected and viewed in the **PC Health Status** section of the CMOS Setup. The fans are automatically turned off after the system enters S3, S4 and S5 mode.

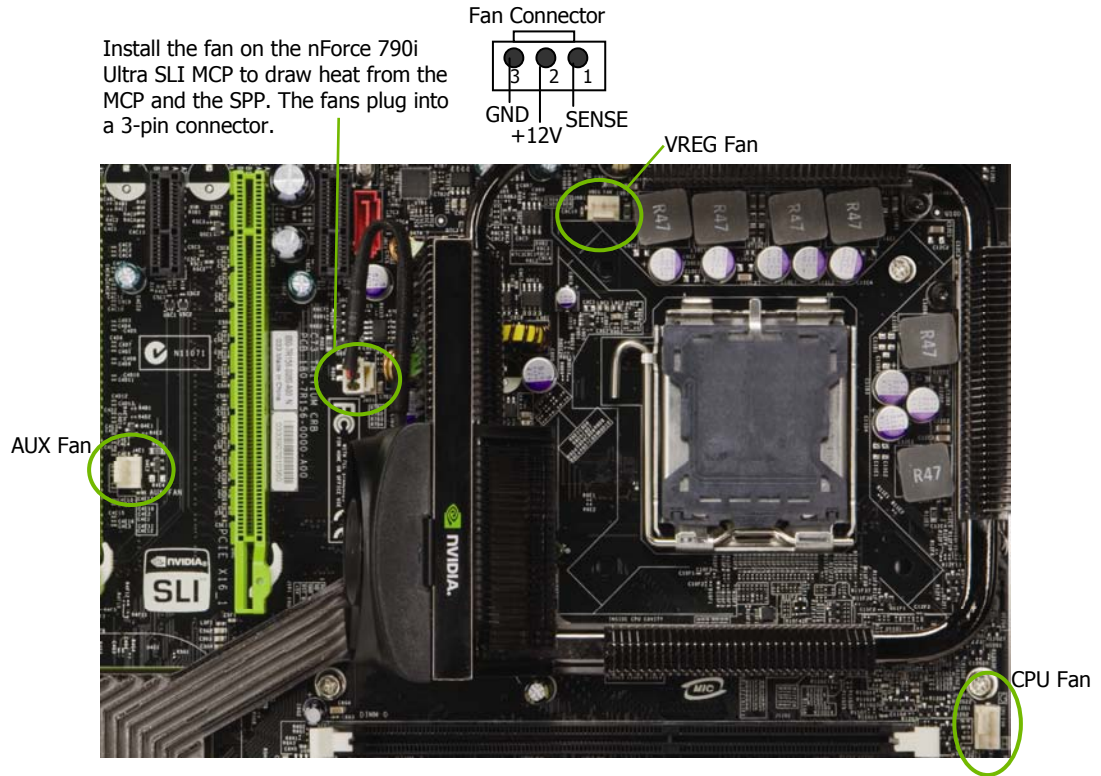

Note that the CPU fan cable can be either a 3-pin or a 4-pin connector. Connect a 3-pin connector to pins 1, 2, and 3 on the motherboard connector.

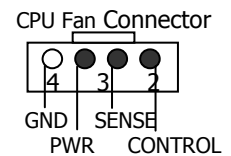



There are three more fan connectors on the motherboard. For this installation, these will not be used.

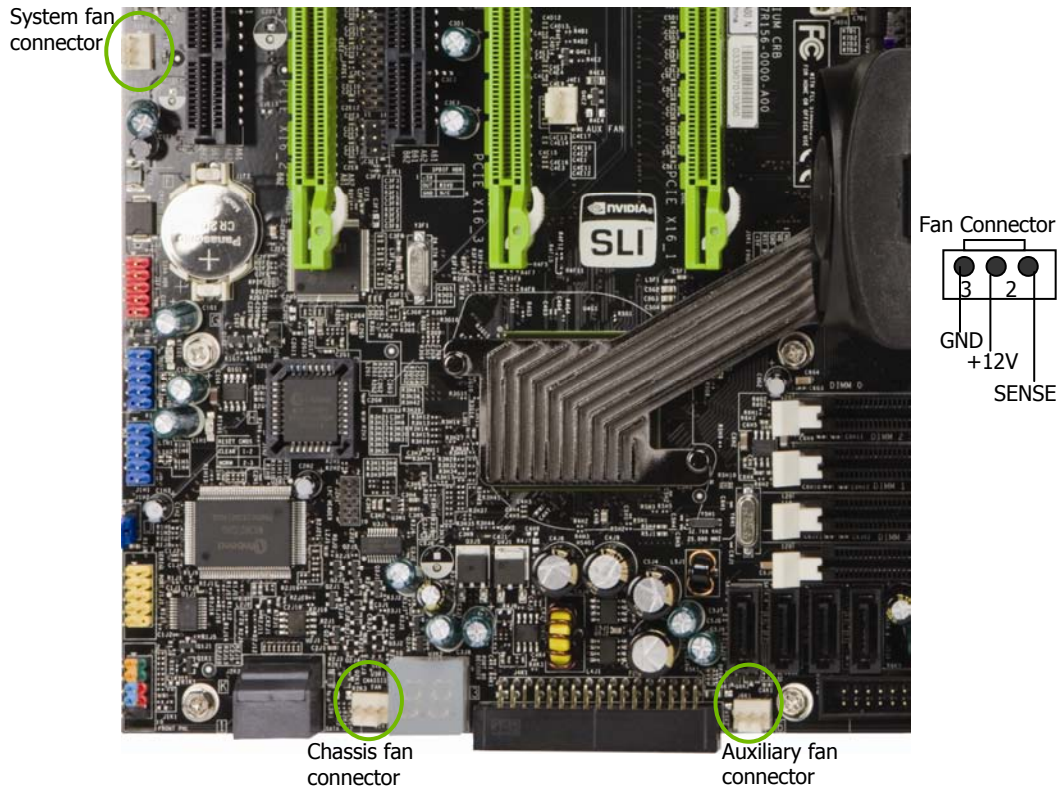

## COM1

The motherboard kit provides an additional serial COM header for your machine. Connect one side of a switching cable to the header and then attach the serial COM device to the other side of the cable.

## FDD Connector

The motherboard supports a standard 360K, 720K, 1.2M, 1.44m, and a 2.88M floppy disk drive (FDD).

## Expansion Slots

The XFX nForce 790i Ultra SLI motherboard contains seven expansion slots, five PCI Express slots and two PCI slots. For a full list of PCI Express x16 graphics card supported by this motherboard, go to [www.XFXforce.com](http://www.XFXforce.com).

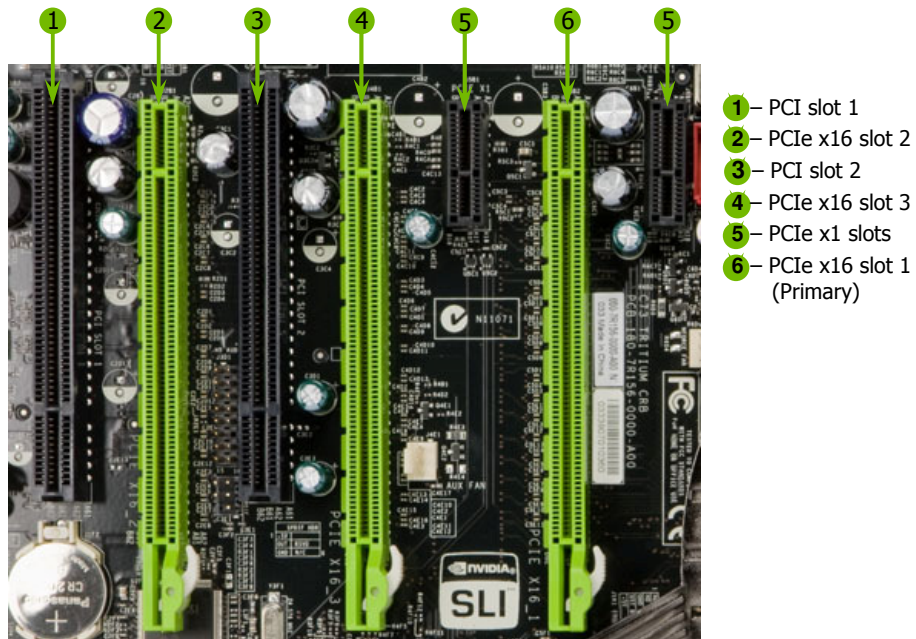

## PCI Slots

The two PCI slots support many expansion cards such as a LAN card, USB card, SCSI card and other cards that comply with PCI specifications. When installing a card into the PCI slot, be sure that it is fully seated. Secure the card's metal bracket to the chassis back panel with the screw used to hold the blank cover.

## PCI Express x1 Slots

There are two PCI Express x1 slots that are designed to accommodate less bandwidth-intensive cards, such as a modem or LAN card. The x1 slots provide 250 MB/sec bandwidth.

## PCI Express x16 Slots

These three PCI Express x16 slots are reserved for graphic or video cards. The bandwidth of the x16 slot is up to 4GB/sec (8GB/sec concurrent). The design of this motherboard supports three PCI-Express graphics cards using NVIDIA's SLI technology with multiple displays.

When installing a PCI Express x16 card, be sure the retention clip snaps and locks the card into place. If the card is not seated properly, it could cause a short across the pins. Secure the card's metal bracket to the chassis back panel with the screw used to hold the blank cover.

To configure for SLI, follow the instructions that come with the SLI kit (the kit is purchased separately from the motherboard).

---

## Jumper Settings

The motherboard contains a 3-pin BIOS configuration jumper that enables all board configurations to be done in the BIOS Setup program.

The silk screen on the motherboard shows a  $\Delta$  next to pin 1.

### Clear CMOS Jumper: CLR\_CMOS

The motherboard uses the CMOS RAM to store all the set parameters. The CMOS can be cleared by removing the CMOS jumper.

Use the following procedure to clear CMOS:

1. Turn off the AC power supply
2. Connect pins 1 and 2 together using the jumper cap.
3. Return the jumper setting to normal (pins 2 and 3 together with the jumper cap).
4. Turn the AC power supply back on.

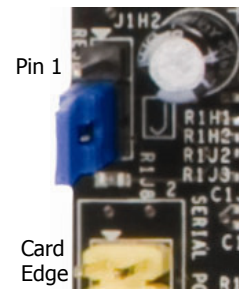

# Configuring the BIOS

This section discusses how to change the system settings through the BIOS Setup menus. Detailed descriptions of the BIOS parameters are also provided.

This section includes the following information:

- ❑ Enter BIOS Setup
- ❑ Main Menu
- ❑ Standard CMOS Features
- ❑ Advanced BIOS Features
- ❑ Advanced Chipset Features
- ❑ Integrated Peripherals
- ❑ Power Management Setup
- ❑ PnP/PCI Configurations
- ❑ System Monitor

---

## Enter BIOS Setup

The BIOS is the communication bridge between hardware and software. Correctly setting the BIOS parameters is critical to maintain optimal system performance.

Use the following procedure to verify/change BIOS settings.

1. Power on the computer.
2. Press the **Del** key when the following message briefly displays at the bottom of the screen during the Power On Self Test (POST).

**Press F1 to continue, DEL to enter Setup.**

Pressing **Del** takes you to the Phoenix-Award BIOS CMOS Setup Utility.

---

**Note:** It is *strongly* recommended that you do not change the default BIOS settings. Changing some settings could damage your computer.

---

---

## Main Menu

The main menu allows you to select from the list of setup functions and two exit choices. Use the **Page Up** and **Page Down** keys to scroll through the options or press **Enter** to display the associated submenu. Use the **↑↓** arrow keys to position the selector in the option you choose. To go back to the previous menu, press **Esc**.

---

**Note:** Note that on the BIOS screens all data in **white** is for information only, data in **yellow** is changeable, data in **blue** is non-changeable, and data in a **red box** is highlighted for selection.

---

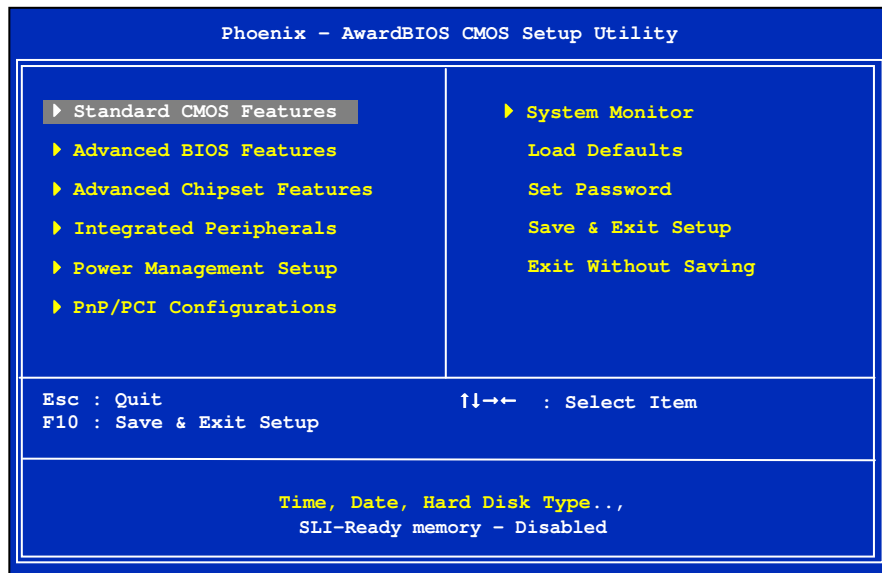

Figure 5. BIOS CMOS Setup Utility Main Menu

- ❑ **Standard CMOS Features**  
Use this menu to set up the basic system configuration.
- ❑ **Advanced BIOS Features**  
Use this menu to set up the advanced system features and boot sequence.
- ❑ **Advanced Chipset Features**  
Use this menu to optimize system performance and configure clocks, voltages, memory timings, and more.
- ❑ **Integrated Peripherals**  
Use this menu to set up onboard peripherals such as IDE, RAID, USB, LAN, and MAC control.
- ❑ **Power Management Setup**  
Use this menu to configure power management, power on, and sleep features.
- ❑ **PnP/PCI Configurations**  
Use this menu to modify the system's Plug-and-Play and PCI configurations.

❑ **System Monitor**

Use this menu to monitor the real-time system status of your PC, including temperature, voltages, and fan speed.

The following items on the CMOS Setup Utility main menu are commands rather than submenus:

❑ **Load Defaults**

Load default system settings.

❑ **Set Password**

Use this command to set, change, and disable the password used to access the BIOS menu.

❑ **Save & Exit Setup**

Use this command to save settings to CMOS and exit setup.

❑ **Exit Without Saving**

Use this command to abandon all setting changes and exit setup.

**SLI-Ready Memory** is a status indicator displayed at the bottom of the BIOS screen. The three status indicators are:

❑ **Enabled:** SLI-Ready memory is detected and enabled.

❑ **Disabled:** SLI-Ready memory is detected but disabled.

❑ **Not Detected:** SLI-Ready memory is not detected.



## Standard CMOS Features Menu

The Standard CMOS Features menu is used to configure the standard CMOS information, such as the date, time, HDD model, and so on. Use the **Page Up** and **Page Down** keys to scroll through the options or press **Enter** to display the sub-menu. Use the **↑↓** arrow keys to position the selector in the option you choose. To go back to the previous menu, press **Esc**.

The information shown in **Item Help** corresponds to the option highlighted.

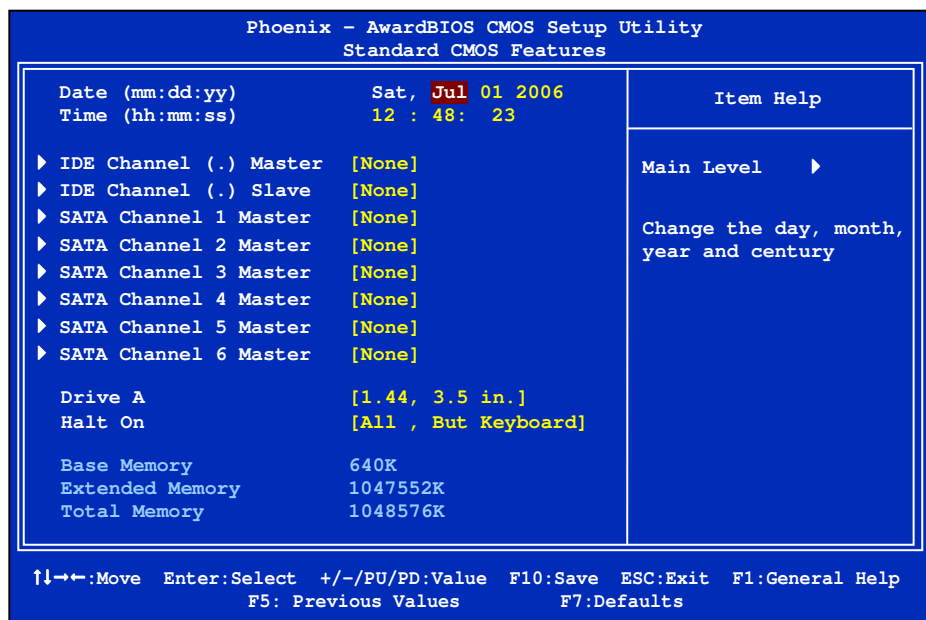

Figure 6. Standard CMOS Features Menu

**Note:** Note that all data in **white** is for information only, data in **yellow** is changeable, data in **blue** is non-changeable, and data in a **red box** is highlighted for selection.

## Date and Time

Using the arrow keys, position the cursor over the month, day, and year. Use the **Page Up** and **Page Down** keys to scroll through dates and times. Note that the weekday (Sun through Sat) cannot be changed. This field changes to correspond to the date you enter. Note that the hour value is shown in a 24-hour clock format. Time is represented as **hour : minute : second**.

```
Date (mm:dd:yy)      Sat, Jul 01 2006
Time (hh:mm:ss)     14 : 48 : 43
```

## IDE Channel and SATA Channel

Use these functions to detect and configure the individual IDE and SATA channels. Select a channel and press **Enter** to display the IDE/SATA sub-menu.

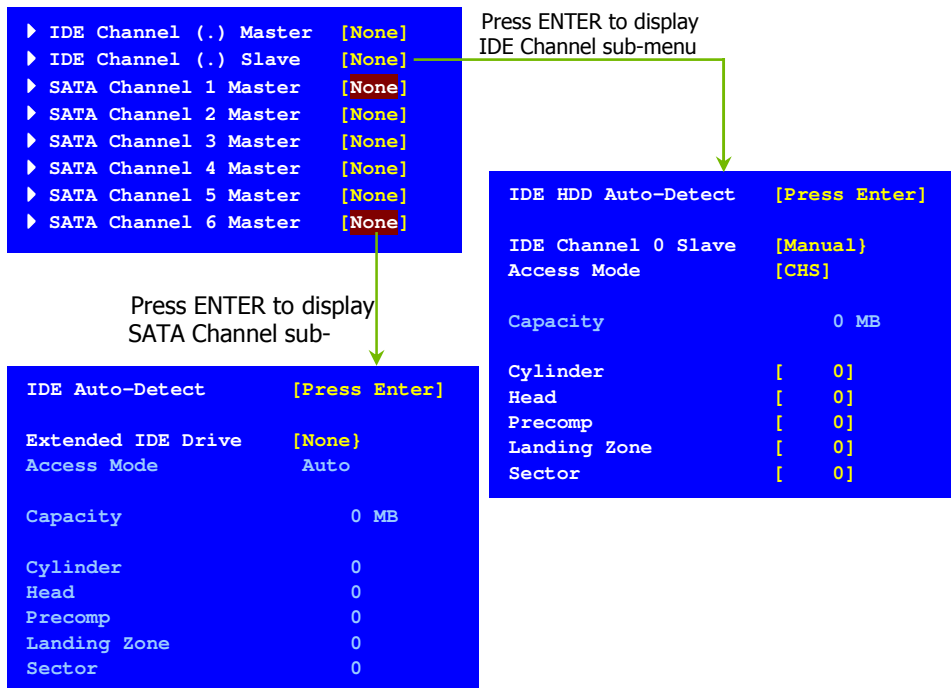

Press **Enter** to auto-detect IDE and SATA channels in the system. Once the channel is detected, the values for Capacity, Cylinder, Heads, Precomp, Landing Zone, and Sector are automatically filled in.

❑ **None**

There is no HDD installed or set.

❑ **Auto**

The system can auto-detect the hard disk when booting up.

❑ **Manual**

When you set the channel to **[Manual]** and change **Access Mode** to **[CHS]**, you can then enter the number of cylinders, heads, Precomp, landing zone, and sector. You can manually enter the values or you can press **Enter** to display a window that tells you the min and max values.

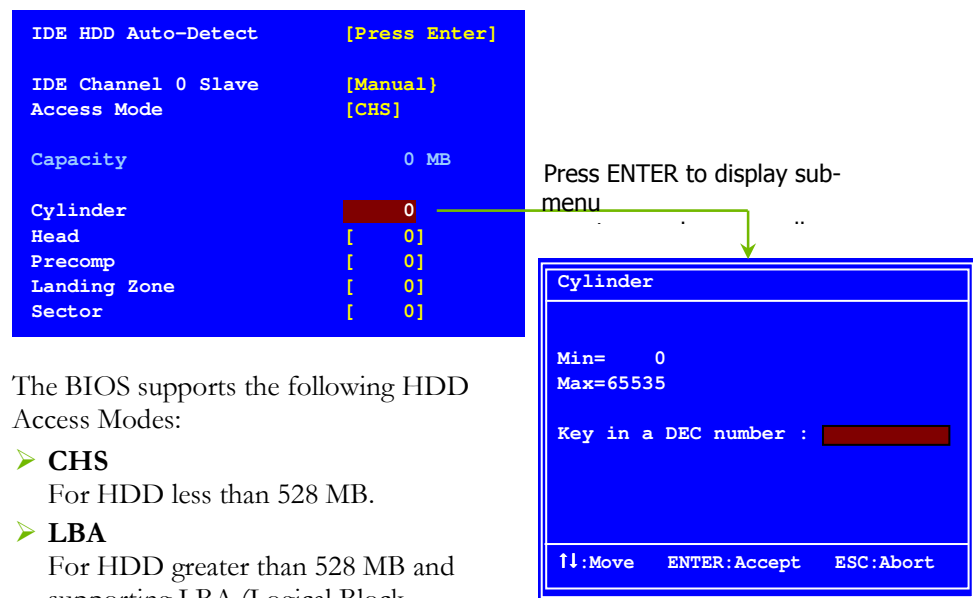

The BIOS supports the following HDD Access Modes:

➤ **CHS**

For HDD less than 528 MB.

➤ **LBA**

For HDD greater than 528 MB and supporting LBA (Logical Block Addressing).

➤ **Large**

For HDD greater than 528 MB but not supporting LBA.

➤ **Auto**

Recommended mode.

## Drive A

The **Drive A** option allows you to select the kind of FDD to install. Options are:

Drive A [1.44, 3.5 in.] Press ENTER to display sub-  
 Halt On [All, But Keyboard]

- None
- 360K, 5.25 in.
- 1.2M, 5.25 in.
- 720K, 3.5 in.
- 1.44M, 3.5 in.
- 2.88M, 3.5 in.

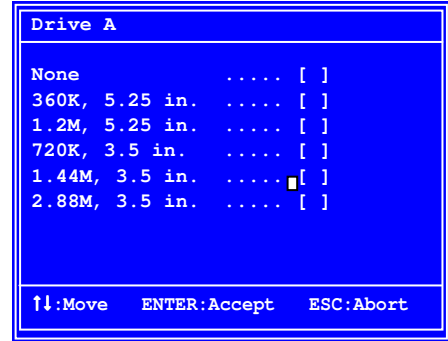

Use the **Page Up** and **Page Down** keys to scroll through the options or press **Enter** to display the sub-menu. Use the **↑↓** arrow keys to position the selector in the option you choose. Press **Enter** to accept the changes and return to the Standard CMOS Features menu.

## Halt On

**Halt On** determines whether or not the computer stops if an error is detected during power on. Use the **Page Up** and **Page Down** keys to scroll through the options or press **Enter** to display the **Halt On** sub-menu. Use the **↑↓** arrow keys to position the selector in the option you choose. Press **Enter** to accept the changes and return to the Standard CMOS Features menu.

Drive A [1.44, 3.5 in.] Press ENTER to display sub-menu  
 Halt On [All, But Keyboard]

- All Errors**  
Whenever the BIOS detects a nonfatal error, the system stops and prompts you.
- No Errors**  
System boot does not stop for any detected errors.

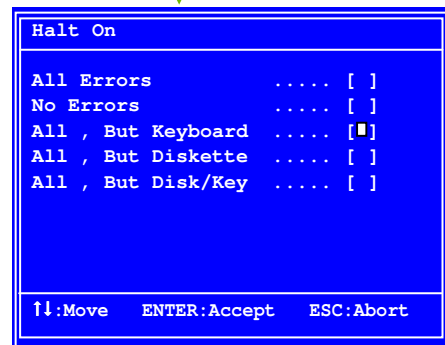

- ❑ **All, But Keyboard**  
System boot does not stop for keyboard errors, but does stop for all other errors.
- ❑ **All, But Diskette**  
The system boot does not stop for a diskette error but will stop for all other errors.
- ❑ **All, But Disk/Key**  
The system boot does not stop for a keyboard or disk error, but will stop for all other errors.

## Memory

These settings are *display-only values* that are determined by the BIOS POST (Power-On Self Test).

Base Memory	640K
Extended Memory	1047552K
Total Memory	1048576K

- ❑ **Base Memory**  
BIOS POST determines the amount of base (or conventional) memory installed in the system.
- ❑ **Extended Memory**  
BIOS determines how much extended memory is present during the POST.
- ❑ **Total Memory**  
This value represents the total memory of the system.

## Advanced BIOS Features

Access the Advanced BIOS Features menu from the CMOS Utility Setup screen. Use the **Page Up** and **Page Down** keys to scroll through the options or press **Enter** to display the sub-menu. Use the **↑↓** arrow keys to position the selector in the option you choose. To go back to the previous menu, press **Esc**.

**Note:** The options that have associated sub-menus are designated by a ▶, which precedes the option. Press **Enter** to display the sub-menus.

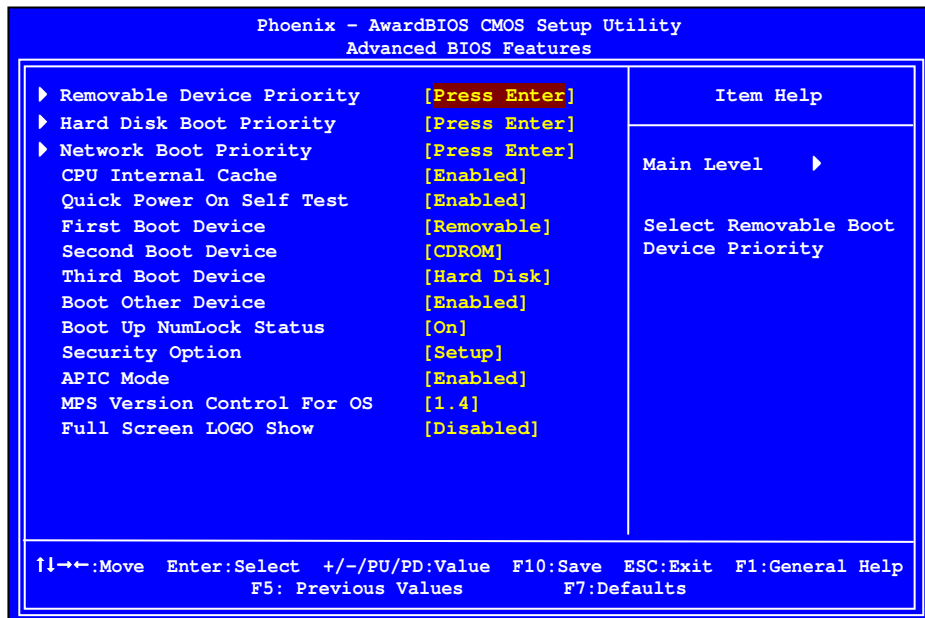

Figure 7. Advanced BIOS Features Menu

**Note:** Note that all data in **white** is for information only, data in **yellow** is changeable, data in **blue** is non-changeable, and data in a **red box** is highlighted for selection.

## Removable Device Priority

Use this option to select the priority for removable device startup. Press **Enter** to see the list of removable devices in your system. Use the **↑↓** arrow keys to go to the various devices. Then use the **+** or **-** keys to move the device priority up or down in the list. To go back to the previous menu, press **Esc**.

```
1. Floppy Disks
```

## Hard Disk Boot Priority

Use this option to select the priority for HDD startup. Press **Enter** to see the list of bootable devices in your system. Use the **↑↓** arrow keys to go to the various devices. Then use the **+** or **-** keys to move the device priority up or down in the list. To go back to the previous menu, press **Esc**.

```
1. Ch0. : ST3802110A
2. Bootable Add-in Cards
```

Use the **+** and **-** keys to move the priority of the device within

## Network Boot Priority

Use this option to select the priority for network startup. Select **Network Boot Priority** and press **Enter** to view available networks. Use the **↑↓** arrow keys to go to the various devices. Then use the **+** or **-** keys to move the device priority up or down in the list. To go back to the previous menu, press **Esc**.

```
1. Network 0 : <description of network>
2. Network 1 : <description of network>
```

## CPU Internal Cache

Use this option to enable or disable the CPU internal cache. Use the **Page Up** and **Page Down** keys to scroll through the options or press **Enter** to display the options in a sub-menu. Use the **↑↓** arrow keys to position the selector in the option you choose.

## Quick Power On Self Test

Enabling this option allows the system to skip certain test while booting, which reduces the time needed to boot the system. Use the **Page Up** and **Page Down** keys to toggle between **Enable** and **Disable**.

## First/Second/Third Boot Device

Use this option to set the priority sequence of the devices booted at power on. Use the **Page Up** and **Page Down** keys to scroll through the options or press **Enter** to display the sub-menu. Use the **↑↓** arrow keys to position the selector in the option you choose.

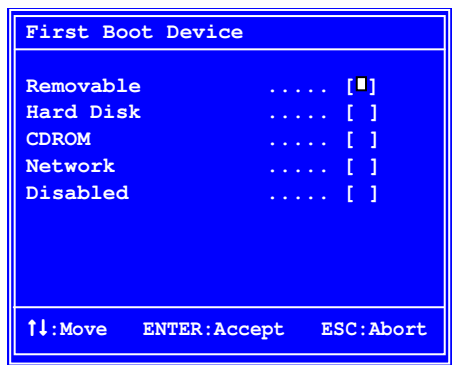

## Boot Other Device

With the option set to **Enable**, the system boots from some other device if the first/second/third boot devices fail.

## Boot Up NumLock Status

This option allows you to select the power-on state of **NumLock**. Select **On** to activate the keyboard **NumLock** when the system is started. Select **Off** to disable the **NumLock** key.



## Security Option

The Security Options allows you to require a password every time the system boots or only when you enter setup. Select **Setup** to require a password to gain access to the CMOS Setup screen. Select **System** to require a password to access the CMOS Setup screen and when the system boots.

## APIC Mode

Use this function to enable or disable the Advanced Programmable Interrupt Controller (APIC). If you disable this option, you also disable the MPS Version Control for OS option.

## MPS Version Control For OS

Use this function to select the Multi-Processor Specification (MPS) version that BIOS passes to the operating system. Use the **Page Up** and **Page Down** keys to scroll through the options.

## Full Screen LOGO Show

This option allows you to enable or disable the display of the full-screen logo when the system boots. Use the **Page Up** and **Page Down** keys to toggle between **Enable** and **Disable**

## Advanced Chipset Features

Select **Advanced Chipset Features** from the CMOS Setup Utility menu and press **Enter** to display the functions of the Advanced Chipset Functions menu.

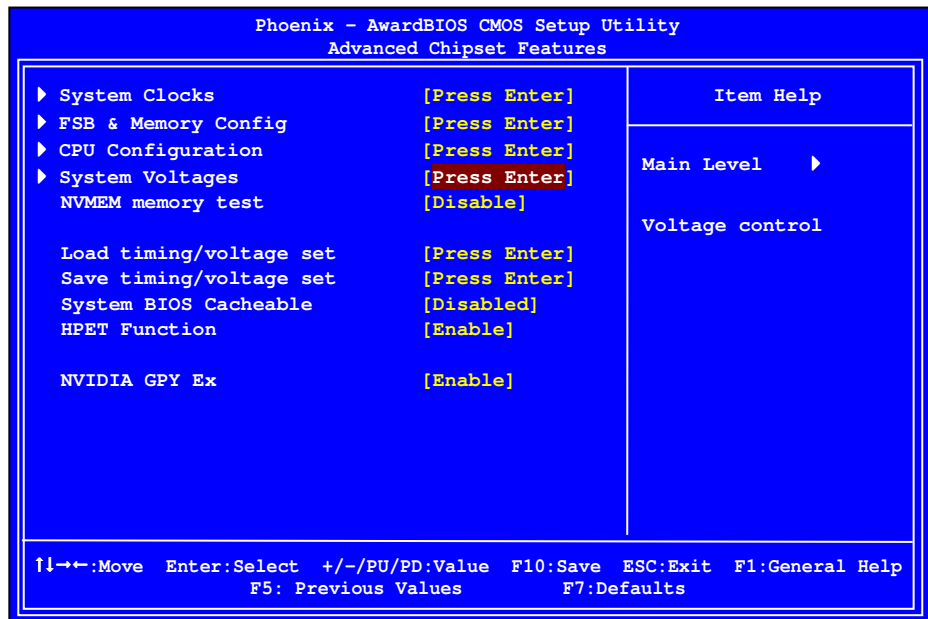

Figure 8. Advanced Chipset Features

## System Clocks

Select **System Clocks** from the Advanced Chipset Features menu and press **Enter** to display the System Clocks menu. From this menu, you are able to specify frequency settings, HT multipliers, and Spread Spectrum settings. Note that in Figure 9, all of the options are listed. On the actual BIOS screen, you will need to scroll down to see all the options.

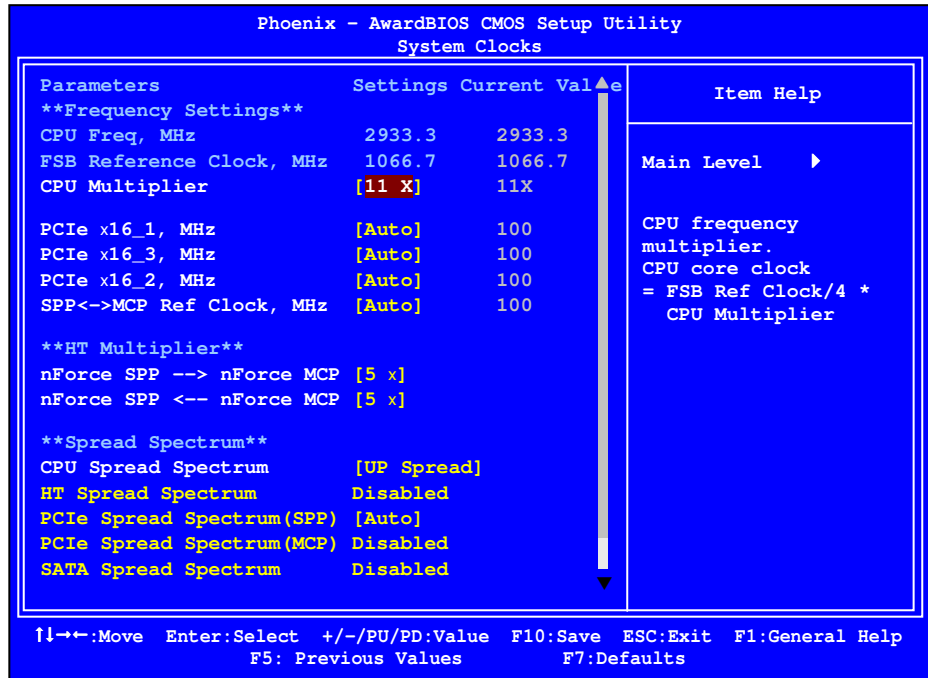

Figure 9. System Clocks Menu

**Note:** Note that all data in **white** is for information only, data in **yellow** is changeable, data in **blue** is non-changeable, and data in a **red box** is highlighted for selection.

## Frequency Settings

- ❑ **CPU Freq, MHz**  
This value is set by the CPU Multiplier (value cannot be changed by the user).
- ❑ **FSB Reference Clock, MHz**  
This value is set by the system (value cannot be changed by the user). To change the SLI-Ready memory, FSB memory, and memory timing, go to the FSB & Memory screen.
- ❑ **CPU Multiplier**  
This value changes the CPU Frequency value depending on the value you choose. Use the **Page Up** and **Page Down** keys to scroll through the options. The options are from 6 X through 60 X.
- ❑ **PCIe x16\_1, MHz**  
Use the **Page Up** and **Page Down** keys to scroll through the frequency options for the PCI Express Bus, Slot 1 (the black slot closest to the CPU). Note that as you go higher in value, **PCIe Spread Spectrum(SPP)** is disabled and cannot be changed from this status.
- ❑ **PCIe x16\_3, MHz**  
Use the **Page Up** and **Page Down** keys to scroll through the frequency options for the PCI Express Bus, Slot 3 (the blue slot in the middle).
- ❑ **PCIe x16\_2, MHz**  
Use the **Page Up** and **Page Down** keys to scroll through the frequency options for the PCI Express Bus, Slot 3 (the black slot farthest from the CPU).
- ❑ **SPP<->MCP Ref Clock, MHz**  
Use the **Page Up** and **Page Down** keys to scroll through the frequency options for the reference clock between the SPP chip and the MCP chip.

## HT Multiplier

- **nForce SPP → nForce MCP**  
Use the **Page Up** and **Page Down** keys to scroll through the HT multiplier options and set the link speed from the SPP chip to the MCP chip. Values are [1 x] through [5 x].
- **nForce MCP ← nForce SPP**  
Use the **Page Up** and **Page Down** keys to scroll through the HT multiplier options and set the link speed from the MCP chip to the SPP chip. Values are [1 x] through [5 x].

## Spread Spectrum

- **CPU Spread Spectrum**  
Use the **Page Up** and **Page Down** keys to scroll through the Spread Spectrum options for the CPU. Option values are [Disabled], [UP Spread], and [Center Spread].
- **HT Spread Spectrum**  
Disabled
- **PCIe Spread Spectrum (SPP)**  
Use the **Page Up** and **Page Down** keys to scroll through the Spread Spectrum options for the SPP PCIe. Option values are [Disabled], [UP Spread], and [Center Spread]. This option reverts to **Disabled** and cannot be changed when the value for PCIe x16\_1 exceeds 100MHz.
- **PCIe Spread Spectrum(MCP)**  
Disabled
- **SATA Spread Spectrum**  
Disabled

## FSB & Memory Config

Select **FSB & Memory Config** from the Advanced Chipset Features menu and press **Enter** to display the FSB & Memory Config menu. This menu provides the means to set SLI-Ready memory, FSB memory, and memory timing.

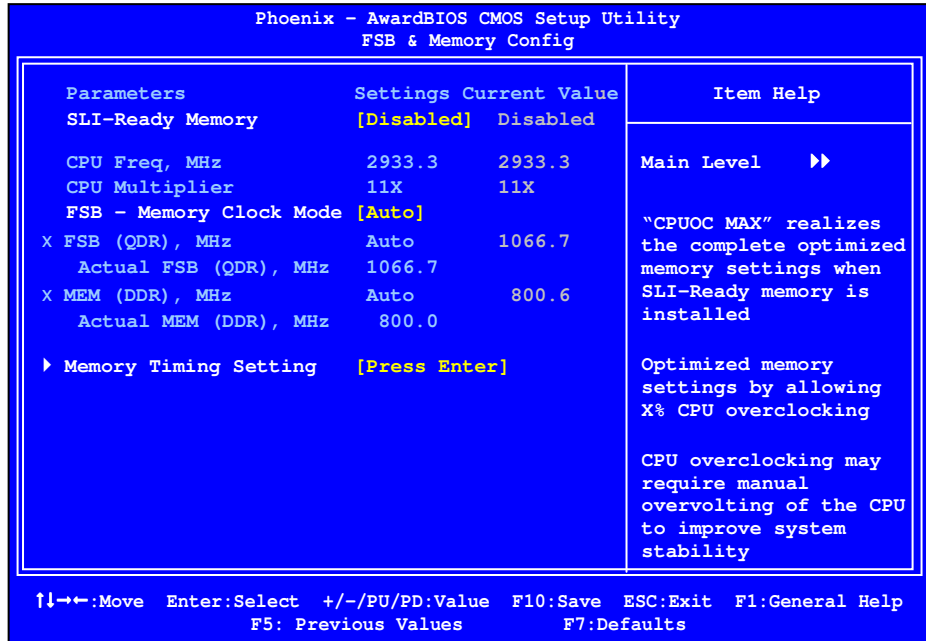

Figure 10. FSB & Memory Config Menu

### □ SLI-Ready Memory

Use the **Page Up** and **Page Down** keys to scroll through the SLI-Ready Memory options. The options are:

- Disabled
- CPUOC 0%
- CPUOC 1%
- CPUOC 2%
- CPUOC 3%

- CPUOC 4%
- CPUOC 5%
- CPUOC MAX

When you select one of the **CPUOC x%** options, the **FSB - Memory Clock Mode** is set to **Unlinked** and cannot be changed until **SLI-Ready Memory** is set to **Disable**.

□ **FSB and Memory Clock Mode**

Use the **Page Up** and **Page Down** keys to scroll through the FSB and Memory Clock Mode options. The options are:

➤ **Auto**

This is the optimal setting since it sets the FSB and memory speeds automatically.

➤ **Linked**

When **Link** is selected, **FSB (QDR), MHz** is changed to editable and the FSB speed can be entered manually. As the FSB speed is changed, **CPU Freq, MHz** changes proportionally.

CPU Freq, MHz	2933.3	2933.3
CPU Multiplier	11X	11X
FSB - Memory Clock Mode	[Linked]	
FSB (QDR), MHz	[1067]	1066.7
Actual FSB (QDR), MHz	1066.7	
X MEM (DDR), MHz	Auto	800.6
Actual MEM (DDR), MHz	800.0	

➤ **Unlinked**

When **Unlink** is selected, **FSB (QDR), MHz** and **MEM (DDR), MHz** are changed to editable and the FSB and memory speeds can be entered manually. As the FSB speed is changed, **CPU Freq, MHz** changes proportionally.

FSB - Memory Clock Mode	[Linked]	
FSB (QDR), MHz	[1067]	1066.7
Actual FSB (QDR), MHz	1066.7	
MEM (DDR), MHz	[1067]	800.6
Actual MEM (DDR), MHz	800.0	

❑ **FSB (QDR), MHz**

Use the **+** or **-** keys to scroll through new values for the CPU FSB frequency or type in a new value. Note that the **Actual FSB (QDR)** reflects the actual frequency that takes effect on a reboot.

❑ **MEM (DDR), MHz**

Use the **+** or **-** keys to scroll through new values for the memory frequency or type in a new value. Note that the **Actual MEM (DDR)** reflects the actual frequency that takes effect when the system reboots.

❑ **Memory Timing Setting**

Press **Enter** to display the Memory Timing Setting menu. Use this menu to set optimal timings or to manually enter timings.

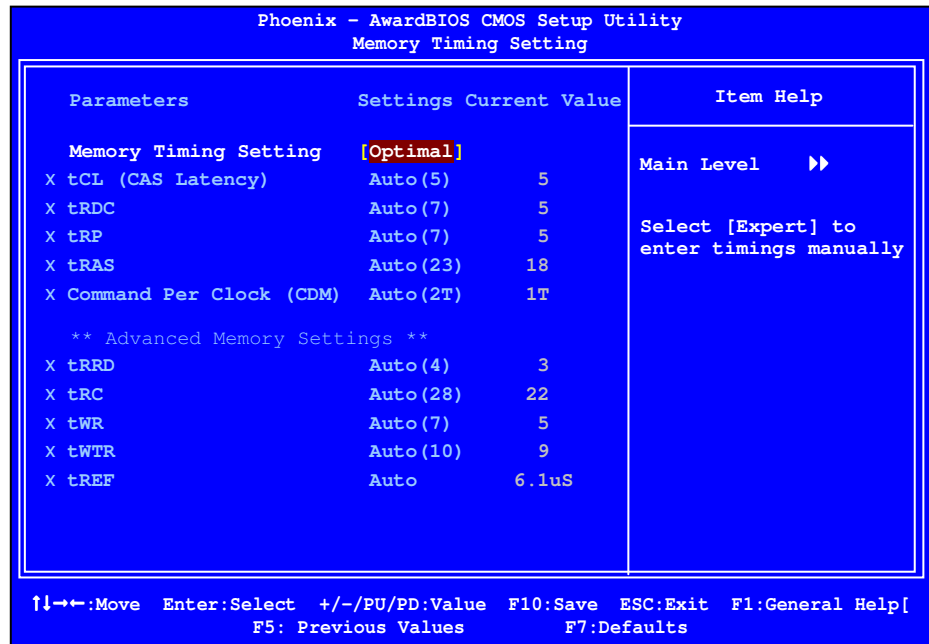

➤ **Optimal**

Use the **Page Up** and **Page Down** keys to select **Optimal**. Optimal prohibits you from manually setting any timing. All timing is set for optimal performance.



### ➤ Expert

Use the **Page Up** and **Page Down** keys to select **Expert**. When Expert is selected, all timing categories are enabled for manual input. Note that you should set the value to Optimal to use the manufacturers' recommended values.

Parameters	Settings	Current Value
Memory Timing Setting	[Expert]	
tCL (CAS Latency)	[Auto (5)]	5
tRDC	[Auto (7)]	5
tRP	[Auto (7)]	5
tRAS	[Auto (23)]	18
Command Per Clock (CDM)	[Auto (2T)]	1T
** Advanced Memory Settings **		
tRRD	[Auto (4)]	3
tRC	[Auto (28)]	22
tWR	[Auto (7)]	5
tWTR	[Auto (10)]	9
tREF	[Auto]	6.1uS

- ◆ **tCL**: CAS# latency (options are 1 through 6).
- ◆ **tRDC**: RAS#-to-CAS# Delay for Read/Write commands to the same bank (options are 1 through 7).
- ◆ **tRP**: Row Precharge time. This is the Precharge-to-Active or Auto-to-Refresh of the same bank (options are 1 through 7).
- ◆ **tRAS**: This is the minimum RAS# active time (options are 1 through 31).
- ◆ **Command Per Clock**: This is the command timing setting on a per clock unit basis (options are 1T and 2T).
- ◆ **tRRD**: RAS#-to-RAS# delay of different banks (options are 1 through 15).
- ◆ **tRC**: RAS#-to-RAS# or auto refresh time of the same bank (options are 1 through 31).
- ◆ **tWR**: The Write recovery time (options are 2 through 7).
- ◆ **tWTR**: This is the minimum write-to-read delay with the same chip selected (options are 1 through 10).
- ◆ **tREF**: This is the DRAM refresh rate (options are **Auto**, **7.8uS**, and **3.9uS**).

## CPU Configuration

Select **CPU Configuration** from the Advanced Chipset Features menu and press **Enter** to display the CPU Configuration menu.

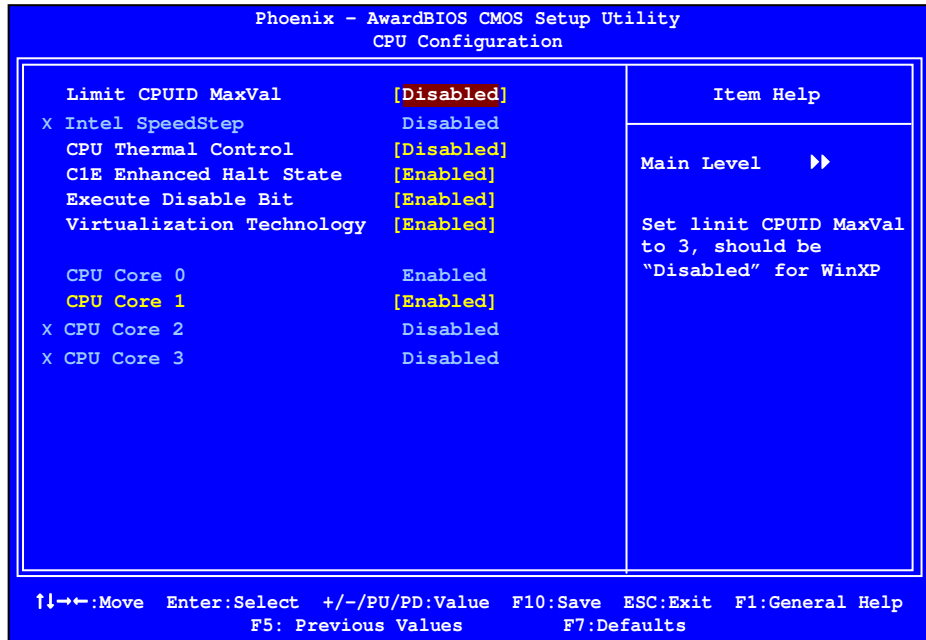

Figure 11. CPU Configuration Menu

- ❑ **Limit CPUID MaxVal**  
Use this function to enable the set limit of the CPUID MaxVal to 3. Set to Disable for Win XP.
- ❑ **CPU Thermal Control**  
Use this function to enable or disable TM1 and TM2 support. Options are:
  - **Disable**  
Disable support for TM1 and TM2.
  - **TM1 Only**  
The CPU is thermally throttled by cutting active processor clock cycles.

- **TM2 Only**  
Thermal throttling is achieved by reducing the CPU multiplier and CPU core voltage.
- **TM1 & TM2**  
Enables support for both TM1 and TM2.
- ❑ **C1E Enhanced Halt State**  
Enabled, this function reduces the CPU power consumption when the CPU is idle. Idle occurs when the operating system issues a halt instruction.
- ❑ **Execute Disable Bit**  
When this function is disabled, it forces the XD feature flag to always return to zero (0).
- ❑ **Virtualization Technology**  
When this function is enabled, it allows a VMM to utilize the additional hardware capabilities provided by Intel Virtualization Technology.
- ❑ **CPU Core 1**  
This function allows you to enable or disable CPU Core.

## System Voltages

Select **System Voltages** from the Advanced Chipset Features menu and press **Enter** to display the System Voltages menu.

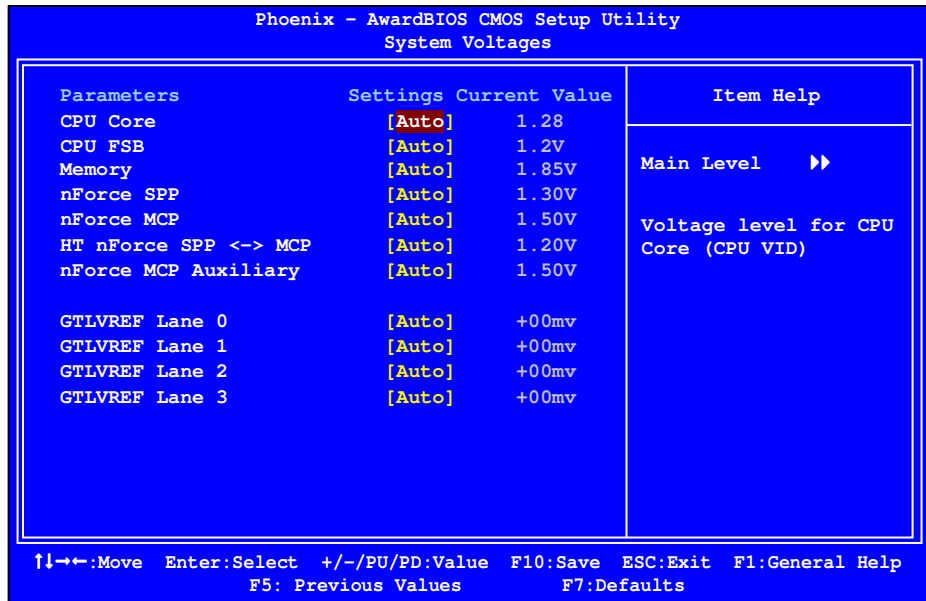

Figure 12. System Voltages Menu

- **CPU Core**  
Use the **Page Up** and **Page Down** keys to scroll through the voltages or select **[Auto]** to automatically set the voltage level for the CPU Core.
- **CPU FSB**  
Use the **Page Up** and **Page Down** keys to scroll through the voltages or select **[Auto]** to automatically set the voltage level for the CPU FSB.
- **Memory**  
This function defines the voltage level for the DRAM. Use the **Page Up** and **Page Down** keys to select a voltage or select **[Auto]** to automatically set the voltage.

- ❑ **nForce SPP**  
This function defines the core voltage level for the NVIDIA nForce SPP chip. Use the **Page Up** and **Page Down** keys to select a voltage (1.20V, 1.30V, 1.40V, 1.50V) or select **[Auto]** to automatically set the voltage.
- ❑ **nForce MCP**  
This function defines the core voltage level for the NVIDIA nForce MCP chip. Use the **Page Up** and **Page Down** keys to select a voltage or select **[Auto]** to automatically set the voltage.
- ❑ **HT nForce SPP <-> MCP**  
This function defines the voltage level for the NVIDIA HT nForce SPP <-> MCP Link. Use the **Page Up** and **Page Down** keys to select a voltage or select **[Auto]** to automatically set the voltage.
- ❑ **nForce MCP Auxiliary**  
This function defines the core voltage level for the NVIDIA nForce MCP Auxiliary voltage. Use the **Page Up** and **Page Down** keys to select a voltage or select **[Auto]** to automatically set the voltage.
- ❑ **GTLVREF Lane 0**  
This function defines the voltage level for GTLVREF Lane 0. Use the **Page Up** and **Page Down** keys to select a voltage or select **[Auto]** to automatically set the voltage.
- ❑ **GTLVREF Lane 1**  
This function defines the voltage level for GTLVREF Lane 1. Use the **Page Up** and **Page Down** keys to select a voltage or select **[Auto]** to automatically set the voltage.
- ❑ **GTLVREF Lane 2**  
This function defines the voltage level for GTLVREF Lane 2. Use the **Page Up** and **Page Down** keys to select a voltage or select **[Auto]** to automatically set the voltage.
- ❑ **GTLVREF Lane 3**  
This function defines the voltage level for GTLVREF Lane 3. Use the **Page Up** and **Page Down** keys to select a voltage or select **[Auto]** to automatically set the voltage.

## NVMEM Memory Test

This function defines whether you run the NVIDIA memory testing module during POST. The options are Fast, Medium, Slow, and Disable.

## Load Timing/Voltage Set

This function loads the system voltages and timing settings that were defined in the System Voltages menu. You can set up to four profile settings using the **Save timing/voltage set** function.

There are four profile options that can be loaded. The default setting is **Auto** for all settings. Press **Enter** to see the options.

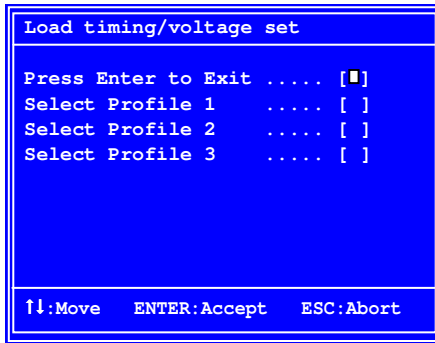

## Save Timing/Voltage Set

This function saves the system voltages and timing settings that were defined in the System Voltages menu. There are four profile options that can be loaded. The default setting is **Auto** for all settings. Press **Enter** to see the options.

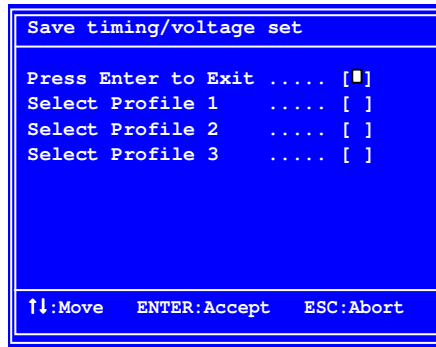

## System BIOS Cacheable

This function allows you to enable or disable caching the system BIOS.

## HPET Function

This function allows you to enable or disable the High Precision Even Timer (HPET). When **Enabled**, HPET is used as the timing hardware for multimedia and other time-sensitive application. When HPET is **Disabled**, the APIC timer is used.

## NVIDIA GPU Ex

To enable or disable this function you need to have the NVIDIA® ForceWare® graphics driver with NVIDIA EX support. When enabled, the system uses the optimized NVIDIA EX graphics driver.

## Integrated Peripherals Menu

Select **Integrated Peripherals** from the CMOS Setup Utility menu and press **Enter** to display the Integrated Peripherals menu.

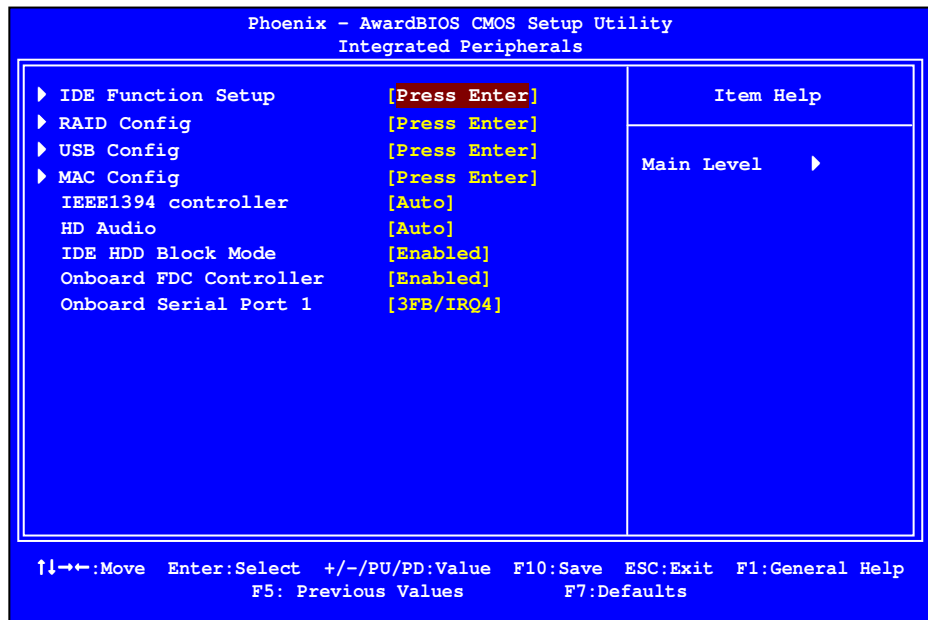

Figure 13. Integrated Peripherals Menu



## IDE Function Setup

Press **Enter** to display the IDE Function Setup menu.

OnChip IDE Channel0	[Enabled]
Primary Master PIO	[Auto]
Primary Slave PIO	[Auto]
Primary Master UDMA	[Auto]
Primary Slave UDMA	[Auto]
IDE DMA transfer access	[Enabled]
Serial-ATA Controller	[All Enabled]
IDE Prefetch Mode	[Enabled]

### ❑ OnChip IDE Channel0

Use this function to enable or disable the onchip IDE Channel0. When disabled, the Primary Master/Slave functions are changed to **Auto** and cannot be changed.

OnChip IDE Channel0	[Disabled]
× Primary Master PIO	Auto
× Primary Slave PIO	Auto
× Primary Master UDMA	Auto
× Primary Slave UDMA	Auto
IDE DMA transfer access	[Enabled]
Serial-ATA Controller	[All Enabled]
IDE Prefetch Mode	[Enabled]

### ❑ Primary Master/Slave PIO

When **OnChip IDE Channel0** is set to **[Enabled]**, you can select a mode for the primary Master and Slave PIO. Select from **Auto**, or **Mode 1** through **Mode 4**.

### ❑ Primary Master/Slave UDMA

When **OnChip IDE Channel0** is set to **[Enabled]**, you can disable the primary Master and Slave UDMA or set it to **[Auto]**.

### ❑ IDE DMA transfer access

Use this function to enable or disable IDE DMA transfer access.

### ❑ Serial-ATA Controller

This function allows you to enable specific SATA controllers, enable all controllers, or disable all controllers. The options available are **[SATA-0]**, **[SATA-0+1]**, **[Enable All]**, and **[Disabled]**.

### ❑ IDE Prefetch Mode

Use this function to enable or disable the IDE Prefetch mode.

## RAID Config

Press **Enter** to display the RAID Config menu.

RAID Enable		[Enabled]
SATA 0 Primary	RAID	[Disabled]
SATA 0 Secondary	RAID	[Disabled]
SATA 1 Primary	RAID	[Disabled]
SATA 1 Secondary	RAID	[Disabled]
SATA 2 Primary	RAID	[Disabled]
SATA 2 Secondary	RAID	[Disabled]

### ❑ RAID Enable

Use this function to enable or disable RAID. When RAID is set to **[Disabled]**, all SATA functions are changed to **Disabled** and cannot be changed.

RAID Enable		[Disabled]
x SATA 0 Primary	RAID	Disabled
x SATA 0 Secondary	RAID	Disabled
x SATA 1 Primary	RAID	Disabled
x SATA 1 Secondary	RAID	Disabled
x SATA 2 Primary	RAID	Disabled
x SATA 2 Secondary	RAID	Disabled

### ❑ SATA x Primary/Secondary

When **RAID Enable** is set to **[Enabled]**, you can enable or disable the various SATA functions.

## USB Config

Press **Enter** to display the USB Config menu.

OnChip USB		[Enabled]
USB Keyboard Support		[Disabled]
USB Mouse Support		[Disabled]

### ❑ OnChip USB

Use this function to enable specific versions of the USB or disable the onchip USB. When the onchip USB is set to **[Disabled]**, the keyboard and mouse support functions are set to **Enabled** and cannot be changed. Versions that can be selected are **[V1.1+V2.0]** or **[V1.1]**.

OnChip USB		[Disabled]
x USB Keyboard Support		Enabled
x USB Mouse Support		Enabled

### ❑ USB Keyboard/Mouse Support

Use these function to enable or disable the onchip WSB support of the keyboard and/or mouse.

## MAC Config

Press **Enter** to display the MAC Config menu.

MAC0 LAN	[Enabled]
MAC1 LAN	[Disabled]

### ❑ MACx LAN

Use these functions to set the MAC0 and/or MAC1 LANs to **Auto** or disable their functions.

## IEEE1394 controller

This function on the Integrated Peripherals menu allows you to enable or disable the IEEE1394 (Firewire) interface.

## HD Audio

This function on the Integrated Peripherals menu allows you to enable or disable the hard disk audio function.

## IDE HDD Block Mode

Using this function on the Integrated Peripherals menu allows your IDE hard drive needs to support block mode. Select **[Enabled]** to automatically detect the optimal number of block read/writes per sector the drive can support. Select **[Disabled]** if your drive does not support block mode.

## Onboard FDC Controller

This function on the Integrated Peripherals menu allows you to enable or disable the onboard FDC controller function.

## Onboard Serial Port 1

This function on the Integrated Peripherals menu allows you to select the onboard serial port 1 function. Options are [3F8/IRQ4], [2E8/IRQ3], [3E8/IRQ4], [Auto], and [Disabled].

## Power Management Setup Menu

Select **Power Management Setup** from the CMOS Setup Utility menu and press **Enter** to display the Power Management Setup menu.

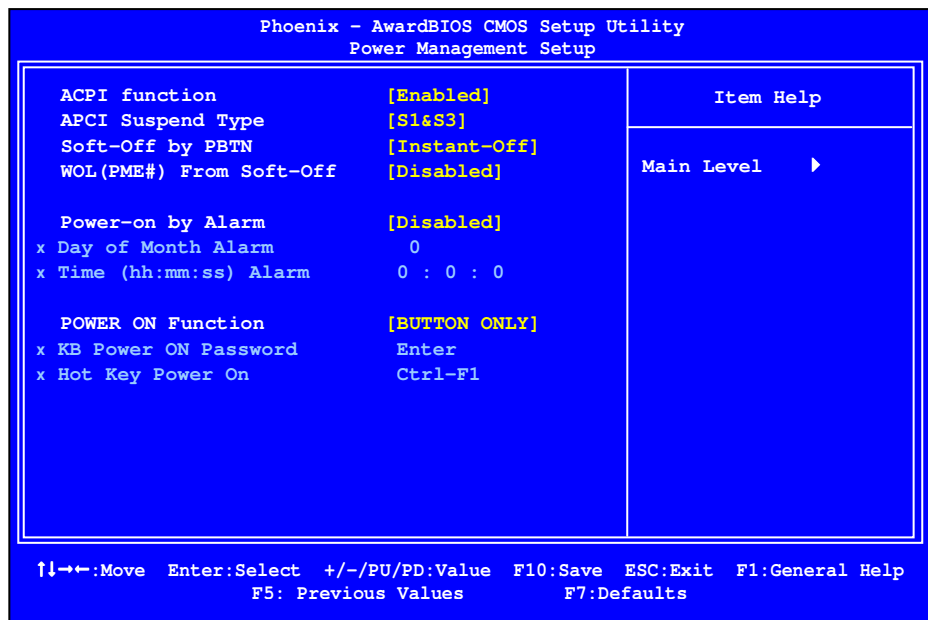

Figure 14. Power Management Setup Menu

## ACPI Function

This function on the Power Management Setup menu allows you to enable or disable the ACPI function.

## ACPI Suspend Type

This function on the Power Management Setup menu allows you to select an ACPI Suspend Type. Types to select from are **[S1&S3]**, **[S1 (POS)]**, and **[S3 (STR)]**.

## Soft-Off by PBNT

This function on the Power Management Setup menu allows you to set Soft-Off by PBNT to **[Instant-Off]** or **[Delay 4 Sec]**.

## WOL(PME#) From Soft-Off

This function on the Power Management Setup menu allows you to enable or disable WOL(PME#) from soft-off.

## Power On by Alarm

This function on the Power Management Setup menu allows you to enable or disable the Power-on by alarm function. Set to **[Disable]** to prevent power-on by alarm. When set to **[Enable]**, you can manually put in the day of the month and the time of the alarm.

```
Power-on by Alarm      [Disabled]
Day of Month Alarm    [ 0]
Time (hh:mm:ss) Alarm [0 : 0 : 0]
```

To enter a day or time, use the **Page Up** and **Page Down** keys to scroll through numbers or enter the number using the keyboard number or the **+** and **-** keys.

## POWER ON Function

This function on the Power Management Setup menu allows you to define the power-on function. Options for this function are:

- BUTTON ONLY**
- Keyboard 98**
- Password**

When **[Password]** is selected, the **KB Power ON Password** function is enabled so that you must enter a password.

POWER ON Function	<b>[Password]</b>
KB Power ON Password	<b>[Enter]</b>
x Hot Key Power On	<b>Ctrl-F1</b>

- 
- Hot Key Power On**

When **[Hot Key]** is selected, the **Hot key Power On function** is enabled so that you must select a keyboard key as the hot key. To select a hot key use **Ctrl+F1** though **Ctrl+F12**

POWER ON Function	<b>[Hot key]</b>
x KB Power ON Password	<b>Enter</b>
Hot Key Power On	<b>[Ctrl-F1]</b>

- Mouse Left**
- Mouse Right**
- Any Key**

## PnP/PCI Configuration Menu

Select **PnP/PCI Configuration** from the CMOS Setup Utility menu and press **Enter** to display the PnP/PCI Configuration menu.

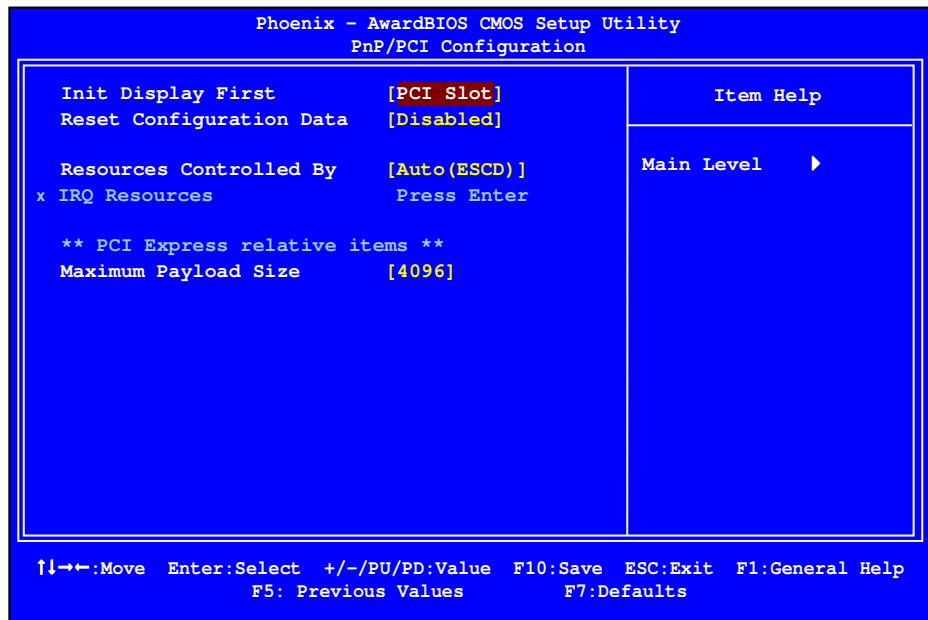

Figure 15. PnP/PCI Configuration Menu

### Init Display First

This function on the PnP/PCI Configuration menu allows you to define if the initial display is in the PCI slot or in the PCI Express slot. Options are **[PCI Slot]** and **[PCIEx]**.

## Reset Configuration Data

This function on the PnP/PCI Configuration menu allows you to enable or disable the resetting of Extended System Configuration Data (ESCD) when you exit Setup. Set this to **[Enabled]** if you have installed a new add-on and the system reconfiguration has caused a serious conflict that prevents the OS from booting. The default setting is **[Disabled]**.

## Resources Controlled By

This function on the PnP/PCI Configuration menu allows you to define if the BIOS can automatically configure all the boot and plug-and-play compatible devices or if you can manually select IRQ, DMA, and memory base address fields. Select **[Auto (ESCD) ]** if you want the BIOS to automatically populate these fields. If you select **[Manual]** so you can assign the resources, **IRQ Resources** is enabled for input.

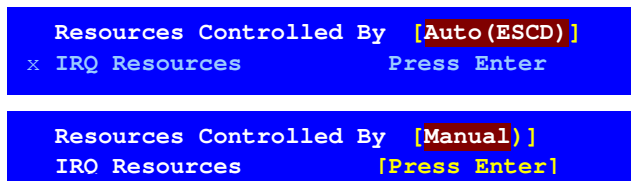



## IRQ Resources

To enable this field for input, set **Resources Controlled By** to **[Manual]**. With this field enabled, press **Enter** to see options.

```
IRQ-5 assigned to [PCI Device]
IRQ-9 assigned to [Reserved]
IRQ-10 assigned to [PCI Device]
IRQ-11 assigned to [PCI Device]
IRQ-14 assigned to [PCI Device]
IRQ-15 assigned to [PCI Device]
```

Use Legacy ISA for devices compliant with the original PC AT Bus specification. Use PCI/ISA PnP for devices compliant with the plug-and-play standard, whether designed for PCI or ISA Bus architecture.

## PCI/VGA Palette Snoop

This function on the PnP/PCI Configuration menu allows you to enable or disable the Palette Snoop function.

## Maximum Payload Size

This function on the PnP/PCI Configuration menu allows you to set the maximum TLP payload size (in bytes) for the PCI Express devices. Use the **Page Up** and **Page Down** keys to scroll through sizes or enter the number using the keyboard numbers or use the **+** and **-** keys to go up and down the list of sizes.

## System Monitor Menu

Select **System Monitor** from the CMOS Setup Utility menu and press **Enter** to display the System Monitor menu.

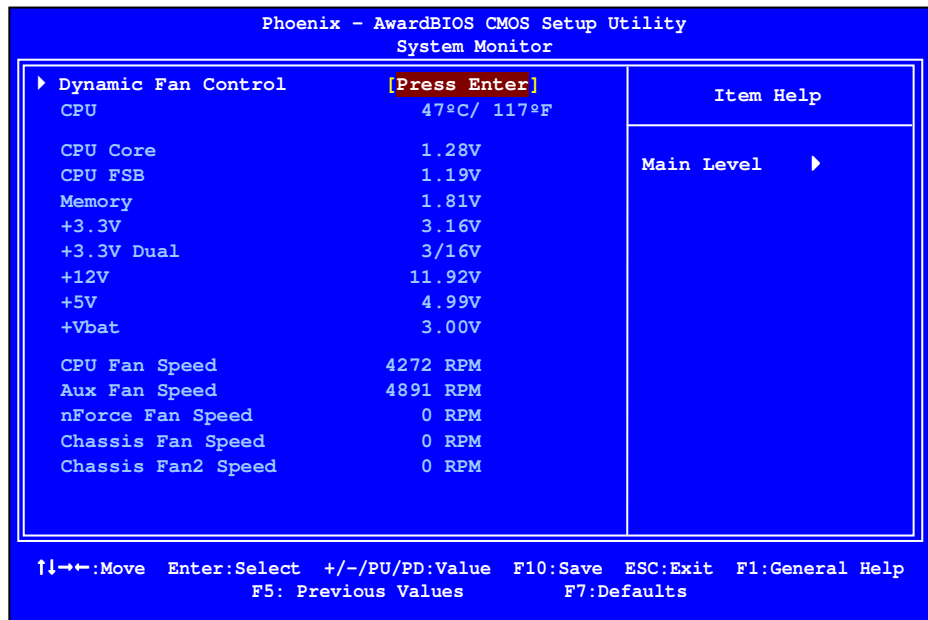

Figure 16. System Monitor Menu

All of the values shown in **Blue** are dynamic and change as the speed and voltages of the various components change with system usage.

## Dynamic Fan Control

Press **Enter** to display the Dynamic Fan Control menu.

```
CPU Fan Speed Control      [SmartFan]
If temp > 70°C, Set Fan Speed 100%
If temp < 30°C, Set Fan Speed  0%
x Manual Fan Speed, %      100

AUX Fan Speed Control, %  [100]
nForce Fan Speed Control, % [100]
Chassis Fan Speed Control, % [100]
```

Use this menu to control the speed of the various fans on the motherboard. Set CPU fan speed to **[SmartFan]** when you want the speed of the fans automatically controlled based on temperature. To set the fan speed to a constant rate, select **[Manual]** and then enter the speed from 0% to 100%.

Set the desired speed for the Aux, nForce, and Chassis fans from 0% to 100%. The system defaults to 100%.

*This page is blank.*

# Installing Drivers and Software

**Note:** It is important to remember that *before* installing the driver CD that is shipped in the kit, you need to load your operating system. The motherboard supports Windows XP 32bit and 64bit and is Vista-capable.

The kit comes with a CD that contains utility drivers and additional NVIDIA software.

The CD that has been shipped with your XFX motherboard contains the following software and drivers:

- ❑ NVIDIA nForce drivers
- ❑ RealTek Audio drivers
- ❑ Microsoft DirectX 9.0C
- ❑ NVIDIA Control Panel
- ❑ Adobe Acrobat Reader
- ❑ NVIDIA MediaShield RAID Manager
- ❑ NVIDIA Networking (FirstPacket)
- ❑ NVIDIA System Monitor

---

## Windows XP Drivers Install

**Note:** When installing the graphics drivers, the resolution defaults to the lowest setting (typically 800 x 600), making your display very large. Adjust accordingly.

3. Insert the XFX nForce 790i Ultra SLI installation CD for the graphics drivers included in the kit.

**Note:** If you have multiple graphics cards installed, you will be asked multiple times for all events once the drivers are installed.

4. Run **setup.exe**.

Depending on your system setup, the install disk may automatically run the install **setp.exe**. If it does not run, go to My Computer and click on the CD to open.

# Using the NVIDIA Software

Built upon the foundation of NVIDIA's core motherboard and GPU technologies, NVIDIA System Monitor and Performance Server software utilities bring consolidated reporting and control to the desktop in seamless fashion. Traditionally, users have been forced to endure a sequence of trial and error attempts within the BIOS in order to customize the operation and performance of the system to their needs. As settings are attempted, the user must start and restart Windows several times. Fortunately, NVIDIA's new System Monitor and Performance Group utilities bring the same rich functionality found in the BIOS to the user's desktop. From a single convenient interface, the user can adjust settings to minimize noise, optimize performance, and maximize system stability. In addition, a wealth of system information is readily available in a lush 3D presentation which is customizable to suit the user.

---

## NVIDIA Performance Group of NVIDIA Control Panel

You can start the NVIDIA Performance Group several ways:

- ❑ Double-click the **NVIDIA Performance Group** icon on the desktop
- ❑ Right-click on the desktop and select **NVIDIA Control Panel**
- ❑ From the Windows Control Panel, double-click the **NVIDIA Control Panel**

NVIDIA Performance Server menus are located under the **Performance** group in the left column.

**Note** All changes made within NVIDIA Performance Group are dynamically applied, and will only remain active for the *current* Windows session. You can save these settings as a profile by using the **Profile** menu item.



**CAUTION:** Increasing the voltage or the clock speed of a component may void its warranty due to exceeding recommended specifications. XFX and the board manufacturer are **not** responsible for damage that may occur when component tolerances are exceeded.

Historically, NVIDIA's Control Panel has contained a wealth of settings and adjustments for NVIDIA based components. In similar fashion, the new NVIDIA Performance Group applies the same depth of control to the rest of the components within a system. Without ever leaving Windows or entering the BIOS, users can optimize and adjust nearly every system component.



## Device Settings

Device Settings has two tabs, **Current Hardware Settings** and **Hardware Profiles**. Under the **Current Hardware Settings** tab there are settings for the CPU, Motherboard, Memory, and GPU.

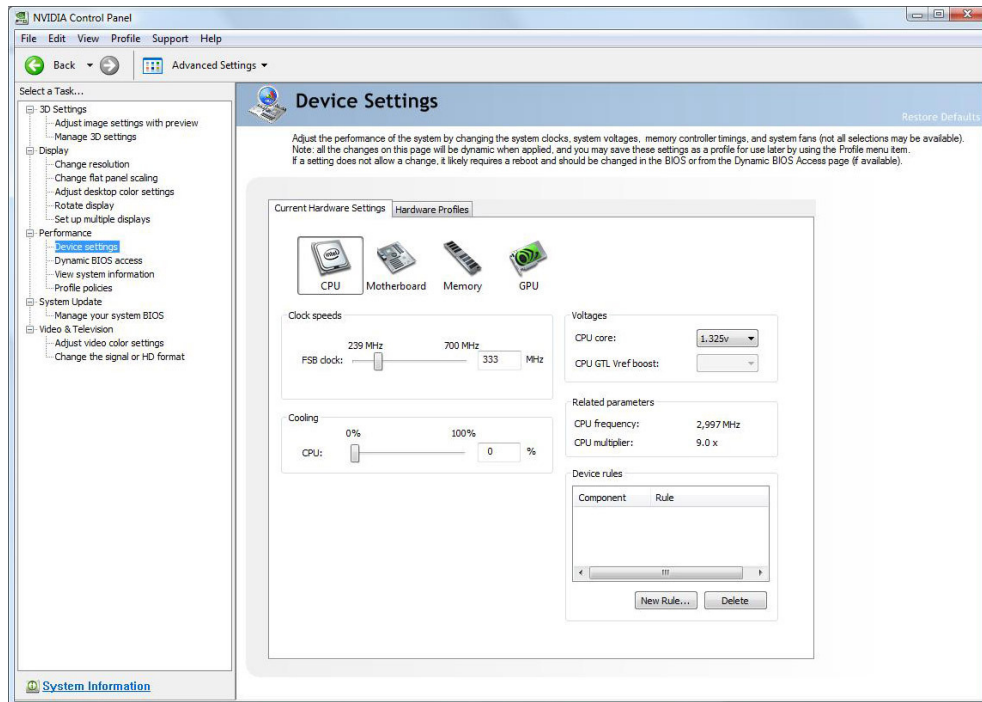

## Current Hardware Settings

### CPU

This option deals with CPU parameters and information. Here, the user has the ability to dynamically change FSB speeds, CPU Voltages, and CPU fan speeds. At all times, real-time values for CPU frequency and appropriate CPU multiplier are reported.



**CAUTION:** Increasing the voltage or the clock speed of a component may void its warranty due to exceeding recommended specifications. XFX and the board manufacturer are not responsible for damage that may occur when component tolerances are exceeded.

Current Hardware Settings Hardware Profiles

CPU Motherboard Memory GPU

Clock speeds

FSB clock: 239 MHz 700 MHz 333 MHz

Cooling

CPU: 0% 100% 0 %

Voltages

CPU core: 1.325v

CPU GTL Vref boost:

Related parameters

CPU frequency: 2,997 MHz

CPU multiplier: 9.0 x

Device rules

Component	Rule
-----------	------

New Rule... Delete

## Motherboard

The **Motherboard** option showcases a wide variety of motherboard and system-wide options and settings. The controls located in the Adjust Motherboard Timings screen allow the bus speeds to be adjusted manually to increase performance for gaming, or lower performance to conserve power and create a quieter user environment. The number to the right of the slider is the new bus speed that will be applied. Adjustments can be made by using the mouse to drag the slider. All changes will take effect immediately after selecting Apply; however, these setting will only remain active for the current Windows session. This will allow a user to safely return to Windows in the event of a crash, without any possibility of boot issues since the changes are not made directly to the BIOS settings.

**Note:** All changes on **Adjust Motherboard Settings** are dynamically made when you apply them, and only remain active for the current Windows session. You can save these settings as a profile for use later by using the **Profile** menu item. If a setting does not allow a change, it probably requires a reboot and should be changed in the BIOS or from the **Dynamic BIOS Access** page (if available).

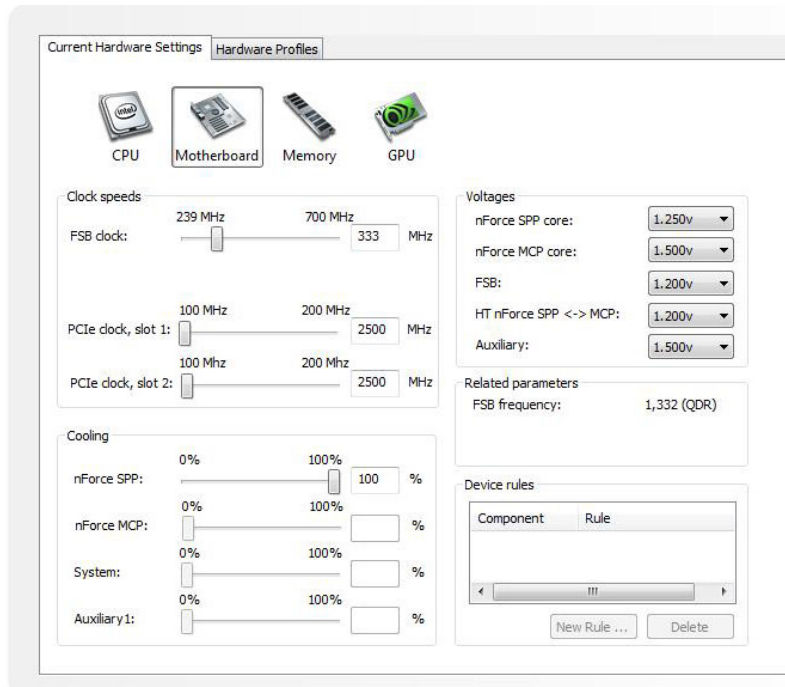

## Memory

Memory is one of the most critical components in terms of determining overall system stability and overclocking success, a wealth of information and options for memory modules is available. Both timings and voltage are dynamically adjustable, with real-time values for memory frequency, FSB frequency, and more being viewable to help dictate which settings are most appropriate.

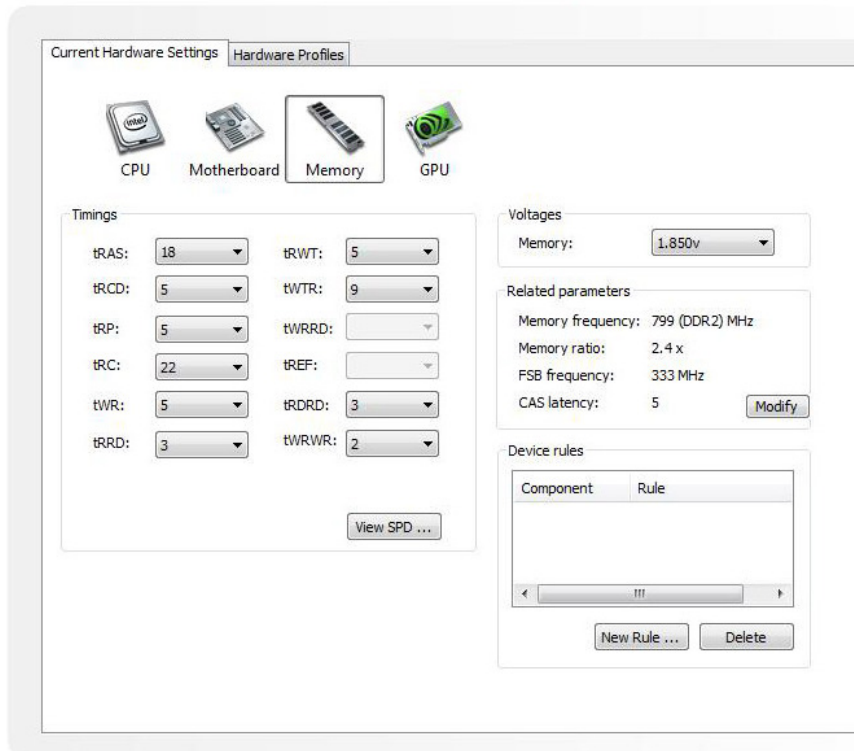

### □ Row Address Strobe

Adjusts the minimum RAS active time. This is the amount of time between a row being activated by Precharge and deactivated. A row cannot be deactivated until tRAS has completed. The lower this value, the faster the performance. However, if it is set too low it can cause data corruption by deactivating the row too soon. Adjustable from 1 to 63.

- ❑ **Write Recovery Time**  
Memory timing that determines the delay between a write command and a Precharge command is set to the same bank of memory. Adjustable from 1 to 15.
- ❑ **W to R Termination Turnaround**  
The Write-to-Read time is the number of clock cycles between the last write data pair and the subsequent READ command to the same physical block. Adjustable from 1 to 15.
- ❑ **RAS to CAS access**  
The RAS-to-CAS access (tRCD) is the amount of time in cycles for issuing an active command and the read/write commands. Adjustable from 1 to 15.
- ❑ **RAS to RAS Delay**  
The RAS-to-RAS delay (tRRD) is the is the amount of cycles it takes to activate the next bank of memory (this is the opposite of tRAS). The lower the timing the better the system performance. However, this scenario can cause instability. Adjustable from 1 to 15.
- ❑ **Refresh Rate**  
This value is filled in by the system and can not be changed by the user.
- ❑ **Memory bank switch**  
The row Precharge time (tRP) is the minimum time between active commands and the read/writes of the next bank on the memory module. Adjustable from 1 to 15.
- ❑ **R to W Turnaround**  
The Read-to-Write turnaround (tRWT) is a the amount of cycles for the command to be executed when a Write command is received. Adjustable from 1 to 15.
- ❑ **R to R Timing**  
the Read-to-Read time (tRDRD) is the number of clock cycles between the last read and the subsequent READ command to the same physical bank. Adjustable from 1 to 15.
- ❑ **Row Cycle Time**  
The Row Cycle Time is the minimum time in cycles it take a row to complete a full cycle. This can be determined by  $tRC=tRAS+tRP$ . If this value is set too short, it can cause corruption of data. If this value is set too high, it causes a loss in performance but an increase in stability. Adjustable from 1 to 63 cycles

- ❑ **W to R Command Delay**

The Write-to-Read (tWRD) command delay is the amount of cycles required between a valid write command and the next read command. A lower cycle time results in better performance but is can instability. Adjustable from 0 to 6 cycles.
- ❑ **W to W Timing**

The Write-to-Write (tWRWR) timing is the number of clock cycles between the last write and the subsequent Write command to the same physical bank. Adjustable from 2 to 15 cycles.
- ❑ **CAS Latency**

The CAS Latency (tCL) is the time (in number of clock cycles) that elapses after the memory controller sends a request to read a memory location and before the data is sent to the module's output pins. The value shown cannot be changed.
- ❑ **Clock Drive Strength**

This value is filled in by the system and can not be changed by the user.
- ❑ **Command Per Clock**

The Command Per Clock (tCPC) sets the Command Rate for the memory controller. The value shown cannot be changed
- ❑ **Async Latency**

This value is filled in by the system and can not be changed by the user.

## GPU

The graphics processing unit (GPU) located on your video card(s) can be adjusted using **Device Setting** interface. You can override the shipped clock frequencies of your GPU and GPU memory, and you can set the GPU fan speed. Increasing the clock speeds will increase your GPU performance but may necessitate improved cooling to maintain the same level of reliability.

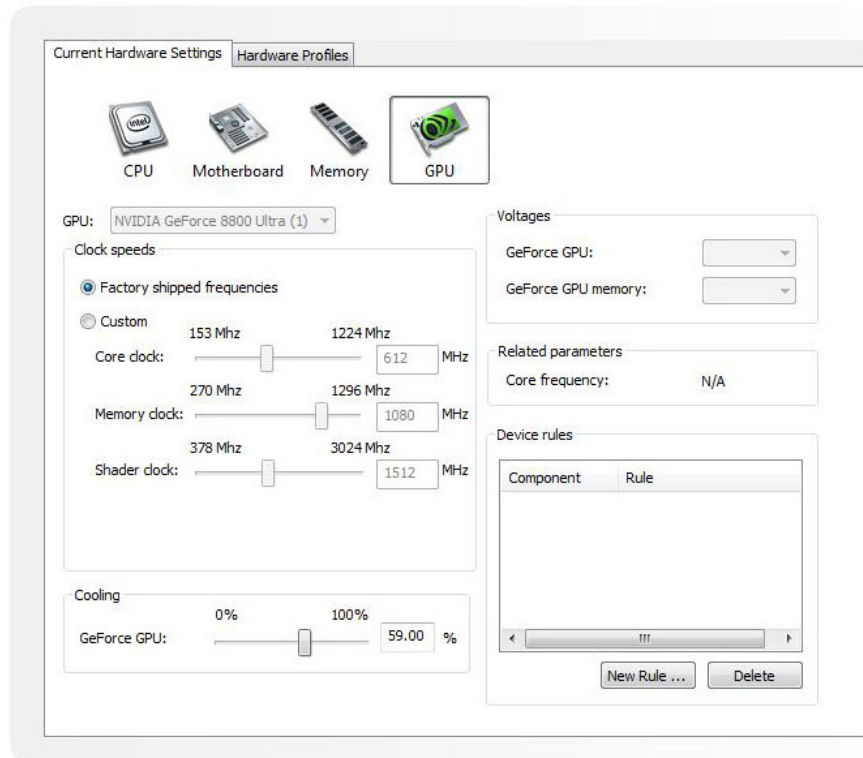

## Dynamic BIOS Access

The **Dynamic BIOS Access** page allows you to change your system BIOS settings. The changes do not go into effect until after you reboot your system. Since these changes are made to actual BIOS settings in the CMOS, the settings remain active until you change them again or restore the CMOS to the default settings.

Click the **Available BIOS Pages** list arrow and select the BIOS page that you want to edit. The BIOS page chosen determines which items on the page are available for changing. To edit an item, select the corresponding list arrow and then select one of the values from the list. When finished making your changes, click the **OK** or **Apply**.

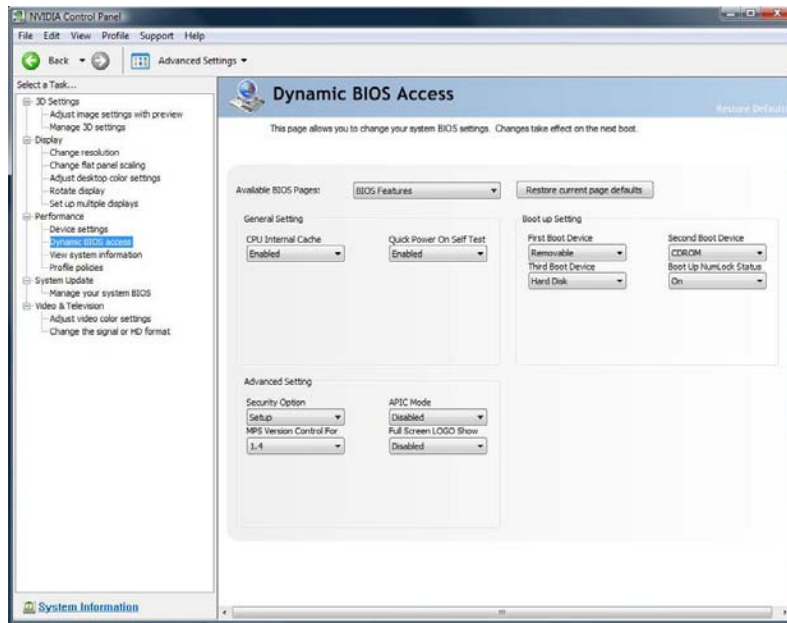

**Note** This feature is available only with BIOS support from the motherboard manufacturer. Available screen and features will vary between different makes and models of motherboards.



## View System Information

The **View System Information** menu is a high-level view where all the critical values of the system are consolidated and presented within a single view. At a glance, the user can clearly see the current status of their components and receives a clear depiction of overall system performance.

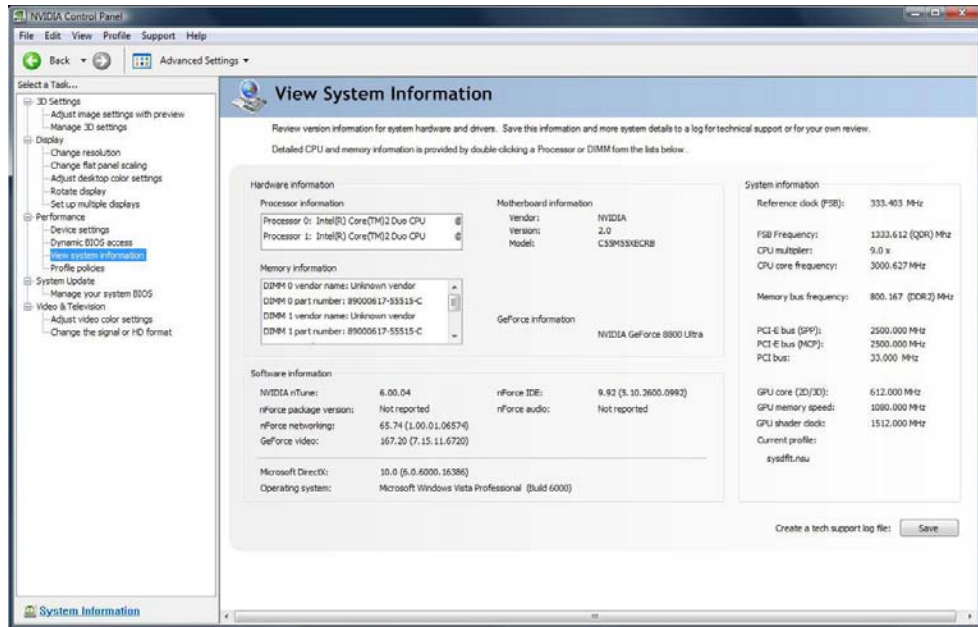

Within the **View System Information** section, the user can also double-click values for both memory modules and processors to receive even more-detailed information regarding those components.

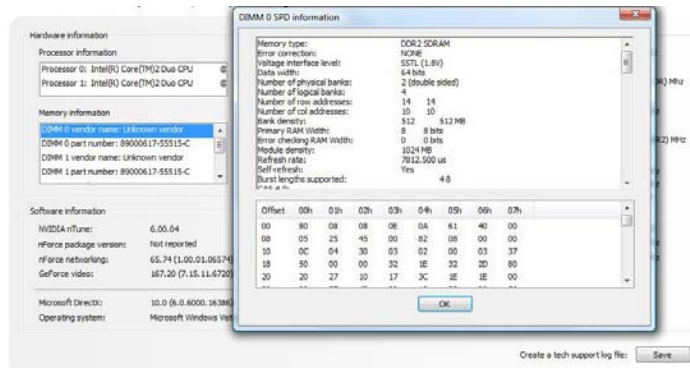

## Profile Policies

Easily one of the most powerful aspects of NVIDIA Performance Server is the ability to create custom profiles and rules. Essentially, NVIDIA Performance Server allows the user to offer a custom set of settings and alerts which can be tailored from a global setting all the way to something as granular as a particular game. In short, you can effortlessly customize your system to run as silent as possible when performing less-demanding tasks such as browsing the web. When loading a game however, system settings adjust to extract the highest possible performance from every system component and ensure you have the ultimate gaming experience with your current hardware.

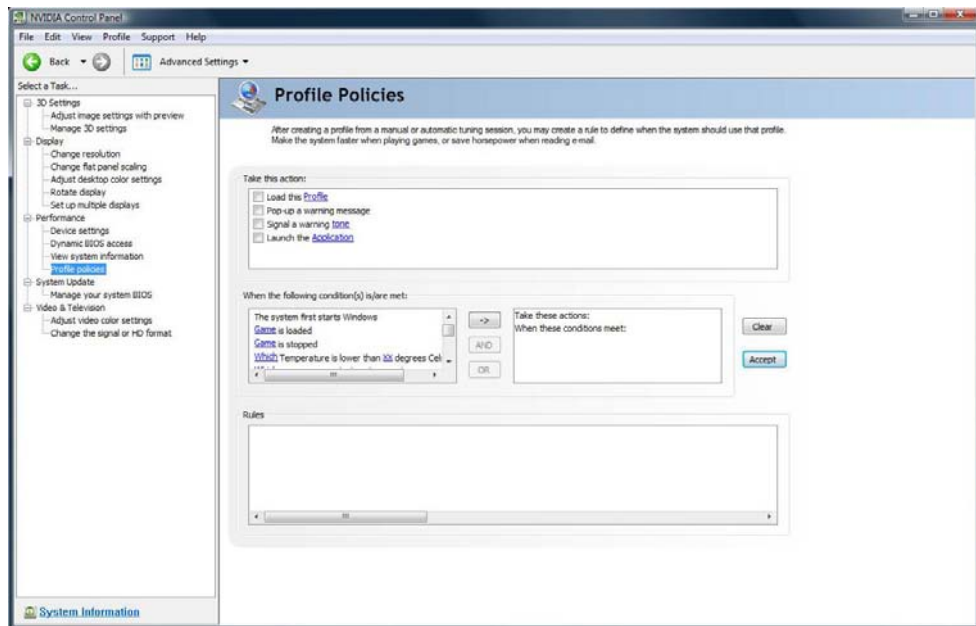

## Manage Your System BIOS

Thanks to the power and flexibility of NVIDIA's Performance Server software, users can even backup or update their system BIOS from within Windows. In addition to displaying a complete collection of information regarding the current BIOS version being used, the user also has the option of saving a backup version of the BIOS being used. This is especially useful when updating the current BIOS because you have a known good BIOS to revert to should the other version have issues with system stability or performance.

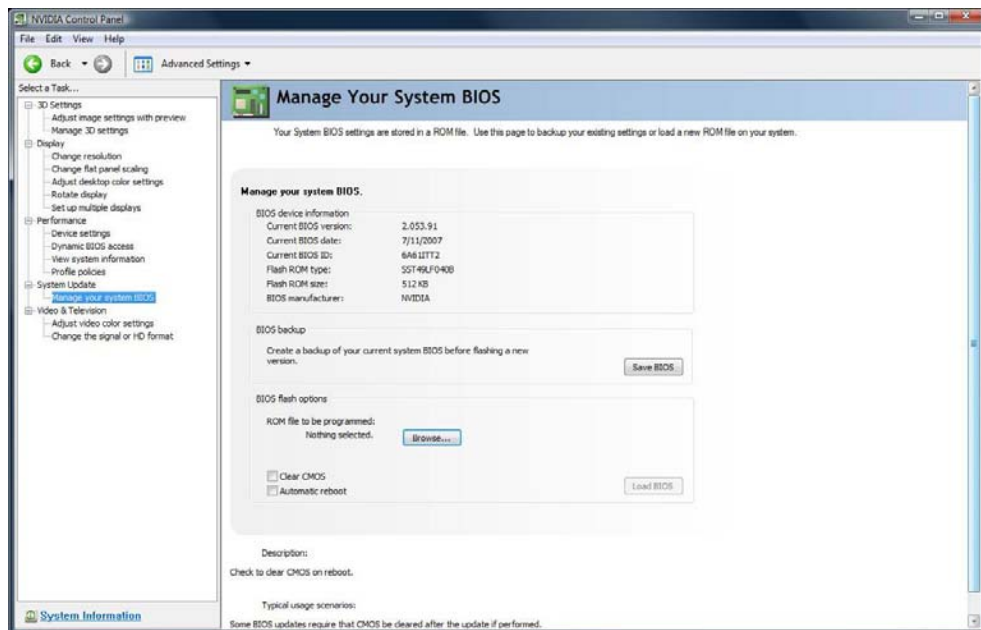

## NVIDIA System Monitor

You can open the NVIDIA System Monitor several ways:

- Double-click the **NVIDIA System Monitor** icon on the desktop
- Click **Start**, then click **All Programs** → **NVIDIA Corporation** → **NVIDIA System Monitor**.

The NVIDIA System Monitor is a unique 3D presentation of core component values. For every supported device, a wide range of information ranging from temperature, frequency, and voltage are reported. Given the fact that the NVIDIA System Monitor is based around an OpenGL foundation, there is nearly zero performance overhead associated with running the utility.

Users can effortlessly navigate through NVIDIA System Monitor by selecting a particular component in order to view that hardware's appropriate information. The selected component comes to the foreground and all supported information is presented. Should the user prefer an overhead view of the components in the system, they can utilize the mouse-wheel to control the angle of the display.

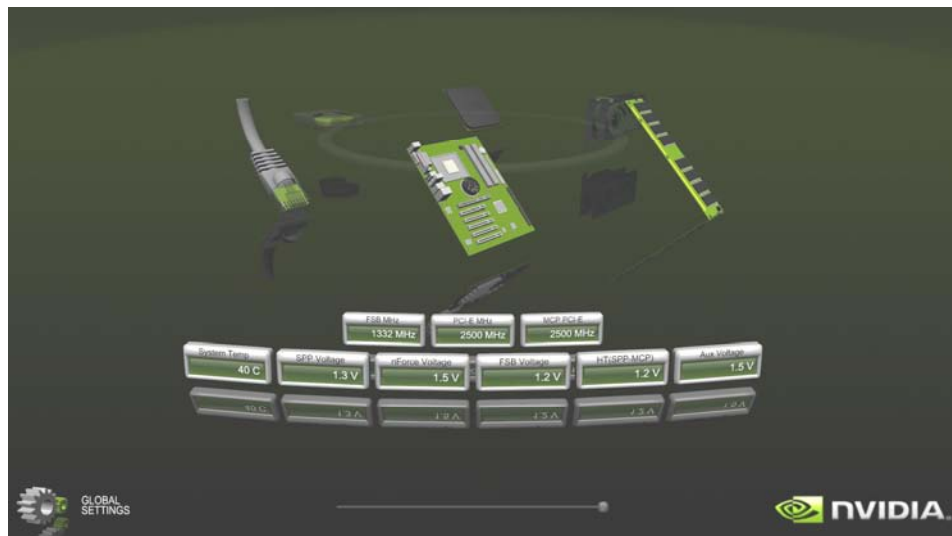

In this example, we can see that the motherboard is selected. As a result, a wide array of related settings and status information is displayed in real-time. In addition to fan speeds and temperatures, we also find critical voltage values for core components. By moving the slider on the bottom of the screen, the user also can control the translucency of the screen allowing them to view the desktop if desired.



Specific information fields that the user wants to always have on display can be selected by double-clicking the appropriate information box. The box will be moved to the top of the screen where it will remain regardless of which component is selected from that point on.



By pressing **Ctrl+Alt+C** or by clicking the arrow icon in the top-right of the screen, the user can switch modes and bring all selected component fields to the desktop. From here, the component fields can be oriented and moved anywhere on the desktop. Furthermore, component fields can be removed from this view by clicking the small button in the top right of the icon's box.



By clicking on the **Global Settings** image in the bottom left of the screen, the user can customize the way **nV Monitor** looks and behaves. The first series of options the user is presented with deals with the application's appearance. The user can control everything from temperature units to overall translucency of the application, and can manipulate a number of other settings to tailor the program to one's liking.

The second series of options the user can alter deals with Event Logging. Here, one can easily select which system components to track and can specify the name of the resulting output file. All fields within the application will be logged and written to this file to aid in troubleshooting issues and tracking overall system behavior.

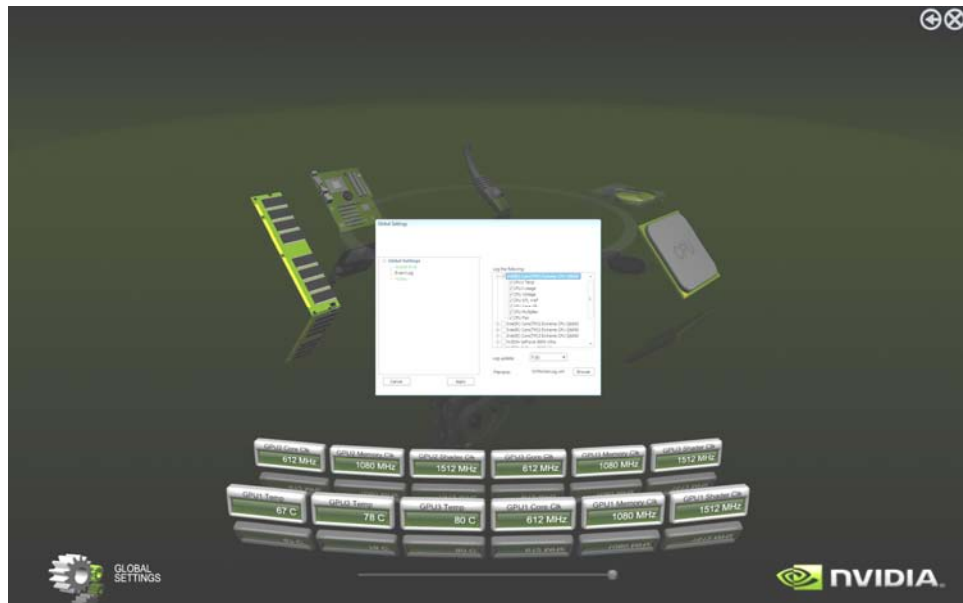

## XFX nForce 790i Ultra 3-Way SLI Motherboard

The final series of options the user can change handles the specific hotkeys used to control various application actions. In this screen, the user simply enters their desired hotkey configuration and they are able to control every aspect of functionality for **nV Monitor** according to their own personal preferences.





# Appendix A.

## POST Codes for Tritium Platform

This section provides the Award POST Codes (Table 6) and the NVMM POST Codes (Table 7) for Tritium platforms during system boot up.

Table 6. Award POST Code

Award POST Codes		
Code	Name	Description
01	Reserved	
02	Jumps to E000 segment	Execution of POST routines in E000
03	Early SuperIO	Init Early Initialized the super IO
04	Reserved	
05	Blank video	Reset Video controller
06	Reserved	
07	Init KBC	Keyboard controller init
08	KB test	Test the Keyboard
09	Reserved	
0A	Mouse Init	Initialized the mouse
0B	Reserved	
0C	Reserved	
0D	Reserved	
0E	Checksum Check	Check the integrity of the ROM, BIOS and message
0F	Reserved	
10	Autodetect EEPROM	Check Flash type and copy flash write/erase routines

<b>Award POST Codes</b>		
<b>Code</b>	<b>Name</b>	<b>Description</b>
11	Reserved	
12	Test CMOS	Test and Reset CMOS
13	Reserved	
14	Load Chipset	Load Chipset Defaults
15	Reserved	
16	Init Clock	Initialize onboard clock generator
17	Reserved	
18	Init CPU	CPU ID and initialize L1/L2 cache
19	Reserved	
1A	Reserved	
1B	Setup Interrupt Vector Table	Initialize first 120 interrupt vectors with SPURIOUS_INT_HDLR and initialize INT 00h-1Fh according to INT_TBL
1C	CMOS Battery Check	Test CMOS and check Battery Fail
1D	Early PM	Early PM initialization
1E	Reserved	
1F	Re-initial KB	Load keyboard matrix
20	Reserved	
21	HPM init	Init Heuristic Power Management (HPM)
22	Reserved	
23	Program chipset	Early Programming of chipset registers
24	Init PNP	Init PNP
25	Shadow VBIOS	Shadow system/video BIOS
26	Clock Gen	Init onboard clock generator and sensor
27	Setup BDA	Setup BIOS DATA AREA (BDA)
28	Reserved	
29	CPU Speed detect	Chipset programming and CPU Speed detect
2A	Reserved	

<b>Award POST Codes</b>		
<b>Code</b>	<b>Name</b>	<b>Description</b>
2B	Init video	Initialize Video
2C	Reserved	
2D	Video memory test	Test Video Memory and display Logos
2E	Reserved	
2F	Reserved	
30	Reserved	
31	Reserved	
32	Reserved	
33	Early keyboard reset	Early Keyboard Reset
34	Reserved	
35	Test DMA Controller 0	Test DMA channel 0
36	Reserved	
37	Test DMA Controller 1	Test DMA channel 1
38	Reserved	
39	Test DMA Page Registers	Test DMA Page Registers
3A	Reserved	
3B	Reserved	
3C	Test Timer	Test 8254 Timer 0 Counter 2.
3D	Reserved	
3E	Test 8259-1 Mask	Verify 8259 Channel 1 masked interrupts by alternately turning off and on the interrupt lines.
3F	Reserved	
40	Test 8259-2 Mask	Verify 8259 Channel 2 masked interrupts by alternately turning off and on the interrupt lines.
41	Reserved	

<b>Award POST Codes</b>		
<b>Code</b>	<b>Name</b>	<b>Description</b>
42	Reserved	
43	Test Stuck Interrupt	Turn off interrupts then verify no 8259's interrupt mask register is on. Test 8259 Force an interrupt and verify the interrupt occurred.
44	Reserved	
45	Reinit serial port	Reinitialize Preboot agent serial port
46	Reserved	
47	EISA Test	If EISA non-volatile memory checksum is good, execute EISA initialization. If not, execute ISA tests and clear EISA mode flag.
48	Reserved	
49	Size Memory	Size base memory from 256K to 640K and extended memory above 1MB.
4A	Reserved	
4B	Reserved	
4C	Reserved	
4D	Reserved	
4E	Init APIC	Initialize APIC and set MTRR
4F	Reserved	
50	USB init	Initialize USB controller
51	Reserved	
52	Memory Test	Test all memory of memory above 1MB using Virtual 8086 mode, page mode and clear the memory
53	Reserved	
54	Reserved	
55	CPU display	Detect CPU speed and display CPU vendor specific version string and turn on all necessary CPU features
56	Reserved	
57	PnP Init Display	PnP logo and PnP early init
58	Reserved	

<b>Award POST Codes</b>		
<b>Code</b>	<b>Name</b>	<b>Description</b>
59	Setup Virus	Setup virus protect according to Protect Setup
5A	Reserved	
5B	Awdflash Load	If required, will auto load Awdflash.exe in POST
5C	Reserved	
5D	Onboard I/O	Init Initializing onboard superIO
5E	Reserved	
5F	Reserved	
60	Setup enable	Display setup message and enable setup functions
61	Reserved	
62	Reserved	
63	Initialize Mouse	Detect if mouse is present, initialize mouse, install interrupt vectors.
64	Reserved	
65	PS2 Mouse special	Special treatment to PS2 Mouse port
66	Reserved	
67	ACPI init	ACPI sub-system initializing
68	Reserved	
69	Init Cache	Initialize cache controller
6A	Reserved	
6B	Setup	Enter setup check and autoconfiguration check up
6C	Reserved	
6D	Initialize Floppy	Initialize floppy disk drive
6E	Reserved	
6F	FDD install	Install FDD and setup BIOS data area parameters
70	Reserved	
71	Reserved	
72	Reserved	
73	Initialize Hard	Initialize hard drive controller

<b>Award POST Codes</b>		
<b>Code</b>	<b>Name</b>	<b>Description</b>
	Drive	
74	Reserved	
75	Detect HDD	IDE device detection
76	Reserved	
77	Detect serial ports	Initialize serial ports.
78	Reserved	
79	Reserved	
7A	Detect parallel ports	Initialize parallel ports.
7B	Reserved	
7C	HDD Write Protect	HDD check for write protection
7D	Reserved	
7E	Reserved	
7F	POST error check	Check POST error and display them and ask for user intervention
80	Reserved	
81	Reserved	
82	Security Check	Ask password security.
83	Write CMOS	Write all CMOS values back to RAM and clear screen.
84	Display PNP	Display PNP devices
85	USB Final Init	Final USB initialization
86	Reserved	
87	Reserved	
88	Reserved	
89	Setup ACPI tables	Setup ACPI tables
8A	Reserved	
8B	Option ROM Detect	Scan for Option ROMs
8C	Reserved	

<b>Award POST Codes</b>		
<b>Code</b>	<b>Name</b>	<b>Description</b>
8D	Enable Parity Check	Enable Parity Check
8E	Reserved	
8F	IRQ12 Enable	Enable IRQ12 if mouse present
90	Reserved	
91	Reserved	
92	Reserved	
93	Boot Medium Read	Detect and store boot partition head and cylinders values in RAM
94	Final Init	Final init for last micro details before boot
95	NumLock	Set NumLock status according to Setup
96	Boot Attempt	Set low stack Boot via INT 19h.
C0	Base CPU test	Read/Write CPU registers
C1	Memory Presence	Base memory detect
C2	Early Memory	Board Initialization
C3	Extend Memory	Turn on extended memory, cache initialization
C4	Special Display	First display initialization
C5	Early Shadow	Early shadow enable for fast boot
C6	Cache presence	External cache size detection
CF	CMOS Check	CMOS checkup
B0	Spurious	If interrupt occurs in protected mode.
B1	Unclaimed NMI	If unmasked NMI occurs, display Press F1 to disable NMI, F2 reboot.
BF	Program MCP	To program chipset from defaults values
E1-EF	Setup Pages	E1- Page 1, E2 - Page 2, etc.
FF	Boot	

Table 7. NVMM POST Codes

NVMM POST Codes		
Code	Name	Description
0F0h		Identify HW in the system
0F1h		Register the slam tables
0F2h		Early SLAM table
0F3h		COM port initialization
000h		Initialize the hardware devices
001h		Override input parameters, etc. before QUERY
004h		Query the hardware devices
008h		Read SPD & fill in arrays
00Ch		ROM table pointer
010h		Initialize the Memory Controller
011h		Program the PLLs
012h		Query after memory PLL has been set
013h		Set Dynamic SPD values
014h		Load MemInfoStruct
015h		Load the DIMM geometry (using SPD)
016h		Prepare MRS variables
017h		Probe memory geometry
018h		PROD_C: PROD f/ Calculated ref manuals
019h		PROD_D: PROD w/ Discrete assembly programming
01Ah		PROD_E: PROD w/ Expandable criteria
01Bh		Send MRS/EMRS configuration cycles
01Ch		Overvoltage handling
01Dh		PROD_F: PROD Final - after MRS/EMRS
020h		PCI Express Initialization
030h		Load Spread Spectrum tables
040h		Set Top-Of-Memory registers



<b>NVMM POST Codes</b>		
<b>Code</b>	<b>Name</b>	<b>Description</b>
044h		Late SLAM table
048h		Previous Power State SLAM table
04Ch		Hardware Workarounds
050h		Restore, and exit NVMM
054h		Memory Test
0FEh		ERROR handler
0FFh		End of Table
0FFh		Invalid APIC ID
0FEh		CPU Identify/Init failed
0FDh		North Bridge not supported
0FCh		South Bridge not supported
0FBh		No DIMMs present
0FAh		Invalid DIMM types, SDR/DDR
0F9h		Different voltage levels
0F8h		Invalid REFRESH Rate
0F7h		Invalid memory geometry
0F6h		Slam Engine error
0F5h		Memory Test Error
0F4h		Link Training timeout



## Appendix B. Configuring an SLI Configuration

NVIDIA SLI (Scalable Link Interface) is a revolutionary technology that allows up to three XFX SLI graphics cards to work together to deliver incredible 3D graphics performance.

Your new motherboard can support up to three PCI Express graphics cards linked using SLI. Currently 3-way NVIDIA SLI is approved and operating on the following graphics cards:

- ❑ XFX GeForce 8800 Ultra
- ❑ XFX GeForce 8800 GTX



Figure 17. 3-Way SLI Using GeForce 8800 Ultra

## SLI Connector

NVIDIA 3-way SLI platform will also require a new SLI connector that connects the SLI headers on the graphics cards (Figure 18).



Figure 18. 3-way NVIDIA SLI connector

---

## ForceWare Driver

The 3-way SLI platform uses the NVIDIA ForceWare Windows Vista driver. To install the driver, run the setup.exe file to launch the **InstallShield**. The **InstallShield** runs three installs, one for each GPU. Reboot your PC when the install is complete.

After reboot, the **Windows Vista Device Manager** shows three GPUs under **Display adapters** (Figure 18).

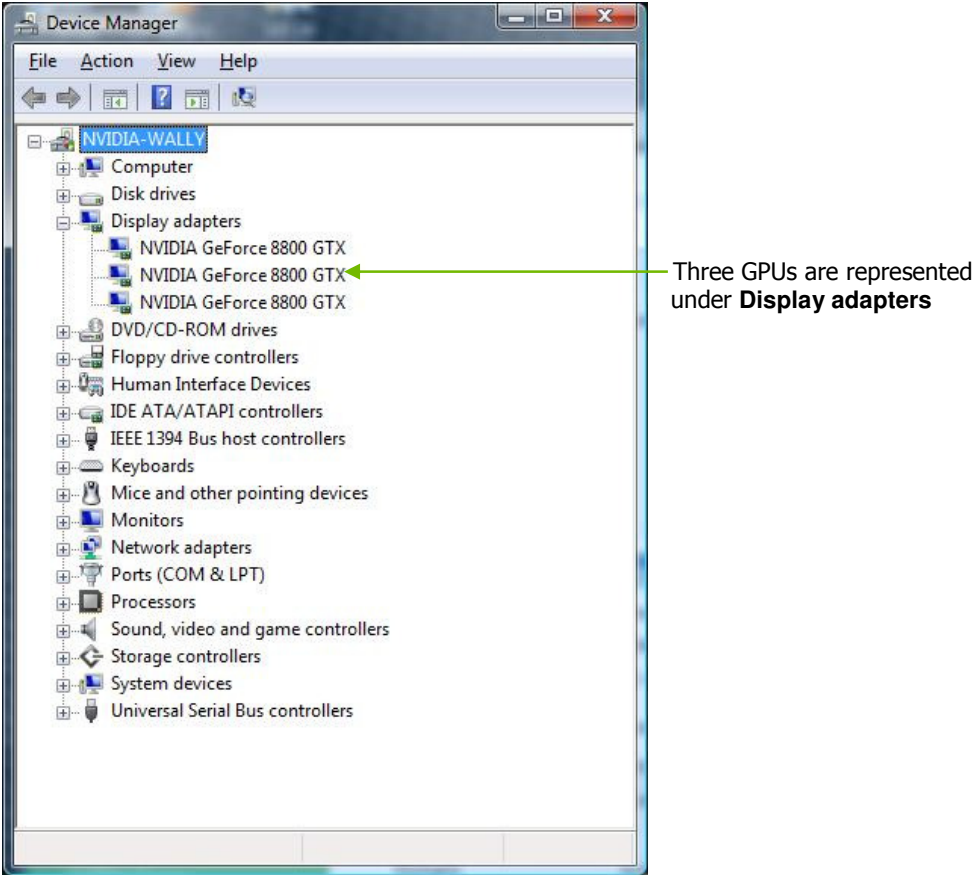

Figure 19. Windows Vista Device Manager

## Enabling 3-Way SLI

3-way NVIDIA SLI is enabled from the **NVIDIA Control Panel**. Right mouse click on the Windows desktop and select NVIDIA Control Panel. Go to **3D Settings** → **Set SLI configuration** (Figure 19) and select **Enable SLI technology (recommended)**. After selecting this option, you will be prompted to verify the settings have been successfully configured.

**Note:** Selecting **Do not use SLI Technology** sets the configuration into single GPU mode.

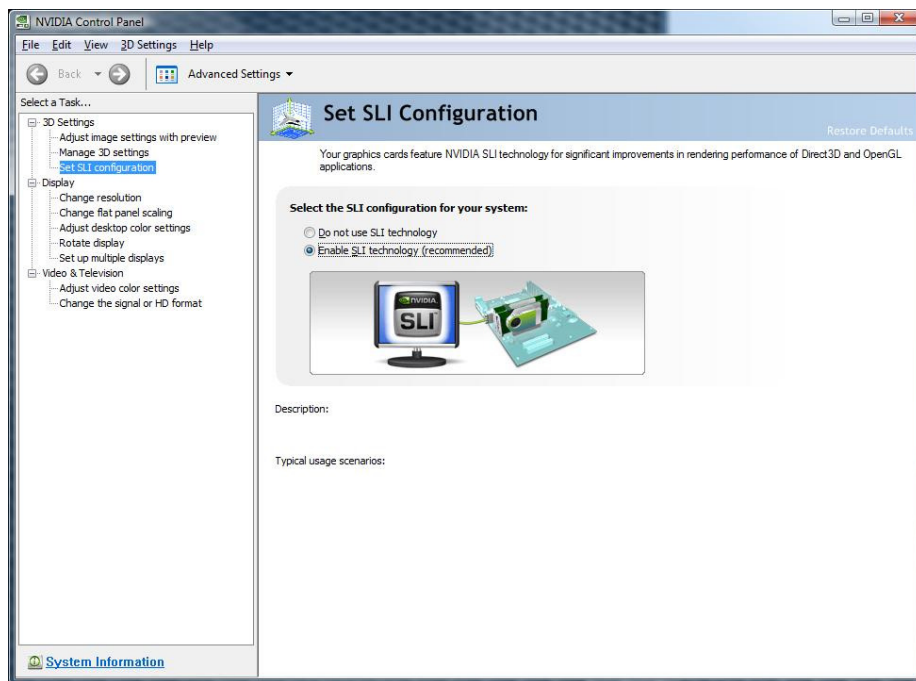

Figure 20. NVIDIA Control Panel, Set SLI Configuration

Before closing the NVIDIA Control Panel, go to the top menu option labeled **3D Settings** and select **Show SLI Visual Indicators**. This option overlays a text label of SLI x3 and green SLI scaling bars in fullscreen 3D applications, as seen in Figure 20.

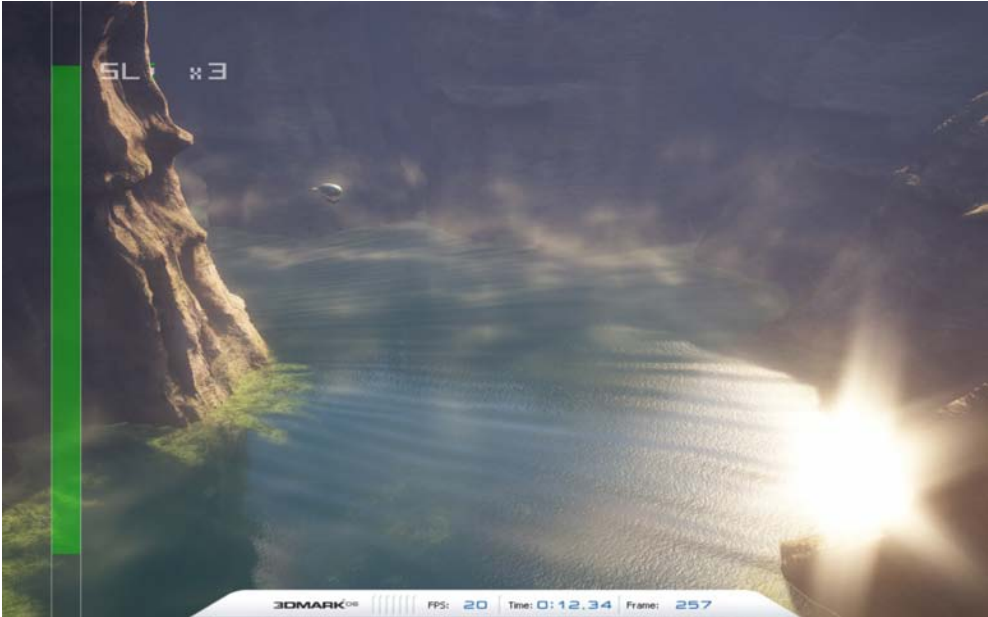
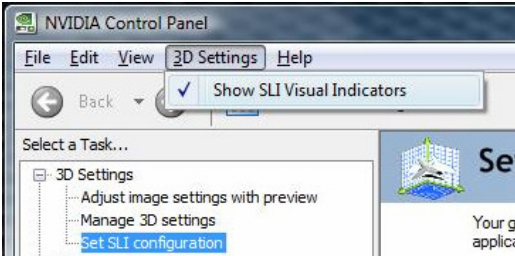

Figure 21. SLI Visual Indicators Operating in 3DMark2006

---

## Verifying 3-way SLI is Active

You can verify 3-way SLI is active and functional by launching a fullscreen 3D application and checking for the SLI Visual indicators.

If these visual indicators are visible and there is no flickering or flashing, 3-way NVIDIA SLI is operational on your platform.

If these visual indicators are not visible, please check previous steps to ensure you have enable the indictors, your connector is firmly in place, and that you have enable SLI technology.



# Index

- 1394 Cable, 4
- 2-Port SATA Power Cable, 4
- ACPI function, 57
- ACPI Suspend Type, 57
- Adjust Motherboard Timings screen, 71
- Advanced BIOS Features, 34
- Advanced Chipset Functions menu, 38
- Advanced Programmable Interrupt Controller, 37
- APIC, 37
- Async Latency, 74
- ATX form factor, 1
- audio connector, 19
- auto-detect IDE and SATA channels, 31
- Available BIOS Pages**, 76
- Award POST Codes, 85
- Base Memory**, 33
- BIOS CMOS Setup Utility Main Menu, 27
- BIOS menus
  - Advanced BIOS Features menu, 34
  - Advanced Chipset Features, 38
  - CMOS Setup Utility menu, 27
  - CPU Configuration, 46
  - FSB & Memory Config, 42
  - Integrated Peripherals, 52
  - Main Menu, 26
  - Memory Timing Setting, 44
  - PnP/PCI Configuration, 59
  - Power Management Setup, 56
  - Standard CMOS Features, 29
  - System Clocks, 39
  - System Monitor menu, 62
  - System Voltages, 48
- BIOS, backup and update, 79
- BIOS, configuring, 25
- block mode, IDE HDD, 55
- boot device priority, 36
- C1E Enhanced Halt State**, 47
- CAS Latency, 74
- Chassis Backpanel Connectors, 6
- CHS**, 31
- Clock Drive Strength, 74
- CMOS RAM jumper, 24
- Command Per Clock**, 45, 74
- configure IDE and SATA channels, BIOS, 30
- configuring the BIOS, 25
- connectors
  - COM1, 21
  - CPU fan, 20

- FDD, 22
- front audio, 19
- IDE, 14
- PWR1, 13
- PWR2, 14
- SATA, 15
- system fan, 20
- Cooling fan for CPU, x
- CPU Configuration menu, 46
- CPU cooling fan, x
- CPU Core 1**, 47
- CPU fan, 9, 20
- CPU Freq**, 40
- CPU internal cache, 35
- CPU Multiplier**, 40
- CPU parameters and information, 70
- CPU Spread Spectrum**, 41
- CPU Thermal Control**, 46
- CPU, installing, 8
- CPU, setting parameters, 70
- create custom profiles and rules, 78
- Current Hardware Settings**, 69
- date and time, setting in BIOS, 30
- DDR2 memory, 9
- Device Settings, 69
- drivers, shipped in kit, 65
- Dynamic BIOS Access** page, 76
- Dynamic Fan Control menu, 63
- equipment list, 3
- ESCD, 60
- Event Logging, 83
- Execute Disable Bit**, 47
- expansion slots, 22
- Extended Memory**, 33
- FDC controller function, 55
- Floppy Cable, 3
- Frequency Settings, 40
- Front Audio, 19
- front panel header, 16
- Front Panel Header Pins, 17
- front panel power LED, 16
- FSB & Memory Config menu, 42
- FSB (QDR)**, 44
- FSB and Memory Clock Mode**, 43
- FSB Reference Clock**, 40
- full-screen logo, 37
- Global Settings**, 82
- GPU, setting parameters, 75
- Halt On** sub-menu, 32
- hard disk audio function, 55
- Hard Disk Boot Priority, 35
- hard disk drive indicator LED, 16
- HD\_LED**, 16
- High Precision Even Timer, 51
- hot key power on**, 58
- hotkey settings, 84
- How to
  - backup and update system BIOS, 79
  - change system BIOS settings, 76
  - configure CPU in BIOS, 46

- configure RAID in BIOS, 54
- configure USB in BIOS, 54
- connect IDE drives, 14
- connect power to motherboard, 13
- create custom profiles, 78
- install CPU, 8
- install DIMMs, 9
- set CMOS jumper, 24
- set CPU parameters, 70
- set date and time, 30
- set disk priority, 35
- set fan speeds in BIOS, 62
- set fan speeds with BIOS, 64
- set GPU parameters, 75
- set IDE functions in BIOS, 53
- set memory parameters, 72
- set motherboard parameters, 71
- set network boot priority, 35
- set power management functions in BIOS, 56
- set system voltages in BIOS, 48
- view system information, 77
- HPET, 51
- HT Multiplier, 41
- HT Spread Spectrum**, 41
- I/O shield, 10
- I/O Shield, 3
- IDE connector, 14
- IDE DMA transfer access**, 53
- IDE Function Setup menu, 53
- IDE Prefetch Mode, 53
- IDE/SATA sub-menu, 30
- IDE-ATA 133 HDD Cable, 4
- IEEE 1394 expansion cable, 17
- IEEE 1934a Connector Pins, 17
- installing
  - CPU, 8
  - I/O shield, 10
  - memory DIMMs, 9
  - motherboard, 10
- installing software, 65
- Integrated Peripherals menu, 52
- Intel microprocessor, x
- internal headers, 16
  - PWRHD\_LED, 16
  - PWRLED, 16
  - PWRSW, 16
- IRQ Resources, 61
- LBA**, 31
- Legacy ISA, 61
- Limit CPUID MaxVal**, 46
- LI-Ready Memory**, 42
- load plate, 8
- MAC Config menu, 55
- MEM (DDR)**, 44
- Memory bank switch, 73
- memory support, x
- Memory Timing Setting**, 44
- memory, setting parameters, 72
- microprocessor, x

- motherboard
  - install procedure, 10
- motherboard specifications, 1
- motherboard, realtime settings and status information, 81
- motherboard, setting parameters, 71
- MPS, 37
- Multi-Processor Specification, 37
- Network Boot Priority, 35
- NumLock** status, 36
- NVIDIA EX support, 51
- NVIDIA memory testing module, 50
- NVIDIA Performance Group, 68
- NVIDIA System Monitor, 80
- NVIDIA System Monitor and Performance Server software utilities, 67
- NVMM POST Codes, 92
- onboard serial port 1 function, 56
- OnChip IDE Channel0**, 53
- OnChip USB**, 54
- Palette Snoop function, 61
- paring the motherboard, 8
- PCI Express x1 slot, 23
- PCI Express x16 slots, 23
- PCI slots, 23
- PCIe Spread Spectrum**, 41
- PCIe x16**, 40
- Performance Group, 68
- PnP/PCI Configuration menu, 59
- POST Codes
  - Award, 85
  - NVMM, 92
- power button cable, 16
- Power Management Setup menu, 56
- power supply requirement, x
- Power-on by alarm function, 57
- power-on function, 58
- Primary Master/Slave PIO**, 53
- Primary Master/Slave UDMA**, 53
- PWR1 connector, 13
- PWR1 pin assignments, 13
- PWR2 connector, 14
- PWRLED**, 16
- PWRSW**, 16
- Quick Power On Self Test, 36
- R to W Turnaround, 73
- RAID Config menu, 54
- RAS to CAS access, 73
- RAS to RAS Delay, 73
- Read-to-Read time, 73
- Ref Clock, SPP→MCP**, 40
- Refresh Rate, 73
- removable device startup priority, 35
- RESET**, 16
- Reset switch cable, 16
- Row Address Strobe, 72
- Row Cycle Time, 73
- safety instructions, 7
- SATA Signal Cable, 4
- SATA Spread Spectrum**, 41

Scalable Link Interface, 95  
 Security Options, 37  
 Serial ATA II connector, 15  
**Serial-ATA Controller**, 53  
 How to, 39  
 Soft-Off by PBNT, 57  
 software installation instructions, 65  
 Spread Spectrum, 41  
 Standard CMOS Features menu, 29  
 System Clocks menu, 39  
 System Monitor menu, 62  
 system voltages and timing settings, 51  
 System Voltages menu, 48  
 $t_{CL}$ , 45, 74  
 $t_{CPC}$ , 74  
 TLP payload size, 61  
**Total Memory**, 33  
 $t_{RAS}$ , 45, 72  
 $t_{RC}$ , 45  
 $t_{RDC}$ , 45  
 $t_{RDRD}$ , 73  
 $t_{REF}$ , 45  
 $t_{RP}$ , 45  
 $t_{RRD}$ , 45  
 $t_{WR}$ , 45  
 $t_{WRD}$ , 74  
 $t_{WRWR}$ , 74  
 $t_{WTR}$ , 45  
 unpacking the kit, 3  
 USB 2.0 4-Port Cable, 4  
 USB 2.0 ports, 18  
 USB Config menu, 54  
**USB Keyboard/Mouse Support**, 54  
**View System Information** menu, 77  
**Virtualization Technology**, 47  
 W to R Termination Turnaround, 73  
 Write Recovery Time, 73  
 Write-to-Write timing, 74  
 XFX nForce 790i Ultra Motherboard, 3  
 XFX nForce 790i Ultra Motherboard  
 Layout, 5

### **Notice**

ALL NVIDIA DESIGN SPECIFICATIONS, REFERENCE BOARDS, FILES, DRAWINGS, DIAGNOSTICS, LISTS, AND OTHER DOCUMENTS (TOGETHER AND SEPARATELY, "MATERIALS") ARE BEING PROVIDED "AS IS." NVIDIA MAKES NO WARRANTIES, EXPRESSED, IMPLIED, STATUTORY, OR OTHERWISE WITH RESPECT TO THE MATERIALS, AND EXPRESSLY DISCLAIMS ALL IMPLIED WARRANTIES OF NONINFRINGEMENT, MERCHANTABILITY, AND FITNESS FOR A PARTICULAR PURPOSE.

Information furnished is believed to be accurate and reliable. However, NVIDIA Corporation assumes no responsibility for the consequences of use of such information or for any infringement of patents or other rights of third parties that may result from its use. No license is granted by implication or otherwise under any patent or patent rights of NVIDIA Corporation. Specifications mentioned in this publication are subject to change without notice. This publication supersedes and replaces all information previously supplied. NVIDIA Corporation products are not authorized for use as critical components in life support devices or systems without express written approval of NVIDIA Corporation.

### **Trademarks**

NVIDIA, the NVIDIA logo, nForce are trademarks or registered trademarks of NVIDIA Corporation. Other company and product names may be trademarks of the respective companies with which they are associated.

### **Copyright**

© 2008 NVIDIA Corporation. All rights reserved.



