

P45 Neo3/ G45 Neo3 P43 Neo3 Series

MS-7514 (v1.X) Mainboard



Copyright Notice

The material in this document is the intellectual property of **MICRO-STAR INTERNATIONAL**. We take every care in the preparation of this document, but no guarantee is given as to the correctness of its contents. Our products are under continual improvement and we reserve the right to make changes without notice.

Trademarks

All trademarks are the properties of their respective owners.

NVIDIA, the NVIDIA logo, DualNet, and nForce are registered trademarks or trademarks of NVIDIA Corporation in the United States and/or other countries.

AMD, Athlon™, Athlon™ XP, Thoroughbred™, and Duron™ are registered trademarks of AMD Corporation.

Intel® and Pentium® are registered trademarks of Intel Corporation.

PS/2 and OS®/2 are registered trademarks of International Business Machines Corporation.

Windows® 95/98/2000/NT/XP/Vista are registered trademarks of Microsoft Corporation.

Netware® is a registered trademark of Novell, Inc.

Award® is a registered trademark of Phoenix Technologies Ltd.

AMI® is a registered trademark of American Megatrends Inc.

Revision History

Revision	Revision History	Date
V1.0	First release for PCB 1.X	April 2008

Technical Support

If a problem arises with your system and no solution can be obtained from the user's manual, please contact your place of purchase or local distributor. Alternatively, please try the following help resources for further guidance.

- 🔍 Visit the MSI website for FAQ, technical guide, BIOS updates, driver updates, and other information: <http://global.msi.com.tw/index.php?func=service>
- 🔍 Contact our technical staff at: <http://ocss.msi.com.tw>

Safety Instructions

1. Always read the safety instructions carefully.
2. Keep this User's Manual for future reference.
3. Keep this equipment away from humidity.
4. Lay this equipment on a reliable flat surface before setting it up.
5. The openings on the enclosure are for air convection hence protects the equipment from overheating. **DO NOT COVER THE OPENINGS.**
6. Make sure the voltage of the power source and adjust properly 110/220V before connecting the equipment to the power inlet.
7. Place the power cord such a way that people can not step on it. Do not place anything over the power cord.
8. Always Unplug the Power Cord before inserting any add-on card or module.
9. All cautions and warnings on the equipment should be noted.
10. Never pour any liquid into the opening that could damage or cause electrical shock.
11. If any of the following situations arises, get the equipment checked by a service personnel:
 - † The power cord or plug is damaged.
 - † Liquid has penetrated into the equipment.
 - † The equipment has been exposed to moisture.
 - † The equipment has not work well or you can not get it work according to User's Manual.
 - † The equipment has dropped and damaged.
 - † The equipment has obvious sign of breakage.
12. **DO NOT LEAVE THIS EQUIPMENT IN AN ENVIRONMENT UNCONDITIONED, STORAGE TEMPERATURE ABOVE 60°C (140°F), IT MAY DAMAGE THE EQUIPMENT.**



CAUTION: Danger of explosion if battery is incorrectly replaced. Replace only with the same or equivalent type recommended by the manufacturer.



警告使用者:

這是甲類的資訊產品，在居住的環境中使用時，可能會造成無線電干擾，在這種情況下，使用者會被要求採取某些適當的對策。



廢電池請回收

For better environmental protection, waste batteries should be collected separately for recycling or special disposal.

FCC-B Radio Frequency Interference Statement

This equipment has been tested and found to comply with the limits for a Class B digital device, pursuant to Part



15 of the FCC Rules. These limits are designed to provide reasonable protection against harmful interference in a residential installation. This equipment generates, uses and can radiate radio frequency energy and, if not installed and used in accordance with the instructions, may cause harmful interference to radio communications. However, there is no guarantee that interference will not occur in a particular installation. If this equipment does cause harmful interference to radio or television reception, which can be determined by turning the equipment off and on, the user is encouraged to try to correct the interference by one or more of the measures listed below.

- † Reorient or relocate the receiving antenna.
- † Increase the separation between the equipment and receiver.
- † Connect the equipment into an outlet on a circuit different from that to which the receiver is connected.
- † Consult the dealer or an experienced radio/television technician for help.

Notice 1

The changes or modifications not expressly approved by the party responsible for compliance could void the user's authority to operate the equipment.

Notice 2

Shielded interface cables and A.C. power cord, if any, must be used in order to comply with the emission limits.

VOIR LANOTICE D'INSTALLATIONAVANT DE RACCORDER AU RESEAU.



This device complies with Part 15 of the FCC Rules. Operation is subject to the following two conditions:

- (1) this device may not cause harmful interference, and*
- (2) this device must accept any interference received, including interference that may cause undesired operation.*

WEEE (Waste Electrical and Electronic Equipment) Statement



ENGLISH

To protect the global environment and as an environmentalist, MSI must remind you that...

Under the European Union ("EU") Directive on Waste Electrical and Electronic Equipment, Directive 2002/96/EC, which takes effect on August 13, 2005, products of "electrical and electronic equipment" cannot be discarded as municipal waste anymore and manufacturers of covered electronic equipment will be obligated to take back such products at the end of their useful life. MSI will comply with the product take back requirements at the end of life of MSI-branded products that are sold into the EU. You can return these products to local collection points.

DEUTSCH

Hinweis von MSI zur Erhaltung und Schutz unserer Umwelt

Gemäß der Richtlinie 2002/96/EG über Elektro- und Elektronik-Altgeräte dürfen Elektro- und Elektronik-Altgeräte nicht mehr als kommunale Abfälle entsorgt werden. MSI hat europaweit verschiedene Sammel- und Recyclingunternehmen beauftragt, die in die Europäische Union in Verkehr gebrachten Produkte, am Ende seines Lebenszyklus zurückzunehmen. Bitte entsorgen Sie dieses Produkt zum gegebenen Zeitpunkt ausschließlich an einer lokalen Altgerätesammelstelle in Ihrer Nähe.

FRANÇAIS

En tant qu'écologiste et afin de protéger l'environnement, MSI tient à rappeler ceci...

Au sujet de la directive européenne (EU) relative aux déchets des équipements électriques et électroniques, directive 2002/96/EC, prenant effet le 13 août 2005, que les produits électriques et électroniques ne peuvent être déposés dans les décharges ou tout simplement mis à la poubelle. Les fabricants de ces équipements seront obligés de récupérer certains produits en fin de vie. MSI prendra en compte cette exigence relative au retour des produits en fin de vie au sein de la communauté européenne. Par conséquent vous pouvez retourner localement ces matériels dans les points de collecte.

РУССКИЙ

Компания MSI предпринимает активные действия по защите окружающей среды, поэтому напоминаем вам, что...

В соответствии с директивой Европейского Союза (ЕС) по предотвращению загрязнения окружающей среды использованным электрическим и электронным оборудованием (директива WEEE 2002/96/EC), вступающей в силу 13 августа 2005 года, изделия, относящиеся к электрическому и электронному оборудованию, не могут рассматриваться как бытовой мусор, поэтому производители вышеперечисленного электронного оборудования обязаны принимать его для переработки по окончании срока службы. MSI обязуется соблюдать требования по приему продукции, проданной под маркой MSI на территории ЕС, в переработку по окончании срока службы. Вы можете вернуть эти изделия в специализированные пункты приема.

ESPAÑOL

MSI como empresa comprometida con la protección del medio ambiente, recomienda:

Bajo la directiva 2002/96/EC de la Unión Europea en materia de desechos y/o equipos electrónicos, con fecha de rigor desde el 13 de agosto de 2005, los productos clasificados como "eléctricos y equipos electrónicos" no pueden ser depositados en los contenedores habituales de su municipio, los fabricantes de equipos electrónicos, están obligados a hacerse cargo de dichos productos al término de su período de vida. MSI estará comprometido con los términos de recogida de sus productos vendidos en la Unión Europea al final de su período de vida. Usted debe depositar estos productos en el punto limpio establecido por el ayuntamiento de su localidad o entregar a una empresa autorizada para la recogida de estos residuos.

NEDERLANDS

Om het milieu te beschermen, wil MSI u eraan herinneren dat...

De richtlijn van de Europese Unie (EU) met betrekking tot Vervuiling van Electriche en Electronische producten (2002/96/EC), die op 13 Augustus 2005 in zal gaan kunnen niet meer beschouwd worden als vervuiling.

Fabrikanten van dit soort producten worden verplicht om producten retour te nemen aan het eind van hun levenscyclus. MSI zal overeenkomstig de richtlijn handelen voor de producten die de merknaam MSI dragen en verkocht zijn in de EU. Deze goederen kunnen geretourneerd worden op lokale inzamelingspunten.

SRPSKI

Da bi zaštitili prirodnu sredinu, i kao preduzeće koje vodi računa o okolini i prirodnoj sredini, MSI mora da vas podesti da...

Po Direktivi Evropske unije ("EU") o odbačenju elektronskoj i električnoj opremi, Direktiva 2002/96/EC, koja stupa na snagu od 13. Avgusta 2005, proizvodi koji spadaju pod "elektronsku i električnu opremu" ne mogu više biti odbačeni kao običan otpad i proizvođači ove opreme biće prinudeni da uzmu natrag ove proizvode na kraju njihovog uobičajenog veka trajanja. MSI će poštovati zahtev o preuzimanju ovakvih proizvoda kojima je istekao vek trajanja, koji imaju MSI oznaku i koji su prodati u EU. Ove proizvode možete vratiti na lokalnim mestima za prikupljanje.

POLSKI

Aby chronić nasze środowisko naturalne oraz jako firma dbająca o ekologię, MSI przypomina, że...

Zgodnie z Dyrektywą Unii Europejskiej ("UE") dotyczącą odpadów produktów elektrycznych i elektronicznych (Dyrektywa 2002/96/EC), która wchodzi w życie 13 sierpnia 2005, tzw. "produkty oraz wyposażenie elektryczne i elektroniczne" nie mogą być traktowane jako śmieć komunalne, tak więc producenci tych produktów będą zobowiązani do odbierania ich w momencie gdy produkt jest wycofywany z użycia. MSI wypełni wymagania UE, przyjmując produkty (sprzedawane na terenie Unii Europejskiej) wycofywane z użycia. Produkty MSI będzie można zwracać w wyznaczonych punktach zbiorczych.

TÜRKÇE

Çevreci özelliğiyle bilinen MSI dünyada çevreyi korumak için hatırlatır:

Avrupa Birliği (AB) Kararnamesi Elektrik ve Elektronik Malzeme Atığı, 2002/96/EC Kararnamesi altında 13 Ağustos 2005 tarihinden itibaren geçerli olmak üzere, elektrikli ve elektronik malzemeler diğer atıklar gibi çöpe atılmayacak ve bu elektronik cihazların üreticileri, cihazların kullanım süreleri bittikten sonra ürünleri geri toplamakla yükümlü olacaktır, Avrupa Birliği'ne satılan MSI markalı ürünlerin kullanım süreleri bittiğinde MSI ürünlerin geri alınması isteği ile işbirliği içerisinde olacaktır. Ürünlerinizi yerel toplama noktalarına bırakabilirsiniz.

ČESKY

Záleží nám na ochraně životního prostředí - společnost MSI upozorňuje...

Podle směrnice Evropské unie ("EU") o likvidaci elektrických a elektronických výrobků 2002/96/EC platné od 13. srpna 2005 je zakázáno likvidovat "elektrické a elektronické výrobky" v běžném komunálním odpadu a výrobci elektronických výrobků, na které se tato směrnice vztahuje, budou povinni odebírat takové výrobky zpět po skončení jejich životnosti. Společnost MSI splní požadavky na odebrání výrobků značky MSI, prodávaných v zemích EU, po skončení jejich životnosti. Tyto výrobky můžete odevzdat v místních sběrnách.

MAGYAR

Annak érdekében, hogy környezetünket megvédjük, illetve környezetvédként fellépve az MSI emlékezteti Önt, hogy ...

Az Európai Unió („EU”) 2005. augusztus 13-án hatályba lépő, az elektromos és elektronikus berendezések hulladékairól szóló 2002/96/EK irányelve szerint az elektromos és elektronikus berendezések többé nem kezelhetők lakossági hulladékként, és az ilyen elektronikus berendezések gyártói kötelesek válnak az ilyen termékek visszavételére azok hasznos élettartama végén. Az MSI betartja a termékvisszavétellel kapcsolatos követelményeket az MSI márkánév alatt az EU-n belül értékesített termékek esetében, azok élettartamának végén. Az ilyen termékeket a legközelebbi gyűjtőhelyre viheti.

ITALIANO

Per proteggere l'ambiente, MSI, da sempre amica della natura, ti ricorda che....

In base alla Direttiva dell'Unione Europea (EU) sullo Smaltimento dei Materiali Elettrici ed Elettronici, Direttiva 2002/96/EC in vigore dal 13 Agosto 2005, prodotti appartenenti alla categoria dei Materiali Elettrici ed Elettronici non possono più essere eliminati come rifiuti municipali: i produttori di detti materiali saranno obbligati a ritirare ogni prodotto alla fine del suo ciclo di vita. MSI si adegnerà a tale Direttiva ritirando tutti i prodotti marchiati MSI che sono stati venduti all'interno dell'Unione Europea alla fine del loro ciclo di vita. È possibile portare i prodotti nel più vicino punto di raccolta.

CONTENTS

Copyright Notice	ii
Trademarks	ii
Revision History	ii
Technical Support	ii
Safety Instructions	iii
FCC-B Radio Frequency Interference Statement	iv
WEEE (Waste Electrical and Electronic Equipment) Statement	v
Chapter 1. Getting Started	1-1
Mainboard Specifications	1-2
Mainboard Layout	1-4
Packing Checklist	1-5
Chapter 2. Hardware Setup	2-1
Quick Components Guide	2-2
CPU (Central Processing Unit)	2-3
Memory	2-7
Power Supply	2-9
Back Panel	2-10
Connectors	2-12
Jumper	2-19
Slots	2-20
Chapter 3 BIOS Setup	3-1
Entering Setup	3-2
The Main Menu	3-4
Standard CMOS Features	3-6
Advanced BIOS Features	3-9
Integrated Peripherals	3-12
Power Management Setup	3-15
H/W Monitor	3-18
BIOS Setting Password	3-19
Cell Menu	3-20
USERSETTINGS	3-24
Load Fail-Safe/ Optimized Defaults	3-25
Appendix A Realtek ALC888 Audio	A-1
Installing the Realtek HD Audio Driver	A-2
Software Configuration	A-4
Hardware Setup	A-19

Appendix B Dual Core Center	B-1
Activating Dual Core Center	B-2
Main	B-3
DOT (Dynamic OverClocking)	B-5
Clock	B-6
Voltage	B-7
FAN Speed	B-8
Temperature	B-9
User Profile	B-10
Appendix C Intel ICH10R SATA RAID	C-1
ICH10R Introduction	C-2
BIOS Configuration	C-3
Installing Driver	C-10
Installing Software	C-12
RAID Migration Instructions	C-16
Recovery Volume Creation	C-23
Degraded RAID Array	C-27
Appendix D JMicron RAID Introduction	D-1
Introduction	D-2
JMicron RAID BIOS Utility	D-3
Installing Driver	D-11
JMicron Raid Configurer	D-13

Chapter 1

Getting Started

Thank you for choosing the P45 Neo3/ G45 Neo3/ P43 Neo3 Series (MS-7514 v1.X) ATX mainboard. The P45 Neo3/ G45 Neo3/ P43 Neo3 Series mainboards are based on Intel® P45/ G45/ P43 & ICH10/ ICH10R chipsets for optimal system efficiency. Designed to fit the advanced **Core 2 Extreme, Core 2 Quad, Core 2 Duo, Pentium Dual-Core** and **Celeron Dual-Core** LGA775 processor, the P45 Neo3/ G45 Neo3/ P43 Neo3 Series deliver a high performance and professional desktop platform solution.

Mainboard Specifications

Processor Support

- Intel® Core 2 Extreme, Core 2 Quad, Core 2 Duo, Pentium Dual-Core and Celeron Dual-Core processors in the LGA775 package
 - Intel® next generation 45 nm Multi-core CPU
- *(For the latest information about CPU, please visit <http://global.msi.com.tw/index.php?func=cpuform>)

Supported FSB

- 1600*(OC)/ 1333/ 1066/ 800 MHz

Chipset

- North Bridge: Intel® P45/ G45/ P43 chipset
- South Bridge: Intel® ICH10/ ICH10R chipset

Memory Support

- 4 DDR2 DIMMs support DDR2 1066**(OC)/ 800/ 667 SDRAM (240pin / 1.8V / 16GB Max)
- (**For more information on compatible components, please visit <http://global.msi.com.tw/index.php?func=testreport>)

LAN

- Supports PCIE LAN 10/100/1000 Fast Ethernet by Realtek 8111C

Audio

- Chip integrated by Realtek® ALC888
- Flexible 8-channel audio with jack sensing
- Compliant with Azalia 1.0 Spec
- Meet Microsoft Vista Premium spec

IDE

- 1 IDE port by JMicron JMB 363
- Supports Ultra DMA 66/100/133 mode
- Supports PIO, Bus Master operation mode

SATA

- 6 SATAII ports by ICH10/ ICH10R (SATA1~6)
- 2 SATAII ports by JMicron JMB363 (SATA7~8)
- Supports storage and data transfers at up to 3 Gb/s

RAID

- SATA1~6 support RAID 0/ 1/ 5/ 10/ JBOD mode by ICH10R
- SATA7 & SATA8 support RAID 0/ RAID1/ JBOD by JMicron JMB363

1394 (optional)

- Supports 1394 by JMicron JMB381

FDD

- 1 floppy port
- Supports 1 FDD with 360KB, 720KB, 1.2MB, 1.44MB and 2.88MB

Connectors

● **Back panel**

- 1 PS/2 mouse port
- 1 PS/2 keyboard port
- 1 Paralle port
- 1 Serial port
- 1 VGA port (for G45 only)
- 4 USB 2.0 Ports
- 1 LAN jack (10/100/1000)
- 6 flexible audio jacks
- 1 1394 port (optional)

● **On-Board Pinheaders / Connectors**

- 4 USB 2.0 pinheaders
- 1 1394 pinheader (optional)
- 1 chassis intrusion connector
- 1 SPDIF-out pinheader
- 1 CD-in connector
- 1 front audio pinheader
- 1 TPM Module connector (optional)
- 2 Hardware Overclock FSB jumpers (JB1 & JB2)

TPM (optional)

- Supports TPM

Slots

- 1 PCI Express x16 slot, support up to PCI Express 2.0 x16 speed
- 1 PCI Express x1 slot
- 4 PCI slots, support 3.3V/ 5V PCI bus Interface

Form Factor

- ATX (30.5cm X 24.5cm)

Mounting

- 9 mounting holes

Mainboard Layout

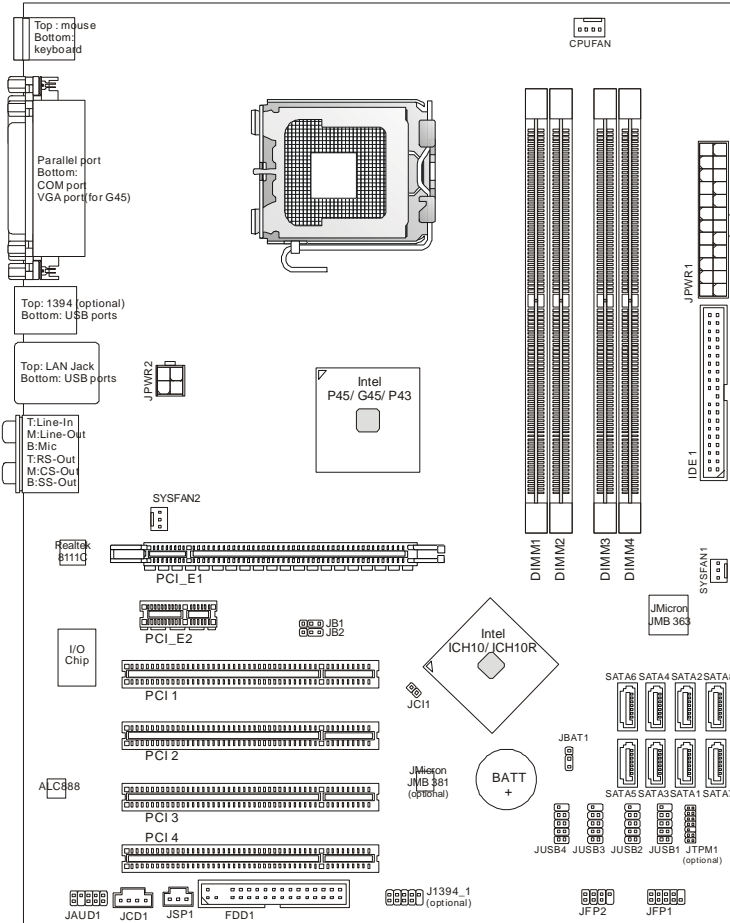

**P45 Neo3/ G45 Neo3/ P43 Neo3 Series
(MS-7514 v1.X) ATX Mainboard**

Packing Checklist



MSI motherboard

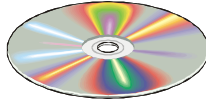

MSI Driver/Utility CD



Back IO Shield



Power Cable



SATA Cable



IDE Cable



User's Guide
and Quick Guide

* The pictures are for reference only and may vary from the packing contents of the product you purchased.

Chapter 2

Hardware Setup

This chapter provides you with the information about hardware setup procedures. While doing the installation, be careful in holding the components and follow the installation procedures. For some components, if you install in the wrong orientation, the components will not work properly.

Use a grounded wrist strap before handling computer components. Static electricity may damage the components.

Quick Components Guide

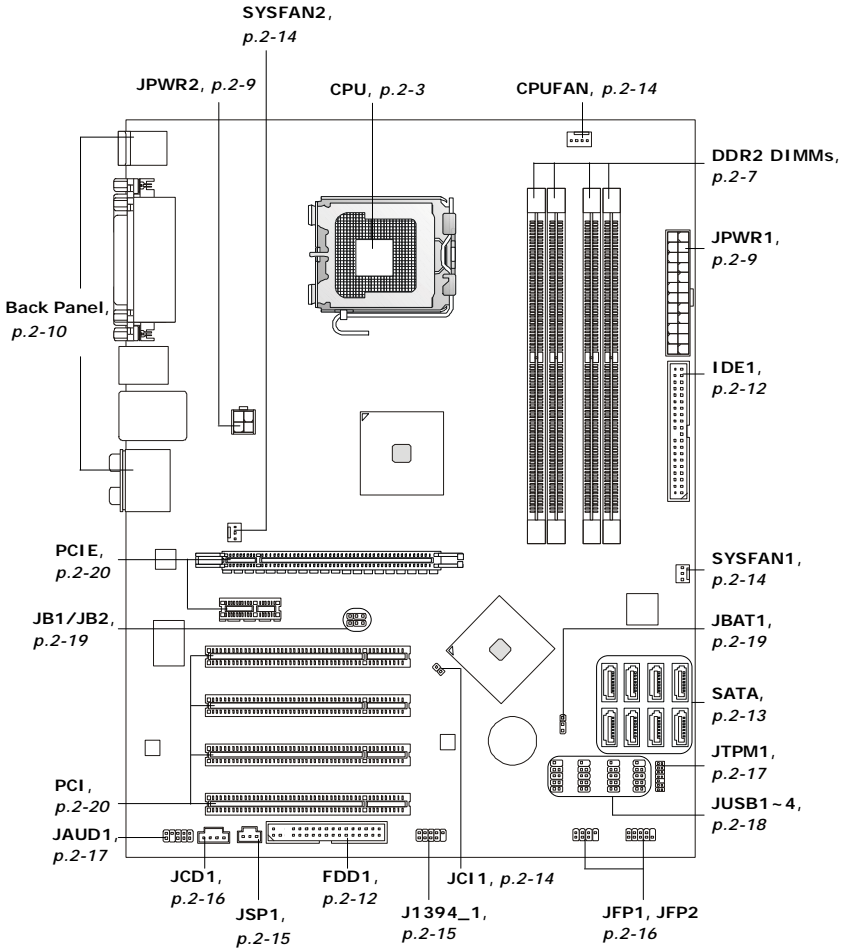

CPU (Central Processing Unit)

When you are installing the CPU, **make sure to install the cooler to prevent overheating.** If you do not have the CPU cooler, consult your dealer before turning on the computer.

For the latest information about CPU, please visit <http://global.msi.com.tw/index.php?func=cpuform>



Important

Overheating

Overheating will seriously damage the CPU and system. Always make sure the cooling fan can work properly to protect the CPU from overheating. Make sure that you apply an even layer of thermal paste (or thermal tape) between the CPU and the heatsink to enhance heat dissipation.

Replacing the CPU

While replacing the CPU, always turn off the ATX power supply or unplug the power supply's power cord from the grounded outlet first to ensure the safety of CPU.

Overclocking

*This mainboard is designed to support overclocking. However, please make sure your components are able to tolerate such abnormal setting, while doing overclocking. Any attempt to operate beyond product specifications is not recommended. **We do not guarantee the damages or risks caused by inadequate operation or beyond product specifications.***

Introduction to LGA 775 CPU

The pin-pad side of LGA 775 CPU.

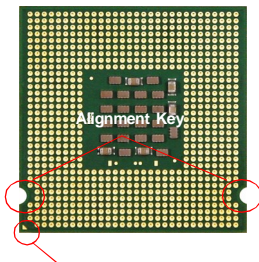

Yellow triangle is the Pin 1 indicator

The surface of LGA 775 CPU. Remember to apply some thermal paste on it for better heat dispersion.

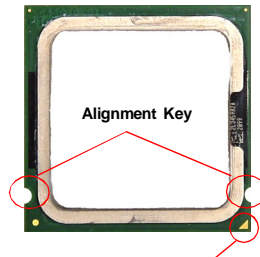

Yellow triangle is the Pin 1 indicator

CPU & Cooler Installation

When you are installing the CPU, **make sure the CPU has a cooler attached on the top to prevent overheating**. Meanwhile, do not forget to apply some thermal paste on CPU before installing the heat sink/cooler fan for better heat dispersion. Follow the steps below to install the CPU & cooler correctly. Wrong installation will cause the damage of your CPU & mainboard.

1. The CPU socket has a plastic cap on it to protect the contact from damage. Before you install the CPU, always cover it to protect the socket pin.
2. Remove the cap from lever hinge side (as the arrow shows).

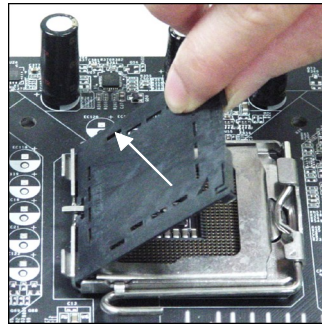
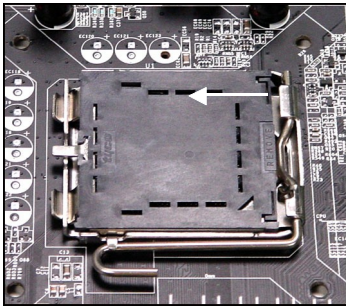

3. The pins of socket reveal.
4. Open the load lever.

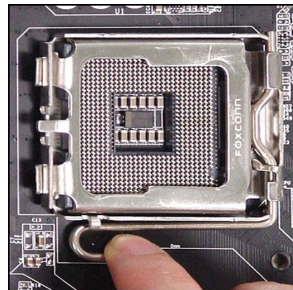
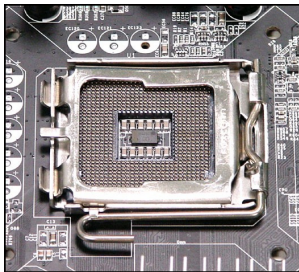

Important

1. Confirm if your CPU cooler is firmly installed before turning on your system.
2. Do not touch the CPU socket pins to avoid damaging.
3. The availability of the CPU land side cover depends on your CPU packing.

Hardware Setup

5. Lift the load lever up and open the load plate.

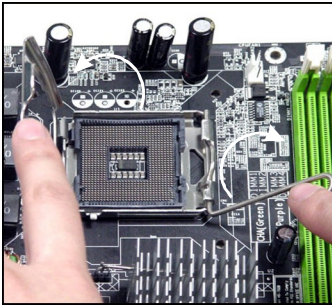

6. After confirming the CPU direction for correct mating, put down the CPU in the socket housing frame. Be sure to grasp on the edge of the CPU base. Note that the alignment keys are matched.

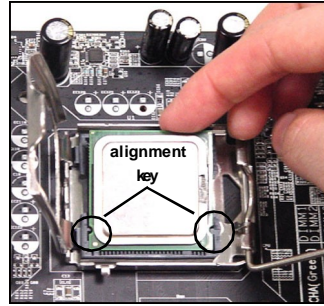

7. Visually inspect if the CPU is seated well into the socket. If not, take out the CPU with pure vertical motion and reinstall.

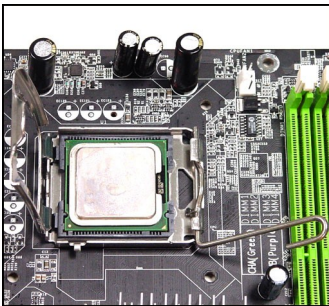

8. Cover the load plate onto the package.

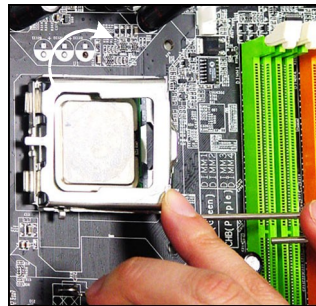

MS-7514 Mainboard

9. Press down the load lever lightly onto the load plate, and then secure the lever with the hook under retention tab.

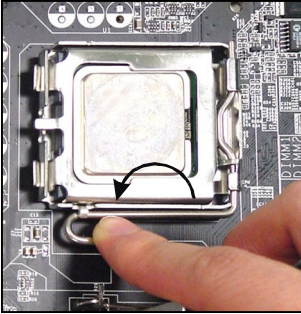

10. Align the holes on the mainboard with the heatsink. Push down the cooler until its four clips get wedged into the holes of the mainboard.

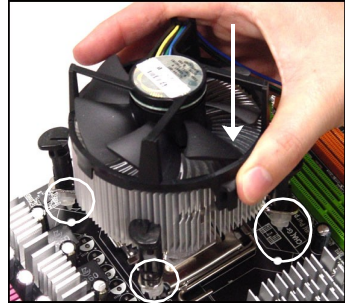

11. Press the four hooks down to fasten the cooler. Then rotate the locking switch (refer to the correct direction marked on it) to lock the hooks.

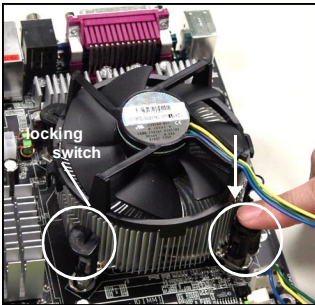

12. Turn over the mainboard to confirm that the clip-ends are correctly inserted.

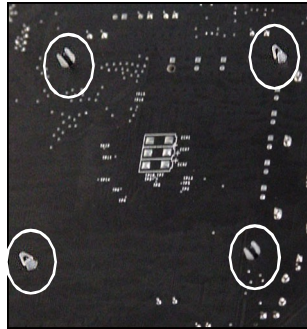

Important

1. Read the CPU status in BIOS (Chapter 3).
2. Whenever CPU is not installed, always protect your CPU socket pin with the plastic cap covered (shown in Figure 1) to avoid damaging.
3. Mainboard photos shown in this section are for demonstration of the CPU/cooler installation only. The appearance of your mainboard may vary depending on the model you purchase.

Memory

These DIMM slots are used for installing memory modules.

For more information on compatible components, please visit <http://global.msi.com.tw/index.php?func=testreport>

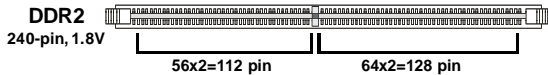

Dual-Channel Memory Population Rules

In Dual-Channel mode, the memory modules can transmit and receive data with two data bus lines simultaneously. Enabling Dual-Channel mode can enhance the system performance. Please refer to the following illustrations for population rules under Dual-Channel mode.

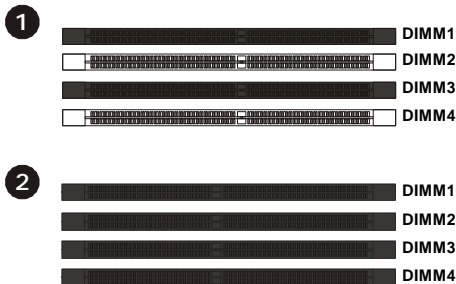

Important

- DDR2 memory modules are not interchangeable with DDR and the DDR2 standard is not backwards compatible. You should always install DDR2 memory modules in the DDR2 DIMM slots.
- In Dual-Channel mode, make sure that you install memory modules of **the same type and density** in different channel DIMM slots.
- To enable successful system boot-up, always insert the memory modules into the **DIMM1 first**.
- Due to the chipset resource deployment, the system density will only be detected up to 15+GB (not full 8GB) when each DIMM is installed with a 4GB memory module.

Installing Memory Modules

1. The memory module has only one notch on the center and will only fit in the right orientation.
2. Insert the memory module vertically into the DIMM slot. Then push it in until the golden finger on the memory module is deeply inserted in the DIMM slot. The plastic clip at each side of the DIMM slot will automatically close when the memory module is properly seated.



Important

You can barely see the golden finger if the memory module is properly inserted in the DIMM slot.

3. Manually check if the memory module has been locked in place by the DIMM slot clips at the sides.

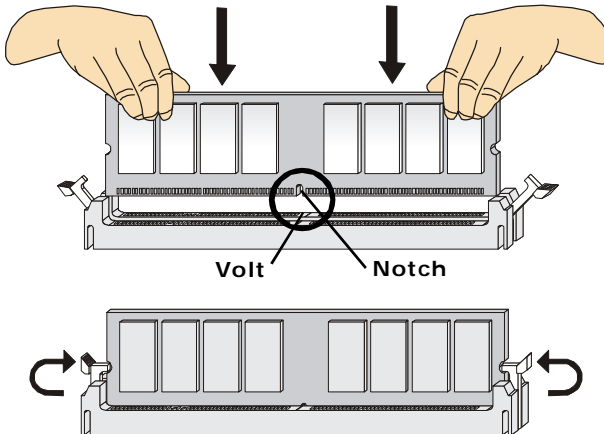

Power Supply

ATX 24-Pin Power Connector: JPWR1

This connector allows you to connect an ATX 24-pin power supply. To connect the ATX 24-pin power supply, make sure the plug of the power supply is inserted in the proper orientation and the pins are aligned. Then push down the power supply firmly into the connector.

You may use the 20-pin ATX power supply as you like. If you'd like to use the 20-pin ATX power supply, please plug your power supply along with pin 1 & pin 13 (refer to the image at the right hand).



JPWR1		Pin Definition			
12	24	PIN	SIGNAL	PIN	SIGNAL
		1	+3.3V	13	+3.3V
		2	+3.3V	14	-12V
		3	GND	15	GND
		4	+5V	16	PS-ON#
		5	GND	17	GND
		6	+5V	18	GND
		7	GND	19	GND
		8	PWROK	20	Res
		9	5VSB	21	+5V
		10	+12V	22	+5V
		11	+12V	23	+5V
		12	+3.3V	24	GND
1	13				

ATX 4-pin Power Connector: JPWR2

This power connector is used to provide power to the CPU.

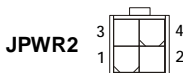

Pin Definition

PIN	SIGNAL
1	GND
2	GND
3	12V
4	12V



Important

1. Make sure that all the connectors are connected to proper ATX power supplies to ensure stable operation of the mainboard.
2. Power supply of 400 watts (and above) is highly recommended for system stability.

Back Panel

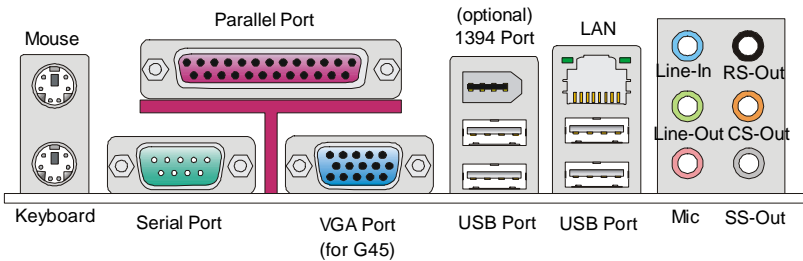

► Mouse/Keyboard

The standard PS/2® mouse/keyboard DIN connector is for a PS/2® mouse/keyboard.

► Parallel Port

A parallel port is a standard printer port that supports Enhanced Parallel Port (EPP) and Extended Capabilities Parallel Port (ECP) mode.

► Serial Port

The serial port is a 16550A high speed communications port that sends/ receives 16 bytes FIFOs. You can attach a serial mouse or other serial devices directly to the connector.

► VGA Port (for G45)

The DB15-pin female connector is provided for monitor.

► 1394 Port (optional)

The IEEE1394 port on the back panel provides connection to IEEE1394 devices.

► USB Port

The USB (Universal Serial Bus) port is for attaching USB devices such as keyboard, mouse, or other USB-compatible devices.

► LAN

The standard RJ-45 LAN jack is for connection to the Local Area Network (LAN). You can connect a network cable to it.

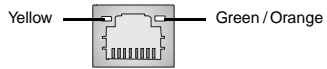

LED	Color	LED State	Condition
Left	Yellow	Off	LAN link is not established.
		On (steady state)	LAN link is established.
		On (brighter & pulsing)	The computer is communicating with another computer on the LAN.
Right	Green	Off	10 Mbit/sec data rate is selected.
		On	100 Mbit/sec data rate is selected.
	Orange	On	1000 Mbit/sec data rate is selected.

► Audio Ports

These audio connectors are used for audio devices. It is easy to differentiate between audio effects according to the color of audio jacks.

- **Line-In (Blue)** - Line In is used for external CD player, tapeplayer or other audio devices.
- **Line-Out (Green)** - Line Out, is a connector for speakers or headphones.
- **Mic (Pink)** - Mic, is a connector for microphones.
- **RS-Out (Black)** - Rear-Surround Out in 4/ 5.1/ 7.1 channel mode.
- **CS-Out (Orange)** - Center/ Subwoofer Out in 5.1/ 7.1 channel mode.
- **SS-Out (Gray)** - Side-Surround Out 7.1 channel mode.

Connectors

Floppy Disk Drive Connector: FDD1

This connector supports 360KB, 720KB, 1.2MB, 1.44MB or 2.88MB floppy disk drive.

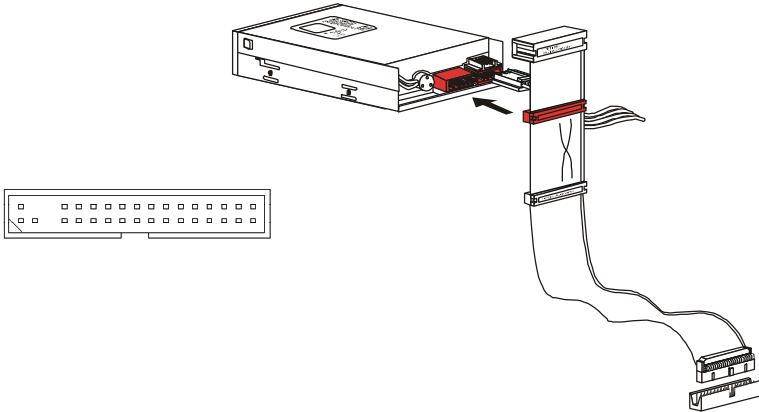

IDE Connector: IDE1

This connector supports IDE hard disk drives, optical disk drives and other IDE devices.

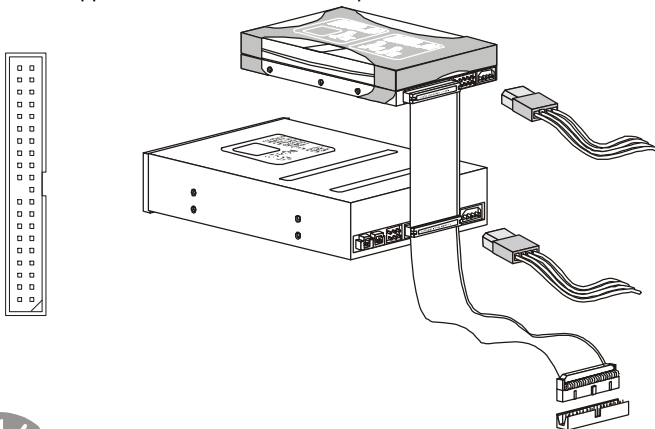

Important

If you install two IDE devices on the same cable, you must configure the drives separately to master / slave mode by setting jumpers. Refer to IDE device's documentation supplied by the vendors for jumper setting instructions.

Serial ATA Connector: SATA1~8

This connector is a high-speed Serial ATA interface port. Each connector can connect to one Serial ATA device.

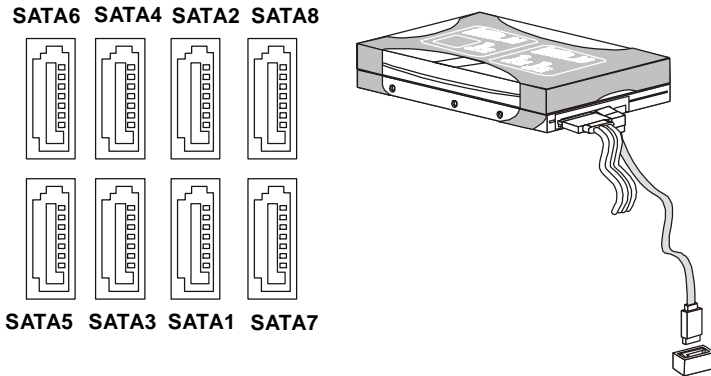

Important

1. Please do not fold the Serial ATA cable into 90-degree angle. Otherwise, data loss may occur during transmission.
2. SATA1~6 controlled by ICH10R/ ICH10, and the ICH10R supports RAID 0/ 1/ 0+1/ 5 mode.
3. SATA7~8 controlled by JMB 363 and they support RAID 0/ 1 mode.

Fan Power Connectors: CPUFAN, SYSFAN1~2

The fan power connectors support system cooling fan with +12V. When connecting the wire to the connectors, always note that the red wire is the positive and should be connected to the +12V; the black wire is Ground and should be connected to GND. If the mainboard has a System Hardware Monitor chipset on-board, you must use a specially designed fan with speed sensor to take advantage of the CPU fan control.

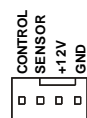

CPUFAN

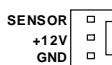

SYSFAN1

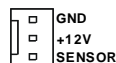

SYSFAN2



Important

1. Please refer to the recommended CPU fans at processor's official website or consult the vendors for proper CPU cooling fan.
2. CPUFAN supports fan control. You can install **Dual Core Center** utility that will automatically control the CPU fan speed according to the actual CPU temperature.
3. Fan cooler set with 3 or 4 pins power connector are both available for CPUFAN.

Chassis Intrusion Connector: JCI1

This connector connects to the chassis intrusion switch cable. If the chassis is opened, the chassis intrusion mechanism will be activated. The system will record this status and show a warning message on the screen. To clear the warning, you must enter the BIOS utility and clear the record.



JCI1

IEEE1394 Connector: J1394_1 (optional)

This connector allows you to connect the IEEE1394 device via an optional IEEE1394 bracket.

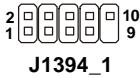

Pin Definition

PIN	SIGNAL	PIN	SIGNAL
1	TPA+	2	TPA-
3	Ground	4	Ground
5	TPB+	6	TPB-
7	Cable power	8	Cable power
9	Key (no pin)	10	Ground

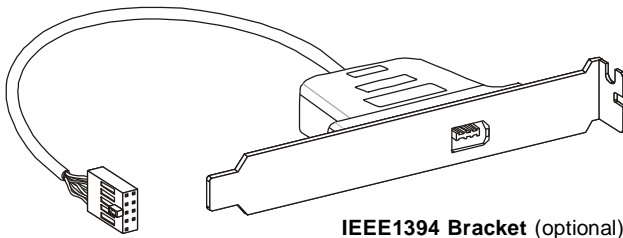

S/PDIF-Out Connector: JSP1

This connector is used to connect S/PDIF (Sony & Philips Digital Interconnect Format) interface for digital audio transmission.

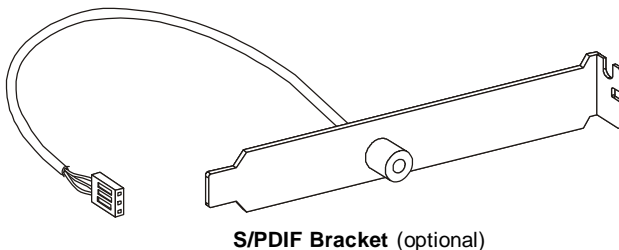
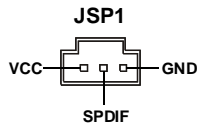

Front Panel Connectors: JFP1, JFP2

These connectors are for electrical connection to the front panel switches and LEDs. The JFP1 is compliant with Intel® Front Panel I/O Connectivity Design Guide.

JFP1 Pin Definition

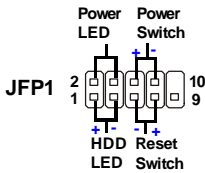

PIN	SIGNAL	DESCRIPTION
1	HD_LED +	Hard disk LED pull-up
2	FPPWR/SLP	MSG LED pull-up
3	HD_LED -	Hard disk active LED
4	FPPWR/SLP	MSG LED pull-up
5	RST_SW -	Reset Switch low reference pull-down to GND
6	PWR_SW+	Power Switch high reference pull-up
7	RST_SW +	Reset Switch high reference pull-up
8	PWR_SW-	Power Switch low reference pull-down to GND
9	RSVD_DNU	Reserved. Do not use.

JFP2 Pin Definition

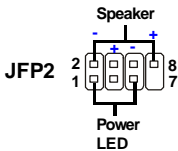

PIN	SIGNAL	DESCRIPTION
1	GND	Ground
2	SPK-	Speaker-
3	SLED	SuspendLED
4	BUZ+	Buzzer+
5	PLED	PowerLED
6	BUZ-	Buzzer-
7	NC	No connection
8	SPK+	Speaker+

CD-In Connector: JCD1

This connector is provided for external audio input.

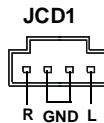

Front Panel Audio Connector: JAUD1

This connector allows you to connect the front panel audio and is compliant with Intel® Front Panel I/O Connectivity Design Guide.

JAUD1



HD Audio Pin Definition

PIN	SIGNAL	DESCRIPTION
1	MIC_L	Microphone - Left channel
2	GND	Ground
3	MIC_R	Microphone - Right channel
4	NC	
5	LINE out_R	Analog Port - Right channel
6	MIC_JD	Jack detection return from front panel microphone JACK1
7	Front_JD	Jack detection sense line from the High Definition Audio CODEC jack detection resistor network
8	NC	No control
9	LINE out_L	Analog Port - Left channel
10	LINEout_JD	Jack detection return from front panel JACK2

TPM Module Connector: JTPM1 (optional)

This connector connects to a TPM (Trusted Platform Module) module (optional). Please refer to the TPM security platform manual for more details and usages.

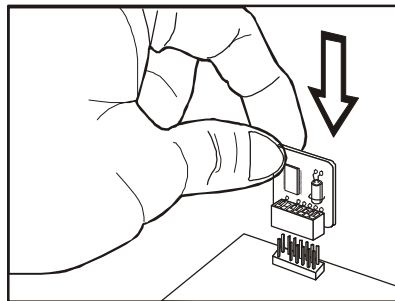

Pin	Signal	Description	Pin	Signal	Description
1	LCLK	LPCclock	2	3V_STB	3Vstandbypower
3	LRST#	LPCreset	4	VCC3	3.3Vpower
5	LAD0	LPC address & data pin0	6	SIRQ	Serial IRQ
7	LAD1	LPC address & data pin1	8	VCC5	5Vpower
9	LAD2	LPC address & data pin2	10	KEY	No pin
11	LAD3	LPC address & data pin3	12	GND	Ground
13	LFRAME#	LPCFrame	14	GND	Ground

Front USB Connector: JUSB1~4

These connectors, compliant with Intel® I/O Connectivity Design Guide, is ideal for connecting high-speed USB interface peripherals such as **USB HDD, digital cameras, MP3 players, printers, modems and the like.**

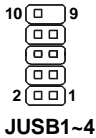

Pin Definition

PIN	SIGNAL	PIN	SIGNAL
1	VCC	2	VCC
3	USB0-	4	USB1-
5	USB0+	6	USB1+
7	GND	8	GND
9	Key (no pin)	10	NC

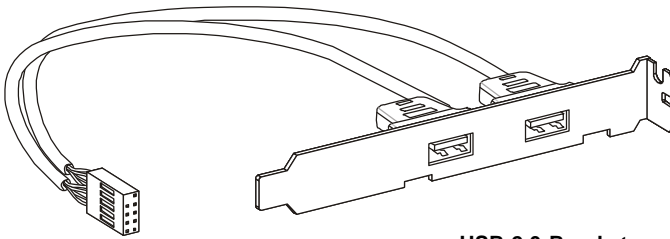

USB 2.0 Bracket
(optional)



Important

Note that the pins of VCC and GND must be connected correctly to avoid possible damage.

Jumpers

Clear CMOS Jumper: JBAT1

There is a CMOS RAM onboard that has a power supply from an external battery to keep the data of system configuration. With the CMOS RAM, the system can automatically boot OS every time it is turned on. If you want to clear the system configuration, set the jumper to clear data.

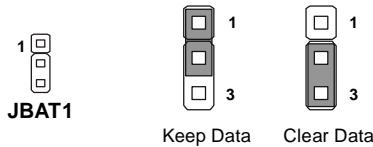

Important

You can clear CMOS by shorting 2-3 pin while the system is off. Then return to 1-2 pin position. Avoid clearing the CMOS while the system is on; it will damage the mainboard.

Hardware Overclock FSB Jumpers: JB1, JB2

You can overclock the FSB to increase the processor frequency by changing the jumpers JB1 and JB2. Follow the instructions below to set the FSB.

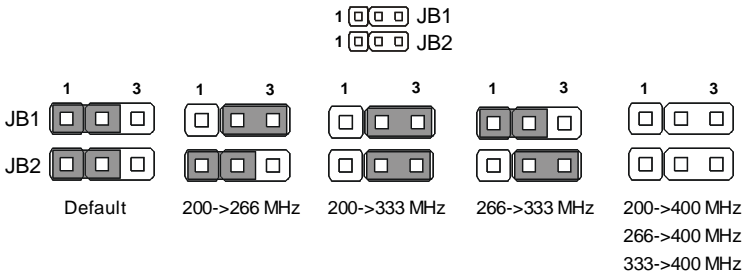

Important

1. Make sure that you power off the system before changing the jumpers.
2. Overclocking may cause instability or crash during boot, then please restore the jumpers to default.

Slots

PCI (Peripheral Component Interconnect) Express Slot

The PCI Express slot supports the PCI Express interface expansion card.

The PCI Express 2.0x 16 supports up to 8.0 GB/s transfer rate.

The PCI Express x 1 supports up to 250 MB/s transfer rate.

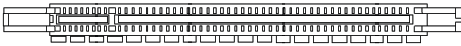

PCI Express x16 Slot

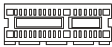

PCI Express x 1 Slot

PCI (Peripheral Component Interconnect) Slot

The PCI slot supports LAN card, SCSI card, USB card, and other add-on cards that comply with PCI specifications.

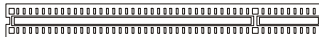

32-bit PCI Slot



Important

When adding or removing expansion cards, make sure that you unplug the power supply first. Meanwhile, read the documentation for the expansion card to configure any necessary hardware or software settings for the expansion card, such as jumpers, switches or BIOS configuration.

PCI Interrupt Request Routing

The IRQ, acronym of interrupt request line and pronounced I-R-Q, are hardware lines over which devices can send interrupt signals to the microprocessor. The PCI IRQ pins are typically connected to the PCI bus pins as follows:

	Order 1	Order 2	Order 3	Order 4
PCI Slot 1	INT A#	INT B#	INT C#	INT D#
PCI Slot 2	INT E#	INT F#	INT G#	INT H#
PCI Slot 3	INT F#	INT G#	INT H#	INT E#
PCI Slot 4	INT G#	INT H#	INT E#	INT F#

Chapter 3

BIOS Setup

This chapter provides information on the BIOS Setup program and allows you to configure the system for optimum use.

You may need to run the Setup program when:

- ≈ An error message appears on the screen during the system booting up, and requests you to run SETUP.
- ≈ You want to change the default settings for customized features.

Entering Setup

Power on the computer and the system will start POST (Power On Self Test) process. When the message below appears on the screen, press key to enter Setup.

Press DEL to enter SETUP

If the message disappears before you respond and you still wish to enter Setup, restart the system by turning it OFF and On or pressing the RESET button. You may also restart the system by simultaneously pressing <Ctrl>, <Alt>, and <Delete> keys.



Important

- 1. The items under each BIOS category described in this chapter are under continuous update for better system performance. Therefore, the description may be slightly different from the latest BIOS and should be held for reference only.*
- 2. Upon boot-up, the 1st line appearing after the memory count is the BIOS version. It is usually in the format:*

A7514IMS V1.0 040108 where:

1st digit refers to BIOS maker as A = AMI, W = AWARD, and P = PHOENIX.

2nd - 5th digit refers to the model number.

6th digit refers to the chipset as I = Intel, N = nVidia, and V = VIA.

7th - 8th digit refers to the customer as MS = all standard customers.

V1.0 refers to the BIOS version.

040108 refers to the date this BIOS was released.

Control Keys

<↑>	Move to the previous item
<↓>	Move to the next item
<←>	Move to the item in the left hand
<→>	Move to the item in the right hand
<Enter>	Select the item
<Esc>	Jumps to the Exit menu or returns to the main menu from a submenu
<+/PU>	Increase the numeric value or make changes
<-/PD>	Decrease the numeric value or make changes
<F6>	Load Optimized Defaults
<F10>	Save all the CMOS changes and exit

Getting Help

After entering the Setup menu, the first menu you will see is the Main Menu.

Main Menu

The main menu lists the setup functions you can make changes to. You can use the arrow keys (↑↓) to select the item. The on-line description of the highlighted setup function is displayed at the bottom of the screen.

Sub-Menu

If you find a right pointer symbol (as shown in the right view) appears to the left of certain fields that means a sub-menu can be launched from this field. A sub-menu contains additional options for a field parameter. You can use arrow keys (↑↓) to highlight the field and press <Enter> to call up the sub-menu. Then you can use the control keys to enter values and move from field to field within a sub-menu. If you want to return to the main menu, just press the <Esc>.



▶ SATA1
▶ SATA2
▶ SATA3
▶ SATA4

General Help <F1>

The BIOS setup program provides a General Help screen. You can call up this screen from any menu by simply pressing <F1>. The Help screen lists the appropriate keys to use and the possible selections for the highlighted item. Press <Esc> to exit the Help screen.

The Main Menu

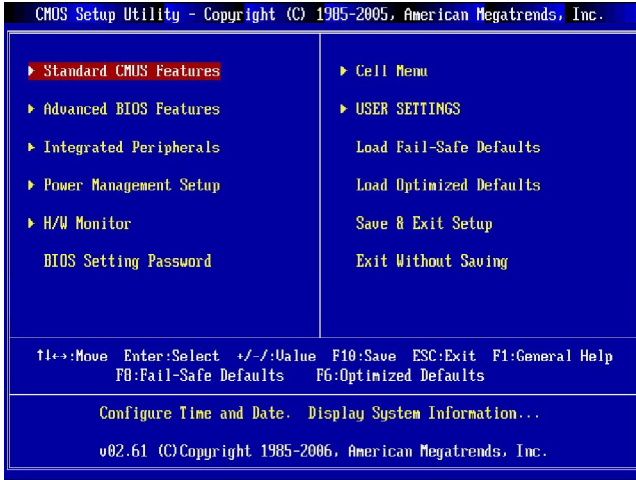

► **Standard CMOS Features**

Use this menu for basic system configurations, such as time, date etc.

► **Advanced BIOS Features**

Use this menu to setup the items of AMI® special enhanced features.

► **Integrated Peripherals**

Use this menu to specify your settings for integrated peripherals.

► **Power Management Setup**

Use this menu to specify your settings for power management.

► **H/W Monitor**

This entry shows your PC health status.

► **BIOS Setting Password**

Use this menu to set the password for BIOS.

► **Cell Menu**

Use this menu to specify your settings for frequency/voltage control and overlocking.

► **USER SETTINGS**

Use this menu to save/ load your settings to/ from CMOS for BIOS.

▶ **Load Fail-Safe Defaults**

Use this menu to load the default values set by the BIOS vendor for stable system performance.

▶ **Load Optimized Defaults**

Use this menu to load the default values set by the mainboard manufacturer specifically for optimal performance of the mainboard.

▶ **Save & Exit Setup**

Save changes to CMOS and exit setup.

▶ **Exit Without Saving**

Abandon all changes and exit setup.

Standard CMOS Features

The items in Standard CMOS Features Menu includes some basic setup items. Use the arrow keys to highlight the item and then use the <PgUp> or <PgDn> keys to select the value you want in each item.

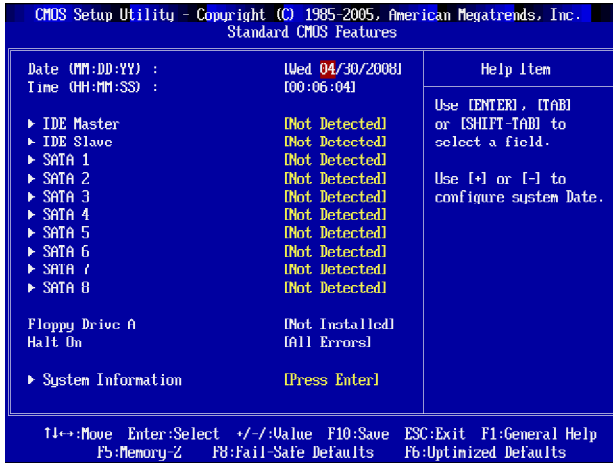

▶ Date (MM:DD:YY)

This allows you to set the system to the date that you want (usually the current date). The format is <day><month> <date> <year>.

- day** Day of the week, from Sun to Sat, determined by BIOS. Read-only.
- month** The month from Jan. to Dec.
- date** The date from 1 to 31 can be keyed by numeric function keys.
- year** The year can be adjusted by users.

▶ Time (HH:MM:SS)

This allows you to set the system time that you want (usually the current time). The time format is <hour> <minute> <second>.

▶ IDE Master/ Slave, SATA1-8

Press <Enter> to enter the sub-menu, and the following screen appears.

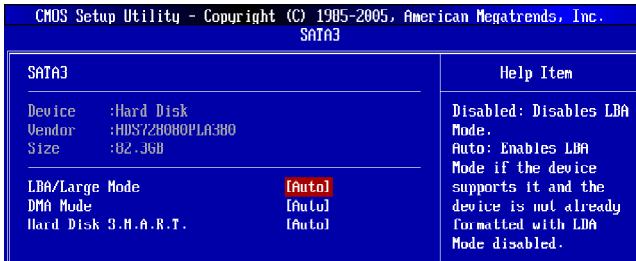

► **Device / Vendor / Size**

It will showing the device information that you connected to the SATA connector.

► **LBA/Large Mode**

This allows you to enable or disable the LBA Mode. Setting to Auto enables LBA mode if the device supports it and the devices is not already formatted with LBA mode disabled.

► **DMA Mode**

Select DMA Mode.

► **Hard Disk S.M.A.R.T.**

This allows you to activate the S.M.A.R.T. (Self-Monitoring Analysis & Reporting Technology) capability for the hard disks. S.M.A.R.T is a utility that monitors your disk status to predict hard disk failure. This gives you an opportunity to move data from a hard disk that is going to fail to a safe place before the hard disk becomes offline.



Important

IDE Master/ Slave, SATA 1~8 are appearing when you connect the HD devices to the IDE/ SATA connectors on the mainboard.

► **Floppy Drive A**

This item allows you to set the type of floppy drives installed. Available options: [Not install], [360KB], [1.2MB], [720KB], [1.44MB], [2.88MB].

► **Halt On**

The setting determines whether the system will stop if an error is detected at boot. When the system stops for the errors preset, it will halt on for 15 seconds and then automatically resume its operation. Available options are:

- | | |
|---------------------|--|
| [All Errors] | The system stops when any error is detected. |
| [No Errors] | The system doesn't stop for any detected error. |
| [All, But Keyboard] | The system doesn't stop for a keyboard error. |
| [All, But Diskette] | The system doesn't stop for a disk error. |
| [All, But Disk/Key] | The system doesn't stop for either a disk or a keyboard error. |

► System Information

Press <Enter> to enter the sub-menu, and the following screen appears.

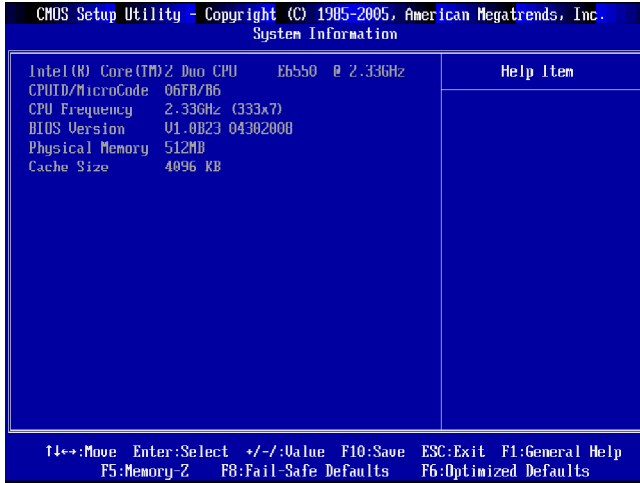

This sub-menu shows the CPU information, BIOS version and memory status of your system (read only).

Advanced BIOS Features

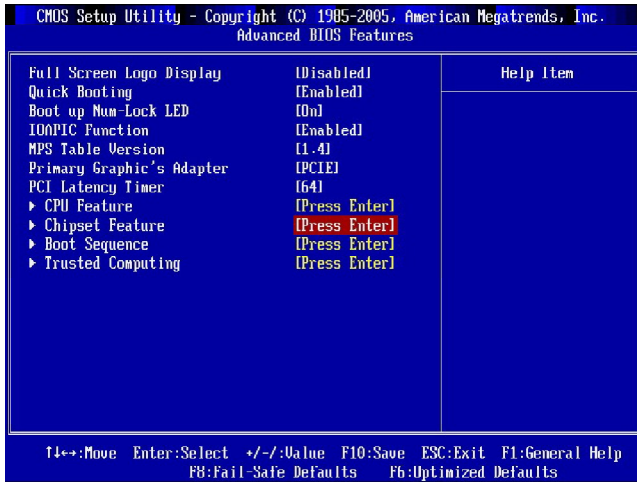

▶ Full Screen Logo Display

This item enables this system to show the company logo on the bootup screen. Settings are:

- [Enabled] Shows a still image (logo) on the full screen at boot.
- [Disabled] Shows the POST messages at boot.

▶ Quick Booting

Setting the item to [Enabled] allows the system to boot within 10 seconds since it will skip some check items.

▶ Boot Up Num-Lock LED

This setting is to set the Num Lock status when the system is powered on. Setting to [On] will turn on the Num Lock key when the system is powered on. Setting to [Off] will allow users to use the arrow keys on the numeric keypad.

▶ IOAPIC Function

This field is used to enable or disable the APIC (Advanced Programmable Interrupt Controller). Due to compliance with PC2001 design guide, the system is able to run in APIC mode. Enabling APIC mode will expand available IRQ resources for the system.

▶ MPS Table Version

This field allows you to select which MPS (Multi-Processor Specification) version to be used for the operating system. You need to select the MPS version supported by your operating system. To find out which version to use, consult the vendor of your operating system.

► Primary Graphic's Adapter

This setting specifies which graphic card is your primary graphics adapter.

► PCI Latency Timer

This item controls how long each PCI device can hold the bus before another takes over. When set to higher values, every PCI device can conduct transactions for a longer time and thus improve the effective PCI bandwidth. For better PCI performance, you should set the item to higher values.

► CPU Feature

Press <Enter> to enter the sub-menu and the following screen appears:



► Execute Bit Support

Intel's Execute Disable Bit functionality can prevent certain classes of malicious "buffer overflow" attacks when combined with a supporting operating system. This functionality allows the processor to classify areas in memory by where application code can execute and where it cannot. When a malicious worm attempts to insert code in the buffer, the processor disables code execution, preventing damage or worm propagation.

► Set Limit CPUID MaxVal to 3

The Max CPUID Value Limit is designed limit the listed speed of the processor to older operating systems.

► Chipset Feature

Press <Enter> to enter the sub-menu and the following screen appears:



► HPET

The HPET (High Precision Event Timers) is a component that is part of the chipset. You can enable it, and it will provide you with the means to get to it via the various ACPI methods.

► **Boot Sequence**

Press <Enter> to enter the sub-menu and the following screen appears:

CMOS Setup Utility - Copyright (C) 1985-2005, American Megatrends, Inc.		
Boot Sequence		
1st Boot Device	[1st FLOPPY DRI]	Help Item
2nd Boot Device	[USB:Netac Only]	
Boot From Other Device	[Yes]	Specifies the boot

► **1st/ 2nd Boot Device**

The items allow you to set the first/ second boot device where BIOS attempts to load the disk operating system.

► **Boot From Other Device**

Setting the option to [Yes] allows the system to try to boot from other device, if the system fails to boot from 1st/ 2nd boot device.

► **Trusted Computing**

Press <Enter> to enter the sub-menu and the following screen appears:

CMOS Setup Utility - Copyright (C) 1985-2005, American Megatrends, Inc.		
Trusted Computing		
Trusted Computing		Help Item
TCG/TPM SUPPORT	[Yes]	Enable/Disable TPM
Execute TPM Command	[Don't change]	TCG (TPM 1.1/1.2) supp
Clearing the TPM	[Press Enter]	in BIOS
TPM Enable/Disable Status	[No State]	
TPM Owner Status	[No State]	

► **TCG/TPM SUPPORT**

Setting the option to [Yes] enables TPM (Trusted Platform Module) to the system.

► **Execute TPM Command**

Setting the option to [Enable] allows the system to execute TPM Command.

► **Clearing the TPM**

Press Enter to clear the TPM status.

► **TPM Enable/Disable status, TPM Owner Status**

These items show the status of TPM (read only).

Integrated Peripherals

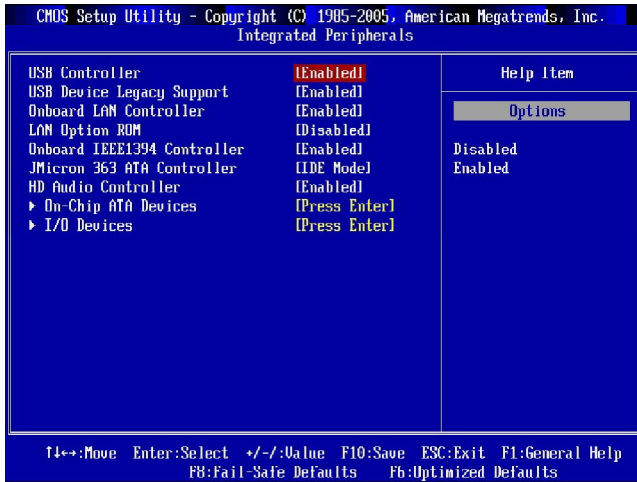

▶ USB Controller

This setting allows you to enable/disable the onboard USB controller.

▶ USB Device Legacy Support

Select [Enabled] if you need to use a USB-interfaced device in the operating system.

▶ Onboard LAN Controller

This item is used to enable/disable the onboard 1st LAN controller.

▶ LAN Option ROM

This item is used to decide whether to invoke the Boot ROM of the LAN controller.

▶ Onboard IEEE1394 Controller

This item allows you to enable/disable the onboard IEEE1394 controller.

▶ JMicron 363 ATA Controller

This item allows you to enable/disable the JMicron controller.

▶ HD Audio Controller

This setting is used to enable/disable the onboard audio controller.

► **On-Chip ATA Devices**

Press <Enter> to enter the sub-menu and the following screen appears:

CMOS Setup Utility - Copyright (C) 1995-2005, American Megatrends, Inc.		
On-Chip ATA Devices		
		Help Item
PCI IDE BusMaster	[Disabled]	
On-Chip SATA Controller	[Enabled]	
RAID Mode	[AHCI]	DISABLED: Use if this channel on card does
► AHCI Configuration	[Press Enter]	

► **PCI IDE BusMaster**

This item allows you to enable/ disable BIOS to used PCI busmastering for reading/ writing to IDE drives.

► **On-Chip SATA Controller**

These items allow users to enable or disable the SATA controller.

► **RAID Mode**

This item allows you to configure SATA RAID mode. Setting options: [RAID], [AHCI] or [IDE].

► **AHCI Configuration**

When the "RAID Mode" sets to [AHCI], this field is available. Press <Enter> to enter the sub-menu and the following screen appears:

CMOS Setup Utility - Copyright (C) 1995-2005, American Megatrends, Inc.		
AHCI Configuration		
AHCI Settings		Help Item
AHCI CD/DVD Boot Time out	[35]	Some SATA CD/DVD in AHCI mode need to wait ready longer.
► AHCI Port1	[Not Detected]	
► AHCI Port2	[Not Detected]	

► **AHCI CD/DVD Boot Time out**

Select the waiting time for the AHCI CD/ DVD when booting.

► **AHCI Port 1~6**

Press <Enter> to enter the sub-menu and the following screen appears:

CMOS Setup Utility - Copyright (C) 1995-2005, American Megatrends, Inc.		
AHCI Port1		
AHCI Port1		Help Item
Device :Not Detected		Select the type of device connected to the system.
AHCI Port 1	[Auto]	
Hard Disk S.M.A.R.T.	[Enabled]	

MS-7514 Mainboard

► AHCI Port 1-6

Select the type of device.

► Hard Disk S.M.A.R.T.

This allows you to activate the S.M.A.R.T. (Self-Monitoring Analysis & Reporting Technology) capability for the hard disks. S.M.A.R.T is a utility that monitors your disk status to predict hard disk failure. This gives you an opportunity to move data from a hard disk that is going to fail to a safe place before the hard disk becomes offline.

► I/O Device

Press <Enter> to enter the sub-menu and the following screen appears:



CMOS Setup Utility - Copyright (C) 1985-2005, American Megatrends, Inc.		
I/O Devices		
COM Port 1	[F8/IRQ4]	Help Item Allows BIOS to Select Serial Port1 Base
Parallel Port	[378]	
Parallel Port Mode	[Bi-Directional]	

► COM Port 1

Select an address and corresponding interrupt for the first serial port.

► Parallel Port

There is a built-in parallel port on the on-board Super I/O chipset that provides Standard, ECP, and EPP features. It has the following options:

[Disabled]

[3BC]	Line Printer port 0
[278]	Line Printer port 2
[378]	Line Printer port 1

► Parallel Port Mode

[Normal]	Standard Parallel Port
[EPP]	Enhanced Parallel Port
[ECP]	Extended Capability Port
[ECP+EPP]	Extended Capability Port + Enhanced Parallel Port
[Bi-Directional]	

To operate the onboard parallel port as Standard Parallel Port only, choose [Normal]. To operate the onboard parallel port in the EPP mode simultaneously, choose [EPP]. By choosing [ECP], the onboard parallel port will operate in ECP mode only. Choosing [ECP + EPP] will allow the onboard parallel port to support both the ECP and EPP modes simultaneously.

Power Management Setup

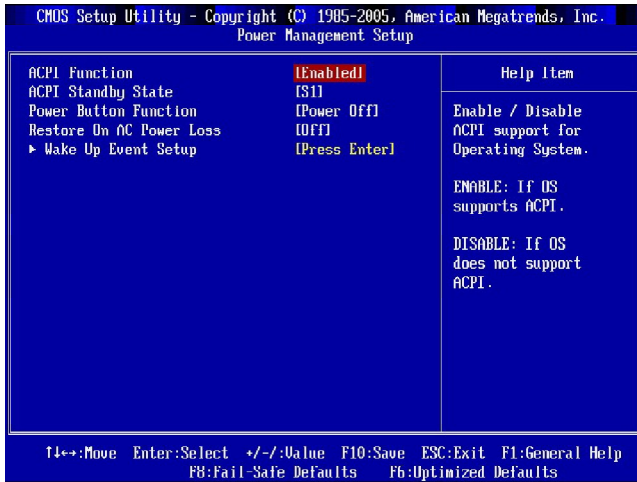

Important

S3-related functions described in this section are available only when your BIOS supports S3 sleep mode.

▶ ACPI Function

This item is to activate the ACPI (Advanced Configuration and Power Management Interface) Function. If your operating system is ACPI-aware, such as Windows 2000/XP, select [Enabled].

▶ ACPI Standby State

This item specifies the power saving modes for ACPI function. If your operating system supports ACPI, such as Windows 2000/XP, you can choose to enter the Standby mode in S1(POS) or S3(STR) fashion through the setting of this field. Settings are:

- [S1] The S1 sleep mode is a low power state. In this state, no system context is lost (CPU or chipset) and hardware maintains all system context.
- [S3] The S3 sleep mode is a lower power state where the information of system configuration and open applications/files is saved to main memory that remains powered while most other hardware components turn off to save energy. The information stored in memory will be used to restore the system when a "wake up" event occurs.

► Power Button Function

This feature sets the function of the power button. Settings are:

- [Power On/ Off] The power button functions as normal power off button.
- [Suspend] When you press the power button, the computer enters the suspend/sleep mode, but if the button is pressed for more than four seconds, the computer is turned off.

► Restore On AC Power Loss

This item specifies whether your system will reboot after a power failure or interrupt occurs. Settings are:

- [Off] Always leaves the computer in the power off state.
- [On] Always leaves the computer in the power on state.
- [Last State] Restores the system to the status before power failure or interrupt occurred.

► Wake Up Event Setup

Press <Enter> and the following sub-menu appears.



► Wake Up Event By

Setting to [BIOS] activates the following fields, and use the following fields to set the wake up events. Setting to [OS], the wake up events will be defined by OS.

► Resume From S3 By USB Device

The item allows the activity of the USB device to wake up the system from S3 (Suspend to RAM) sleep state.

► Resume From S3 By PS/2 Keyboard

This setting determines whether the system will be awakened from what power saving modes when input signal of the PS/2 keyboard is detected.

► Resume From S3 By PS/2 Mouse

This setting determines whether the system will be awakened from what power saving modes when input signal of the PS/2 mouse is detected.

► Resume By PCI Device (PME#)

When set to [Enabled], the feature allows your system to be awakened from the power saving modes through any event on PME (Power Management Event).

▶ Resume By PCI-E Device

When set to [Enabled], the feature allows your system to be awakened from the power saving modes through any event on PCIE device.

▶ Resume By RTC Alarm

The field is used to enable or disable the feature of booting up the system on a scheduled time/date.

H/W Monitor

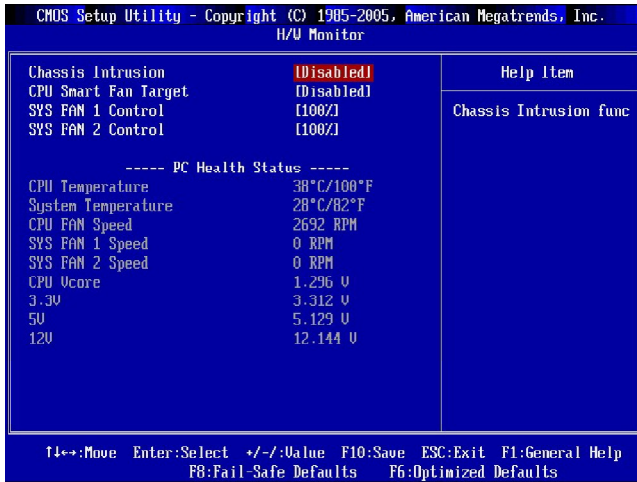

► Chassis Intrusion

The field enables or disables the feature of recording the chassis intrusion status and issuing a warning message if the chassis is once opened. To clear the warning message, set the field to [Reset]. The setting of the field will automatically return to [Enabled] later.

► CPU Smart FAN Target

The mainboard provides the Smart Fan function which can control the CPU fan speed automatically depending on the current temperature to keep it within a specific range. You can enable a fan target value here. If the current CPU fan temperature reaches to the target value, the smart fan function will be activated. It provides several sections to speed up for cooling down automatically.

► SYS FAN1/2 Control

This item allows users to select how percentage of speed for the SYS FAN1/2.

► PC Health Status

► CPU/ System Temperature, CPU FAN/ SYS FAN Speed, CPU Vcore, 3.3V, 5V, 12V

These items display the current status of all of the monitored hardware devices/ components such as CPU voltage, temperatures and all fans' speeds.

BIOS Setting Password

When you select this function, a message as below will appear on the screen:



Type the password, up to six characters in length, and press <Enter>. The password typed now will replace any previously set password from CMOS memory. You will be prompted to confirm the password. Retype the password and press <Enter>. You may also press <Esc> to abort the selection and not enter a password.

To clear a set password, just press <Enter> when you are prompted to enter the password. A message will show up confirming the password will be disabled. Once the password is disabled, the system will boot and you can enter Setup without entering any password.

When a password has been set, you will be prompted to enter it every time you try to enter Setup. This prevents an unauthorized person from changing any part of your system configuration.

Cell Menu

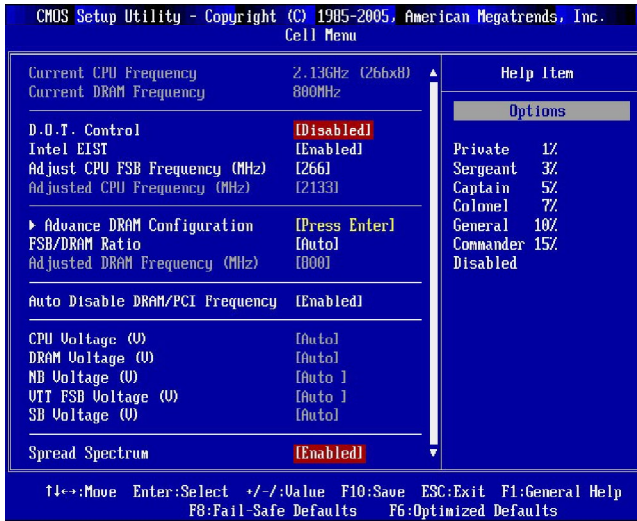

Important

Change these settings only if you are familiar with the chipset.

► Current CPU / DRAM Frequency

These items show the current clocks of CPU and Memory speed. Read-only.

► D.O.T. Control

D.O.T. (Dynamic Overclocking Technology) is an automatic overclocking function, included in the MSI™'s newly developed Dual CoreCell™ Technology. It is designed to detect the load balance of CPU while running programs, and to adjust the best frequency automatically. When the mainboard detects system is running programs, it will speed up automatically to make the program run smoothly and faster. When the system is temporarily suspending or staying in the low load balance, it will restore the default settings instead. Usually the Dynamic Overclocking Technology will be powered only when users' PC need to run huge amount of data like 3D games or the video process, and the CPU and PCIE frequency need to be boosted up to enhance the overall performance.



Important

Even though the Dynamic Overclocking Technology is more stable than manual overclocking, basically, it is still risky. We suggest user to make sure that your CPU / memory modules can afford to overclocking regularly first. If you find the PC appears to be unstable or reboot incidentally, it's better to disable the Dynamic Overclocking or to lower the level of overclocking options. By the way, if you need to conduct overclocking manually, you also need to disable the Dynamic OverClocking first.

► Intel EIST

The Enhanced Intel SpeedStep technology allows you to set the performance level of the microprocessor whether the computer is running on battery or AC power. This field will appear after you installed the CPU which support speedstep technology.

► Adjust CPU FSB Frequency (MHz)

This item allows you to set the CPU FSB frequency (in MHz). This item will disappear after you set the

► Adjusted CPU FSB Frequency (MHz)

It shows the adjusted CPU frequency (FSB x Ratio). Read-only.

► Advance DRAM Configuration

Press <Enter> to enter the sub-menu and the following screen appears.



► Configure DRAM Timing by SPD

Setting to [Auto] enables DRAM CAS# Latency automatically to be determined by BIOS based on the configurations on the SPD (Serial Presence Detect) EEPROM on the DRAM module.

► MEMORY-Z

Press <Enter> to enter the sub-menu and the following screen appears.

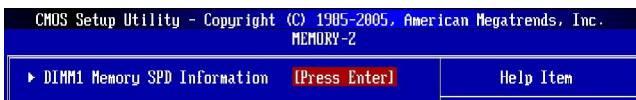

► DIMM1~4 Memory SPD Infomation

Press <Enter> to enter the sub-menu and the following screen appears.

CMOS Setup Utility - Copyright (C) 1985-2005, American Megatrends, Inc.	
DIMM1 Memory SPD Information	
DIMM1 Memory SPD Information	Help Item
Memory Type: DDR2 SDRAM	
Manufacture: Corsair	
Part Number: CM2X512A-6400	
Serial Number:00	
Memory CAS Latency Support:4.5	
SDRAM CYCLE TIME:2.5ns	
MEMORY TRP: 12.50ns(5CLK)	
MEMORY TRCD: 12.50ns(5CLK)	
MEMORY TRAS: 45ns(18CLK)	
MEMORY TRC: 55.0ns(22CLK)	
MEMORY TRTP: 7.50ns(3CLK)	
MEMORY TRRD: 7.50ns(3CLK)	
MEMORY TWR: 15.0ns(6CLK)	
MEMORY TWTR: 7.50ns(3CLK)	

► DIMM1~4 Memory SPD Infomation

These items display the current status of the current DIMM Memory speed information such as memory type, max bandwidth, manufacture, part number, serial number, SDRAM cycle time, DRAM TCL, DRAM TRCD, DRAM TRP, DRAM TRAS, DRAM TRFC, DRAM TWR, DRAM TWTR, DRAM TRRD and DRAM TRTP. They are read only.

► FSB/DRAM Ratio

This item will allow you to adjust the ratio of FSB to memory.

► Adjusted DRAM Frequency (MHz)

It shows the adjusted DDR Memory frequency. Read-only.

► Auto Disable DRAM/PCI Frequency

When set to [Enabled], the system will remove (turn off) clocks from empty DIMM and PCI slots to minimize the electromagnetic interference (EMI).

► CPU Voltage (V) / DRAM Voltage (V) / NB Voltage (V) / VTT FSB Voltage(V) / SB Voltage (V)

These items are used to asjst the voltage of CPU, Memory, FSB and chipset.

► Spread Spectrum

When the mainboard's clock generator pulses, the extreme values (spikes) of the pulses create EMI (Electromagnetic Interference). The Spread Spectrum function reduces the EMI generated by modulating the pulses so that the spikes of the pulses are reduced to flatter curves. If you do not have any EMI problem, leave the setting at Disabled for optimal system stability and performance. But if you are plagued by EMI, set to Enabled for EMI reduction. Remember to disable Spread Spectrum if you are overclocking because even a slight jitter can introduce a temporary boost in clock speed which may just cause your overclocked processor to lock up.



Important

1. *If you do not have any EMI problem, leave the setting at [Disabled] for optimal system stability and performance. But if you are plagued by EMI, select the value of Spread Spectrum for EMI reduction.*
2. *The greater the Spread Spectrum value is, the greater the EMI is reduced, and the system will become less stable. For the most suitable Spread Spectrum value, please consult your local EMI regulation.*
3. *Remember to disable Spread Spectrum if you are overclocking because even a slight jitter can introduce a temporary boost in clock speed which may just cause your overclocked processor to lock up.*

USER SETTINGS

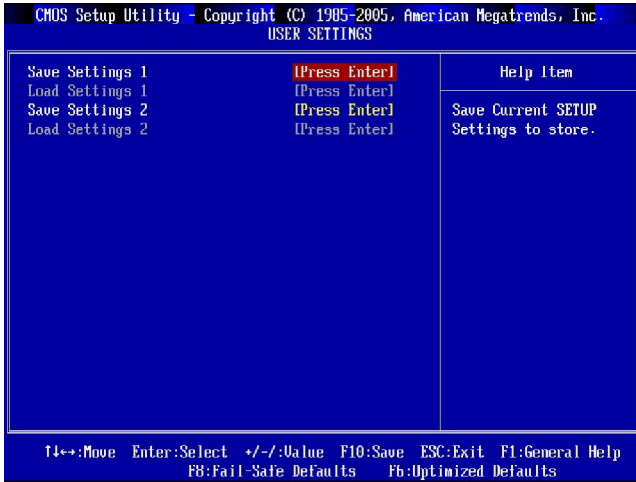

► Save Settings 1/ 2

These items are used to save the settings set by yourself to CMOS.

► Load Settings 1/ 2

These items are available after you save your settings in **Save Settings 1/ 2** items, and are used to load the settings from CMOS.

Load Fail-Safe/ Optimized Defaults

The two options on the main menu allow users to restore all of the BIOS settings to the default Fail-Safe or Optimized values. The Optimized Defaults are the default values set by the mainboard manufacturer specifically for optimal performance of the mainboard. The Fail-Safe Defaults are the default values set by the BIOS vendor for stable system performance.

When you select Load Fail-Safe Defaults, a message as below appears:



Selecting Ok and pressing *Enter* loads the BIOS default values for the most stable, minimal system performance.

When you select Load Optimized Defaults, a message as below appears:



Selecting Ok and pressing *Enter* loads the default factory settings for optimal system performance.

Appendix A

Realtek ALC888 Audio

The Realtek ALC888 provides 10-channel DAC that simultaneously supports 7.1 sound playback and 2 channels of independent stereo sound output (multiple streaming) through the Front-Out-Left and Front-Out-Right channels.

Installing the Realtek HD Audio Driver

You need to install the HD audio driver for Realtek ALC888 codec to function properly before you can get access to 2-, 4-, 6-, 8- channel or 7.1+2 channel audio operations. Follow the procedures described below to install the drivers for different operating systems.

Installation for Windows XP/ Vista

For Windows® XP, you must install Windows® XP Service Pack1 or later before installing the driver.

The following illustrations are based on Windows® XP environment and could look slightly different if you install the drivers in different operating systems.

1. Insert the application CD into the CD-ROM drive. The setup screen will automatically appear.
2. Click **Realtek HD Audio Driver**.



Click here



Important

*The **HD Audio Configuration** software utility is under continuous update to enhance audio applications. Hence, the program screens shown here in this section may be slightly different from the latest software utility and shall be held for reference only.*

3. Click **Next** to install the Realtek High Definition Audio Driver.

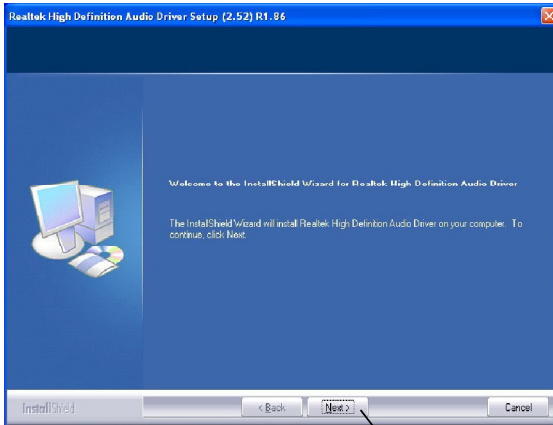

Click here

4. Click **Finish** to restart the system.

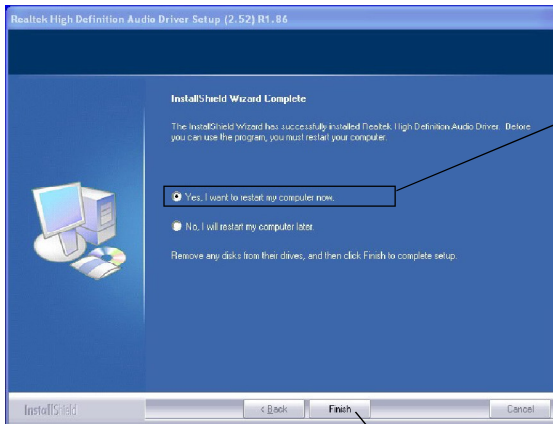

Select this option

Click here

Software Configuration

After installing the audio driver, you are able to use the 2-, 4-, 6- or 8- channel audio feature now. Click the audio icon  from the system tray at the lower-right corner of the screen to activate the **HD Audio Configuration**. It is also available to enable the **HD Audio Configuration** by clicking the **Realtek HD Audio Manager** from the **Control Panel**.

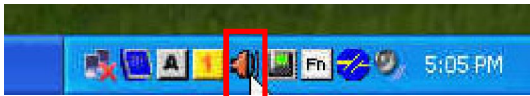

Double click

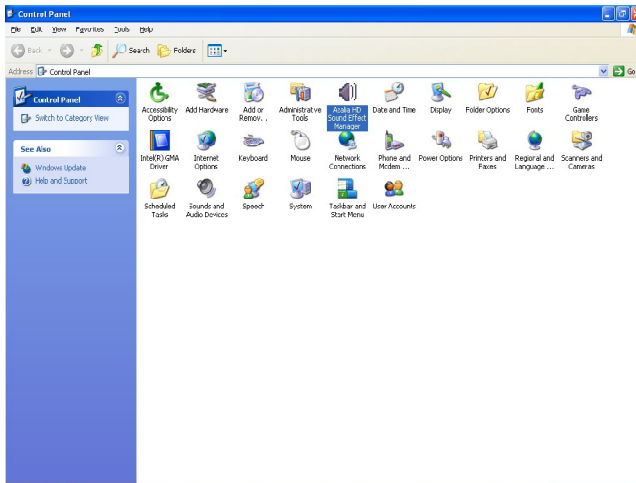

Sound Effect

Here you can select a sound effect you like from the **Environment** list.

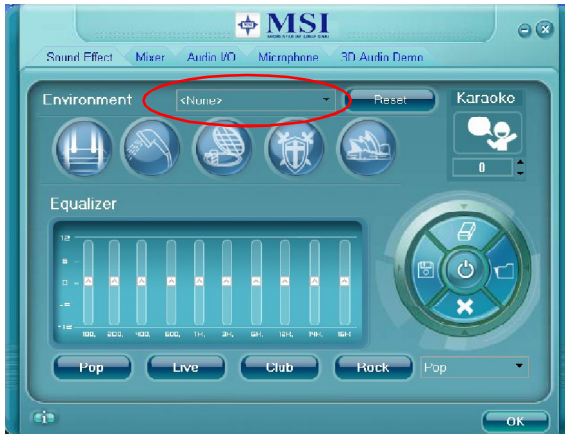

Environment Simulation

You will be able to enjoy different sound experience by pulling down the arrow, several kinds of sound effect will be shown for selection. Realtek HD Audio Sound Manager also provides five popular settings “Stone Corridor”, “Bathroom”, “Sewer pipe”, “Arena” and “Audio Corridor” for quick enjoyment.

You may choose the provided sound effects, and the equalizer will adjust automatically. If you like, you may also load an equalizer setting or make an new equalizer setting to save as an new one by using the **“Load EQ Setting”** and **“Save Preset”** button, click **“Reset EQ Setting”** button to use the default value, or click **“Delete EQ Setting”** button to remove a preset EQ setting.

There are also other pre-set equalizer models for you to choose by clicking **“Others”** under the **Equalizer** part.

Equalizer Selection

Equalizer frees users from default settings; users may create their own preferred settings by utilizing this tool.

10 bands of equalizer, ranging from 100Hz to 16KHz.

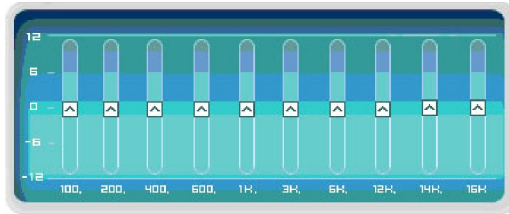

Save

The settings are saved permanently for future use

Reset

10 bands of equalizer would go back to the default setting

Enable / Disable

To disable, you can temporarily stop the sound effect without losing the settings

Load

Whenever you would like to use preload settings, simply click this, the whole list will be shown for your selection.

Delete

To delete the pre-saved settings which are created from previous steps.



Frequently Used Equalizer Setting

Realtek recognizes the needs that you might have. By leveraging our long experience at audio field, Realtek HD Audio Sound Manager provides you certain optimized equalizer settings that are frequently used for your quick enjoyment.

[How to Use It]

Other than the buttons “Pop” “Live” “Club” & “Rock” shown on the page, to pull down the arrow in “Others”, you will find more optimized settings available to you.

Karaoke Mode

Karaoke mode brings Karaoke fun back home. Simply using the music you usually play, Karaoke mode can help you eliminate the vocal of the song or adjust the key to accommodate your range.

- 1.Vocal Cancellation: Single click on “Voice Cancellation”, the vocal of the song would be eliminated, while the background music is still in place, and you can be that singer!
- 2.Key Adjustment: Using “Up / Down Arrow” to find a key which better fits your vocal range.

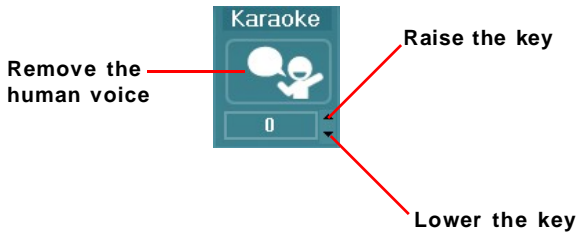

Mixer

In the **Mixer** part, you may adjust the volumes of the rear and front panels individually.

1. Adjust Volume

You can adjust the volume of the speakers that you plugged in front or rear panel by select the **Realtek HD Audio rear output** or **Realtek HD Audio front output** items.



Important

*Before set up, please make sure the playback devices are well plugged in the jacks on the rear or front panel. The **Realtek HD Audio front output** item will appear after you plugging the speakers into the jacks on the front panel.*

2. Multi-Stream Function

ALC888 supports an outstanding feature called Multi-Stream, which means you may play different audio sources simultaneously and let them output respectively from the indicated rear panel or front panel. This feature is very helpful when 2 people are using the same computer together for different purposes.

Click the  button and the Mixer **ToolBox** menu will appear. Then check the **Enable playback multi-streaming** and click **OK** to save the setup.



Important

*If you use **AC97 front panel**, the device have to be plugged into the jacks on the panel before enable the multi-stream function.*

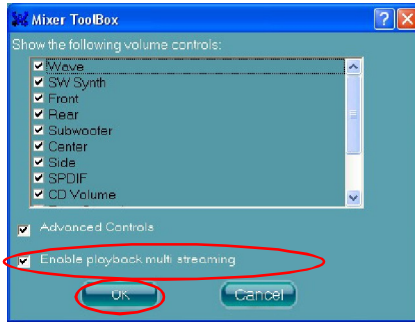

When you are playing the first audio source (for example: use Windows Media Player to play DVD/VCD), the output will be played from the rear panel, which is the default setting.

Then you **must** to select the **Realtek HD Audio front output** from the scroll list **first**, and use a different program to play the second audio source (for example: use Winamp to play MP3 files). You will find that the second audio source (MP3 music) will come out from the Line-Out audio jack of Front Panel.



3. Playback control



Tool **Mute**

Playback device
This function is to let you freely decide which ports to output the sound. And this is essential when multi-streaming playback enabled.
- Realtek HD Audio Rear Output
- Realtek HD Audio Front Output

Mute

You may choose to mute single or multiple volume controls or to completely mute sound output.

Tool

- Show the following volume controls

This is to let you freely decide which volume control items to be displayed.

- Advanced controls

- Enable playback multi-streaming

With this function, you will be able to have an audio chat with your friends via headphone (stream 1 from front panel) while still have music (stream 2 from back panel) in play. At any given period, you can have maximum 2 streams operating simultaneously.

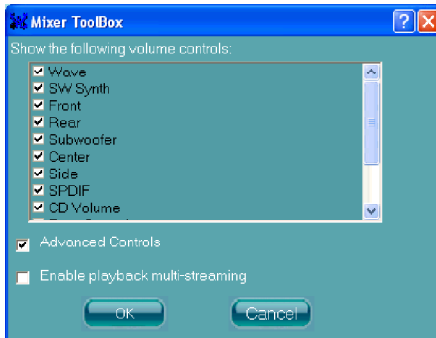

4. Recording control

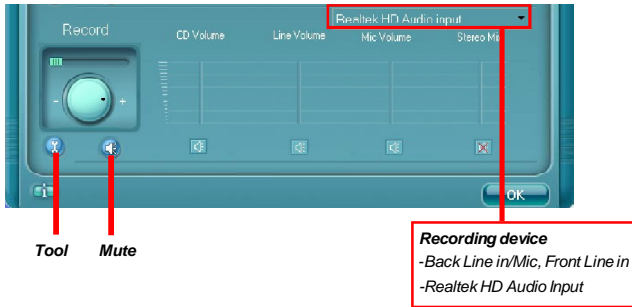

Mute

You may choose to mute single or multiple volume controls or to completely mute sound input.

Tool

- Show the following volume controls

This is to let you freely decide which volume control items to be displayed.

- Enable recording multi-streaming



Important

ALC888 allows you to record the CD, Line, Mic and Stereo Mix channels simultaneously, frees you from mixing efforts. At any given period, you may choose 1 of the following 4 channels to record.

Audio I/O

In this tab, you can easily configure your multi-channel audio function and speakers. You can choose a desired multi-channel operation here.

- a. **Headphone** for the common headphone
- b. **2CH Speaker** for Stereo-Speaker Output
- c. **4CH Speaker** for 4-Speaker Output
- d. **6CH Speaker** for 5.1-Speaker Output
- e. **8CH Speaker** for 7.1-Speaker Output



Speaker Configuration:

1. Plug the speakers in the corresponding jack.
2. Dialogue "connected device" will pop up for your selection. Please select the device you have plugged in.
 - If the device is being plugged into the correct jack, you will be able to find the icon beside the jack changed to the one that is same as your device.
 - If not correct, Realtek HD Audio Manager will guide you to plug the device into the correct jack.

Connector Settings

Click  to access connector settings.



Disable front panel jack detection (option)

Find no function on front panel jacks? Please check if front jacks on your system are so-called AC'97 jacks. If so, please check this item to disable front panel jack detection.

Mute rear panel output when front headphone plugged in.

Enable auto popup dialogue, when device has been plugged in

Once this item checked, the dialog "Connected device" would automatically pop up when device plugged in.

S/PDIF

Short for Sony/Philips Digital Interface, a standard audio file transfer format. S/PDIF allows the transfer of digital audio signals from one device to another without having to be converted first to an analog format. Maintaining the viability of a digital signal prevents the quality of the signal from degrading when it is converted to analog.

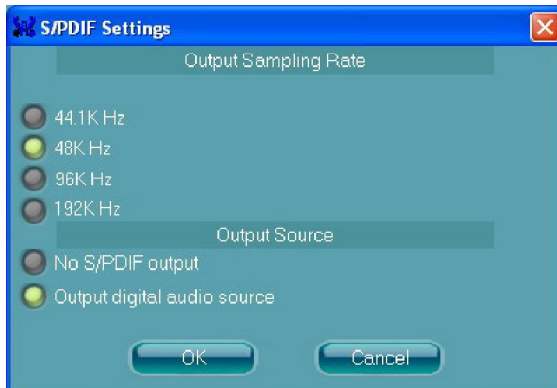

Output Sampling Rate

44.1KHz: This is recommend while playing CD.

48KHz: This is recommended while playing DVD or Dolby.

96KHz: This is recommended while playing DVD-Audio.

192KHz: This is recommended while playing High quality Audio.

Output Source

Output digital audio source: The digital audio format (such as .wav, .mp3,.midi etc) will come out through S/PDIF-Out.

Test Speakers

You can select the speaker by clicking it to test its functionality. The one you select will light up and make testing sound. If any speaker fails to make sound, then check whether the cable is inserted firmly to the connector or replace the bad speakers with good ones. Or you may click the **auto test**  button to test the sounds of each speaker automatically.

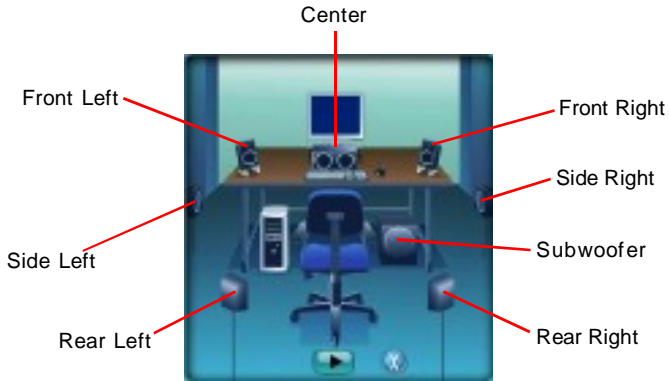

Microphone

In this tab you may set the function of the microphone. Select the **Noise Suppression** to remove the possible noise during recording, or select **Acoustic Echo Cancellation** to cancel the acoustic echo during recording.

Acoustic Echo Cancellation prevents playback sound from being recorded by microphone together with your sound. For example, you might have chance to use VOIP function through Internet with your friends. The voice of your friend will come out from speakers (playback). However, the voice of your friend might also be recorded into your microphone then go back to your friend through Internet. In that case, your friend will hear his/her own voice again. With AEC(Acoustic Echo Cancellation) enabled at your side, your friend can enjoy the benefit with less echo.

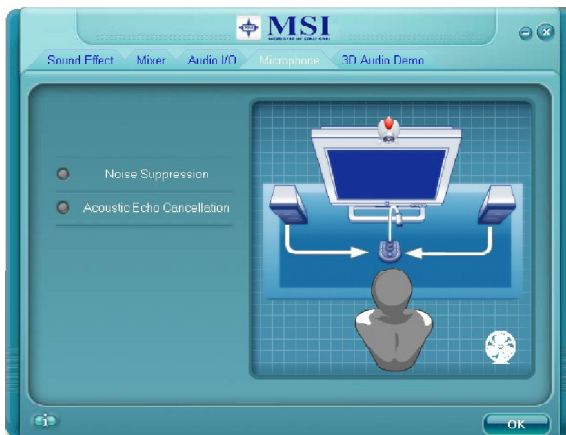

3D Audio Demo

In this tab you may adjust your 3D positional audio before playing 3D audio applications like gaming. You may also select different environment to choose the most suitable environment you like.



Information

In this tab it provides some information about this HD Audio Configuration utility, including Audio Driver Version, DirectX Version, Audio Controller & Audio Codec. You may also select the language of this utility by choosing from the **Language** list.

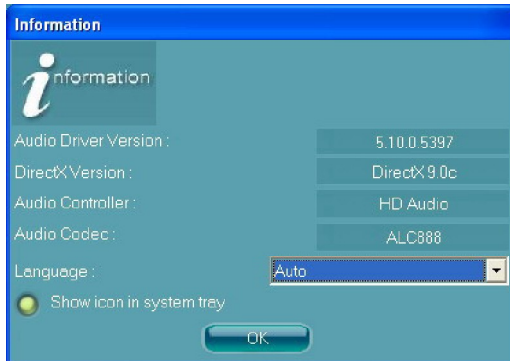

Also there is a selection **Show icon in system tray**. Switch it on and an icon  will show in the system tray. Right-click on the icon and the **Audio Accessories** dialogue box will appear which provides several multimedia features for you to take advantage of.



Hardware Setup

Connecting the Speakers

When you have set the Multi-Channel Audio Function mode properly in the software utility, connect your speakers to the correct phone jacks in accordance with the setting in software utility.

n 2-Channel Mode for Stereo-Speaker Output

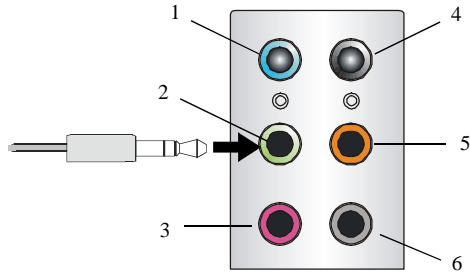

- 1 Line In
- 2 Line Out (*Front channels*)
- 3 MC
- 4 No function
- 5 No function
- 6 No function

n 4-Channel Mode for 4-Speaker Output

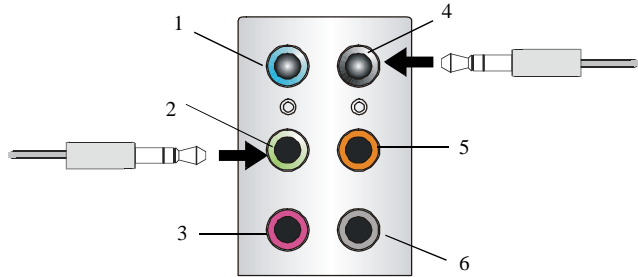

- 1 Line In
- 2 Line Out (*Front channels*)
- 3 MIC
- 4 Line Out (*Rear channels*)
- 5 No function
- 6 No function

n 6-Channel Mode for 6-Speaker Output

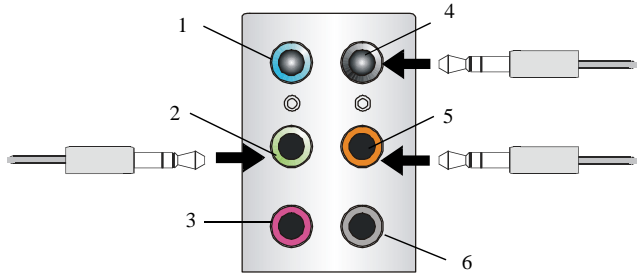

- 1 Line In
- 2 Line Out (*Front channels*)
- 3 MIC
- 4 Line Out (*Rear channels*)
- 5 Line Out (*Center and Subwoofer channel*)
- 6 No function

n 8-Channel Mode for 8-Speaker Output

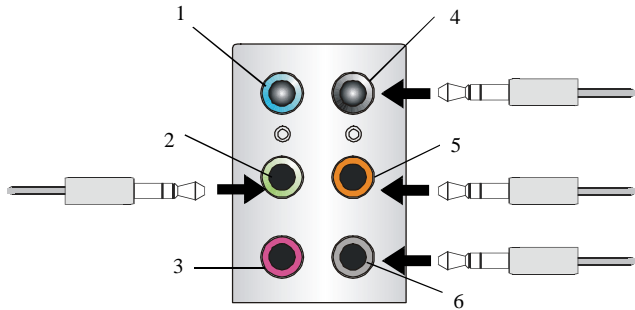

- 1 Line In
- 2 Line Out (Front channels)
- 3 MIC
- 4 Line Out (Rear channels)
- 5 Line Out (Center and Subwoofer channel)
- 6 Line Out (Side channels)



Important

To enable 7.1 channel audio-out function on Vista operating system, you have to install the Realtek Audio Driver. Or, the mainboard will support 5.1 channel audio-out only.

Appendix B

Dual Core Center

Dual CoreCenter, the most useful and powerful utility that MSI has spent much research and efforts to develop, helps users to monitor or configure the hardware status of MSI Mainboard & MSI Graphics card in windows, such as CPU/GPU clock, voltage, fan speed and temperature. The appearance in this appendix are for reference only. The available functions will different depend on the devices you installed.

Before you install the Dual CoreCenter, please make sure the system has meet the following requirements:

1. Intel Pentium4 / Celeron, AMD Athlon XP/ Sempron or compatible CPU with PCI Express slot.
2. 256MB system memory.
3. CD-ROM drive for software installation.
4. Operation system: Windows XP.
5. DotNet Frame Work 2.0

Activating Dual Core Center

Once you have your Dual Core Center installed (locate the setup source file in the setup CD accompanying with your mainboard, path: **Utility --> MSI Utility --> Dual Core Center**), it will have an icon  in the system tray, a short cut icon on the desktop, and a short cut path in your "Start-up" menu. You may double-click on each icon to enable Dual Core Center.



short-cut icon in the system tray

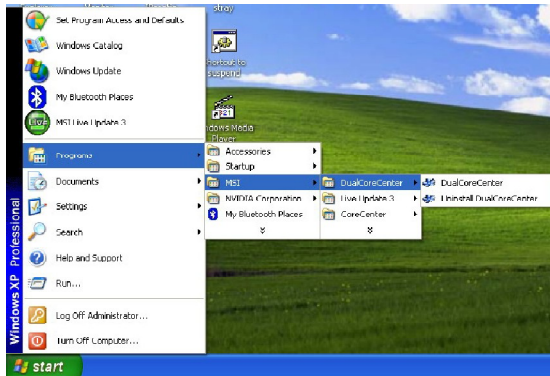

short-cut path in the start-up menu
(path: Start-->Programs-->MSI-->
DualCoreCenter-->DualCoreCenter)

Main

Before using this utility, we have to remind you: only when installing the MSI V044 (V044 has to install with the version 8.26 or newer driver)/ V046 or V060 graphics card can activate the full function of this utility. If you install a graphics card of other brand, only hardware status of the MSI mainboard would be available.



Introduction:

Click each button appearing above to enter sub-menu to make further configuration or to execute the function.

MB

Click MB button to read current CPU temperature, FSB and CPU clock of mainboard will show below.

VGA

Click VGA button to read current GPU temperature, GPU clock and memory clock of graphics card will show below.

DOT

Click DOT button to enable or disable the Dynamic Overclocking Technology.

AV/ Game/ Office/ Silence/ Cool

MSI provides five common settings for different environments. The settings had been set to optimal values to reach better performance in each environment. Click the button you need.



Important

Before clicking the AV/ Game/ Office/ Silence or Cool button, select Smooth mode or Sharp mode to decide whether you want the system to reach the optimal values smoothly or quickly.

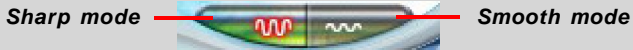

Clock



In this sub-menu, you can adjust and monitor the clocks of MB and graphics card.

Voltage



In this sub-menu, you can adjust and monitor the voltages of MB and graphics card.

FAN Speed



In this sub-menu, you can adjust and monitor the fan speeds of MB and graphics card.

Temperature



In this sub-menu, you can monitor the temperatures of MB and graphics card.

User Profile

In this sub-menu, you can set the values of clock, voltage and fan speed by your need and save them in a profile. You can save 3 profiles for further use.





Important

Click on the icon , the clock, voltage, fan, and temperature buttons will appear beside the icon.



DOT (Dynamic OverClocking)

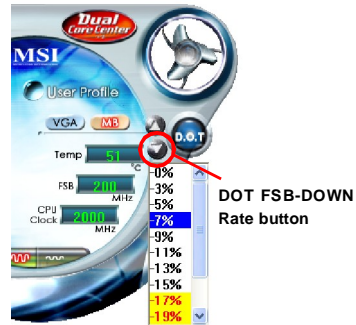
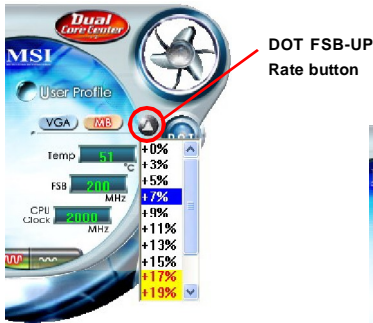

Dynamic Overclocking Technology is an automatic overclocking function, included in the MSI™'s newly developed Dual CoreCenter Technology. It is designed to detect the loading of CPU/ GPU while running programs, and to over-clock automatically. When the motherboard detects that the loading of CPU is exceed the default threshold for a time, it will speed up the CPU and fan automatically to make the system run smoother and faster. When the graphics card detects that the loading of GPU is exceed the default threshold for a time, it will speed up the GPU, memory, fan and voltage automatically to make the system run smoother and faster. When the CPU/ GPU is temporarily suspending or staying in low loading balance, it will restore the default settings instead. Usually the Dynamic Overclocking Technology will be powered only when users' PC runs huge amount of data, like 3D games or video process, and the motherboard/ graphicd card need to be boosted up to enhance the overall performance. There will be several selections when you click the DOT rate button (include increase rate  and decrease  rate buttons), to select the DOT level, then you have to click the DOT button  to apply the DOT function.



Important

Even though the Dynamic Overclocking Technology is more stable than manual overclocking, basically, it is still risky. We suggest user to overclock regularly first. If you find the PC appears to be unstable or reboot incidentally, it's better to lower the level of overclocking options. By the way, if you need to conduct overclocking manually, please do not to apply the DOT function.

Clock

In the **Clock** sub-menu, you can see clock status (including FSB/ CPU clock of mainboard and GPU/ memory clock of graphics card) of your system. And you can select desired value for overclocking. There will be several items for you to select for overclocking after you click  button. You can click the plus sign button  to increase the clock, or click the minus sign button  to decrease the clock. And finally, click the Apply button to apply the values adjusted. If you do not want to apply the adjustments, click the Cancel button to cancel. Or click the Default button to restore the default values.

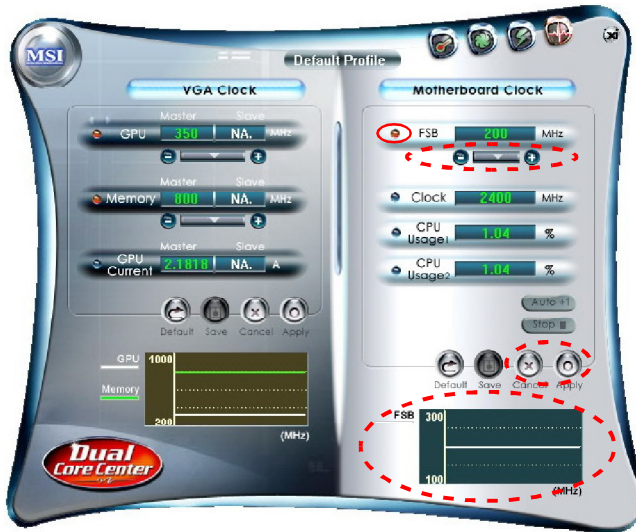



On the underside, it shows the graphs of the clocks. Only the curves of the item which the button is lit up with red color will be shown.



Important

*In the user profile, clicking the **Save** button can save the changes to it. In the default profile, the Save button is not available.*

Voltage

In the **Voltage** sub-menu, you can see voltage status (including Vcore, memory, GPU voltage... etc.) of your system, and you can select desired value for overclocking. It will show several items to select for overclocking after you click the  button. You can click the plus sign button  to increase the voltage, or click the minus sign button  to decrease. And finally, click the Apply button to apply the adjustments. If you do not want to apply the adjustments, click the Cancel button to cancel. Or click the Default button to restore the default values.





On the underside, it shows the graphs of the voltages. Only the curves of the item which the button is lit up with red color will be shown.



Important

*In the user profile, clicking the **Save** button can save the changes to it. In the default profile, the Save button is not available.*

FAN Speed

In the **FAN Speed** sub-menu, you can read fan status of your system. Select higher speed for better cooling effect. There are several sections for you to change the fan speed to a section after clicking  button. Click the plus sign button  to increase the fan speed to a section, or click the minus sign button  to decrease. Or click the Default button to restore the default values.

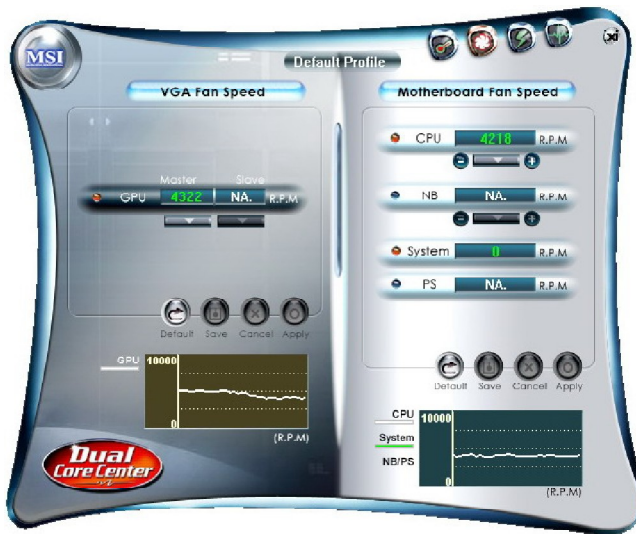

On the underside, it shows the graphs of the fan speed. Only the curves of the item which the button is lit up with red color will be shown.



Important

1. When you set the fan speed manually, please make sure to disabled the "CPU Smart FAN Target" item in the BIOS.
2. In the user profile, clicking the **Save** button can save the changes to it. In the default profile, the Save button is not available.

Temperature

In the **Temperature** sub-menu, you can see temperature status of your system.

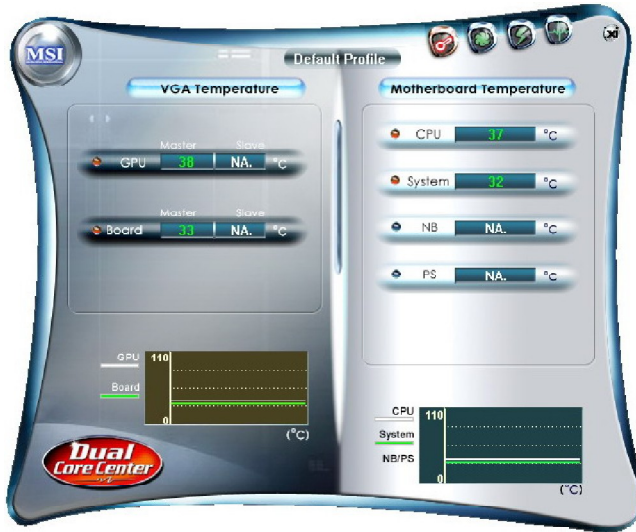



On the underside, it shows the graphs of the temperatures. Only the curves of the item which the button is lit with red color will be shown.

User Profile

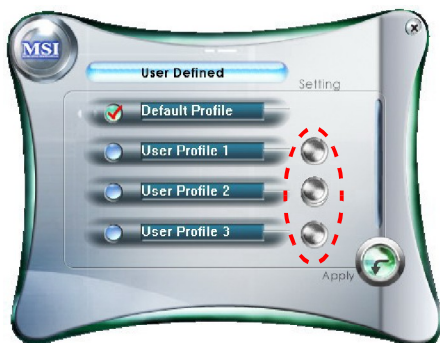
In the **User Profile** sub-menu, click the setting button that besides the user profile bar, and the next screen will appear.



Here you can define the clock/ fan speed/ voltage by your need, click the  button to choose a value quickly, or click the plus  / minus sign  button to increase/ decrease the value.



Dual Core Center

Use the draw bar to set the max system temperature. When the system temperature exceeds the threshold you defined, the system will pop up a warning message and shut down the system.

Use the draw bar to set the minimal fan speed. When the fan speed is lower than the threshold you defined, the system will pop up a warning message.



After setting all values you need, you can change the user profile name in the box then click the save button  to save all changes in a profile.

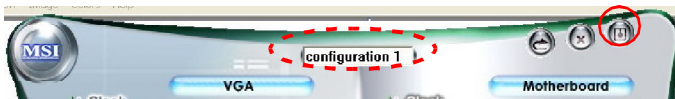

Finally, you can choose MAX the user profile by click the button in the left side and click the Apply button to load the user profile.

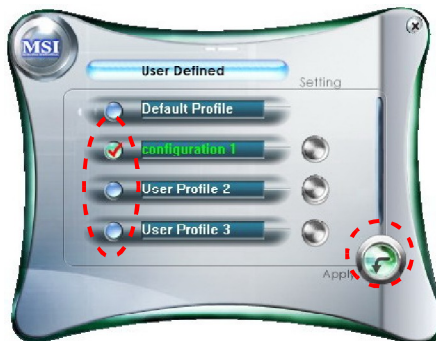

Appendix C

Intel ICH10R SATA RAID

This appendix will assist users in configuring and enabling RAID functionality on platforms

ICH10R Introduction

The ICH10R provides a hybrid solution that combines 6 independent SATAII ports for support of up to 6 Serial ATAII (Serial ATAII RAID) drives.

Serial ATAII (SATAII) is the latest generation of the ATA interface. SATA hard drives deliver blistering transfer speeds up to 3Gb/s. Serial ATA uses long, thin cables, making it easier to connect your drive and improving the airflow inside your PC. The most outstanding features are:

1. Supports 3Gb/s transfers with CRC error checking.
2. Supports Hot-plug-n-play feature.
3. Data handling optimizations including tagged command queuing, elevator seek and packet chain command.

Intel® ICH10R offers RAID level 0 (Striping), RAID level 1 (Mirroring and Duplexing), RAID level 5 (Block Interleaved Distributed Parity), RAID level 10 (A Stripe of Mirrors) , Intel® Martix Storage Technology and Intel® Rapid Recover Technology.

RAID 0 breaks the data into blocks which are written to separate hard drives. Spreading the hard drive I/O load across independent channels greatly improves I/O performance.

RAID 1 provides data redundancy by mirroring data between the hard drives and provides enhanced read performance.

RAID 5 Provides data striping at the byte level and also stripe error correction information. This results in excellent performance and good fault tolerance. Level 5 is one of the most popular implementations of RAID.

RAID 10 Not one of the original RAID levels, multiple RAID 1 mirrors are created, and a RAID 0 stripe is created over these.

Intel Matrix RAID Technology is the advanced ability for two RAID volumes to share the combined space of two hard drives being used in unison.

Intel Rapid Recover Technology utilizes RAID 1 functionality to copy data from a designated Master drive to a designated Recovery drive. The size of the Mater drive must be less than or equal to the size of the Recovery drive. When a Recovery volume is created, complete capacity of the Master drive will be used as the Master volume. Only one Recovery Volume can exist on a system. There are 2 methods of updating the data on the Master to the Recovery drive. They are Continuous Update Policy and On Request Update Policy.



Important

The least number of hard drives for RAID 0, RAID 1, Recovery or Matrix mode is 2. The least number of hard drives for RAID 10 mode is 4. And the least number of hard drives for RAID 5 mode is 3.

All the information/ volumes/ pictures listed in your system might differ from the illustrations in this appendix.

BIOS Configuration

The Intel Matrix Storage Manager Option ROM should be integrated with the system BIOS on all motherboards with a supported Intel chipset. The Intel Matrix Storage Manager Option ROM is the Intel RAID implementation and provides BIOS and DOS disk services. Please use <Ctrl> + <I> keys to enter the “Intel(R) RAID for Serial ATA” status screen, which should appear early in system boot-up, during the POST (Power-On Self Test). Also, you need to enable the RAID function in BIOS to create, delete and reset RAID volumes.

Using the Intel Matrix Storage Manager Option ROM

1. Creating, Deleting and Resetting RAID Volumes:

The Serial ATA RAID volume may be configured using the RAID Configuration utility stored within the Intel RAID Option ROM. During the Power-On Self Test (POST), the following message will appear for a few seconds:



Important

The “Driver Model”, “Serial #” and “Size” in the following example might be different from your system.

```
Intel(R) Matrix Storage Manager option ROM v8.5.0.1013 ICH10R wRAID5
Copyright(C) 2003-08 Intel Corporation, All Rights Reserved.'
```

```
RAID Volumes
None defined.
```

```
Physical Disks::
```

Port	Device Model	Serial #	Size	Type/Status(Vol ID)
0	HDS722580VLSA80	VNRB3EC20549SL	76.7GB	Non-RAID Disk
1	HDS722580VLSA80	VNRB3EC20559SL	76.7GB	Non-RAID Disk
2	HDS722580VLSA80	VNRB3EC20569SL	76.7GB	Non-RAID Disk
3	HDS722580VLSA80	VNRB3EC20579SL	76.7GB	Non-RAID Disk

```
Press <CTRL-I> to enter Configuration Utility..
```

After the above message shows, press <Ctrl> and <I> keys simultaneously to enter the RAID Configuration Utility.



Important

The following procedure is only available with a newly-built system or if you are reinstalling your OS. It should not be used to migrate an existing system to RAID.

- 3. In the **Disk** field, press <Enter> key and the following screen appears. Use <Space> key to select the disks you want to create for the RAID volume, then click <Enter> key to finish selection.

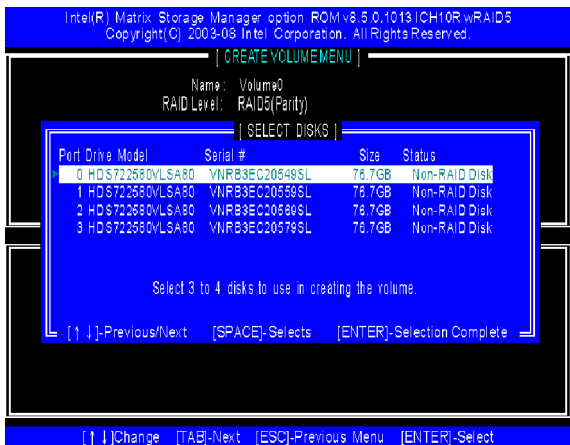

- 4. Then select the strip value for the RAID array by using the “upper arrow” or “down arrow” keys to scroll through the available values, and pressing the <Enter> key to select and advance to the next field. The available values range from 4KB to 128 KB in power of 2 increments. The strip value should be chosen based on the planned drive usage. Here are some typical values:
RAID0 – 128KB
RAID10 – 64KB
RAID5 – 64KB
- 5. Then select the capacity of the volume in the **Capacity** field. The default value is the maximum volume capacity of the selected disks.

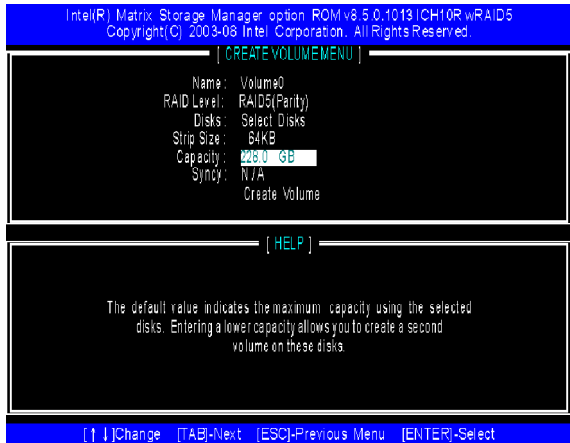



Important

Since you want to create two volumes (Intel Matrix RAID Technology), this default size (maximum) needs to be reduced. Type in a new size for the first volume. As an example: if you want the first volume to span the first half of the two disks, re-type the size to be half of what is shown by default. The second volume, when created, will automatically span the remainder of two hard drives.

- Then the following screen appears for you to confirm if you are sure to create the RAID volume. Press <Y> to continue.

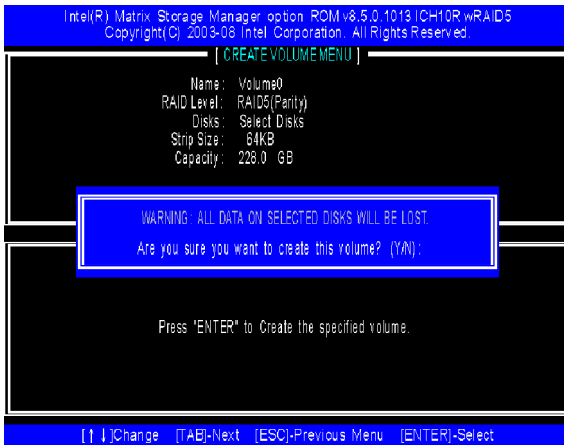

- Then the following screen appears to indicate that the creation is finished.

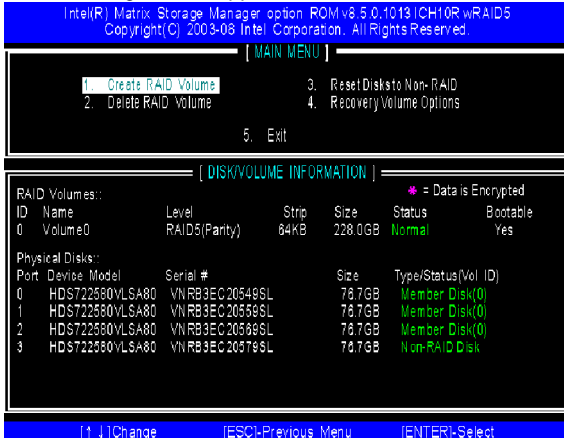

(2) Delete RAID Volume

Here you can delete the RAID volume, but please be noted that all data on RAID drives will be lost.



Important

If your system currently boots to RAID and you delete the RAID volume in the Intel RAID Option ROM, your system will become unbootable.

Select option 2 **Delete RAID Volume** from the main menu window and press <Enter> key to select a RAID volume for deletion. Then press <Delete> key to delete the selected RAID volume. The following screen appears.

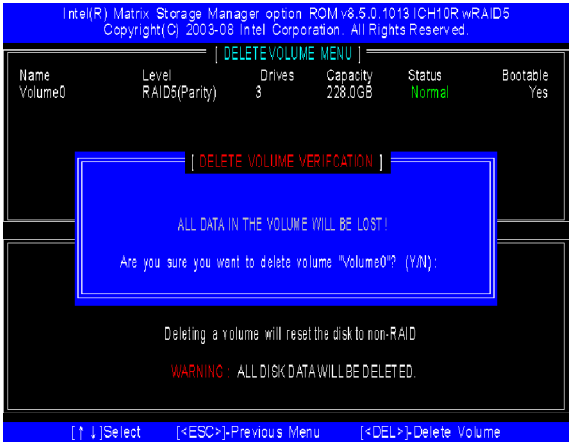

Press <Y> key to accept the volume deletion.

(3) Reset Disks to Non-RAID

Select option **3 Reset Disks to Non-RAID** and press <Enter> to delete the RAID volume and remove any RAID structures from the drives. The following screen appears:



Press <Y> key to accept the selection.



Important

1. You will lose all data on the RAID drives and any internal RAID structures when you perform this operation.
2. Possible reasons to 'Reset Disks to Non-RAID' could include issues such as incompatible RAID configurations or a failed volume or failed disk.

(4) Recovery Volume Options

Select option 4 **Recovery Volume Options** and press <Enter> to change recovery volume mode. The following screen appears:



Recovery mode will change from Continuous Update to On-Request after you enable Only Recovery Disk or Only Master Disk.

Installing Driver

Install Driver in Windows Vista / XP / 2000

† New Windows Vista / XP / 2000 Installation

The following details the installation of the drivers while installing Windows XP / 2000.

1. When you start installing Windows XP and older operating systems, you may encounter a message stating, "Setup could not determine the type of one or more mass storage devices installed in your system". If this is the case, then you are already in the right place and are ready to supply the driver. If this is not the case, then press F6 when prompted at the beginning of Windows setup.
2. Press the "S" key to select "Specify Additional Device".
3. You should be prompted to insert a floppy disk containing the Intel® RAID driver into the A: drive.

Note: For Windows Vista you can use Floppy, CD/DVD or USB.



Important

Please follow the instruction below to make an "Intel® RAID Driver" for yourself.

1. Insert the MSI CD into the CD-ROM drive.
2. Click the "Browse CD" on the Setup screen.
3. Copy all the contents in `\\DE\Inte\ICH10R\Floppy` to a formatted floppy diskette.
4. The driver diskette for **Intel® ICH10R RAID Controller** is done.

4. For Windows Vista:
During the Operating system installation, after selecting the location to install Vista click on "Load Driver" button to install a third party SCSI or RAID driver.
5. When prompted, insert the floppy disk or media (Floppy, CD/DVD or USB) you created in step 3 and press Enter.
6. You should be shown a list of available SCSI Adapters. This list should include "Intel(R) 82801HEM SATA RAID Controller(ICH8M-E)" when the system is in RAID mode and "Intel(R) 82801HEM SATA AHCI Controller(ICH8M-E)" or "Intel(R) 82801HBM SATA AHCI Controller(ICH8M)" when the system is in AHCI mode.
7. Select the appropriate Intel RAID controller and press ENTER.
8. The next screen should confirm that you have selected the Intel® RAID controller. Press ENTER again to continue.
9. You have successfully installed the Intel® Matrix Storage Manager driver, and Windows setup should continue.
10. Leave the disk in the floppy drive until the system reboots itself. Windows setup will need to copy the files from the floppy again after the RAID volume is formatted, and Windows setup starts copying files.

† **Existing Windows Vista/XP/2000 Driver Installation**

1. Insert the MSI CD into the CD-ROM drive.
2. The CD will auto-run and the setup screen will appear.
3. Under the Driver tab, click on **Intel IAA RAID Edition**.
4. The drivers will be automatically installed.

† **Confirming Windows Vista/XP/2000 Driver Installation**

1. From Windows Vista/XP/2000, open the **Control Panel** from **My Computer** followed by the System icon.
2. Choose the **Hardware** tab, then click the **Device Manager** tab.
3. Click the "+" in front of the **SCSI and RAID Controllers** hardware type. The driver **Intel(R) ICH10R SATA RAID Controller** should appear.

Installing Software

Install Intel Matrix Storage Console

The Intel Application Accelerator RAID Edition driver may be used to operate the hard drive from which the system is booting or a hard drive that contains important data. For this reason, you cannot remove or un-install this driver from the system after installation; however, you will have the ability to un-install all other non-driver components.

Insert the MSI CD and click on the **Intel IAA RAID Editor** to install the software.



Click on this item

The **InstallShield Wizard** will begin automatically for installation showed as following:

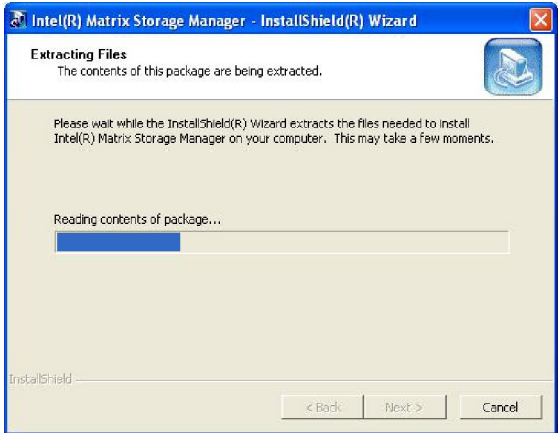

Click on the **Next** button to proceed the installation in the welcoming window.

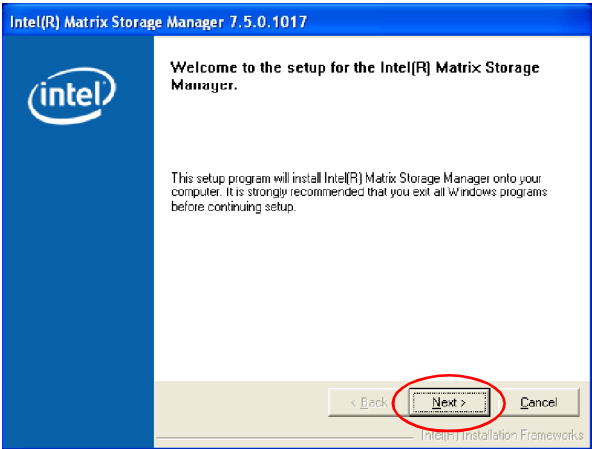

The window shows the components to be installed. Click **Next** button to continue.

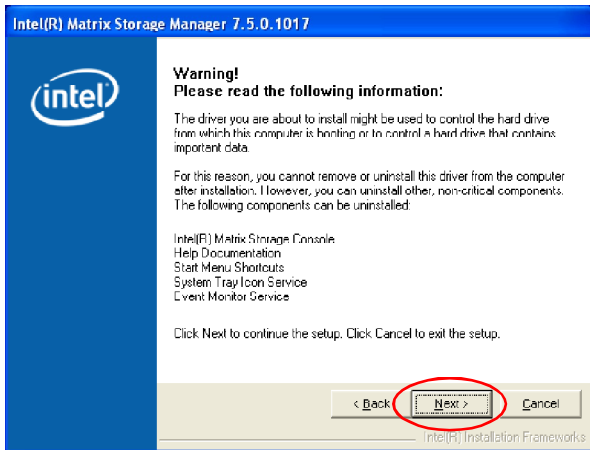

After reading the license agreement in the following window, click **Yes** button to continue.

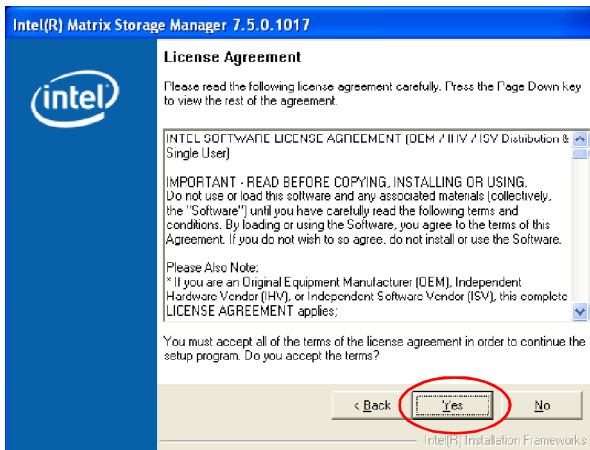

The following window appears to show the Readme File Information. It shows the system requirements and installation information.

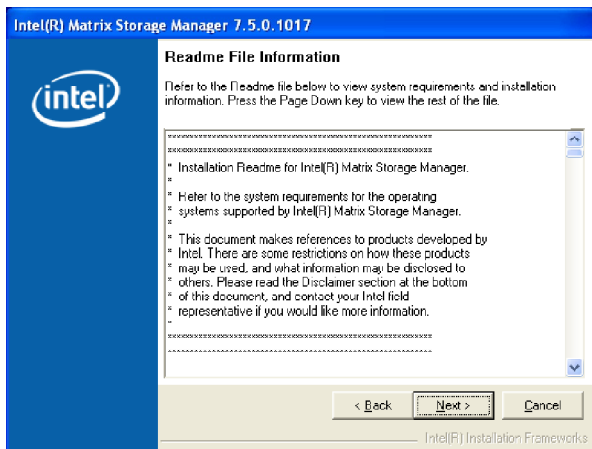

Once the installation is complete, the following window appears.

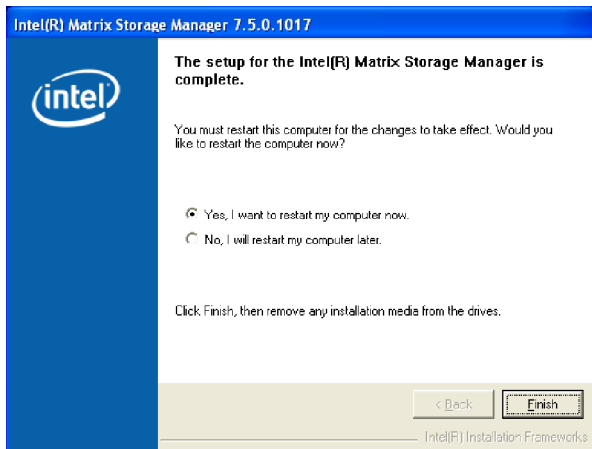

RAID Migration Instructions

The Intel Matrix Storage Console offers the flexibility to upgrade from a single Serial ATA (SATA) hard drive to RAID configuration when an additional SATA hard drive is added to the system. This process will create a new RAID volume from an existing disk. However, several important steps must be followed at the time the system is first configured in order to take advantage of RAID when upgrading to a second SATA hard drive:

1. BIOS must be configured for RAID before installing Windows on the single SATA hard drive. Refer to **On-Chip ATA Devices** for properly setting of the BIOS.
2. Install the Intel Application Accelerator RAID Driver during Windows Setup. Refer to **Installing Software** for instructions on installing the driver during Windows Setup.
3. Install the Intel Matrix Storage Console after the operating system is installed.

To create a volume from an existing disk, complete the following steps:



Important

*A **Create from Existing Disk** operation will delete all existing data from the added disk and the data cannot be recovered. It is critical to backup all important data on the added disk before proceeding. However, during the migration process, the data on the source disk is preserved.*

After the Intel Matrix Storage Console has been successfully installed and the system has rebooted, click on the Intel Application Accelerator shortcut link (**Start --> All Programs --> Intel Matrix Storage Manager --> Intel Matrix Storage Console**) and the following window will appear:

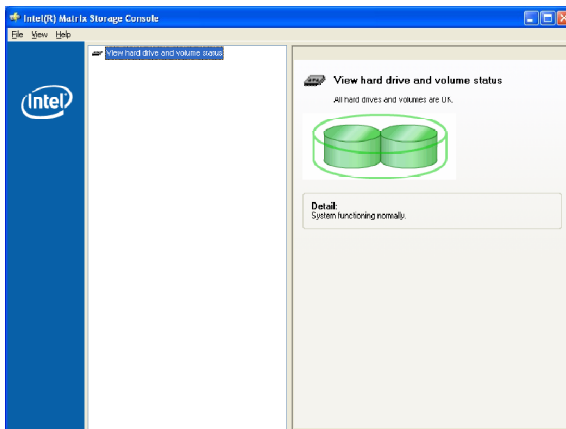

Create RAID Volume from Existing Disk

To create a RAID volume from an existing disk, choose **Action --> Create RAID Volume from Existing Hard Drive**.

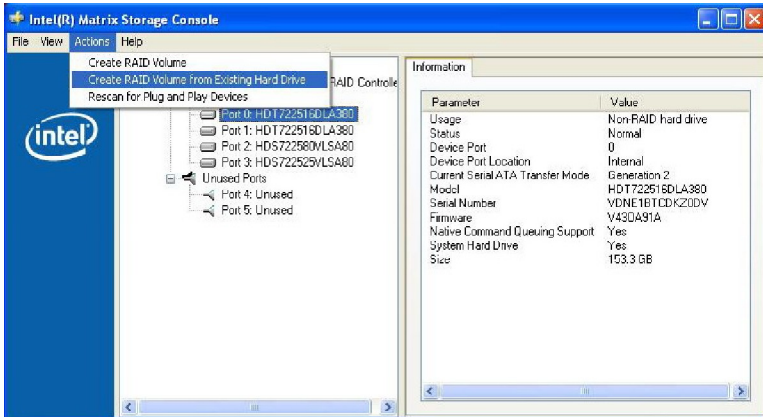

The **Create RAID Volume from Existing Hard Drive Wizard** pops up to lead you for the following procedure. Click **Next** to continue.

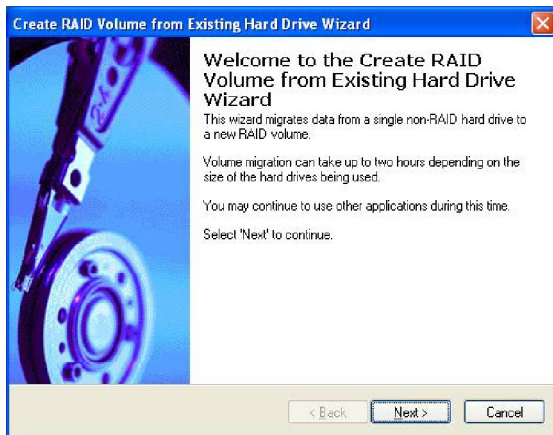

(1) Configure Volume

Here you can configure the new RAID volume by entering the volume name, selecting the RAID level and strip size.

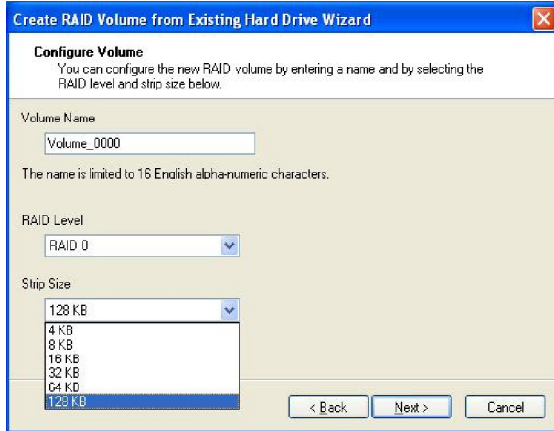

† RAID Volume Name:

A desired RAID volume name needs to be typed in where the 'RAID_Volume1' text currently appears above. The RAID volume name has a maximum limit of 16 characters. The RAID volume name must also be in English alphanumeric ASCII characters.

† RAID Level:

Select the desired RAID level:

RAID 0 (Performance) – A volume optimized for performance will allow you to access your data more quickly.

RAID 1 (Redundancy) – A volume optimized for data redundancy will provide you with a realtime duplicate copy of your data. Note: Only half of the available volume space will be available for data storage.

RAID 5 (Useful) – RAID 5 can be used on three or more disks, with zero or more spare-disks. The resulting RAID-5 device size will be $(N-1)*S$, where N is the how many drive, S is the size of the smallest drive in the array. If one of the disks fail, all data are still intact. It can rebuild the disk from the parity information. If spare disks are available, reconstruction will begin immediately after the device failure. If two disks fail simultaneously, all data are lost. RAID-5 can survive one disk failure, but not two or more. Both read and write performance usually increase, but can be hard to predict how much. Reads are similar to RAID-0 reads, writes can be either rather

expensive (requiring read-in prior to write, in order to be able to calculate the correct parity information), or similar to RAID-1 writes. The write efficiency depends heavily on the amount of memory in the machine, and the usage pattern of the array. Heavily scattered writes are bound to be more expensive.

RAID 10 (Mirrored Stripes) –A RAID 1 array of two RAID 0 arrays.

† **Strip Sizes:**

Select the desired strip size setting. As indicated, the optimal setting is 128KB. Selecting any other option may result in performance degradation. Even though 128KB is the recommended setting for most users, you should choose the strip size value which is best suited to your specific RAID usage model. The most typical strip size settings are:

4KB: For specialized usage models requiring 4KB strips

8KB: For specialized usage models requiring 8KB strips

16KB: Best for sequential transfers

32KB: Good for sequential transfers

64KB: Good general purpose strip size

128KB: Best performance for most desktops and workstations

(2) Select the source disk

Then select the source disk that you wish to use and then click “--->” to move it to the **Selected** field. Then click **Next** to continue.

It is very important to note which disk is the source disk (the one containing all of the information to be migrated) and which one is the target disk. On a RAID Ready system, this can be determined by making a note during POST of which port the single disk is attached to.

You can also use the Intel Application Accelerator RAID Edition utility before the second disk is installed to verify the Port and serial number of the drive that contains all the data.

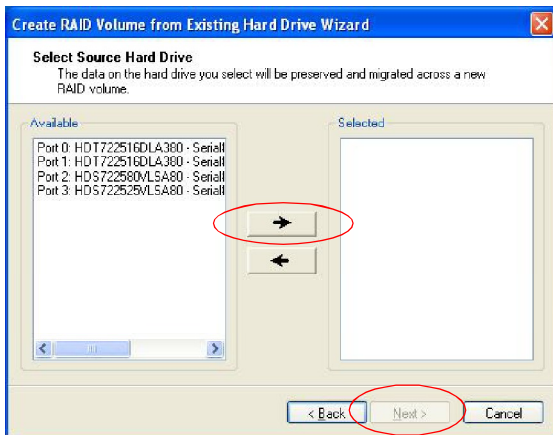

(3) Select Member Hard Drive(s)

Then select the member disk (the target disk) that you wish to use and then click “-->” to move it to the **Selected** field. Then click **Next** to continue.

Please note that the existing data on the selected hard drive(s) will be deleted permanently. Do not forget to back up all the important data before continuing.

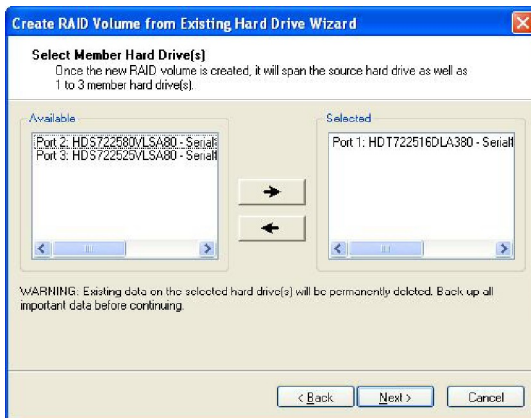
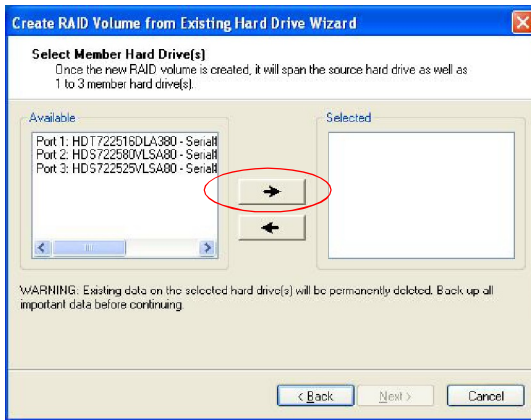

(4) Specify Volume Size

Specify the amount of available array space to be used by the new RAID volume. You may enter the amount in the space or use the slider to specify. It is recommended you use 100% of the available space for the optimized usage. For RAID 0 volume, if you do not specify 100% of the hard drive space, the rest hard drive space will be worked as RAID 1 volume, which is the new technology called Intel Matrix RAID. Then click **Next** to continue.

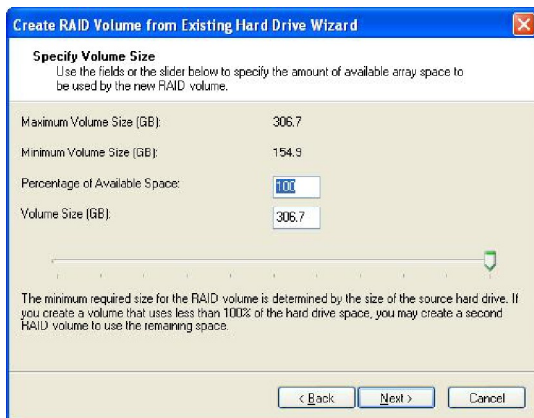

(5) Start Creating RAID Volume from Existing Hard Drive Wizard

Before you continue the procedure of RAID volume creation from existing hard drive, read the dialogue box below carefully. Please note that once you click **Finish**, the existing data on the selected hard drive(s) will be deleted permanently and this operation cannot be undone. It is critical that you backup all important data before selecting **Finish** to start the migration process.

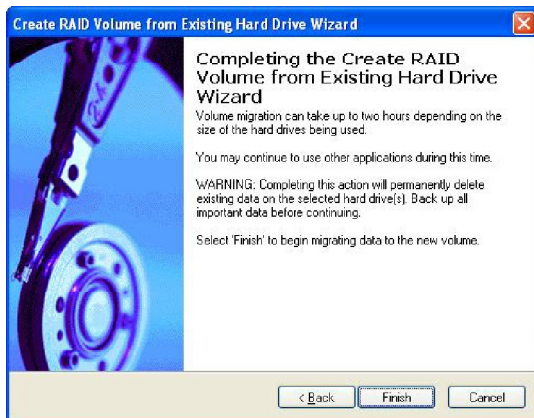

(6) Start Migration

The migration process may take up to two hours to complete depending on the size of the disks being used and the strip size selected. A dialogue window will appear stating that the migration process may take considerable time to complete, meanwhile a popup dialogue at the taskbar will also show the migration status. While you can still continue using your computer during the migration process, once the migration process starts, it cannot be stopped. If the migration process gets interrupted and your system is rebooted for any reason, it will pick up the migration process where it left off. You will be provided with an estimated completion time (the remaining time will depend on your system) once the migration process starts.



The following screen appears if the migration process is completed successfully. Then you have to reboot your system to use the full capacity of the new volume.

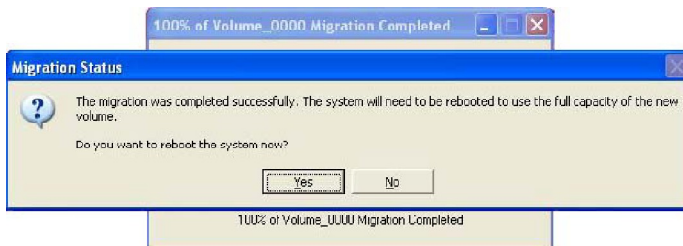

Recovery Volume Creation

A recovery volume can be created using either Basic mode or Advanced mode in the Intel Matrix Storage Console.

Recovery Volume in Basic Mode Creation



Important

Creating a recovery volume will permanently delete any existing data on the drive selected as the recovery drive. Back up all important data before beginning these steps.

This option may or may not be available depending on your system configuration. If you do not see the option listed, refer to Recovery Volume Creation in Advanced Mode.

To create a recovery volume in Basic mode, use the following steps:

- (1) Open the Intel Matrix Storage Console. (**Start --> All Programs --> Intel Matrix Storage Manager --> Intel Matrix Storage Console**)
- (2) Select Protect data using IntelR Rapid Recover Technology.

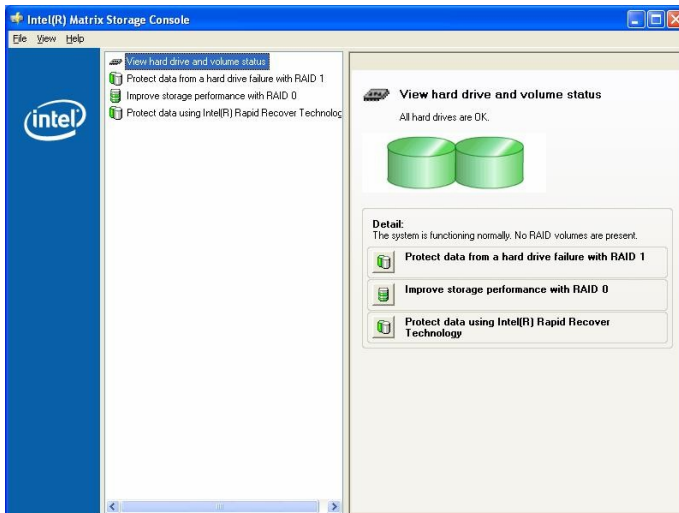

- (3) Select **Yes** to confirm volume creation.

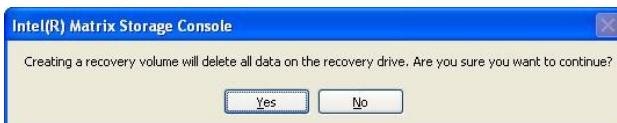

Recovery Volume in Advanced Mode Creation



Important

Creating a recovery volume will permanently delete any existing data on the drive selected as the recovery drive. Back up all important data before beginning these steps.

To create a recovery volume in Advanced mode, use the following steps:

- (1) Open the Intel Matrix Storage Console. (**Start --> All Programs --> Intel Matrix Storage Manager --> Intel Matrix Storage Console**)
- (2) Select Advanced Mode in the View menu.
- (3) Select **Create Recovery Volume** in the Actions menu.

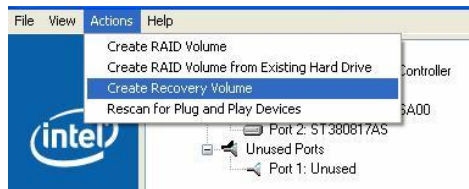

- (4) Select **Next** to continue.



- (5) Modify the recovery volume name if you wish.

- (6) Select a hard drive to be used as the master hard drive for the recovery volume.

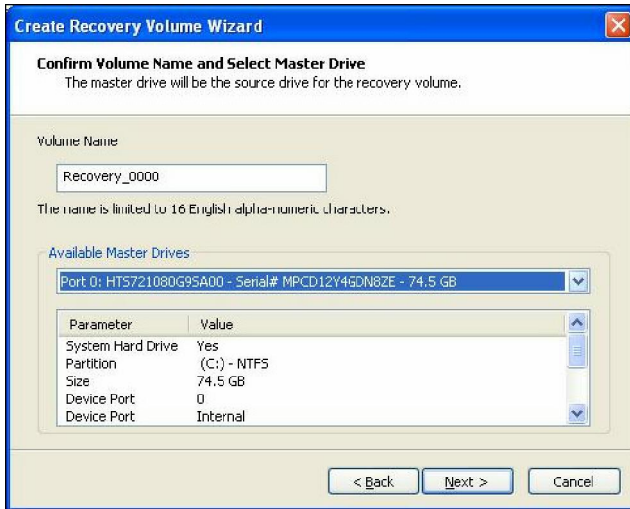

- (7) Select a hard drive to be used as the recovery hard drive for the recovery volume.

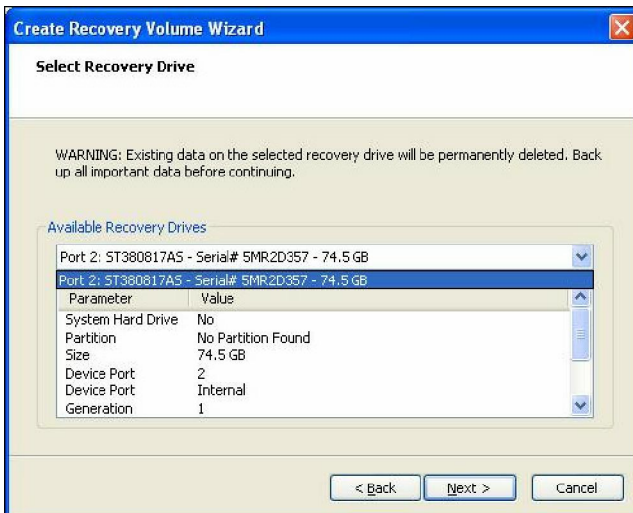

(8) Select an update policy.

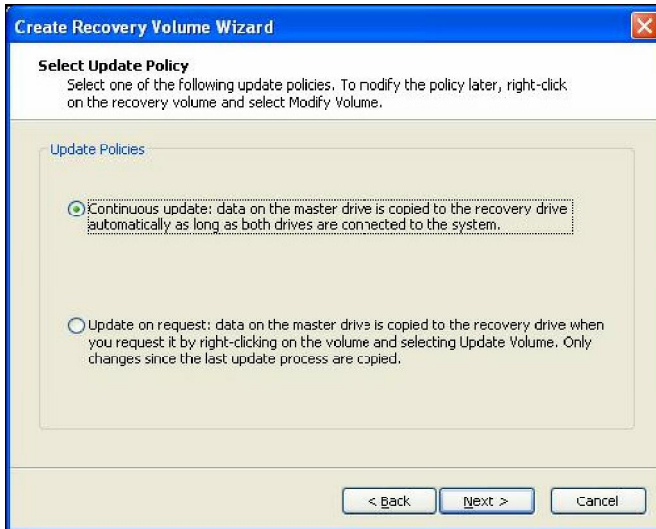

(9) Select **Finish** to begin recovery volume creation.

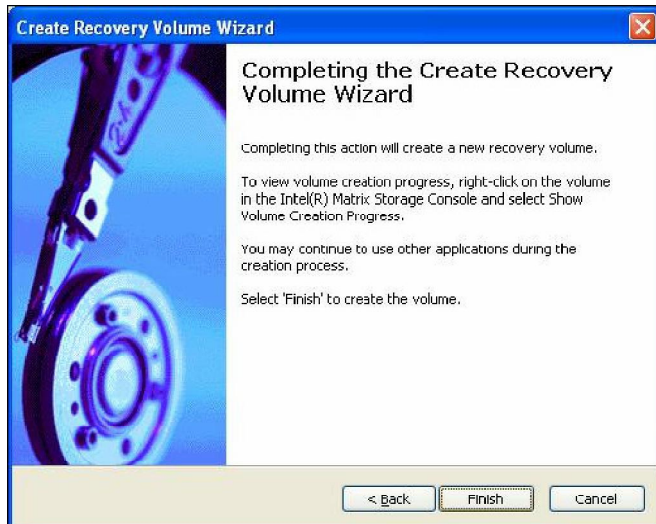

Degraded RAID Array

A RAID 1, RAID 5 or RAID 10 volume is reported as degraded when one of its hard drive members fails or is temporarily disconnected, and data mirroring is lost. As a result, the system can only utilize the remaining functional hard drive member. To re-establish data mirroring and restore data redundancy, refer to the procedure below that corresponds to the current situation.

Missing Hard Drive Member

1. Make sure the system is powered off.
2. Reconnect the hard drive.
3. Reboot the system to Windows; the rebuild will occur automatically.

Failed Hard Drive Member

1. Make sure the system is powered off.
2. Replace the failed hard drive with a new one that is of equal or greater capacity.
3. Reboot the system to Intel RAID Option ROM by press <Ctrl> and <I> keys simultaneously during the Power-On Self Test (POST).

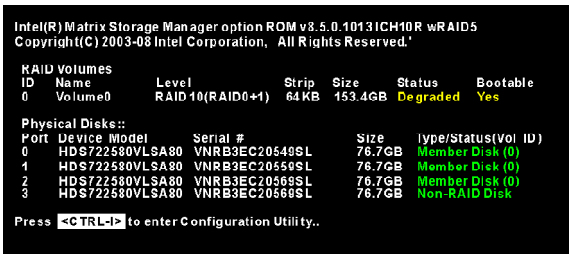

4. Select the port of the destination disk for rebuilding, and then press ENTER.

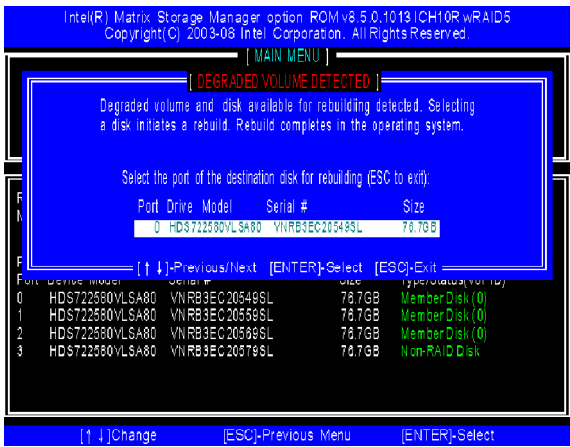

5. Exit Intel RAID Option ROM, and then reboot to Windows system.
6. When prompted to rebuild the RAID volume, click 'Yes'.
7. The Intel(R) Storage Utility will be launched. Right-click the new hard drive and select 'Rebuild to this Disk'. The 'Rebuild Wizard' will be launched which will guide you through the process of rebuilding to the new hard drive.

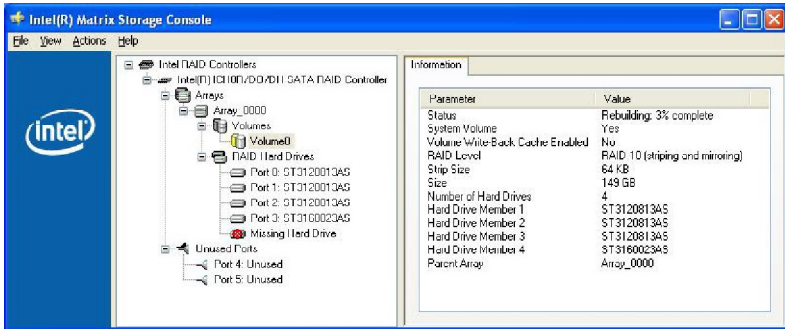

Appendix D

JMicron RAID Introduction

This appendix will assist users in configuring and enabling RAID functionality on platforms
The JM micron RAID solution supports RAID level 0 (striping), RAID level 1 (mirroring), RAID level 10 (striping and mirroring) and JBOD (Concatenate).

Introduction

JMicron JMB363 offers RAID level 0 (Striping), RAID level 1 (Mirroring and Duplexing), RAID level 10 (A Stripe of Mirrors) and JBOD (Concatenate).

RAID 0 breaks the data into blocks which are written to separate hard drives. Spreading the hard drive I/O load across independent channels greatly improves I/O performance. RAID 1 provides data redundancy by mirroring data between the hard drives and provides enhanced read performance. RAID 10 Not one of the original RAID levels, multiple RAID 1 mirrors are created, and a RAID 0 stripe is created over these. JBOD provides a method for combining drives of different sizes into one large disk.



Important

The least number of hard drives for RAID 0, RAID 1 or JBOD mode is 2. The least number of hard drives for RAID 10 mode is 4. All the information/ volumes/ pictures listed in your system might differ from the illustrations in this appendix. And this mainboard supports RAID 0/ RAID 1 or JBOD mode only.

JMicron RAID BIOS Utility

Be sure to set **RAID** mode for the **JMicron 36x ATA Controller** in BIOS before configuring the JMicron BIOS utility. After that, save the configuration and exit. During boot up (POST), press CTRL+J to enter the JMicron BIOS RAID utility.

The RAID Utility menu screen will be displayed. A brief description of each section is presented below.

```

JMicron Technology Corp.      PCIE-to-SATA/IDE RAID Controller BIOS
[ Main Menu ]                [ Hard Disk Drive List ]

Create RAID Disk Drive
Delete RAID Disk Drive
Revert HDD to Non-RAID
Solve Mirror Conflict
Rebuild Mirror Drive
Save And Exit Setup
Exit Without Saving

HDD0: ST3120013AS           120 GB RAID Inside
HDD1: ST3120013AS           120 GB RAID Inside

Model Name      Capacity Type/Status

[ RAID Disk Drive List ]

Model Name      RAID Level      Capacity Status  Members(HDD#)
RDD0: JRAID     0-Stripe          240 GB Normal   01

[=>TAB]-Switch Window [F1]-Select ITEM [ENTER]-Action [ESC]-Exit

```

Main Menu

- Create RAID Disk Drive - Create a new legacy RAID set.
- Delete RAID Disk Drive - Delete a legacy RAID set.
- Revert HDD to Non-RAID - Revert an existed-RAID HDD to non-RAID.
- Solve Mirror Conflict - Solve a mirror conflict.
- Rebuild Mirror Drive - Rebuild data, when RAID 1 or RAID 10 data mirroring is lost.
- Save And Exit Setup - Save all settings and exit the BIOS utility.
- Exit Without Saving - Exit the BIOS utility without any saving.

Hard Disk Driver List

The menu shows the model number and capacities of the drives physically attached to the SATA/IDE & PATA ports.

RAID Disk Driver List

The menu shows the current configuration of RAID set.

Creating RAID set

1. Select "Create RAID Disk Drive". Then press <Enter>.

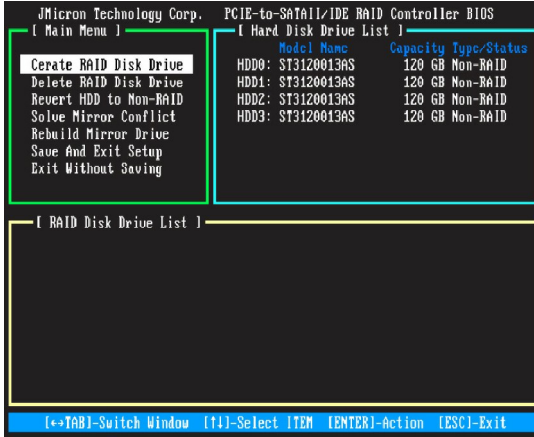

2. Then in the **Name** field, specify a RAID set name and then press the <Enter> to go to the next field.

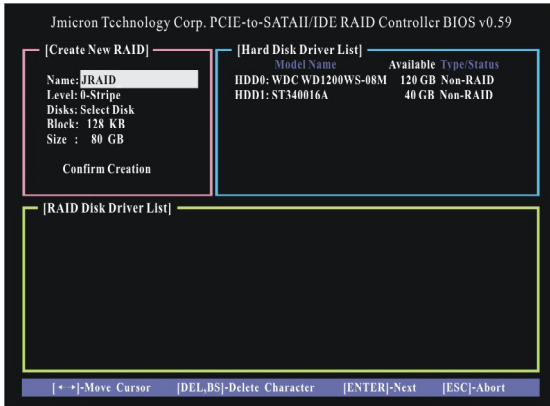

3. Choose a 0-Striped, a 1-Mirror, or a JBOD-Concatenate combination set and then press <Enter> to go to the next step.

4. In the **Hard Disk Disk List** menu, use <Space> key to select the disks you want to create for the RAID set, then click <Enter> key to finish selection.

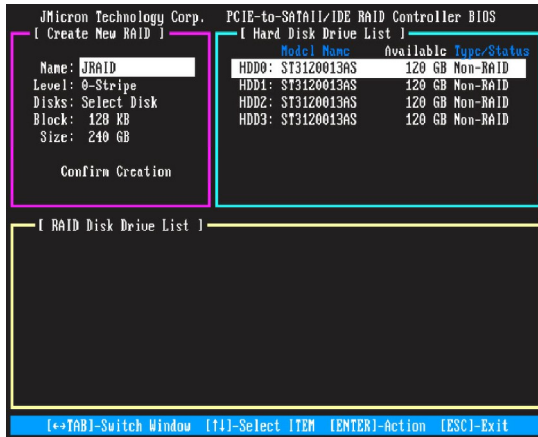

5. Then select the block value (stripe value) for the RAID array by using the “upper arrow” or “down arrow” keys to scroll through the available values, and pressing the <Enter> key to select and advance to the next field. The available values range from 4KB to 128 KB. The default and typical value for RAID 0 is 128KB. (This field only available for RAID 0 mode.)

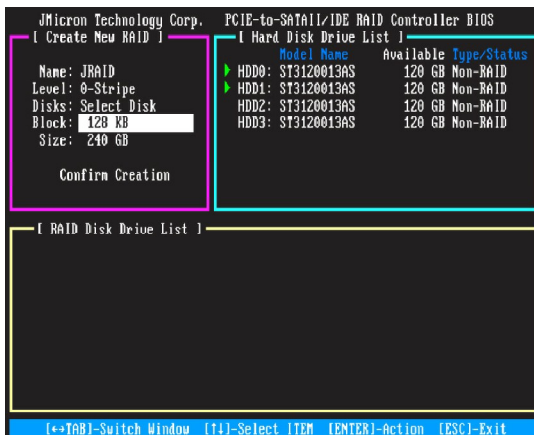

MS-7514 Mainboard

- Then select the capacity of the RAID set in the **Size** field. The default value is the maximum capacity of the selected disks. Then press <Enter> to the Confirm Creation field.
- The Creation field will display a message to ask you to confirm the creation. Then press <Y> key to proceed with the RAID set creation.

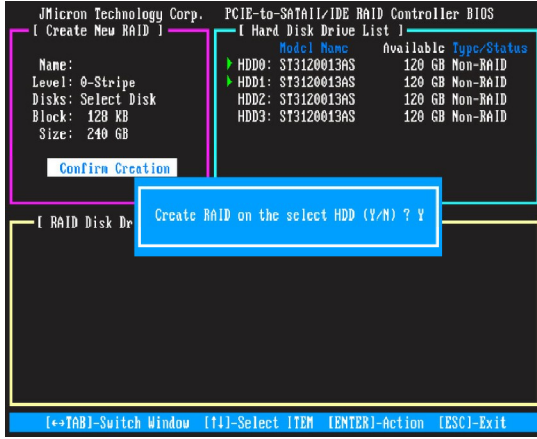

- Then the following screen appears to indicate that the creation is finished.

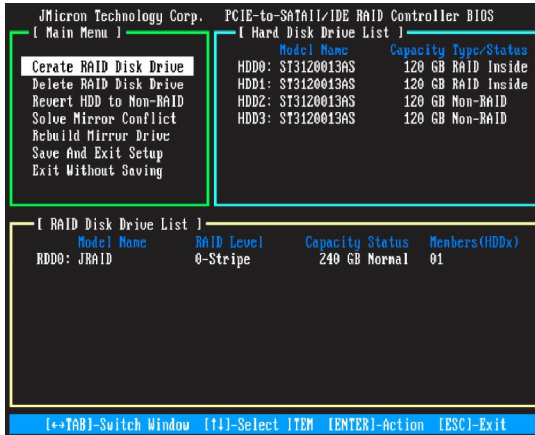

- Go to the Save And Exit Setup field and press <Enter>, a message will display to ask you to confirm the setup. Then press <Y> key to save the setting and exit the BIOS utility.

Deleting RAID set

1. Select "Delete RAID Disk Drive". Then press <Enter>.

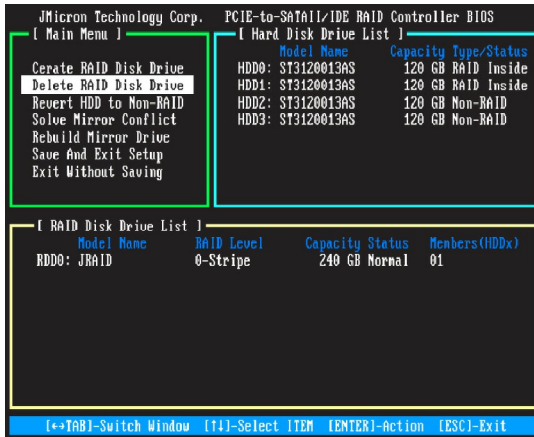

2. In the RAID Disk Driver List menu, use <Space> key to select the RAID set you want to delete. Then press key.
3. Press "Y" to accept the deletion when a deletion message is appeared.

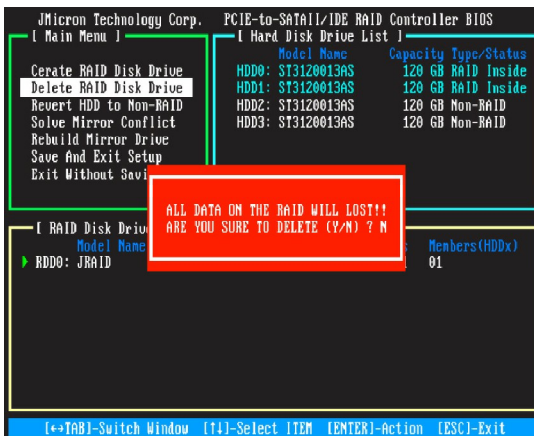

Revert HDD to non-RAID

Select **Revert HDD to non-RAID** and press <Enter>. In the Hard Disk Drive List menu use <Space> key to select the disks you want to revert then click <Enter> key. The following screen appears, press <Y> key to remove any RAID structures from the drives.

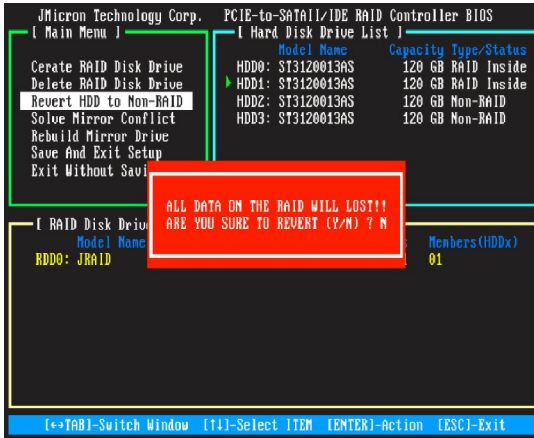

Important

1. You will lose all data on the RAID drives and any internal RAID structures when you perform this operation.
2. Possible reasons to 'Revert HDD to non-RAID' could include issues such as incompatible RAID configurations or a failed volume or failed disk.

Solving a Mirror Conflict

A Mirror conflict occurs when both disks in a RAID 1 (Mirror) configuration are unplugged from the system in turn, then plugged in again. Since both disks contain exactly the same data, the system will be unable to determine which of the two is the source drive. This option allows you to set the source drive and rebuild the Mirror drive according to the contents of the source drive.

To solving a Mirror conflict:

Select **Solving a Mirror Conflict** and press <Enter>. In the Hard Disk Driver List menu use <Space> key to select the disks you want to set as source drive. Using the <TAB>, move to the RAID Disk Drive List menu and highlight the RAID set that you want to rebuild. Press to begin rebuilding the Mirror configuration.

A status bar at the bottom of the screen shows the progress of the rebuilding.

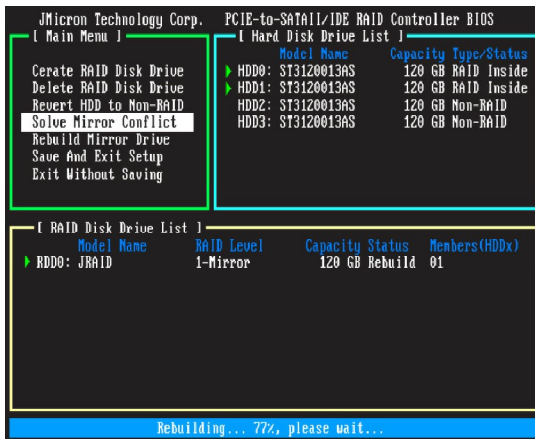

Rebuilding a Mirror drive

When one of the disk in a RAID 1 (Mirror) configuration is unplugged from the system, then plugged in again, a dialogue box appears to ask you to rebuild the Mirror drive. Press <Y> to confirm; otherwise, press <N>.

This option allows you to rebuild the Mirror drive later and synchronize the data between two hard disks.

To rebuild a Mirror drive:

Select **Rebuild Mirror Drive** and press <Enter>. Using the <TAB>, move to the RAID Disk Drive List menu and highlight the RAID set that you want to rebuild. Press to begin rebuilding the Mirror configuration.

A status bar at the bottom of the screen shows the progress of the rebuilding.

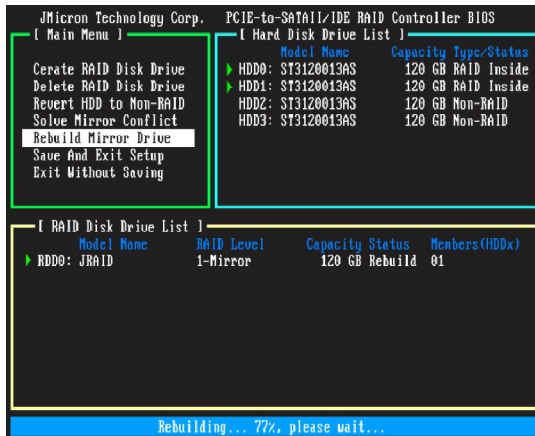

Installing Driver

Install Driver in Windows Vista / XP

† New Windows Vista / XP Installation

For Windows XP:.

1. When you start installing Windows XP and older operating systems, you may encounter a message stating, "Setup could not determine the type of one or more mass storage devices installed in your system". If this is the case, then you are already in the right place and are ready to supply the driver. If this is not the case, then press F6 when prompted at the beginning of Windows setup.
2. Press the "S" key to select "Specify Additional Device".
3. You should be prompted to insert a floppy disk containing the JMicon RAID driver into the A: drive.



Important

Please follow the instruction below to make an "**JMicon RAID Driver**" for yourself.

1. Insert the MSI CD into the CD-ROM drive.
2. Click the "Browse CD" on the Setup screen.
3. Copy all the contents in the
for XP: **\\DE\JMicon\Floppy32** (for 32-bit OS) or **Floppy64** (for 64-bit OS) to a formatted floppy disk.
for Vista: **\\DE\JMicon\Floppy32** (for 32-bit OS) or **Floppy64** (for 64-bit OS) to a medium (floppy disk/ CD/DVD or USB).
4. The driver diskette for **JMicon RAID Controller** is done.
4. When prompted, insert the floppy disk you created in step 3 and press Enter.
5. You should be shown a list of available SCSI Adapters.
6. Select the appropriate JMicon RAID controller and press ENTER.
7. The next screen should confirm that you have selected the JMicon RAID controller. Press ENTER again to continue.
8. You have successfully installed the JMicon RAID driver, and Windows setup should continue.
9. Leave the disk in the floppy drive until the system reboots itself. Windows setup will need to copy the files from the floppy again after the RAID volume is formatted, and Windows setup starts copying files.

For Windows Vista:

After selecting the location to install Windows Vista, please click on the "Load Driver" button to install the RAID driver. Please refer the **Important** notice above to make a RAID Driver medium. And then, follow the instructions to complete the RAID drive installation and the Windows Vista installation.

† **Existing Windows Vista/XP Driver Installation**

1. Insert the MSI CD into the CD-ROM drive.
2. The CD will auto-run and the setup screen will appear.
3. Under the Driver tab, click on **JMicron JMB363 Drivers**.
4. The drivers will be automatically installed.

† **Confirming Windows Vista/XP Driver Installation**

1. From Windows Vista/XP, open the **Control Panel** from **My Computer** followed by the System icon.
2. Choose the **Hardware** tab, then click the **Device Manager** tab.
3. Click the "+" in front of the **SCSI and RAID Controllers** hardware type. The driver **JMicron JMB36X Controller** should appear.

JMicron RAID Configurer

There is an application called JM RAID Tool which helps you perform the following tasks of JMicron RAID.

- **Viewing RAID Array Configurations**
View an array configuration (mirrored, striped)
- **Creating RAID Arrays**
- **Deleting a RAID Array**
- **Rebuilding RAID Arrays**
- **Solving Mirror Conflict**

View RAID Array Configurations

Left-click the “Show Disks” button and the information of all hard disks will display on the right side of the window.

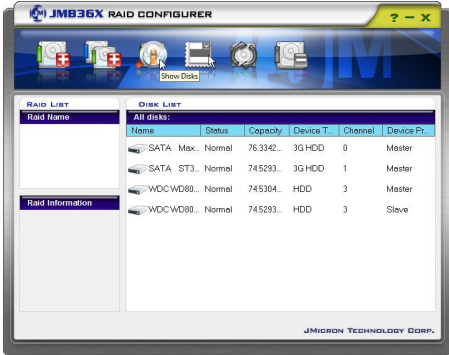

Left-click the name of the disk array and the information of all hard disks of the selected disk array will display on the right side of the window. The information of the disk array will also display on the lower-left part of the window.



Create RAID

JMRaidTool supports the creation of RAID 0, 1, 0+1 and JBOD.

1. Left-click the “Create Raid” button.
2. A CREATE RAID WIZARD dialogue will display on the screen, following the description of every step to complete the creation.

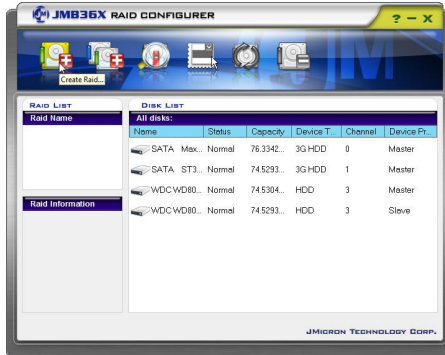

Create RAID from Existing Disk

You can combine the Existing Disk (Source disk may content OS and Data) with other HD (must be larger than source Disk) to be RAID. The data on Source Disk will be reserved. After RAID is built, system will need to reboot.

1. Left-Click the “Create RAID from Existing Disk” icon on the toolbar.
2. A “CREATING RAID FROM EXISTING DISK” wizard dialogue will display on the screen, following the description of every step to complete the creation.



Remove RAID

There are two ways you can choose to remove RAID.

Way 1

1. Right-click the name of the disk array you want to delete and the "Remove" menu will appear. Select the "Remove Raid" of the pop-up menu.

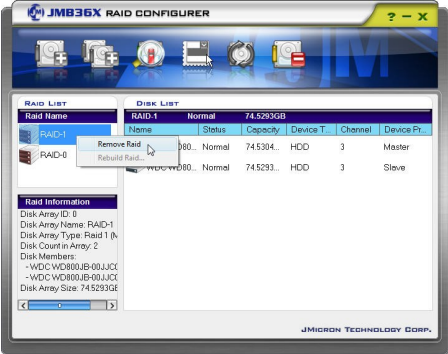

2. A warning message appears to remind you that the data will be lost. Press the "Yes" button if you really want to delete the disk array.

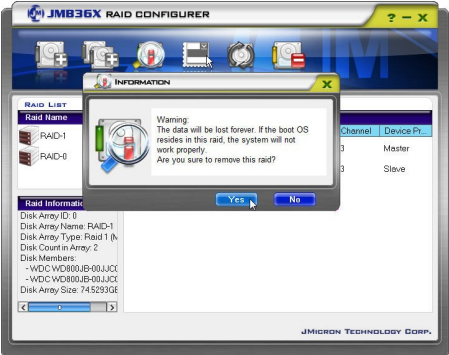

Way2

1. Left-Click the “Remove Raid” icon on the toolbar.
2. A “REMOVE RAID” wizard dialogue will display on the screen, following the description of every step to complete the deletion.

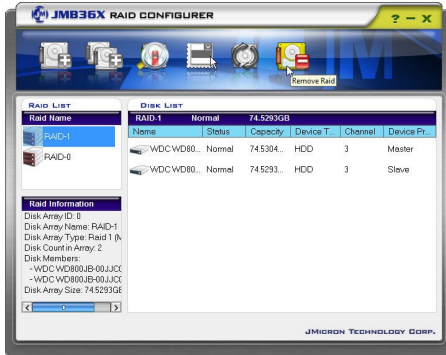

Rebuild RAID

RAID 1, 0+1 can be rebuilt while RAID 0, JBOD cannot be rebuilt. There are two ways you can choose to rebuild RAID.

Way 1

1. Right-click the name of the disk array you want to rebuild and the “Rebuild” menu will appear.

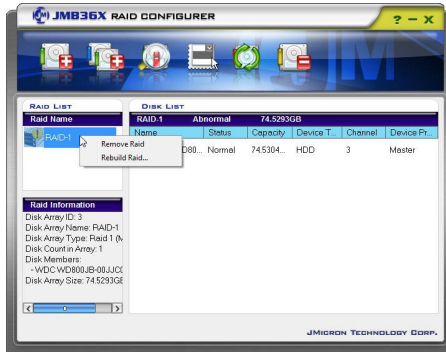

- 2. Select "Rebuild Raid".
- 3. A "REBUILD RAID WIZARD" dialogue will display on the screen, following the description of every step to complete the rebuilding.

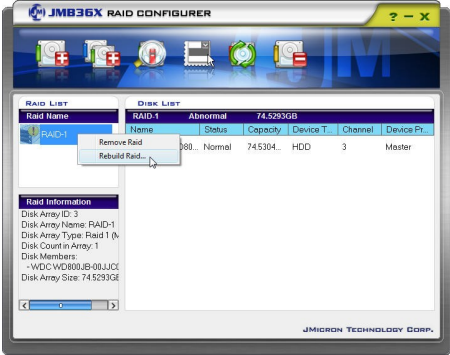

Way 2

- 1. If the disk array needs to rebuild then the rebuild button will be enabling on the toolbar.

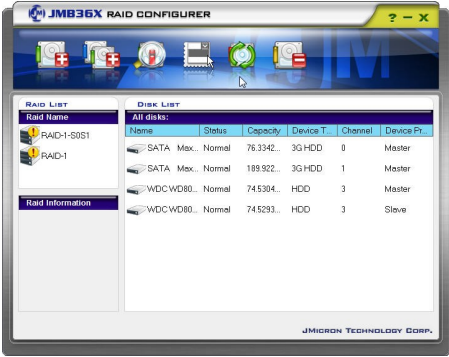

MS-7514 Mainboard

2. Left-Click the “Rebuild Raid” button on the toolbar.
3. A “REBUILD RAID WIZARD” dialogue will display on the screen, following the description of every step to complete the rebuilding.

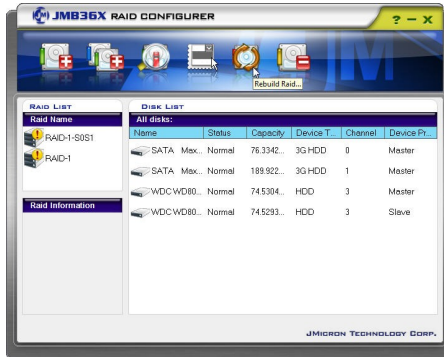

Solve Mirror Conflict

If the conflict occurs, it will show the “REBUILDING RAID WIZARD” dialogue to ask you if you want to rebuild RAID, following the description of every step to rebuild the RAID.

