

# Table of Contents

- Chapter 1: Introduction**----- 2
  - 1.1 Mainboard Features ----- 3
- Chapter 2: Hardware Installation**----- 5
  - 2.1 Mainboard Layout and Connectors Jumpers View---- 5
  - 2.2 Connectors and Jumpers Setting----- 6
  - 2.3 Install CPU ----- 13
  - 2.4 Install Memory ----- 18
  - 2.5 The instruction for VIA Chipset----- 19
  - 2.6 Install the sound driver----- 20
  - 2.7 Hardware Monitoring----- 21
- Chapter 3: BIOS SETUP**
  - 3.1 Main Menu ----- 24
  - 3.2 Standard CMOS Setup ----- 26
  - 3.3 BIOS Features Setup ----- 28
  - 3.4 Advanced Chipset Features/Integrated Peripherals---- 32
  - 3.5 Setup Power Management ----- 41
  - 3.6 Setup PnP/PCI Configuration ----- 44
  - 3.7 PC Health Status----- 45
  - 3.8 Frequency/Voltage Control----- 46
  - 3.9 Supervisor/User Password Setting----- 48

The mainboard is high-performance person computer based on FC-PGA Socket 370 for Celeron,Coppermine 370 CPU.

This motherboard uses the high integrated VIA VT82C694X(VIA APOLLO PRO 133A)This chipset Support 133 MHz frequency.

The Apollo Pro 133A builds on the success of the Apollo Pro133,the industry's First available PC-133 chipset,the Apollo Pro 133A adds even more high-end Features while still maintaining its scalability and superior value,it is the first Chipset to martket with support for AGP 4X, the new advanced graphics protocol,the 133MHz frontside bus optimizes the performance of intel's 133MHz Pentium III and other next-generation processors,the highly scalable asynchronous bus design also makes the Apollo Pro133A suitable for Pentium II And Celeron-based systems.the Apollo Pro133A delivers advanced performance through support for AGP 4X,133MHz, FSB, PC-133 SDRAM,ATA-66,

Through its advanced memory controller architecture the Apollo Pro 133A supports PC133 and VC/133 DRAMs,the latest high-performance and cost-effective memory types,support for ATA-66,the latest fast-IDE transfer protocol Advance HDD access and data throughput and boosts overall system performance,additional features include 2USB ports and advanced power management.

The VIA VT82C686A Chipset integrates all system control function such as ACPI(Advanced Configuration and power interface) The ACPI provides more Energy Saving Features for the OSPM(OS Direct Power Management)function. This chipset also improves the IDE Transfer rate by supporting Ultra DMA 66 IDE that Transfer data at the rate of 66MB/s,and Integrated in chip with Audio 97 sound Codec.support AMR ,this is Super South bridge.

Accelerated Graphics Port (AGP or A.G.P.)

Typically, 3D graphics rendering requires a tremendous amount of memory,and demands ever increasing throughput speed as well. As 3D products for the personal computer become more and more popular, these demands will only increase. This will cause a rise in costs for both end users and manufacturers. Lowering these costs as well as improving performance is the primary motivation behind AGP. By providing a massive increase in the bandwidth available between the video card and the processor, it will assist in relieving some of these pres-sures for quite sometime.

## **1.1 Mainboard Features**

### **Processor**

Socket 370 of  
Celeron,Coppermine CPU

### **Chipset**

VIA 694X + 686A

### **Sound**

Integrated in chip with Audio AC97 sound codec  
Support Line out, Mic., Line in, Game port

### **Expansion Slot**

- 1 \* AGP (32bit) slot for 4X mode
- 5 \* PCI (32 bit) slots
- 1 \* ISA (16 bit) slot
- 1 \* AMR slot (Audio Modem Riser)

### **Memory**

3 \* 168 pin DIMM sockets up to 1.5GB  
Support SDRAM / (VCM) Virtual Channel Memory

### **BIOS**

Award BIOS (Support Advanced Power Management Function)  
with ACPI, DMI, Green and PnP  
(Flash ROM for easy upgrade)

### **IDE**

2 Bus Master IDE ports (up to 4 IDE devices)  
Support Ultra DMA 33 / 66 function

### **I/O Interface**

Support PS/2 keyboard and mouse  
2 Serial ports (16550 High speed UART)  
1 Parallel port (SPP / EPP / ECP)  
2 USB connectors (2 USB channel for 4 USB ports)  
ATX double decker for I/O connectors  
Support IrDA TX / RX header

**Other Features**

Switching voltage regulator

Support CPU temperature warning function

Support 66MHz ~ 133MHz bus clock

ACPI Power Management, Soft-off control

STR(Suspend to RAM)

Support Modem Ring-in and RTC Alarm Wake-up

Support Wake-On-Lan Connector

Support SCSI / CD-ROM boot function

**Power**

ATX power connector

**Board Size**

ATX factor by 30.5cm \* 21.5cm, 4 Layers PCB

## Chapter 2 Hardware Installation

### 2.1 Mainboard Layout And Connectors Jumpers View

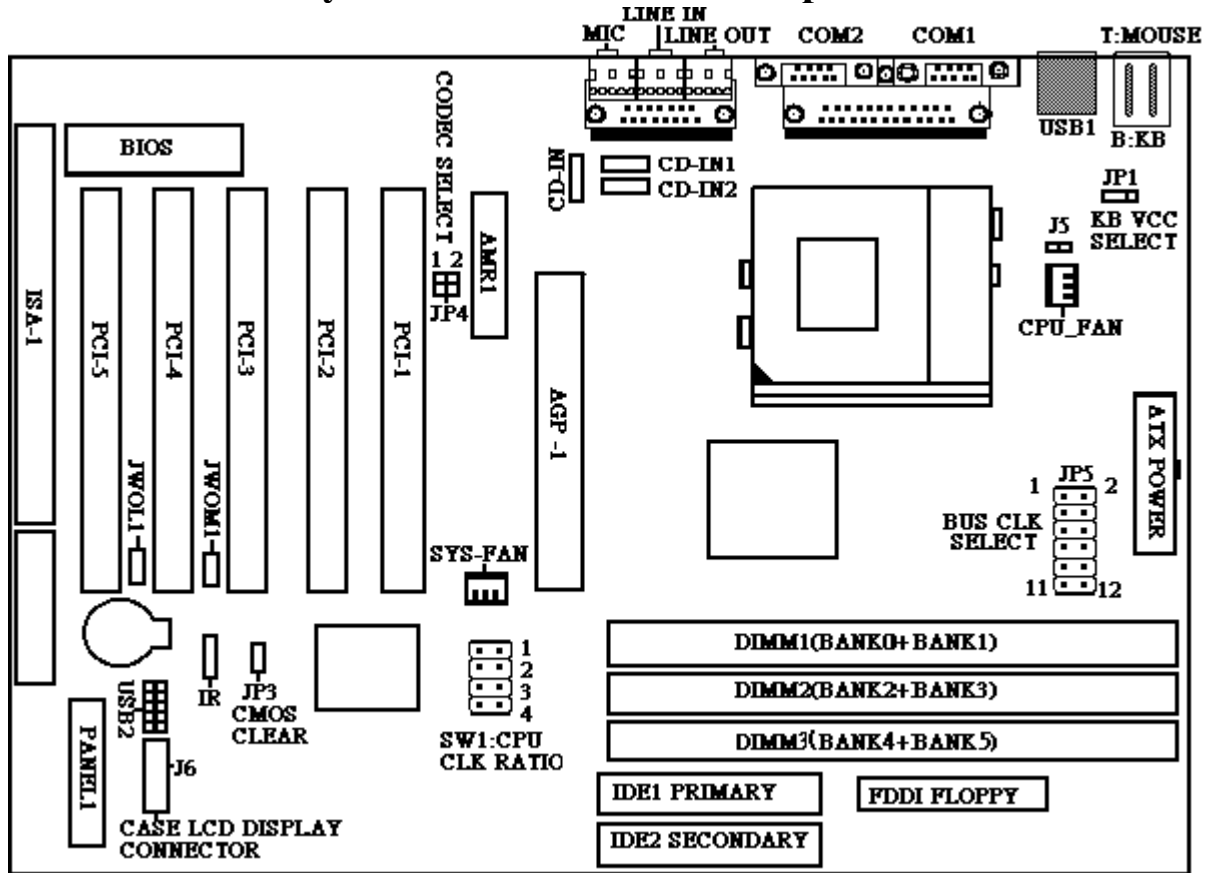

#### Ultra DMA 66 Cable(40 pin connector & 80 line cable)

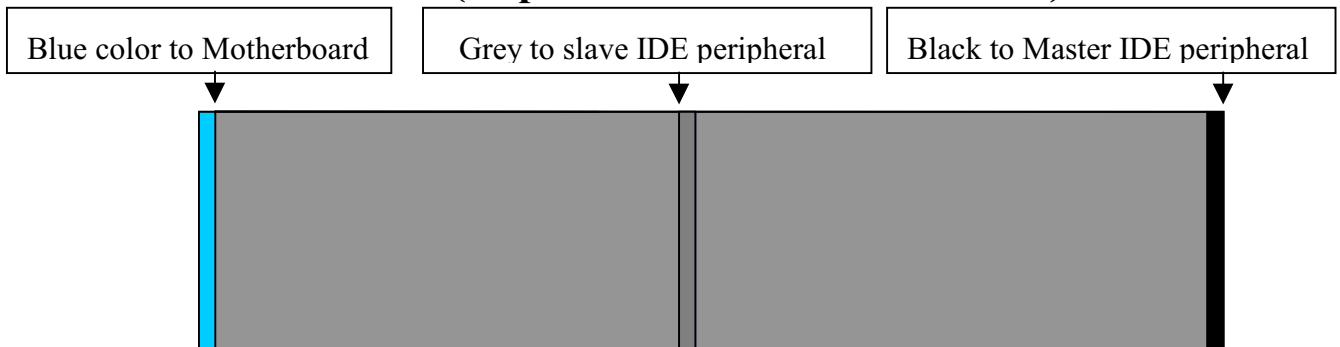

## 2-2 Connectors & Jumper Setting

PANEL1: Power LED, Speaker, ATX Power Stand By Led, ATX Power Switch, Reset, Hard disk Led, STR Led,

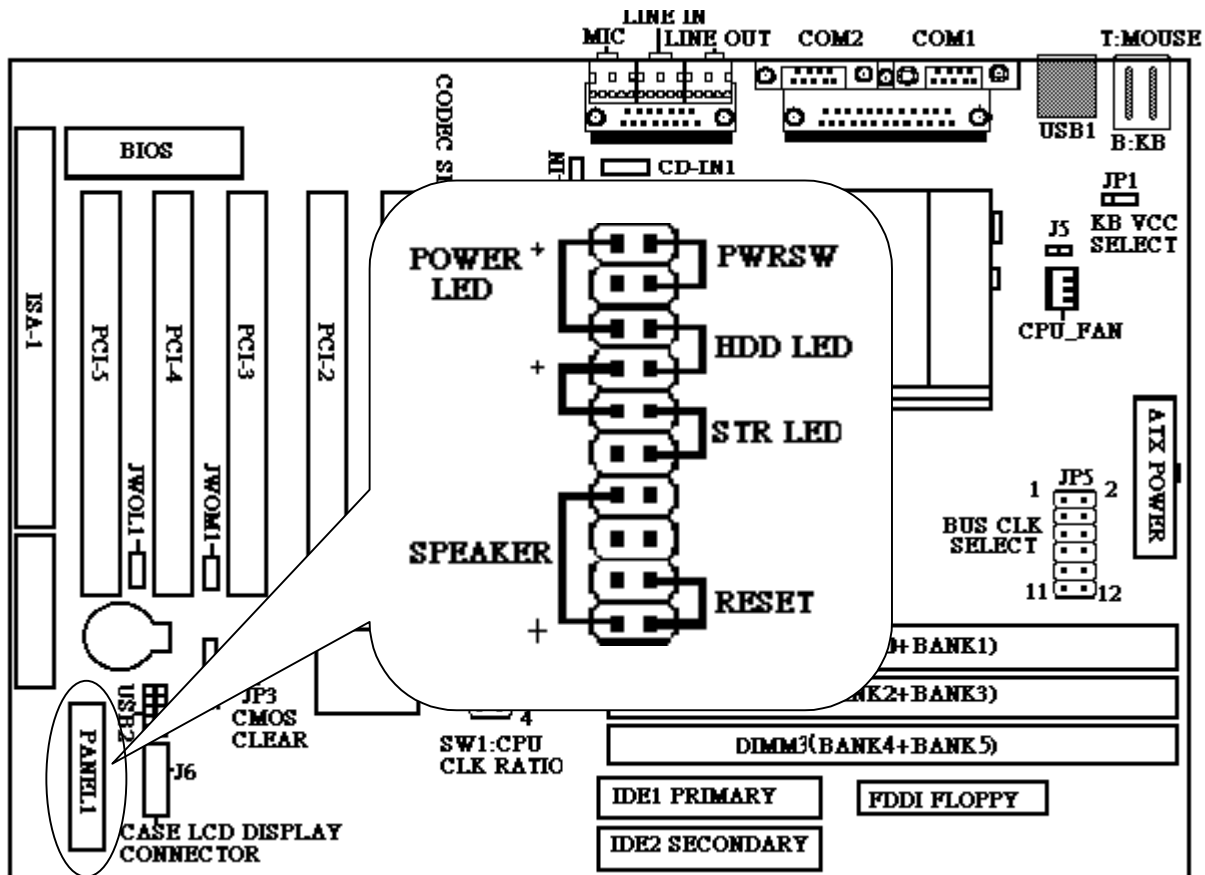

PS: ATX POWER SWITCH

*1. For Bios Setup Power Management Setup, In One Of The Item "SOFT-OFF BY PWR-BTTN: DELAY 4 SEC "*

*In this mode, When You One Touch (1 SEC.) will be into the suspend mode, and press Any key will recover it. If you are keeping touch 4 sec above, the ATX power will be off.*

*2. If you shut down the computer the ATX POWER STAND BY LED will light.*

## PS/2 Mouse Connector & Keyboard Connector

## USB1 ( Universal Serial Bus ) Connector

## Serial Port 1 Connector , Serial Port2 Connector , Printer Port Connector, Line in, Line out, MIC, Game port.

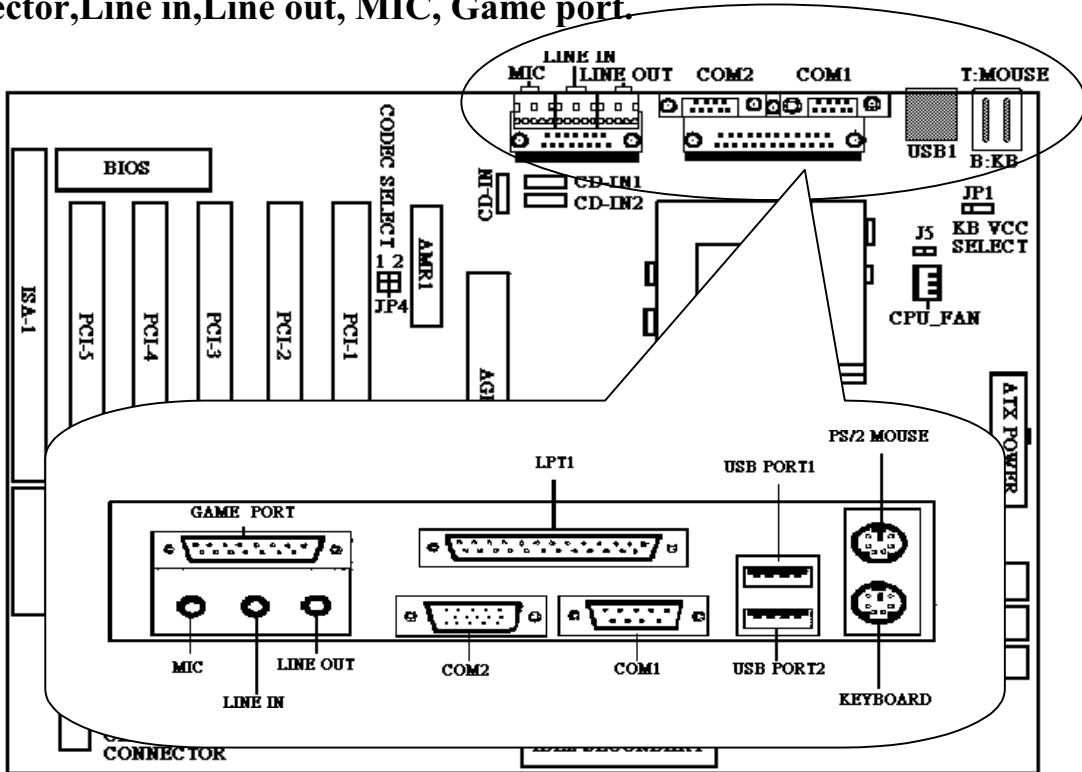

## ATX POWER SUPPLY CONNECTOR

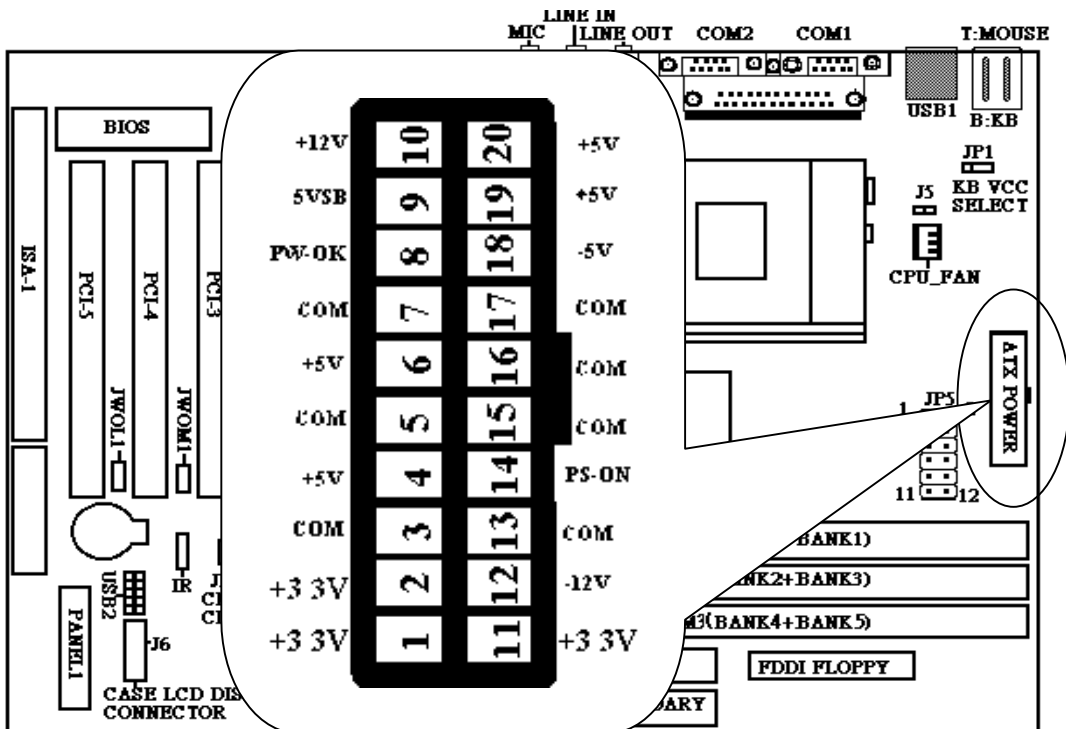

## IR :FIR/CIR CONNECT

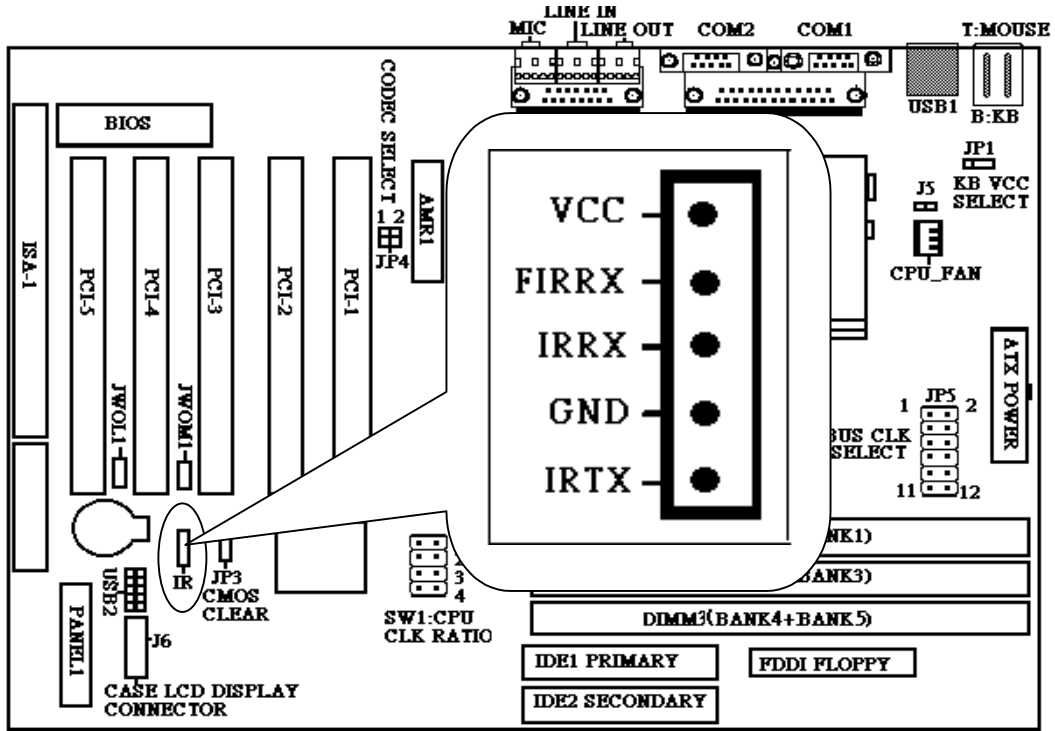

## JWOL1 : WOL ( WAKE ON LAN ) CONNECT

For supporting this feature,the system must have a ATX Power Supply), that must provide at least 800mA driving ability on the "5V standby"voltage

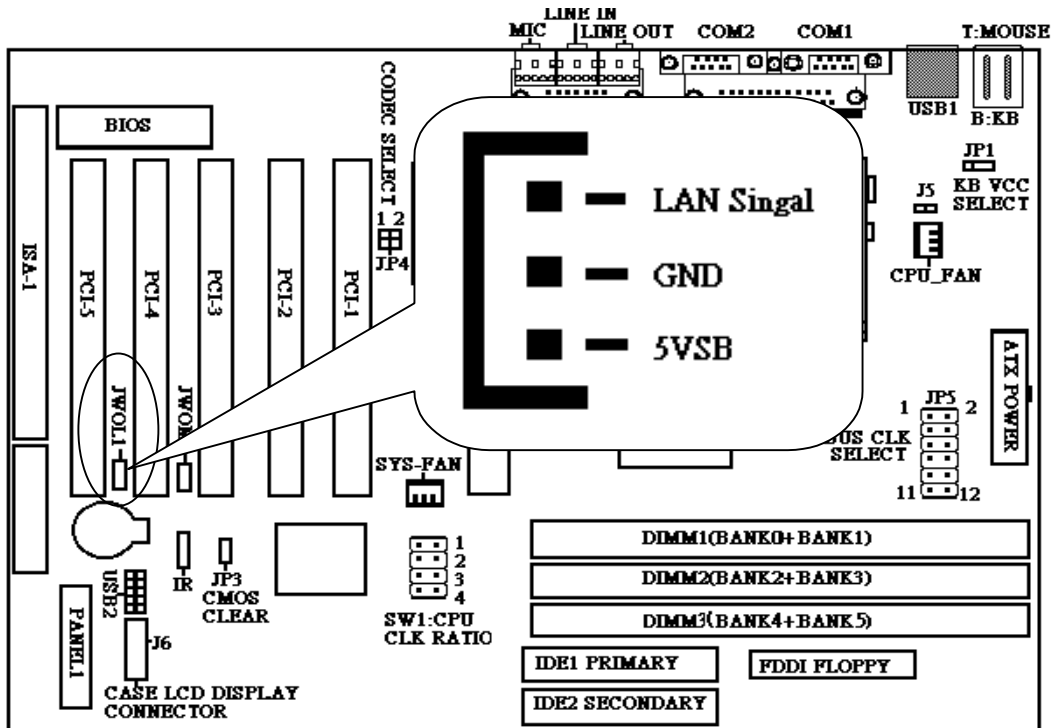



# JWOM1 : WOM ( WAKE ON MODEM ) CONNECT

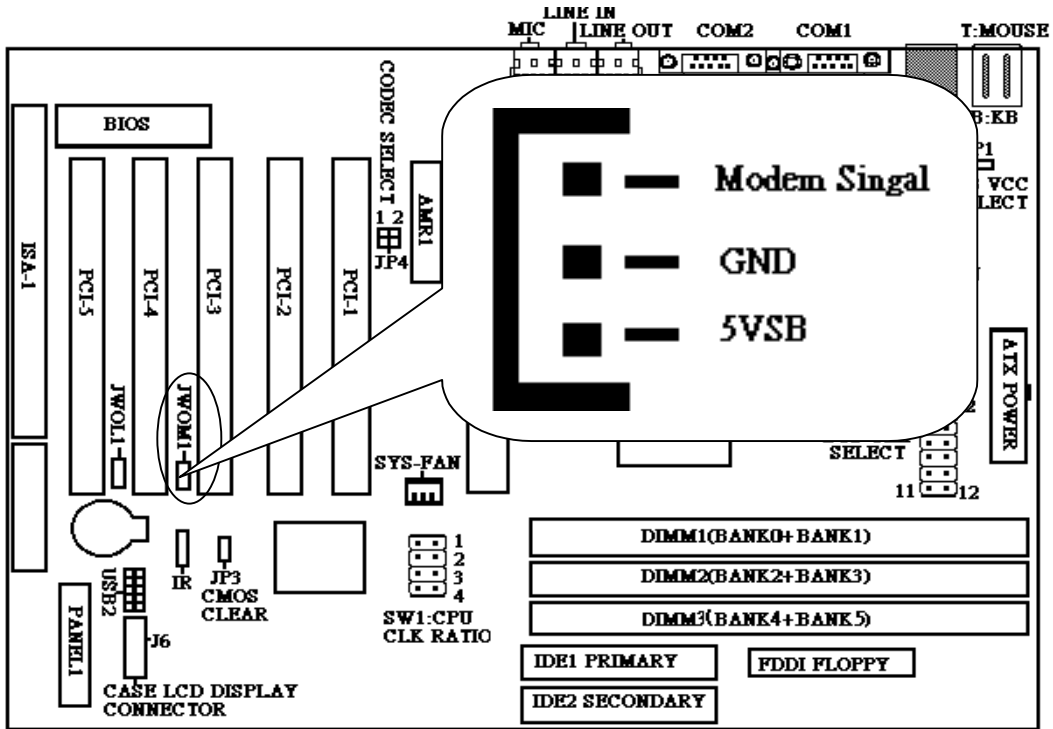

# CPU-FAN: CPU FAN CONNECT

# SYS-FAN : SYSTEM FAN CONNECT

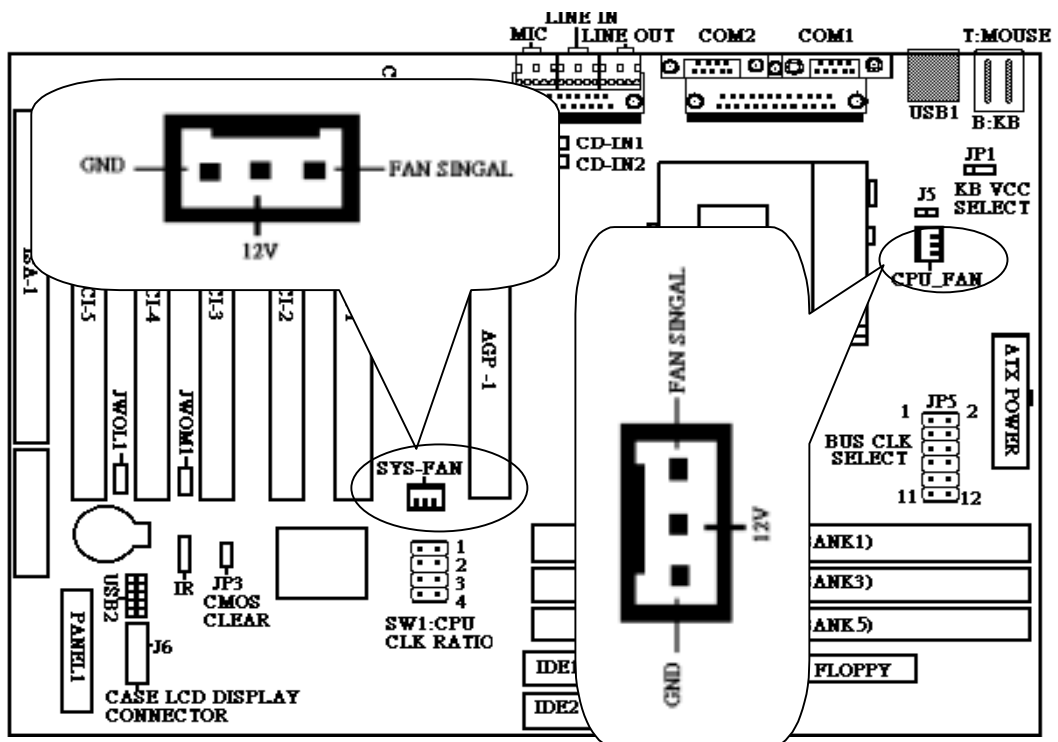

## USB2 : USB2 CONNECT

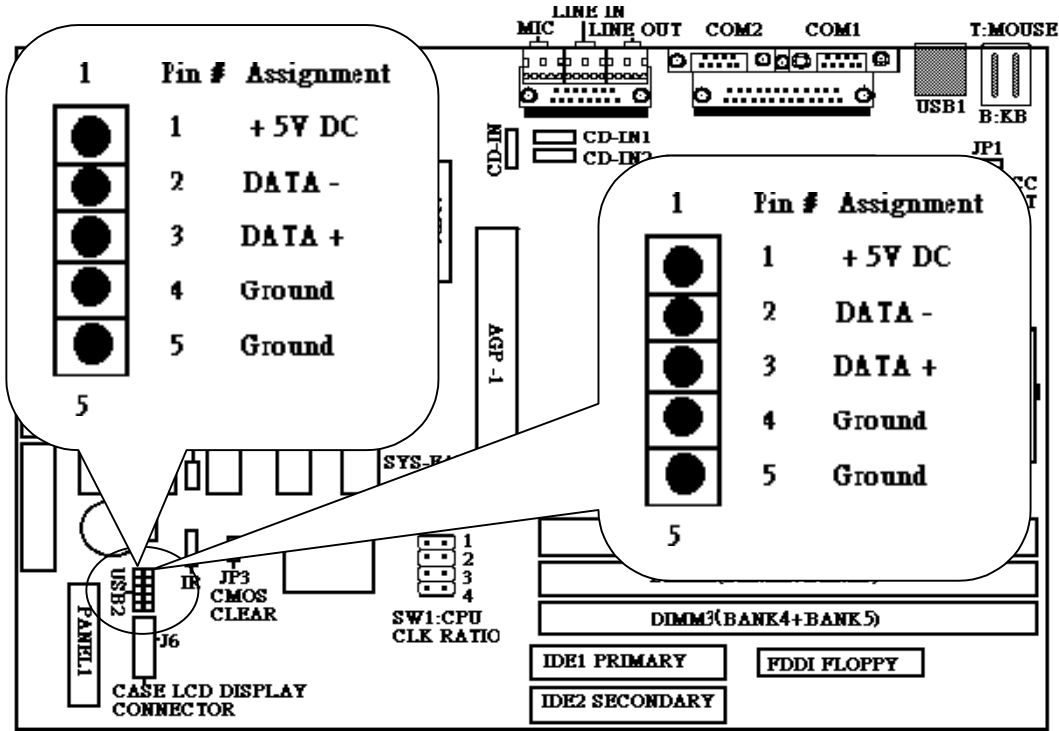

## JP3: CMOS CLEAR SELECT

Clear CMOS: When you clear CMOS ,you got to power off(AC&DC) your computer, And set jumper 2-3 close to clear CMOS about 5~10 secs,and you should change JP3 to normal 1-2 close(default).

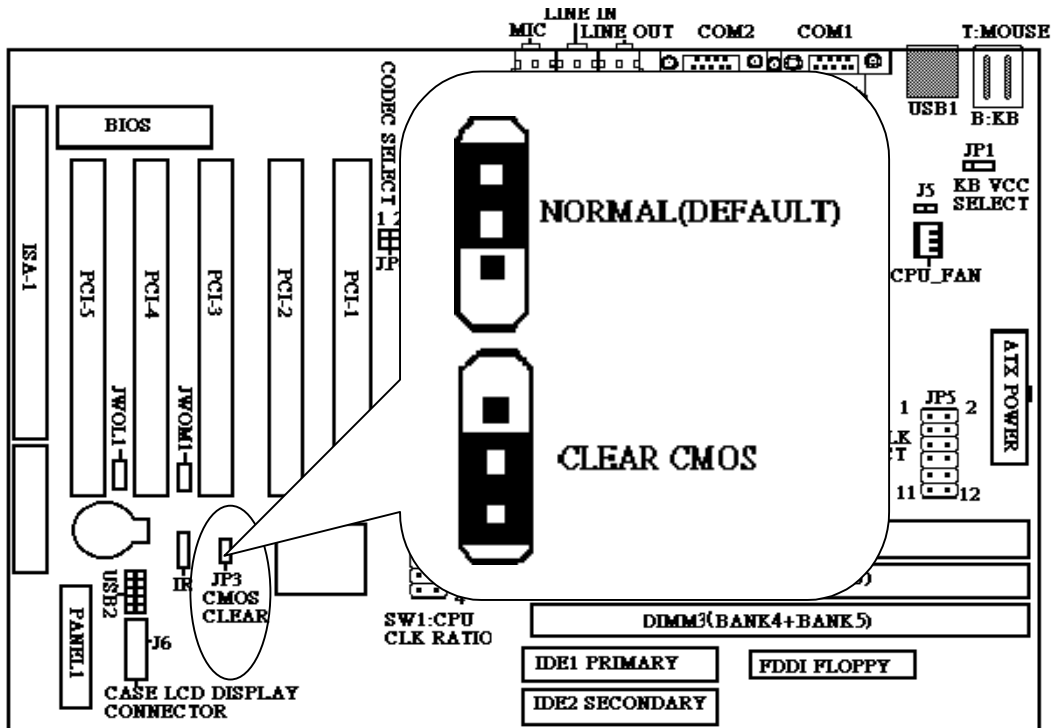

**JP1: KEYBOARD VCC SELECTOR**

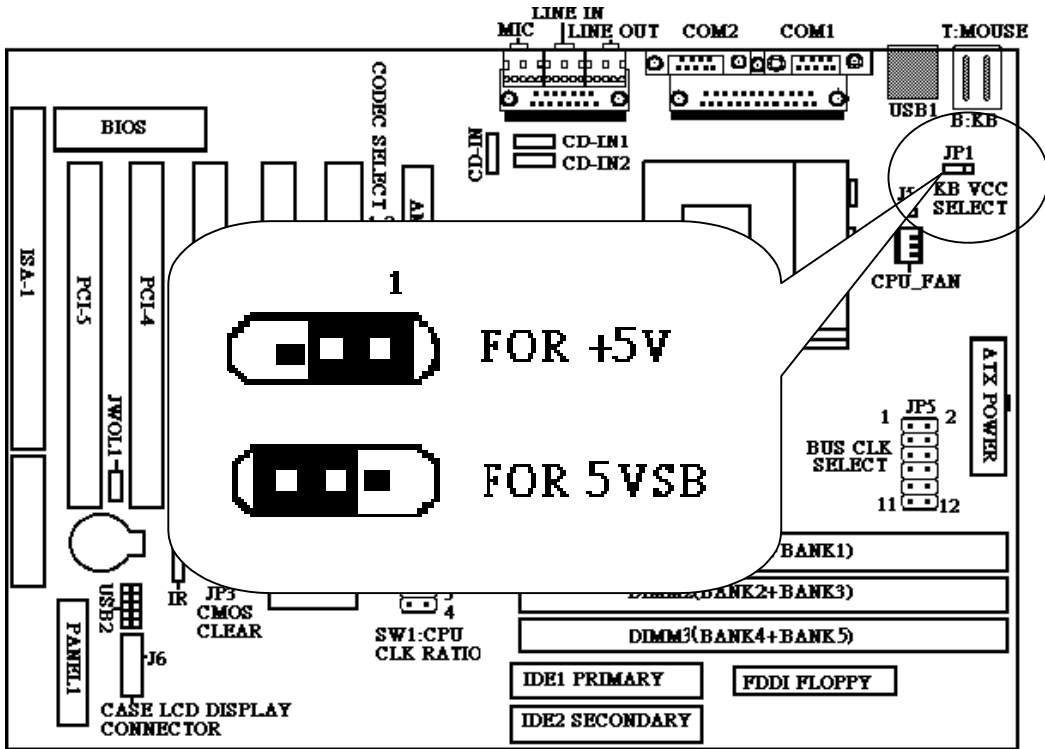

**JP4: CODEC SELECT**

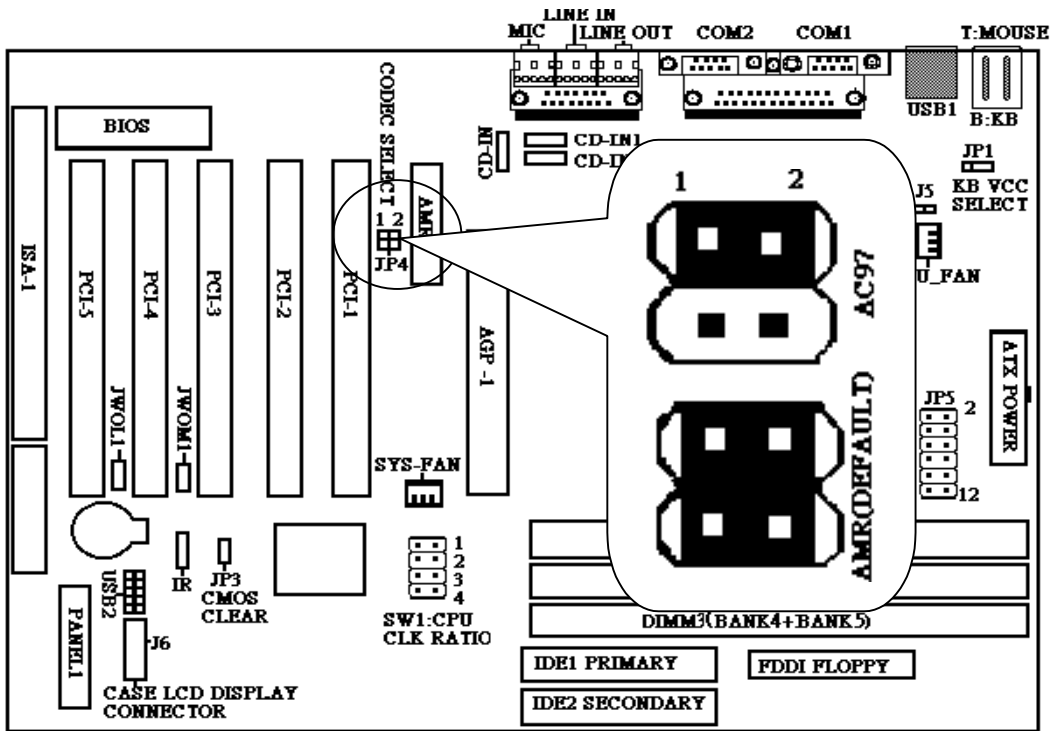

# J6: CASE LCD DISPLAY CONNECT(PORT 80) (OPTION)

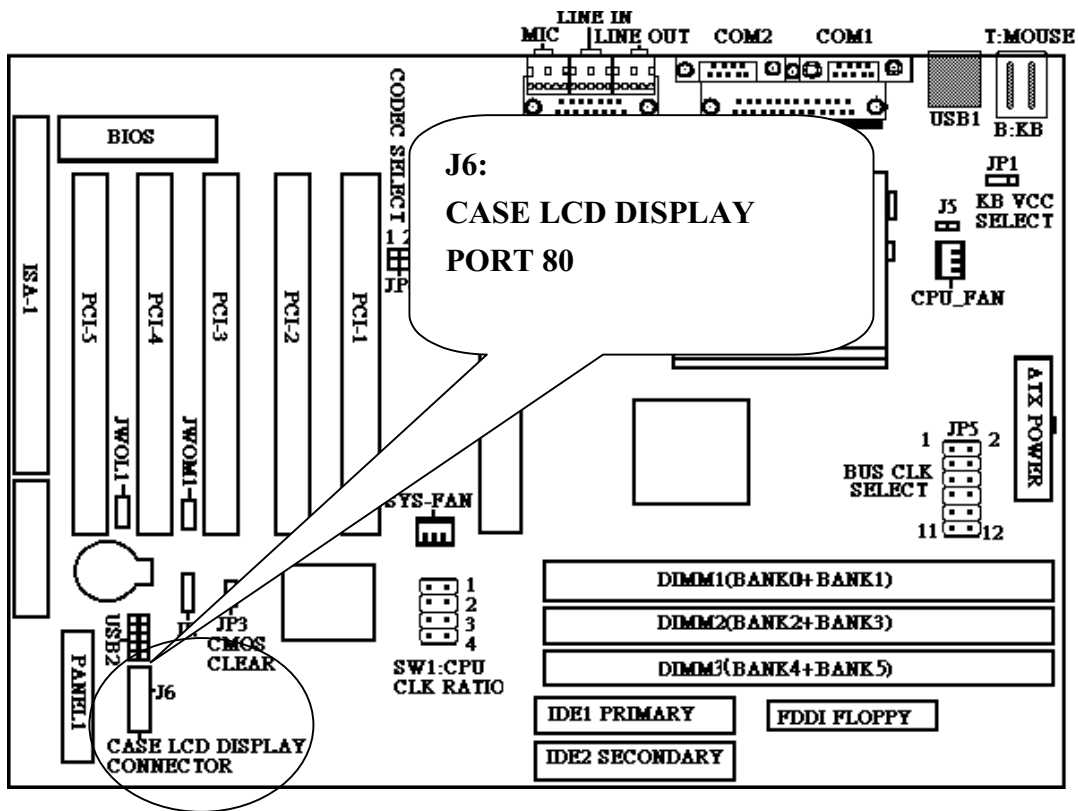

## 2-3 INSTALL CPU

### INTEL CELERON, COPPERMINE ( SW1 ) CPU RATIO SETTING

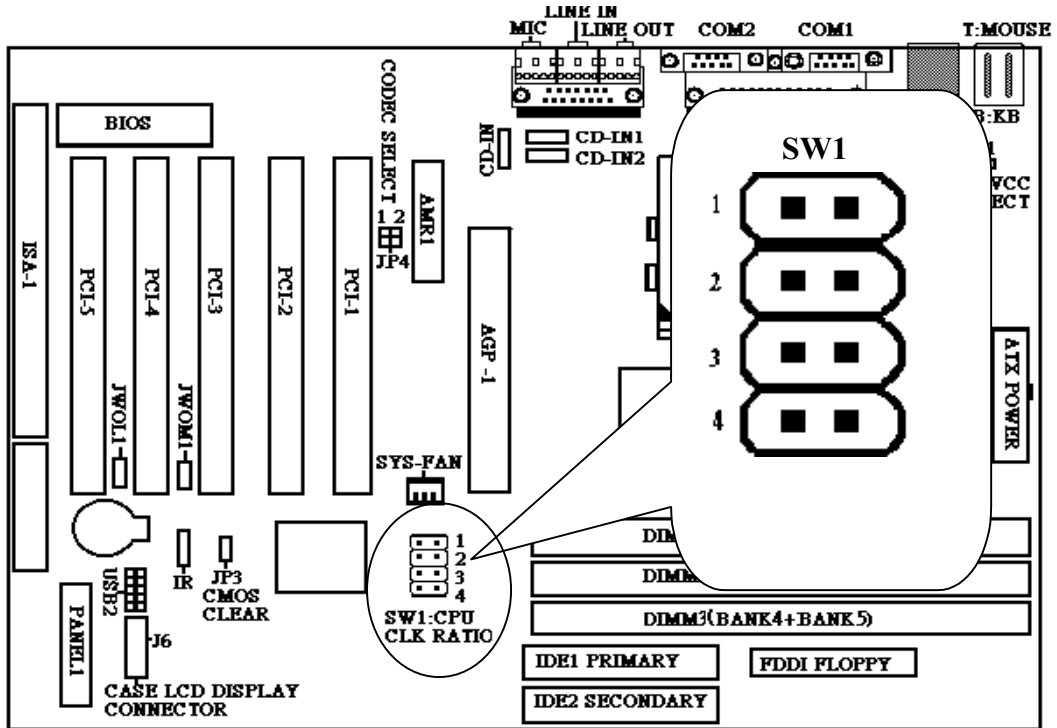







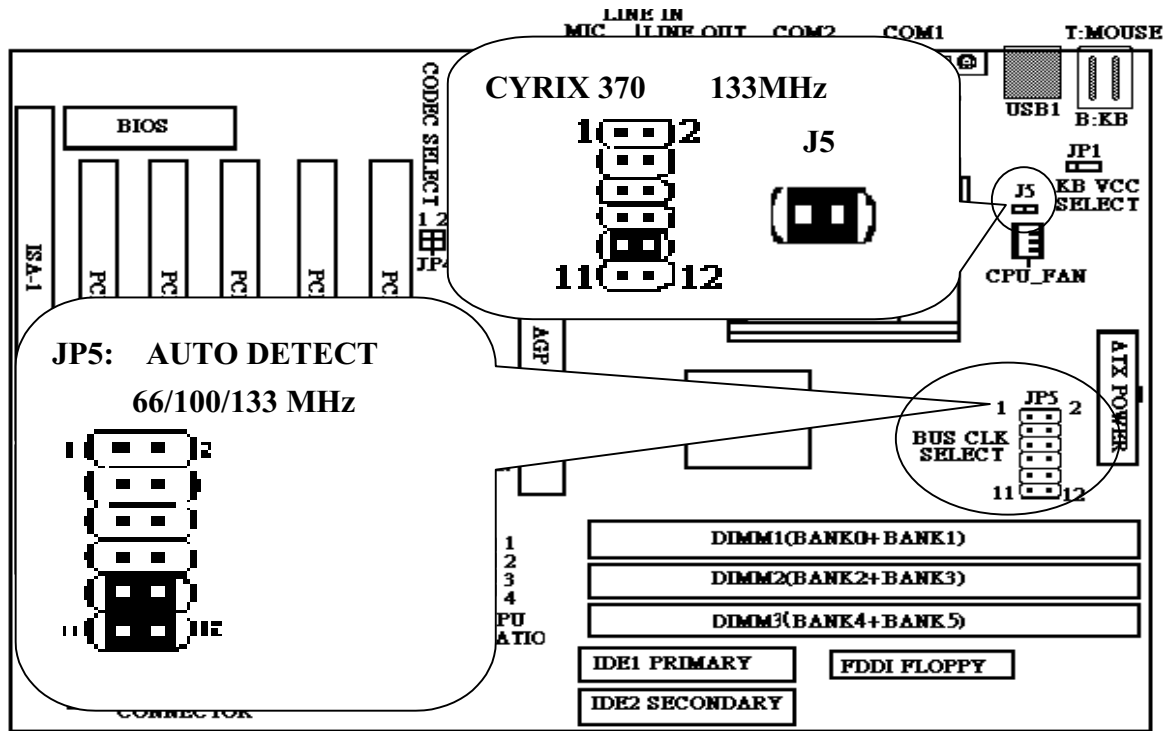



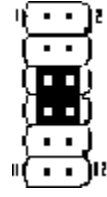
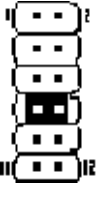





### SW1 CPU RATIO ( SW1 ) SELECTOR

CPU RATIO	SW 1	CPU RATIO	SW 1	CPU RATIO	SW 1
3X		5X		7X	
3.5X		5.5X		7.5X	
4X		6X		8X	
4.5X		6.5X			

## (2). CPU CLK SETTING FOR AUTO DETECT AND MANUAL



CPU CLK				
CLK TYPE	JP5	BUS CLK (MHZ)	JP5	BUS CLK (MHZ)
AUTO DETECT		66/100/133 (default)		83
MANUAL		66		100
MANUAL		75		103
MANUAL		80		110

CLK TYPE	JP5	BUS CLK (MHZ)	JP5	BUS CLK (MHZ)	
MANUAL		112		133	
MANUAL		115		140	
MANUAL		120		150	
MANUAL		124	Cyrix 370	JP5 	J5 Bus Clk
					133 MHz

**Warning:**

*the frequency spec. of Via chipset bus clock is set as 133MHz  
 When you set the frequency of chipset over 133MHz. We don't promise  
 the over 133MHz setting could keep the system continue to work stable.*

**(3) AUTO DETECT ( 66/100/133 MHZ )CLK**

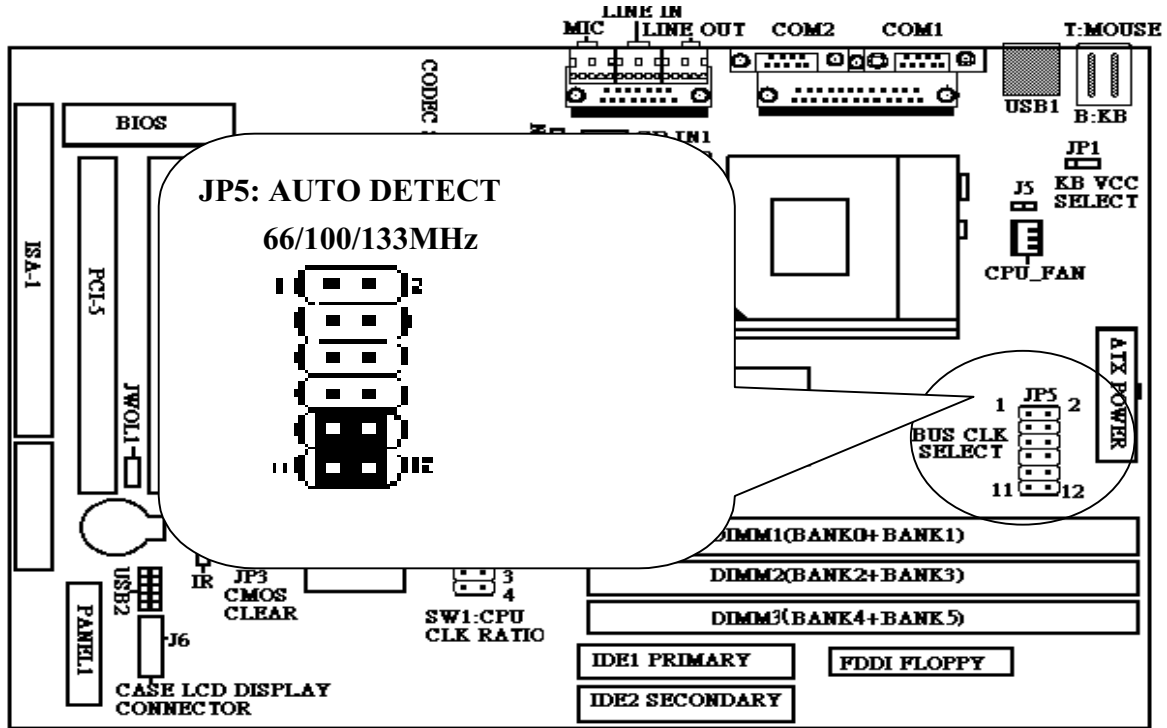















**(4) QUICK INSTALL CELERON AND COPPERMINE CPU.**

<1>CELERON (REFERENCE)

Product Name	BUS CLK	RATIO	SW1	Product Name	BUS CLK	RATIO	SW1
CELERON 233	66 (MHZ)	3.5X		CELERON 400	66 (MHZ)	6X	
CELERON 266	66	4X		CELERON 433	66	6.5X	
CELERON 300	66	4.5X		CELERON 466	66	7X	
CELERON 333	66	5X		CELERON 500	66	7.5X	
CELERON 366	66	5.5X		CELERON 533	66	8X	

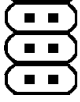

**<2>COPPERMINE (REFERENCE)**

Product Name	BUS CLK	RATIO	SW1	Product Name	BUS CLK	RATIO	SW1
500E	100 (MHZ)	5X	1 2 3 4 	533EB	133 (MHZ)	4X	
550E	100	5.5X		600EB	133	4.5X	
600E	100	6X		667B	133	5X	
650	100	6.5X		733B	133	5.5X	
700	100	7X		800B (Future)	133	6X	
750	100	7.5X		867B (Future)	133	6.5X	
800 (Future)	100	8X		933B (Future)	133	7X	
				1GB (Future)	133	7.5X	

**“B”-----133MHz System Bus Frequency**

**“E”-----Processor with “Advanced Transfer Cache**

- \* The M/B Design Auto-Detect CPU BUS CLK 66 & 100 & 133MHZ Frequency
- \* No Jumper Needed For Setting .
- \* For 133 MHZ BUS CLK . We Suggests Using “ PC – 133 “ SDRAM SPEC .
- \* For Better Reliability . We Suggests Using SPD ( Serial Port Data ) SDRAM SPEC

**Note: The Above quick install CPU only for reference,our motherboard Ratio setting is not change.**

## 2-4 INSTALL MEMORY

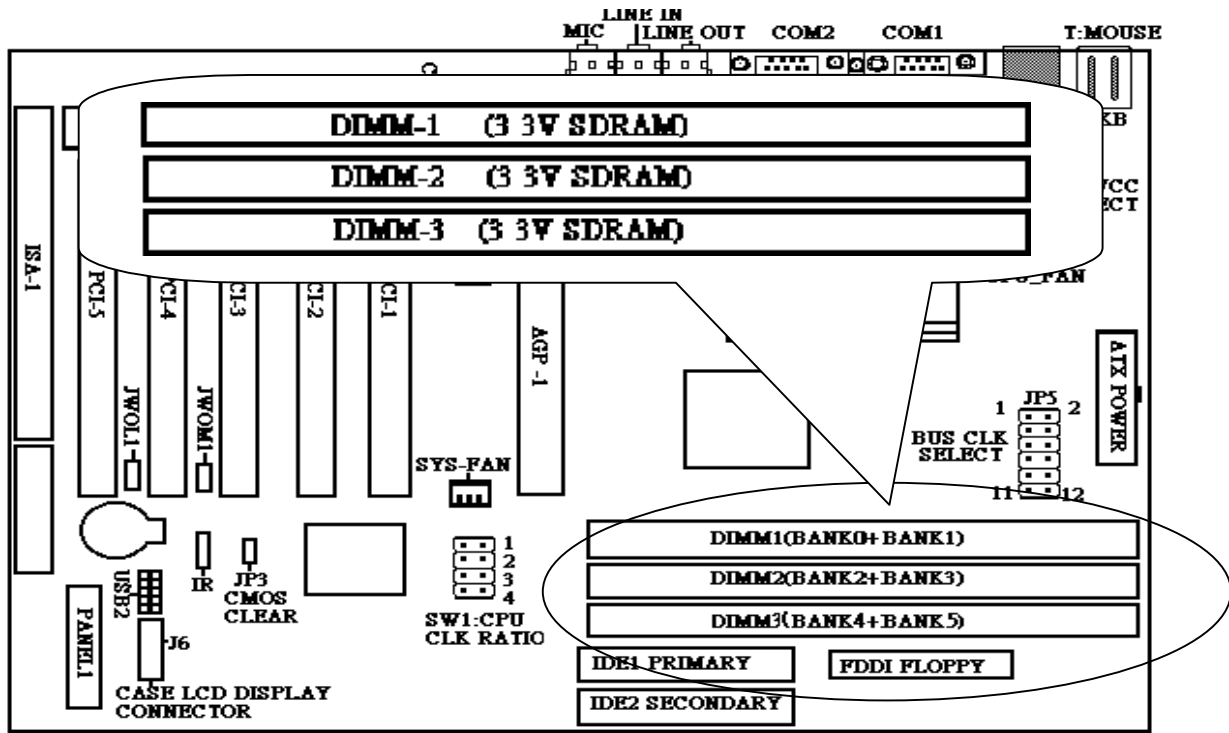

### (1) PCB LAYOUT AND RELEVANT POSITIONS FOR DIMM X 3

(2) The Supports Different Type Of Settings For The System Memory . There Is No Jumper Nor Connect Needed For Memory Configuration . Following Figures Provides All Possible Memory Combinations .

SDRAM			STATUS
BANK0	BANK1	BANK2	
DIMM1	DIMM2	DIMM3	
INSTALLED	NONE	NONE	OK
NONE	INSTALLED	NONE	OK
NONE	NONE	INSTALLED	OK
INSTALLED	INSTALLED	NONE	OK
NONE	INSTALLED	INSTALLED	OK
INSTALLED	NONE	INSTALLED	OK
INSTALLED	INSTALLED	INSTALLED	OK

#### NOTE :

- 1 . SDRAM Module Specification : 3.3 V Only .
- 2 . For 133 MHZ BUS CLK . We Suggests Using “ PC – 133 “ SDRAM SPEC .
- 3 . For Better Reliability . We Suggests Using SPD ( Serial Port Data ) SDRAM SPEC .

## **2-5 The Instruction For VIA Chipset**

### **1, VIA 4-in-1 Driver**

The 4-in-1 driver is suitable for all VIA chipsets using Windows 95, 98, NT. This driver will install the:

**IDE Busmaster.**

**VIA AGP**

**IRQ Routing Driver.**

**VIA ACPI Registry.**

If you are using Windows 98 SE, you do not need to install the 4-in-1 driver as the IRQ Routing Driver and the ACPI Registry are already incorporated into the operating system. Users with Windows 98 SE may update the IDE Busmaster and AGP drivers by installing them individually.

The 4-in-1 driver : D:\VIA\694DRV\VIADRV\SETUP.EXE

*If you are using Windows 2000, you do not need to install the 4-in-1 driver*

### **2,Hardware Monitoring.**

Hardware monitoring allows you to monitor various aspects of your systems operations and status. The features include CPU temperature, voltage and RPM of fan.

The Hardware Monitor Software, an application software based on Microsoft Windows 95 (98) / NT4.0, is used to control the VT82C686A Chipset System Hardware Monitor. It can monitor the temperatures, power supply voltages and fan speeds via VT82C686A Chipset and show the information on screen periodically. User can use it to specify temperature, voltage and fan speed configurations used by VT82C686A ,By the way, the alarm warning events and polling interval could also be set by this software. If there is an abnormal event happens, it will pop up a window on screen to inform the user the abnormal situation.

### **Installing the Hardware Monitor Software on Windows 95 (98) / NT4.0:**

- 1.Start Windows 95 (98) / NT4.0.
- 2.Insert the driver CD disk
- 3.Choose "Run" from the "Start" menu.
- 4.In the "Run" dialog, type "D:\VIA\694DRV\HWM\SETUP.EXE" and click the "next" button.
- 5.The System Monitor setup program will start.
- 6.Follow the setup program's on-screen instructions.
- 7.The software will pop up when user click it's icon on taskbar area.

## 2-6 Install the Sound driver

### 1, Installing the Onboard Sound Driver on Windows 95 (98,2000) / NT4.0:

- 1.Start Windows 95 (98,2000) / NT4.0.
- 2.Insert the driver CD disk
- 3.Choose "Run" from the "Start" menu.
- 4.In the "Run" dialog, type "D:\VIA\694DRV\AC97\SETUP.EXE" and click the "next" button.
- 5.The System Monitor setup program will start.
- 6.Follow the setup program's on-screen instructions.
- 7.The software will pop up when user click it's icon on taskbar area.

#### Features

- \*16 bit stereo high quality sound
- \*Spatializer 3D sound
- \*Plug & Play Ready
- \*Support Full Duplex mode
- \*Record, compress, and playback voice, sound, music
- \*Mixer controlled recording, 6 channel mixer
- \*3-D Audio LINE Output, Stereo Input for LINE IN, Mono Input for Microphone, GAME Port for Joystic or MIDI kit
- \*BUILT in power amplifier
- \*Windows compatible and OLE complinat and OPL3 compatible
- \*Supports the Microsoft Windows Sound system
- \*Sound Blaster and Sound Blaster Pro compatible

### 2, Hardware Connect & Jumper

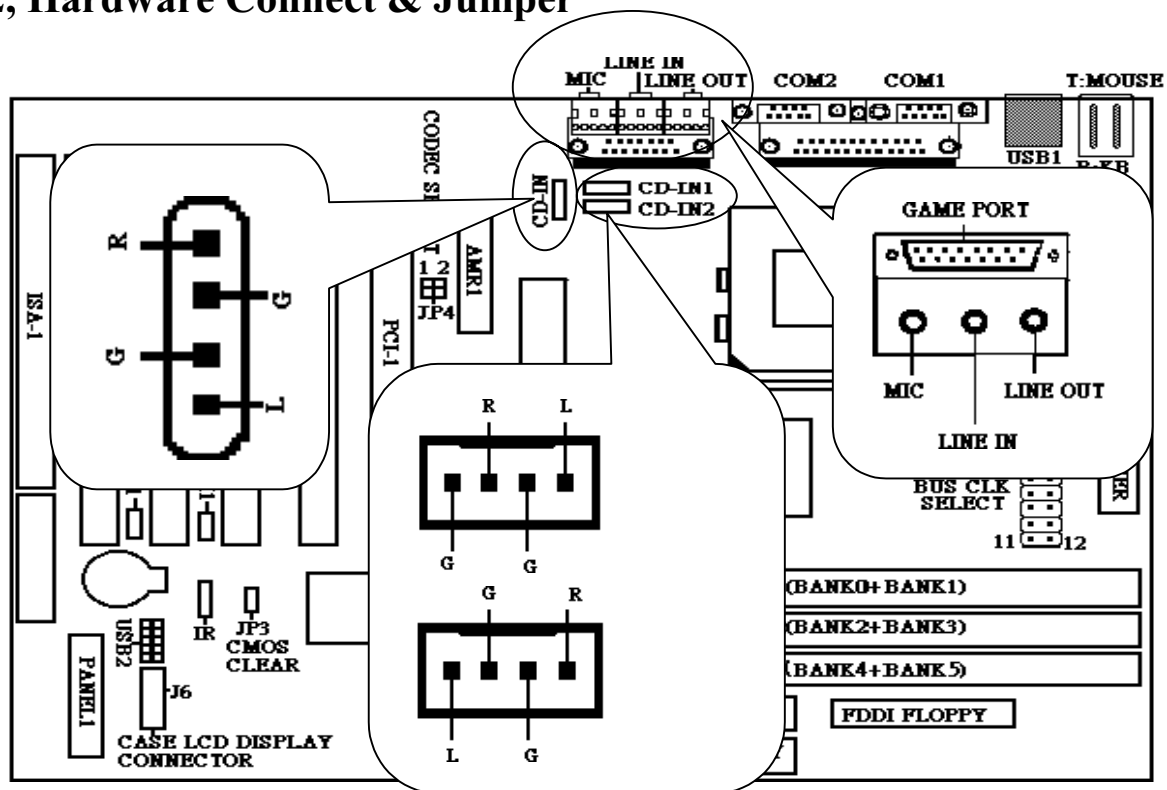

## 2-7 Hardware Monitoring.

Hardware monitoring allows you to monitor various aspects of your systems operations and status. The features include CPU temperature, voltage and RPM of fan.

### 1, PC Health Status

CMOS Setup Utility – Copyright © 1984 – 2000 Award Software  
PC Health Status Setup

Current CPU Temp.	24°C/75°F	Item Help
Current System Temp	16°C/60°F	
		Menu Level >
Current CPU-FAN Speed	5002 RPM	
Current SYS-FAN Speed	0 RPM	
Vcore	2.01V	
2.5V	2.51V	
3.3V	3.3V	
5V	5V	
12V	12V	
↑↓←→Move Enter: Select +/-/PU/PD: Value F10:Save ESC: Exit F1:General Help F5:Previous Values F6:Fail-safe defaults F7:Optimized Defaults		

#### Current CPU Temperature

This is the current temperature of the CPU.

#### Current System Temp

This is the Current temperature of the system.

#### Current CPU- FAN Speed

The current CPU- fan speed in RPMs.

#### Current SYS- FAN Speed

The current SYS- fan speed in RPMs.

**CPU(V):** The voltage level of the CPU(Vio/Vcore).

**+2.5V, +3.3V, +5V, +12V:** The voltage level of the switch power supply..

## 2. Hardware Monitor for Win95/98/2000 AND WinNT.

When you install the **Hardware Monitor** driver and you will appear as follows: **VIA Hardware Monitor System V 1.07**

Temperature		
CPU Over-Heat Temp.	50 (Celsius)	<input checked="" type="checkbox"/> Celsius <input type="checkbox"/> Fahrenheit
CPU Hysterisis Temp.	40	
CPU Current Temp.	14	
System Over-Heat Temp.	50	
System Hysteresis	40	
System Current Temp.	16	
Voltage (V)	Fan Speed(RPM)	
Vcore Value=2.03	CPU Fan: 5080	<input type="checkbox"/> CPU Over Heat  <input type="checkbox"/> CPU Hysteresis Low  <input type="checkbox"/> System Over Heat  <input type="checkbox"/> System Hysteresis Low  <input type="checkbox"/> Voltage Abnormal  <input type="checkbox"/> CPU Fan Low  <input type="checkbox"/> System Fan Low
2.5V Value=2.49	System Fan: 0	
3.3V Value=3.37	CPU Fan RPM 0	
5V Value=5.03	System Fan RPM 0	
12V Value=11.83	Polling Interval 5 secs	
Range 125%... 75%		

**UPDATE W/O SAVE**

**UPDATE AND SAVE**

**DEFAULT SETTING**

**USER SETTING**

**CLOSE**

**MiniMize**

**ALARM**

 CPU Over Heat  
  
 CPU Hysteresis Low  
  
 System Over Heat  
  
 System Hysteresis Low  
  
 Voltage Abnormal  
  
 CPU Fan Low  
  
 System Fan Low

**SUBJECT : Y2K**

**AWARD Announcement**

*Award BIOS Supports Year 2000 and Beyond*

*Award Software International Inc. is pleased to announce that its BIOS software automatically solves*

*The changeover to the year 2000 ,all Award BIOSes with the date code July 07,1995,and beyond can now support all dates to year 2079.*

*For Award BIOSes with earlier release dates,the user may either simply re-set the system date manually or use a free utility that will be available from a award at the end of this year,We will continue our best efforts to provide customers the technical support they need .if we can be of any service or if you have any further questions about this announcement,please do not hesitate to call us. Thank you so much for your support of Award.*

*This announcement in the*

*Award web-site [www.award.com.tw/news/oct1\\_96.htm](http://www.award.com.tw/news/oct1_96.htm)*

*If you have any Y2k problem,you can visit the Award web\_site [www.Award.com.tw](http://www.Award.com.tw)*

### 3.1 Main Menu

Once you enter the AwardBIOS™ CMOS Setup Utility, the Main Menu will appear on the screen. The Main Menu allows you to select from several setup functions and two exit choices. Use the arrow keys to select among the items and press <Enter> to accept and enter the sub-menu.

#### CMOS Setup Utility - Copyright ( C ) 1984-2000 Award Software

Standard CMOS Feature	Frequency/Voltage Control
Advanced BIOS Feature	Load Fail-Safe Defaults
Advanced Chipset Feature	Load Optimized Defaults
Integrated Peripherals	Set Supervisor Password
Power Management Setup	Set User Password
PnP/PCI Configurations	Save & Exit Setup
PC Health Status	Exit Without Saving
Esc : Quit	↑ ↓ ← → : Select Item
F10 : Save & Exit Setup	
Time, Date, Hard Disk Type....	

Note that a brief description of each highlighted selection appears at the bottom of the screen.

#### Setup Items

The main menu includes the following main setup categories. Recall that some systems may not include all entries.

#### Standard CMOS Features

Use this menu for basic system configuration. See Section 2 for the details.

#### Advanced BIOS Features

Use this menu to set the Advanced Features available on your system. See Section 3 for the details.

#### Advanced Chipset Features

Use this menu to change the values in the chipset registers and optimize your system's performance. See section 4 for the details.



### **Integrated Peripherals**

Use this menu to specify your settings for integrated peripherals. See section 4 for the details.

### **Power Management Setup**

Use this menu to specify your settings for power management. See section 5 for the details.

### **PnP / PCI Configuration**

This entry appears if your system supports PnP / PCI. See section 6 for the details.

### **PC Health Status**

This entry appears the current system temperature,CPU temperature, Fan Speed, Shutdown temperature,and the Voltage.

### **Frequency/Voltage Control**

Use this menu to specify your settings for frequency/voltage control. See section 7 for the details.

### **Load Fail-Safe Defaults**

Use this menu to load the BIOS default values for the minimal/stable performance for your system to operate. See section 8 for the details.

### **Load Optimized Defaults**

Use this menu to load the BIOS default values that are factory settings for optimal performance system operations. While Award has designed the custom BIOS to maximize performance, the factory has the right to change these defaults to meet their needs. See section 8 for the details.

### **Supervisor / User Password**

Use this menu to set User and Supervisor Passwords. See section 9 for the details.

### **Save & Exit Setup**

Save CMOS value changes to CMOS and exit setup. See section 10 for the details.

### **Exit Without Save**

Abandon all CMOS value changes and exit setup. See section 10 for the details.

### 3.2 Standard CMOS Setup

The items in Standard CMOS Setup Menu are divided into 10 categories. Each category includes no, one or more than one setup items. Use the arrow keys to highlight the item and then use the <PgUp> or <PgDn> keys to select the value you want in each item.

**. CMOS Setup Utility – Copyright © 1984 – 2000 Award Software**  
**Standard CMOS Features**

Date:	Mon, Feb 8 1999	Item Help
Time:	16 :19 :20	
➤ IDE Primary Master	PRESS ENTER None	Menu Level ➤
➤ IDE Primary Slave	PRESS ENTER None	Change the day, month, year and century
➤ IDE Secondary Master	PRESS ENTER None	
➤ IDE Secondary Slave	PRESS ENTER None	
Drive A	1.44M, 3.5in	
Drive B	None	
Video	EGA/VGA	
Halt On	All ,But Keyboard	
Based Memory	640K	
Extended Memory	64512K	
Total Memory	65536K	
↑↓←→Move Enter: Select +/-/PU/PD: Value F10:Save ESC: Exit F1:General Help F5:Previous Values F6:Fail-safe defaults F7:Optimized Defaults		

## Main Menu Selections

This table shows the selections that you can make on the Main Menu

Item	Options	Description
Date	Month DD YYYY	Set the system date. Note that the 'Day' automatically changes when you set the date
Time	HH : MM : SS	Set the system time
IDE Primary Master	Options are in its sub menu (described in Table 3)	Press <Enter> to enter the sub menu of detailed options
IDE Primary Slave	Options are in its sub menu (described in Table 3)	Press <Enter> to enter the sub menu of detailed options
IDE Secondary Master	Options are in its sub menu (described in Table 3)	Press <Enter> to enter the sub menu of detailed options
IDE Secondary Master	Options are in its sub menu (described in Table 3)	Press <Enter> to enter the sub menu of detailed options
Drive A Drive B	None 360K, 5.25 in 1.2M, 5.25 in 720K, 3.5 in 1.44M, 3.5 in 2.88M, 3.5 in	Select the type of floppy disk drive installed in your system
Video	EGA/VGA CGA 40 CGA 80 MONO	Select the default video device
Halt On	All Errors No Errors All, but Keyboard All, but Diskette All, but Disk/Key	Select the situation in which you want the BIOS to stop the POST process and notify you
Base Memory	N/A	Displays the amount of conventional memory detected during boot up
Extended Memory	N/A	Displays the amount of extended memory detected during boot up
Total Memory	N/A	Displays the total memory available in the system

### 3.3 Advanced BIOS Features

This section allows you to configure your system for basic operation. You have the opportunity to select the system's default speed, boot-up sequence, keyboard operation, shadowing and security.

CMOS Setup Utility – Copyright © 1984 – 2000 Award Software  
Advanced BIOS Features

Virus Warning	Disabled	Item Help
CPU Internal Cache	Enabled	
External Cache	Enabled	
CPU L2 Cache ECC Checking	Enabled	Menu Level      ➤
Quick Power On Self Test	Enabled	
First Boot device	HDD-0	Allows you to choose the
Second Boot device	Floppy	VIRUS warning feature for IDE
Third Boot device	LS 120	Hard Disk boot sector
Boot other device	Enabled	protection. If this function is
Swap Floppy Drive	Disabled	enabled and someone attempt to
Boot Up Floppy Seek	Disabled	write data into this area, BIOS
Boot Up NumLock Status	Off	will show a warning message on
Gate A20 Option	Fast	screen and alarm beep
Typematic Rate Setting	Disabled	
Typematic Rate (Chars/Sec)	6	
Typematic Delay (Msec)	250	
Security Option	Setup	
OS Select For DRAM > 64MB	Non-OS2	
Video BIOS Shadow	Enabled	
C8000-CBFFF shadow	Disabled	
CC000-CFFFF shadow	Disabled	
D0000-D3FFF shadow	Disabled	
D4000-D7FFF shadow	Disabled	
D8000-DBFFF shadow	Disabled	
DC000-DFFFF shadow	Disabled	
↑↓←→Move    Enter: Select    +/-/PU/PD: Value    F10:Save    ESC: Exit    F1:General Help F5:Previous Values    F6:Fail-safe defaults    F7:Optimized Defaults		

## **Virus Warning**

Allows you to choose the VIRUS Warning feature for IDE Hard Disk boot sector protection. If this function is enabled and someone attempt to write data into this area, BIOS will show a warning message on screen and alarm beep.

Enabled	Activates automatically when the system boots up causing a warning message to appear when anything attempts to access the boot sector or hard disk partition table.
Disabled	No warning message will appear when anything attempts to access the boot sector or hard disk partition table.

## **CPU Internal Cache/External Cache**

These two categories speed up memory access. However, it depends on CPU/chipset design.

Enabled	Enable cache
Disabled	Disable cache

## **CPU L2 Cache ECC Checking**

This item allows you to enable/disable CPU L2 Cache ECC checking.

The choice: Enabled, Disabled.

## **Quick Power On Self Test**

This category speeds up Power On Self Test (POST) after you power up the computer. If it is set to Enable, BIOS will shorten or skip some check items during POST.the default value is Enabled.

Enabled	Enable quick POST
Disabled	Normal POST

## **First/Second/Third/Other Boot Device**

The BIOS attempts to load the operating system from the devices in the sequence selected in these items.

The Choice: Floppy, LS120, HDD, SCSI, CDROM, Disabled.the default value is LS120.

## **Swap Floppy Drive**

If the system has two floppy drives, you can swap the logical drive name assignments.

The choice: Enabled/Disabled.

## **Boot Up Floppy Seek**

Seeks disk drives during boot up. Disabling speeds boot up.

The choice: Enabled/Disabled.

### **Boot Up NumLock Status**

Select power on state for NumLock.

The choice: Enabled/Disabled.

### **Gate A20 Option**

Select if chipset or keyboard controller should control GateA20.

Normal	A pin in the keyboard controller controls GateA20
Fast	Lets chipset control GateA20

### **Typematic Rate Setting**

Key strokes repeat at a rate determined by the keyboard controller. When enabled, the typematic rate and typematic delay can be selected.

The choice: Enabled/Disabled.

### **Typematic Rate (Chars/Sec)**

Sets the number of times a second to repeat a key stroke when you hold the key down.

The choice: 6, 8, 10, 12, 15, 20, 24, 30.

### **Typematic Delay (Msec)**

Sets the delay time after the key is held down before it begins to repeat the keystroke. The choice: 250, 500, 750, 1000.

### **Security Option**

Select whether the password is required every time the system boots or only when you enter setup.

System	The system will not boot and access to Setup will be denied if the correct password is not entered at the prompt.
Setup	The system will boot, but access to Setup will be denied if the correct password is not entered at the prompt.

Note: To disable security, select PASSWORD SETTING at Main Menu and then you will be asked to enter password. Do not type anything and just press <Enter>, it will disable security. Once the security is disabled, the system will boot and you can enter Setup freely.

### **OS Select For DRAM > 64MB**

Select the operating system that is running with greater than 64MB of RAM on the system. The choice: Non-OS2, OS2.

## **Video BIOS Shadow**

Enabled copies Video BIOS to Shadow Ram improves performance.

This option allows video BIOS to be copied into RAM.

Video Shadowing will increase the video performance of your system.

The default is Enabled.

**Enabled:** Video shadow is enabled.

**Disabled:** Video shadow is disabled.

**C8000 - CBFFF Shadow: CC000 - CFFFF Shadow:**

**D0000 - D3FFF Shadow: D4000 - D7FFF Shadow:**

**D8000 - DBFFF Shadow: DC000 - DFFFF Shadow:**

These categories determine whether ROMs from option cards will be copied into RAM. This will be in 16K byte or 32K byte units, and the size will depend on chipset of the option card.

**Enabled:** Optional shadow is enabled.

### 3.4 Advanced Chipset Features/Integrated Peripherals

CMOS Setup Utility – Copyright © 1984 – 2000 Award Software

#### Advanced Chipset Features

Bank 0/1 DRAM Timing	SDRAM 10ns	Item Help
Bank 2/3 DRAM Timing	SDRAM 10ns	
Bank 4/5 DRAM Timing	SDRAM 10ns	Menu Level ➤
SDRAM Cycle Length	3	
DRAM Clock	HCLK-33M	
Memory Hole	Disabled	
P2C/C2P Concurrency	Enabled	
Fast R-W Turn Around	Disabled	
System BIOS Cacheable	Disabled	
Video RAM Cacheable	Disabled	
AGP Aperture Size (MB)	64M	
AGP 4X Mode	Enabled	
AGP Driving Control	Auto	
AGP Driving Value	DA	
Onchip USB	Enabled	
USB Keyboard Support	Disabled	
Onchip Sound	Auto	
Onchip Modem	Auto	
CPU to PCI Write Buffer	Enabled	
PCI Dynamic Bursting	Enabled	
PCI Master 0 WS Write	Enabled	
PCI Delay Transaction	Disabled	
PCI #2 Access #1 Retry	Enabled	
AGP Master 1 WS Write	Disabled	
AGP Master 1 WS Read	Disabled	
Memory Parity /ECC Check	Disabled	
↑↓←→Move Enter: Select +/-/PU/PD:Value F10:Save ESC: F1:General Help F5:Previous Values F6:Fail-safe defaults F7:Optimized Defaults		



### **Bank 0/1 DRAM Timing**

This value in this field is set by the system board manufacturer, depending on whether the board has paged DRAMs or EDO (extended data output) DRAMs.

This item allows you to select SDRAM 10 ns,8 ns,Normal,Medium,Fast,Turbo. The default is SDRAM 10 ns.

### **Bank 2/3 DRAM Timing**

This item allows you to select SDRAM 10 ns,8 ns,Normal,Medium,Fast,Turbo. The default is SDRAM 10 ns.

### **Bank 4/5 DRAM Timing**

This item allows you to select SDRAM 10 ns,8 ns,Normal,Medium,Fast,Turbo. The default is SDRAM 10 ns.

### **SDRAM Cycle Length**

This item allows you to select 3,2. The default setup is 3.

This setting defines the CAS timing parameter of the SDRAM in terms of clocks. The default is 3.

2: Provides faster memory performance.

3: Provides better memory compatibility.

### **DRAM Clock**

This item allows you to select Host CLK,HCLK-33M, 66MHz. The default setup is HCLK-33M.

### **Memory Hole**

Some special add-on cards require a 1MB address space between 15 and 16MB. The documentation for this type of card should prompt you if it need this. The default setting is Disabled. You can reserve this memory area for the use of ISA adaptor ROMs. The default is Disabled.

**Enabled:** This field enables the main memory (15~16MB) to remap to ISA BUS.

**Disabled:** Normal Setting.

**Note:** *If this feature is enabled you will not be able to cache this memory segment.*

### **P2C/C2P Concurrency**

This item allows you to select Disabled,Enabled.the default setup is Enabled.

### **Fast R-W Turn Around**

This item allows you to select Disabled, Enabled. the default setup is Disabled.

### **System BIOS Cacheable**

This allows you to copy your BIOS code from slow ROM to fast RAM. The default is Disabled.

**Enabled:** The option will improve system performance. However, if any program writes to this memory area, a system error may result.

**Disabled:** System BIOS non-cacheable.

This item allows you to select Enabled, Disabled. The default is Disabled.

### **Video BIOS Cacheable**

This option copies the video ROM BIOS to fast RAM (C0000h to C7FFFh). The default is Enabled.

**Enabled:** Enables the Video BIOS Cacheable to speed up the VGA Performance.

**Disabled:** Will not use the Video BIOS Cacheable function.

### **Video RAM Cacheable**

This option allows the CPU to cache read/writes of the video RAM. The default is Enabled.

**Enabled:** This option allows for faster video access.

**Disabled:** Reduced video performance.

### **AGP Aperture Size (MB)**

This item sets the maximum amount of system memory that an AGP card will use to store 3D texture mapping data. The larger aperture makes the better performance of the 3D function. The settings range from 4MB to 128MB. The default setting is "64MB".

### **AGP-4X Mode**

This item allows you to select Enabled, Disabled. The default is Enabled.

Chipset AGP Mode support. Options: x1 , x2 and x4.

### **AGP Driving Control**

This item allows you to adjust the AGP driving force. Choose *Manual* to key in a AGP Driving Value in the next selection. This field is recommended to set in Auto for avoiding any error in your system. The Choice: Auto, Manual.

## **AGP Driving Value**

This item allows you to adjust the AGP driving force.

The Choice: Min=0000~ Max=00FF.

## **Onchip USB**

Select Enabled if your system contains a Universal Serial Bus (USB) controller and you have a USB peripheral.

This item allows you to select Enabled, Disabled. The default is Enabled.

## **USB Keyboard Support**

This controls the activation status of an optional USB keyboard that may be attached. The default is disabled.

**Enabled:** Enable USB keyboard support.

**Disabled:** Disable USB keyboard support.

If you have USB keyboard, you must be enable this item. The default is Disabled.

## **Onchip Sound**

Turn on/off onchip sound device. the default value is Auto.

This item allows you to control the onboard AC 97 audio.

## **Onchip Modem**

Turn on/off onchip software modem device, the default value is Auto.

This item allows you to control the onboard MC 97 Modem.

The Choice: Auto, Disabled.

## **CPU to PCI Write Buffer**

When enabled, up to four D words of data can be written to the PCI bus without interrupting the CPU. When disabled, a write buffer is not used and the CPU read cycle will not be completed until the PCI bus signals

that it is ready to receive the data.

The Choice: Enabled, Disabled.

## **PCI Dynamic Bursting**

When Enabled, data transfers on the PCI bus, where possible, make use of the high-performance PCI burst protocol, in which greater amounts of data are transferred at a single command.

The Choice: Enabled, Disabled.

**PCI Master 0 WS Write**

When Enabled, writes to the PCI bus are command with zero wait states.

This item allows you to select Enabled, Disabled. The default is Enabled.

**PCI Delay Transaction**

The chipset has an embedded 32-bit posted write buffer to support delay transactions cycles. Select Enabled to support compliance with PCI specification

This item allows you to select Enabled, Disabled. The default is Disabled.

**PCI #2 Access #1 Retry**

This item allows you enabled/disable the PCI #2 Access #1 Retry.

The Choice: Enabled, Disabled. The default is Enabled.

**AGP Master 1 WS Write**

This item allows you to select Enabled, Disabled. The default is Disabled.

**AGP Master 1 WS Read**

This item allows you to select Enabled, Disabled. The default is Disabled.

**Memory Parity /ECC Check**

This item allows you to select Enabled, Disabled. The default is Disabled. Enabled adds a parity check to the boot-up memory tests,select Enabled only If the system Dram contains parity.

## Integrated Peripherals

CMOS Setup Utility – Copyright © 1984 – 2000 Award Software  
 Integrated Peripherals

OnChip IDE Channel 0	Ebabled	Item Help
OnChip IDE Channel 1	Ebabled	
IDE Prefetch Mode	Ebabled	Menu Level ➤
Primary Master PIO	Auto	
Primary Salve PIO	Auto	
Secondary Master PIO	Auto	
Primary Master UDMA	Auto	
Primary Salve UDMA	Auto	
Secondary Master UDMA	Auto	
Secondary Salve UDMA	Auto	
Init Display First	PCI Slot	
IDE HDD Block Mode	Enabled	
OnBoard FDD Controller	Enabled	
Onboard Serial Port 1	Auto	
Onboard Serial Port 2	Auto	
UART 2 Mode	Standard	
IR Function Duplex	Half	
TX.RX inverting enable	No. Yes	
Onboard Parallel Port	378/IRQ7	
Onboard Parallel Mode	Normal	
ECP Mode use DMA	3	
Parallel Port EPP Type	EPP 1.9	
Onboard Legacy Audio	Enabled	
Sound Blaster	Enabled	
SB I/O Base address	220H	
SB IRQ Select	IRQ5	
SB DMA Select	DMA1	
MPU-401	Enabled	
MPU-401 I/O Address	300-333H	
Game Port(200-207H)	Enabled	
↑↓←→ Move    Enter: Select    +/-/PU/PD: Value F10:Save    ESC: Exit F1:General Help F5:Previous Values    F6:Fail-safe defaults    F7:Optimized Defaults		

### **OnChip IDE Channel 0**

The chipset contains a PCI IDE interface with support for two IDE channels. Select Enabled to activate the primary IDE interface. Select Disabled to deactivate this interface

The choice: Enabled, Disabled.

### **OnChip IDE Channel 1**

The chipset contains a PCI IDE interface with support for two IDE channels. Select Enabled to activate the secondary IDE interface. Select Disabled to deactivate this interface

The choice: Enabled, Disabled.

### **IDE Prefetch Mode**

This item allows you to select Enabled, Disabled. The default is Enabled.

Enable prefetching for IDE drive interfaces that support its

faster drive accesses. If you are getting disk drive errors, change the setting to omit the drive interface where the errors occur. Depending on the configuration of your IDE subsystem, this field may not appear, and it does not appear when the Internal PCI/IDE field, above, is Disabled.

### **Primary/Secondary Master/Slave PIO**

The four IDE PIO (Programmed Input/Output) fields let you set a PIO mode (0-4) for each of the four IDE devices that the onboard IDE interface supports. Modes 0 through 4 provide successively increased performance. In Auto mode, the system automatically determines the best mode for each device.

The choice: Auto, Mode 0, Mode 1, Mode 2, Mode 3, Mode 4.

### **Primary/Secondary Master/Slave UDMA**

Ultra DMA/33 implementation is possible only if your IDE hard drive supports it and the operating environment includes a DMA driver (Windows 95 OSR2 or a third-party IDE bus master driver). If your hard drive and your system software both support Ultra DMA/33, select Auto to enable BIOS support.

The Choice: Auto, Disabled.

### **Init Display First**

This item allows you to decide to active whether PCI Slot or Onboard first

The choice: PCI Slot, Onboard. If two video cards are used (1 AGP and 1 PCI) this specifies

which one will be the primary display adapter. The default is PCI Slot.

### **IDE HDD Block Mode**

Block mode is also called block transfer, multiple commands, or multiple sector read/write. If your IDE hard drive supports block mode (most new drives do), select Enabled for automatic detection of the optimal number of block read/writes per sector the drive can support.

The choice: Enabled, Disabled, the default value is Enabled.

### **Onboard FDD Controller**

This item allows you to select Enabled, Disabled. The default is Enabled.

This controls the state of the onboard floppy controller. The default value is Enabled.

**Enabled:** Enable the Onboard Winbond Chips's floppy drive interface controller.

**Disabled:** Disable the Onboard Winbond Chip's floppy drive interface controller.

### **Uart 2 Mode**

This item allows you to determine which Infra Red (IR) function of onboard I/O chip.

The Choice: Standard, ASKIR, HPSIR.

### **IR Function Duplex**

This item allows you to select the IR half/full duplex function.

The choice: Half, Full.

### **TX,RX inverting enable**

This item allow you to enable the TX, RX inverting which depends on

H/W requirement. This field is not recommended to change its default setting

for avoiding any error in your systemThe choice: No, No/ No, Yes(Default)/ Yes, No/ Yes, Yes.

### **Onboard Parallel port:**

This field allows the user to configure the LPT port.

The default is 378H / IRQ7.

378H: Enable Onboard LPT port and address is 378H and IRQ7.

278H: Enable Onboard LPT port and address is 278H and IRQ5.

3BCH: Enable Onboard LPT port and address is 3BCH and IRQ7.

Disabled: Disable Onboard Winbond Chip's LPT port.

## **Parallel Port Mode**

This field allows the user to select the parallel port mode.

The default is Normal.

**Normal:** Standard mode. IBM PC/AT Compatible bidirectional parallel port.

**EPP:** Enhanced Parallel Port mode.

**ECP:** Extended Capabilities Port mode.

**EPP+ECP:** ECP Mode & EPP Mode.

**Onboard Legacy Audio:** Legacy Audio enabled/disabled.

**Sound Blaster:** Sound Blaster compatible device enabled/disabled.the default Value is Enabled.

**SB I/O Base Address:** Sound Blaster I/O resource selection.

**SB IRQ Select:** Legacy audio device IRQ selection.

**SB DMA Select:** Sound Blaster DMA channel selection.

**MPU-401:** MPU-401 function enabled/disabled.the default value is Enabled.

**MPU-401 I/O Address:** Built-in MPU-401 compatible MIDI I/O port selection:

300-303H

310-313H

320-323H

330-333H (default)

**Game Port (200-207H):** Built-in joystick port support disabled/enabled(default)



## 3.5 Power Management Setup

The Power Management Setup allows you to configure your system to most effectively save energy while operating in a manner consistent with your own style of computer use.

CMOS Setup Utility – Copyright © 1984 – 2000 Award Software  
Power Management Setup

ACPI function	Enabled	Item Help
Power Management	Press Enter	
ACPI Suspend Type	S1(POS)	Menu Level ➤
PM Control by APM	Yes	
Video off Option	Suspend>off	
Video off Method	V/H SYNC+Blank	
MODEM Use IRQ	3	
Soft-off by PWRBTN	Instant-off	
State After Power Failure	off	
Wake Up Events	Press Enter	
↑↓←→Move    Enter: Select    +/-/PU/PD: Value    F10:Save    ESC: Exit    F1:General Help F5:Previous Values    F6:Fail-safe defaults    F7:Optimized Defaults		

### ACPI Function

This item allows you to enable/disable the Advanced Configuration and Power Management (ACPI).

**Enabled:** Support ACPI function for new O.S

**Disabled:** No Support ACPI function.

You can only change the content of Doze Mode, Standby Mode, and Suspend Mode when the Power Management is set to 'User Define'.

The choice: Enabled, Disabled.

### Power Management

This category allows you to select the type (or degree) of power saving and is directly related to the following modes: Press Enter

1. HDD Power Down
2. Doze Mode
3. Suspend Mode

There are four selections for Power Management, three of which have fixed mode settings.

Disable (default)	No power management. Disables all four modes
Min. Power Saving	Minimum power management. Doze Mode = 1 hr. Standby Mode = 1 hr., Suspend Mode = 1 hr., and HDD Power Down = 15 min.
Max. Power Saving	Maximum power management -- <b>ONLY AVAILABLE FOR SL CPU's.</b> Doze Mode = 1 min., Standby Mode = 1 min., Suspend Mode = 1 min., and HDD Power Down = 1 min.
User Defined	Allows you to set each mode individually. When not disabled, each of the ranges are from 1 min. to 1 hr. except for HDD Power Down which ranges from 1 min. to 15 min. and disable.

### ACPI Suspend Type

This item allows you to select S1(POS) and S3(STR),The default value is S1(POS).

### PM Control by APM

This option shows whether or not you want the Power Management to be controlled the Advanced Power Management (APM). The default is Yes.

**Yes:** APM controls your PM. **No:** APM does not control your PM

### Video off Option

This item allows you to select Suspend Off and On The default value is Suspend Off..

### Video Off Method

This determines the manner in which the monitor is blanked.

V/H SYNC+Blank	This selection will cause the system to turn off the vertical and horizontal synchronization ports and write blanks to the video buffer.
Blank Screen	This option only writes blanks to the video buffer.
DPMS	Initial display power management signaling.

### MODEM Use IRQ

This determines the IRQ in which the MODEM can use. The choice: 3, 4, 5, 7, 9, 10, 11, NA.

## Soft-Off by PWRBTN

Pressing the power button for more than 4 seconds forces the system to enter the Soft-Off state when the system has “hung.”

The choice: Delay 4 Sec, Instant-Off.,the default value is Instant-off

## State After Power Failure

This field lets you determine the state that your PC returns to after a power Failure,If set to off,the pc will not boot after a power failure,if set to on,the PC Will restart after a power failure

**Wake Up Events** Press Enter

**VGA:** Off **LPT & COM:** LPT/COM **HDD&FDD:**On **PCI Master:** Off

**Modem Ring Resume:** When set to *Enabled*, any event occurring to the Modem Ring will awaken a system which has been powered down.

**RTC Alarm Resume:** When set to *Enable rtc alarm resume*, you could set the date (of month) and timer (hh:mm:ss), any event occurring at will awaken a system which has been powered down.

**Primary INTR:** When set to *On* (default), any event occurring at will awaken a system which has been powered down.

## Resume By Alarm (For ATX POWER ONLY)

This item allows you to select Disabled ,Enabled.

Which allows the user setting date(Day/Hour/Minute)

in advance for turning on the system with a range in 30 days.

The system will be awoken on the date according to the user' setup.

**IRQs Activity Monitoring:** Press Enter.

- |                       |          |
|-----------------------|----------|
| ● IRQ3 (COM2)         | Enabled  |
| ● IRQ4 (COM1)         | Enabled  |
| ● IRQ5 (LPT2)         | Enabled  |
| ● IRQ6 (Floppy Disk)  | Enabled  |
| ● IRQ7 (LPT1)         | Enabled  |
| ● IRQ8 (RTC Alarm)    | Disabled |
| ● IRQ9 (IRQ2 Redir)   | Disabled |
| ● IRQ10 (Reserved)    | Disabled |
| ● IRQ11 (Reserved)    | Disabled |
| ● IRQ12 (Reserved)    | Enabled  |
| ● IRQ13 (Coprocessor) | Enabled  |
| ● IRQ14 (Hard Disk)   | Enabled  |
| ● IRQ15 (Reserved)    | Disabled |

### 3.6 PnP/PCI Configuration Setup

This section describes configuring the PCI bus system. PCI, or personal Computer Interconnect, is a system which allows I/O devices to operate at speeds nearing the speed the CPU itself uses when communicating with its own special components. This section covers some very technical items and it is strongly recommended that only experienced users should make any changes to the default settings.

CMOS Setup Utility – Copyright © 1984-2000 Award Software  
PnP/PCI Configurations

		Item Help
PNP OS Installed	No	Menu Level ➤ Default is Disabled. Select
Reset Configuration Data	Disabled	Enabled to reset Extended System Configuration
Resources Controlled By	AUTO(ESCD)	Data(ESCD) when you exit Setup
x IRQ Resources	Press Enter	if you have installed a new add-on
x DMA Resources	Press Enter	and the system reconfiguration
PCI/VGA Palette Snoop	Disabled	has caused such a serious conflict
Assign IRQ For VGA	Enabled	that the OS cannot boot
Assign IRQ For USB	Enabled	
↑↓←→Move Enter: Select +/-/PU/PD: Value F10:Save F5:Previous Values F6:Fail-safe defaults F7:Optimized Defaults		ESC: Exit F1:General Help

#### PNP OS Installed

Select Yes if you are using a plug and play capable operating system ,Select No if You need the BIOS to Configure non-boot device.

#### Reset Configuration Data

Normally, you leave this field Disabled. Select Enabled to reset Extended System Configuration Data (ESCD) when you exit Setup if you have installed a new add-on and the system reconfiguration has caused such a serious conflict that the operating system can not boot. The choice: Enabled, Disabled .

#### Resource controlled by

The Award Plug and Play BIOS has the capacity to automatically configure all of the boot and Plug and Play compatible devices. However, this capability means absolutely nothing unless you are using a Plug and Play operating system such as Windows®95. If you set this field to “manual” choose specific resources by going into each of the sub menu that follows this field (a sub menu is preceded by a “➤”).

#### PCI/VGA Palette Snoop

Leave this field at *Disabled*. Choices are Enabled,

### 3.7 PC Health Status

CMOS Setup Utility – Copyright © 1984 – 2000 Award Software  
PC Health Status Setup

Current CPU Temp.	24°C/75°F	Item Help
Current System Temp	16°C/60°F	
Current CPU-Fan Speed	5002 RPM	Menu Level ➤
Current SYS-Fan Speed	0 RPM	
Vcore	2.01V	
2.5V	2.51V	
3.3V	3.3V	
5V	5V	
12V	12V	
↑↓←→Move Enter: Select +/-/PU/PD: Value F10:Save ESC: Exit F1:General Help F5:Previous Values F6:Fail-safe defaults F7:Optimized Defaults		

#### Current CPU Temperature

This is the current temperature of the CPU.

#### Current System Temp

This is the Current temperature of the system.

#### Current CPU FAN Speed

The current CPU fan speed in RPMs.

#### Current SYS FAN Speed

The current SYS fan speed in RPMs.

**CPU(V):** The voltage level of the CPU(Vio/Vcore).

**+2.5V, +3.3V, +5V, +12V:** The voltage level of the switch power supply..

## 3.8 Frequency/Voltage Control

### CMOS Setup Utility – Copyright © 1984-2000 Award Software Frequency/Voltage Control

		Item Help
Auto Detect DIMM/PCI CLK	Enabled	-----
Spread Spectrum	Disabled	Menu Level    ➤
CPU Host /PCI Clock	Default	

↑↓←→ Move	Enter: Select	+/-/PU/PD: Value	F10:Save ESC: Exit	F1:General Help
F5:Previous Values	F6:Fail-safe defaults	F7:Optimized Defaults		

#### **Auto Detect DIMM/PCI CLK**

This item allows you to select Disabled,Enabled.the default setup is Enabled. When enabled the motherboard will automatically disable the clock source for a DIMM socket which does not have a module in it. Same applies for PCI slots.

#### **Spread Spectrum**

This item allows you to select Disabled,Enabled.the default setup is Disabled,

#### **CPU Host /PCI Clock**

Allows the external clock to be modified depending upon what FSB has been selected. Should not be used to clock proces-sor faster than it was designed for. The default is Default.

## Defaults Menu

Selecting “Defaults” from the main menu shows you two options which are described below

### Load Fail-Safe Defaults

When you press <Enter> on this item you get a confirmation dialog box with a message similar to:

Load Fail-Safe Defaults (Y/N) ?

Pressing ‘Y’ loads the BIOS default values for the most stable, minimal-performance system operations.

### Load Optimized Defaults

When you press <Enter> on this item you get a confirmation dialog box with a message similar to:

Load Optimized Defaults (Y/N) ?

Pressing ‘Y’ loads the default values that are factory settings for optimal performance system operations.

### 3.9 Supervisor/User Password Setting

You can set either supervisor or user password, or both of them. The differences between are:

**supervisor password** : can enter and change the options of the setup menus.

**user password** : just can only enter but do not have the right to change the options of the setup menus. When you select this function, the following message will appear at the center of the screen to assist you in creating a password.

#### ENTER PASSWORD:

Type the password, up to eight characters in length, and press <Enter>. The password typed now will clear any previously entered password from CMOS memory. You will be asked to confirm the password. Type the password again and press <Enter>. You may also press <Esc> to abort the selection and not enter a password.

To disable a password, just press <Enter> when you are prompted to enter the password. A message will confirm the password will be disabled. Once the password is disabled, the system will boot and you can enter Setup freely.

#### PASSWORD DISABLED.

When a password has been enabled, you will be prompted to enter it every time you try to enter Setup. This prevents an unauthorized person from changing any part of your system configuration.

Additionally, when a password is enabled, you can also require the BIOS to request a password every time your system is rebooted. This would prevent unauthorized use of your computer.

You determine when the password is required within the BIOS Features Setup Menu and its Security option (see Section 3). If the Security option is set to “System”, the password will be required both at boot and at entry to Setup. If set to “Setup”, prompting only occurs when trying to enter Setup.



## **Exit Selecting**

### **Save & Exit Setup**

Pressing <Enter> on this item asks for confirmation:

**Save to CMOS and EXIT (Y/N)?**  Y

Pressing “Y” stores the selections made in the menus in CMOS – a special section of memory that stays on after you turn your system off. The next time you boot your computer, the BIOS configures your system according to the Setup selections stored in CMOS. After saving the values the system is restarted again.

### **Exit Without Saving**

Pressing <Enter> on this item asks for confirmation:

**Quit without saving (Y/N)?**  Y

This allows you to exit Setup without storing in CMOS any change. The previous selections remain in effect. This exits the Setup utility and restarts your computer.

