

## FCC Compliance Statement:

<p><b>DECLARATION OF CONFORMITY</b> Per FCC Part 2 Section 2.107(a)</p> <p><b>FC</b></p> <p>Responsible Party Name: G.B.T. INC.</p> <p>Address: 18365 Valley Blvd., Suite#A LA Puente, CA 91744</p> <p>Phone/Fax No: (818) 854-9338 / (818) 854-9339</p> <p>hereby declares that the product</p> <p>Product Name: Mother Board</p> <p>Model Number: GA-6VX7B-4X</p> <p>Conforms to the following specifications:</p> <p>FCC Part 15, Subpart B, Section 15.107(a) and Section 15.109(a). Class B Digital Device.</p> <p><b>Supplementary Information:</b></p> <p>This device complies with part 15 of the FCC Rules. Operation is subject to the following two conditions: (1) This device may not cause harmful and (2) this device must accept any interference received, including that may cause undesired operation.</p> <p>Representative Person's Name: <u>ERIC LU</u></p> <p>Signature: <u>Eric Lu</u></p> <p>Date: <u>Sep. 13, 2000</u></p>
--

This equipment has been tested and found to comply with limits for a Class B digital device, pursuant to Part 15 of the FCC rules. These limits are designed to provide reasonable protection against harmful interference in residential installations. This equipment generates, uses, and can radiate radio frequency energy, and if not installed and used in accordance with the instructions, may cause harmful interference to radio communications. However, there is no guarantee that interference will not occur in a particular installation. If this equipment does cause interference to radio or television equipment reception, which can be

determined by turning the equipment off and on, the user is encouraged to try to correct the interference by one or more of the following measures:

- Reorient or relocate the receiving antenna
- Move the equipment away from the receiver
- Plug the equipment into an outlet on a circuit different from that to which the receiver is connected
- Consult the dealer or an experienced radio/television technician for additional suggestions

You are cautioned that any change or modifications to the equipment not expressly approve by the party responsible for compliance could void Your authority to operate such equipment.

This device complies with Part 15 of the FCC Rules. Operation is subjected to the following two conditions 1) this device may not cause harmful interference and 2) this device must accept any interference received, including interference that may cause undesired operation.

# Declaration of Conformity

We, Manufacturer/Importer  
(full address)

**G.B.T. Technology Trading GmbH**  
**Ausschlagler Weg 41, 1F, 20537 Hamburg, Germany**

declare that the product  
( description of the apparatus, system, installation to which it refers)

**Mother Board**  
GA-6VX7B-4X

is in conformity with  
(reference to the specification under which conformity is declared)  
in accordance with 89/336 EEC-EMC Directive

- |   |  |  |  |
|---|--|--|--|
| <input type="checkbox"/> EN 55011   | Limits and methods of measurement of radio disturbance characteristics of industrial, scientific and medical (ISM high frequency equipment                 | <input type="checkbox"/> EN 61000-3-2*<br><input checked="" type="checkbox"/> EN60555-2          | Disturbances in supply systems caused by household appliances and similar electrical equipment "Harmonics"   |
| <input type="checkbox"/> EN55013  | Limits and methods of measurement of radio disturbance characteristics of broadcast receivers and associated equipment                                     | <input type="checkbox"/> EN61000-3-3*<br><input checked="" type="checkbox"/> EN60555-3           | Disturbances in supply systems caused by household appliances and similar electrical equipment "Voltage fluctuations"                                  |
| <input type="checkbox"/> EN 55014   | Limits and methods of measurement of radio disturbance characteristics of household electrical appliances, portable tools and similar electrical apparatus | <input checked="" type="checkbox"/> EN 50081-1<br><input checked="" type="checkbox"/> EN 50082-1 | Generic emission standard Part 1: Residual, commercial and light industry<br>Generic immunity standard Part 1: Residual, commercial and light industry |
| <input type="checkbox"/> EN 55015   | Limits and methods of measurement of radio disturbance characteristics of fluorescent lamps and luminaries   | <input type="checkbox"/> EN 55081-2  | Generic emission standard Part 2: Industrial environment   |
| <input type="checkbox"/> EN 55020   | Immunity from radio interference of broadcast receivers and associated equipment   | <input type="checkbox"/> EN 55082-2  | Generic immunity standard Part 2: Industrial environment   |
| <input checked="" type="checkbox"/> EN 55022  | Limits and methods of measurement of radio disturbance characteristics of information technology equipment   | <input type="checkbox"/> ENV 55104   | Immunity requirements for household appliances tools and similar apparatus   |
| <input type="checkbox"/> DIN VDE 0855<br><input type="checkbox"/> part 10<br><input type="checkbox"/> part 12 | Cabled distribution systems; Equipment for receiving and/or distribution from sound and television signals   | <input type="checkbox"/> EN 50091- 2   | EMC requirements for uninterruptible power systems (UPS)   |

CE marking



(EC conformity marking)

**The manufacturer also declares the conformity of above mentioned product with the actual required safety standards in accordance with LVD 73/23 EEC**

- |                                   |   |                                     |   |
|-----------------------------------|---|-------------------------------------|---|
| <input type="checkbox"/> EN 60065 | Safety requirements for mains operated electronic and related apparatus for household and similar general use | <input type="checkbox"/> EN 60950   | Safety for information technology equipment including electrical business equipment |
| <input type="checkbox"/> EN 60335 | Safety of household and similar electrical appliances   | <input type="checkbox"/> EN 50091-1 | General and Safety requirements for uninterruptible power systems (UPS)             |

Manufacturer/Importer

Signature : Rex Lin  
Name : Rex Lin

(Stamp)

Date: Sep.13, 2000

**6VX7B-4X**  
**Socket 370 Processor Motherboard**

**USER'S MANUAL**

Socket 370 Processor Motherboard  
REV. 3.2 Second Edition  
R-32-02-010627  
12ME-6VX7B4X-3202



## How This Manual Is Organized

This manual is divided into the following sections:

<b>1) Revision History</b>	Manual revision information
<b>2) Item Checklist</b>	Product item list
<b>3) Features</b>	Product information & specification
<b>4) Hardware Setup</b>	Instructions on setting up the motherboard
<b>5) Performance &amp; Block Diagram</b>	Product performance & block diagram
<b>6) Suspend to RAM</b>	Instructions STR installation
<b>7) BIOS Setup</b>	Instructions on setting up the BIOS software
<b>8) Appendix</b>	General reference



## Table Of Content

Revision History	P.1
Item Checklist	P.2
Summary of Features	P.3
6VX7B-4X Motherboard Layout	P.5
Page Index for CPU Speed Setup/Connectors/Panel and Jumper Definition	P.6
Performance List	P.34
Block Diagram	P.35
Suspend to RAM Installation	P.36
Memory Installation	P.42
Page Index for BIOS Setup	P.43
Appendix	P.72

## Revision History

Revision	Revision Note	Date
3.2	Initial release of the 6VX7B-4X motherboard user's manual.	Sep.2000
3.2	Second release of the 6VX7B-4X motherboard user's manual.	Jun.2001

The author assumes no responsibility for any errors or omissions that may appear in this document nor does the author make a commitment to update the information contained herein. Third-party brands and names are the property of their respective owners.



---

## Item Checklist

- The 6VX7B-4X motherboard
- Cable for IDE / floppy device
- Diskettes or CD (TUCD) for motherboard driver & utility
- 6VX7B-4X user's manual

## Summary Of Features

Form Factor	<ul style="list-style-type: none"> <li>30.4 cm x 20.3 cm ATX Size form factor, 4 layers PCB.</li> </ul>
CPU	<ul style="list-style-type: none"> <li>Socket 370 processor           <ul style="list-style-type: none"> <li>Intel Pentium® III 100/133MHz FSB, FC-PGA</li> <li>Intel Celeron™ 66MHz FSB, FC-PGA</li> <li>VIA Cyrix® III 100/133MHz FSB, PPGA</li> </ul> </li> <li>2nd cache in CPU (Depend on CPU)</li> </ul>
Chipset	<ul style="list-style-type: none"> <li>VT82C694X (VIA Apollo Pro 133A)</li> <li>VT82C686B</li> </ul>
Clock Generator	<ul style="list-style-type: none"> <li>ICS 9248DF-39</li> <li>66/100/133 MHz system bus speeds (PCI 33MHz)</li> <li>75/83/112/124/140/150 MHz system bus speeds (PCI 44MHz) (reserved)</li> </ul>
Memory	<ul style="list-style-type: none"> <li>3 168-pin DIMM sockets.</li> <li>Supports PC-100 / PC-133 SDRAM and VCM SDRAM</li> <li>Supports up to 1.5GB(Max)</li> <li>Supports only 3.3V SDRAM DIMM</li> <li>Supports 72bit ECC type DRAM integrity mode.</li> </ul>
I/O Control	<ul style="list-style-type: none"> <li>VT82C686B</li> </ul>
Slots	<ul style="list-style-type: none"> <li>1 AGP Slot Supports 4X mode &amp; AGP 2.0 compliant</li> <li>5 PCI Slot Supports 33MHz &amp; PCI 2.2 compliant</li> <li>1 ISA Slot</li> <li>1 AMR(Audio Modem Riser)Slot</li> </ul>
On-Board IDE	<ul style="list-style-type: none"> <li>Supports PIO mode 3, 4 (UDMA33/ATA66) IDE &amp; ATAPI CD-ROM</li> <li>2 IDE bus master (DMA 33/ ATA 66/100) IDE ports for up to 4 ATAPI devices</li> </ul>
On-Board Peripherals	<ul style="list-style-type: none"> <li>1 floppy port supports 2 FDD with 360K, 720K, 1.2M, 1.44M and 2.88M bytes</li> <li>1 parallel ports supports SPP/EPP/ECP mode</li> <li>2 serial ports (COM A &amp; COM B)</li> <li>4 USB ports</li> <li>1 IrDA connector for IR</li> </ul>

To be continued...

---

Summary of Features

Hardware Monitor	<ul style="list-style-type: none"><li>• CPU / System fan revolution detect</li><li>• CPU / System temperature detect</li><li>• System voltage detect</li><li>• CPU overheat shutdown detect</li></ul>
PS/2 Connector	<ul style="list-style-type: none"><li>• PS/2 keyboard interface and PS/2 mouse interface</li></ul>
BIOS	<ul style="list-style-type: none"><li>• Licensed AMI BIOS, 2M bit flash ROM</li></ul>
On-Board Sound	<ul style="list-style-type: none"><li>• Build -in VIA sound (VIA VT82C686B)</li><li>• Creative CT5880 sound (Optional)</li></ul>
Additional Features	<ul style="list-style-type: none"><li>• Supports Wake-on-LAN (WOL)</li><li>• Supports Internal / External modem wake up</li><li>• Includes 3 fan power connectors</li><li>• Poly fuse for keyboard over-current protection</li><li>• Support STR (Suspend to RAM ) function</li><li>• Support USB KB/MS Wake up From S3-S5</li></ul>

# 6VX7B-4X Motherboard Layout

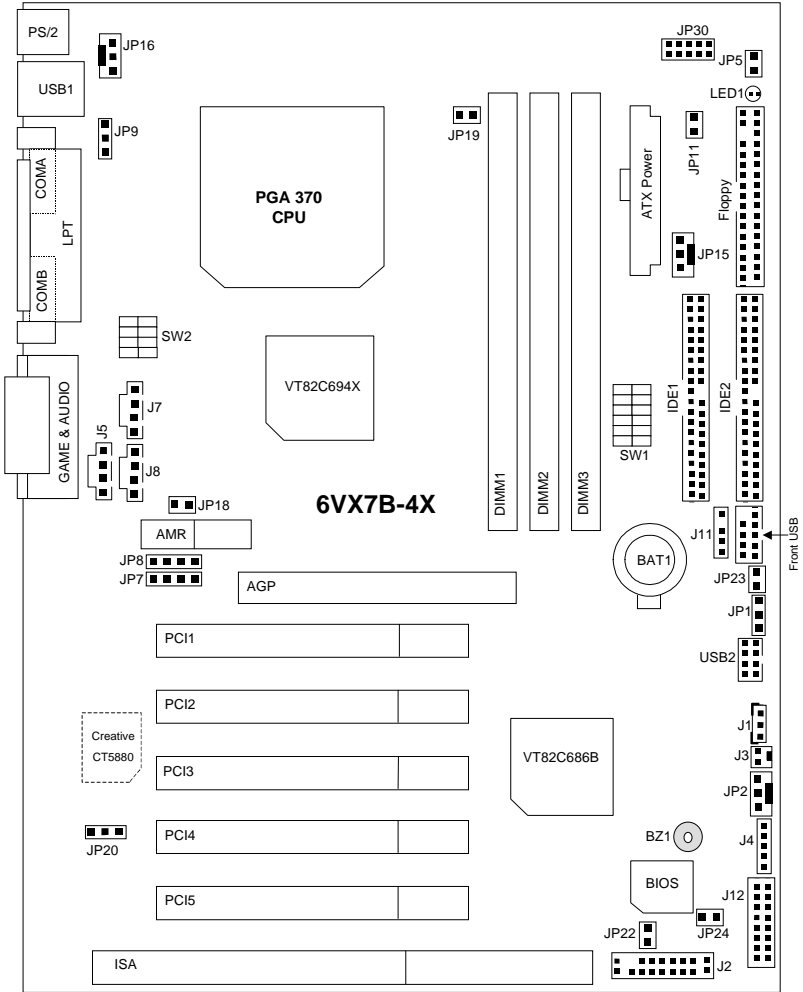

	Page
Page Index for CPU Speed Setup/Connectors/Panel and Jumper Definition	
CPU Speed Setup	P.7
Connectors	P.17
Game & Audio Port	P.17
COM A / COM B / LPT Port	P.17
USB1 Connector	P.18
PS/2 Keyboard & PS/2 Mouse Connector	P.18
JP16 (CPU Fan)	P.19
JP15 (Power Fan)	P.19
JP2 (System Fan)	P.20
ATX Power	P.20
USB 2 Connector	P.21
IR Connector	P.21
Floppy Port	P.22
IDE 1(Primary)/ IDE 2(Secondary) Port	P.22
J3 (Ring Power On)	P.23
J1 (Wake on LAN)	P.23
J7 (TEL)	P.24
J5 (AUX_IN)	P.24
J8 (CD Audio Line In)	P.25
JP5 (STR LED Connector) & LED 1 (DIMM LED)	P.25
Front USB Port (Optional)	P.26
J11 (SM BUS)	P.26
Panel and Jumper Definition	P.27
J2 (2x11 Pins Jumper)	P.27
JP1 (Clear CMOS Function)	P.28
JP18/JP7/JP8 (Onboard AC97& AMR Select)	P.28
JP11 (STR Enable)	P.29
JP20 (Onboard Sound Function Selection) [Optional]	P.29
JP24 (Normal/Recovery) [Optional]	P.30
JP19 (Cyrix CPU Turbo Function) [Optional]	P.30
JP9 (USB Device Wake up Selection)	P.31
JP23 (Case Open)	P.31
JP22 (BIOS Flash Write Protection)	P.32
JP30 (Over Voltage CPU Speed up) [Optional]	P.32
J12 (Front Panel Jumper) [Optional]	P.33
BAT1 (Battery)	P.33

## CPU Speed Setup

The system bus speed is selectable at 66,100,133MHz and Auto. The user can select the system bus speed (**SW1**) and change the DIP switch (**SW2**) selection to set up the CPU speed for 500MHz – 1GHz processor.

**SW1:**

**O: ON, X: OFF**

CPU	PCICLK	1	2	3	4	5	6
Auto	33.3	X	X	X	X	O	O
66	33.3	O	O	X	X	X	X
75	37.5	O	O	O	X	X	X
83	41.6	O	O	X	O	X	X
100	33.3	O	X	X	X	X	X
112	37.3	O	X	O	X	X	X
124	31	X	X	X	O	X	X
133	33.3	X	X	X	X	X	X
140	35	X	X	O	O	X	X
150	37.5	X	X	O	X	X	X

⚠ The CPU speed must match with the frequency **RATIO**. It will cause system hanging up if the frequency **RATIO** is higher than that of CPU.

**SW2:**

FREQ. RATIO	DIP SWITCH			
	1	2	3	4
X3	O	X	O	O
X3.5	X	X	O	O
X4	O	O	X	O
X4.5	X	O	X	O
X5	O	X	X	O
X5.5	X	X	X	O
X6	O	O	O	X
X6.5	X	O	O	X
X7	O	X	O	X
X7.5	X	X	O	X
X8	O	O	X	X
X8.5	O	X	O	O
X9	X	X	O	O
X9.5	X	O	O	O
X10	X	O	X	X
X10.5	O	O	X	O
X11	O	X	X	X
X11.5	X	O	X	O
X12	O	X	X	O
X13	X	X	X	O

X14	O	O	O	X
X15	X	O	O	X
X16	O	X	O	X

☛ For Auto Jumper setting:

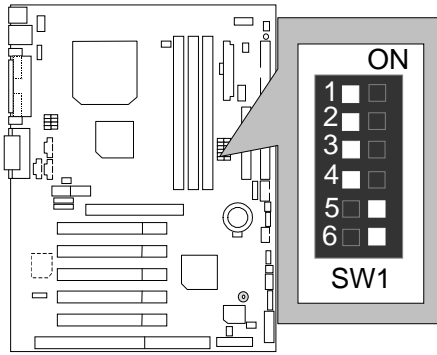

★Note:

1. If you use 66, 100, 133 MHz CPU, we recommend you to set up your system speed to "Auto" value.
2. We don't recommend you to set up your system speed to 75,83,112, 124, 140,150 MHz because these frequencies are not the standard specifications for CPU, Chipset and most of the peripherals. Whether your system can run under 75,83,112, 124, 140,150 MHz properly will depend on your hardware configurations: CPU, SDRAM, Cards, etc.

1. Celeron™ 533 / 66MHz FSB

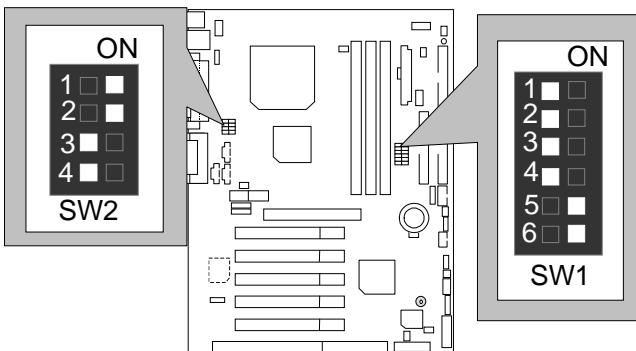

2. Celeron™ 566 / 66 MHz FSB

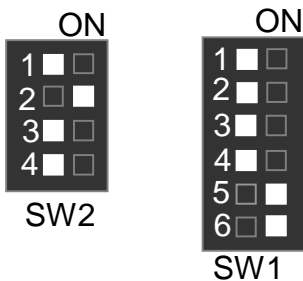

3. Celeron™ 600 / 66 MHz FSB

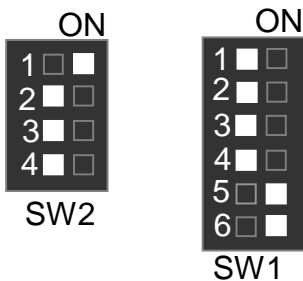

4. Celeron™ 633 / 66 MHz FSB

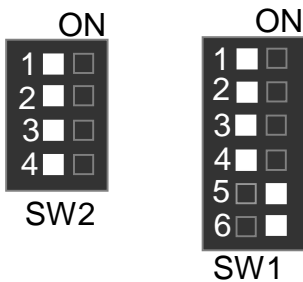



5. Celeron™ 667 / 66 MHz FSB

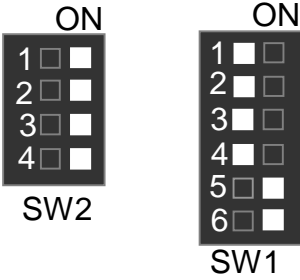

6. Celeron™ 700 / 66 MHz FSB

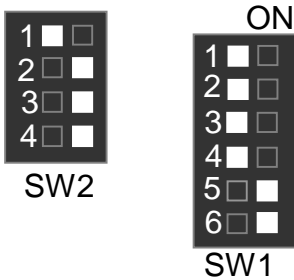

7. Cyrix® III 550 / 100 MHz FSB (Optional)

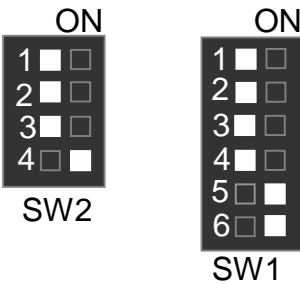

8. Cyrix® III 533 / 133 MHz FSB (Optional)

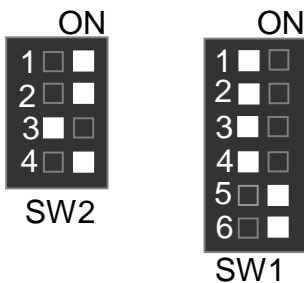

9. Cyrix® III 600 / 133 MHz FSB (Optional)

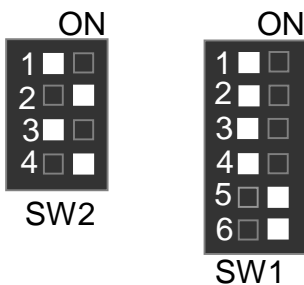

10. Pentium® !!! 500 / 100MHz FSB

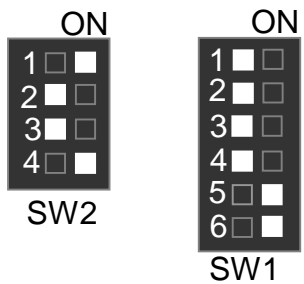

11. Pentium® !!! 550 / 100MHz FSB

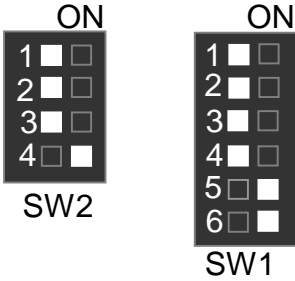

12. Pentium® !!! 600 / 100MHz FSB

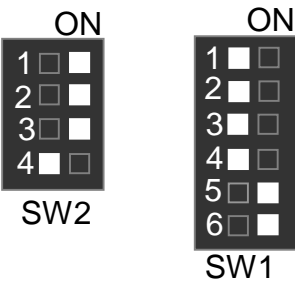

13. Pentium® !!! 650 / 100MHz FSB

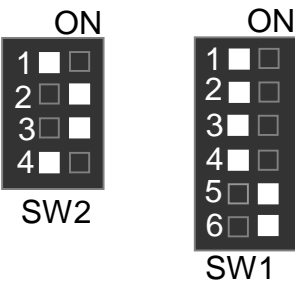

14. Pentium® !!! 700 / 100MHz FSB

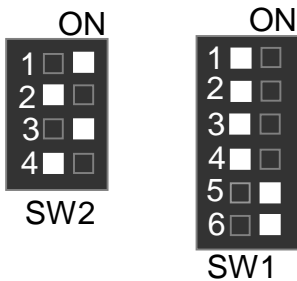

15. Pentium® !!! 750 / 100MHz FSB

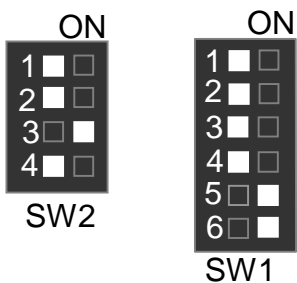

16. Pentium® !!! 800 / 100MHz FSB

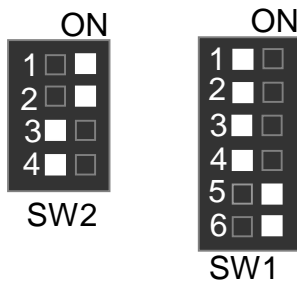

17. Pentium® !!!850 / 100MHz FSB

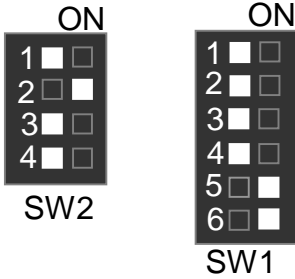

18. Pentium® !!!533 / 133MHz FSB

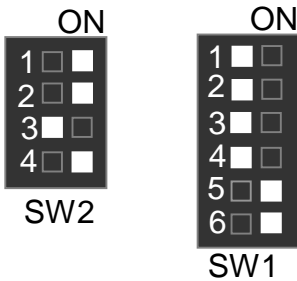

19. Pentium® !!!600 / 133MHz FSB

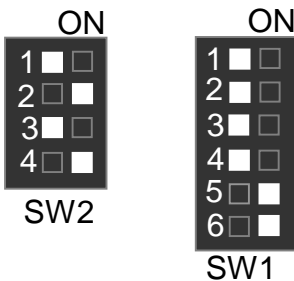

20. Pentium® !!!667 / 133MHz FSB

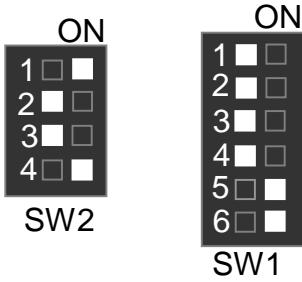

21. Pentium® !!!733 / 133MHz FSB

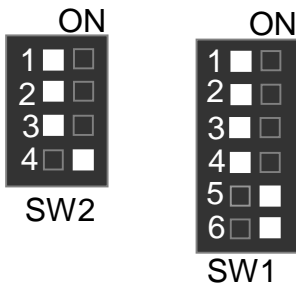

22. Pentium® !!!800 / 133MHz FSB

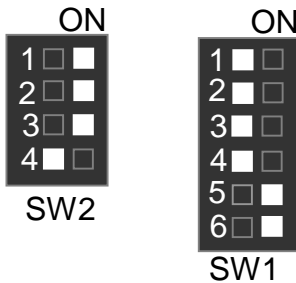

23. Pentium® !!!866 / 133MHz FSB

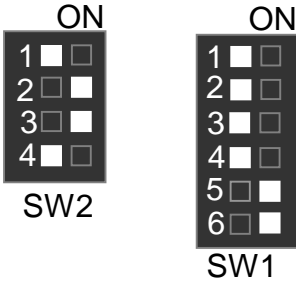

24. Pentium® !!!933 / 133MHz FSB

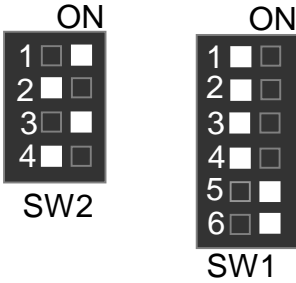

25. Pentium® !!!1GHz / 133MHz FSB

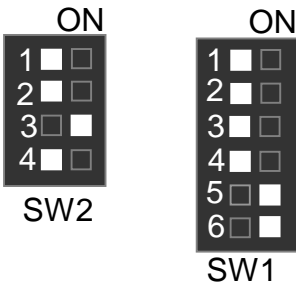

## Connectors

### Game & Audio Port

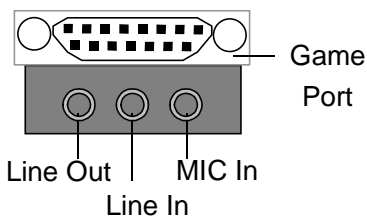
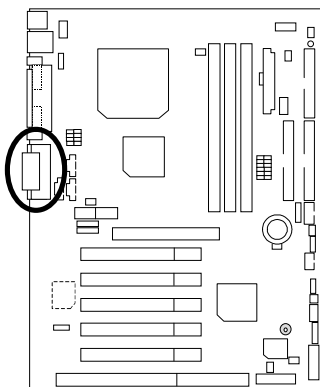

### COM A / COM B / LPT Port

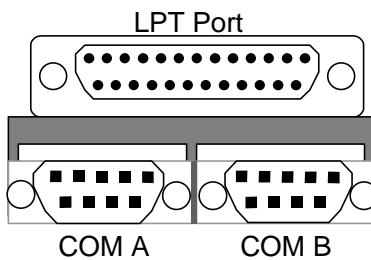
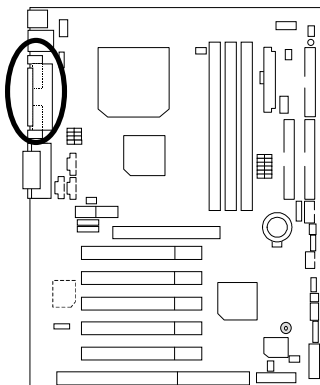



## USB 1 Connector

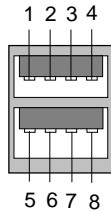
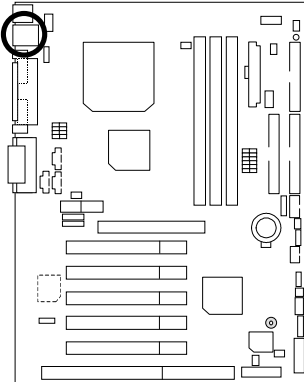

Pin No.	Definition
1	USB V0
2	USB D0-
3	USB D0+
4	GND
5	USB V1
6	USB D1-
7	USB D1+
8	GND

## PS/2 Keyboard & PS/2 Mouse Connector

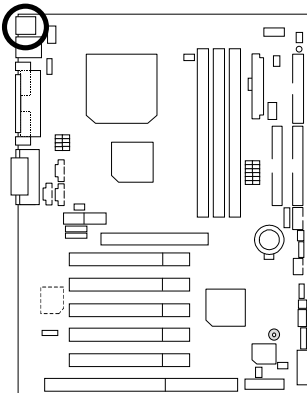

PS/2 Mouse

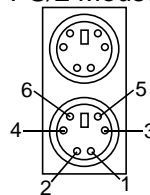

PS/2 Keyboard

PS/2 Mouse/ Keyboard	
Pin No.	Definition
1	Data
2	NC
3	GND
4	VCC(+5V)
5	Clock
6	NC

### JP16: CPU Fan

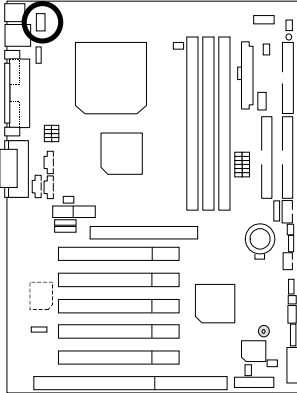

Pin No.	Definition
1	GND
2	+12V
3	SENSE

### JP15: Power Fan

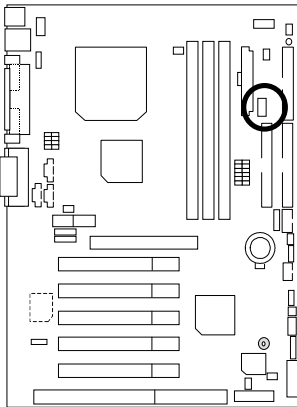

Pin No.	Definition
1	GND
2	+12V
3	NC

## JP2: System Fan

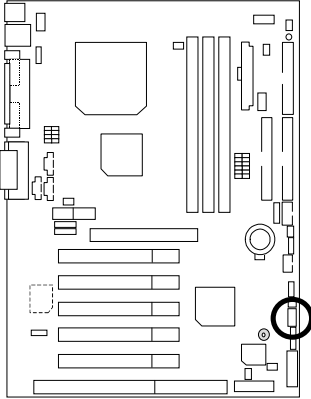

Pin No.	Definition
1	GND
2	+12V
3	SENSE

## ATX Power

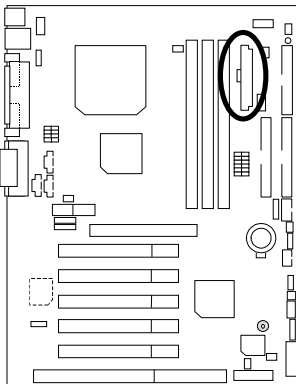

Pin No.	Definition
3,5,7,13,15-17	GND
1,2,11	3.3V
4,6,19,20	VCC
10	+12V
12	-12V
18	-5V
8	Power Good
9	5V SB stand by+5V
14	PS-ON(Soft On/Off)

## USB 2 Connector

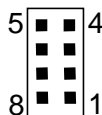
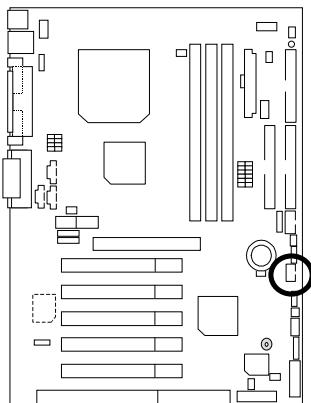

Pin No.	Definition
1	VCC
2	USB D0-
3	USB D0+
4	GND
5	VCC
6	USB D1-
7	USB D1+
8	GND

## IR Connector

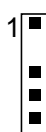
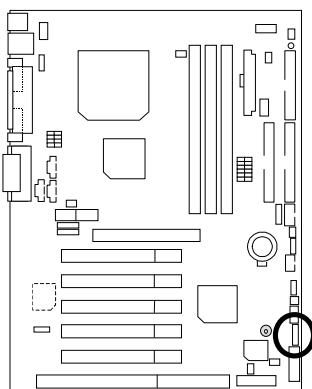

PIN No.	Definition
1	VCC(+5V)
2	NC
3	IR data input
4	GND
5	IR data output

## Floppy Port

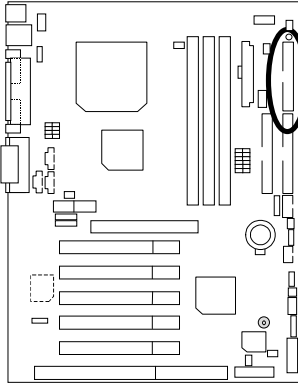

Red Line



## IDE1 (Primary), IDE2(Secondary) Port

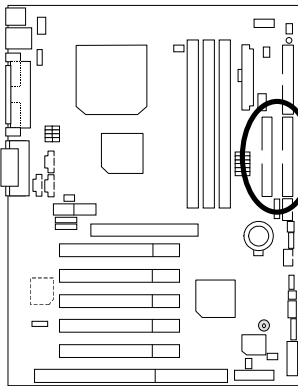

Red Line

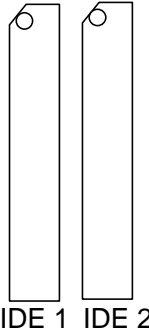

### J3: Ring Power On (Internal Modem Card Wake Up)

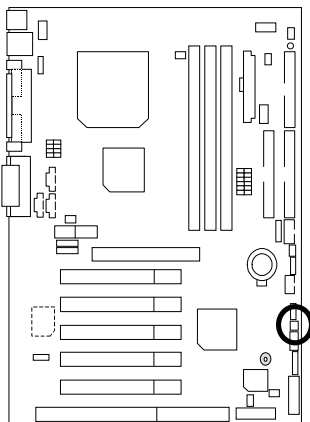

Pin No.	Definition
1	Signal
2	GND

### J1: Wake On LAN

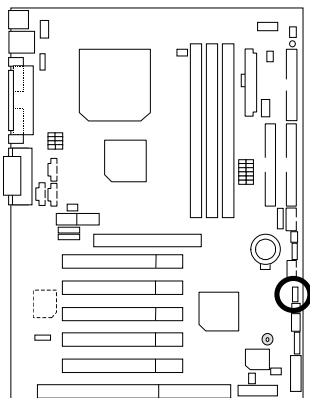

Pin No.	Definition
1	+5V SB
2	GND
3	Signal

J7: TEL: The connector is for Modem with internal voice connector

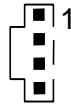
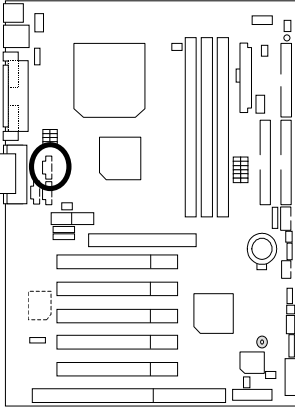

Pin No.	Definition
1	Signal-In
2	GND
3	GND
4	Signal-Out

J5: AUX\_IN

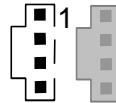
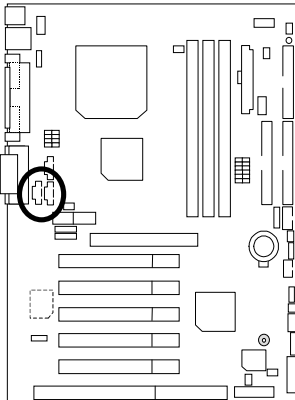

Pin No.	Definition
1	AUX-L
2	GND
3	GND
4	AUX-R

### J8: CD Audio Line In

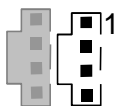
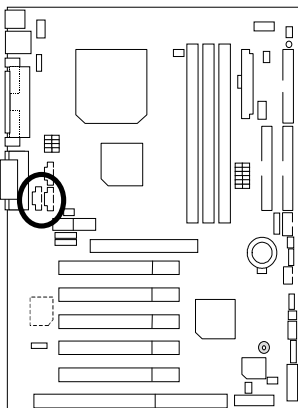

Pin No.	Definition
1	CD-L
2	GND
3	GND
4	CD-R

### JP5: STR LED Connector & LED1: DIMM LED

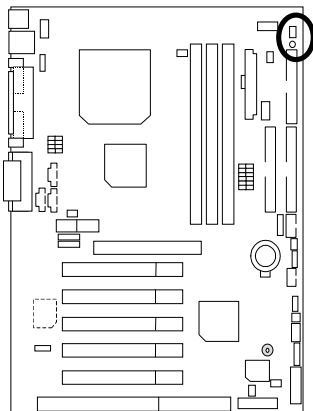

STR LED Connector External





## Front USB Port (Optional)

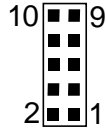
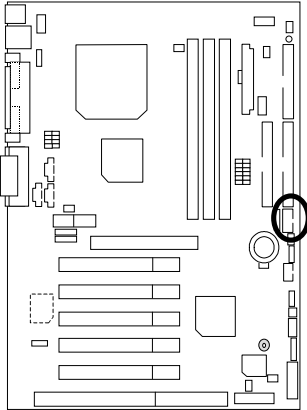

Pin No.	Definition
1,4,5,10	NC
2	+5V
3,7,9	GND
6	USBP0+
8	USBP0-

## J11: SM BUS

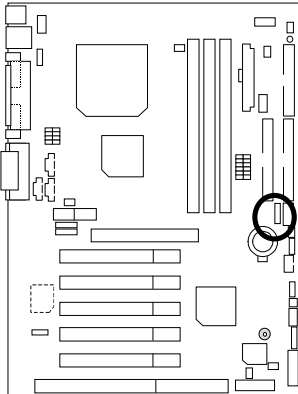

Pin No.	Definition
1	SMB CLK
2	NC
3	GND
4	SMB DATA
5	+5V

## Panel And Jumper Definition

J2: For 2x11 Pins Jumper

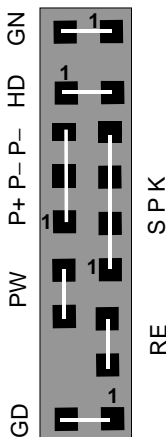
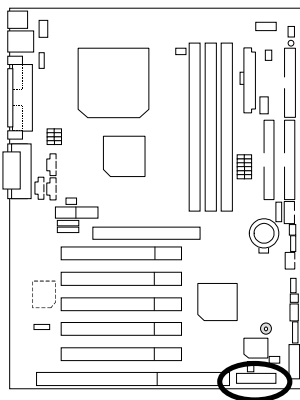

GN (Green Switch)	Open: Normal Operation Close: Entering Green Mode
GD (Green LED)	Pin 1: LED anode(+) Pin 2: LED cathode(-)
HD (IDE Hard Disk Active LED)	Pin 1: LED anode(+) Pin 2: LED cathode(-)
SPKR (Speaker Connector)	Pin 1: VCC(+) Pin 2- Pin 3: NC Pin 4: Data(-)
RE (Reset Switch)	Open: Normal Operation Close: Reset Hardware System
P+P-P-(Power LED)	Pin 1: LED anode(+) Pin 2: LED cathode(-) Pin 3: LED cathode(-)
PW (Soft Power Connector)	Open: Normal Operation Close: Power On/Off

JP1: Clear CMOS Function

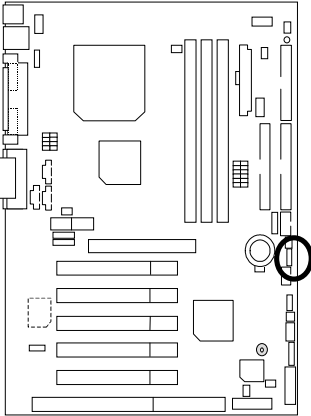

Pin No.	Definition
1-2 close	Normal (Default)
2-3 close	Clear CMOS

JP7/JP8/JP18: Onboard AC97 & AMR (Primary or Secondary) Select  
(AMR → Audio Modem Riser)

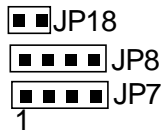
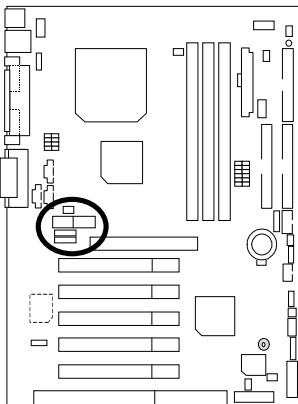

Jumper Function	JP7	JP8	JP18
Only AC97	1-2 Close	1-2 Close	Open
Only AMR (Primary)	3-4 Close	3-4 Close	Open
AC97+MR (Secondary) (Default)	1-2 Close	1-2 Close 3-4 Close	Close

### JP11: STR Enable

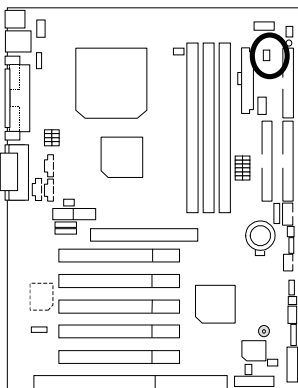

Pin No.	Definition
Open	STR Disabled (Default)
Close	STR Enabled

### JP20: Onboard Sound Function Selection (Optional)

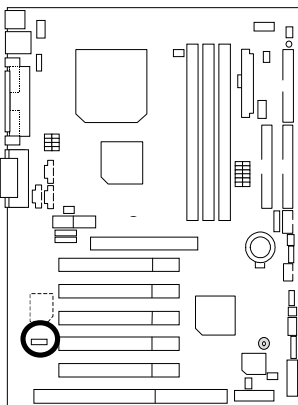

Pin No.	Definition
1-2 close	Enabled Onboard Sound (Default)
2-3 close	Disabled Onboard Sound

JP24: Normal/ Recovery mode (Optional)

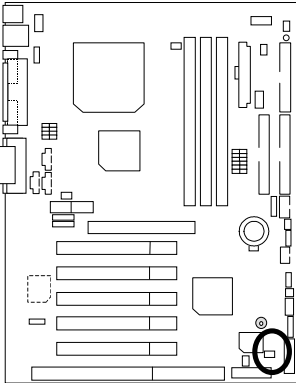

Pin No.	Definition
Open	Normal
Close	Recovery

JP19: Cyrix CPU Turbo Function (Optional)

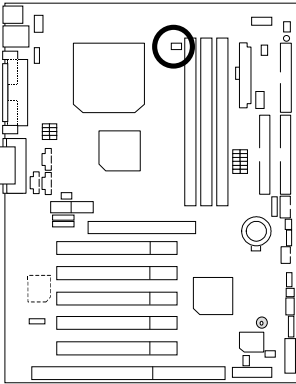

Pin No.	Definition
Open	Normal
Close	Turbo

## JP9: USB Device Wake up Selection

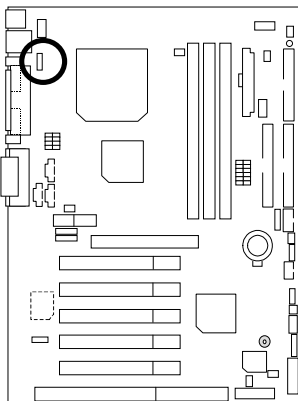

Pin No.	Definition
1-2 close	Normal (Default)
2-3 close	Enabled USB Device Wake up

(If you want to use “**USB KB Wakeup from S3~S5**” function, you have to set the BIOS setting “USB KB Wakeup from S3~S5” enabled, and the jumper “**JP9**” enabled).

\*(Power on the computer and as soon as memory counting starts, press <Del>. You will enter BIOS Setup. Select the item “**POWER MANAGEMENT SETUP**”, then select “**USB KB Wakeup from S3~S5: Enabled**”. Remember to save the setting by pressing “ESC” and choose the “**SAVE & EXIT SETUP**” option.)

## JP23: Case Open

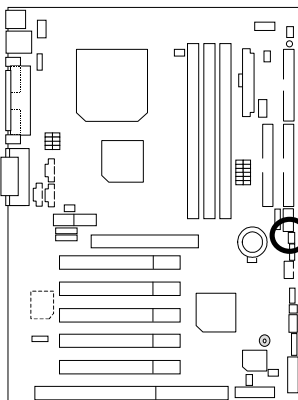

Pin No.	Definition
1	Signal
2	GND

JP22: BIOS Flash ROM Write Protect

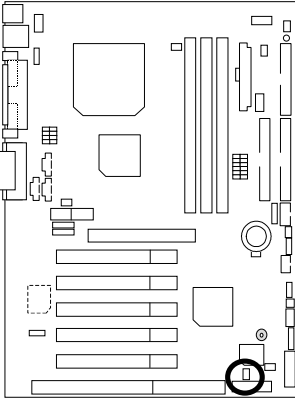

Pin No.	Definition
Close	BIOS Write Disabled
Open	BIOS Write Enabled (Default)

● Please set Jumper JP22 to "Open" to enabled BIOS write function when you update new BIOS or new device.

JP30: Over Voltage CPU Speed Up (**Magic Booster**) (Optional)  
 (When JP30 set "7-8 Close", CPU Voltage is rising 10%)

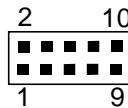
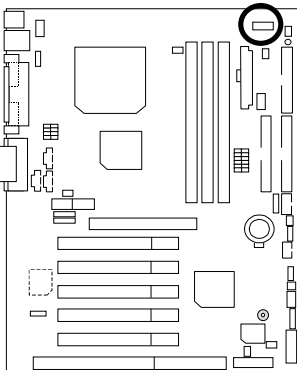

Pin No.	Definition
1-2 close	40%
3-4 close	30%
5-6 close	20%
7-8 close	10%
9-10 close	Normal

## J12: Front Panel Jumper (Optional)

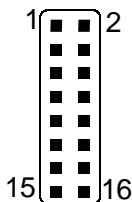
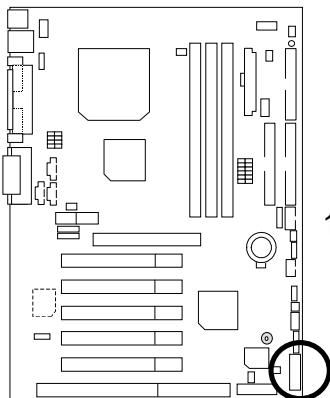

Pin No.	Definition
1	HD LED+
2	GN LED+
3	HD LED-
4	PWR LED+
5,7	RESET SW
6,8	Soft ON/OFF
10,12	Green SW
9	+5V
11	IR RX
13	GND
15	IRTX
14	NC
16	IR Power

## BAT1: Battery

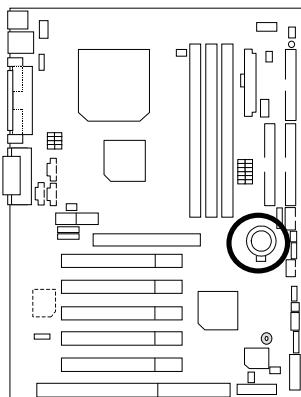

- ⚠ Danger of explosion if battery is incorrectly replaced.
- ⚠ Replace only with the same or equivalent type recommended by the manufacturer.
- ⚠ Dispose of used batteries according to the manufacturer's instructions.



## Performance List

The following performance data list is the testing results of some popular benchmark testing programs.

These data are just referred by users, and there is no responsibility for different testing data values gotten by users. (The different Hardware & Software configuration will result in different benchmark testing results.)

- CPU Intel® Socket 370 Processor
- DRAM (256 x 1) MB SDRAM (MOSEL V436532S04VCTG-75)
- CACHE SIZE 256 KB included in CPU (Pentium® !!!)
- DISPLAY GA-66032D AGP Card (Rev. 1.3)
- STORAGE Onboard IDE (Quantum KA13600AT)
- O.S. Windows NT™ 4.0 +SPK6a
- DRIVER Display Driver at 1024 x 768 True colors 75Hz  
VIA 4 in 1 Rev. 4.24a

Processor	Intel® Coppermine 933 MHz (133 x 7)
<b>Winbench99</b>	
CPU mark99	81.9
FPU Winmark 99	4940
Business Disk Winmark 99	5930
Hi-End Disk Winmark 99	8760
Business Graphics Winmark 99	365
Hi-End Graphics Winmark 99	798
<b>Winstone99</b>	
Business Winstone99	45
Hi-End Winstone99	45.8

● If you wish to maximize the performance of your system, please refer to the detail on P.52

# Block Diagram

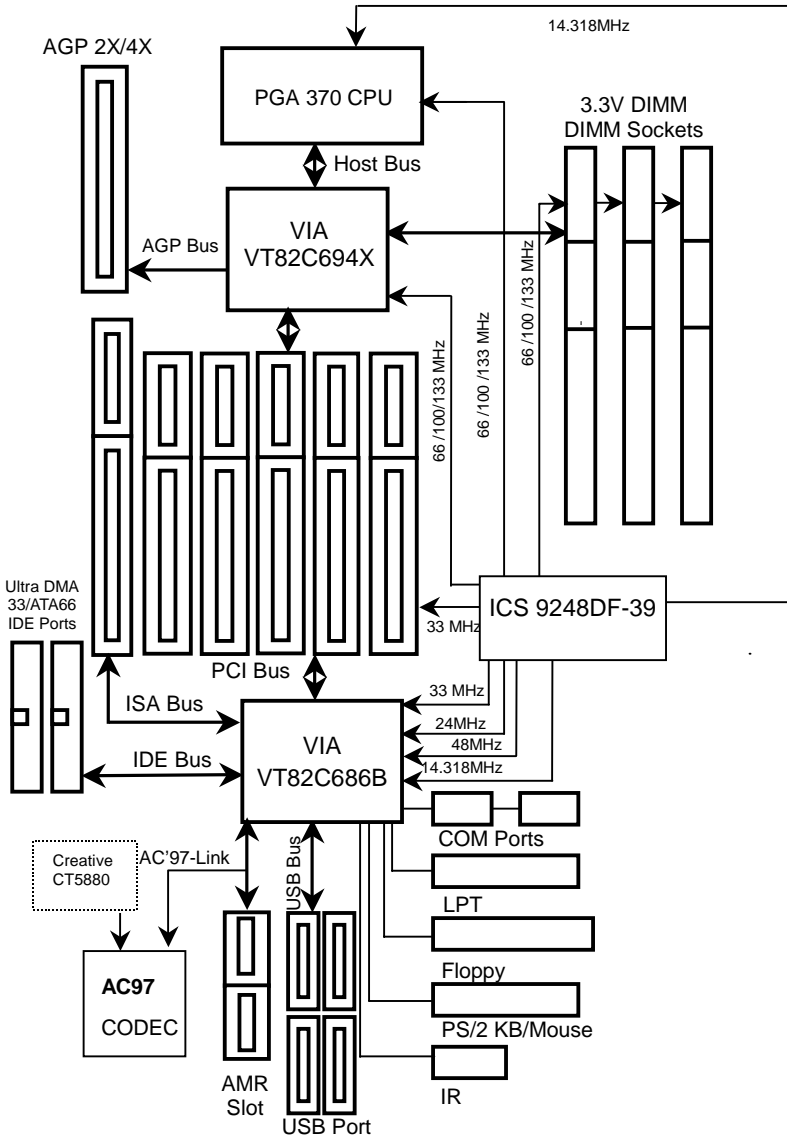

## Suspend To RAM Installation

### A.1 Introduce STR function:

Suspend-to-RAM (STR) is a Windows 98 ACPI sleep mode function. When recovering from STR (S3) sleep mode, the system is able, in just a few seconds, to retrieve the last "state" of the system before it went to sleep and recover to that state. The "state" is stored in memory (RAM) before the system goes to sleep. During STR sleep mode, your system uses only enough energy to maintain critical information and system functions, primarily the system state and the ability to recognize various "wake up" triggers or signals, respectively.

### A.2 STR function Installation

Please use the following steps to complete the STR function installation.

#### Step-By-Step Setup

##### Step 1:

To utilize the STR function, the system must be in Windows 98 ACPI mode.

Putting Windows 98 into ACPI mode is fairly easy.

#### Setup with Windows 98 CD:

- A. Insert the Windows 98 CD into your CD-ROM drive, select Start, and then Run.
- B. Type (without quotes) "**D:\setup /p j**" in the window provided. Hit the enter key or click OK. 『 In Windows 98 second edition version, all the bios version dated 12/01/99 or later are ACPI compatible. Just type " D:\Setup", the operating system will be installed as ACPI mode. 』
- C. After setup completes, remove the CD, and reboot your system  
(This manual assumes that your CD-ROM device drive letter is D:).

**Step 2:**

(If you want to use STR Function, please set jumper JP11 Closed.)

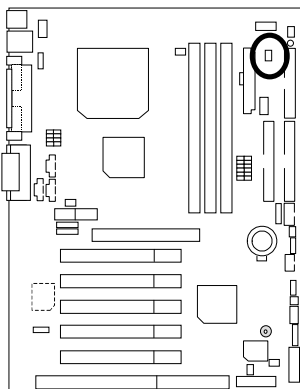

Pin No.	Definition
Open	STR Disabled (Default)
Close	STR Enabled

**Step 3:**

Power on the computer and as soon as memory counting starts, press <Del>. You will enter BIOS Setup. Select the item **"POWER MANAGEMENT SETUP"**, then select **"ACPI Sleep Type: S3 / STR"**. Remember to save the settings by pressing "ESC" and choose the **"SAVE & EXIT SETUP"** option.

Congratulation! You have completed the installation and now can use the STR function.

### A.3 How to put your system into STR mode?

There are two ways to accomplish this:

1. Choose the "Stand by" item in the "Shut Down Windows" area.
  - A. Press the "Start" button and then select "Shut Down"



- B. Choose the "Stand by" item and press "OK"

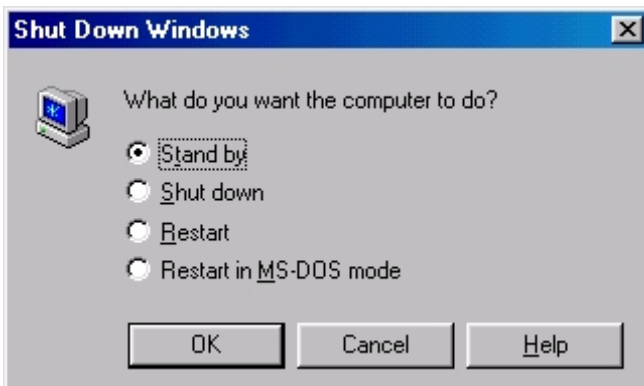

## 6VX7B-4X Motherboard

---

2. Define the system "power on" button to initiate STR sleep mode:

A. Double click "My Computer" and then "Control Panel"



B. Double click the " Power Management" item.

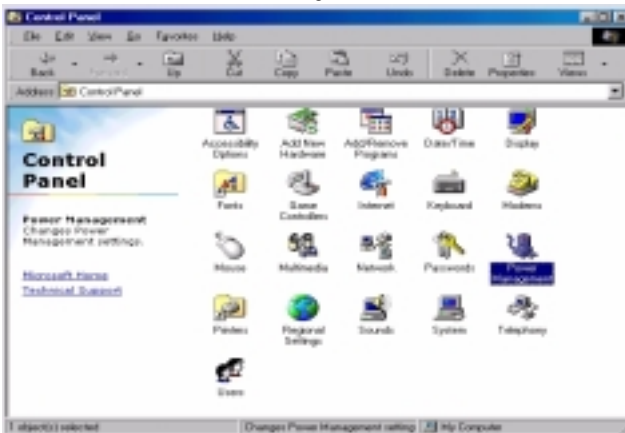

C. Select the "Advanced" tab and "Standby" mode in Power Buttons.

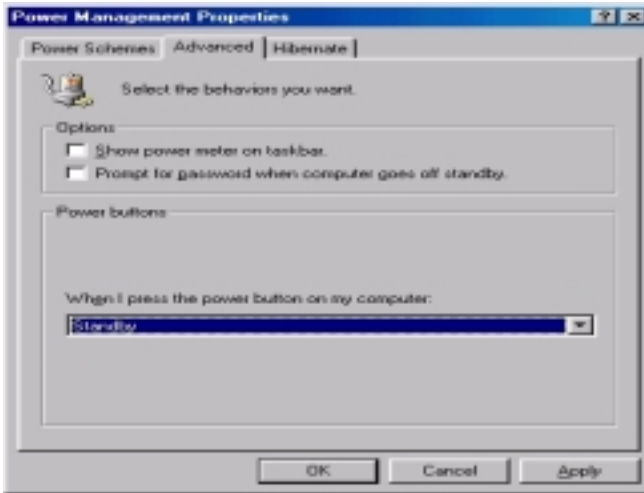

**Step 4:**

Restart your computer to complete setup.

Now when you want to enter STR sleep mode, just momentarily press the "Power on" button..

**A.4 How to recover from the STR sleep mode?**

There are five ways to "wake up" the system:

1. Press the "Power On" button.
2. Use the "Resume by Alarm" function.
3. Use the "Modem Ring On" function.
4. Use the "Wake On LAN" function.
5. Use the "USB Device Wake up" function.

**A.5 Notices:**

1. In order for STR to function properly, several hardware and software requirements must be satisfied:
  - A. Your ATX power supply must comply with the ATX 2.01 specification (provide more than 720 mA 5V Stand-By current).
  - B. Your SDRAM must be PC-100 compliant.
2. Jumper JP5 is provided to connect to the STR LED in your system chassis. [Your chassis may not provide this feature.] The STR LED will be illuminated when your system is in STR sleep mode.

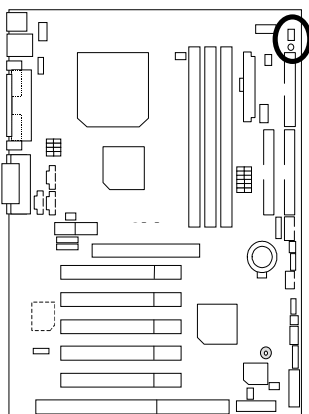

**STR LED Connector External**



**DIMM LED**



## Memory Installation

The motherboard has 3 dual inline memory module (DIMM) sockets. The BIOS will automatically detects memory type and size. To install the memory module, just push it vertically into the DIMM Slot .The DIMM module can only fit in one direction due to the two notch. Memory size can vary between sockets.

Install memory in any combination table:

DIMM	168-pin SDRAM DIMM Modules	
DIMM1	Supports 16 / 32 / 64 / 128 / 256 / 512MB	X 1 pcs
DIMM2	Supports 16 / 32 / 64 / 128 / 256 / 512MB	X 1 pcs
DIMM3	Supports 16 / 32 / 64 / 128 / 256 / 512MB	X 1 pcs

## 6VX7B-4X Motherboard

---

 Page Index for BIOS Setup	Page
The Main Menu	P.45
Standard CMOS Setup	P.47
BIOS Features Setup	P.50
Chipset Features Setup	P.52
Power Management Setup	P.55
PNP/ PCI Configuration	P.58
Load BIOS Defaults	P.60
Load Setup Defaults	P.61
Integrated Peripherals	P.62
Hardware Monitor Setup	P.66
Supervisor Password / User Password	P.68
IDE HDD Auto Detection	P.69
Save & Exit Setup	P.70
Exit Without Saving	P.71

## BIOS Setup

BIOS Setup is an overview of the BIOS Setup Program. The program that allows users to modify the basic system configuration. This type of information is stored in battery-backed CMOS RAM so that it retains the Setup information when the power is turned off.

### ENTERING SETUP

Power ON the computer and press <Del> immediately will allow you to enter Setup. If the message disappears before you respond and you still wish to enter Setup, restart the system to try again by turning it OFF then ON or pressing the "RESET" bottom on the system case. You may also restart by simultaneously press <Ctrl> – <Alt>– <Del> keys.

### CONTROL KEYS

<↑>	Move to previous item
<↓>	Move to next item
<<←>	Move to the item in the left hand
<→>	Move to the item in the right hand
<Esc>	Main Menu - Quit and not save changes into CMOS Status Page Setup Menu and Option Page Setup Menu - Exit current page and return to Main Menu
<+/PgUp>	Increase the numeric value or make changes
<-/PgDn>	Decrease the numeric value or make changes
<F1>	General help, only for Status Page Setup Menu and Option Page Setup Menu
<F2>	Reserved
<F3>	Reserved
<F4>	Reserved
<F5>	Restore the previous CMOS value from CMOS, only for Option Page Setup Menu
<F6>	Load the default CMOS value from BIOS default table, only for Option Page Setup Menu
<F7>	Load the Setup Defaults.
<F8>	Reserved
<F9>	Reserved
<F10>	Save all the CMOS changes, only for Main Menu

## GETTING HELP

### Main Menu

The on-line description of the highlighted setup function is displayed at the bottom of the screen.

### Status Page Setup Menu / Option Page Setup Menu

Press F1 to pop up a small help window that describes the appropriate keys to use and the possible selections for the highlighted item. To exit the Help Window press <Esc>.

## The Main Menu

Once you enter AMI BIOS CMOS Setup Utility, the Main Menu (Figure 1) will appear on the screen. The Main Menu allows you to select from nine setup functions and two exit choices. Use arrow keys to select among the items and press <Enter> to accept or enter the sub-menu.

AMIBIOS SIMPLE SETUP UTILITY-VERSION 1.23 ( C ) 1999 American Megatrends, Inc. All Rights Reserved	
STANDARD CMOS SETUP	INTEGRATED PERIPHERALS
BIOS FEATURES SETUP	HARDWARE MONITOR SETUP
CHIPSET FEATURES SETUP	SUPERVISOR PASSWORD
POWER MANAGEMENT SETUP	USER PASSWORD
PNP/PCI CONFIGURATION	IDE HDD AUTO DETECTION
LOAD BIOS DEFAULTS	SAVE & EXIT SETUP
LOAD SETUP DEFAULTS	EXIT WITHOUT SAVING
ESC : Quit      ↑↓←→ : Select Item      (Shift) F2 : Change Color      F5 : Old Values F6 : Load BIOS Defaults      F7: Load Setup Defaults      F10: Save & Exit	
Time, Date, Hard Disk Type, ...	

Figure 1: Main Menu

- **Standard CMOS Setup**

This setup page includes all the items in standard compatible BIOS.

- **BIOS Features Setup**

This setup page includes all the items of AMI special enhanced features.

- **Chipset Features Setup**

This setup page includes all the items of chipset special features.

- **Power Management Setup**

This setup page includes all the items of Green function features.

- **PnP/PCI Configurations**

This setup page includes all the configurations of PCI & PnP ISA resources.

- **Load BIOS Defaults**

Bios Defaults indicates the value of the system parameter which the system would be in the safe configuration.

- **Load Setup Defaults**

Setup Defaults indicates the value of the system parameter which the system would be in the most appropriate configuration.

- **Integrated Peripherals**

This setup page includes all onboard peripherals.

- **Hardware Monitor Setup**

This setup page is auto detect fan and temperature status.

- **Supervisor password**

Change, set, or disable password. It allows you to limit access to the system and Setup, or just to Setup.

- **User password**

Change, set, or disable password. It allows you to limit access to the system.

- **IDE HDD auto detection**

Automatically configure hard disk parameters.

- **Save & Exit Setup**

Save CMOS value settings to CMOS and exit setup.

- **Exit Without Saving**

Abandon all CMOS value changes and exit setup.

## Standard CMOS Setup

The items in Standard CMOS Features Menu (Figure 2) are divided into 9 categories. Each category includes no, one or more than one setup items. Use the arrows to highlight the item and then use the <PgUp> or <PgDn> keys to select the value you want in each item.

AMIBIOS SETUP – STANDARD CMOS SETUP ( C ) 1999 American Megatrends, Inc. All Rights Reserved	
Date (mm/dd/yyyy) : Tue Mar 07, 2000 Time (hh/mm/ss) : 10:36:24	
	TYPE SIZE CYLS HEAD PRECOMP LANDZ SECTOR MODE
Pri Master : Auto	
Pri Slave : Auto	
Sec Master : Auto	
Sec Slave : Auto	
Floppy Drive A: 1.44 MB 3 ½	Base Memory : 640 Kb
Floppy Drive B: Not Installed	Other Memory: 384 Kb
	Extended Memory: 31Mb
	Total Memory: 32Mb
Boot Sector Virus Protection : Disabled	
Month: Jan – Dec	ESC : Exit
Day: 01 – 31	↑↓ : Select Item
Year: 1990– 2099	PU/PD/+/- : Modify (Shift)F2 : Color

Figure 2: Standard CMOS Setup

- **Date**

The date format is <Week>, <Month>, <Day>, <Year>.

Week	The week, from Sun to Sat, determined by the BIOS and is display-only
Month	The month, Jan. Through Dec.
Day	The day, from 1 to 31 (or the maximum allowed in the month)
Year	The year, from 1990 through 2099

- **Time**

The times format in <hour> <minute> <second>. The time is calculated base on the 24-hour military-time clock. For example, 1 p.m. is 13:00:00.

- **Primary Master, Slave / Secondary Master, Slave**

The category identifies the types of hard disk from drive C to F that has been installed in the computer. There are two types: auto type, and user definable type. User type is user-definable; Auto type which will automatically detect HDD type.

Note that the specifications of your drive must match with the drive table. The hard disk will not work properly if you enter improper information for this category.

If you select User Type, related information will be asked to enter to the following items. Enter the information directly from the keyboard and press <Enter>. Such information should be provided in the documentation form your hard disk vendor or the system manufacturer.

CYLS.	Number of cylinders
HEADS	number of heads
PRECOMP	write precomp
LANDZONE	Landing zone
SECTORS	number of sectors

If a hard disk has not been installed select NONE and press <Enter>.

- **Floppy Drive A / Floppy Drive B**

The category identifies the types of floppy disk drive A or drive B that has been installed in the computer.

None	No floppy drive installed
360K, 5.25 in.	5.25 inch PC-type standard drive; 360K byte capacity.
1.2M, 5.25 in.	5.25 inch AT-type high-density drive; 1.2M byte capacity (3.5 inch when 3 Mode is Enabled).
720K, 3.5 in.	3.5 inch double-sided drive; 720K byte capacity
1.44M, 3.5 in.	3.5 inch double-sided drive; 1.44M byte capacity.
2.88M, 3.5 in.	3.5 inch double-sided drive; 2.88M byte capacity.

- **Boot Sector Virus Protection**

If it is set to enable, the category will flash on the screen when there is any attempt to write to the boot sector or partition table of the hard disk drive. The system will halt and the following error message will appear in the mean time. You can run anti-virus program to locate the problem.

Enabled	Activate automatically when the system boots up causing a warning message to appear when anything attempts to access the boot sector or hard disk partition table
Disabled	No warning message to appear when anything attempts to access the boot sector or hard disk partition table. <b>(Default Value)</b>

- **Memory**

The category is display-only which is determined by POST (Power On Self Test) of the BIOS.

**Base Memory**

The POST of the BIOS will determine the amount of base (or conventional) memory installed in the system.

The value of the base memory is typically 512 K for systems with 512 K memory installed on the motherboard, or 640 K for systems with 640 K or more memory installed on the motherboard.

**Extended Memory**

The BIOS determines how much extended memory is present during the POST.

This is the amount of memory located above 1 MB in the CPU's memory address map.

**Other Memory**

This refers to the memory located in the 640 K to 1024 K address space. This is memory that can be used for different applications.

DOS uses this area to load device drivers to keep as much base memory free for application programs. Most use for this area is Shadow RAM





- **Boot Up Num-Lock**

On	Keypad is number keys. <b>(Default Value)</b>
Off	Keypad is arrow keys.

- **Floppy Drive Seek**

During POST, BIOS will determine if the floppy disk drive installed is 40 or 80 tracks. 360 type is 40 tracks while 720 , 1.2 and 1.44 are all 80 tracks.

Enabled	BIOS searches for floppy disk drive to determine if it is 40 or 80 tracks. Note that BIOS can not tell from 720, 1.2 or 1.44 drive type as they are all 80 tracks.
Disabled	BIOS will not search for the type of floppy disk drive by track number. Note that there will not be any warning message if the drive installed is 360. <b>(Default Value)</b>

- **Password Check**

Setup	Set Password Check to Setup. <b>(Default Value)</b>
Always	Set Password Check to Always.

- **Processor Serial Number**

Disabled	Disabled Processor Serial Number. <b>(Default Value)</b>
Enabled	Enabled Processor Serial Number.

## Chipset Features Setup

AMIBIOS SETUP –CHIPSET FEATURE CMOS SETUP ( C ) 1999 American Megatrends, Inc. All Rights Reserved	
*** DRAM Timing ***	
Top Performance	:Disabled
SDRAM Timing by SPD	:Disabled
SDRAM CAS# Latency	:3
DRAM Frequency	:Auto
C2P Concurrency & Master	:Enabled
DRAM Integrity Mode	:Disabled
AGP Mode	:4X
AGP Comp. Driving	:Auto
Manual AGP Comp. Driving	:CB
AGP Aperture Size	:64MB
ClkGen Spread Spectrum	:Center± 0.25%
USB Controller	:All USB Port
USB Legacy Support	:Disabled
ESC : Quit            ↑↓←→: Select Item F1: Help            PU/PD/+/- : Modify F5 : Old Values (Shift)F2 :Color F6 : Load BIOS Defaults F7 : Load Setup Defaults	

Figure 4: Chipset Features Setup

- **Top Performance**

If you wish to maximize the performance of your system, set "Top Performance" as "Enabled".

Disabled	Disabled this function. <b>(Default Value)</b>
Enabled	Enabled Top Performance function.

- **SDRAM Timing by SPD**

Disabled	SDRAM Timing by SPD Function Disabled. <b>(Default Value)</b>
Enabled	SDRAM Timing by SPD Function Enabled.

- **SDRAM CAS# Latency**

3	For Slower SDRAM DIMM module. <b>(Default Value)</b>
2	For Fastest SDRAM DIMM module.

- **DRAM Frequency**

Auto	Set DRAM Frequency to Auto. <b>(Default Value)</b>
66MHz	Set DRAM Frequency is 66MHz.
100MHz	Set DRAM Frequency is 100MHz.
133MHz	Set DRAM Frequency is 133MHz.

- **C2P Concurrency & Master**

Enabled	Enabled C2P Concurrency & Master. <b>(Default Value)</b>
Disabled	Disabled C2P Concurrency & Master.

- **DRAM Integrity Mode**

ECC	For 72 bit ECC type DIMM Modle.
Disabled	Normal Setting. <b>(Default Value)</b>

- **AGP Mode**

4X	Set AGP Mode is 4X. <b>(Default Value)</b>
1X	Set AGP Mode is 1X.
2X	Set AGP Mode is 2X.

- **AGP Comp. Driving**

Auto	Set AGP Comp. Driving is Auto. <b>(Default Value)</b>
Manual	Set AGP Comp. Driving is Manual.

If AGP Comp. Driving is Manual.

Manual AGP Comp. Driving :	00-FF
----------------------------	-------

- **AGP Aperture Size**

4MB	Set AGP Aperture Size to 4MB.
8MB	Set AGP Aperture Size to 8 MB.
16MB	Set AGP Aperture Size to 16 MB.
32MB	Set AGP Aperture Size to 32 MB.
64MB	Set AGP Aperture Size to 64 MB. <b>(Default Value)</b>
128MB	Set AGP Aperture Size to 128 MB.
256MB	Set AGP Aperture Size to 256 MB.

- **ClkGen Spread Spectrum**

Disabled	Spread Spectrum Disabled.
Center± 0.25%	Set Spread Spectrum 0. 25%(Center Spread). <b>(Default Value)</b>
Center± 0.5%	Set Spread Spectrum 0. 5%(Center Spread).

---

- **USB Controller**

USB Port 0&1	USB Controller for USB Port 0&1.
USB Port 2&3	USB Controller for USB Port 2&3.
All USB Port	USB Controller for All USB Port. <b>(Default Value)</b>
Disabled	USB Controller Function Disabled.

- **USB Legacy Support**

Keyboard	Set USB Legacy Support Keyboard.
Keyb+Mouse	Set USB Legacy Support Keyboard +Mouse.
Disabled	Disabled USB Legacy Support Function. <b>(Default Value)</b>

## Power Management Setup

AMIBIOS SETUP –POWER MANAGEMENT SETUP ( C ) 1999 American Megatrends, Inc. All Rights Reserved			
ACPI Sleep Type	:S1/POS	PME Event Wake up	:Enabled
USB KB Wakeup From S3~S5	:Disabled	RTC Alarm Power On	:Disabled
Video Power Down Mode	:Stand By	RTC Alarm Date	:15
Hard Disk Power Down Mode	:Stand By	RTC Alarm Hour	:12
Suspend Time Out(Minute)	:Disabled	RTC Alarm Minute	:30
Display Activity	:Ignore	RTC Alarm Second	:30
IRQ3	:Monitor		
IRQ 4	:Monitor		
IRQ 5	:Ignore		
IRQ 7	:Monitor		
IRQ 9	:Ignore		
IRQ 10	:Ignore		
IRQ 11	:Ignore		
IRQ 13	:Ignore		
IRQ 14	:Monitor		
IRQ 15	:Ignore		
Soft-off by Power Button	:Instant off	ESC : Quit	↑↓←→: Select Item
AC Back Function	:Memory	F1 : Help	PU/PD/+/- : Modify
Modem Use IRQ	:4	F5 : Old Values	(Shift)F2 :Color
Modem Ring On/Wake On Lan	:Enabled	F6 : Load BIOS Defaults	
		F7 : Load Setup Defaults	

Figure 5: Power Management Setup

- **ACPI Sleep type**

S1/POS	Set ACPI Sleep type is S1 ( <b>Default Value</b> )
S3/STR	Set ACPI Sleep type is S3.

- **USB KB Wakeup From S3~S5**

Enabled	Enable USB Keyboard Wakeup from system.
Disabled	Disable USB Keyboard Wakeup from system. ( <b>Default Value</b> )

- **Video Power Down Mode**

Disabled	Disabled Video Power Down Mode Function.
Suspend	Set Video Power Down Mode to Suspend.
Stand By	Set Video Power Down Mode to Stand By. ( <b>Default Value</b> )

- **Hard Disk Power Down Mode**

Disabled	Disabled Hard Disk Power Down Mode Function.
Suspend	Set Hard Disk Power Down Mode to Suspend
Stand By	Set Hard Disk Power Down Mode to Stand By. ( <b>Default Value</b> )

- **Suspend Time Out (Minute.)**

Disabled	Disabled Suspend Time Out Function. <b>(Default Value)</b>
1	Enabled Suspend Time Out after 1min.
2	Enabled Suspend Time Out after 2min.
4	Enabled Suspend Time Out after 4min.
8	Enabled Suspend Time Out after 8min.
10	Enabled Suspend Time Out after 10min.
20	Enabled Suspend Time Out after 20min.
30	Enabled Suspend Time Out after 30min.
40	Enabled Suspend Time Out after 40min.
50	Enabled Suspend Time Out after 50min.
60	Enabled Suspend Time Out after 60min.

- **Display Activity**

Ignore	Ignore Display Activity. <b>(Default Value)</b>
Monitor	Monitor Display Activity.

- **IRQ 3-IRQ15**

Ignore	Ignore IRQ3 -IRQ15.
Monitor	Monitor IRQ3-IRQ15.

- **Soft-off by Power Button**

Instant off	Soft switch ON/OFF for Power Button. <b>(Default Value)</b>
Delay-4Sec	Soft switch ON 4 Sec for Power off.

- **AC Back Function**

Memory	This function depends on computer status. <b>(Default value)</b>
Soft-Off	Set System Soft-Off Status.
Full-On	Set System Full-On Status.

- **MODEM Use IRQ**

NA	Set MODEM Use IRQ to NA.
3	Set MODEM Use IRQ to 3.
4	Set MODEM Use IRQ to 4. <b>(Default Value)</b>
5	Set MODEM Use IRQ to 5.
7	Set MODEM Use IRQ to 7.

- **Modem Ring On/Wake On Lan**

Disabled	Disabled Modem Ring On/Wake On Lan.
Enabled	Enabled Modem Ring On/Wake On Lan. <b>(Default Value)</b>

- **PME Event Wake up**

Disabled	Disabled PME Event Wake up function.
Enabled	Enabled PME Event Wake up function. <b>(Default Value)</b>

- **RTC Alarm Power On**

You can set "RTC Alarm Power On" item to Enabled and key in date/time to power on system.

Disabled	Disable this function. <b>(Default Value)</b>
Enabled	Enable alarm function to POWER ON system.

If the "RTC Alarm Power On" is Enabled.

RTC Alarm Date :	Every Day,1-31
RTC Alarm Hour:	0-23
RTC Alarm Minute :	0-59
RTC Alarm Second :	0-59



## PnP/PCI Configurations

AMIBIOS SETUP –PNP/PCI CONFIGURATION SETUP ( C ) 1999 American Megatrends, Inc. All Rights Reserved	
Plug and Play Aware O/S	:No
Reset Configuration Data	:No
VGA Boot From	:AGP
PCI VGA Palette Snoop	:Disabled
DMA Channel 0	:PnP
DMA Channel 1	:PnP
DMA Channel 3	:PnP
DMA Channel 5	:PnP
DMA Channel 6	:PnP
DMA Channel 7	:PnP
IRQ 3	:PCI/PnP
IRQ 4	:PCI/PnP
IRQ 5	:PCI/PnP
IRQ 7	:PCI/PnP
IRQ 9	:PCI/PnP
IRQ 10	:PCI/PnP
IRQ 11	:PCI/PnP
IRQ 14	:PCI/PnP
IRQ 15	:PCI/PnP

ESC : Quit	↑↓←→: Select Item
F1 : Help	PU/PD/+/- : Modify
F5 : Old Values	(Shift)F2 :Color
F6 : Load BIOS Defaults	
F7 : Load Setup Defaults	

Figure 6: PnP/PCI Configuration

- **Plug and Play Aware O/S**

Yes	Enable Plug and Play Aware O/S function.
No	Disable Plug and Play Aware O/S function. <b>(Default Value)</b>

- **Reset Configuration Data**

Yes	Clear PnP information in ESCD & update DMI data.
No	Disabled this function. <b>(Default Value)</b>

- **VGA Boot From**

AGP	Primary Graphics Adapter From AGP. <b>(Default Value)</b>
PCI	Primary Graphics Adapter From PCI.

- **PCI VGA Palette Snoop**

Enabled	For having Video Card on ISA Bus and VGA Card on PCI Bus.
Disabled	For VGA Card only. <b>(Default Value)</b>

- **DMA Channel (0,1,3,5,6,7)**

PnP	The resource is used by PnP device.
ISA / EISA	The resource is used by ISA / EISA device (PCI or ISA).

- **IRQ (3,4,5,7, 9,10,11,14,15)**

PCI/PnP	The resource is used by PCI/PnP device.
ISA / EISA	The resource is used by ISA / EISA device (PCI or ISA).

## Load BIOS Defaults

AMIBIOS SIMPLE SETUP UTILITY-VERSION 1.23 ( C ) 1999 American Megatrends, Inc. All Rights Reserved	
STANDARD CMOS SETUP	INTEGRATED PERIPHERALS
BIOS FEATURES SETUP	HARDWARE MONITOR SETUP
CHIPSET FEATURES SETUP	SUPERVISOR PASSWORD
POWER MANAGEMENT	
PNP/PCI CONFIGURATION	
LOAD BIOS DEFAULTS	SAVE & EXIT SETUP
LOAD SETUP DEFAULTS	EXIT WITHOUT SAVING
ESC : Quit    ↑↓→← : Select Item    (Shift) F2 : Change Color    F5 : Old Values F6 : Load BIOS Defaults    F7: Load Setup Defaults F10: Save & Exit	
Load BIOS Default except Standard CMOS Setup	

Figure 7: Load BIOS Defaults

- **Load BIOS Defaults**

BIOS defaults contain the most appropriate values of the system parameters that allow minimum system performance.

## Load Setup Defaults

AMIBIOS SIMPLE SETUP UTILITY-VERSION 1.23 ( C ) 1999 American Megatrends, Inc. All Rights Reserved	
STANDARD CMOS SETUP	INTEGRATED PERIPHERALS
BIOS FEATURES SETUP	HARDWARE MONITOR SETUP
CHIPSET FEATURES SETUP	SUPERVISOR PASSWORD
POWER MANAGE	Load SETUP Defaults (Y/N)? N
PNP/PCI CONFIGURATION	
LOAD BIOS DEFAULTS	SAVE & EXIT SETUP
LOAD SETUP DEFAULTS	EXIT WITHOUT SAVING
ESC : Quit      ↑↓→← : Select Item      (Shift) F2 : Change Color      F5 : Old Values F6 : Load BIOS Defaults      F7: Load Setup Defaults F10: Save & Exit	
Load Setup Default except Standard CMOS Setup	

Figure 8: Load Setup Defaults

- **Load Setup Defaults**

Selecting this field loads the factory defaults for BIOS and Chipset Features which the system automatically detects.

## Integrated Peripherals

AMIBIOS SETUP –INTEGRATED PERIPHERAL ( C ) 1999 American Megatrends, Inc. All Rights Reserved			
OnBoard IDE	:Both	Game Port(200h-207h)	:Enabled
OnBoard FDC	:Auto		
OnBoard Serial Port 1	:Auto		
OnBoard Serial Port 2	:Auto		
Serial Port 2 Mode	:Normal		
Duplex Mode	:N/A		
OnBoard Parallel Port	:Auto		
Parallel Port Mode	:ECP		
Parallel Port DMA	:Auto		
Parallel Port IRQ	:Auto		
OnBoard AC'97 Audio	:Auto		
OnBoard MC'97 Modem	:Auto		
Onboard Legacy Audio	:Enabled		
Sound Blaster	:Disabled		
SB I/O Base Address	:220h-22Fh		
SB IRQ Select	:IRQ 5	ESC : Quit	↑↓←→: Select Item
SB DMA Select	:DMA 1	F1 : Help	PU/PD/+/- : Modify
MPU-401	:Disabled	F5 : Old Values	(Shift)F2 :Color
MPU-401 I/O Address	:330h-333h	F6 : Load BIOS Defaults	
FM Port(388h-38Bh)	:Disabled	F7 : Load Setup Defaults	

Figure 9: Integrated Peripherals

- **OnBoard IDE**

Disabled	Disabled OnBoard IDE
Both	Set OnBoard IDE is Both. <b>(Default Value)</b>
Primary	Set OnBoard IDE is Primary.
Secondary	Set OnBoard IDE is Secondary.

- **OnBoard FDC**

Auto	Set OnBoard FDC is Auto. <b>(Default Value)</b>
Disabled	Disabled OnBoard FDC.
Enabled	Enabled OnBoard FDC.

- **OnBoard Serial Port 1**

Auto	BIOS will automatically setup the port 1 address. <b>(Default Value)</b>
3F8/COM1	Enable onBoard Serial port 1 and address is 3F8.
2F8/COM2	Enable onBoard Serial port 1 and address is 2F8.
3E8/COM3	Enable onBoard Serial port 1 and address is 3E8.
2E8/COM4	Enable onBoard Serial port 1 and address is 2E8.
Disabled	Disable onBoard Serial port 1.

- **OnBoard Serial Port 2**

Auto	BIOS will automatically setup the port 2 address. <b>(Default Value)</b>
3F8/COM1	Enable onBoard Serial port 2 and address is 3F8.
2F8/COM2	Enable onBoard Serial port 2 and address is 2F8.
3E8/COM3	Enable onBoard Serial port 2 and address is 3E8.
2E8/COM4	Enable onBoard Serial port 2 and address is 2E8.
Disabled	Disable onBoard Serial port 2.

- **Serial Port 2 Mode**

(This item allows you to determine which Serial Port 2 Mode of onboard I/O chip)

ASK IR	Set onboard I/O chip Serial Port 2 to ASK IR Mode.
IrDA	Set onboard I/O chip Serial Port 2 to IrDA Mode.
Normal	Set onboard I/O chip Serial Port 2 to Normal Mode. <b>(Default Value)</b>

- **Duplex Mode**

Half Duplex	IR Function Duplex Half.
N/A	Disabled this function. <b>(Default Value)</b>
Full Duplex	IR Function Duplex Full.

- **On Board Parallel port**

378	Enable On Board LPT port and address is 378.
278	Enable On Board LPT port and address is 278.
3BC	Enable On Board LPT port and address is 3BC.
Auto	Set On Board LPT port is Auto. <b>(Default Value)</b>
Disabled	Disable On Board LPT port.

- **Parallel Port Mode**

EPP	Using Parallel port as Enhanced Parallel Port.
ECP	Using Parallel port as Extended Capabilities Port. <b>(Default Value)</b>
Normal	Normal Operation.

- **Parallel Port DMA**

Auto	Set Auto to parallel port mode DMA Channel. <b>(Default Value)</b>
3	Set Parallel Port DMA is 3.
1	Set Parallel Port DMA is 1.
0	Set Parallel Port DMA is 0.

- **Parallel Port IRQ**

7	Set Parallel Port IRQ is 7.
Auto	Set Auto to parallel Port IRQ DMA Channel. <b>(Default Value)</b>
5	Set Parallel Port IRQ is 5.

- **OnBoard AC'97 Audio**

Auto	Set OnBoard AC'97 Audio to Auto. <b>(Default Value)</b>
Disabled	Disabled OnBoard AC'97 Audio.

- **OnBoard MC'97 Modem**

Auto	Set OnBoard MC'97 Modem to Auto. <b>(Default Value)</b>
Disabled	Disabled OnBoard MC'97 Modem.

- **OnBoard Legacy Audio**

Enabled	Enabled OnBoard Legacy Audio. <b>(Default Value)</b>
Disabled	Disabled OnBoard Legacy Audio.

- **Sound Blaster**

Enabled	Enabled Sound Blaster.
Disabled	Disabled Sound Blaster. <b>(Default Value)</b>

- **SB I/O Base Address**

220h-22Fh	Set SB I/O Base Address is 220h-22Fh. <b>(Default Value)</b>
280h-28Fh	Set SB I/O Base Address is 280h-28Fh.
260h-26Fh	Set SB I/O Base Address is 260h-26Fh.
240h-24Fh	Set SB I/O Base Address is 240h-24Fh.

- **SB IRQ Select**

IRQ 5 / 7 / 9 / 10. <b>(Default Value: 5)</b>
---

- **SB DMA Select**

DMA 0 / 1 / 2 / 3. <b>(Default Value: 1)</b>
--

- **MPU-401**

Enabled	Enabled MPU-401.
Disabled	Disabled MPU-401. <b>(Default Value)</b>

- **MUP-401 I/O Address**

330h-333h	Set MUP-401 I/O Address is 330h-333h. <b>(Default Value)</b>
300h-303h	Set MUP-401 I/O Address is 300h-303h.
310h-313h	Set MUP-401 I/O Address is 310h-313h.
320h-323h	Set MUP-401 I/O Address is 320h-323h.

- **FM Port (388h-38Bh)**

Disabled	Disabled FM Port (388h-38Bh). <b>(Default Value)</b>
Enabled	Enabled FM Port (388h-38Bh).

- **Game Port (200h-207h)**

Disabled	Disabled Game Port (200h-207h).
Enabled	Enabled Game Port (200h-207h). <b>(Default Value)</b>



## Hardware Monitor

AMBIOS SETUP –HARDWARE MONITOR	
(C) 1999 American Megatrends, Inc. All Rights Reserved	
ACPI Shut Down Temp.	:Disabled
Current CPU Temp.	:36°C/96°F
Current System Temp.	:28°C/82°F
Case Status	:Closed
Current CPU Fan Speed	:5487 RPM
Current System Fan Speed	:0 RPM
Vcore	:1.634V
+3.300V	:3.590V
+5.000V	:5.119V
+12.000V	:11.926V
ESC : Quit                    ↑↓←→: Select Item F1 : Help                    PU/PD/+/- : Modify F5 : Old Values            (Shift)F2 :Color F6 : Load BIOS Defaults F7 : Load Setup Defaults	

Figure 10: Hardware Monitor

- **ACPI Shutdown Temp. (°C / °F)**

(This function will be effective only for the operating systems that support ACPI Function.)

Disabled	Disable ACPI Shutdown function. <b>(Default Value)</b>
60°C / 140°F	Monitor CPU Temp. at 60°C / 140°F, if Temp. > 60°C / 140°F system will automatically power off.
65°C / 149°F	Monitor CPU Temp. at 65°C / 149°F, if Temp. > 65°C / 149°F system will automatically power off.
70°C / 158°F	Monitor CPU Temp. at 70°C / 158°F, if Temp. > 70°C / 158°F system will automatically power off.
75°C / 167°F	Monitor CPU Temp. at 75°C / 167°F, if Temp. > 75°C / 167°F system will automatically power off.

- **Current CPU Temp. (°C / °F)**

Detect CPU Temperature automatically.

- **Current System Temp. (°C / °F)**

Detect System Temperature automatically.

- **Case Status**

If the case is closed, "Case Status" will show "Closed".

If the case have been opened, "Case Opened" will show "Open".

- **Current CPU Fan Speed**

Detect CPU Fan speed status automatically .

- **Current System Fan Speed**

Detect System Fan speed status automatically .

- **Current Voltage (V) VCORE / +3.3V / +5V / +12V**

Detect system's voltage status automatically.

## Set Supervisor / User Password

When you select this function, the following message will appear at the center of the screen to assist you in creating a password.

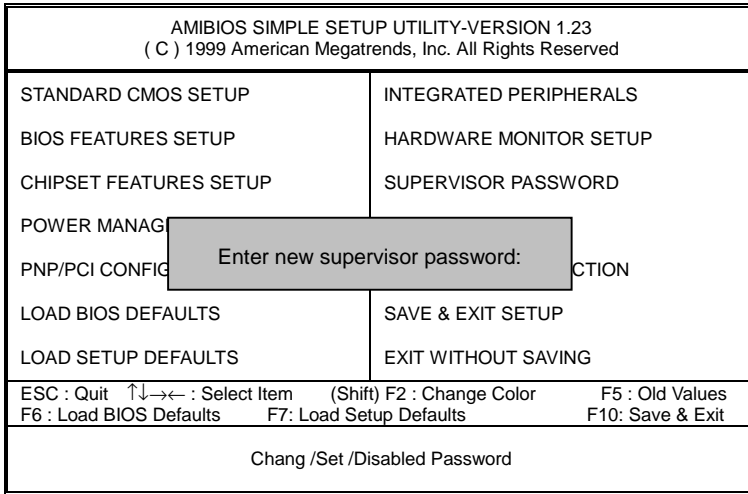

Figure 11: Password Setting

Type the password, up to eight characters, and press <Enter>. The password typed now will clear the previously entered password from CMOS memory. You will be asked to confirm the password. Type the password again and press <Enter>. You may also press <Esc> to abort the selection and not enter a password.

To disable password, just press <Enter> when you are prompted to enter password. A message "PASSWORD DISABLED" will appear to confirm the password being disabled. Once the password is disabled, the system will boot and you can enter Setup freely.

If you select "Always" at "Password Check" Option in BIOS Features Setup Menu, you will be prompted for the password every time the system is rebooted or any time you try to enter Setup Menu. If you select "Setup" at "Password Check" Option in BIOS Features Setup Menu, you will be prompted only when you try to enter Setup.

## IDE HDD AUTO Detection

AMIBIOS SETUP – STANDARD CMOS SETUP	
( C ) 1999 American Megatrends, Inc. All Rights Reserved	
Date (mm/dd/yyyy) : Tue Feb 17, 2000	
Time (hh/mm/ss) : 10:36:24	
	TYPE SIZE CYLS HEAD PRECOMP LANDZ
SECTOR	MODE
Pri Master	:Auto
Pri Slave	:Auto
Sec Master	:Auto
Sec Slave	:Auto
Floppy Drive A:	1.44 MB 3 ½
Floppy Drive B:	Not Installed
Boot Sector Virus Protection :	Disabled
Base Memory	: 640 Kb
Other Memory	: 384 Kb
Extended Memory	: 31Mb
Total Memory	: 32Mb
Month:	Jan – Dec
Day:	01 – 31
Year:	1990 – 2099
	ESC : Exit
	↑↓: Select Item
	PU/PD/+/- : Modify
	Shift)F2 : Color

Figure 12: IDE HDD Auto Detection

Type "Y" will accept the H.D.D. parameter reported by BIOS.

Type "N" will keep the old H.D.D. parameter setup. If the hard disk cylinder number is over 1024, then the user can select LBA mode or LARGER mode for DOS partition larger than 528 MB.

## Save & Exit Setup

AMIBIOS SIMPLE SETUP UTILITY-VERSION 1.23 ( C ) 1999 American Megatrends, Inc. All Rights Reserved	
STANDARD CMOS SETUP	INTEGRATED PERIPHERALS
BIOS FEATURES SETUP	HARDWARE MONITOR SETUP
CHIPSET FEATURES SETUP	SUPERVISOR PASSWORD
POWER MANAGEMENT SETUP	
PNP/PCI CONFIGURATION	
LOAD BIOS DEFAULTS	SAVE & EXIT SETUP
LOAD SETUP DEFAULTS	EXIT WITHOUT SAVING
ESC : Quit    ↑↓→← : Select Item    (Shift) F2 : Change Color    F5 : Old Values F6 : Load BIOS Defaults    F7: Load Setup Defaults    F10: Save & Exit	
Save Data to CMOS & Exit Setup	

Figure 13: Save & Exit Setup

Type "Y" will quit the Setup Utility and save the user setup value to RTC CMOS.

Type "N" will return to Setup Utility.

## Exit Without Saving

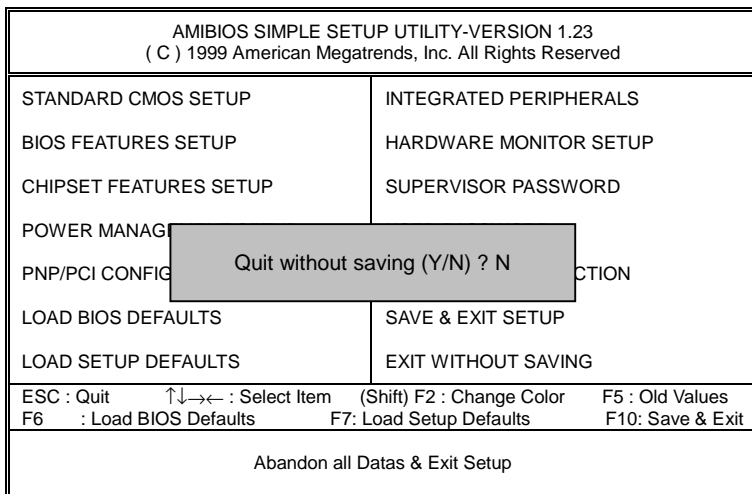

Figure 14: Exit Without Saving

Type "Y" will quit the Setup Utility without saving to RTC CMOS.

Type "N" will return to Setup Utility.

## Appendix

### Appendix A : VIA Chipsets Driver Installation

#### A.VIA 4 in 1 Service Pack Utility:

Insert the support CD that came with your motherboard into your CD-ROM driver or double –click the CD driver icon in My Computer to bring up the screen.

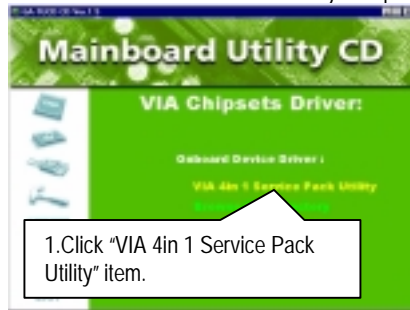

(1)

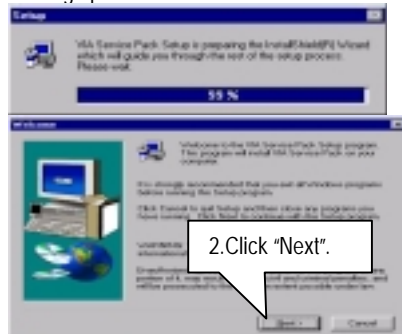

(2)

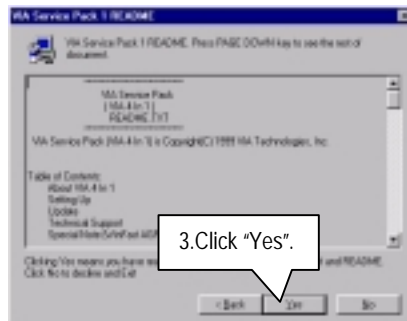

(3)

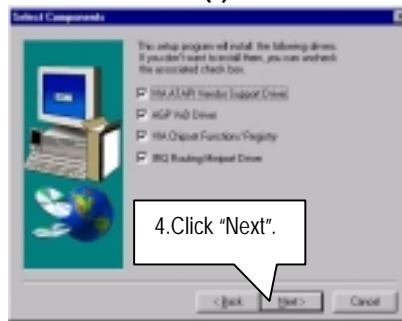

(4)

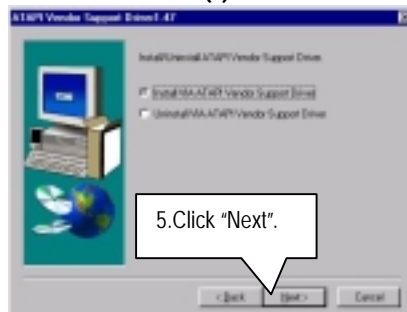

(5)

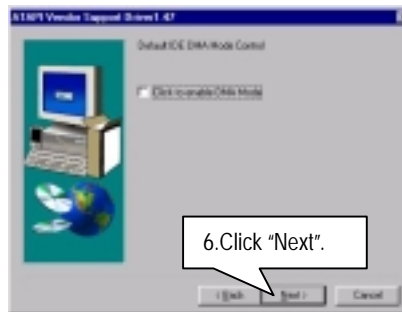

(6)



(7)

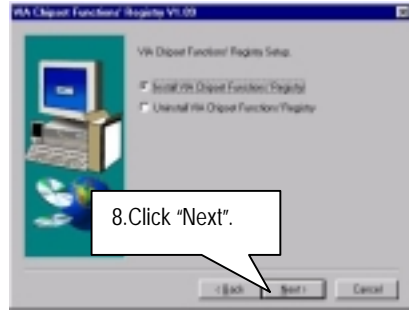

(8)

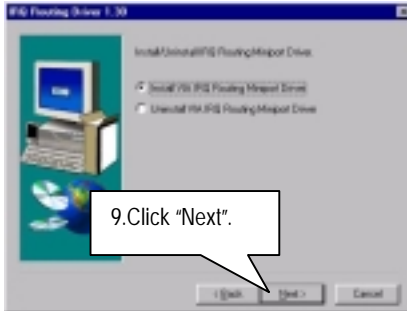

(9)

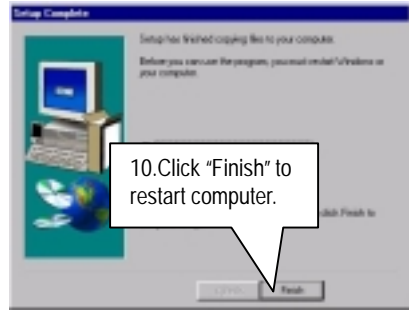

(10)



## Appendix B: VIA Sound Driver

### A. AC'97 Audio Driver:

Insert the support CD that came with your motherboard into your CD-ROM driver or double-click the CD driver icon in My Computer to bring up the screen.

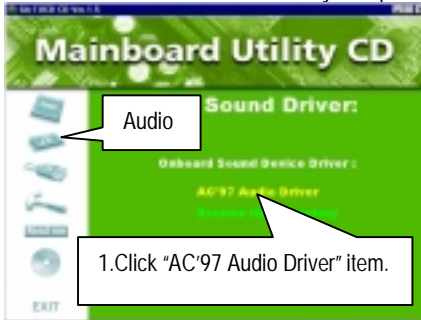

(1)

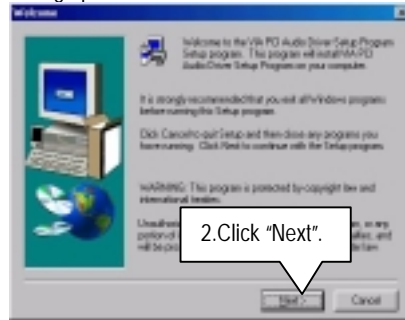

(2)

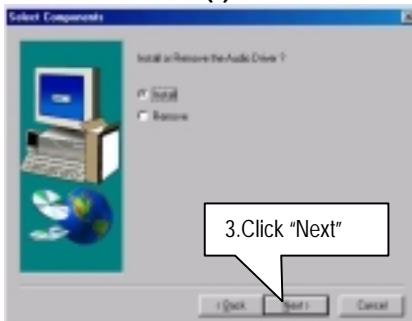

(3)

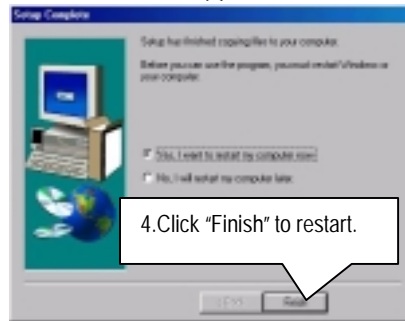

(4)

### Appendix C: Creative Sound Driver Installation (Optional)

Insert the support CD that came with your motherboard into your CD-ROM driver or double-click the CD driver icon in My Computer to bring up the screen.

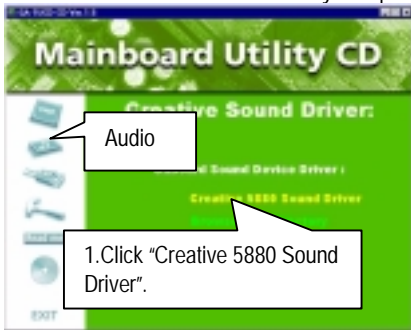

(1)

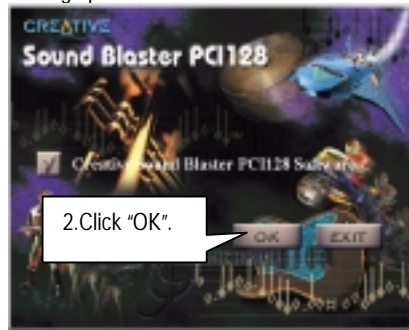

(2)

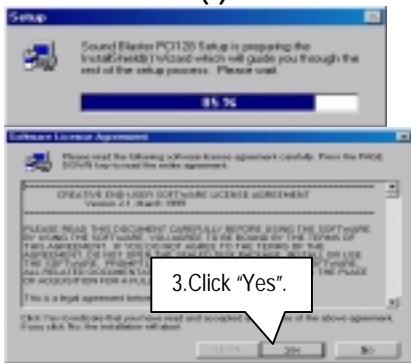

(3)

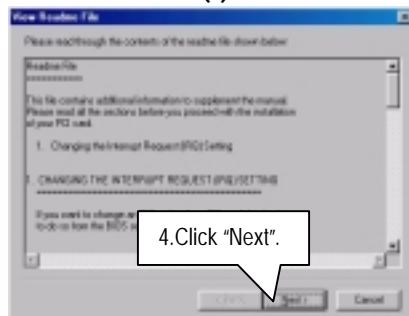

(4)

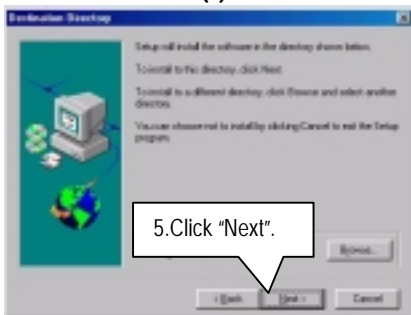

(5)

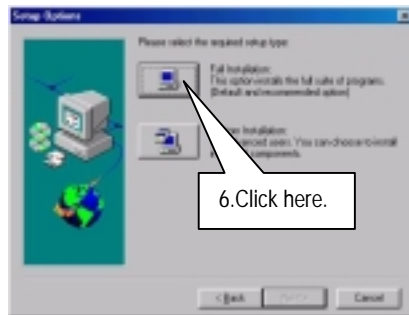

(6)



(7)

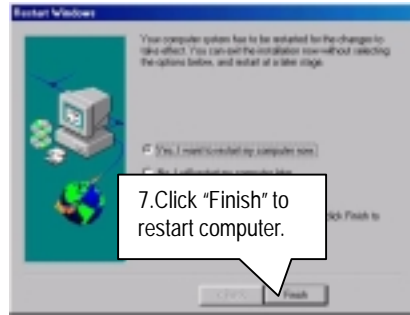

(8)

## Appendix D: BIOS Flash Procedure

BIOS update procedure:

- ✓ Please check your BIOS vendor (AMI or AWARD) on the motherboard.
- ✓ It is recommended you copy the AWDFlash.exe or AMIFlash.exe in driver CD (D:\>Utility\BIOSFlash) and the BIOS binary files into the directory you made in your hard disk. 【 i.e:C:\>Utility\ (C:\>Utility : denotes the driver and the directory where you put the flash utilities and BIOS file in.) 】
- ✓ Restart your computer into MS-DOS mode or command prompt only for Win95/98, go into the directory where the new BIOS file are located use the utility AWDFlash.exe or AMIFlash.exe to update the BIOS.
- ✓ Type the following command once you have enter the directory where all the files are located C:\utility\ AWDFlash or AMIFlash <filename of the BIOS binary file intended for flashing>
- ✓ Once the process is finished, reboot the system

● Note: Please download the newest BIOS from our website ([www.gigabyte.com.tw](http://www.gigabyte.com.tw)) or contact your local dealer for the file.

## Appendix E: Acronyms

Acro.	Meaning
ACPI	Advanced Configuration and Power Interface
POST	Power-On Self Test
LAN	Local Area Network
ECP	Extended Capabilities Port
APM	Advanced Power Management
DMA	Direct Memory Access
MHz	Megahertz
ESCD	Extended System Configuration Data
CPU	Central Processing Unit
SMP	Symmetric Multi-Processing
USB	Universal Serial Bus
OS	Operating System
ECC	Error Checking and Correcting
IDE	Integrated Dual Channel Enhanced
SCI	Special Circumstance Instructions
LBA	Logical Block Addressing
EMC	Electromagnetic Compatibility
BIOS	Basic Input / Output System
SMI	System Management Interrupt
IRO	Interrupt Request
NIC	Network Interface Card
A.G.P.	Accelerated Graphics Port
S.E.C.C.	Single Edge Contact Cartridge
LED	Light Emitting Diode
EPP	Enhanced Parallel Port
CMOS	Complementary Metal Oxide Semiconductor
I/O	Input / Output
ESD	Electrostatic Discharge
OEM	Original Equipment Manufacturer
SRAM	Static Random Access Memory
VID	Voltage ID
DMI	Desktop Management Interface
MIDI	Musical Interface Digital Interface
IOAPIC	Input Output Advanced Programmable Input Controller
DIMM	Dual Inline Memory Module
DRAM	Dynamic Random Access Memory
PAC	PCI A.G.P. Controller
AMR	Audio Modem Riser

To be continued...

## 6VX7B-4X Motherboard

---

Acro.	Meaning
PCI	Peripheral Component Interconnect
RIMM	Rambus in-line Memory Module
DRM	Dual Retention Mechanism
ISA	Industry Standard Architecture
MTH	Memory Translator Hub
CRIMM	Continuity RIMM