

6BX/ZX/VIA82

User's Manual Version 1.3

The information presented in this publication has been made carefully for reliability; however, no responsibility is assumed for inaccuracies. Specifications are subject to change without notice.

IBM, PC/AT, and PC/XT are trademarks of International Business Machines Corporation.

Pentium is a trademark of Intel Corporation

AWARD is a registered trademark of Award Software Inc.

MS-DOS and WINDOWS NT are registered trademarks of Microsoft Corporation.

Trademarks and/or registered trademarks are the properties of their respective owners.

Table of Contents

Chapter 1	Introduction	1
	How this manual is organized	1
	Package checklist	2
Chapter 2	Features	3
	Features of the mainboard	3
	The mainboard layout	6
Chapter 3	Installation	7
	System Installation Setups	9
	Static Electricity Precaution	9
	Jumper Settings	10
	System Memory (DIMM modules)	12
	DIMM Memory Installation	13
	CPU Installation	15
	Selecting the CPU Frequency	16
	Clearance Requirements	16
	Fan Exhaust	16
	External Connectors	17

Note:

If there is any change in the content please refer to our website. Regarding the BIOS setting & Driver installation, refer the web site please. (www.acorp.com.tw)

Chapter 1

1

Introduction

How This Manual is Organized

This manual is divided into the following sections:

Chapter 1 Introduction : Manual information and checklist.

Chapter 2 Features : Information and Specifications concerning this mainboard.

Chapter 3 Installation : Instructions on setting up the board.

Package Checklist

Please check that your package is complete . If you discover any item damaged or missing , please contact with your retailer immediately.

- ⌚ The 6BX/ZX/VIA82 mainboard.
- ⌚ 1 x IDE ribbon cable.
- ⌚ 1 x floppy ribbon cable.
- ⌚ 6BX/ZX/VIA82 support software:
 - Flash Memory Write utility to update the FLASH BIOS.
 - Technical Support Form.
- ⌚ This user's Manual

Chapter 2

2

Features

Features of the 6BX/ZX/VIA82 Mainboard

The 6BX/ZX/VIA82 is designed for the PC user's who want many new key features processed by the fastest CPU in a economic package. This mainboard :

- ⌘ **New general CPU support :**
 - Socket 370 Celeron (300MHz~677MHz(1.5V))processor.
 - Socket 370 Coppermine (500MHz~800MHz)processor.
 - CPU clock select support for 66/100MHz.

- ∞ **Chipset :**
Intel 440BX PCIset™ /440ZX PCIset™/VIA 693+596A (6VIA82) chips with I/O subsystems.
- ∞ **Biggest memory capacity :**
6BX/VIA82 is equipped with three DIMM socket to support (16MB, 32MB, 64MB, 128MB.256MB) 168 pin 3.3v SDRAM SPD(Special Presence Detect).Maximum memory up to 768MB.
6ZX82 is equipped with two DIMM socket to support 168 pin 3.3v SDRAM SPD(Special Presence Detect).Maximum memory up to 512MB.
- ∞ **AGP for fast VGA solution :**
AGP (Accelerator Graphic Port) will enhance & improve display performance and Application. The bus speed is 66 MHz .
- ∞ **ISA & PCI Expansion Slot :**
Provide one 16 bit ISA, and three 32 bit PCI slots.
- ∞ **PCI Bus MasterIDE Controller :**
Comes with an on-board PCI Bus Master IDE, controller with two connectors that supports four IDE devices in two channels, Provides faster data transfer rate, and supports Enhanced IDE devices such as Tape Backup and CD-ROM devices(ATAPI). This controller supports PIO mode 3 and 4 (16.6MB/sec.), and Ultra DMA 33(33MB/Sec.), also supports ZIP100 and LS-120. BIOS support IDE CD-ROM or SCSI bootup.

∞ **Super Multi-I/O :**

Provides two high-speed UART2 compatible serial ports (match NS16C550A compatible) and one parallel port with SPP,EPP and ECP capabilities. UART2 can also be directed from COM2 to the Infrared Module for wireless connections. Two floppy drives of either 5.25" or 3.5 "(1.25MB,1.44MB or 2.88MB) are also supported without an external card. Supports Japanese standard "Floppy 3 mode" (3.5" 1.25MB).

∞ **CPU built-in Level 2 Cache :**

128/256KB Pipeline Burst Level 2 cache in the PII/III CPU processors.

∞ **WOL (Wake On LAN) :**

Supports system power up from LAN ring up .

∞ **IrDA Port :**

Support this serial fast communication up to 115.2Kbps.

∞ **Support Ring on by modem/Alarm on :**

Support System power up from Modem ring up or timer of System. Required enabled in Ring on by modem and Alarm on in BIOS.

∞ To support CPU FAN On/Off and LED indicator under Suspend mode.

∞ **To support CPU temperature detect and Alarm warning by sound. (option)**

∞ **Dimension : 24.3 cm x 19.0 cm**

The 6BX/ZX/VIA82 Mainboard layout

6ZX82 only two DIMM sockets

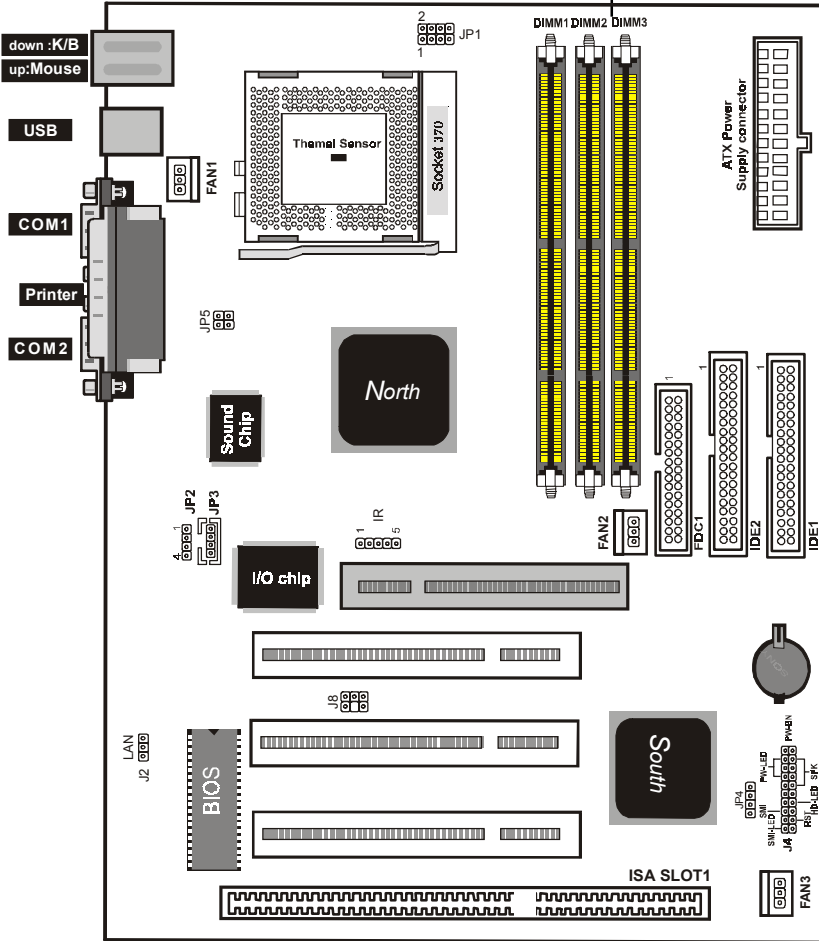

Chapter 3

3

Installation

Jumper

Jumper		Refer to page
◆ JP4	- Real time Clock RTC clean	11
◆ J4	- HDD LED	22
◆ J4	- Reset Switch	22
◆ J4	- Power LED	22
◆ J4	- SMI Suspend switch	22
◆ J4	- Speaker Connector	23
◆ J4	- ATX Power switch	23
◆ J2	- LAN Card Wake Up	24
◆ JP1	- CPU Type selector Jumper	25

Expansion Slot

Which page

◆ 168 pin DIMM Socket	13
◆ Socket 370	15
◆ AGP (Accelerator Graphic port) SLOT	17
◆ PCI SLOT 1,2,3 -32bits PCI SLOT	17
◆ ISA SLOT1 - 16bits ISA SLOT	17

Connectors

Refer to page

◆ KB1(UP) - PS/2 Mouse port.	18
◆ KB1(DP) - PS/2 Keyboard port	18
◆ USB - USB1,2 Port	18
◆ COM1 - COM 1 serial port	18
◆ COM2 - COM 2 serial port	18
◆ LPT1 - Parallel port	18
◆ FDC1 - FLOPPY connector	18
◆ FAN1 - FAN CONN. for CPU	19
◆ FAN2 - FAN CONN. for AGP	19
◆ FAN3 - FAN CONN. for Case	19
◆ IDE1 - Primary IDE connector	20
◆ IDE2 - Secondary IDE connector	20
◆ IR(J1) - IrDA connector	21
◆ PW1 - ATX Power Connector	23

System Installation Setup

Before using your computer, you must finish the following steps:

1. Set jumpers on mainboard
2. Install SDRAM module.
3. Install the Processor.
4. Connect Ribbon Cables, Cabinet Wires, and Power supply.
5. Install Add on Cards.
6. Setup the BIOS software.





Static Electricity Precaution

- ⌚ Keep the mainboard and other system components in their anti-static packaging until you are ready to install them.
- ⌚ Do all preparative work on a static-free surface with the main board components facing up.
- ⌚ Unplug your computer when working on the inside.
- ⌚ Wear an Anti-static wrist strap.
- ⌚ Hold the system components, boards or cards by its edges only. Be careful not to touch any of IC chips, circuitry, contacts or connections, especially gold contacts on the mainboard.

Jumper Settings

Jumpers

Several hardware settings are made through the use of jumper caps to connect jumper pins (Jxx) on the mainboard. See "Map of the mainboard" for the location of the jumpers.

The jumper settings will be described numerically such as [----], [1-2], [2-3] for no connection, connect pins 1 & 2, and connect pins 2 & 3 respectively. Pin 1 for our mainboard is always on top one or on the left when holding the mainboard with the keyboard away from yourself. "P1" is written besides pin 1 on jumper with three pins. The jumpers will also be shown graphically such as  to connect pin 1 & 2 and  to connect 2 & 3. Jumpers with two pins will be shown as  for Short (on) and  for Open (off). For manufacturing simplicity it may be sharing pins from other groups. Use the diagrams in this manual instead of following the pin layout on the board. Settings with two jumper numbers require that both jumpers be moved together. To connect the pin, simply place a plastic jumper cap over the two pins as diagrammed.

Real Time Clock (RTC) RAM - JP4 :

The CMOS RAM is powered by the onboard button cell battery. To clear the RTC data:

(1) Turn off your computer, (2) Move this jumper to "3-4Pin Clear Data", (3) Move the jumper back to "Default", (4) Turn on your computer, (5) Hold down <Delete > during bootup and enter BIOS setup to re-enter user Preferences.

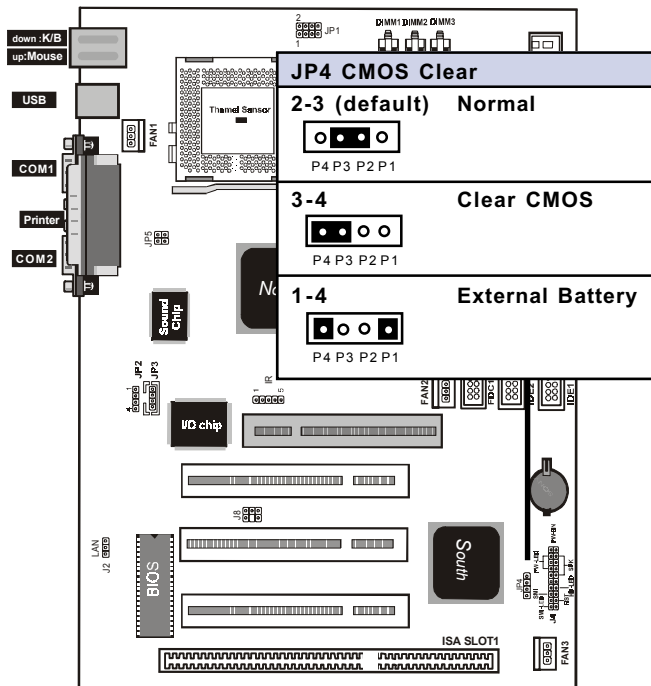

System Memory (DIMM Module)

This **6BX/ZX/VIA82** main board supports three 168 pins DIMM (Dual Inline Memory Module) (**6ZX82 supports two DIMMs**) of 16 MB, 32 MB, 64 MB, 128 MB ,256MB to form a memory size between 16MB to 256MB.

The DRAM can be either 45ns,50ns,or 60ns 3.3v SDRAM,and 3.3v Enhanced Data Output (EDO) RAM.

Install memory in any or all Banks in Combination:

Bank	Memory module
DIMM 1	16MB,32MB,64MB,128MB,256MB
(Bank 0-1)	168 pin,3.3v SDRAM / EDO RAM
DIMM 2	16MB,32MB,64MB,128MB,256MB
(Bank 2-3)	168 pin 3.3v,SDRAM / EDO RAM
DIMM 3	16MB,32MB,64MB,128MB,256MB
(Bank 4-5)	168 pin 3.3v,SDRAM / EDO RAM
	Total System Memory(Max 768MB)

Note :

- ◆ The DIMM Slot does not support any 5v EDO DIMM module.
- ◆ The DIMM Slot does not support any 5v SDRAM DIMM module.
- ◆ Memory speed setup is required through "Auto Configuration" in BIOS chipset Setup of BIOS SOFTWARE. If several speed memorious are used, You must set Auto Configuration to low. Example If both 50ns, 60ns are used, Please set Auto configuration to 60ns.
- ◆ It's allowed any DIMM module put in any DIMM slot. It's allowed there are different capacity DIMM module in all DIMM slot.

DIMM Memory Installation

Insert the module (s) as shown. Because the number pins are different on either side of the breaks, the module will only fit in the orientation as shown. SDRAM DIMM modules have different pin contacts on each side and therefore have a higher pin density.

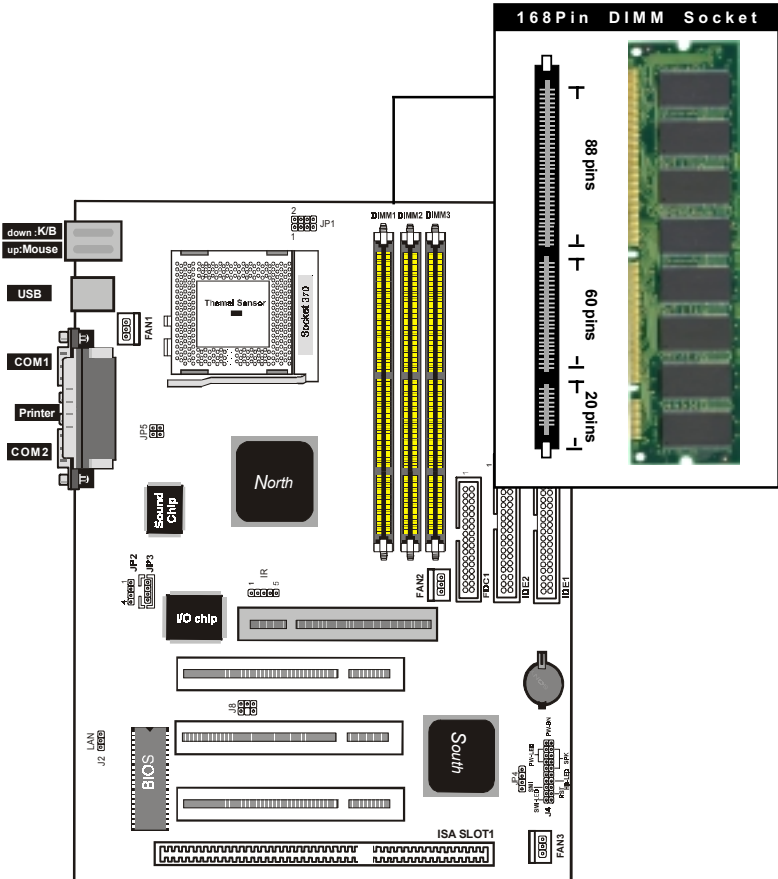

The Dual Inline Memory Module (DIMM) memory module must be 3.3v Extended Data Output (EDO) DRAM or SDRAM. You can identify the type of DIMM module by the illustration below:

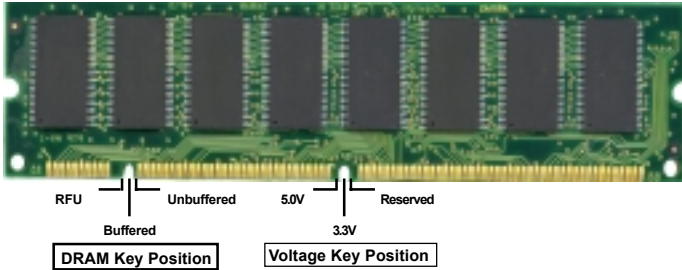

168 Pin DRAM DIMM Notch Key Definitions

The notch on the DIMM module will shift between left, center, or right to identify the type and also to prevent the wrong type to be inserted into the DIMM slot on the Mainboard. You must ask your retailer for Specifications before purchasing.

Four clock signals are supported on this mainboard

CPU Installation

The motherboard provides a ZIF socket 370. The CPU that came with the motherboard should have a fan attached to it to prevent overheating . If this is not the case then purchase a fan before you turn on your system.

To install a CPU , first turn off your system and remove its cover. Locate the ZIF socket and open it by first pulling the lever sideways away from the socket then upwards to a 90-degree right angle. Insert the CPU with the correct orientation shown . The notched corner should point towards end of the lever. Because the CPU has a corner pin for two of the four corners, the CPU will only fit in the orientation as shown.

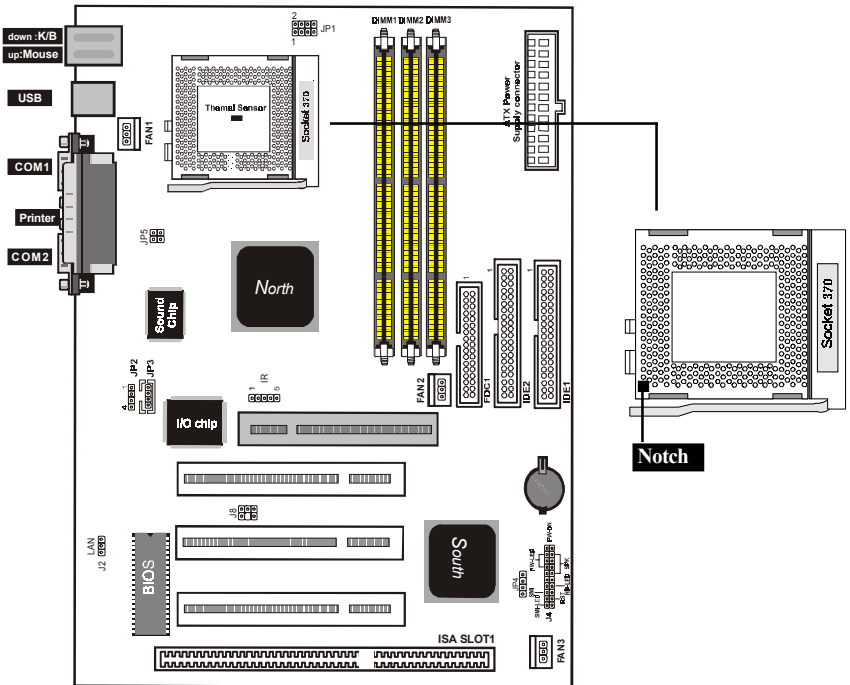

Selecting the CPU Frequency

CPU voltage auto-detection and allow user to set CPU frequency through BIOS setup, no jumper or switch is needed. The correct CPU information is saved into EPROM, with these technologies, the disadvantages of Pentium base jumper-less design are eliminated. There will be no worry of wrong CPU voltage detection . The CPU frequency selection is set by going into:

Choose “**CPU SPEED SETTING**” from the Main Menu and a screen with a list of items appears.

CPU Speed

Set to Manual user can use the next two items to decide the CPU speed.

CPU Ratio:TO BIOS "CPU Speed setting " item

This item lets you select the ratio of Core/Bus frequency. Have the following selection: 3x, 3.5x, 4x, 4.5x, 5x, 5.5x, 6x, 6.5x, 7.0x, 7.5x

CPU Frequency :JPI (CPU Type Selector)

This item lets you set external clock (bus clock). The possible settings are 66,100 and 133 MHZ....

Clearance Requirements

To maintain proper airflow once the processor is installed on the mainboard, the processor and fan heatsink require certain space clearances. The clearance above the processor must be at least 0.3 inch. The clearance on at least 3 of 4 sides of the processor and fan heatsink must be at least 0.2 inch. All cables (for Floppy drive,Hard drive,CD-ROM,and so on) must be routed clear of the processor and its airspace.

Fan Exhaust

The processor must be kept cool by using a processor with heatsink and fan attached . The temperature of the air filled with the fan/heatsink cannot exceed 45 °C(113 °F) . The ambient or room temperature must be below 37 °C (99 °F) .

EXTERNAL CONNECTORS

Both Ribbon cable and Connectors on board are with direction signs to avoid that user insert wrong direction. On other hand, the ribbon cables should always be connected with the red stripe on the pin 1 of side of the connector.

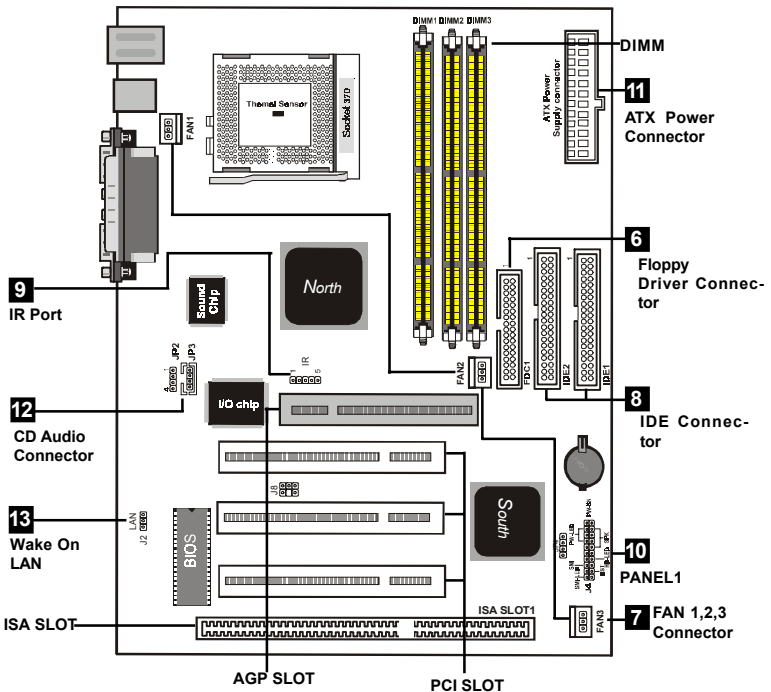
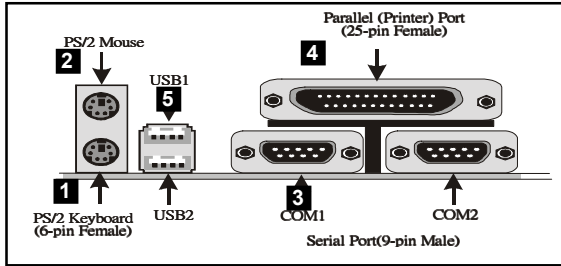

1. PS/2 Keyboard port

This connection is for a standard keyboard using an PS/2 plug (mini DIN) . This connector will not allow standard AT size (large DIN) keyboard plugs. You may use a DIN to mini DIN adapter on standard AT keyboards.

2. PS/2 Mouse port

This system will direct IRQ12 to PS/2 mouse.

3. Serial Port COM 1 and COM 2 port

The two serial ports can be used for pointing devices or other serial devices. See "Onboard Serial Port" in chipset Feature Setup of the BIOS SOFTWARE.

NOTE:

Serial {D-type 25pin (F) } must be connected to the serial port.

4. Parallel Printer port

You can enable the parallel port and choose the IRQ through " Onboard Parallel Port" in Chipset. Feature Setup of the BIOS SOFTWARE.

5. Universal Serial BUS Ports 1 & 2

Two USB ports are available for connecting USB devices.

6. Floppy drive connector

This connector supports the provided floppy drive ribbon cable. After connecting the single end to the board, connect the two plus on the other end to the floppy drives.

7. FAN1 , FAN2 , FAN3 CPU Cooling Fan (FAN/PWR)

These connectors support cooling fans of 500mAmp (6Watt) or less. Orientate the fans so that the heat sink fins allow airflow to go across the onboard heat sink(s) instead of the expansion slots. Depending on the fan manufacturer, the wiring and plug may be different. The red wire should be positive, while the black should be ground. Connect the fan's plug to the board taking into consideration the polarity of this connector.

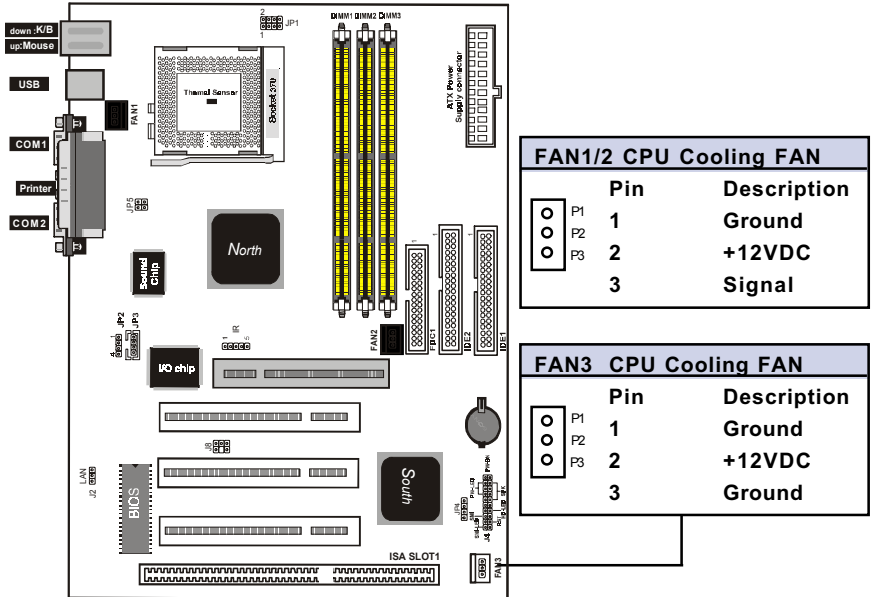

NOTE :

The "Rotation" signal is to be used only by a specially designed fan with rotation signal.

WARNING :

The CPU and/or motherboard will overheat if there is no air flowing across the CPU and onboard heatsinks. Damage may occur to the motherboard and/or the CPU fan if these pins are incorrectly used. These are not jumpers, do not place jumper caps over these pins.

8. **Primary / Secondary IDE connectors (Two 40-pin Blocks)**

These connectors support the provided IDE hard disk ribbon cable. After connecting the single end to the board, connect the two plugs at the other end to your hard disk no space(s) . If you install two hard disks, you must configure the second drive to Slave mode by setting its jumper settings. BIOS now supports SCSI device or IDE CD-ROM boot up (see "HDD Sequence SCSI/IDE First" & "Boot Sequence" in the BIOS Features Setup of the BIOS SOFTWARE) (Pin 20 is removed to prevent inserting in the wrong orientation when using ribbon cables with pin 20 plugged).

Note :

You may configure two hard disks to be both Masters using one ribbon cable on the primary IDE connector. You may install one operating system on an IDE drive and another on a SCSI drive and select right one the through BIOS Feature Setup.

9. IrDA / Fast IR-Compliant infrared module connector - IR(J1)

This connector supports the optional wireless transmitting and receiving infrared module. This module mounts to a small opening on system cases that support this feature. You must also configure the setting through “UART2 Use Infrared” in Chipset Feature Setup to select whether UART2 is directed for use with COM2 or IrDA. Use the five pins as shown on the Back View and connect a ribbon cable from the module to the motherboard according to the pin definitions.

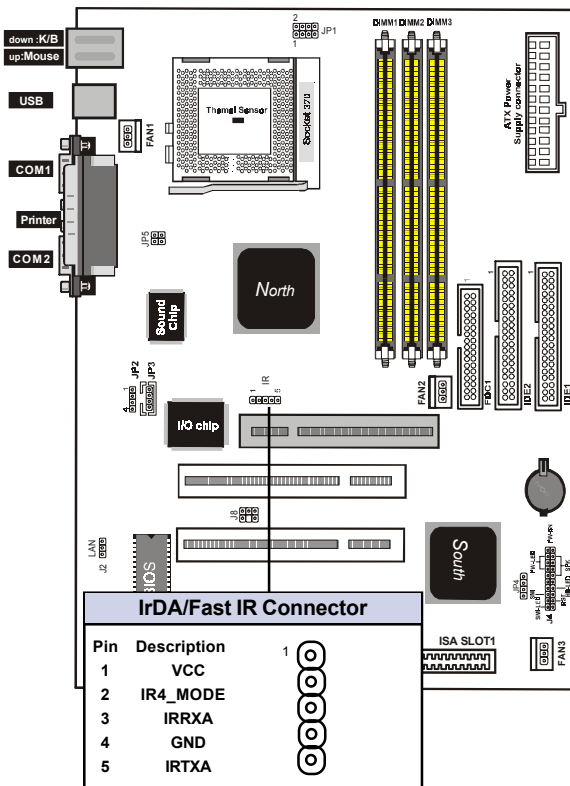

10.J4

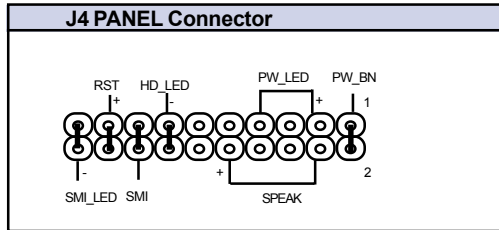

a. IDE activity LED (HD-LED)

This connector supplies power to the cabinet's IDE activity LED. Read and write activity by devices connected to the Primary or Secondary IDE connectors will cause the LED to light up.

b. Power LED Lead (PW_LED)

The system power LED lights when the system's power is on.

c. SMI Suspend Switch Lead (SMI)

This allows the user to manually place the system into a suspend mode or "Green" mode where systematic activity will be instantly decreased to save electricity and expand the life of certain components when the system is not in use. This 2-pin connector (see the figure below) connects to the case-mounted suspend switch. If you do not have a switch for the connector, you may use the "Turbo Switch" since it does not have a function. SMI is activated when it detects a short to open moment and therefore leaving it shorted will not cause any problems. It may require one or two pushes depending on the position of the switch. Wake-up can be controlled by settings in the BIOS but the keyboard will always allow wake-up (the SMI lead cannot wake-up the system). If you want to use this connector, "Suspend Switch" in the Power Management Setup of the BIOS SOFTWARE section should be on the default setting of Enable

d. Reset Switch Lead (RST)

This 2-pin connector connects to the case-mounted reset switch for rebooting your computer without having to turn off your power switch. This is a preferred method of rebooting in order to prolong the life of the system's power supply.

e. **Speaker Connector (SPEAKER)**

This 4-pin connector connects to the case-mounted speaker.

f. **ATX Power Switch (PW_BN)**

The system power is controlled by a momentary switch connected to this lead. Pushing the button once will switch the system ON. The system power LED lights when the system's power is on

11. **ATX Power Supply Connector (20-pin block) - PW1**

This connector connects to a ATX power supply. The plug from the power supply will only insert in one orientation because of the different hole sizes. Find the proper orientation and push down firmly making sure that the pins are aligned.

IMPORTANT:

Make sure that the ATX power supply can take at least 10mAmp load on the 5Volt standby lead (5VSB). You may experience difficulty in powering on your system without this.

Pin	Description	Pin	Description
1	3.3V	2	3.3V
3	GND	4	5V
5	GND	6	5V
7	GND	8	PW-OK
9	5VSB	10	12V
11	3.3V	12	-12V
13	GND	14	PS-ON
15	GND	16	GND
17	GND	18	-5V
19	5V	20	5V

12. Wake On LAN : J2

This connector connects LAN cards and a Wake On LAN output. When the system is in soft-off mode LAN activity will power on the system.

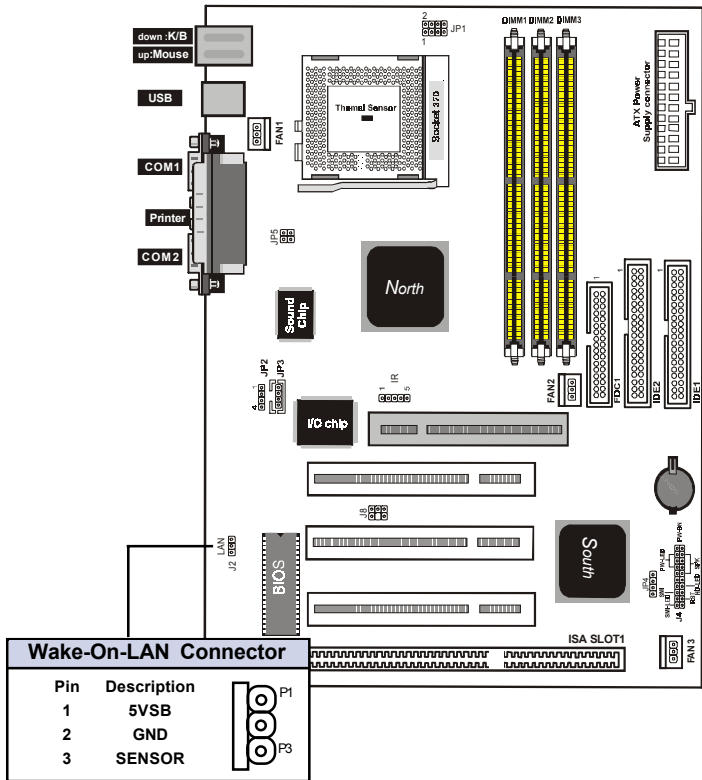

13. CPU Type Selector jumper : JP1

CPU Type Selecto	JP1				
66 MHZ	1-2	3-4	5-6	7-8	ON
100MHZ	1-2	3-4	7-8		ON
133MHZ	1-2	3-4			ON

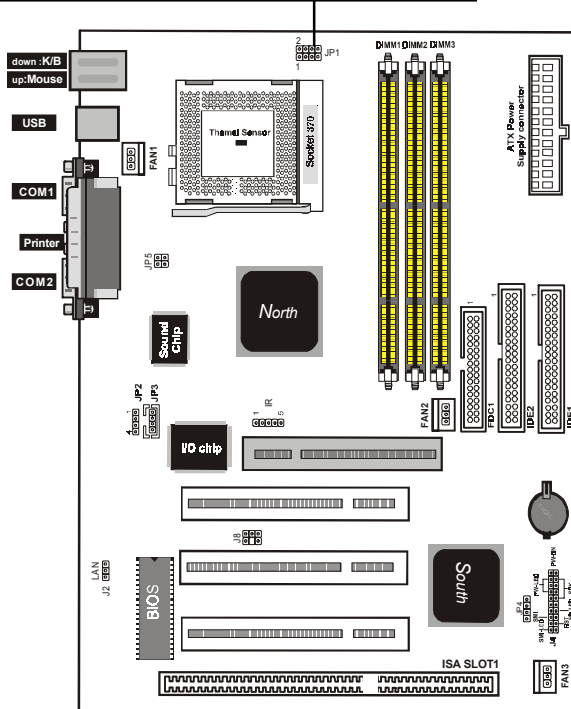

Date : / /

Guarantee Sheet/Technical Fault Report

M/B Model No.: _____ Vender

Serial No. : _____

Date of Purchasing: _____

Hardware Configuration Used :

CPU	
RAM	
Video Card	
Hard Drive	
Other Card	

Diagnostic Software Used :

--

Fault Description :

--

Technical Support :

WWW : www.acorp.com.tw

FAE : fae@acorp.com.tw