

6PLEF

User's Manual Version 1.0

The information presented in this publication has been made carefully for reliability; however, no responsibility is assumed for inaccuracies. Specifications are subject to change without notice.

IBM, PC/AT, and PC/XT are trademarks of International Business Machines Corporation.

Socket370 is a trademark of Intel Corporation

AWARD is a registered trademark of Phoenix Software Inc.

MS-DOS and WINDOWS NT are registered trademarks of Microsoft Corporation.

Trademarks and/or registered trademarks are the properties of their respective owners.

Table of Contents

Introduction

1. Motherboard Description

1.1 Features	
1.1.1 Hardware	1-2
1.1.2 Software	1-4
1.1.3 Attachments	1-4
1.2 Motherboard Installation	
1.2.1 Motherboard Map	1-5
1.2.2 Motherboard Layout	1-6
1.3 Motherboard Connectors	
1.3.1 Front Panel Connectors(PANEL)	1-8
1.3.2 Floppy Disk Connector(FDD)	1-9
1.3.3 Hard Disk Connectors(IDE1/IDE2)	1-9
1.3.4 ATX 20-pin Power Connector(ATX)	1-10
1.3.5 Infrared Connector(IR)	1-10
1.4 Back Panel Connectors	
1.4.1 PS/2 Mouse/Keyboard CONN.	1-11
1.4.2 USB Connectors(USB1/USB2)	1-11
1.4.3 VGA Interface Connector(VGA)	1-12
1.4.4 RJ-45 Connector	1-12
1.5 Serial and Parallel Interface ports	1-13
1.6 CPU Installation	
1.6.1 CPU Installation Product(Socket 370)	1-15
1.6.2 CPU Clock Frequency Setting(JCK1/JBSEL1&2)	1-16
1.7 Jumper Setting	
1.7.1 CPU Fan Connector(FAN1/2)	1-17
1.7.2 Wake-On-Modem Header(WOM)	1-18
1.7.3 Wake-On-LAN Header(WOL)	1-18
1.7.4 AC'97 Codec Selection(J1)	1-18
1.7.5 CMOS Function Selection(CMOS)	1-18
1.8 DRAM Installation	
1.8.1 DIMM	1-19

Table of Contents

1.8.2	How to install a DIMM Module	1-19
1.9	Audio Subsystem	
1.9.1	CD-Audio-IN Connectors(CDIN1/CDIN2)	1-20
1.9.2	TV-OUT Connector(TV-OUT)	1-21
1.10	Smart Panel Onboard Connector	
1.10.1	Port 80 Debug Function(SP-J6)	1-22
1.10.2	Second BIOS Connector(SP-J2)	1-22
1.10.3	Suspend Mode / Voice Debug(SP-J3)	1-22
1.10.4	AUX Line(SP-J5)	1-23
1.10.5	FSB Adjust(JCK1)	1-23
2.	BIOS Setup	
2.1	Main Menu	2-4
2.2	Standard CMOS Features	2-7
2.3	Advanced BIOS Features	2-10
2.4	Advanced Chipset Features	2-14
2.5	Integrated Peripherals	2-18
2.6	Power Management Setup	2-23
2.7	FnP/PCI Configurations	2-29
2.8	PC Health Status	2-33
2.9	Frequency/Voltage Control	2-34
2.10	Load Fail-Safe Defaults	2-35
2.11	Load Optimized Defaults	2-36
2.12	Set Supervisor/user Password	2-37
2.13	Save & Exit Setup	2-39
2.14	Exit Without Saving	2-40
3.	Driver Installation	
3.1	Main Menu	3-1
3.2	Installing VIA 4 in 1 Driver	3-2
3.3	Installing Audio Driver	3-3
3.4	Installing Hardware Monitoring Utility	3-5
3.5	Installing VGA Driver	3-6
3.6	Installing TV-OUT Connector Function	3-9
3.7	Installing LAN Driver	3-13

Introduction

System Overview

This manual was written to help you start using this product as quickly and smoothly as possible. Inside, you will find the answers to solve most problems. In order for this reference material to be of greatest use, refer to the “expanded table of contents” to find relevant topics.

This board provides a total PC solution by incorporating the System , I/O , and PCI IDE. The mainboard is designed for Intel PIII/Celeron/Coppermine processors base PC ATX system, support single processors with AMR Bus, PCI Local Bus to support upgrades to your system performance. It is ideal for multi-tasking and fully supports MS-DOS, Windows, Windows NT , Windows ME, Windows 2000 , Novell, OS/2, Windows95/98 , UNIX , Windows 98SE , SCO UNIX etc.

This manual also explains how to install the mainboard for operation, and how to setup your CMOS configuration with the BIOS setup program.

1.Motherboard Description

1.1 Features

1.1.1 Hardware

CPU

- Socket 370 for Intel Celeron/PIII Processors.
- Intel FC-PGA/PPGA Celeron Processors 600MHz~900MHz or higher processor with 66/100MHz FSB.
- Intel Coppermine Pentium III Processors 500MHz~1GHz or higher processor with 100/133MHz FSB.
- VIA Cyrix III Processor with 100/133MHz FSB.

DRAM Memory

- Supports 8/16/32/64....MB DIMM module socket.
- Supports Synchronous DRAM(3.3V)
- Supports a maximum memory size of 1GB with SDRAM.

Flash Memory

- Support 2/4MB flash memory.
- Support ESCD Function.

Green Function

- Support power management operation VIA BIOS.
- Power down timer from 1 to 15 mins.
- Wakes from power saving sleep mode at the press of any key or any mouse activity.

Universal Serial Bus

- Supports two back Universal Serial Bus(USB)Ports and two front Universal serial Bus(USB)Ports.

Bus Slots

- Provide one AMR slot.
- Two 32-bit PCI bus.

Hardware Monitor Function

- CPU Fan Speed Monitor.
- CPU Temperature Monitor.
- System Voltage Monitor.

TV-OUT

- Onboard VIA VT1621.
- Support NTSC/PAL TV output.
- Support composite, S-Video output.
- support 600*480 / 800*600 resolution.

IDE Bulit-in On Board

- Supports four IDE devices.
- Supports PIO Mode 5, Master Mode, high performance hard disk drives.
- Support Ultra DMA 33/66/100 Bus Master Mode.
- Supports IDE interface with CD-ROM.
- Supports high capacity hard disk drives.
- Support LBA mode.

Network

- Onboard Realtek 8100.
- Support 10/100Mb/s operation.
- Support wake on LAN function and remote wake up.

PCI-Based AC 97 Digital Audio Processor

- AC 97 2.1 interface.
- 16 channels of high-quality sample rate conversion.
- 16x8 channel digital mixer.
- Stereo 10 band graphic equalizer.
- Sound Blaster and Sound Blaster Pro emulation.

Smart Panel

- Supports BIOS Port 80H POST Code output to debug LED.

I/O Built-in On Board

- Supports one multi-mode Parallel Port.
 - (1)Standard & Bidirection Parallel Port
 - (2)Enhanced Parallel Port (EPP)
 - (3)Extended Capabilities Port
- Supports two serial ports, 16550 UART.
- Supports one Infrared transmission (IR).
- Supports PS/2 mouse and PS/2 Keyboard.
- Support VGA Port Interface.
- Supports 360KB, 720KB, 1.2MB, 1.44MB, and 2.88MB floppy disk drivers.

1.1.2 Software

BIOS

- AWARD legal BIOS.
- Supports APM 1.2.
- Supports USB Function.
- Supports ACPI

Operation System

- Supporting the highest performance for MS-DOS, Windows, Windows NT, Windows 2000, Windows ME, Novell, OS/2, Windows 95/98, Windows 98 SE, UNIX, SCO UNIX etc.

1.1.3 Attachments

- HDD UDMA66/100 Cable.
- FDD Cable.
- Flash Memory Written for BIOS Update.
- USB2 Cable (**Option**).
- TV-OUT Cable (**Option**).
- Fully Setup CD Driver built in Utility(Ghost, Anitivirus, Adobe Acrobat).
- This Manual.

1.2 Motherboard Installation

1.2.1 Motherboard Map



1.2.2 Motherboard Layout

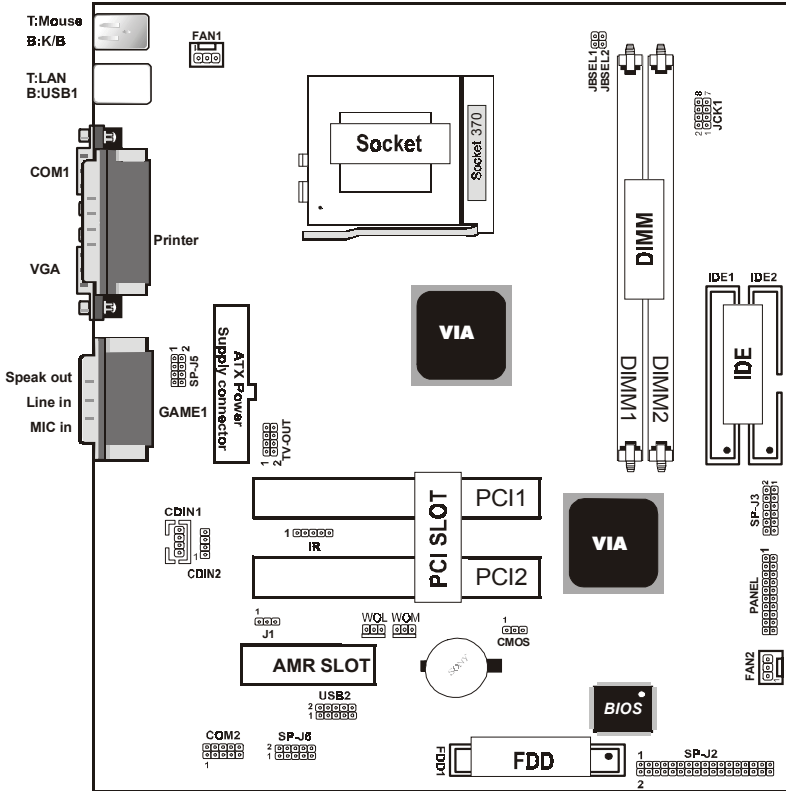

1.3 Motherboard Connectors

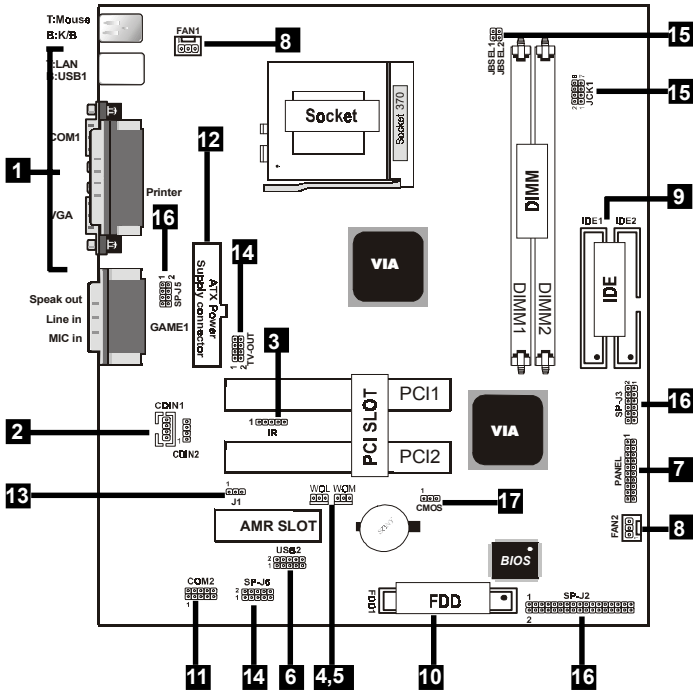

- | | |
|---|----------------------------|
| 1. Back Panel I/O Connectors | 2. CD Audio-In Connector |
| 3. IR Connector | 4. Wake-On-LAN Connector |
| 5. Wake-On-MODEM Connector | 6. Front USB2 Connector |
| 7. Front Panel Connector | 8. Fan Connectors (Fan1/2) |
| 9. IDE Connectors | 10. Floppy Connector |
| 11. Front COM2 Connector | 12. ATX Power Connector |
| 13. AC' 97 CODEC Selection (J1) | 14. TV-OUT Connector |
| 15. CPU Clock Setting (JCK1/JBSEL1/JBSEL2) | |
| 16. Smart Panel Function (SP-J2/SP-J3/SP-J6) (option) | |
| 17. CMOS Function Selection (CMOS) | |

1.3.1 Front Panel Connector (PANEL)

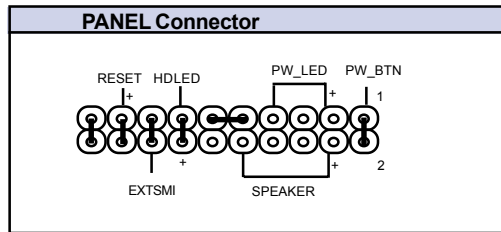

Speaker Connector (SPEAKER)

An offboard speaker can be installed onto the motherboard as a manufacturing option. An offboard speaker can be connected to the motherboard at the front panel connector. The speaker (onboard or offboard) provides error beep code information during the Power Self-Test when the computer cannot use the video interface. The speaker is not connected to the audio subsystem and does not receive output from the audio subsystem.

Hard Drive LED Connector (HDLED)

This connector supplies power to the cabinet IDE activity LED. Read and write activity by devices connected to the Primary or Secondary IDE connectors will cause the LED to light up.

SMI Suspend Switch Lead (EXTSMI)

This allows the user to manually place the system into a suspend mode of Green mode. System activity will be instantly decreased to save electricity and expand the life of certain components when the system is not in use. This 2-pin connector (see the figure) connects to the case-mounted suspend switch. If you do not have a switch for the connector, you may use the "Turbo Switch" instead since it does not have a function. SMI is activated when it detects a short. It may require one or two pushes depending on the position of the switch. Wake-up can be controlled by settings in the BIOS but the keyboard will always allow wake-up (the SMI Suspend Switch Lead cannot wake-up the system). If you want to use this connector, the "Suspend Switch" in the Power Management Setup of the BIOS SOFTWARE section should be on the default setting of Enable.

ATX Power Switch (PW_BN)

The system power is controlled by a momentary switch connected to this lead. Pushing the button once will switch the system ON. The system power LED lights when the system's power is on .

Power LED Lead (PW_LED)

The system power LED lights when the system power is on.

Reset Switch Lead (RESET)

The connector can be connected to a momentary SPST type switch that is normally open. When the switch is closed, the motherboard resets and runs the POST.

1.3.2 Floppy Disk Connector (FDD)

This connector supports the provided floppy drive ribbon cable. After connecting the single end to the board, connect the two plugs on the other end to the floppy drives.

1.3.3 Hard Disk Connectors (IDE1/IDE2)

These connectors support the provided IDE hard disk ribbon cable. After connecting the single end to the board, connect the two plugs at the other end to your hard disk.

If you install two hard disks, you must configure the second drive to Slave mode by setting its jumper settings. BIOS now supports SCSI device or IDE CD-ROM boot up (see "HDD Sequence SCSI/IDE First" & "Boot Sequence" in the BIOS Features Setup of the BIOS SOFTWARE) (Pin 20 is removed to prevent inserting in the wrong orientation when using ribbon cables with pin 20 plugged) .

1.3.4 ATX 20-pin Power Connector (ATX)

This connector supports the power button on-board. Using the ATX power supply, functions such as Modem Ring Wake-Up and Soft Power Off are supported on this motherboard. This power connector supports instant power-on functionality, which means that the system will boot up instantly when the power connector is inserted on the board.

Pin	Signal	Pin	Signal
1	3.3V	11	3.3V
2	3.3V	12	-12V
3	GND	13	GND
4	5V	14	PS-ON
5	GND	15	GND
6	5V	16	GND
7	GND	17	GND
8	PW-OK	18	-5V
9	5V_SB	19	5V
10	12V	20	5V

1.3.5 Infrared Connector (IR)

After the IrDA interface is configured, files can be transferred from or to portable devices such as laptops, PDAs, and printers using application software.

1.4 Back Panel Connectors

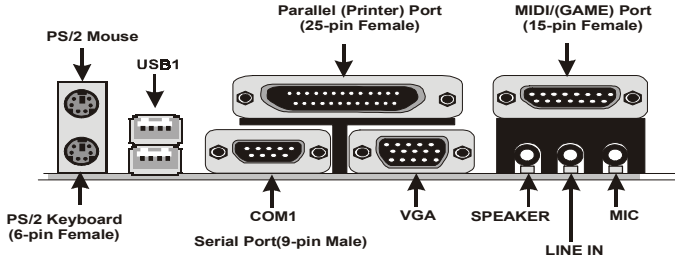

1.4.1 PS/2 Mouse /Keyboard CONN.

The motherboard provides a standard PS/2 mouse / Keyboard mini DIN connector for attaching a PS/2 mouse. You can plug a PS/2 mouse / Keyboard directly into this connector.

1.4.2 USB Connectors: USB1+RJ-45

The motherboard provides a OHCI(Open Host Controller Interface)Universal Serial Bus Roots for attaching USB devices such as a keyboard, mouse and other USB devices. You can plug the USB devices directly into this connector.



Pin	Signal
1	+5V_SB
2	USBP0-(USBP1-)
3	USBP0+(USBP1+)
4	GND



Pin	Signal
1	+5V_SB
2	USBP0-(USBP1-)
3	USBP0+(USBP1+)
4	GND
RJ45	10/100M LAN Port

Front Two USB Connectors: USB2

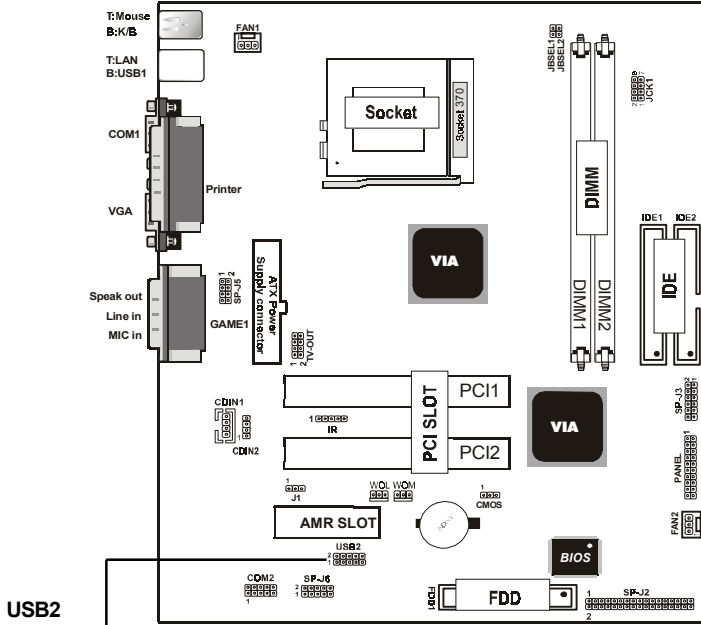

1.4.3 VGA Interface Connector:VGA(15 Pin)

This connector is for output to VGA-compatible devices.



1.4.4 RJ-45 Connector

Onboard 10/100MB PCI Fast Ethernet Network.
 The RJ-45 connector is located on top of the USB connectors.
 The connector allows the motherboard to connect to a Local Area Network (LAN) through a network hub .

1.5 Serial and Parallel Interface Ports

This system comes equipped with two serial ports and one parallel port. Both types of interface ports will be explained in this chapter.

The Serial Interfaces: COM1/COM2

The serial interface port is sometimes referred to as an RS-232 port or an asynchronous communication port. Mice, printers, modems and other peripheral devices can be connected to a serial port. The serial port can also be used to connect your computer system. If you wish to transfer the contents of your hard disk to another system it can be accomplished by using each machine's serial port.



The serial port on this system has one 9-pin connector. Some older computer systems and peripherals used to be equipped with only a 25-pin connector. Should you need to connect your 9-pin serial port to an older 25-pin serial port, you can purchase a 9-to-25 pin adapter.

Signal	DB9 Pin	DB25 Pin
DCD	1	8
RX	2	3
TX	3	2
DTR	4	20
GND	5	7
DSR	6	6
RTS	7	4
CTS	8	5
RI	9	22

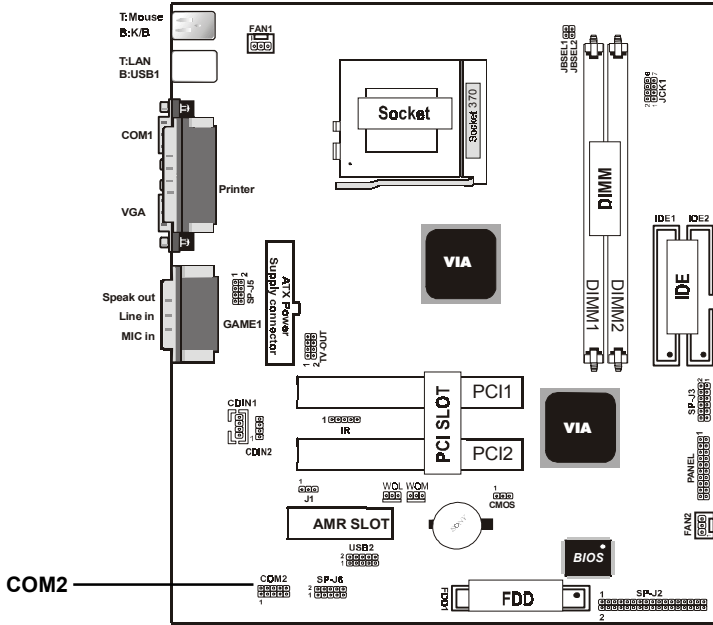

Parallel Interface Port

Unlike serial ports, parallel interface ports have been standardized and should not present any difficulty interfacing peripherals to your system. Sometimes called a Centronics port, the parallel port is almost exclusively used with printers. The parallel port on your system has a 25-pin, DB 25 connector(see the picture below).

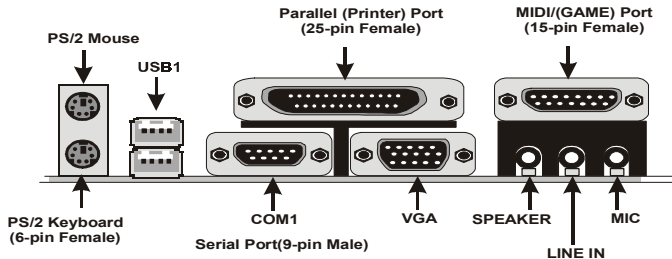

1.6 CPU Installation

1.6.1 CPU Installation Procedure: Socket 370

1. Pull the lever sideways away from the socket then raise the lever to a 90-degree angle.
2. Locate Pin 1 in the socket and look for the white dot or cut edge in the CPU. Match Pin 1 with the white dot/cut edge then insert the CPU.
3. Press the lever down to complete the installation.
4. **Make sure the spec of the heatsink is good enough.**

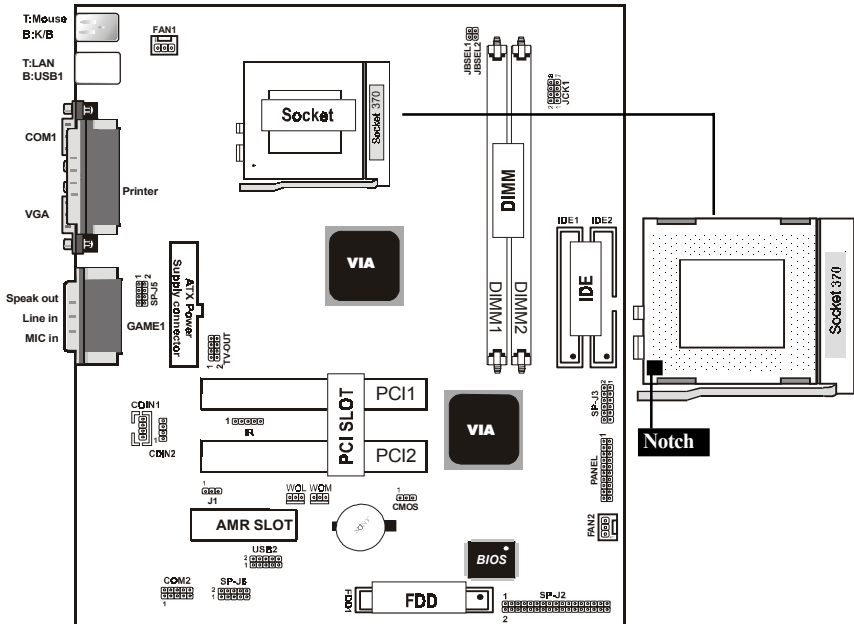

1.6.2 CPU Clock Frequency Setting: JCK1/JBSEL1&2

Overclocking is operating a CPU/Processor beyond its specified frequency. JCK1 jumper is used for the CPU Front Side Bus Frequencies from 100MHz to 133MHz.

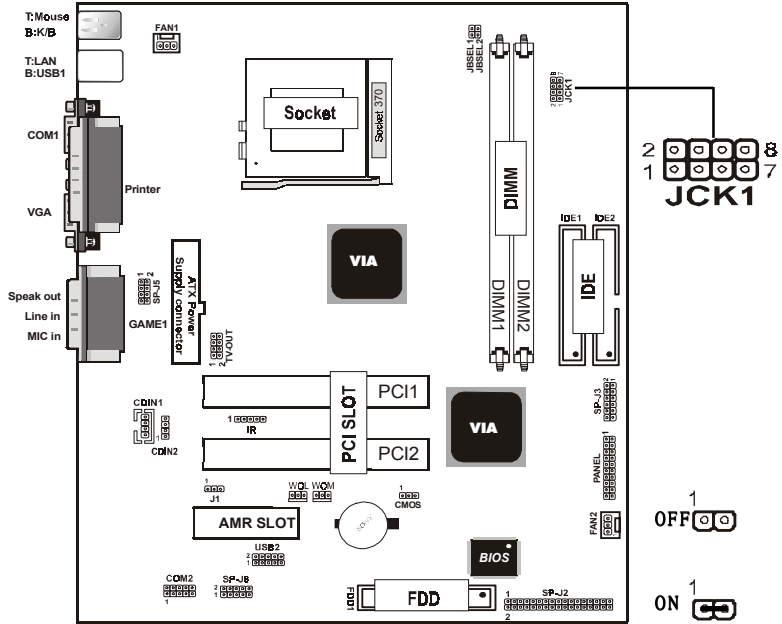

JBSEL1	JBSEL2	JCK1				Bus Freq.
		1-2	3-4	5-6	7-8	
OFF	OFF	OFF	OFF	OFF	OFF	133MHz
OFF	OFF	OFF	ON	OFF	OFF	100MHz
OFF	OFF	ON	ON	OFF	OFF	66MHz
ON	ON	OFF	OFF	ON	ON	Auto

1.7 Jumper Setting

A jumper has two or more pins that can be covered by a plastic jumper cap, allowing you to select different system options.

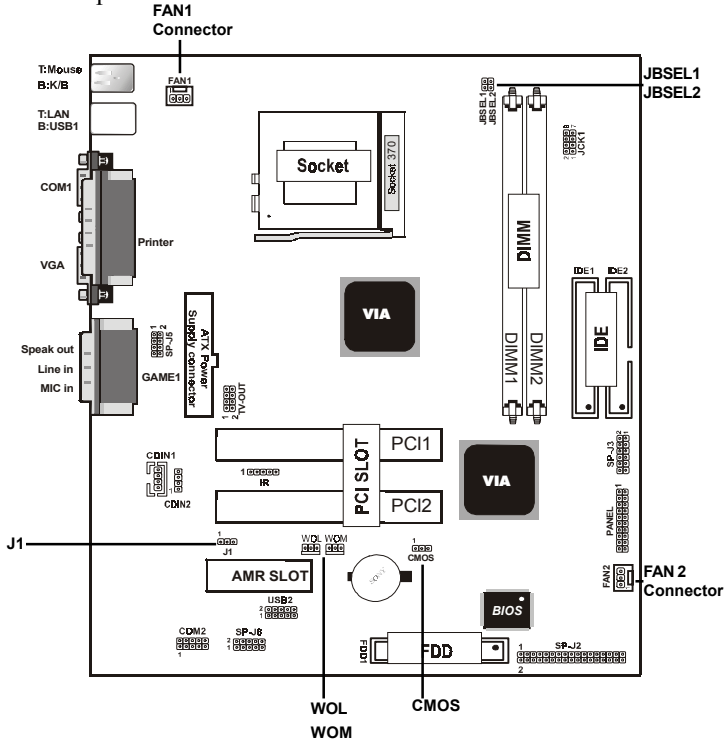

1.7.1 CPU/System Fan Connector: Fan1/2

Pin	Assignment
1	Ground
2	+12VDC
3	Signal

1.7.2 Wake-On Modem Header: WOM

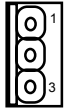
Pin	Assignment
 1	5V_SB
2	Ground
3	Signal

1.7.3 Wake-On LAN Header: WOL

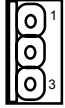
Pin	Assignment
 1	5V_SB
2	Ground
3	Signal

1.7.4 AC'97 CODEC Selection: J1

Pin	Assignment
1-2	On board CODEC is used (Default)
2-3	Disabled

1.7.5 CMOS Function Selection:CMOS

Pin	Assignment
1-2	Normal (Default)
2-3	Clear CMOS

NOTE:

(Please follow the procedure below to clear CMOS data.)
 (1)Remove the AC power line.(2)CMOS(2-3)Closed.(3)Wait five seconds.(4)CMOS(1-2) Closed.(5)AC Power on.(6)Reset your desired password or clear CMOS data.

1.8 DRAM Installation

1.8.1 DIMM

DRAM Access Time: 3.3V Unbuffered SDRAM/ PC66/
PC100 and PC133 Type required.

DRAM Type: 8MB, 16MB, 32MB, 64MB, 128MB, 256MB,
512MB DIMM Module.(168 pin)

Bank	Memory module
DIMM 1 (Bank 0-1)	16MB, 32MB, 64MB, 128MB, 256MB, 512MB 168 pin,3.3v SDRAM
DIMM 2 (Bank 2-3)	16MB, 32MB, 64MB, 128MB, 256MB, 512MB 168 pin 3.3v,SDRAM
	Total System Memory (Max 1GB)

1.8.2 How to install a DIMM Module

1. The DIMM socket has a “Plastic Safety Tab” and the DIMM memory module has an asymmetrical notch”, so the DIMM memory module can only fit into the slot in one direction.
2. Push the tabs out. Insert the DIMM memory modules into the socket at a 90-degree angle then push down vertically so that it will fit into place.
3. The Mounting Holes and plastic tabs should fit over the edge and hold the DIMM memory modules in place.

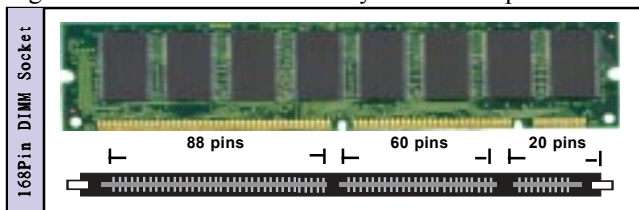

1.9 Audio Subsystem

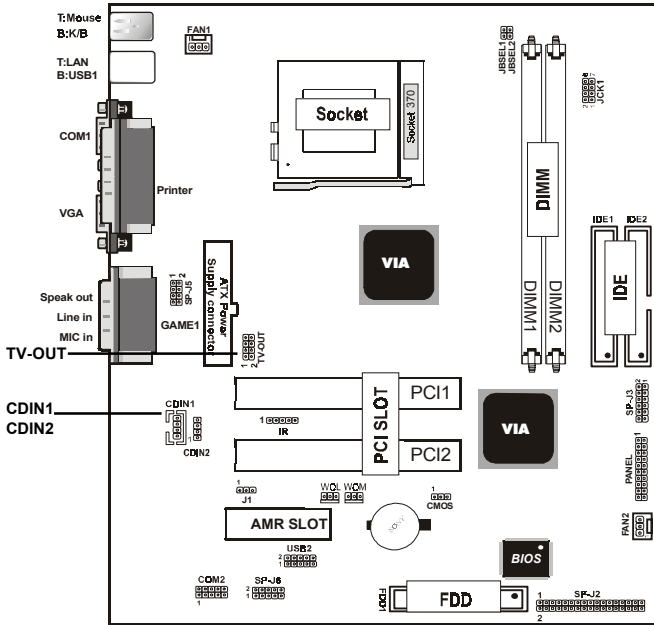

1.9.1 CD Audio-in Connectors: CDIN1/CDIN2

Pin CDIN1	Assignment
1	CD-L
2	GND
3	GND
4	CD-R

Pin CDIN2	Assignment
1	CD-L
2	GND
3	GND
4	CD-R

1.9.2 TV-OUT Connector: TV-OUT

Pin TV-OUT	Assignment	Pin TV-OUT	Assignment
1	GND	2	C_OUT
3	GND	4	NC
5	Y_OUT	6	CVBS
7	GND	8	GND

1.10 Smart Panel Onboard Connector

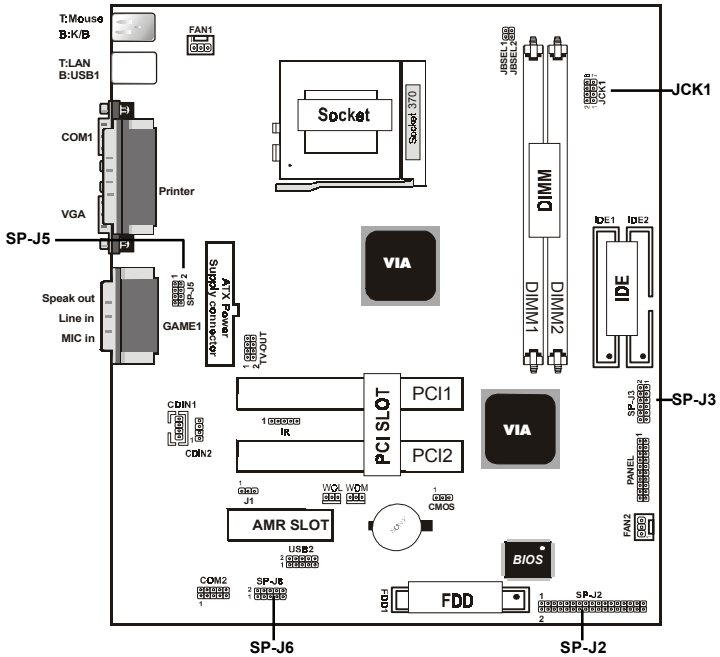

Note:
 The motherboard provides the pin leads for Smart Panel. If you want POST Error Code or Smart Panel function, please refer to Smart Panel (SPPLEF) manual.

1.10.1 Port 80 Debug Function: SP-J6

For Smart Panel connector(SP-J6) to M/B (SP-J6)

Pin SP-J6	Assignment	Pin SP-J6	Assignment
1	ERD4	2	ERD0
3	ERD5	4	ERD1
5	ERD6	6	ERD2
7	ERD7	8	ERD3
9	GND	10	NC

1.10.2 Second BIOS Connector: SP-J2

For Smart Panel connector(SP-J2) to M/B (SP-J2)

Pin SP-J2	Assignment	Pin SP-J2	Assignment
1	SD0	2	+5V
3	SD1	4	SA0
5	SD2	6	SA1
7	SD3	8	SA2
9	SD4	10	SA3
11	SD5	12	SA4
13	SD6	14	SA5
15	SD7	16	SA6
17	GND	18	DISABLE
19	ROMCS-	20	SA7
21	MEMR-	22	SA8
23	MEMW-	24	SA9
25	SA18	26	SA10
27	SA17	28	SA11
29	SA16	30	SA12
31	SA15	32	SA13
33	+5V	34	SA14

1.10.3 Suspend Mode / Voice Debug: SP-J3

For Smart Panel connector(SP-J3) to M/B (SP-J3)

Pin SP-J3	Assignment	Pin SP-J3	Assignment
1	5V_SB	2	GND
3	GPO0	4	S3+
5	SUSA	6	GND
7	-PCISTP	8	S5+
9	SPEAKOUT	10	GPIOD
11	GND	12	-PCIRST

1.10.4 AUX Line: SP-J5

For Smart Panel connector(SP-J5) to M/B (SP-J5)

Pin SP-J5	Assignment	Pin SP-J5	Assignment
1	LINE_OUT_L	2	LINE_OUT_R
3	LINE_IN_L	4	LINE_IN_R
5	MIC_IN_L	6	MIC_IN_R

1.10.5 FSB Adjust: JCK1

For Smart Panel connector(JCK1) to M/B (JCK1)

Pin JCK1	Assignment	Pin JCK1	Assignment
5	133/100 ADJ	6	GND
3	GND	4	GND

2. BIOS Setup

Introduction

This manual discussed the Award Setup program built into the ROM BIOS. The Setup program allows the user to modify the basic system configuration. This special information is then stored in battery-backed RAM so that it retains the setup information when the power is turned off.

The Award BIOS installed in your computer system's ROM (Read Only Memory) is a custom version of an industry standard BIOS. This means that it supports Intel PIII/Celeron/Coppermine & VIA Cyrix processors input/output system. The BIOS provides critical low-level support for standard devices such as disk drives and serial and parallel ports. The rest of this manual is intended to guide you through the process of configuring your system using Setup.

Plug and Play Support

This AWARD BIOS supports the Plug and Play Version 1.0A specification. ESCD(Extended System Configuration Data)write is supported.

EPA Green PC Support

This AWARD BIOS supports Version 1.03 of the EPA Green PC specification.

APM Support

This AWARD BIOS supports Version 1.1&1.2 of the Advanced Power Management(APM) specification. Power management features are implemented via the System Management Interrupt(SMI). Sleep and Suspend power management modes are supported. Power to the hard disk drives and video monitors can be managed by this AWARD BIOS.

PCI Bus Support

This AWARD BIOS also supports Version 2.1 of the Intel PCI (Peripheral Component Interconnect)local bus specification.

Support CPU

This AWARD BIOS supports the Intel PIII/Celeron/ Coppermine & VIA Cyrix processor CPU.

Using Setup

In general, you use the arrow keys to highlight items, press <Enter>to select, use the <PgUp>and <PgDn>keys to change entries, press<F1>for help and press <Esc>to quit. The following table provides more detail about how to navigate in the Setup program by using the keyboard.

Note:

(BIOS version 1.0 is for reference only. If there is a change in BIOS version, please use the actual version on the BIOS.)

Keystroke	Function
Up arrow	Move to previous item
Down arrow	Move to next item
Left arrow	Move to the item on the left(menu bar)
Right arrow	Move to the item on the right(menu bar)
Esc	Main Menu: Quit without saving changes Submenus: Exit Current page to the next higher level menu
Move Enter	Move to item you desired
PgUp key	Increase the numeric value or make changes
PgDn key	Decrease the numeric value or make changes
+Key	Increase the numeric value or make changes
-Key	Decrease the numeric value or make changes
Esc Key	Main menu-Quit and not save changes into CMOS Status Page Setup Menu and option Page Setup Menu-Exit Current page and return to Main Menu
F1 Key	General help on Setup navigation keys.
F5 Key	Load previous values from CMOS
F6 Key	Load the fail-safe defaults from BIOS default table
F7 Key	Load the optimized defaults
F10 Key	Save all the CMOS changes and exit

2.1 Main Menu

Once you enter AWARD BIOS CMOS Setup Utility, the Main Menu will appear on the screen. The Main Menu allows you to select from several setup function. Use the arrow keys to select among the items and press<Enter> to accept and enter the sub-menu.

“WARNING”

The information about BIOS defaults on manual (Figure 1,2,3,4,5,6,7,8,9,10,11,12,13,14)is just for reference, please refer to the BIOS installed on the board for updated information.

© Figure 1. Main Menu

CMOS Setup Utility-Copyright(C) 1984-2001 Award Software

Standard CMOS Features	Frequency/Voltage Control
Advanced BIOS Features	Load Fail-Safe Defaults
Advanced Chipset Features	Load Optimized Defaults
Integrated Peripherals	Set Supervisor Password
Power Management Setup	Set User Password
PNP/PCI Configuration	Save & Exit Setup
PC Health Status	Exit Without Saving
Esc : Quit F9 : Menu in BIOS ←→↑↓: Select Item	
F10 : Save & Exit Setup	
Time , Date , Hard Disk Type ...	

Standard CMOS Features

This setup page includes all the items in standard compatible BIOS.

Advanced BIOS Features

This setup page includes all the items of the BIOS special enhanced features.

Advanced Chipset Features

This setup page includes all the items of the Chipset special enhanced features.

Integrated Peripherals

This selection page includes all the items of the IDE hard drive and Programmed Input/Output features.

Power Management Setup

This setup page includes all the items of the power management features.

PnP/PCI Configuration

This setup page includes the user defined or default IRQ Setting.

PC Health Status

This page shows the hardware Monitor information of the system.

Frequency / Voltage Control

This setup page controls the CPU's clock and frequency ratio.

Load Fail-Safe Defaults

Use this menu to load the BIOS default values for the minimal/stable performance for your system to operate.

Load Optimized Defaults

These settings are more likely to configure a workable computer when something is wrong. If you cannot boot the computer successfully, select the BIOS Setup options and try to diagnose the problem after the computer boots. These settings do not provide optional performance.

Set Supervisor Password

Change, set, or, disable password. It allows you to limit access to the system and Setup, or just to Setup.

Set User Password

You can specify both a User and a Supervisor password. When you select either password option, you are prompted for a 1-6 character password. Enter the password and then retype the password when prompted.

Save & Exit Setup

Save CMOS value changes to CMOS and exit setup.

Exit Without Saving

Abandon all CMOS value changes and exit setup.

2.2 Standard CMOS Features

This item in the Standard CMOS Setup Menu is divided into 10 categories. Each category includes no, one or more than one setup items. Use the arrow keys to highlight the item and then use the <PgUp> or <PgDn> keys to select the value you want in each item.

© Figure 2. Standard CMOS Features

CMOS Setup Utility-Copyright(C) 1984-2001 Award Software

Standard CMOS Features

Date(mm:dd:yy)	Tue,Jun 6 2000	Item Help
Time (hh:mm:ss)	11:26:10	
IDE Primary Master	None	Menu Level
IDE Primary Slave		Change the day,
IDE Secondary Master		month,year
IDE Secondary Master	None	and century.
Drive A	1.44M,3.5 in	
Drive B	None	
Video	EGA/VGA	
Halt On	All,But Keyboard	
Base Memory	640K	
Extended Memory	65472K	
Total	1024K	

←→↑↓: Move Enter:Select +/-/PU/PD:Value F10:Save ESC:Exit
 F1:General Help F5:Previous Values F6:Fail-Safe Defaults
 F7:Optimized Defaults

Main Menu Selections

This table shows the selections that you can make on the Main Menu.

Item	Options	Description
Date	Month DD YYYY	Set the system,date. Note that the 'Day' automatically changes when you set the data.
IDE Primary Master	Options are in its sub menu.	Press<Enter> to enter the sub menu of detailed.
IDE Primary Slave	Options are in its sub menu.	Press<Enter> to enter the sub menu of detailed.
IDE Secondary Master	Options are in its sub menu.	Press<Enter> to enter the sub menu of detailed.
IDE Secondary Slave	Options are in its sub menu.	Press<Enter> to enter the sub menu of detailed.
Drive A Drive B	None 360K, 5.25in 1.2M, 5.25in 720K, 3.5in 1.44M, 3.5in 2.88M, 3.5in	Select the type of floppy disk drive installed in your system.
Video	EGA/VGA CGA 40 CGA 80 MONO	Select the default video device.

Item	Options	Description
Halt On	All Errors No Errors All, but Keyboard All, but Diskette All, but Disk/Key	Select the situation in which you want the BIOS to stop the POST process and notify.
Base Memory	N/A	Displays the amount of conventional memory detected during boot up.
Extended Memory	N/A	Displays the amount of conventional memory detected during boot up.
Total Memory	N/A	Displays the total memory available in the system.

2.3 Advanced BIOS Features

© Figure 3. Advanced BIOS Features

CMOS Setup Utility-Copyright(C) 1984-2001 Award Software

Advanced BIOS Features

Virus Warning	Disabled	Item Help
CPU Internal Cache	Enabled	
External Cache	Enabled	Menu Level
CPU L2 Cache ECC Checking	Enabled	
Quick Power On Self Test	Enabled	
First Boot Device	Floppy	Allows you to choose the
Second Boot Device	HDD-0	VIRUS warning
Third Boot Device	LS-120	feature for IDE
Boot Other Device	Enabled	Hard Disk boot
Swap Floppy Drive	Disabled	sector protection.
Boot Up Floppy Seek	Enabled	If this function
Boot Up NumLock Status	On	is enabled and
Gate A20 Option	Normal	someone attempts
Typeomatic Rate Setting	Disabled	to write data into
Typeomatic Rate (Chars/Sec)	6	this area.BIOS
Typeomatic Delay (Msec)	250	will show a
Security Option	Setup	warning message
OS Select For DRAM	Non-OS2	on screen and
Video BIOS Shadow	Enabled	alarm beep
C8000-CBFFF Shadow	Disabled	
CC000-CFFFF Shadow	Disabled	
D0000-D3FFF Shadow	Disabled	
D4000-D7FFF Shadow	Disabled	
D8000-DBFFF Shadow	Disabled	
DC000-DBFFF Shadow	Disabled	
Small Logo(EPA) Show	Disabled	

←→↑↓: Move Enter:Select +/-/PU/PD:Value F10:Save ESC:Exit
 F1:General Help F5:Previous Values F6:Fail-Safe Defaults
 F7:Optimized Defaults

Virus Warning

This option allows you to choose the VIRUS Warning feature for IDE Hard Disk boot sector protection. If this function is enabled and someone attempts to write data into this area, BIOS will show a warning message on screen and alarm beep.

The Choices: Disabled(default), Enabled.

CPU Internal Cache

These two categories speed up memory access. However, it depends on CPU/chipset design.

Enabled (default) Enabled cache.
Disabled Disabled cache.

External Cache

This fields allow you to Enable or Disable the CPU'S "Level 2" secondary cache. Caching allows better performance.

Enabled (default) Enabled cache.
Disabled Disabled cache.

CPU L2 Cache ECC Checking

The item allows you to enable/disable CPU L2 Cache ECC Checking.

The Choices: Enabled(default), Disabled.

Quick Power On Self Test

This category speeds up Power on Self-Test(POST) after you power up the computer. If it is set to Enable, BIOS will shorten or skip some check items during POST.

Enabled (default) Enabled quick POST.
Disabled Normal POST.

First/Secondary/Third Boot Device

This BIOS attempts to load the operating system from the devices in the sequence selected in these items.

The Choices: Floppy, LS120, HDD-0, SCSI, CDROM, HDD-1, HDD-2, HDD-3, ZIP100, LAN, Disabled.

Boot Other Device

The Choices: Enabled(default), Disabled.

Swap Floppy Drive

If the system has two floppy drives, you can swap the logical drive name assignments.

The Choices: **Disabled**(default), Enabled.

Boot Up Floppy Seek

Seek disk drives during boot up. Disabled speeds boot-up.

The Choices: **Enabled**(default), Disabled.

Boot Up NumLock Status

Select power on state for Numlock.

On (default) Numpad is number keys.

Off Numpad is arrow keys.

Gate A20 Option

Select if chipset or keyboard controller should control Gate A20.

Normal (default) A pin in the keyboard controller controls Gate A20.

Fast Lets chipset control Gate A20.

Typematic Rate Setting

Enabled Enabled this option to adjust the keystroke repeat rate.

Disabled (default) Disabled.

Typematic Rate (Char/Sec)

Range between 6(**default**) and 30 characters per second. This option controls the speed of repeating keystrokes.

Typematic Delay (Msec)

This option sets the time interval for displaying the first and the second characters.

The Choices: **250**(default), 500, 750, 1000

Security Option

This category allows you to limit access to the system and Setup, or just to Setup.

System	The system will not boot and access to Setup will be denied if the correct password is not entered in prompt.
Setup (default)	The system will boot, but access to Setup will be denied if the correct password is not entered in prompt.

OS Select For DRAM

Select the operating system that is running with greater than 64MB of RAM on the system.

The Choices: Non-OS2(default), OS2

Video BIOS Shadow

Determines whether video BIOS will be copied to RAM for faster execution.

Enabled (default)	Optional ROM is enabled.
Disabled	Optional ROM is disabled.

C8000-CFFFF Shadow / D0000-DFFFF Shadow

Determines whether video BIOS will be copied to RAM for faster execution.

Enabled	Optional ROM is Shadowed.
Disabled (default)	Optional ROM is not Shadowed.

Note: For C8000-DFFFF option-ROM on PCI BIOS, BIOS will automatically enable the shadow RAM. User does not have to select the item.

Small Logo(EPA) Show

The Choices: Disabled(default), Enabled.

2.4 Advanced Chipset Features

This section allows you to configure the system based on the specific features of the installed chipset. This chipset manages bus speeds and access to system memory resources, such as DRAM and external cache. It also coordinates communications of the PCI bus. It must be stated that these items should never need to be altered. The default settings have been chosen because they provide the best operating conditions for your system. The only time you might consider making any changes would be if you discovered that data was lost while using your system.

© Figure 4. Advanced Chipset Features

CMOS Setup Utility-Copyright(C) 1984-2001 Award Software

Advanced Chipset Features

DRAM Clock	Host CLK	Item Help
DRAM Timary By SPD	Enabled	
SDRAM Cycle Length	3	
Bank Interleave	Disabled	
Memory Hole	Disabled	Menu Level
PCI Master Pipeline Req	Enabled	
P2C/C2P Concurrency	Disabled	
Fast R-W Turn Around	Disabled	
System BIOS Cacheable	Disabled	
Video RAM Cacheable	Disabled	
Frame Buffer Size	8M	
AGP Aperture Size	64M	
On Chip USB	Enabled	
USB Keyboard Support	Disabled	
On Chip Sound	Enabled	
On Chip Modem	Enabled	
CPU to PCI Write Buffer	Enabled	
PCI Dynamic Bursting	Enabled	
PCI Master 0 WS Write	Enabled	
PCI Delay Transaction	Enabled	
PCI #2 Access #1 Retry	Disabled	
AGP Master 1WS Write	Disabled	
AGP Master 1WS Read	Disabled	

←→↑↓: Move Enter:Select +/-/PU/PD:Value F10:Save ESC:Exit
 F1:General Help F5:Previous Values F6:Fail-Safe Defaults
 F7:Optimized Defaults

DRAM Clock

This item determines DRAM Clock following the CPU host clock.

The Choices: Host CLK(default), Host CLK+33M, Host CLK-33M.

DRAM Timary By SPD

The Choices: Enabled(default), Disabled.

SDRAM Cycle Length

When synchronous DRAM is installed, the number of clock cycle of CAS latency depends on the DRAM timing. Do not reset this field from the default value specified by the system designer.

The Choices: 3(default), 2, Auto.

Bank Interleave

The Choices: Disabled(default), Enabled.

Memory Hole

In order to improve performace, certain space in memory can be reserved for ISA cards. This memory must be mapped into the memory's space below 16MB.

The Choices: Diabled(default), Enabled.

PCI Master Pipeline Req

The Choices: Enabled(default), Disabled.

P2C/C2P Concurrency

The item allows you to enable/disable the PCI to CPU to PCI concurrency.

The Choices: Disabled(default), Enabled.

Fast R-W Turn Around

The item controls the DRAM timing.It allows you to enable/disable the fast read/write turn around.

The Choices: Disabled(default), Enabled.

System BIOS Cacheable

When enabled, the access to the system BIOS ROM address at F0000H-FFFFFFH is cached.

The Choices: Disabled(default), Enabled.

Video RAM Cacheable

Enabled Enabled Video RAM Cacheable.

Disabled (default) Disabled Video RAM Cacheable.

Frame Buffer Size

The item onchip VGA share memory size.

The Choices: 8M(default), 4M, 2M, 1M.

AGP Aperture Size

Select the size of the Accelerated Graphic Port(AGP) aperture. The aperture is a portion of the PCI memory address range dedicated for graphics memory address space. Host cycle that hit the aperture range are forwarded to the AGP without any translation.

The Choices: 64M(default), 32M, 16M, 8M, 4M, 128M.

On Chip USB

This should be enabled if your system has a USB installed on the system board and you wish to use it. Even when so equipped, if you add a higher performance controller, you will need to disable this feature.

The Choices: Enabled(default), Disabled.

USB Keyboard Support

Select Enabled if your system contains a Universal Serial Bus(USB) controller and you have a USB keyboard.

The Choices: Disabled(default), Enabled.

On Chip Modem

The item allows you to control the onboard MC97 Modem controller.

The Choices: Enabled(default), Disabled.

On Chip Sound

The default setting of this item utilizes an onboard sound chip for audio output. There is no need to buy and insert a sound card. If a sound card is installed, disable this item.

The Choices: Enabled(default), Disabled

CPU to PCI Write Buffer

When this field is Enabled, write from the CPU to the PCI bus are buffered, to compensate for the speed differences between the CPU and the PCI bus. When Disabled, the are not buffered and the CPU must wait until the write is complete before starting another write cycle.

The Choices: Enabled(default), Disabled.

PCI Dynamic Bursting

The Choices: Enabled(default), Disabled.

PCI Master 0 WS Write

When this field is Enabled, write data to the PCI bus are executed with zero wait states.

The Choices: Enabled(default), Disabled.

PCI Delay Transaction

The Choices: Enabled(default), Disabled.

PCI #2 Access #1 Retry

The Choices: Disabled(default), Enabled.

AGP Master 1WS Write

When Enabled, write data to the AGP (Accelerated Graphic Port) that will be executed with one wait states.

The Choices: Disabled(default), Enabled.

AGP Master 1WS Read

When Enabled, read data to the AGP (Accelerated Graphic Port) that will be executed with one wait states.

The Choices: Disabled(default), Enabled.

2.5 Integrated Peripherals

© Figure 5. Integrated Peripherals

CMOS Setup Utility-Copyright(C) 1984-2001 Award Software

Integrated Peripherals

On-Chip IDE Channel 0	Enabled	Item Help
On-Chip IDE Channel 1	Enabled	
IDE Prefetch Mode	Enabled	Menu Level
Primary Master PIO	Auto	
Primary Slave PIO	Auto	
Secondary Master PIO	Auto	
Secondary Slave PIO	Auto	
Primary Master UDMA	Auto	
Primary Slave UDMA	Auto	
Secondary Master UDMA	Auto	
Secondary Slave UDMA	Auto	
Init Display First	PCI Slot	
IDE HDD Block Mode	Enabled	
Onboard FDD Controller	Enabled	
Onboard Serial Port 1	Auto	
Onboard Serial Port 2	Auto	
UART 2 Mode	Standard	
IR Function Duplex	Half	
RxD,TxD Active	No,Yes	
Onboard Parallel Port	378/IRQ7	
Onboard Parallel Mode	Normal	
ECP Mode Use DMA	3	
Parallel Port EPP Type	EPP1.9	
Onboard Legacy Audio	Enabled	
Sound Blaster	Disabled	
SB I/O Base Address	220H	
SB IRQ Select	IRQ 5	
SB DMA Select	DMA1	
MPU - 401	Disabled	
MPU - 401 I/O Address	330-333H	
Game Port (200-270H)	Enabled	

←→↑↓: Move Enter:Select +/-/PU/PD:Value F10:Save ESC:Exit

F1:General Help F5:Previous Values F6:Fail-Safe Defaults

F7:Optimized Defaults

On-Chip IDE Channel 0

Enabled (default)	Enabled onboard 1st channel IDE port.
Disabled	Disabled onboard 1st channel IDE port.

On-Chip IDE Channel 1

Enabled (default)	Enabled onboard 2nd channel IDE port.
Disabled	Disabled onboard 2nd channel IDE port.

IDE Prefetch Mode

The onboard IDE drive interface supports IDE prefetching, for faster drive access. If you install a primary and or secondary add-in IDE interface, set this field to Disabled if the interface does not support prefetching.

The Choices: Enabled(default), Disabled.

Primary Master PIO(for onboard IDE 1st channel)

Auto (default)	BIOS will automatically detect the IDE HDD Accessing mode.
Mode 0~5	Manually set the IDE Accessing mode.

Primary Slave PIO(for onboard IDE 2nd channel)

Auto (default)	BIOS will automatically detect the IDE HDD Accessing mode.
Mode 0~5	Manually set the IDE Accessing mode.

Secondary Master PIO(for onboard IDE 1st channel)

Auto (default)	BIOS will automatically detect the IDE HDD Accessing mode.
Mode 0~5	Manually set the IDE Accessing mode.

Secondary Slave PIO(for onboard IDE 2nd channel)	
Auto (default)	BIOS will automatically detect the IDE HDD Accessing mode.
Mode 0~5	Manually set the IDE Accessing mode.
Primary Master UDMA	
Auto (default)	BIOS will automatically detect the IDE HDD Accessing mode.
Disabled	Disabled.
Primary Slave UDMA	
Auto (default)	BIOS will automatically detect the IDE HDD Accessing mode.
Disabled	Disabled.
Secondary Master UDMA	
Auto (default)	BIOS will automatically detect the IDE HDD Accessing mode.
Disabled	Disabled.
Secondary Slave UDMA	
Auto (default)	BIOS will automatically detect the IDE HDD Accessing mode.
Disabled	Disabled.
Init Display First	
PCI Slot (default)	Set Init Display First to PCI Slot.
Onboard AGP	Set Init Display First to onboard AGP.

IDE HDD Block Mode

Enabled (default)	Enabled.
Disabled	Disabled.

Onboard FDD Controller

Enabled (default)	Enabled.
Disabled	Disabled.

Onboard Serial Port1/Port2

Select an address and corresponding interrupt for the first and second serial ports.

The Choices: **Auto**(default), (3F8/IRQ4), (2F8/IRQ3), (3E8/IRQ4), (2E8/IRQ3).

UART 2 Mode

This item allows you to select which Infra Red(IR) function of the onboard I/O chip you wish to use.

The Choices: **Standard** (default), SCR, ASKIR.

IR Function Duplex

This item allows you to select which Infra Red(IR) function of the onboard I/O chip you wish to use.

The Choices: **Half** (default), Full.

Onboard Parallel Mode

Normal (default)	
EPP	Using Parallel port as Enhanced Parallel Port.
ECP	Using Parallel port as Extended Capabilities Port.
ECP/EPP	Using Parallel port as ECP/EPP mode.

ECP Mode Use DMA

The Choices: **3**(default), 1.

Onboard Parallel Port

This item allows you to select the I/O address with which to access the onboard parallel port controller.

Disabled.

3BC/IRQ7.

378/IRQ7. (default)

278/IRQ5.

Parallel Port EPP Type

The Choices: 1.9(default), 1.7.

Onboard Legacy Audio

The Choices: Enabled(default), Disabled.

Sound Blaster

The Choices: Disabled(default), Enabled.

SB I/O Base Address

Change the SoundBlaster Pro Base I/O Address settings.

SB IRQ Select

Change the SoundBlaster Pro interrupt signal.

SB DMA Select

Change the SoundBlaster Pro direct memory access setting.

MPU -401

The Choices: Disabled(default), Enabled.

MPU -401 I/O Address(330-333H)

Change the SoundBlaster Pro MPU-401 I/O address.

Game Port (200-270H)

Change the joystick connection address.

The Choices: Enabled(default), Disabled.

2.6 Power Management Setup

The Power Management Setup allows you to configure your system to most effectively save energy while operating in a manner consistent with your own style of computer use.

© Figure 6. Power Management Setup

CMOS Setup Utility-Copyright(C) 1984-2001 Award Software

Power Management Setup

ACPI Function	Enabled	Item Help
Power Management	Press Enter	Menu Level
ACPI Suspend Type	S1(POS)	
PM Control by APM	Yes	
Video Off Option	Suspend->Off	
Video Off Method	V/H SYNC+Blank	
Modem Use IRQ	3	
Soft-Off by PWRBTN	Instant-Off	
Wake Up Events	Press Enter	

←→↑↓: Move Enter:Select +/-/PU/PD:Value F10:Save ESC:Exit
 F1:General Help F5:Previous Values F6:Fail-Safe Defaults
 F7:Optimized Defaults

CMOS Setup Utility-Copyright(C) 1984-2001 Award Software

Power Management

Power Management	User Define	Item Help
HDD Power Down	Disabled	Menu Level
Doze Mode	Disabled	
Suspend Mode	Disabled	

←→↑↓: Move Enter:Select +/-/PU/PD:Value F10:Save ESC:Exit
 F1:General Help F5:Previous Values F6:Fail-Safe Defaults
 F7:Optimized Defaults

ACPI Function

This item display status of the Advanced Configuration and Power Management (ACPI).

Power Management

This category allows you to select the type (or degree) of power saving and is directly related to the following modes.

1. HDD Power Down.
2. Doze Mode.
3. Suspend Mode.

If you highlight the “Press Enter” next to the “Power Management” label and then press the enter key, it will take you to a submenu with the following options:

Power Management

This option allows you to set each mode individually. When not disabled, each of the ranges are from 1 min. to 1 hr. except for HDD Power Down which ranges from 1 min. to 15 min. and disable.

The Choices: User Define (default), Min Saving, Max Saving.

HDD Power Down

By default, this is “Disabled”, meaning that no matter the mode of the rest of the system, the hard drive will remain ready. Otherwise, you have a range of choices from 1 to 15 minutes or Suspend. This means that you can select to have your hard disk drive be turned off after a selected number of minutes or when the rest of the system goes into a suspend mode.

The Choices: Disabled(default).

Doze Mode/Suspend Mode

The **Doze Mode**, and **Suspend Mode** fields set the Period of time after each of these modes activates. At Max Saving, these modes activate sequentially (in the given order) after one minute; at Min Saving after one hour.

The Choices: Disabled(default).

ACPI Suspend Type

The item allows you to select the suspend type under ACPI operating system.

- | | |
|--------------------------|-------------------|
| S1(POS) (default) | Power on Suspend. |
| S3(STR) | Suspend to RAM. |

PM Control by APM

- | | |
|----------------------|--|
| No | System BIOS will ignore APM when Power Management is on. |
| Yes (default) | System BIOS will wait for APM'S prompt before it enters any PM mode. |

Video Off Option

This field determines when to activate the video off feature for monitor power management.

The Choices: Suspend->off(default), Always on.

Video Off Method

This determines the manner in which the monitor is blanked.

- | | |
|------------------------------------|--|
| V/H SYNC+Blank
(default) | This selection will cause the system to turn off the vertical and horizontal synchronization ports and write blanks to the video buffer. |
| Blank Screen | This option only writes blanks to the video buffer. |
| DPMS Support | Initial display power management signaling. |

Modem Use IRQ

This determines the IRQ, which can be applied in Modem use.

- | |
|-------------------------|
| 3 (default) |
| 4/5/7/9/10/11/NA |

Soft-Off by PWRBTN

Pressing the power button for more than 4 seconds forces the system to enter the Soft-Off state when the system has “hung”.

The Choices: Instant-Off(default), Delay 4 Sec.

CMOS Setup Utility-Copyright(C) 1984-2001 Award Software

Wake Up Events

VGA	OFF	Item Help
LPT & COM	LPT/COM	Menu Level
HDD & FDD	ON	
PCI Master	OFF	
Poweron by PCI Card	Disabled	
Wake up On LAN/Ring	Disabled	
RTC Alarm Resume	Disabled	
Date (of Month)	0	
Resume Time (hh:mm:ss)	0 0 0	
IRQs Activity Monitoring	Press Enter	

←→↑↓: Move Enter:Select +/-/PU/PD:Value F10:Save ESC:Exit
 F1:General Help F5:Previous Values F6:Fail-Safe Defaults
 F7:Optimized Defaults

CMOS Setup Utility-Copyright(C) 1984-2001 Award Software

IRQs Activity Monitoring

Primary INTR	ON	Item Help
IRQ 3 (COM2)	Enabled	Menu Level
IRQ 4 (COM1)	Enabled	
IRQ 5 (LPT2)	Enabled	
IRQ 6 (Floppy Disk)	Enabled	
IRQ 7 (LPT1)	Enabled	
IRQ 8 (RTC Alarm)	Disabled	
IRQ 9 (IRQ2 Redir)	Disabled	
IRQ 10 (Reserved)	Disabled	
IRQ 11 (Reserved)	Disabled	
IRQ 12 (PS2/Mouse)	Enabled	
IRQ 13 (Coprocessor)	Enabled	
IRQ 14 (Hard Disk)	Enabled	
IRQ 15 (Reserved)	Disabled	

←→↑↓: Move Enter:Select +/-/PU/PD:Value F10:Save ESC:Exit
 F1:General Help F5:Previous Values F6:Fail-Safe Defaults
 F7:Optimized Defaults

Wake Up Events

If you highlight the “Press Enter” next to the “Wake Up Events” label and then press the enter key, it will take you to a submenu with the following options:

VGA

When set to On, any event occurring at a VGA port will awaken a system which has been powered down.

LPT & COM

When set to On, any event occurring at a COM(serial) / LPT (printer) port will awaken a system which has been powered down.

HDD & FDD

When set to On(default), any event occurring at a hard or floppy drive will awaken a system which has been powered down.

PCI Master

When set to On, any event occurring at a PCI port will awaken a system which has been powered down.

Wake up On LAN/Ring

To use this function, you need a LAN add-on card which supports power on function. It should also support the wake-up on LAN jump. **The Choices: Disabled**(default).

Poweron by PCI Card

To use this function, you need a PCI add-on card which supports power on function. **The Choices: Disabled** (default).

RTC Alarm Resume

When “Enabled”, you can set the date and time at which the RTC (real-time clock) alarm awakens the system from Suspend mode.

Primary INTR

When set to On(default), any event occurring at Primary INTR will awaken a system which has been powered down.

The following is a list of IRQ, Interrupt ReQuests, which can be exempted much as the COM ports and LPT ports above can. When an I/O device wants to gain the attention of the operating system, it signals this by causing an IRQ to occur. When the operating system is ready to respond to the request, it interrupts itself and performs the service. As above, the choices are On and Off. Off is the default. When set On, activity will neither prevent the system from going into a power management mode nor awaken it.

IRQ3	(COM1)
IRQ4	(COM2)
IRQ5	(LPT2)
IRQ6	(Floppy Disk)
IRQ7	(LPT1)
IRQ8	(RTC Alarm)
IRQ9	(IRQ2 Redir)
IRQ10	(Reserved)
IRQ11	(Reserved)
IRQ12	(PS/2 Mouse)
IRQ13	(Coprocessor)
IRQ14	(Hard Disk)
IRQ15	(Reserved)

2.7 PnP/PCI Configurations

This section describes configuring the PCI bus system. PCI or Personal Computer Interconnect, is a system which allows I/O devices to operate at speeds nearing the speed of the CPU itself uses when communicating with its own special components. This section covers some very technical items and it is strongly recommended that only experienced users should make any changes to the default settings.

© Figure 7. PnP/PCI Configurations

CMOS Setup Utility-Copyright(C) 1984-2001 Award Software

PnP/PCI Configurations

PNP OS Installed	No	Item Help
Reset Configuration Data	Disabled	Menu Level
Resources Controlled By	Auto(ESCD)	Select Yes if you are using a Plug and Play capable operating system
IRQ Resources	Press Enter	
DMA Resources	Press Enter	
PCI/VGA Palette Snoop	Disabled	select No if you need the BIOS to configure non-boot devices
Assign IRQ For VGA	Enabled	
Assign IRQ For USB	Enabled	

←→↑↓: Move Enter:Select +/-/PU/PD:Value F10:Save ESC:Exit
 F1:General Help F5:Previous Values F6:Fail-Safe Defaults
 F7:Optimized Defaults

PNP OS Installed

When set to YES, BIOS will only initialize the PnP cards used for booting (VGA, IDE, SCSI). The rest of the cards will be initialized by the PnP operating system like Windows 95. When set to No, BIOS will initialize all the PnP cards. Therefore for non-PnP operating systems (DOS, Netware), this option must be set to No.

Reset Configuration Data

The system BIOS supports the PnP feature so the system needs to record which resource is assigned and proceeds resources from conflict. Every peripheral device has a node, which is called ESCD. This node records which resources are assigned to it. The system needs to record and update ESCD to the memory locations. These locations (4K) are reserved at the system BIOS.

If Disabled (Default) is chosen, the system's ESCD will update only when the new configuration varies from the last one. If Enabled is chosen, the system is forced to update ESCDs and then is automatically set to the "Disabled" mode.

IRQ3	assigned to:PCI/ISA PnP
IRQ4	assigned to:PCI/ISA PnP
IRQ5	assigned to:PCI/ISA PnP
IRQ7	assigned to:PCI/ISA PnP
IRQ9	assigned to:PCI/ISA PnP
IRQ10	assigned to:PCI/ISA PnP
IRQ11	assigned to:PCI/ISA PnP
IRQ12	assigned to:PCI/ISA PnP
IRQ14	assigned to:PCI/ISA PnP
IRQ15	assigned to:PCI/ISA PnP
DMA-0	assigned to:PCI/ISA PnP
DMA-1	assigned to:PCI/ISA PnP
DMA-3	assigned to:PCI/ISA PnP
DMA-5	assigned to:PCI/ISA PnP
DMA-6	assigned to:PCI/ISA PnP
DMA-7	assigned to:PCI/ISA PnP

The above settings will be shown on the screen only if “Manual” is chosen for the resources controlled by function.

Legacy is the term which signifies that a resource is assigned to the ISA Bus and provides for non-PnP ISA add-on cards. PCI/ISA PnP signifies that a resource is assigned to the PCI Bus or provides for ISA PnP add-on cards and peripherals.

Resources Controlled By

By Choosing “Auto” (default), the system BIOS will detect the system resources and automatically assign the relative IRQ and DMA channel for each peripheral. By Choosing “Manual” the user will need to assign IRQ & DMA for add-on cards. Be sure that there are no IRQ/DMA and I/O port conflicts.

IRQ Resources

When resources are controlled manually, assign each system interrupt a type, depending on the type of device using the interrupt.

DMA Resources

When resources are controlled manually, assign each DMA channel a type, depending on the type of device using the DMA channel.

PCI / VGA Palette Snoop

Choose Disabled or Enabled. Some graphic controllers which are not VGA compatible take the output from a VGA controller and map it to their display as a way to provide boot information and VGA compatibility.

However, the color information coming from the VGA controller is drawn from the palette table inside the VGA controller to generate the proper colors, and the graphic controller needs to know what is in the palette of the VGA controller. To do this, the non-VGA graphic controller watches for the write access to the VGA palette and registers the snoop data. In PCI based systems, the Write Access to the palette will not show up on the ISA bus if the PCI VGA controller responds to the Write.

In this case, the PCI VGA controller should not respond to the Write, it should only snoop the data and permit the access to be forwarded to the ISA bus. The non-VGA ISA graphic controller can then snoop the data on the ISA bus. Unless you have the above situation, you should disable this option.

Disabled (default)	Function Disabled.
Enabled	Function Enabled.

Assign IRQ For VGA

Lets the user choose which IRQ to assign for the VGA.

Assign IRQ For USB

Lets the user choose which IRQ to assign for the USB.

2.8 PC Health Status

© Figure 8. PC Health Status

CMOS Setup Utility-Copyright(C) 1984-2001 Award Software

PC Health Status

Current CPU Temp.	Item Help
Current System Temp.	Menu Level
Current CPUFan1 Speed	
Current CPUFan2 Speed	
Vcore	
2.5V	
3.3V	
5V	
12V	

←→↑↓: Move Enter:Select +/-/PU/PD:Value F10:Save ESC:Exit
 F1:General Help F5:Previous Values F6:Fail-Safe Defaults
 F7:Optimized Defaults

Current CPU Temp.

This field displays the current CPU temperature, if your computer contains a monitoring system.

Current System Temp.

This field displays the current system temperature, if your computer contains a monitoring system.

Current CPUFan1 Speed

This field displays the current speed of up to CPU Fans, if your computer contains a monitoring system.

Current CPUFan2 Speed

This field displays the current speed of up to System Fans, if your computer contains a monitoring system.

Current CPU Vcore 2.5V, 3.3V, 5V, 12V

Detect system's voltage status automatically.

2.9 Frequency / Voltage Control

© Figure 9. Frequency / Voltage Control

CMOS Setup Utility-Copyright(C) 1984-2001 Award Software

Frequency / Voltage Control

Auto Detect DIMM / PCI CLK	Enabled	Item Help
Spread Spectrum	Disabled	
CPU Host/PCI Clock	66	Menu Level

←→↑↓: Move Enter:Select +/-/PU/PD:Value F10:Save ESC:Exit
 F1:General Help F5:Previous Values F6:Fail-Safe Defaults
 F7:Optimized Defaults

Auto Detect DIMM / PCI CLK

This item allows you to enable/disable auto detect DIMM / PCI CLOCK.

The Choices: Enabled(default), Disabled.

Spread Spectrum

This function is designed to EMI test only.

The Choices: Disabled(default), Enabled.

CPU Host PCI / Clock

This item allows you to select the CPU Host Clock (CPU/ PCI).

The Choices: Min 66~Max 166.

2.10 Load Fail-Safe Defaults

When you press <Enter> on this item, you get a confirmation dialog box with a message similar to:

© Figure 10. Load Fail-Safe Defaults

CMOS Setup Utility-Copyright(C) 1984-2001 Award Software

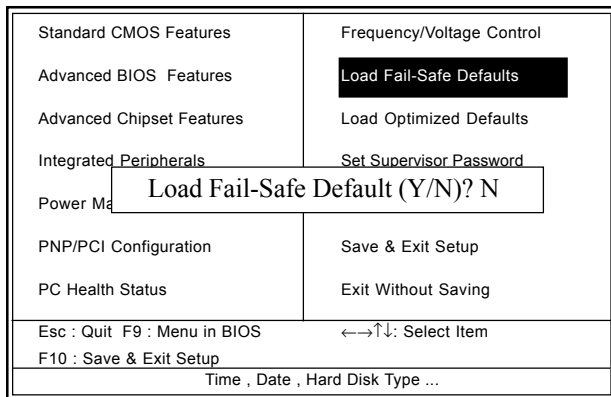

Pressing 'Y' loads the default values that are factory settings for optimal performance of system operations.

2.11 Load Optimized Defaults

When you press <Enter> on this item, you get a confirmation dialog box with a message similar to:

© **Figure 11. Load Optimized Defaults**

CMOS Setup Utility-Copyright(C) 1984-2001 Award Software

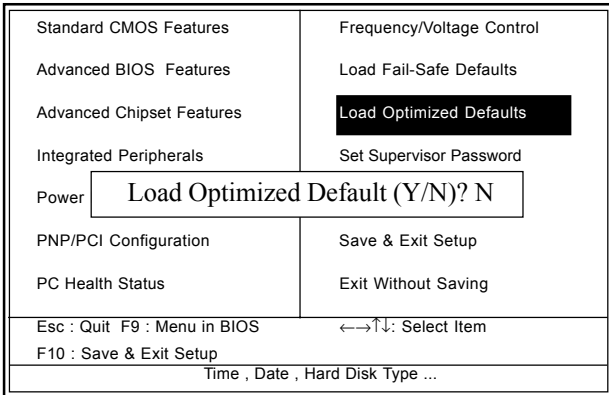

Pressing ‘Y’ loads the default values that are factory settings for optimal performance of system operations.

2.12 Set Supervisor / User Password

© Figure 12. Set Supervisor / User Password

CMOS Setup Utility-Copyright(C) 1984-2001 Award Software

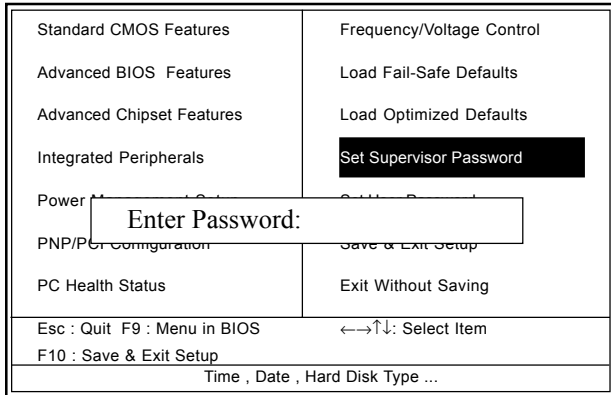

When you select this function, the following message will appear at the center of the screen to assist you in creating a password.

Enter Password

Type a password, up to eight characters, and press <Enter>. The password you type now will clear any previously entered password from CMOS memory. You will be asked to confirm the password. Type the password again and press <Enter>. You may also press <ESC> to abort the selection and not enter a password. To disable the password, just press <Enter> when you are prompted to enter a password. A message will confirm that you wish to disable the password. Once the password is disabled, the system will boot and you can enter setup freely.

Password Disabled

If you select “System” at the Security Option of BIOS Features Setup Menu, you will be prompted for the password every time when the system is rebooted, or any time when you try to enter Setup. If you select “Setup” at the Security Option of the BIOS Features Setup Menu, you will be prompted only when you try to enter Setup.

2.13 Save & Exit Setup

© Figure 13. Save & Exit Setup

CMOS Setup Utility-Copyright(C) 1984-2001 Award Software

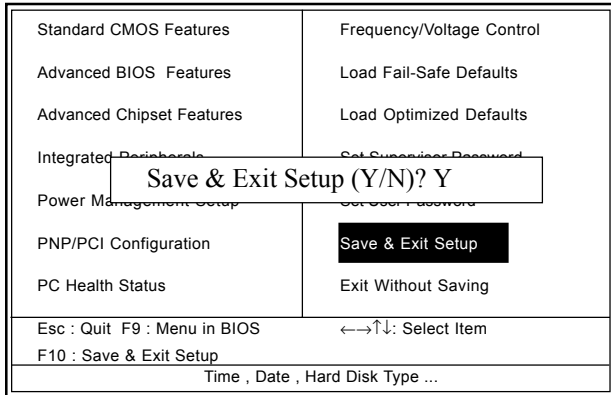

Typing “Y” will quit the Setup Utility and save the user setup value to RTC CMOS RAM.

Typing “N” will return to the Setup Utility.

2.14 Exit Without Saving

© Figure 14. Exit Without Saving

CMOS Setup Utility-Copyright(C) 1984-2001 Award Software

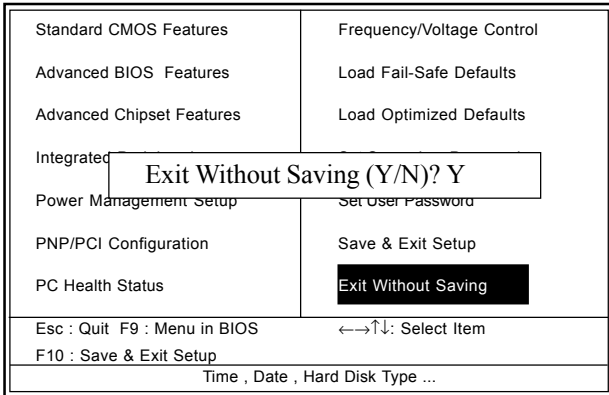

Typing “Y” will quit the Setup Utility without saving to RTC CMOS RAM.

Typing “N” will return to the Setup Utility.

3. Driver Installation

Introduction

There are motherboard drivers and utilities included in ACORP Bonus CD disc. You don't need to install all of them in order to boot your system. But after you finish the hardware installation, you have to install your operation system first (such as windows 98) before you can install any drivers or utilities. Please refer to your operation system installation guide.

Note: Please follow recommended procedure to install Windows 95 and Windows 98.

3.1 Auto-run Menu

You can use the auto-run menu of Bonus CD disc. Choose the utility or driver and select model name.



3.2 Installing VIA 4 in 1 Driver

You can install the VIA 4 in 1 driver (IDE Bus master (For Windows NT use), VIA ATAPI Vendor Support Driver, VIA AGP, IRQ Routing Driver (For Windows 98 use), VIA Registry (INF) Driver) from the Bonus Pack CD disc auto-run menu.



(1)
Click
"VIA Driver" Item.



(2)
Click
"Chipset_driver" Item.

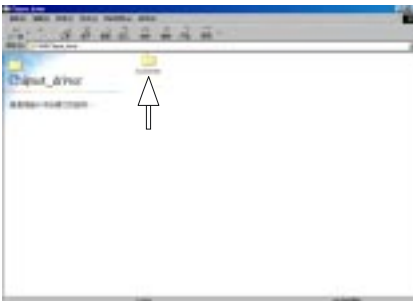

(3)
Click
"4in1432v(a)" Item.

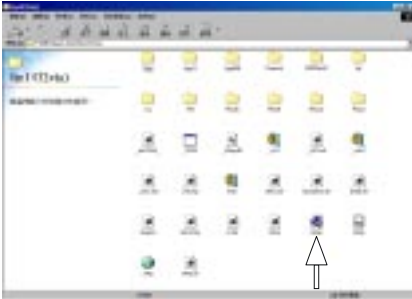

(2)
Click
"Setup" Item.

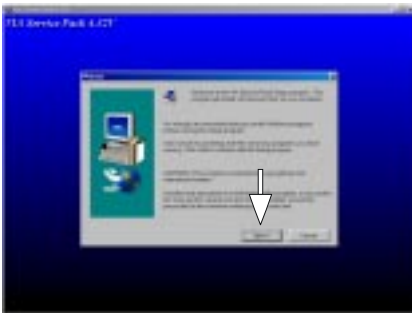

(5)
Click "Next".

Note: Installing this Bus Master IDE driver may cause Suspend to Hard Drive failure.

3.3 Installing Audio Driver

This motherboard comes with an AC97 CODEC and the sound controller is in VIA South Bridge chipset. You can find the audio driver from the Bonus Pack CD disc auto-run menu.



(1)
Click
"VIA Driver" Item.

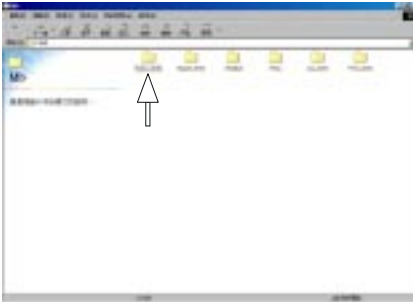

(2)
Click
"Audio_driver" Item.



(3)
Click
"Via686A&B" Item.

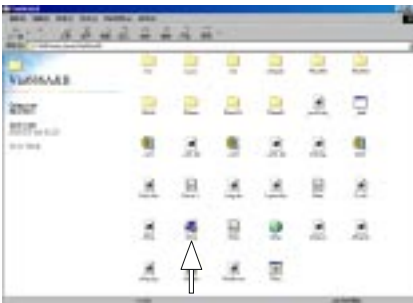

(4)
Click "Setup".



(5)

3.4 Installing Hardware Monitoring Utility

You can install Hardware Monitoring Utility to monitor CPU temperature, fans and system voltage. The hardware monitoring function is automatically implemented by the BIOS and utility software. No hardware installation is needed.



(1)
Click
"VIA Driver" Item.

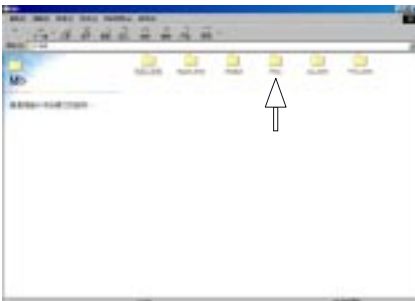

(2)
Click
"HWM" Item.

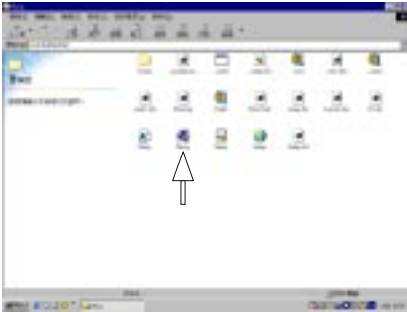

(3)
Click "Setup".



(4)
Click "Next".

3.5 Installing VGA Driver

VIA Ple133 chipset integrated a 2D/3D graphics acceleration.



(1)
Click
"VIA Driver" Item.



(2)
Click
"VGA_driver" Item.

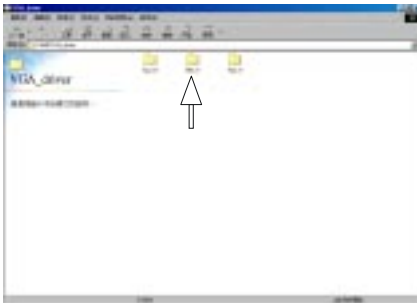

(3)
Click
"Ple133" Item.

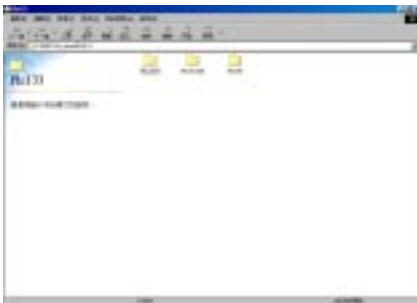

(4)
a. For Win NT System
Click
"WinNT" Item.
b. For Win 2000 System
Click
"Win2000" Item.
c. For Win9x_ME System
Click
"Win9x_ME" Item.



(5)
For Win NT System
Click
"Setup".



(6)
For Win 2000 System
Click
"Setup".

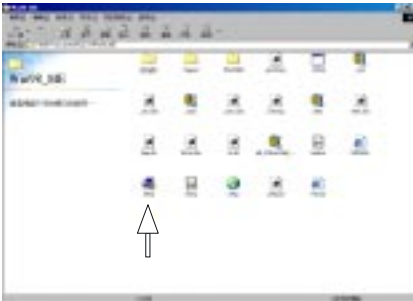

(7)
For Win9x_ME System
Click
"Setup".

3.6 Installing TV-OUT Connector

This motherboard is support TV-OUT function. When you install TV-OUT hardware and you can find related function in Display Properties menu from the Windows Desktop.

Note:
VGA & TV-OUT Connector can't simultaneous use it.

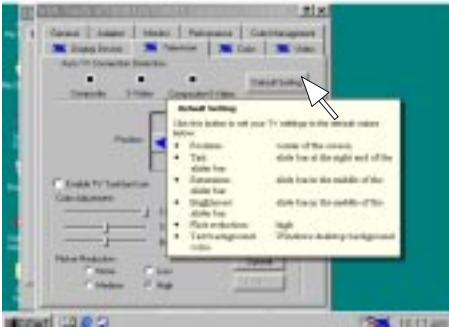

**Explain1:
 Default Setting**



**Explain2:
 Enable TV
 Taskbar Icon**

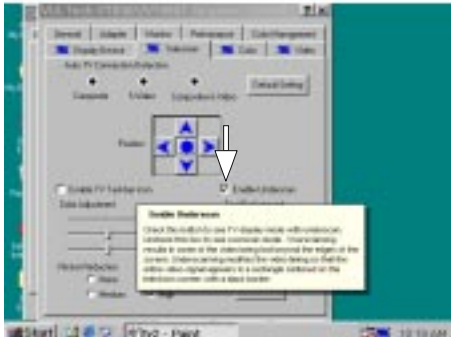

Explain3:
Enable Underscan



Explain4:
TV Color Tint



Explain5:
TV Color Saturation

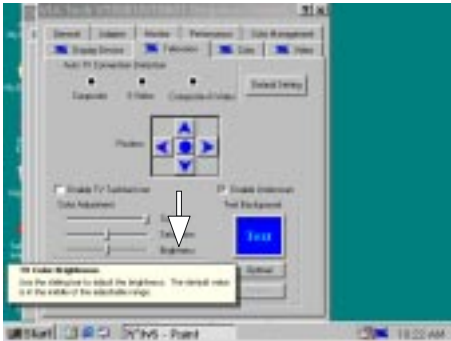

**Explain6:
TV Color
Brightness**

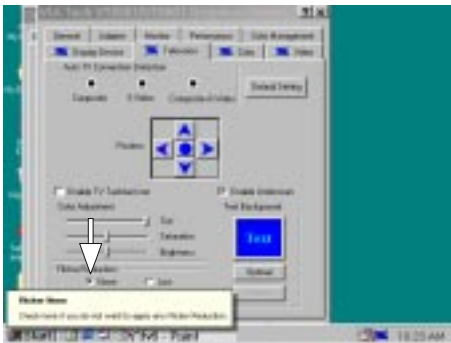

**Explain7:
Flicker None**

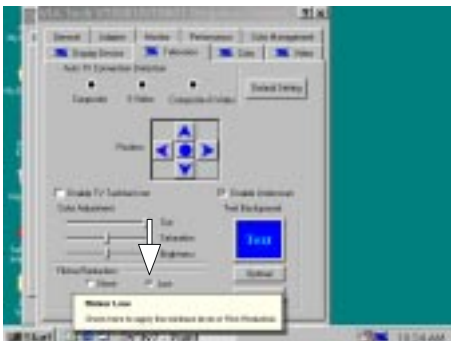

**Explain8:
Flicker Low**



**Explain9:
Flicker High**



**Explain10:
Flicker Medium**

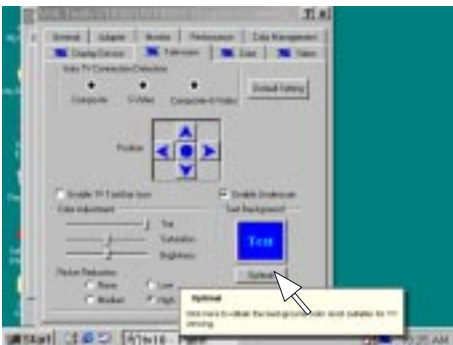

**Explain11:
Optional**

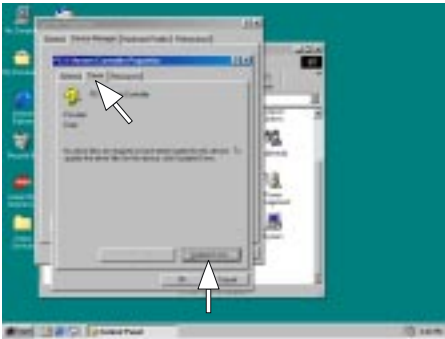

(3)
Select
"Driver"
then Click
"Update Driver" Item.



(4)
Click
"Next" Item.

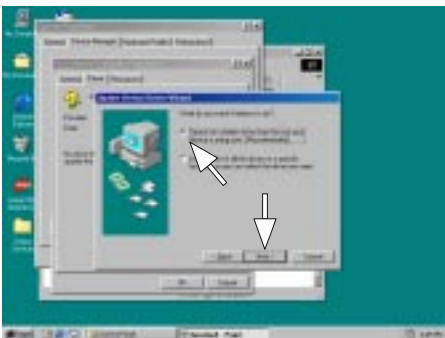

(5)
Click
"Next" Item.

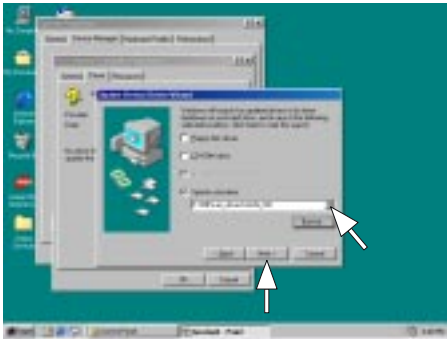

(6)
Selection your system environment follow path :\\MB\\LAN_driver\\ then Click "Next" Item.

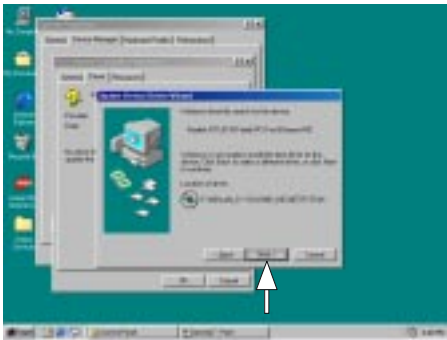

(7)
Click "Next" Item.

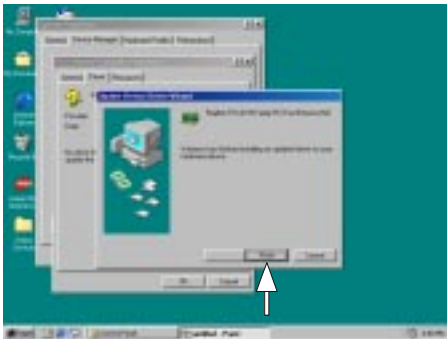

(8)
Click "Finish" Item.