



Declaration of Conformity

According to 47 CFR, Parts 2 and 15 of the FCC Rules

The following designated product:

EQUIPMENT: MAINBOARD
MODEL NO.: CT- 6AIA2

is a Class B digital device that complies with 47 CFR Parts 2 and 15 of the FCC Rules. Operation is subject to the following two conditions:

1. This device may not cause harmful interference.
2. This device must accept any interference received, including interference that may cause undesired operation.

This declaration is given to the manufacturer:

CHAINTECH COMPUTER U.S., INC
509 Valley Way, Milpitas, CA 95035, U.S.A.

Tel: 1-408-935-6988

Fax: 1-408-935-6989

Chaintech President: Raff Tung

Signature:

A handwritten signature in black ink, appearing to read 'Raff Tung', written over a horizontal line.

Federal Communications Commission Statement

This device complies with FCC Rules Part 15. Operation is subject to the following two conditions:

- ♦ This device may not cause harmful interference
- ♦ This device must accept any interference received, including interference that may cause undesired operation.

This equipment has been tested and found to comply with the limits for a Class B digital device, pursuant to Part 15 of the FCC Rules. These limits are designed to provide reasonable protection against harmful interference in a residential installation. This equipment generates, uses and can radiate radio frequency energy. If this equipment is not installed and used in accordance with the manufacturer's instructions, it may cause harmful interference to radio communications. However, there is no guarantee that interference will not occur in a particular installation. If this equipment does cause harmful interference to radio or television reception, which can be determined by turning the equipment off and on, the user is encouraged to try to correct the interference by one or more of the following measures:

- ♦ Reorient or relocate the receiving antenna.
- ♦ Increase the separation between the equipment and receiver.
- ♦ Connect the equipment to an outlet on a circuit different from that to which the receiver is connected.
- ♦ Consult the dealer or an experienced radio/TV technician for help.

The use of shielded cables for connection of the monitor to the graphics card is required to assure compliance with FCC regulations. Changes or modifications to this unit not expressly approved by the party responsible for compliance could void the user's authority to operate this equipment.

Canadian Department of Communications Statement

This digital apparatus does not exceed the Class B limits for audio noise emissions from digital apparatuses set out in the Radio Interference Regulations of the Canadian Department of Communications.

Manufacturer's Disclaimer Statement

The information in this document is subject to change without notice and does not represent a commitment on the part of the vendor. No warranty or representation, either expressed or implied, is made with respect to the quality, accuracy or fitness for any particular purpose of this document. The manufacturer reserves the right to make changes to the content of this document and/or the products associated with it at any time without obligation to notify any person or organization of such changes. In no event will the manufacturer be liable for direct, indirect, special, incidental or consequential damages arising out of the use or inability to use this product or documentation, even if advised of the possibility of such damages. This document contains materials protected by copyright. All rights are reserved. No part of this manual may be reproduced or transmitted in any form, by any means or for any purpose without expressed written consent of its authors. Product names appearing in this document are mentioned for identification purposes only. All trademarks, product names or brand names appearing in this document are registered property of their respective owners.

Printed in Taiwan

July 1999

100% POST-CONSUMER
RECYCLED PAPER 

Table of Contents

Chapter 1 Introduction	1
1-1 Product Specifications	1
1-2 Package Contents	4
1-3 Mainboard Layout	5
1-4 Connector and Jumper Reference Chart	5
Chapter 2 Hardware Setup	7
2-1 Introduction to Jumpers	7
2-2 Installing a CPU in a Socket 370	8
2-3 Setting Your CPU's Parameters	8
2-4 Connector and Jumper Settings	9
2-5 Main Memory Configuration	17
Chapter 3 Award BIOS Setup Program	19
3-1 Standard CMOS Setup	20
3-2 BIOS Features Setup	23
3-3 Chipset Features Setup	27
3-4 Power Management Setup	30
3-5 PNP/PCI Configuration	35
3-6 Load Setup Defaults	37
3-7 Integrated Peripherals	38
3-8 Supervisor Password & User Password Setting	40
3-9 IDE HDD Auto Detection	42
3-10 Save and Exit Setup	42
3-11 Exit Without Saving	42
Chapter 4 Brief Software Driver Guide	43
Chapter 5 ESS Solo-1 Audio Subsystem	45
5-1 Features	45
5-2 Sound Driver and Utility	45
5-3 CD-ROM Audio-in connection	45
Feature Explanations	
Software Power-off Control	9
Over-ride Power Button	10
Blinking LED in Suspend Mode	10
Power On By Modem	9/34
Power On By Alarm	33
Poly-fuse Over Current Protection	13

Appendices

Appendix I On Board I/O Addresses & IRQ Maps	47
Appendix II Quick Connector and Jumper Reference	49



Memo

Chapter 1

Introduction

1-1 Product Specifications

❑ Processor

- Supports Intel Socket370 processors up to 400MHz
- System clock 66/100MHz
- High efficiency switching power modules(VRM.8.3 compliant)

❑ Chipset

- VIA Apollo Pro Plus (VT82c693/VT82c596B) dual chip AGPset

❑ DRAM Memory

- Two 168-pin DIMM sockets support up to 256MB for SDRAM
- Supports 16/32/64/128MB, 64/72-bit unbuffered Synchronous DIMM modules
- Provides single-bit ECC capability



PC-100 certified SDRAM DIMM modules with SPD are required for 100MHz frequency clock speed



Because 256MB unbuffered DIMM and Registered DIMM modules are not yet mainstream, their compatibility can not be guaranteed. (See Section 2-5 for details.)

❑ Expansion Slots

- One 32-bit AGP slot (Rev 1.0 compliant)
- Three 32-bit PCI slots (Rev 2.1 compliant)
- One 16-bit ISA slot (with sharing slot)

❑ BIOS

- Award System BIOS, supports PnP, APM, DMI, ACPI & Multi-device booting features i.e. floppy, LS120, CD-ROM, HDD(IDE, SCSI), ZIP-ATAPI etc.
- Includes Trend **ChipAway Virus** protection for virus-free boot and virus free operating system
 - ✎ Trend ChipAway Virus is a rule-based anti-virus technology and does not require periodical updates of virus code

❑ Embedded Ultra DMA-66 PCI IDE controller

- Supports two IDE ports up to 4 ATAPI devices
- Supports up to PIO Mode 4 up to 14MBps, Multi Mode 4 up to 66MBps with bus mastering
- Bus Mastering software drivers for all well known multi-task operating systems

❑ On-board Ultra I/O

- ITE 8671 I/O chip
- One Parallel (SPP/ECP/EPP) and two Serial (16550A compliant) ports
- One floppy disk drive connector supports up to 2.88MB, Japanese 3-Mode, and 1Mbps transfer rates
- Supports HPSIR and ASKIR function up to 115.2Kbps

❑ On-board Audio Chip (Optional)

- ESS Solo-1(ES1938S) audio chip
- CD-quality, 16-bit stereo audio controller
- Programmable independent sample rate from 4KHz to 48KHz for record and playback
- Full-duplex operation for simultaneous recording and playback
- Built-in high quality ESFM music synthesizer
- Integrated Spatializer-3D audio effects processor

❑ Two Channel USB Ports



Now under compatibility testing with different peripherals

❑ Board Dimensions

- Micro-ATX form factor, 244mm x 195mm, 4 Layers
- Six mounting holes

❑ Advanced Management Features

- Innovative SeePU technology for jumperless CPU installation and 75/83/103/124/133MHz overclocking technology
- Optional LDCM compliant System Monitor Hardware with Chassis intrusion detection
- Power-on by Mouse movement or clicks, Keyboard password, WOL(Wake-on-LAN) network card, Modem ring , RTC Alarm
- Software power off control, Over-ride power button, Power failure recovery, Blinking LED in Suspend, etc.
- Poly-fuse protection for USB and keyboard circuitry
- Flash BIOS write protection against unauthorized access with Trend PC-Cillin 98 and ChipAway Virus to ensure virus-free booting procedure

□ Switching Power Supply Requirement (at least 200 Watts)

Output Voltage	Max. Regulation Requirement	Min. Current Requirement (Amps)
+12V	+/- 5%	0
+5V	+/- 5%	1
+3.3V	+/- 5%	10*
-5V	+/- 10%	0
-12V	+/- 10%	0
+5VSB	+/- 5%	0.75

Table 1-1

3.3V at 10Amps is necessary to guarantee full loading operation because some AGP cards and memory modules have high current consumption.

1-2 Package Contents

This product comes with the following components:

- ❑ One mainboard
- ❑ One 40-pin Ultra DMA-66 IDE connector ribbon cable (Figure 1-1)
 - * **Color coded connection for UDMA/66 cable**
 - Blue to mainboard, Ground in blue, Gray to Master and Black to slave
- ❑ One 34-pin floppy disk drive ribbon cable (Figure 1-2a) or (Figure 1-2b)
- ❑ One plastic stub for standard ATX installation (Figure 1-3)
- ❑ One User's Manual
- ❑ One CD-ROM that includes
 - Acrobat Reader- Award Flash Utility and Award DMI Utility for DOS
 - VIA Bus Master IDE drivers for Win95, WinNT
 - VIA AGP VxD for Win95
 - ESS Audio Driver for DOS/Win95/NT
 - ESS AudioRack Utility for Win95/NT
 - ESS 1MB WaveData for Win95
 - System Health Monitoring Software
 - Trend **PC-cillin 98** with multilingual support
 - Optional **AIRBAG** software group including Norton Ghost, Norton AntiVirus and High Point Xstore Pro

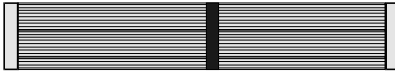

Figure 1-1 IDE cable

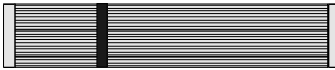

Figure 1-2a Standard Floppy cable



Figure 1-2b Optional 5.25 in. floppy cable

Insert the stub if the mounting screw is not supported by the ATX case

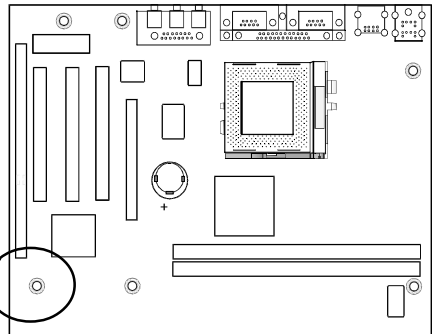
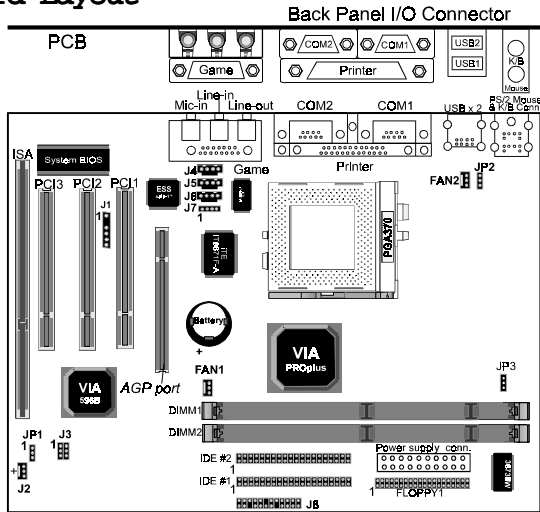

Figure 1-3

1-3 Mainboard Layout



1-4 Connector and Jumper Reference Chart

Jumper & Connector No.	Function	Page
J1	Infrared connector	12
J2	WOL (Wake-on-LAN) connector	15
J3	Creative's SB-LINK Sound connector	15
J4	CD-ROM audio in connector	14
J5	AUX audio-in connector	14
J6	Modem Telephony connector	14
J7	Volume control connector	14
J8	Keyboard lock & Power indicator LED connector	10
	System reset switch connector	11
	Speaker connector	11
	Green switch/Green LED connector	11
	Turbo LED connector	11
	IDE activity LED connector	11
	Over ride power button connector	10
PW1	ATX Power supply connector	9
FAN1	System cooling fan connector	12
FAN2	CPU cooling fan connector	12
JP1	Clear CMOS data jumper	13
JP2	Power-on by Keyboard	12
JP3	System bus setting jumper	15
Ports	PS/2 mouse and keyboard ports	13
Ports	USB (Universal Serial Bus) ports	16



Memo

Hardware Setup

If your mainboard has already been installed in your computer you may still need to refer to this chapter if you plan to upgrade your system's hardware.

! Be sure to disconnect the power cable from the power source before performing any work on your mainboard, i. e. installing a CPU, memory module, changing a jumper setting, etc. Not doing so may result in electrical shock!

2-1 Introduction to Jumpers

Jumpers are used to select between various operating modes. A jumper consists of a row of gold colored pins that protrude from the surface of the mainboard. It is important not to confuse jumpers with connectors or headers.

! Putting jumper caps on anything that is not a jumper may result in damaging your mainboard. Please refer to Section 1-3, Mainboard Layout, for the location of jumpers on your mainboard.

As indicated in Figure 2-1 below, a cap is used to cover the pins of a jumper, resulting in shorting those pins that it covers. If the cap is removed from the top of the pins, the jumper is left "open." The number 1 shown both in the diagram below and in all multiple pin jumper and header diagrams in this manual indicates the pin designated with the number 1. The numbering of the remaining pins follows in sequence.

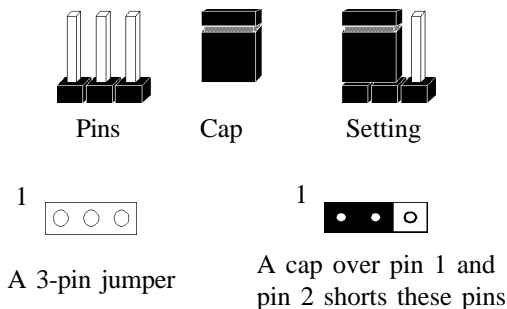

Figure 2-1

2-2 Installing a CPU in a Socket 370

The Intel Socket 370, designed for the Celeron processor, has been incorporated as a standard mainboard specification. To insert your CPU into Socket 370 please do the following:

1. Locate a small dot marked on the top surface of the CPU close to one of its corners. The same corner will also be cut off, leaving a noticeable notch in the CPU's corner. These markings indicate Pin 1 of the CPU.
2. Pull up the lever of Socket 370 so that it is perpendicular with the surface of the mainboard. Gently insert the CPU with Pin 1 at the same corner of Socket 370 that contains the end of the lever. Allow the weight of the CPU to push itself into place. Do not apply extra pressure as doing so may result in damaging your CPU. Snap the lever back into place.



Installing a heat sink with cooling fan is necessary for proper heat dissipation from your CPU. Failing to install these items may result in overheating and possible burn-out of your CPU.

2-3 Setting Your CPU's Parameters

Jumperless CPU setting enables the user to setup a mainboard's CPU Host/PCI Clock values through an easy to use BIOS setup procedure. It is no longer necessary to make many jumper settings as on conventional mainboards.

1. After installing all your hardware into your PC system, turn on your system's power. Enter the CMOS Setup Utility by pressing the Delete key when your BIOS identification screen appears.
2. Move the cursor to Chipset Feature Setup menu and press Enter. Find the CPU Host/PCI Clock Setup commands at the right hand side of the BIOS screen.
3. Select the CPU Host/PCI Clock value according to the speed of your Celeron processor.
4. Press Esc to return to the CMOS Setup Utility, press F10 to Save and Exit Setup and choose 'Y' to confirm. The system will automatically reboot and during startup you will see the correct CPU type shown on the screen.

2-4 Connector and Jumper Settings

Connectors are used to link the system board with other parts of the system, including the power supply, the keyboard, and the various controllers on the front panel of the system case.



The power supply connector is the last connection to be made while installing a mainboard. Before connecting the power supply, please make sure it is not connected to the power source.

ATX Power Supply Connector (PW1)

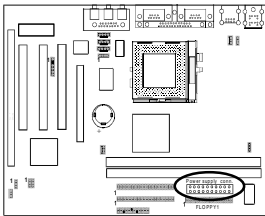

This mainboard requires a power supply of at least 200 watts. The power cord leading from the system's power supply to the external power source must be the very last part connected when assembling a system.

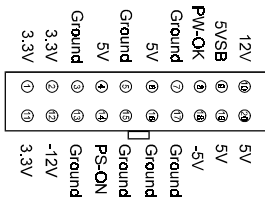

The ATX power supply provides a single 20-pin connector interface which incorporates standard +/-5V, +/-12V, optional 3.3V and Soft-power signals. The Soft-power signal, a 5V trickle supply is continuously supplied when AC power is available. When the system is in the Soft-Off mode, this trickle supply maintains the system in it's minimum power state.

Software Power-Off Control

This mainboard can be powered down using the Windows 95 Software Power-Off function. To power down your computer, click the START button on the Windows 95 task bar. Select "Shut Down The Computer" and the system turns off. The message "It is now safe to turn off your computer" will not be shown when using this function.

Power-On By Modem

While in Soft-off state, if an external modem ring-up signal occurs, the system wakes up and can be remotely accessed. You may enable this function in BIOS's Power Management Setup menu. (See section 3-4)

Front Panel Connector Set (J8) A through G

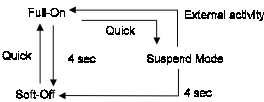
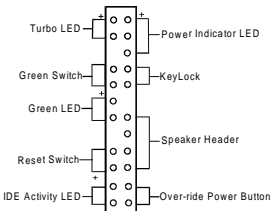
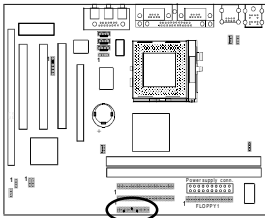

Over-ride Power Button

A. Over-ride Power Button Connector

The power button on the ATX chassis can be used as a normal power switch as well as a device to activate Advanced Power Management Suspend mode. This mode is used for saving electricity when the computer is not in use for long periods of time. The Soft-OFF by PWR-BTTN function in BIOS's Power Management Setup menu must be set to "Delay 4 Sec." to activate this function. (See section 3-4)

When the Soft-OFF by PWR-BTTN function is enabled, pushing the power button rapidly will switch the system to Suspend mode. Any occurrence of external activities such as pressing a key on the keyboard or moving the mouse will bring the system back to Full-On. Pushing the button while in Full-On mode for more than 4 seconds will switch the system completely off. See Over-ride Power Button Operation diagram.

B. Keyboard Lock & Power Indicator LED Connector

Plugging this connector into the lock on the front panel of the system case allows the lock to enable or disable the keyboard. This function provides limited security against casual intruders. The power indicator LED shows the system's power status. It is important to pay attention to the correct cables and pin orientation (i.e., not to reverse the order of these two connectors.)

	Pin	Definition
Power Good LED	1	+5V DC
	2	No Connect
	3	Ground
Keyboard Lock	4	Keylock
	5	Ground

Blinking LED in Suspend Mode

While in Suspend mode, the LED light on the front panel of your computer will flash. Suspend mode is entered by pressing the Override Power Button, pushing the Green button on your ATX case, or enabling the Power Management and Suspend Mode options in BIOS's Power Management menu. (See section 3-4)

C. Green Switch/Green LED Connector

Some ATX cases provide a Green switch which is used to put the system in Suspend mode. In Suspend mode, the power supply to the system is reduced to a trickle, the CPU clock is stopped, and the CPU core is in its minimum power state. The system is woken up whenever the keyboard or mouse is touched. The system resumes in different ways as defined by Power Management Setup screen in BIOS.

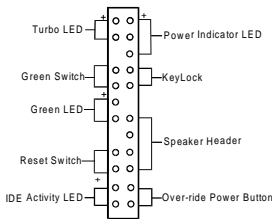

D. System Reset Switch Connector

This connector should be connected to the reset switch on the front panel of the system case. The reset switch allows you to restart the system without turning the power off.

Pin	Definition
1	System
2	GND

E. Speaker Connector

PIN	Definition
1	Speaker Signal
2	NC
3	NC
4	+5V DC

F. IDE Activity LED Connector

The IDE activity LED lights up whenever the system reads/writes to the IDE devices.

G. Turbo LED Connector

This mainboard does not have a Turbo/De-turbo speed modes. Even though this function does not exist, the turbo LED will light when the LED is connected and turbo button pressed.

Infrared Connector (J1)

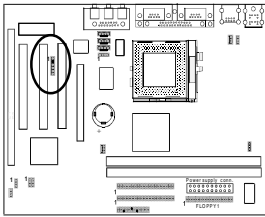

If you enable the COM2 Mode in BIOS's Integrated Peripherals menu the COM2 port will support IR functions. (See section 3-8)



System/CPU Cooling Fan Connectors (FAN1/FAN2)

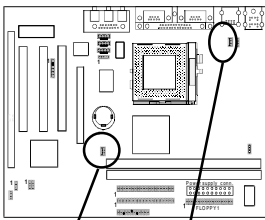

SYS FAN CPU FAN

These added connectors allow the fan to draw their power from the mainboard instead of the disk drive connector. The board's management extension hardware is able to detect the CPU and system fan speed in rpm (revolutions per minute). These connectors supports 3-pin cooling fans with minimum of 3500 RPM. The wiring and plug may vary depending on the manufacturer. On standard fans, the red is positive (+12V), the black is ground, and the yellow wire is the rotation signal.



Power On by Keyboard (JP2)

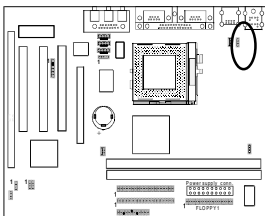

Enabled





Disabled

This board is able to be turned on by the keyboard (hot key/Password) or mouse click. To use this function, select a device of your choice at the Power on by Keyboard option in BIOS's Integrated Peripherals screen (See section 3-8). You must also set this jumper's cap to pins 2-3 to use this function. Some out-of-date keyboards may require larger current than supplied by the Suspend 5V of modern power supplies. When using older keyboards disable this function.

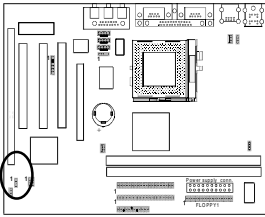
Clear CMOS Data Jumper (JP1)



- 1  Normal (default) 1  Clear CMOS data

To clear the contents of the CMOS, please follow the steps below.

1. Disconnect the system power supply from the power source.
2. Set the jumper cap at location 2~3 for 5 seconds, then set it back to the default position.
3. Connect the system's power and then start the system.
4. Enter BIOS's CMOS Setup Utility and choose Load Setup Defaults. Type Y and press enter.
5. Set the system configuration in the Standard CMOS Setup menu.

PS/2 Mouse and Keyboard Ports

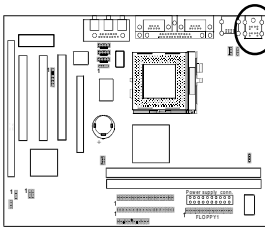

If a PS/2 mouse is used, BIOS will automatically detect and assign IRQ12 to the PS/2 mouse.



Pin	Definition
1	Data
2	No Connect
3	Ground
4	+5V (fused)
5	Clock
6	No Connect

Poly-fuse Over Current Protection

The poly-fuse protects the system from dangerous voltages the system might be exposed to via the keyboard or USB connectors. In case of such exposure, the poly-fuse will immediately be disconnected from the circuit, just like a normal fuse. After being disconnected for a certain period of time, the poly-fuse will return to its normal state, after which the keyboard or USB can function properly again. Unlike conventional fuses, the poly-fuse does not have to be replaced, relieving the user wasted time and inconvenience.

CD-ROM Audio-in Connector(J4)

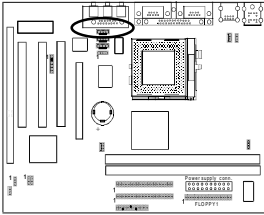

Use the audio cable enclosed with your CD-ROM disk drive to connect the CD-ROM to your mainboard. This will enable your CD-ROM's audio function.



AUX Audio-in Connector(J5)

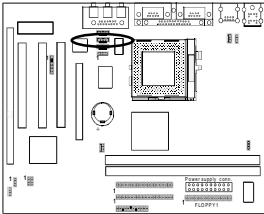

This connector supports AUX Audio input for connecting DVD or other audio devices.



Modem Telephony Connector(J6)

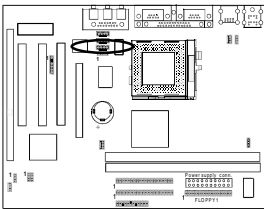

This connector supports mono audio input/output for modem telephony device.



Volume Control Connector (J7)

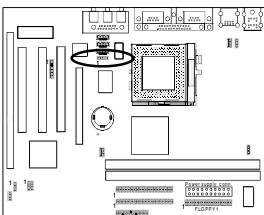

This connector should be connected to a switch on the front panel of the system case. The switch allows you to turn the volume up and down.



WOL (Wake-on-LAN) Connector (J2)

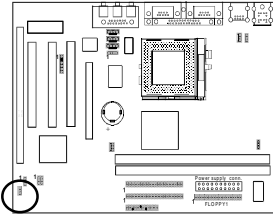

Enable the Wake Up On LAN selection in BIOS's Power Management Menu to use this function. The capability to remotely manage PCs on a network is a significant factor in reducing administrative and ownership costs. Magic Packet technology is designed to give WOL (Wake-on-LAN) capability to the LAN controller. When a PC capable of receiving wake up command goes to sleep, the Magic Packet mode in the LAN controller is enabled. When the LAN controller receives a Magic Packet frame, the LAN controller will wake up the PC. This header is used to connect an add-in NIC (Network Interface Card) which gives WOL capability to the mainboard.



To support this function, a switching power supply with a minimum of **750mA 5VSB** is required.

Creative's SB-LINK Sound Connector (J3)

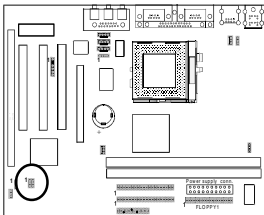

The SB-LINK serves as a bridge between the mainboard and Creative's PCI sound card. This connector delivers Sound Blaster 16 compatibility for real-mode DOS games.



System Bus Setting Jumper (JP3)

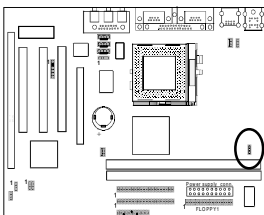

CPU



100MHz

This jumper allows the system bus frequency to be determined either by the CPU or the user. If set to pins 1-2, the CPU automatic determines the system bus speed. If set to pins 2-3, the system bus speed is always 100MHz.

USB(Universal Serial Bus) Ports

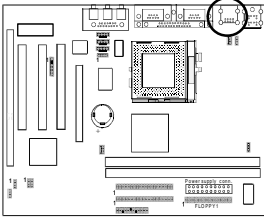

If you want to use a USB keyboard, you must enable the USB keyboard support function in BIOS's Integrated Peripherals menu (See Section 3-8). USB is an open industry standard, providing a simple and inexpensive way to connect up to 125 devices to a single computer port. Keyboards, mice, tablets, digitizers, scanners, bar-code readers, modems, printers and many more can all be used at the same time.

USB is a dynamically reconfigurable serial bus with an elementary data rate of 12Mbps. Based on off the shelf, low cost micro-controller technology, its modular layered software protocol supports sophisticated devices and application programs.

This board contains a USB Host controller and includes a root hub with two USB ports (meets USB Rev 1.0 spec.). Two USB peripherals or hub devices are able to be connected.



Compatibility with different USB peripherals is still being tested.

2-5 Main Memory Configuration

The DRAM memory system consists two banks and the memory size ranges from **16~256 MBytes**. If you only use one bank it does not matter which one you use and if you use two or more banks, it does not matter which bank you install first.

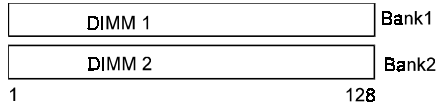

DRAM Specifications

DIMM type:	3.3V, 64/72-bit Synchronous DRAM
Module size:	Single/double-sided 16/32/64/128 MBytes
DRAM speed:	10/12ns for Synchronous DRAM
Parity:	Either parity or non-parity



The compatibility of 256MB DIMM is still under testing and cannot be guaranteed.



This mainboard supports 3.3v, unbuffered, 4-clock, SDRAM DIMM only. Buffered, 5V, or 2-clock SDRAM DIMMs should not be used.



Due to loading anomalies, using DIMM with an 'n x 4' DRAM base on this mainboard is not recommended. For example, a DIMM that uses sixteen 16Mb x 4 devices should not be used.

SPD (Serial Presence Detect)

This is an EPROM that contains speed and design information about the memory module. The mainboard queries the module and makes adjustments to system operation based on what it finds.

ECC DRAM Capability

This mainboard can be configured to support ECC (Error Check and Correct) function when utilizing parity DIMM modules. To utilize the chipset's ECC features, you must use a 72-bit DIMM module. These modules are automatically detected during bootup. However, the user must configure the DRAM Data Integrity Mode to "ECC" in BIOS's SeePU&Chipset Features Setup menu to enable the ECC function. ECC detects double bit errors and detects and corrects single bit memory errors on the fly without user intervention. Errors may be generated by a defective memory module, conflicting memory speeds between different banks, DMA, etc.



Memo

Award BIOS Setup Program

Award's BIOS ROM has a built-in setup program that allows users to modify the basic system configuration. This information is stored in CMOS RAM so that it can retain the setup information, even when the power is turned off.

When you turn on or reboot the system, press the Delete key to enter the Award BIOS setup program. The primary screen as shown in Figure 3-1 is a list of the menus and functions available in the setup program. Select the desired item and press enter to make changes. Operating commands are located at the bottom of this and all other BIOS screens. When a field is highlighted, on-line help information is displayed on the left bottom edge of the screen.

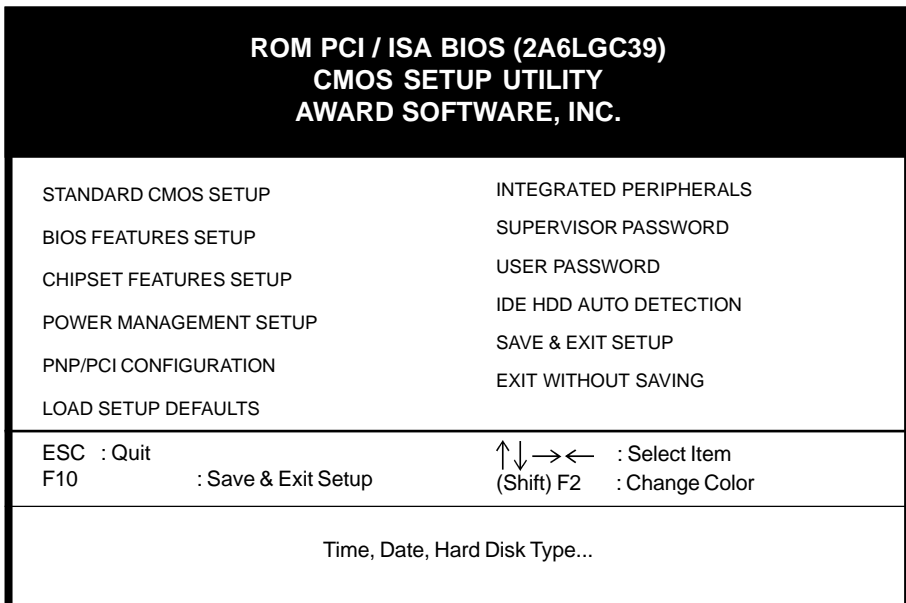

Figure 3-1 Setup Program Initial Screen

3-1 Standard CMOS Setup

The Standard CMOS Setup allows users to configure system components such as hard disk drive, floppy disk drive and video display as well as date, time and boot-up error signaling. This configuration menu should be changed when installing a mainboard for the first time, changing hardware in your system such as the HDD, FDD, video display, or when the CMOS data has been lost or contaminated. Choose the Standard CMOS Setup option from the CMOS Setup Utility menu (Figure 3-1) to display the following screen. When a field is highlighted, on-line help information is displayed on the left bottom edge of the screen.

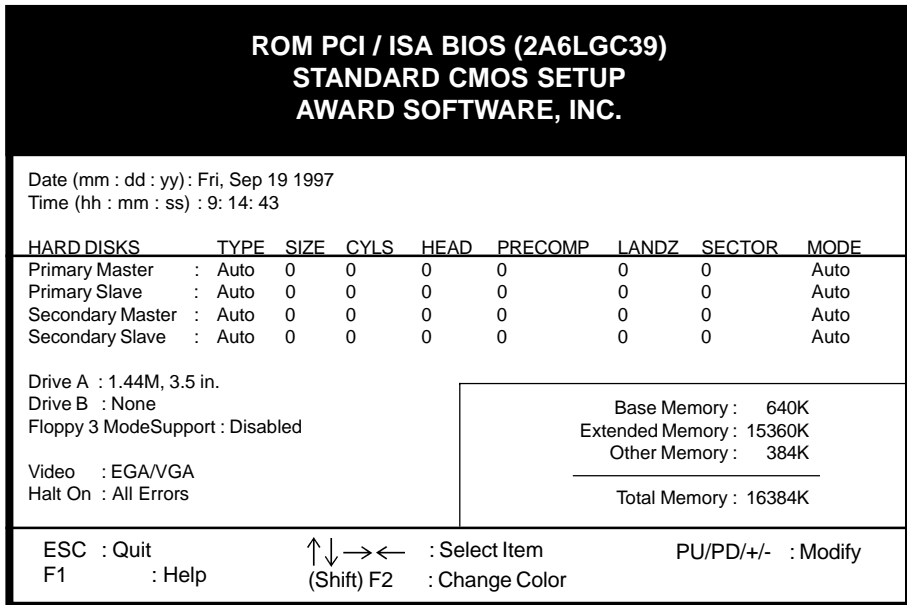

Figure 3-2 Standard CMOS Setup Screen

Date/Time

Set the date and time. Do not skip this function as all of your timed events such as power management, saving files, etc. are based on this timer.

Hard Disk Setup (Primary/Secondary; Master/Slave)

This category identifies up to four IDE hard disk drives that have been installed in the computer. This section does not show information on other IDE devices such as CD-ROM drives or other hard drive types such as SCSI drives.

Type (Auto/User/None): Use the fields under the Type column to determine the method you will use to configure the IDE devices. If you choose Auto, BIOS will automatically detect and make optimal settings for most IDE hard drives.



The mainboard manufacturer recommends that you choose Auto for all drives.

Choose User to define your own drive type manually. You must enter values indicated in the table below into each drive parameter field. This information should be included in the documentation from your hard disk vendor or system manufacturer:

TYPE	Setting method
CYLS	Number of cylinders
HEAD	Number of heads
PRECOMP	Write precompensation cylinder
LANDZ	Landing zone
SECTOR	Number of sectors
MODE	Mode type

Table 3-1 Hard Disk Drive Parameters

Cyls/Head/Sector: The number of Cylinders, Heads, and Sectors can usually be found written on the top of the hard disk. If you have a relatively new hard drive, entering this information alone is usually sufficient for normal hard disk operation. The hard disk will not work properly if you enter improper information for these categories.

Precomp: Older hard drives (i.e., MFM or RLL drives) have the same number of sectors per track at the innermost tracks as at the outermost tracks. Thus, the data density at the innermost tracks is higher and the bits are lying closer together. Even though the physical size of a sector gets progressively smaller as the track diameter diminishes, each sector must still hold 512 bytes. Write precompensation circuitry compensates for the difference in sector size by boosting the write current for inner track sectors.

Landz: This defines the address of the landing zone and is only used for older hard drives which do not have an auto-parking feature.

Mode: If the Type value is not None for any device, you must set the Mode value for that device. There are four different Mode values: Auto, Normal, Large, and LBA.

Auto - BIOS detects and enters the IDE drive type during bootup.

Normal - for IDE drives that meet the old IDE specification which support a maximum capacity of 528MB (1024 cylinders, 16 heads, and 63 sectors).

Large - for IDE drives that do not support LBA and have more than 1024 cylinders. Try this setting if your hard disk does not operate properly with the LBA setting. Large mode is not supported by all operating systems, i.e., only certain versions of DOS support large mode.

LBA - (Large/Logical Block Addressing) With LBA, the IDE controller transforms the data address described by sector, head, and cylinder number into a physical block address, significantly improving data transfer rates. This mode is for drives with greater than 1024 cylinders and between 528MB and 8.4GB in size. This protocol is the current common standard.

Choose None for Type if there are no IDE HDD devices in your system.

- ☞ You can use the IDE HDD Auto Detection function to auto detect your hard drive parameters. Using this function will automatically insert the parameters discussed under Hard Disk Setup and will indicate User for the Field value. Please see Section 3-10 for more information.

Floppy Disk Drives

Choose the memory capacity and disk size that corresponds with that of your floppy disk drive(s).

Video

Select the type of video adapter present in your system. You can ignore this setting if you are using a VGA monitor since VGA BIOS automatically configures this setting.

Halt

When the system is powered on, BIOS performs a series of diagnostic tests called POST (Power On Self Test). This function stops the computer if BIOS detects a hardware error. You can tell BIOS to halt on all errors, no errors, or not to halt on specific errors.

3-2 BIOS Features Setup

By choosing the BIOS Features Setup option from the CMOS Setup Utility menu (Figure 3-1), the screen below is displayed. This sample screen contains the manufacturer's default values for the mainboard.

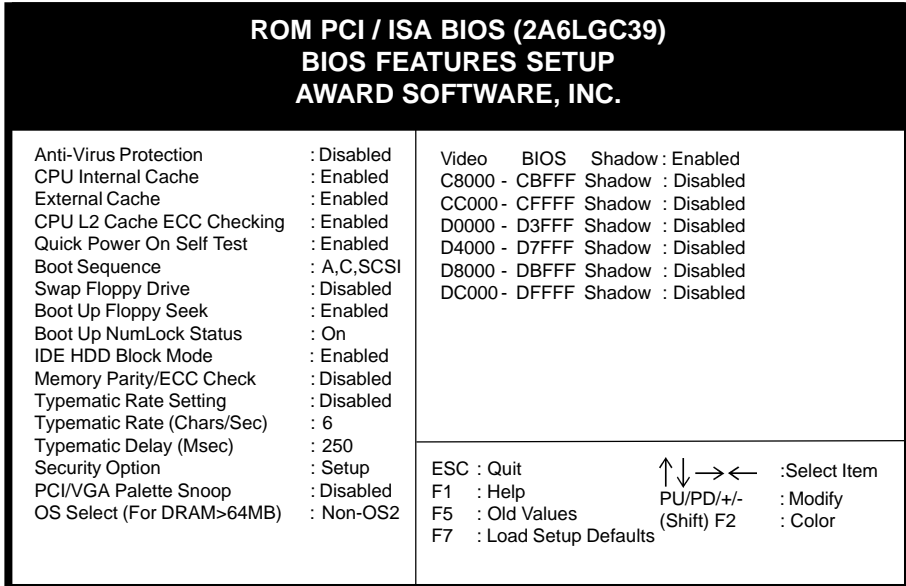

Figure 3-3 BIOS Feature Setup Screen

A. Anti-Virus Protection

Trend ChipAway Virus

Trend ChipAway Virus is a code incorporated in the mainboard's BIOS firmware. During the boot-up sequence, BIOS loads before loading of the partition table or boot sector. ChipAway Virus loads with BIOS and is able to detect boot-up viruses before they have a chance to infect the hard drive. ChipAway Virus employs rule-based logic that doesn't look for specific viruses but rather detects patterns found in every virus, eliminating the need to perform periodical version updates after new viruses have been found.

B. Cache Control

CPU Internal Cache/External Cache

Cache memory is much faster than conventional DRAM system memory. These fields allow you to enable or disable the CPUs Level 1 built-in cache and Level 2 external cache. Both settings are left enabled to significantly increase the performance of your computer.

C. Boot Up Features

After turning on the system, BIOS will perform a series of device initializations and diagnostic tests discussed below.

Quick Power On Self Test (POST)

Enable this function to reduce the amount of time required to run the POST (Power On Self Test). BIOS saves time by skipping some items during POST. It is recommended that you disable this setting. Discovering a problem during bootup is better than losing data during your work.

Boot Sequence

This option sets the sequence of drives BIOS attempts to boot from after POST completes. BIOS will search these drives for an operating system.

Swap Floppy Drive

Enabling this function will swap the floppy drive assignment so that drive A will function as drive B, and drive B will function as drive A. Note that the boot sequence assignment mentioned directly above does not include booting from floppy drive B. This function is useful if floppy drives B and A are of a different format and you want to boot from floppy drive B.

Boot up Floppy Seek

During POST, BIOS will determine if the installed floppy disk drive has 40 or 80 tracks. A 360K drive has 40 tracks and 720K, 1.2M and 1.44M drives have 80 tracks. All modern floppy disk drives have 80 tracks.

Boot Up NumLock Status

This function defines the keyboard's numberpad as number keys or arrow keys.

D. IDE HDD Block Mode

Block mode is also called block transfer, multiple commands, or multiple sector read/write. If your IDE hard drive supports block mode (most new drives do), select Enabled for automatic detection of the optimal number of block read/writes per sector the drive can support.

E. Memory Parity/ECC Check

If the DRAM chips in your system support parity/ECC check, select Enabled

F. Keyboard Interface

Typematic Rate Setting

When enabled, you can set the following two typematic control items. When disabled, keystrokes are determined arbitrarily by the keyboard controller in your system.

Typematic Rate (Chars/Sec)

The typematic rate sets the rate at which characters on the screen repeat when a key is pressed and held down.

Typematic Delay (Msec)

The typematic delay sets how long after you press a key that a character begins repeating.

G. Security Option

The Supervisor and/or User Password functions shown in Figure 3-1 must be set to take advantage of this function. See Section 3-9 for password setting information. When the Security Option is set to System, a password must be entered to boot the system or enter the BIOS setup program. When the Security Option is set to Setup, a password is required to enter the BIOS setup program.

H. PCI/VGA Palette Snoop

Some non-standard VGA cards or MPEG video cards may not show colors properly. Setting this function to Enabled can correct this problem.

I. OS Select (For DRAM > 64MB)

If your system's DRAM is larger than 64MB and you are running OS/2, select OS/2 as the item value. Otherwise, set the item value to Non-OS/2 for all other operating systems.

J. Shadow Memory

Software such as system BIOS, video BIOS, SCSI BIOS, etc that resides in ROM (Read Only Memory) chips is called firmware. Shadowing of firmware occurs when BIOS is copied to RAM address C0000h through DFFFFh. Video BIOS loads into the C0000-C7FFF memory area when video shadowing is enabled. If an expansion peripheral in your system contains ROM-based firmware, you need to know the address range the ROM occupies to shadow it into the correct area of RAM.

Shadowing improves the firmware's performance because the firmware can be read by the CPU through the 16- or 32-bit DRAM bus as opposed to the 8-bit XT bus. However, shadowing also results in reducing the amount of high memory (640 KB to 1 MB) for loading device drivers. Shadowing is used mostly for ROM chips on ISA cards and not for PCI cards. Shadowing and playing games at the same time may result in system instability as some games access the RAM memory area being shadowed.

3-3 Chipset Features Setup

By choosing the Chipset Features Setup option from the CMOS SETUP UTILITY menu (Figure 3-1), the screen below is displayed. This sample screen contains the manufacturer's default values for the mainboard.

ROM PCI / ISA BIOS (2A6LGC39)			
CHIPSET FEATURES SETUP			
AWARD SOFTWARE, INC.			
Bank 0/1 DRAM Timing	: SDRAM 10ns	Spectrum Spread	: Disabled
Bank 2/3 DRAM Timing	: SDRAM 10ns	CPU Host/PCI Clock	: 66/33MHz
SDRAM Cycle Length	: 3		
DRAM Clock	: Host CLK		
Memory Hole	: Disabled		
Read Around Write	: Disabled		
Concurrent PCI/Host	: Disabled		
System BIOS Cacheable	: Disabled		
Video RAM Cacheable	: Disabled		
AGP Aperture Size	: 64M		
AGP 2X Mode	: Enabled		
Flash BIOS Protection	: Disabled		
Hardware Reset Protect	: Disabled		
		ESC : Quit	↑↓→← : Select Item
		F1 : Help	PU/PD/+/- : Modify
		F5 : Old Values	(Shift) F2 : Color
		F7 : Load Setup Defaults	

Figure 3-4 Chipset Features Setup Screen



With the exception of the CPU Setup, all of the above settings have been determined by the mainboard manufacturer and should not be changed unless you are absolutely sure of what you are doing. Explanation of the DRAM timing and chipset features setup is lengthy, highly technical and beyond the scope of this manual. Below are abbreviated descriptions of the functions in this setup menu. You can look on the world wide web for helpful chipset and RAM configuration information including AWARD's web site at <http://www.award.com>.

A. DRAM Setting

The first settings deal with CPU access to dynamic random access memory (DRAM). The default timings have been carefully chosen and should only be altered if data is being lost. Such a scenario might well occur if your system had mixed speed DRAM chips installed so that greater delays may be required to preserve the integrity of the data held in the slower memory chips.

B. BANK 0/1 & 2/3 DRAM Timing

This item allows you to select the value in this field, depending on whether the board has paged DRAM or EDO (Extended Data Output) DRAMs.

C. SDRAM Cycle Length

When synchronous DRAM is installed, the number of the clock cycles of CAS latency depends on the DRAM timing. Do not reset this setting from the default value specified by the system designer.

D. Memory Hole

Enabling this function will reserve the memory address space between 15MB and 16MB for ISA expansion cards. However, enabling this function will result in not allowing the system to have access to memory above 16MB. Please note that some expansion cards require this setting to be enabled.

E. Read Around write

DRAM optimization feature : If a memory read is addressed to a location whose latest write is being held in a buffer before being written to memory, the read is satisfied through the buffer contents, and the read is not sent to the DRAM. Default is Disabled.

F. Concurrent PCI/Host

Disabled this function, the CPU bus will be occupied during the entire PCI operation period.

G. Video RAM Cacheable

Enabling this function will allow caching of the video RAM, resulting in better system performance. However, if any programs write to this memory area, a system error may occur.

H. AGP Aperture Size (MB)

This function determines the amount of system memory that is given to the AGP card. Options range from 4MB to 256MB. This is a dynamic memory allotment in that the AGP card will only use the amount of memory that it needs. The remaining memory not in use will be available for the system to use. For example, if 16MB are allotted to the AGP card and the card only needs 8MB, the remaining 8MB will be available for system use.

I. AGP-2X Mode

Enable this setting to utilize the 2X mode (twice as fast as 1X) offered by advanced AGP cards. Your VGA card must support 2X mode in order to take advantage of the faster speed.

J. Flash BIOS Protection

The mainboard manufacturer developed BIOS protection technology that protects the System BIOS from accidental corruption by unauthorized users or computer viruses. When enabled, the BIOS data cannot be changed when attempting to update BIOS with the the FLASH utility. When disabled, the BIOS data can be updated by using the FLASH utility.

K. Hardware Reset Protect

When this function is enabled, your PC's hardware reset button will not function. This function is especially useful to prevent accidental resets for file servers and routers, etc., which should be available 24 hrs/day. When disabled, your PC's hardware reset button will function normally.

L. Spectrum Spread

When Enabled this function will cause lower EMI by spreading the system frequency spectrum. For normal operation, Disable this function.

M. CPU Host/PCI Clock

Selection of 66/33MHz., 100/33MHz. or 133/44MHz. timing combination for the CPU and the PCI bus.

3-4 Power Management Setup

This section provides information on the Green PC power management functions. By choosing the Power Management Setup option from the CMOS Setup Utility menu (Figure 3-1), the screen below is displayed. This sample screen contains the

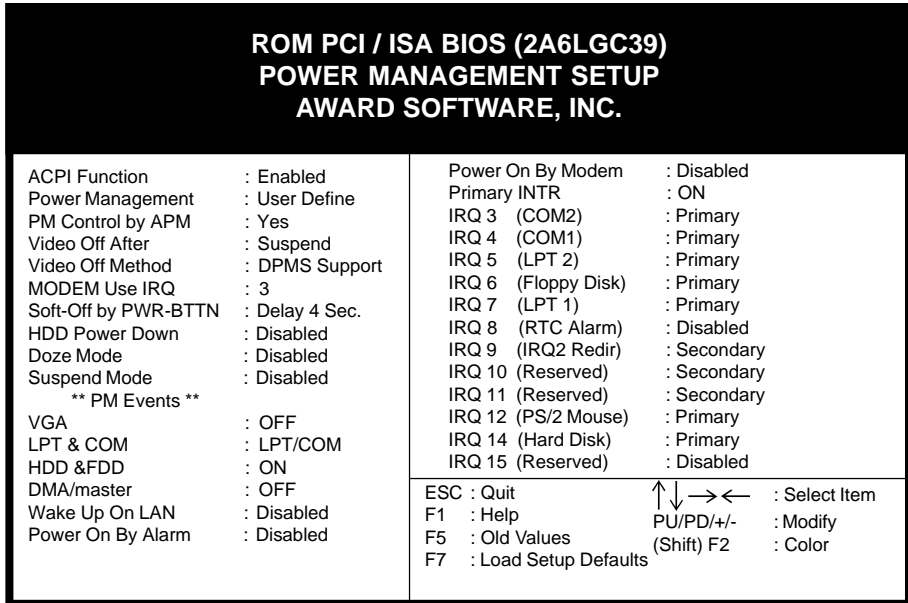

Figure 3-5 Power Management Setup Screen

A. Advanced Configuration Power Interface (ACPI)

ACPI management enables the operating system to control the amount of power given to each device attached to the computer. With ACPI, the operating system can turn off peripherals devices, such as CD-ROM players, when they are not in use.

B. Power Management

Power management allows the computer to save electricity when it is not in use by entering increasingly deep power saving modes as shown by the diagram below.

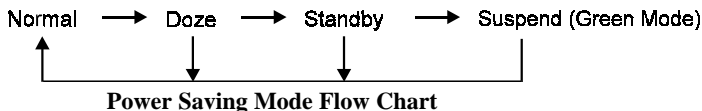

The computer runs in Normal operation mode until the Doze timer expires, at which point the computer enters Doze mode. If no external activity occurs, the computer will go into Standby and Suspend modes when their respective timers expire. If external activity occurs, the computer will wake up from Power Management and return to Normal mode. To activate the function, set Power Management to Maximum Saving, User Define, or Minimum Saving described below. For a description of the power saving modes (Doze, Standby, and Suspend) see their descriptions below.

Max. Saving - All timers are set at the minimum value of one minute to maximize power saving.

Min. Saving - All timers are set at the maximum value of one hour for minimal power saving.

User Define - User can configure the timer to a desired time according to the values available.

Note that enabling the Power Management function will result in enabling the  HDD Power Down function (Max Saving = 15 min, Min Saving = 1 min). The HDD Power Down function is not part of the Power Management scheme as indicated in Figure 3-5. Refer to the Standby Mode, Suspend Mode, and HDD Power Down descriptions below for more information on hard drive power management.

C. PM Control by APM

This function allows software other than BIOS to control Power Management features. Enable this function in BIOS and make sure APM (Advanced Power Management) is present. For example, run the Power utility program located in the DOS directory, C:\DOS\POWER.EXE to use Power Management features under DOS. For Windows 3.1x and Windows 95, you need to install Windows with the APM feature.

D. Video Off After

This setting determines when the monitor enters power saving mode. As the function name indicates, the monitor enters the power saving mode after the chosen event expires. The Power Management function must be enabled to use this function.

E. Video Off Method

This function serves as both a screen saver and power saver for monitors. See the next function, Video Off After, for setting the video timer.

Blank - BIOS will only blank the monitor's screen. The electricity saved in this mode is negligible and this function is only used as a screen saver to prevent screen damage while the screen is on but not in use.

V/H SYNC+Blank - The system turns off the vertical and horizontal synchronization ports, writes blanks to the VGA buffer and the monitor's electron gun turns off. This function requires a monitor with Green features in order to take advantage of the power saving function. If you enable this function and do not have a Green monitor, the result will be the same as if you had selected Blank. This function serves as both a screen saver and an electricity saver.

DPMS Supported - Select this option if your video card supports the Display Power Management Signaling (DPMS) standard (i.e., you have a monitor that supports Green features). Use software supplied by your video subsystem to set video power management options.

F. Modem Use IRQ

If your computer has an modem, use this function to tell BIOS which IRQ is being occupied by the modem card. When the system is in Green mode, the modem requires an IRQ assignment to wake up the system and perform tasks. This assignment is compliant with the APM 1.2 specification and is to be used in coordination with APM 1.2 compliant operating systems.

G. Soft-Off by PWR-BTTN

When set to Delay 4 Sec., this function allows the power button to put the system in Suspend, a power saving mode. See Section 2-4 for operation instructions of the over-ride power button operation which puts the system in Suspend mode. When set to Instant-Off the Soft-Off by PWR-BTTN function is disabled and the computer turns completely off when the power button is pressed.

H. HDD Power Down

The Power Management function must not be set to disabled to enable this function. When the HDD idle time has elapsed, BIOS sends a command to the hard disk to turn off the motor. Set a time between 1 and 15 to indicate time required to wait before the hard drive enters a power saving mode. Some old hard drives may not support this function.

I. Doze Mode

The Power Management function must not be set to disabled to enable this function. If no interrupts have occurred and the Doze timer expires, system will enter Doze mode. In Doze mode, the CPU clock runs at a lower speed while all other devices operate normally.

- ✎ Power saving modes achieved in lower power saving states will either be maintained or enter higher power saving modes when switching to higher power saving states. For example, the CPU clock will not switch back to normal in Standby mode. It will maintain a decreased rate in Standby Mode and turn off in Suspend Mode.

J. Suspend Mode

The Power Management function must not be set to disabled to enable this function. If the system runs in Standby mode and the Suspend timer expires, all devices regulated by power management will shut off and the CPU speed will be 0 MHz.

K. VGA

Enable this selection to set the LAN awakening the system function .

L. LPT & COM

When On of LPT & COM, any activity from one of the listed system peripheral devices or IRQs wakes up the system.

M. HDD & FDD

When On of HDD & FDD, any activity from one of the listed system peripheral devices wakes up the system.

N. DMA/Master

When you are On DMA/ISA Master, any activity from one of the listed system peripheral devices or IRQs wakes up the system.

O. Wake Up On LAN

Enable this selection to use the Wake Up On LAN function discussed in Section 2-4 of this manual.

P. Power On By Alarm

When enabled, this setting allows the system to turn back on at a designated time of the month. User must designate date of month and time of day. This function is only available when using an ATX power supply and the Software Power-Off function to turn off the computer. See the Software Power-Off feature in Section 2-4 of this manual for instructions.

Q. Power On By Modem

When enabled, a modem that receives a call will wake up the system from soft off and green mode. You should connect the modem to the COM port and turn on the resume event in green mode.

R. Primary INTR

When set to On, any event occurring at will awaken a system which has been power down.

- ✎ The following listed IRQ'S, (see figures 3-6) which can be exempted much as the COM ports and LPT ports can. When an I/O device wants to gain the the attention of the operating system, it send signals causing an IRQ to occur. When the operating system is ready to respond to the request, it interrupts itself and performs the service.

3-5 PNP/PCI Configuration

This section provides IRQ and DMA setting information. By choosing the PNP/PCI Configuration option from the CMOS Setup Utility menu (Figure 3-1), the screen below is displayed. This sample screen contains the manufacturer's default values for the mainboard.

ROM PCI / ISA BIOS (2A6LGC39) PNP/PCI CONFIGURATION AWARD SOFTWARE, INC.	
PNP OS Installed : No	CPU to PCI Write Buffer : Enabled
Resources Controlled By : Manual	PCI Dynamic Bursting : Enabled
Reset Configuration Data : Disabled	PCI Master 0 WS Write : Enabled
IRQ-3 assigned to : PCI/ISA PnP	PCI Delay Transaction : Enabled
IRQ-4 assigned to : PCI/ISA PnP	PC#2 Access #1Retry : Disabled
IRQ-5 assigned to : PCI/ISA PnP	AGP Master 1 WS Write : Enabled
IRQ-7 assigned to : PCI/ISA PnP	AGP Master 1 WS Read : Disabled
IRQ-9 assigned to : PCI/ISA PnP	Assign IRQ For USB : Enabled
IRQ-10 assigned to : PCI/ISA PnP	Assign IRQ For VGA : Enabled
IRQ-11 assigned to : PCI/ISA PnP	FDD IRQ Can Be Free : Yes
IRQ-12 assigned to : PCI/ISA PnP	Slot 1 Use IRQ No. : Auto
IRQ-14 assigned to : PCI/ISA PnP	Slot 2 Use IRQ No. : Auto
IRQ-15 assigned to : PCI/ISA PnP	Slot 3 Use IRQ No. : Auto
DMA-0 assigned to : PCI/ISA PnP	Audio Use IRQ No. : 5
DMA-1 assigned to : PCI/ISA PnP	ESC : Quit
DMA-3 assigned to : PCI/ISA PnP	F1 : Help
DMA-5 assigned to : PCI/ISA PnP	F5 : Old Values
DMA-6 assigned to : PCI/ISA PnP	F7 : Load Setup Defaults
DMA-7 assigned to : PCI/ISA PnP	↑ ↓ → ← : Select Item
	PU/PD/+/- : Modify
	(Shift) F2 : Color

Figure 3-6 PCI & ONBOARD I/O Setup Screen

A. PNP OS Installed

If you want to install a PNP compatible OS (such as Windows 95) set to Yes.

B. Resources Controlled By

When set to Manual the system BIOS will not refer to the ESCD for IRQ & DMA information. Instead, it will refer to the items in the setup menu for assigning IRQ & DMA. When set to Auto the system BIOS will refer to the ESCD for all legacy information.



ESCD(Extended System Configuration Data) provides a detailed format of the configuration data structures stored in flash memory. Each data structure defines the resources used by a device or a card in the system. This includes legacy and PCI/ISA PnP devices.

C. Reset Configuration Data

When enabled the system BIOS will clear/reset the ESCD during POST. After clearing the ESCD, the BIOS will then change this item's value to Disabled. Otherwise, the ESCD data will become useless.

D. IRQ#/DMA# assign to

When resources are controlled manually, you can assign each system interrupt & DMA channel for "Legacy ISA" or "PCI/ISA PnP" card used. While using **Legacy ISA Card** (non-PnP ISA card), please set it's necessary corresponding resources (INT#, DMA#) from "PCI/ISA PnP" to "Legacy ISA."

- ☞ All ISA non-PnP devices are legacy devices that select resources (I/O Addr., INT# or DMA#) by using hardware jumpers.
- ☞ IRQ-3/4/7/12/14/15 have been set as default for on board devices (COM2, COM1, Printer port, PS/2 mouse, IDE1 and IDE2).

E. CPU to PCI Write Buffer

When Enabled, CPU to the PCI bus are buffered, to compensate for the speed differences between the CPU and the PCI bus.

F. PCI Delay Transaction

The chipset has an embedded 32-bit posted write buffer to support delay transactions cycles. Select Enabled to support compliance with PCI specification version 2.1.

G. Assign IRQ For USB

If USB is employed this function must be Enabled. Otherwise, disable this function to optimize Windows 95 IRQ resources for other IRQ usage. N/A (disabled.)

H. Assign IRQ For VGA

This function allows BIOS to make an IRQ available to VGA cards. Most current VGA card models do not require this function to be enabled.

I. FDD IRQ Can Be Free

This function allows user to choose if the FDD IRQ is able to be freed up. The default setting is Yes and this does not allow the IRQ to be free.

3-6 Load Setup Defaults

Load Setup Defaults loads the default system values directly from the CMOS Setup Utility menu (Figure3-1). If the stored record created by the setup program becomes corrupted and therefore unusable, these defaults will be loaded automatically when you turn on the computer.

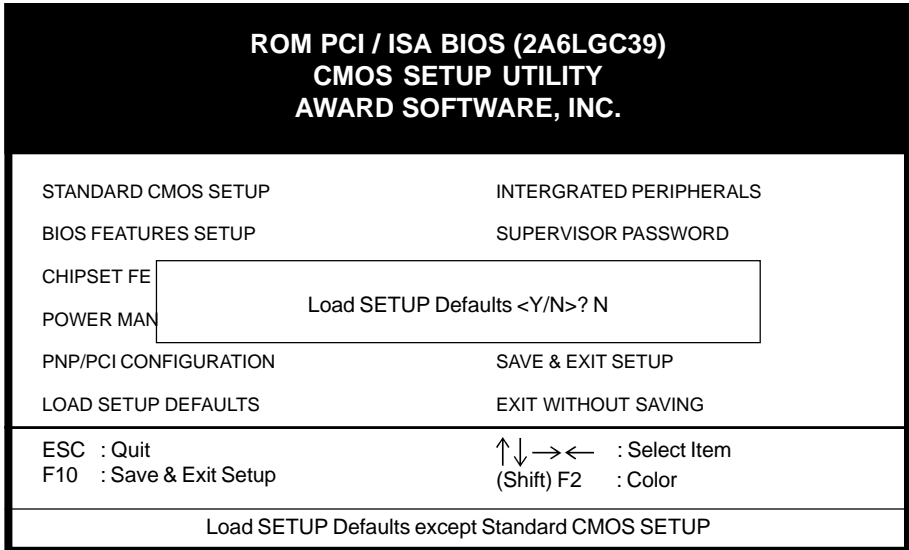

Figure 3-7 Load Setup Defaults Screen

3-7 Integrated Peripherals

This section provides information on setting peripheral devices. By choosing the Integrated Peripherals option from the CMOS Setup Utility menu (Figure 3-1), the screen below is displayed. This sample screen contains the manufacturer's default values for the mainboard.

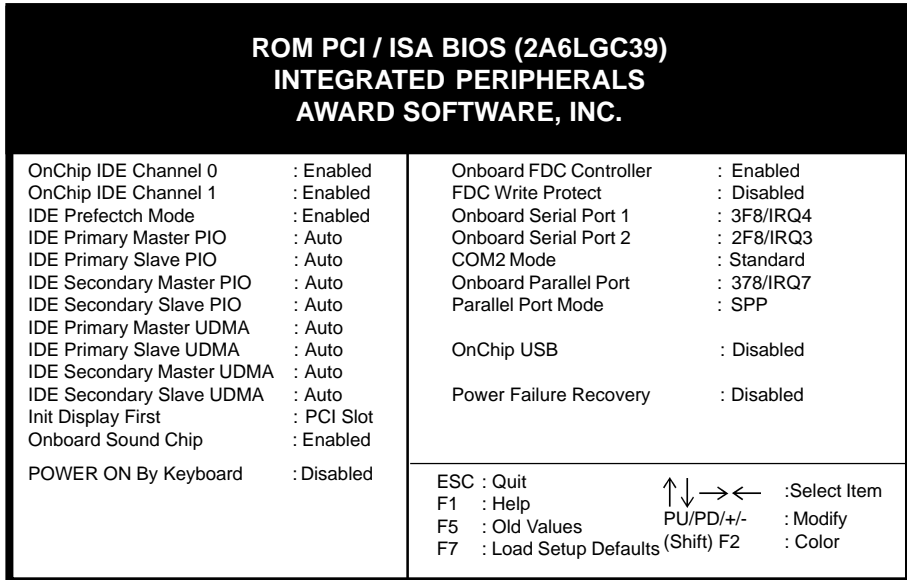

Figure 3-8 Integrated Peripherals Setup Screen

A. On Board IDE Control

IDE HDD Block Mode

Specify the maximum number of sectors that can be transferred at a time.

IDE Primary/Secondary Master/Slave PIO

The four IDE PIO (programmed Input/Output) fields let you set a PIO mode (0-4) for each IDE device that the internal PCI IDE interface supports. Modes 0 through 4 provide successively increased performance. In Auto mode, the system automatically determines the best mode for each device.

On-chip Primary/Secondary PCI IDE

You can set this to disable the On-chip IDE controller if you are going to add a higher performance IDE board.

B. Init Display First

This function allows user to choose between AGP slot or VGA slot to initialise Display first .

C. Onboard Sound Chip

This function must be enabled in order to use the onboard audio function. To terminate this function set it to disable.

D. Power On By Keyboard

Set to Disabled to control your computer's power by the button on your system case. Set this function to Any Key to turn on the computer by touching any key on the keyboard. If you set this function to Hot Key or Password you must designate the keystrokes that will turn on the computer.

E. Onboard FDC Controller

Select Enabled if your system has a floppy disk controller (FDC) installed on the system board and you wish to use it. If you install an add-in FDC or the system has no floppy drive, select Disabled in this field.

F. Com2 Mode

When set to Enabled, the COM port will be redirected to support IR function.

G. Onboard Parallel Port

Select a logical LPT port address and corresponding interrupt for the physical parallel port.

H. Parallel Port Mode

Select an operating mode for the onboard parallel (printer) port. Select Normal, Compatible, or SPP unless you are certain your hardware and software both support one of the other available modes

I. Power Failure Recovery

Computers using an ATX power supply do not turn back on after the power source to the computer unexpectedly fails (i.e. electricity outage). Enabling this setting will allow the system to always turn back on after a power failure. This is especially important for computers that must be on 24 hours per day.

3-8 Supervisor Password & User Password Setting

There are four different variables that control password settings. The first two are located under the Security Option function in BIOS Features Setup Menu (Figure 3-3). When the Security Option function is set to Setup, a password is required to enter BIOS and change BIOS settings. When the Security Option function is set to System, a password is required to enter both BIOS and the the computer's operating system (for example Windows 95) found on the boot drive. This is shown in Figures 3-9 and 3-10.

The third and fourth variables are user password and supervisor password selected in BIOS (Figure 3-1). The main purpose of separating user and supervisor is to allow only the supervisor to have control over the settings in BIOS. The user, on the other hand, is only allowed to access the computer's operating system and change the user password in BIOS (See Figure 3-10). Note that when there is no supervisor password set, the user password controls access to all BIOS settings (See Figure 3-9 below).

A. Set Either Supervisor Password or User Password

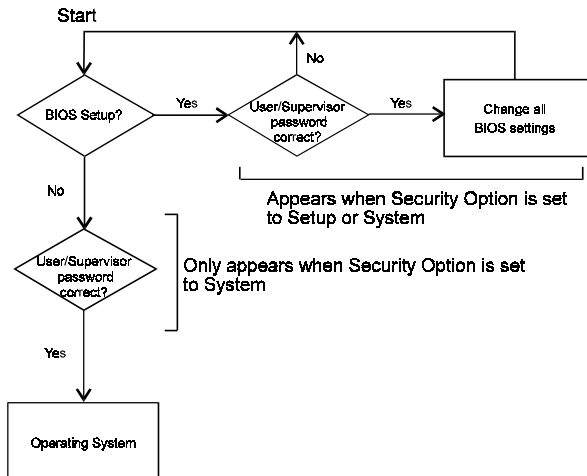

Figure 3-9 Set Either Supervisor or User Password

B. Set Both Supervisor Password and User Password

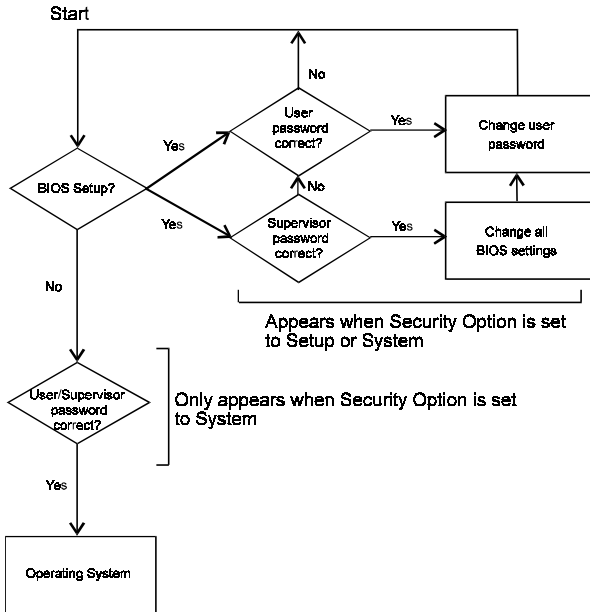

Figure 3-10 Set Both Supervisor and User Password

3-9 IDE HDD Auto Detection

This utility can automatically detect IDE hard disk type and parameters. The detection process take about 5 seconds for each physical drive. After the utility detects the disk drive, type Y and press [Enter] to automatically load the parameters in the Hard Disk section of the Standard CMOS Setup menu. Otherwise, leave the option set at N and press [Enter] or the [Esc] key to skip the detected drive. After detecting your hard drive(s), return to the Standard CMOS menu to check your settings.

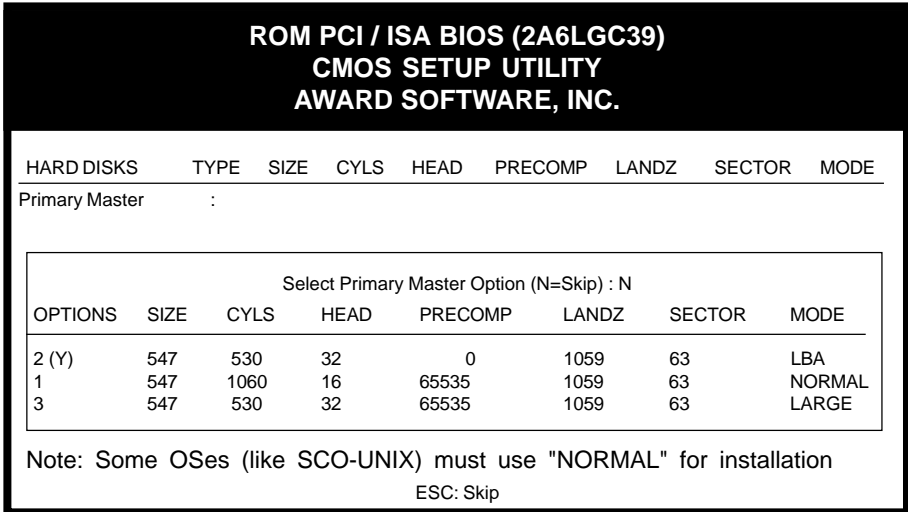

Figure 3-11 IDE HDD Auto Detection Screen

3-10 Save and Exit Setup

If you select this and type Y (for yes) followed by the [Enter] key, the values entered in the setup utilities will be recorded in the CMOS memory of the BIOS chip.

3-11 Exit Without Saving

Selecting this option and pressing Y followed by the [Enter] key lets you exit the Setup program without recording any new values or changing old ones.



Memo

Brief Software Driver Guide

The Mainboard Software Guide is found on the CD-ROM that is enclosed with your mainboard and is a PDF file which must be viewed with Adobe's freeware called Acrobat® Reader. The Acrobat Reader software is also included on the same CD-ROM. See the Readme.txt file in the CD-ROM's root directory for installation instructions of the Acrobat Reader. The Mainboard software guide discusses the following items:

The following items are discussed in the PDF files:

- Bus Master/PIO IDE Driver Installation
- USB Driver Installation
- Removing the Exclamation and/or Question Marks From the Windows 95 Device Manager Menu
- Updating Your System BIOS
- Installing and Using a Desktop Management Interface (DMI) Utility for DOS
- Sound Driver and Utility Installation
- Optional AIRBAG software group including Norton Ghost, Norton AntiVirus and High Point Xstore Pro



The DMI utility is a DOS utility, operating under Windows or other operating system might cause damage to the BIOS.



Memo

Audio Subsystem

5-1 Feature

- **ESS PCI audio Solo-1** (ES1938S-G) subsystem on a single chip.
- Advance wavetable synthesizer using wavedata on the system memory.
- Up to 48KHz programmable sample rate for record and playback.
- Intergrated Spatializer 3D effects Processor.
- Advance power management meets ACPI standards.
- Full duplex operation for simultaneous record and playback.



5-2 Sound Driver and Utility (See Chapter 4)

5-3 CD-ROM Audio-in Connection (See Section 2-4)



Memo

Appendix I

On Board I/O Addresses & IRQ Maps

System Resource	IRQ	I/O Address
1. Timer	IRQ0	040, 043
2. Keyboard	IRQ1	060, 064
3. Programmable INT	IRQ2	0020, 0021, 00A0, 00A1
4. COM2(B)	IRQ3	2F8, 2FF
5. COM1(A)	IRQ4	3F8, 3FF
6. Floppy	IRQ6	3F0, 3F7
7. LPT1	IRQ7	378, 37F
8. Real Time Clock	IRQ8	070, 071
9. PS/2 Mouse	IRQ12	060, 064
10. Math coprocessor	IRQ13	0F0, 0FF
11. IDE 1	IRQ14	1F0, 1F7
12. IDE 2	IRQ15	170, 177

⚠ IRQ 5, 9, 10 and 11 are available for interface cards.



Memo