

Notice to End Users

This User's Guide & Technical Reference is for assisting system manufacturers and end users in setting up and installing the mainboard.

Every effort has been made to ensure that the information in this manual is accurate. Soltek Computer Inc. is not responsible for printing or clerical errors. Information in this document is subject to change without notice and does not represent a commitment on the part of Soltek Computer Inc.

No part of this manual may be reproduced, transmitted, translated into any language in any form or by any means, electronic or mechanical, including photocopying and recording, for any purpose without the express written permission of Soltek Computer Inc.

Companies and products mentioned in this manual are for identification purposes only. Product names appearing in this manual may or may not be registered trademarks or copyrights of their respective companies.

SOLTEK COMPUTER INC. PROVIDES THIS MANUAL "AS IS" WITHOUT WARRANTY OF ANY KIND, EITHER EXPRESS OR IMPLIED, INCLUDING BUT NOT LIMITED TO THE IMPLIED WARRANTIES OR CONDITIONS OF MERCHANTABILITY OR FITNESS FOR A PARTICULAR PURPOSE. IN NO EVENT SHALL SOLTEK COMPUTER INC. BE LIABLE FOR ANY LOSS OR PROFITS, LOSS OF BUSINESS, LOSS OF USE OR DATA, INTERRUPTION OF BUSINESS, OR FOR INDIRECT, SPECIAL, INCIDENTAL, OR CONSEQUENTIAL DAMAGES OF ANY KIND, EVEN IF SOLTEK COMPUTER INC. HAS BEEN ADVISED OF THE POSSIBILITY OF SUCH DAMAGES ARISING FROM ANY DEFECT OR ERROR IN THIS MANUAL OR PRODUCT.

© Copyright 1998 Soltek Computer Inc. All right reserved

Web site: <http://www.soltek.com.tw>
email: support@mail.soltek.com.tw

Edition: July 1998
Version: 1.0
SL-67B SERIALS



Contents

Chapter 1: Introduction -----	1
Features-----	1
CPU -----	1
Chipset -----	1
L2 Cache -----	1
Main Memory -----	1
BIOS-----	2
Super I/O Function -----	2
Other Functions -----	2
Mainboard Layout with Default Settings -----	3
Chapter 2: Hardware Setup-----	4
CPU Type Configuration-----	4
CPU 3.5X Clock Setting -----	4
Deschutes – 350/100MHz -----	4
Pentium II – 233/66MHz -----	4
CPU 4.0X Clock Setting -----	5
Deschutes – 400/100MHz -----	5
Pentium II – 266/66 MHz -----	5
CPU 4.5X Clock Setting -----	5
Deschutes – 450/100MHz -----	5
Pentium II – 300/66 MHz -----	5
CPU 5.0X Clock Setting -----	5
Deschutes – 500/100MHz -----	5
Pentium II – 333/66 MHz -----	5
System Memory Configuration-----	6
CPU Installation-----	6

Jumper Settings-----	10
JP2: Keyboard Power Selection-----	10
XFAN 1: Onboard FAN (12V) Connector-----	11
JBAT1: Clear CMOS Data-----	11
JP6: Power Lost Resume-----	11
JP3, JP4: USB Port Select-----	12
JVGA1: VGA Card-----	12
SW1: 5–6 Bus Clock Select-----	12
SW1: 1–4: Bus Ratio Select-----	13
IDE LED Activity Light: (J2 pin1–4)-----	13
Infrared Port Module Connector (J2 pin6–10)-----	14
J2 pin12, 13: PWR Switch-----	14
SLEEP Switch (J2 pin14, 15)-----	14
Speaker Connector (J3 pin1–4)-----	14
Reset Switch (J3 pin5, 6)-----	14
J1: Audio Socket (SB Link)-----	14
Power LED and Keylock Switch (J3 pin8–12)-----	14
JWOL1: Wake On Lan (WOL) Connector-----	15
Green LED (J3 pin14, 15)-----	15
J2 Switch Signal Summary-----	16
J3 Switch Signal Summary-----	17

Chapter 3: BIOS Setup ----- 18

Standard CMOS Setup-----	19
BIOS Features Setup-----	21
Chipset Features Setup-----	25
Power Management Setup-----	29
PnP/PCI Configuration Setup-----	33
Load Setup Defaults-----	35
Integrated Peripherals-----	36
Supervisor/User Password-----	40
IDE HDD Auto Detection-----	41
Save & Exit Setup-----	41
Exit Without Saving-----	41

Chapter 1

Introduction

Features

CPU

1. Supports Intel Pentium II, Deschutes, and Celeron CPUs using SLOT1 at 233 ~ 533 MHz (PII/Celeron) or 800MHz (Deschutes)
2. Supports CPU voltage autodetect circuit
3. **Supports 66/100MHz Bus Clock with autodetect (BIOS provides 103/112 MHz Bus Clock without auto detect)**

Chipset

1. Intel 82440BX chipset
2. PCI Rev 2.1, 5V, 33MHz interface compliant
3. Supports AGP 1x/2x Mode, 3.3V AGP (Accelerated Graphics Port) slot

L2 Cache

1. PII (Deschutes) supports 256K/512k write back cache with Pipelined Burst SRAMs

Main Memory

1. Memory range from 8MB (minimum) to 1GB (SDRAM) (maximum) with DRAM Table Free configurations
2. Supports SDRAM with 12/10/8ns DRAM speed
3. **Supports 4 pcs 168pin DIMM sockets (3.3V Unbuffered type)**
4. DRAM supports ECC or Parity function

BIOS

1. AWARD Plug and Play BIOS
2. Supports Advanced Power Management Function
3. Flash Memory for easy upgrade

Super I/O Function

1. Integrated USB (Universal Serial Bus) controller with two USB ports.
2. Supports 2 IDE channels with 4IDE devices (including 120MB IDE floppy)
3. Provides PCI IDE Bus Master function and supports Ultra DMA33 function
4. One floppy port
5. Two high speed 16550 FIFO UART ports
6. One parallel port with EPP/ECP/SPP capabilities
7. PS/2 mouse connector
8. Built-in RTC, CMOS, keyboard controller on single I/O chip
9. Peripherals boot function (with ATX power)

Other Functions

1. ATX size 17cm x 30.5cm
2. 5 PCI Master slots, 2 ISA slots, and 1 AGP slot
3. Supports CPU temperature warning function (optional)
4. Provides DIP switch setting
5. **Supports 66/100MHz Bus Clock**
6. **Supports keyboard Power On function**
7. **Supports Wake On LAN function**
8. **Supports Power Lost Resume function**
9. **BIOS supports 103/112MHz Bus clock.**

Mainboard Layout with Default Settings

The default settings of the following figure is for the Pentium II (Celeron) 233/66MHz or Deschutes 350/100MHz.

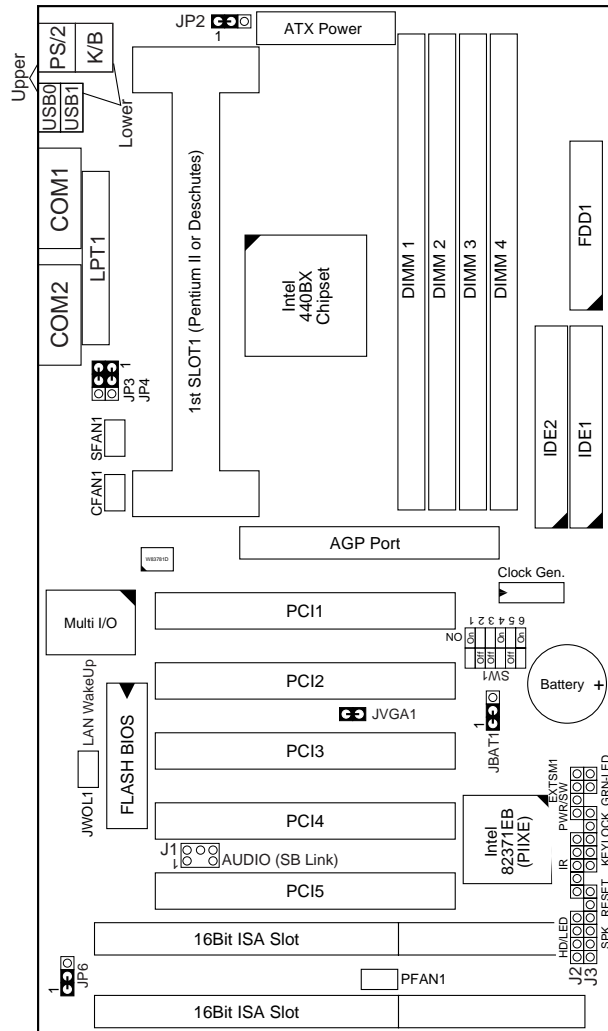

Figure 1-1. Motherboard Layout

Note: For 100MHz CPU environment, the SDRAM specification must comply with PC-100 spec.

Chapter 2

Hardware Setup

CPU Type Configuration

CPU 3.5X Clock Setting

Deschutes – 350/100MHz

Pentium II – 233/66MHz

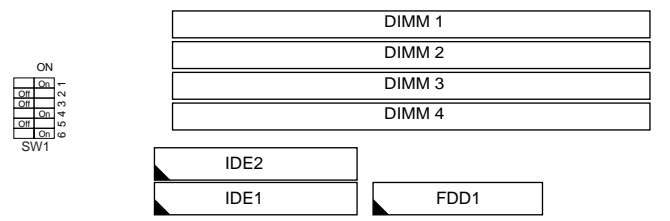

Figure 2-1. CPU Type Configuration

CPU 4.0X Clock Setting

Deschutes – 400/100MHz

Pentium II – 266/66 MHz

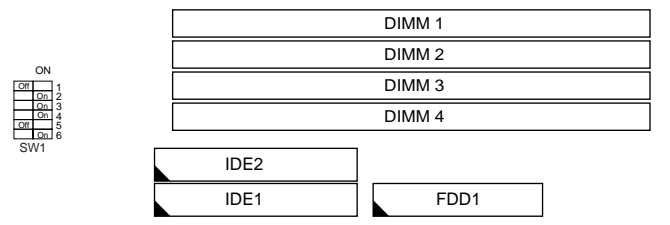

Figure 2–2. CPU Type Configuration

CPU 4.5X Clock Setting

Deschutes – 450/100MHz

Pentium II – 300/66 MHz

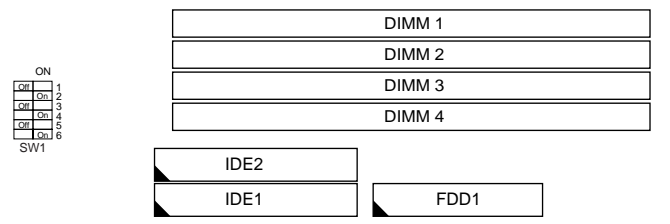

Figure 2–3. CPU Type Configuration

CPU 5.0X Clock Setting

Deschutes – 500/100MHz

Pentium II – 333/66 MHz

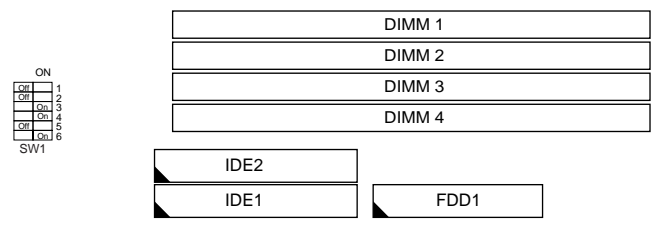

Figure 2–4. CPU Type Configuration

System Memory Configuration

This 82440BX motherboard supports 168 pin DIMM of 4MB, 8MB, 16MB, 32MB or 64MB to form a memory size between 8MB to 1GB (SDRAM). 82440BX chipsets provide "Table-Free" function. It means that users can install DRAM with any configuration and in any bank, and that is why the DRAM table is not needed but do remember that the DRAM must be 3.3V type. **For 100MHz CPU environment, the SDRAM specification must comply with PC-100 spec.**

CPU Installation

Follow the following steps in order to install your Intel Pentium II, Celeron, and Deschutes properly.

Step 1:

Be sure you are in contact with heat sink vendors for attaching the heat sink on to the CPU.

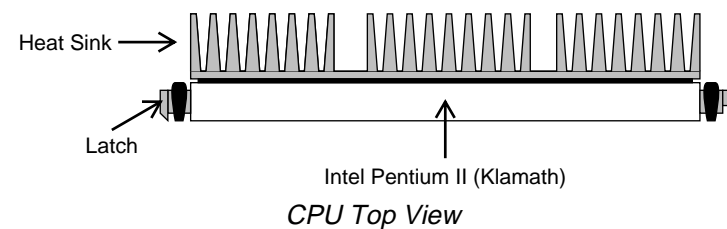
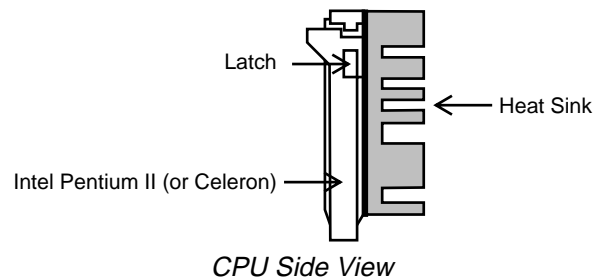

Notice that the heat sink may be different from the drawings shown here.

Step 2:

Install the 2 pairs of screws, which are shown in the following drawing, onto the mainboard under the SLOT1 Socket.

Two of the screws are right around the SLOT1 Socket and the other pair of screws should be inserted opposite the first pair. The screws should be inserted from the bottom of the motherboard upward.

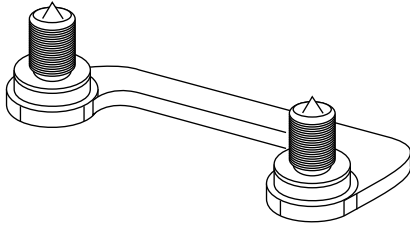

Step 3:

Retention clip is shown in the following figure:

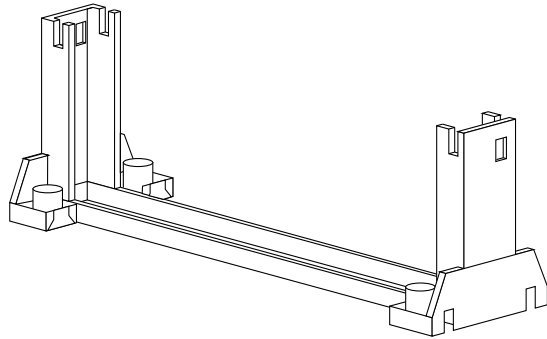

Set the board according to the following diagram before installing the retention clip.

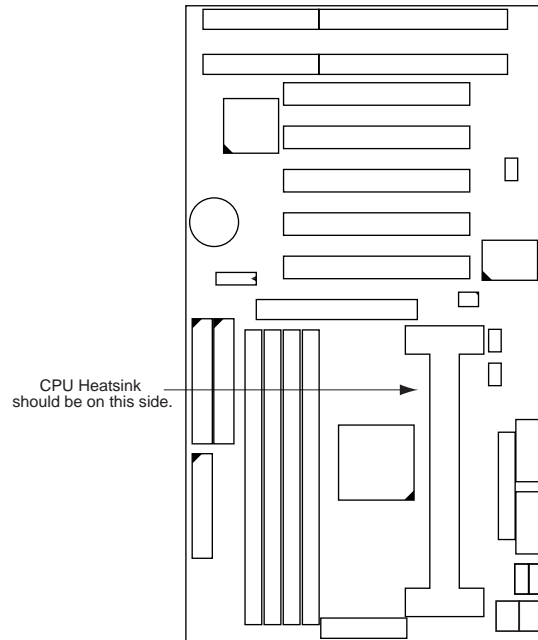

The retention clip should be inserted so that the small rectangle window is more toward to the right hand side of the board.

If installed incorrectly, you will not be able to insert the CPU into the retention clip and in this situation you might need to rotate the retention clip by 180°.

Tighten the 4 screws on the retention clip till the neck of the screws can not be seen from the bottom of the board

Step 4:

Pull the latches up on the base of the CPU supporter and insert it into the two holes directly to the left of the retention clip so that the larger hole is on the bottom.

Press the base of the CPU supporter down in to the holes and lock the latches.

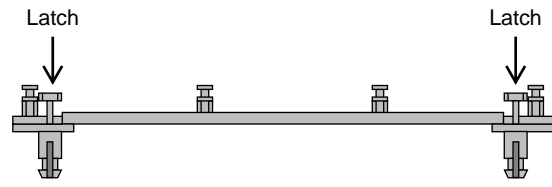

Side View of CPU Supporter Base

Step 5:

Flatten the two latches on the side of CPU. Insert the CPU into the retention clip and notice that the heat sink is on the right hand side of the board. Lock the two latches to secure the CPU.

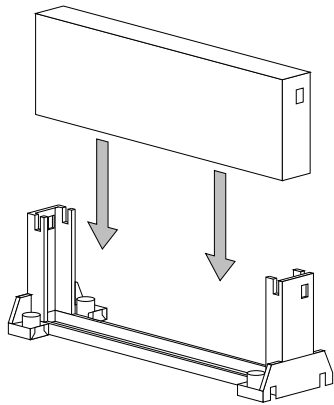

Step 6:

Insert the clip portion of the CPU supporter so that the heat sink can sit on the top of the whole CPU supporter.

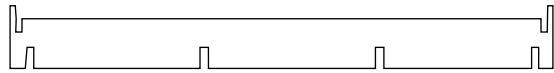



Top View of CPU Support Clip

Notice that the base and the clip of CPU Supporter may be different from the figures shown here.

Jumper Settings

JP2: Keyboard Power Selection

Keyboard Power On	JP2
Disabled (default)	 1 3
Enabled	 1 3



- Note:**
1. If the JP2 is fixed by jumperwire then the board does not support keyboard power on function.
 2. When the keyboard power on function shows any compatible problem, choose Disabled and report the keyboard model to the vendor/maker.
 3. Keyboard power on function must be set from the BIOS. Refer to the "Integrated Peripherals" section in the Chapter 3.

XFAN 1: Onboard FAN (12V) Connector

FAN#	Function
SFAN1	System FAN
CFAN1	CPU FAN
PFAN1	Chasis FAN



JBAT1: Clear CMOS Data

Clear the CMOS memory by shorting this jumper momentarily; then remove the cap to retain new settings.

CMOS Data	JBAT1
Clear Data	
Retain Data (default)	

JP6: Power Lost Resume



This jumper allows you to use the switch of ATX power supply to control on/off switch directly instead of using the power switch on the mainboard.

Power Lost Resume	JP6
Normal (default)	
Enabled	

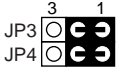
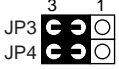
JP3, JP4: USB Port Select



USB Port	JP3/JP4
Redirect all USB ports to USB connector (default)	
Redirect USB1 to AGP port	

JVGA1: VGA Card

	JVGA1
For Special VGA Card*	
Normal (default)	

Note: This jumper is set for the special VGA card. Open this jumper when the system isn't able to boot

SW1: 5-6 Bus Clock Select

Bus Clock	SW: 5-6
66MHz	 On
100MHz	 On
Auto Detect (default)	 On

SW1: 1–4: Bus Ratio Select

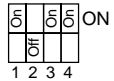
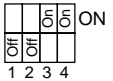
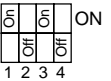
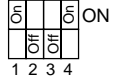
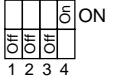
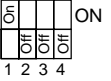
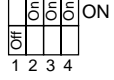
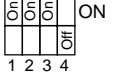
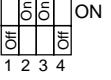
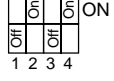
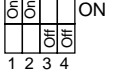
Bus Ratio	SW: 1~4	Bus Ratio	SW: 1~4	Bus Ratio	SW: 1~4
3.0x		5.0x		7.0x	
3.5x		5.5x		7.5x	
4.0x		6.0x		8.0x	
4.5x		6.5x			

IDE LED Activity Light: (J2 pin1–4)

This connector connects to the hard disk activity indicator light on the case.

Infrared Port Module Connector (J2 pin6–10)

The system board provides a 5-pin infrared connector—IR1 as an optional module for wireless transmitting and receiving. **Pin 6 through 10 are Transmit, GND, Receive (low speed), Receive (high speed), and Vcc, respectively.**

J2 pin12, 13: PWR Switch

Power Switch: Toggle this pin for turning on/off of the power supply (for ATX power only).

SLEEP Switch (J2 pin14, 15)

Toggle this jumper forces the system to sleep and the system won't wake up until the hardware event is coming. (The BIOS Power Management setting must be Enabled.)

Speaker Connector (J3 pin1–4)

The speaker connector is a 4-pin connector for connecting the system and the speaker. (See the following drawing for jumper position.)

Reset Switch (J3 pin5, 6)

The system board has a 2-pin connector for rebooting your computer without having to turn off your power switch. This prolongs the life of the system's power supply.

J1: Audio Socket (SB Link)

This socket is designed for using SoundBlast PCI sound card.

Power LED and Keylock Switch (J3 pin8–12)

The keylock switch is a 5-pin connector for locking the keyboard for security purposes. (See the following drawing for jumper position, and pin1~3 is connected to power LED and pin 4~5 is connected to keylock switch.)

JWOL1: Wake On Lan (WOL) Connector

This connector is designed to use Lan to bootup the system.
Connect the wake on signal from Lan card to this connector.

Green LED (J3 pin14, 15)

Reserved.

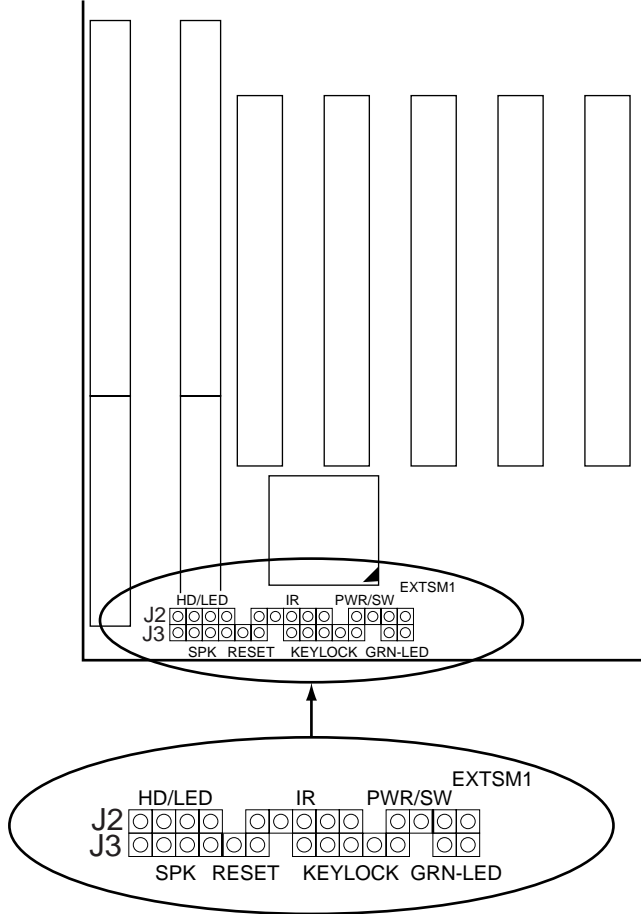

J2 Switch Signal Summary

J2	Pin	Signal Description
HDD LED Connector	1	+5V
	2	HDD LED Signal
	3	HDD LED Signal
	4	+5V
N.C.	5	No Connection
Infrared Connector	6	Infrared Transmit Signal
	7	GND
	8	Infrared Receive Signal (low speed)
	9	Infrared Receive Signal (high speed)
	10	+5V
N.C.	11	No Connection
PWR	12	GND
	13	Power Switch (for ATX Power)
SLEEP	14	GND
	15	Sleep Signal

J3 Switch Signal Summary

J3	Pin	Signal Description
Speaker Connector	1	Speaker Signal
	2	No Connection
	3	Ground
	4	+5V
Reset Switch	5	Reset Signal
	6	Ground
N.C.	7	No Connection
Power LED Connector	8	+5V
	9	No Connection
	10	Ground
Keylock Connector	11	Keylock Signal
	12	GND
N.C.	13	No Connection
Power Saving Connector	14	No Connection
	15	No Connection

Chapter 3

Award BIOS Setup

This 82440BX motherboard comes with the AWARD BIOS from AWARD Software Inc. Enter the Award BIOS program's Main Menu as follows:

1. Turn on or reboot the system.

After a series of diagnostic checks, the following message will appear:

PRESS TO ENTER SETUP

2. Press the key and the main program screen appears as in the following page.

ROM PCI/ISA BIOS
CMOS SETUP UTILITY
AWARD SOFTWARE, INC.

STANDARD CMOS SETUP	INTEGRATED PERIPHERALS
BIOS FEATURES SETUP	SUPERVISOR PASSWORD
CHIPSET FEATURES SETUP	USER PASSWORD
POWER MANAGEMENT SETUP	IDE HDD AUTO DETECTION
PNP/PCI CONFIGURATION	SAVE & EXIT SETUP
LOAD SETUP DEFAULTS	EXIT WITHOUT SAVING
Esc : Quit	↑ ↓ → ← : Select Item
F10 : Save & Exit Setup	(Shift) F2 : Change Color
Time, Date, Hard Disk Type...	

- Using one of the arrows on your keyboard to select an option and press <Enter>. Modify the system parameters to reflect the options installed in the system.
- You may return to the Main Menu anytime by press <ESC> .
- In the Main Menu, "SAVE AND EXIT SETUP" saves your changes and reboots the system, and "EXIT WITHOUT SAVING" ignores your changes and exits the program.

Standard CMOS Setup

Standard CMOS Setup allows you to record some basic system hardware configuration and set the system clock and error handling. You only need to modify the configuration values of this option when you change your system hardware configuration or the configuration stored in the CMOS memory got lost or damaged.

Run the Standard CMOS Setup as follows:

- Choose "STANDARD CMOS SETUP" from the Main Menu and a screen with a list of options appears.

```

ROM PCI/ISA BIOS
STANDARD CMOS SETUP
AWARD SOFTWARE, INC.

Date (mm:dd:yy) : Thu, May 9 1996
Time (hh:mm:ss) : 15 : 45 : 10

HARD DISKS      TYPE  SIZE  CYLS HEAD  PRECOMP  LANDZ  SECTOR  MODE
-----
Primary Master  : Auto   0      0   0      0      0      0   Auto
Primary Slave   : Auto   0      0   0      0      0      0   Auto
Secondary Master : Auto   0      0   0      0      0      0   Auto
Secondary Slave : Auto   0      0   0      0      0      0   Auto

Drive A : 1.44M, 3.5 in.
Drive B : None

Video : EGA/VGA
Halt On : All Errors

Base Memory: 640K
Extended Memory: 15360K
Other Memory: 384K
-----
Total Memory: 16384K

Esc : Quit      ↑ ↓ → ← : Select Item  PU/PD/+/- : Modify
F1 : Help      (Shift) F2 : Change Color

```

- Use one of the arrow keys to move between options and modify the selected options by using PgUp/PgDn/+/- keys.

A short description of screen options follows:

- Date (mm:dd:yy)** Set the current date and time.
- Time (hh:mm:ss)**

- Primary (Secondary) Master/Slave** This field records the specifications for all non-SCSI hard disk drives installed in your system. Refer to the respective documentation on how to install the drivers.

- Drive A/B** Set this field to the types of floppy disk drives installed in your system. The choices are:
360KB, 5.25 in.,
1.2MB, 5.25 in.,
720KB, 3.5 in.,
1.44M, 3.5 in. (default),
2.88MB, 3.5 in., or None

- Video** Set this field to the type of video display card installed in the system. The choices are: Monochrome; Color 40x25; VGA/EGA (default); or Color 80x25

- Halt On** Set this field to the type of errors that will cause the system to halt. The choices are: All Errors (default); No Errors; All, But Keyboard; All, But Diskette; or All, But Disk/Key

3. Press <ESC> to return to the Main Menu when you finish setting up in the "Standard CMOS Setup".

BIOS Features Setup

BIOS Features Setup allows you to improve your system performance or set up some system features according to your preference.

Run the BIOS Features Setup as follows:

1. Choose "BIOS FEATURES SETUP" from the Main Menu and a screen with a list of options appears.

```
ROM PCI/ISA BIOS
BIOS FEATURES SETUP
AWARD SOFTWARE, INC.
```

Virus Warning	: Disabeld	Video BIOS Shadow	: Enabled
CPU Internal Cache	: Enabled	C8000-CBFFF Shadow	: Disabled
External Cache	: Enabled	CC000-CFFFF Shadow	: Disabled
CPU L2 Cache ECC Checking	: Enabled	D0000-D3FFF Shadow	: Disabled
Quick Power on Self Test	: Enalbed	D4000-D7FFF Shadow	: Disabled
Boot Sequence	: A,C, SCSI	D8000-DBFFF Shadow	: Disabled
Swap Floppy Drive	: Disabled	DC000-DFFFF Shadow	: Disabled
Boot Up Floppy Seek	: Enabled		
Boot Up NumLock Status	: On		
Gate A20 Option	: Fast		
Typematic Rate Setting	: Disabled		
Typematic Rate (Chars/Sec)	: 6		
Typematic Delay (Msec)	: 250		
Security Option	: Setup		
PCI/VGA Palette Snoop	: Disabled	ESC : Quit	↑ ↓ → ← : Select Item
Assign IRQ For VGA	: Enabled	F1 : Help	PU/PD/+/- : Modify
OS Select for DRAMs>64MB	: Non-OS/2	F5 : Old Values (Shift)	F2 : Color
Report No FDD For WIN 95	: No	F6 : Load BIOS Defaults	
		F7 : Load Setup Defaults	

2. Use one of the arrow keys to move between options and modify the selected options by using PgUp/PgDn/+/- keys. An explanation of the <F> keys follows:
 - <F1>: "Help" gives options available for each item.
 - Shift <F2>: Change color.
 - <F5> : Get the previous values. These values are the values with which the user started the current session.
 - <F6>: Load all options with the BIOS default values.
 - <F7>: Load all options with the Setup default values.

A short description of screen options follows:

- Virus Warning** Enabled: Activates automatically when the system boots up causing a warning message to appear if there is anything attempts to access the boot sector or hard disk partition table.
Disabled: No warning message will appear when there is something attempts to access the boot sector or hard disk partition table
Note: Many diagnostic (or boot manager) programs which attempt to access the boot sector table can cause the above warning message. If you will be running such a program, we recommend that you disable the virus protection first.
- CPU Internal Cache** Choose Enabled (default) or Disabled. This option allows you to enable or disable the CPU's internal cache.
- External Cache** Choose Enabled (default) or Disabled. This option allows you to enable or disable the external cache memory.
- Quick Power On Self Test** Choose Enabled (default) or Disabled. This option allows you to speed up the Power On Self Test routine.

Boot Sequence	Default is "A, C, SCSI". This option determines which drive to look for first for an operating system.
Swap Floppy Drive	Choose Enabled or Disabled (default). This option swaps floppy drive assignments when it is enabled.
Boot Up Floppy Seek	<p>Enabled (default): During POST, BIOS checks the track number of the floppy disk drive to see whether it is 40 or 80 tracks.</p> <p>Disabled: During POST, BIOS will not check the track number of the floppy disk drive.</p>
Boot Up NumLock Status	Choose On (default) or Off. This option lets user to activate the NumLock function at boot-up.
Gate A20 Option	Choose Normal or Fast (default). This option allows the RAM to access the memory above 1MB by using the fast gate A20 line.
Typematic Rate Setting	Choose Enabled or Disabled (default). Enable this option to adjust the keystroke repeat rate.
Typematic Rate (Chars/Sec)	Range between 6 (default) and 30 characters per second. This option controls the speed of repeating keystrokes.
Typematic Delay (Msec)	Choose 250 (default), 500, 750, and 1000. This option sets the time interval for displaying the first and the second characters.

Security Option	Choose System or Setup (default). This option is to prevent unauthorized system boot-up or use of BIOS Setup.
PCI/VGA palette Snoop	Choose Enabled or Disabled (default). It determines whether the MPEG ISA cards can work with PCI/VGA or not.
Assign IRQ for VGA	Choose Enabled (default) or Disabled. Enabled: Add one IRQ to VGA controller. Deisabled: Remove IRQ from VGA controller. The system will have extra IRQ for other devices but the VGA controller will still not disabled (only IRQ was removed.)
OS Select for DRAM > 64MB	Non-OS2 (default): For Non-OS/2 system. OS: For OS/2 system.
Report No FDD For WIN95	Yes: BIOS reports "NO FDD" to Win95. No (default): BIOS will not report "NO FDD" to Win95.
Video BIOS Shadow	Enabled (default): Map the VGA BIOS to system RAM. Disabled: Don't map the VGA BIOS to system RAM.
C8000-CBFFF to DC000-DFFF Shadow	These options are used to shadow other expansion card ROMs.

3. Press <ESC> and follow the screen instructions to save or disregard your settings.

Chipset Features Setup

Chipset Features Setup changes the values of the chipset registers. These registers control the system options.

Run the Chipset Features Setup as follows:

1. Choose "CHIPSET FEATURES SETUP" from the Main Menu and a screen with a list of options appears.

```
ROM PCI/ISA BIOS
CHIPSET FEATURES SETUP
AWARD SOFTWARE, INC.
```

Auto Configuration	: Enabled	Auto Detect DIMM/PCI Clk	: Enabled
EDO DRAM Speed Selection	: 60ns	Spread Spectrum Modulated	: Disabled
EDO CAS# MA Wait State	: 2	CPU Host Clock	: Default
EDO RAS# To CAS# Delay	: 2	CPU Warning Temperature	: Disabled
SDRAM CAS latency Time	: 3	Current System Temp.	:
DRAM Data Integrity Mode	: Non-ECC	Current CPU1 Temperature	:
System BIOS Cacheable	: Disabled	Current CPUFAN1 Speed	:
Video BIOS Cacheable	: Disabled	Current CPUFAN2 Speed	:
Video RAM Cacheable	: Disabled	Current CPUFAN3 Speed	:
8 Bit I/O Recovery Time	: 1	IN0 (V)	: IN1 (V)
16 Bit I/O Recovery Time	: 1	IN2 (V)	: + 5 V
Memory hole At 15M-16M	: Disabled	+12 V	: -12 V :-
Passive Release	: Disabled	- 5 V	:
Delay Transaction	: Disabled		
AGP Aperture Size (MB)	: 64		

ESC : Quit ↑↓→←: Select Item
F1 : Help PU/PD/+/- : Modify
F5 : Old Values (Shift)F2 : Color
F6 : Load BIOS Defaults
F7 : Load Setup Defaults

2. Use one of the arrow keys to move between options and modify the selected options by using PgUp/PgDn/+/- keys.

A short description of screen options follows:

Auto Configuration Choose Enabled (default) or Disabled. The system sets all options on the left side of the screen automatically when choose Enabled.

EDO DRAM Speed Selection Choose 50ns or 60ns (default). Do not change this setting unless you know the DRAM access time spec.

EDO CASX# MA Wait State	Use the default setting.
EDO RASX# Wait State	Use the default setting.
SDRAM CAS Latency Time	Use the default setting.
DRAM Data Integrity Mode	Choose Non-ECC (default) or ECC depending on the DRAM type. ECC stands for Error Check and Correct. Non-ECC: Disabled ECC check function. ECC: Enabled ECC check function.
System BIOS Cacheable	Choose Enabled or Disabled (default). When Enabled, the access to the system BIOS ROM addressed at F0000H-FFFFFH is cached.
Video BIOS Cacheable	Choose Enabled or Disabled (default). When Enabled, the access to the VGA BIOS ROM addressed at C0000H-C7FFFH is cached.
Video RAM Cacheable	Choose Enabled or Disabled (default). When Enabled, the access to the VGA RAM addressed is cached.

8 Bit I/O Recovery Time This delay happens when the CPU is running so much faster than the I/O bus that the CPU must be delayed to allow for the completion of the I/O.

16 Bit I/O Recovery Time The choices for 8 bit I/O are NA, 1 to 8 CPU clock. Default is 3.
The choices for 16 bit I/O are NA, 1 to 4 CPU clock. Default is 2.

Memory Hole At 15M-16M Choose Enabled or Disabled (default).
In order to improve performance, certain space in memory can be reserved for ISA cards. This memory must be mapped into the memory's space below 16MB.

Passive Release Use the default setting.

Delayed Transaction Use the default setting.

AGP Aperture Size (MB) Choose 4 , 8, 16, 32, 64 (default), 128, or 256 MB. Memory mapped and graphics data structures can reside in a Graphics Aperture. This area is like a linear buffer. BIOS will auto report the starting address of this buffer to the O.S.

CPU Host Clock Choose CPU host clock ratio from: default, 66MHz, 68MHz, 75MHz, 83MHz, 100MHz, 103MHz, 112, MHz, or 133MHz.

Spread Spectrum Modulated Choose Disabled (default) or Enabled. **This function is designed only for EMI test.**

**CPU Warning
Temperature⁺**

Choose Disabled (default),
50°C/122°F, 53°C/127°F,
56°C/133°F, 60°C/140°F,
63°C/145°F, 66°C/151°F,
70°C/150°F.

When CPU temperature is over the
setting value, the speaker will
sound an alarm and the clock will
drop until the temperature is within
optimum the temperature range.

**Current System⁺
Temp**

BIOS will displays System's
temperature, fan speed, and voltage
value.

*⁺: These two functions are dependent
on the necessary hardware installation.*

3. Press <ESC> and follow the screen instructions to save or disregard your settings.

Power Management Setup

Power Management Setup sets the system's power saving functions.

1. Choose "POWER MANAGEMENT SETUP" from the Main Menu and a screen with a list of options appears.

ROM PCI/ISA BIOS POWER MANAGEMENT SETUP AWARD SOFTWARE, INC.		
Power Management	: User Define	** Reload Global Timer Events **
PM Control by APM	: No	IRQ[3-7,9-15], NMI : Enabled
Video Off Method	: V/H SYNC+Blank	Primary IDE 0 : Enabled
Video Off After	: Standby	Primary IDE 1 : Enabled
Modem Use IRQ	: 3	Secondary IDE 0 : Enabled
Doze Mode	: Disabled	Secondary IDE 1 : Enabled
Standby Mode	: Disabled	Floppy Disk : Enabled
Suspend Mode	: Disabled	Serial Port : Enabled
HDD Power Down	: Disabled	Parallel Port : Enabled
Throttle Duty Cycle	: 62.5%	
VGA Active Monitor	: Disabled	
Soft-Off by PWR-BTNN	: Instant-Off	
Resume by Ring	: Enabled	
Resume by Alarm	: Enabled	
Date (of Month) Alarm*	: 0	ESC : Quit ↑ ↓ → ←: Select Item
Time (hh:mm:ss) Alarm*	: 7:0:0	F1 : Help PU/PD/+/- : Modify
Wake Up On LAN	: Disabled	F5 : Old Values (Shift)F2 : Color
IRQ 8 Break Suspend	: Disabled	F6 : Load BIOS Defaults
		F7 : Load Setup Defaults

*: These options are available only when "Resume by Alarm" is set to Enabled.

2. Use one of the arrow keys to move between options and modify the selected options by using PgUp/PgDn/+/- keys.

A short description of screen options follows:

Power Management	Choose Max. Saving, User Define (default), Disabled, or Min Saving.
PM Control by APM	Choose Yes or No (default). You need to choose Yes when the operating system has the APM functions, choose No otherwise.

- Video Off Method** Choose Blank , DPMS, or V/H Sync+Blank (default). You can chose either DPMS or V/H Sync+Blank when the monitor has the Green function. You need to choose Blank when the monitor has neither the Green function.
- Video Off After** Choose NA, Suspend, Standby (default), or Doze.
- MODEM Use IRQ** Assign the IRQ number to the modem which is being used so that the ring signal can wakeup the system. The default setting is 3 (COM2).
- Doze Mode** This option sets the CPU speed down to 33MHz during this mode.
- Standby Mode**
Suspend Mode These two options allow you to choose the mode for the different timers. The Standby Mode turns off the VGA monitor, and the Suspend Mode turns off the CPU and saves the energy of the system.
- HDD Power Down** Time is adjustable from 1 to 15 minutes. When the set time has elapsed, the BIOS sends a command to the HDD to power down, which turns off the motor.
- Throttle Duty Cycle** Choose the duty cycle time: 12.5%, 25%, 37.5%, 50%, 62.5% (default), or 75%. The bigger of the percentage, the more saving power it gets.

VGA Active Monitor	<p>Enabled: the system can not enter the power saving mode when monitor is on.</p> <p>Disabled: the system can enter the power saving mode when monitor is on.</p>
Soft-Off by PWR-BTTN	<p>Instant-off: (default) turns off the system power at once after pushing the power button.</p> <p>Delay 4 Sec: turns off the system power 4 seconds after pushing the power button (to meet PC97 spec.)</p>
Resume by Ring	<p>Enabled: Wake up the system from ring signal.</p> <p>Disabled: (default) Ring signal can not wake up the system.</p>
Resume by Alarm	<p>Enabled: Wake up the system at assigned time, and also, the user needs to set both "Date Alarm" and "Time Alarm" 2 options.</p> <p>Disabled: (default) Disable this feature.</p>
IRQ8 Break Suspend	Use the default setting.

Wake On LAN	<p>Enabled: Wake up the system from LAN card (LAN card must support Wake Up On LAN function and the power supply must provide at least 5V/750mA standby current.</p> <p>Disabled: (default) Disabled Wake On LAN function.</p>
IRQ (#), NMI; Primary IDE 0 Primary IDE 1; Secondary IDE 0 Secondary IDE 1; Floppy Disk; Serial Port; Parallel Port	<p>Enabled: (default) The system can not enter the power saving mode when I/O ports or IRQ# is activated.</p> <p>Disabled: The system still can enter the power saving mode when I/O ports or IRQ# is activated.</p> <p><i>Note: These functions can only be activated when the power management option is Enabled.</i></p>

3. Press <ESC> and follow the screen instructions to save or disregard your settings.

PnP/PCI Configuration Setup

PnP/PCI Configuration Setup configures the PCI bus slots.

Run the Chipset Features Setup as follows:

1. Choose “PnP/PCI CONFIGURATION SETUP” from the Main Menu and a screen with a list of options appears.

```
ROM PCI/ISA BIOS
PNP/PCI CONFIGURATION
AWARD SOFTWARE, INC.
```

PNP OS Installed	: No	Used MEM base adr	: N/A
Resources Controlled By	: Auto	Used MEM Length*	: 8K
Reset Configuration Data	: Disabled	Assign IRQ For USB	: Enabled
IRQ-3	assigned to : PCI/ISA PnP		
IRQ-4	assigned to : PCI/ISA PnP		
IRQ-5	assigned to : PCI/ISA PnP		
IRQ-7	assigned to : PCI/ISA PnP		
IRQ-9	assigned to : PCI/ISA PnP		
IRQ-10	assigned to : PCI/ISA PnP		
IRQ-11	assigned to : PCI/ISA PnP		
IRQ-12	assigned to : PCI/ISA PnP		
IRQ-14	assigned to : PCI/ISA PnP		
IRQ-15	assigned to : PCI/ISA PnP		
DMA-0	assigned to : PCI/ISA PnP		
DMA-1	assigned to : PCI/ISA PnP		
DMA-3	assigned to : PCI/ISA PnP		
DMA-5	assigned to : PCI/ISA PnP		
DMA-6	assigned to : PCI/ISA PnP		
DMA-7	assigned to : PCI/ISA PnP		

```
ESC : Quit      ↑ ↓ → ← : Select Item
F1  : Help      PU/PD/+/- : Modify
F5  : Old Values (Shift)F2 : Color
F6  : Load BIOS Defaults
F7  : Load Setup Defaults
```

Note: The above setting is displayed only when “Manual” is chosen in the Resources Controlled By function.

2. Use one of the arrow keys to move between options and modify the selected options by using PgUp/PgDn/+/- keys.

A short description of screen options follows:

- PNP OS Installed** Yes: OS supports Plug and Play function.
No (default): OS doesn't support Plug and Play function.
Note: BIOS will automatically disable all PnP resources except the boot device card when select Yes on Non-PnP OS.
- Resources Controlled By** Choose Manual or Auto (default).
The BIOS checks the IRQ/DMA channel number on the ISA and PCI card manually if chose Manual and the IRQ/DMA channel number will be checked automatically if choose Auto.
- Reset Configuration Data** Choose Enabled or Disabled (default). Disabled means to retain PnP configuration data in BIOS and Enabled means to reset PnP configuration data in BIOS.
- IRQ-x assigned to DMA-x assigned to** Legacy ISA: Manually assigns IRQ/DMA to device.
PCI/ISA PnP: BIOS assigns IRQ/DMA to device automatically.
- Used MEM Base Addr** Choose N/A (default) or ISA legacy card requests to have memory start address.

Used MEM Length*

Choose 8K, 16K, 32K, or 64K.

With the above two functions, users can define where the used memory address is located and its corresponding length of the legacy area. BIOS will skip the UMB area which is used by the legacy device to avoid memory space conflict.

* This function activates only when the "Used MEM Base Addr" is chosen.

Assign IRQ for USB

Choose Enabled (default) or Disabled.

Enabled: Add one IRQ to USB controller.

Deisabled: Remove IRQ from USB controller. The system will have extra IRQ for other devices but the USB controller will still not disabled (only IRQ was removed.)

3. Press <ESC> and follow the screen instructions to save or disregard your settings.

Load Setup Defaults

Load Setup Defaults option loads the default system values to the system configuration fields. If the CMOS is corrupted the defaults are loaded automatically. Choose this option and the following message appears:

"Load Setup Defaults (Y/N)? N"

To use the Setup defaults, change the prompt to "Y" and press <Enter>.

Integrated Peripherals

Integrated Peripherals option changes the values of the chipset registers. These registers control system options in the computer.

1. Choose "INTEGRATED PERIPHERALS" from the Main Menu and a screen with a list of options appears.

ROM PCI/ISA BIOS INTEGRATED PERIPHERALS AWARD SOFTWARE, INC.			
IDE HDD Block Mode	: Enabled	UART Mode Select*	: IrDA
IDE Primary Master PIO	: Auto	RxD, TxD Active*	: Lo, Lo
IDE Primary Slave PIO	: Auto	IR Transmission Delay*	: Disabled
IDE Secondary Master PIO	: Auto	Onboard Parallel Port	: 378/IRQ7
IDE Secondary Slave PIO	: Auto	Parallel Port Mode	: ECP+EPP
IDE Primary Master UDMA	: Auto	ECP Mode Use DMA*	: 3
IDE Primary Slave UDMA	: Auto	EPP Mode Select*	: EPP1.7
IDE Secondary Master UDMA	: Auto	Power On Function*	: BUTTON ONLY
IDE Secondary Slave UDMA	: Auto		
On-Chip Primary PCI IDE	: Enalbed		
On-Chip Secondary PCI IDE	: Enalbed		
USB Keyboard Support	: Disabled		
Init Display First	: PCI Slot		
KBC Input Clock	: 8 MHz		
Onboard FDC Controller	: Enabled		
Onboard Serial Port 1	: Auto	ESC : Quit	↑ ↓ → ← : Select Item
Onboard Serial Port 2	: Auto	F1 : Help	PU/PD/+/- : Modify
		F5 : Old Values (Shift)/F2	: Color
		F6 : Load BIOS Defaults	
		F7 : Load Setup Defaults	

*: These items are available only when "UART Mode Select" is set to either IrDA or ASKIR.

†: These items are available only when "Parallel Port Mode" is set to ECP+EPP/ECP/EPP.

2. Use one of the arrow keys to move between options and modify the selected options by using PgUp/PgDn/+/- keys.

A short description of screen options follows:

IDE HDD Block Mode Choose Enabled (default) or Disabled. If your hard disk size is larger than 540MB, choose Enabled, and, if you are using the IDE HDD Auto Detection option, the BIOS will choose this option automatically.

Note: Some HDDs of old models don't provide this feature.)

IDE Primary Master/Slave PIO	Choose Auto (default) or Mode 0~4. The BIOS will detect the HDD Mode type automatically when you choose Auto. You need to set to a lower mode than Auto when your hard disk becomes unstable.
IDE Secondary Master/Slave PIO	
On-Chip Primary/Secondary PCI IDE	Enabled: (default) Turn on the onboard IDE function. Disabled: Turn off the onboard IDE function.
USB Keyboard Support	Enabled: Enables function when the USB keyboard is being used. Disabled: (default) When the AT keyboard be used.
KBC Input Clock	Choose 6MHz, 8MHz (default), 12MHz, or 16MHz. There might be a compatible problem when is above 8MHz.
Onboard FDC Controller	Choose Enabled (default) or Disabled. Choose Disabled when you use an ISA card with FDD function, or , choose Enabled to use the onboard FDD connector.
Onboard Serial Port 1	Choose Auto (default), 3F8/IRQ4 , 2F8/IRQ3, 3E8/IRQ4, 2E8/IRQ3, or Disabled. Do no set port 1 & 2 to the same value except for Disabled.
Onboard Serial Port 2	Choose Auto (default), 3F8/IRQ4 , 2F8/IRQ3, 3E8/IRQ4, 2E8/IRQ3, or Disabled.
UART Mode select	Choose Normal (default), IrDA, or ASKIR.

IR Transmission Delay	<p>Enabled: Enabled delay when transfers data.</p> <p>Disabled (default) Disabled delay when transfers data.</p>
Onboard Parallel Port	<p>Choose the printer I/O address: 378H/IRQ7 (default), 3BCH/IRQ7, 278H/IRQ5</p>
Parallel Port Mode	<p>Choose SPP (default), ECP + EPP EPP, or ECP mode. The mode depends on your external device that connects to this port.</p>
ECP Mode Use DMA	<p>Choose DMA3 (default) or DMA1. Most sound cards use DMA1. Check with your sound card configuration to make sure that there is no conflict with this function. <i>*: This option will not be displayed unless the EPP/ECP function is selected..</i></p>
EPP Mode Select	<p>Choose EPP1.7 (default) or EPP1.9. EPP1.9 supports hardware handshake. This setting is dependent on your EPP device. <i>Note: The above 2 options will not be displayed unless the EPP/ECP function is selected.</i></p>

Power On Function Choose BUTTON ONLY (default), Password, Mouse Left, or Mouse Right.

Mouse Left: Use the PS/2 Mouse Left to boot the system.

Mouse Right: Use the PS/2 Mouse Right to boot the system.

Password: Choose a special password which is defined by the user or use one of the HOT keys (from CTRL-F1 to CTRL-F12) to boot the system.

3. Press <ESC> and follow the screen instructions to save or disregard your settings.

Supervisor/User Password

These two options allow you to set your system passwords. Normally, supervisor has a higher right to change the CMOS setup option than the user. The way to set up the passwords for both Supervisor and User are as follows:

1. Choose "Change Password" in the Main Menu and press <Enter>. The following message appears:

"Enter Password:"

2. The first time you run this option, enter your password up to only 8 characters and press <Enter>. The screen does not display the entered characters.
3. After you enter the password, the following message appears prompting you to confirm the password:

"Confirm Password:"

4. Enter exactly the same password you just typed again to confirm the password and press <Enter>.
5. Move the cursor to Save & Exit Setup to save the password.
6. If you need to delete the password you entered before, choose the Supervisor Password and press <Enter>. It will delete the password that you had before.
7. Move the cursor to Save & Exit Setup to save the option you did, otherwise the old password will still be there when you turn on your machine next time.
8. Press <ESC> to exit to the Main Menu.

Note: *If you forget or lose the password, the only way to access the system is to clear the CMOS RAM by setting JBAT1. All setup information will be lost and you need to run the BIOS setup program again.*

IDE HDD Auto Detection

IDE HDD Auto Detection detects the parameters of an IDE hard disk drive and automatically enters them to the Standard CMOS Setup screen.

The screen will ask you to select a specific hard disk for Primary Master after you select this option. If you accept a hard disk detected by the BIOS, you can enter "Y" to confirm and then press <Enter> to check next hard disk. This function allows you to check four hard disks and you may press the <ESC> after the <Enter> to skip this function and go back to the Main Menu.

Save & Exit Setup

Save & Exit Setup allows you to save all modifications you have specified into the CMOS memory. Highlight this option on the Main Menu and the following message appears:

```
SAVE to CMOS and EXIT (Y/N)? Y
```

Press <Enter> key to save the configuration changes.

Exit Without Saving

Exit Without Saving allows you to exit the Setup utility without saving the modifications that you have specified. Highlight this option on the Main Menu and the following message appears:

```
Quit Without Saving (Y/N)? N
```

You may change the prompt to "Y" and press <Enter> key to leave this option.