



CERTIFICATE

The TÜV CERT Certification Body
for QM Systems of RWTÜV Systems GmbH

hereby certifies in accordance with TÜV CERT
procedure that

**ELITEGROUP COMPUTER SYSTEMS CO., LTD.
ECS MANUFACTURING (SHENZHEN) CO., LTD.
ELITE TECHNOLOGY (SHENZHEN) CO., LTD.**

2F, No. 240, Sec. 1, Nei Hu Road, Taipei, Taiwan 114
No. 22, Alley 38, Lane 91, Sec. 1, Nei Hu Road, Taipei, Taiwan 114
No. 20 & No. 26, Free Trade Zone, ShaTouJiao, Shenzhen City, Guangdong Province, China

has established and applies a quality system for

**Design, Manufacturing and Sales of Mainboards,
Personal Computers, Notebooks and Peripheral Cards**

An audit was performed, Report No. **2.5-1585/2000**

Proof has been furnished that the requirements according to
ISO 9001 : 2000 / EN ISO 9001 : 2000 / JIS Q 9001 : 2000 / ANSI/ASQC Q9001 : 2000

are fulfilled. The certificate is valid until **27 January 2007**

Certificate Registration No. **04100 2000 1325**

The company has been certified since **2000**



Essen, 04.03.2004

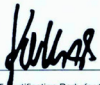

The TÜV CERT Certification Body for QM Systems
of RWTÜV Systems GmbH



ISO14001 CERTIFICATE

Certificate NO.: 05-2001-065

We hereby certify that
ECS Manufacturing(Shenzhen) Co.,Ltd

by reason of its

Environmental Management System

has been awarded this certificate for
compliance with the standard

ISO14001:1996

The Environmental Management System
applies in the following area:

The manufacture of Mother Board and Peripheral Card and interrelated
management activities of ECS Manufacturing(Shenzhen) Co.,Ltd.
which is located in No.20,Free Trade Zone,Shatuojiiao,Shenzhen, P. R.China.

Date of issue: 30th Dec 2001

Date of expiry: 29th Dec 2004

Signed by:



SHENZHEN ENVIRONMENTAL MANAGEMENT SYSTEM CERTIFICATION CENTER

Preface

Copyright

This publication, including all photographs, illustrations and software, is protected under international copyright laws, with all rights reserved. Neither this manual, nor any of the material contained herein, may be reproduced without written consent of the author.

Version 3.0

Disclaimer

The information in this document is subject to change without notice. The manufacturer makes no representations or warranties with respect to the contents hereof and specifically disclaims any implied warranties of merchantability or fitness for any particular purpose. The manufacturer reserves the right to revise this publication and to make changes from time to time in the content hereof without obligation of the manufacturer to notify any person of such revision or changes.

Trademark Recognition

Microsoft, MS-DOS and Windows are registered trademarks of Microsoft Corp.

MMX, Pentium, Pentium-II, Pentium-III, Celeron are registered trademarks of Intel Corporation.

Other product names used in this manual are the properties of their respective owners and are acknowledged.

Federal Communications Commission (FCC)

This equipment has been tested and found to comply with the limits for a Class B digital device, pursuant to Part 15 of the FCC Rules. These limits are designed to provide reasonable protection against harmful interference in a residential installation. This equipment generates, uses, and can radiate radio frequency energy and, if not installed and used in accordance with the instructions, may cause harmful interference to radio communications. However, there is no guarantee that interference will not occur in a particular installation. If this equipment does cause harmful interference to radio or television reception, which can be determined by turning the equipment off and on, the user is encouraged to try to correct the interference by one or more of the following measures:

- Reorient or relocate the receiving antenna
- Increase the separation between the equipment and the receiver
- Connect the equipment onto an outlet on a circuit different from that to which the receiver is connected
- Consult the dealer or an experienced radio/TV technician for help

Shielded interconnect cables and a shielded AC power cable must be employed with this equipment to ensure compliance with the pertinent RF emission limits governing this device. Changes or modifications not expressly approved by the system's manufacturer could void the user's authority to operate the equipment.

Declaration of Conformity

This device complies with part 15 of the FCC rules. Operation is subject to the following conditions:

- This device may not cause harmful interference, and
- This device must accept any interference received, including interference that may cause undesired operation

Canadian Department of Communications

This class B digital apparatus meets all requirements of the Canadian Interference-causing Equipment Regulations.

Cet appareil numérique de la classe B respecte toutes les exigences du Règlement sur le matériel brouilleur du Canada.

About the Manual

The manual consists of the following:

Chapter 1

Introducing the Motherboard

Describes features of the motherboard.

Go to  page 1

Chapter 2

Installing the Motherboard

Describes installation of motherboard components.

Go to  page 7

Chapter 3

Using BIOS

Provides information on using the BIOS Setup Utility.

Go to  page 25

Chapter 4

Using the Motherboard Software

Describes the motherboard software

Go to  page 47

Chapter 5

SIS964 SATA RAID Setup Guide

Provides information about SATA RAID Setup

Go to  page 51

Preface

TABLE OF CONTENTS

Preface	i
Chapter 1	1
Introducing the Motherboard	1
Introduction.....	1
Feature.....	2
Motherboard Components.....	4
Chapter 2	7
Installing the Motherboard	7
Safety Precautions.....	7
Choosing a Computer Case.....	7
Installing the Motherboard in a Case.....	7
Checking Jumper Settings.....	8
<i>Setting Jumpers.....</i>	8
<i>Checking Jumper Settings.....</i>	9
<i>Jumper Settings.....</i>	9
Connecting Case Components.....	10
<i>Front Panel Connector.....</i>	11
Installing Hardware.....	12
<i>Installing the Processor.....</i>	12
<i>Installing Memory Modules.....</i>	14
<i>Installing a Hard Disk Drive/CD-ROM/SATA Hard Drive.....</i>	16
<i>Installing a Floppy Diskette Drive.....</i>	18
<i>Installing Add-on Cards.....</i>	19
<i>Connecting Optional Devices.....</i>	20
Connecting I/O Devices.....	23
Chapter 3	25
Using BIOS	25
About the Setup Utility.....	25
<i>The Standard Configuration.....</i>	25
<i>Entering the Setup Utility.....</i>	25
<i>Updating the BIOS.....</i>	27
Using BIOS.....	27
<i>Standard CMOS Features.....</i>	28
<i>Advanced BIOS Features.....</i>	30
<i>Advanced Chipset Features.....</i>	33

<i>Integrated Peripherals</i>	36
<i>Power Management Setup</i>	39
<i>PNP/PCI Configurations</i>	41
<i>PC Health Status</i>	42
<i>Frequency/Voltage Control</i>	43
<i>Load Fail-Safe Defaults</i>	44
<i>Load Optimized Defaults</i>	44
<i>Set Password</i>	44
<i>Save & Exit Setup Option</i>	44
<i>Exit Without Saving</i>	45

Chapter 4 **47**

Using the Motherboard Software **47**

About the Software CD-ROM.....	47
Auto-installing under Windows 98/ME/2000/XP.....	47
<i>Running Setup</i>	48
Manual Installation.....	50
Utility Software Reference.....	50

Chapter 5 **51**

SIS964 SATA RAID Setup Guide **51**

Introduction for SiS964 SATA RAID Function.....	51
Features.....	51
Support Operating Systems.....	51
What is RAID.....	51
Installing Software Drivers.....	52
BIOS Utility Operation.....	53

Multi-Language Translation

Chapter 1

Introducing the Motherboard

Introduction

Thank you for choosing the 661GX-M7 motherboard. This motherboard is a high performance, enhanced function motherboard that supports LGA775 Socket for latest Pentium 4/ Celeron Processors.

The motherboard incorporates the SiS661GX Northbridge (NB) and SiS964 Southbridge (SB) chipsets. The SiS661GX Northbridge chipset features the AGTL & AGTL+ compliant bus driver technology with integrated on-die termination to support Intel Pentium 4 series processors with FSB 800 MHz (by overclocking)/533 MHz. The memory controller supports DDR only. It can offer bandwidth up to 3.2 GB/s under DDR400 to sustain the bandwidth demand from host processors. One AGP interface supports AGP 3.0 including 8X/4X data transfers and 8X/4X fast writes protocol.

The SiS964 Southbridge supports Hi-Precision Event Timer (HPET) for Microsoft Windows with multiple DMA bus architecture that supports isochroous request and continuous packet transmission. It implements an EHCI compliant interface that provides 480Mb/s bandwidth for eight USB 2.0 ports, integrates AC'97 v2.3 compliant audio controller that features a 6-channels of audio speaker out and HSP v.90 modem support. The SiS964 integrates a Serial ATA host controller that is SATA v1.0 compliant, supporting Ultra DMA 150. SiS964 also provides dual independent IDE channels and each of them support PIO mode 0,1,2,3,4 and multiword DMA mode 0,1,2 and UltraDMA 133/100/66.

The 661GX-M7 motherboard is equipped with advanced full set of I/O ports in the rear panel, including PS/2 mouse and keyboard connectors, COM1, LPT1, VGA, four USB ports, one optional LAN port, and audio jacks for microphone, line-in and line-out.

Feature

Processor

This motherboard uses an LGA775 type of Pentium 4 that carries the following features:

- Accommodates Intel P4/Celeron processors
- Supports a system bus (FSB) of 533MHz
- Supports "Hyper-Threading" technology CPU

"Hyper-Threading" technology enables the operating system into thinking it's hooked up to two processors, allowing two threads to be run in parallel, both on separate "logical" processors within the same physical processor.

Chipset

The SiS661GX Northbridge (NB) and SiS964 Southbridge (SB) chipset are based on an innovative and scalable architecture with proven reliability and performance.

- **SiS661GX(NB)**
 - Supports 12 outstanding transactions and out-of-order completion
 - Accommodates high throughput SiS MuTIOL 1G interconnecting to SiS964 MuTIOL 1G media I/O with bi-directional 16-bit data bus to perform 1GB/s bandwidth in 133 MHz x 4 mode
 - Supports AGP 8X/4X Interface with Fast Write Transaction
 - Supports DDR400/333/266 SDRAM
 - Support High Performance 256bit & High Quality 3D/2D Graphics Accelerator
- **SiS964(SB)**
 - Concurrent servicing of all DMA Devices: Dual IDE Controllers, SATA controller, three USB 2.0/1.1 host controller, LAN MAC Controller and Audio/Modem DMA Controller
 - Compliant with PCI 2.3 specification
 - Compliant with Serial ATA 1.0 specification, supports power saving mode
 - Compliant with AC'97 v2.3 supporting 6 Channels of audio outputs and V.90 HSP-Modem
 - Integrated USB 2.0 Controller with three root hubs and eight function ports

Memory

- Supports DDR400/333/266 MHz DDR SDRAM memory module
- Accommodates two unbuffered DIMM of 2.5 volt DDR SDRAM
- Up to 1 GB per DIMM with maximum memory size up to 2 GB

Graphics

- Built-in a high performance 256-bit 3D engine, supporting Ultra-AGP II™ up to 2.7GB/s bandwidth
- Built-in a high quality 3 D engine, supporting up to 2048x2048 texture size
- Supports VCD, DVD and HDTV decoding

Audio

- Compliant with the AC'97 V2.3 CODEC
- Supports 6-channel audio CODEC designed for PC multimedia systems
- Provides three analog line-level stereo inputs with 5-bit volume control: LINE-IN, CD, AUX
- Support S/PDIF output function

Expansion Options

The motherboard comes with the following expansion options:

- One AGP 3.0 compliant slot with 8X/4X speed (supports 1.5V AGP interface only)
- Three 32-bit PCI v2.3 compliant slots
- Two 40-pin IDE low profile headers that support four IDE devices
- One floppy disk drive interface
- Two 7-pin SATA connectors
- One Communications Network Riser (CNR) slot

The motherboard supports UltraDMA bus mastering with transfer rates of 133/100/66 MB/s.

Onboard LAN (Optional)

The onboard LAN provides the following features:

- Supports 10Mb/s and 100Mb/s N-way Auto-negotiation operation
- Supports half/full duplex operation
- Supports Wake-On-LAN(WOL) function and remote wake-up
- Supports power down mode

Integrated I/O

The motherboard has a full set of I/O ports and connectors:

- Two PS/2 ports for mouse and keyboard
- One serial port
- One parallel port
- One VGA port
- Four USB ports
- One LAN port (optional)
- Audio jacks for microphone, line-in and line-out

BIOS Firmware

This motherboard uses Award BIOS that enables users to configure many system features including the following:

- Power management
- Wake-up alarms
- CPU parameters
- CPU and memory timing

The firmware can also be used to set parameters for different processor clock speeds.



Some hardware specifications and software items are subject to change with out prior notice.

Motherboard Components

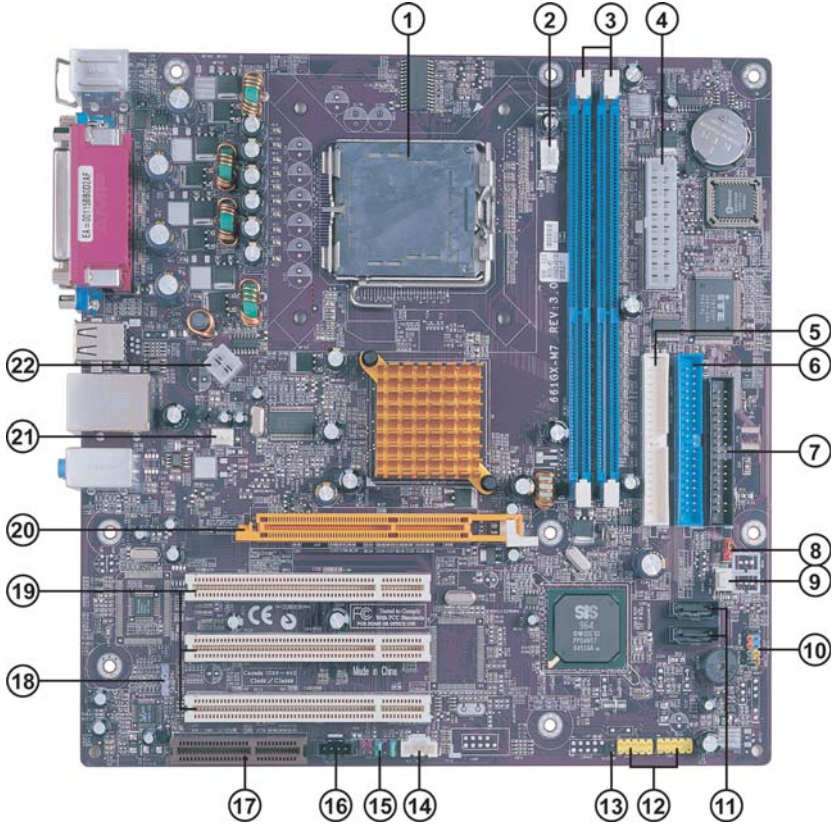

Introducing the Motherboard

Table of Motherboard Components

LABEL	COMPONENT
1 CPU	LGA775 socket for Pentium 4 CPUs
2 CPU_FAN	CPU cooling fan connector
3 DIMM1~DIMM2	Two 184-pin DDR SDRAM slots
4 ATX_POWER	Standard 20-pin ATX power connector
5 IDE2	Secondary IDE connector
6 IDE1	Primary IDE connector
7 FDD	Floppy diskette drive connector
8 CLR_CMOS	Clear CMOS jumper
9 PWR_FAN	Power cooling fan connector
10 PANEL1	Front panel switch/LED header
11 SATA1~SATA2	Serial ATA connectors
12 USB3-4	Front Panel USB headers
13 BIOS_WP	BIOS flash protect jumper
14 AUX_IN*	Auxiliary In connector
15 AUDIO1	Front panel audio header
16 CD_IN	Analog audio input connector
17 CNR1	Communications Networking Riser slot
18 SPDIFO1	SPDIF out header
19 PCI1~PCI3	32-bit add-on card slots
20 AGP	Accelerated Graphics Port slot
21 SYS_FAN	System cooling fan connector
22 ATX12V	4-pin +12V power connector

“*” stands for optional components.

This concludes Chapter 1. The next chapter explains how to install the motherboard.

Memo

Chapter 2

Installing the Motherboard

Safety Precautions

- Follow these safety precautions when installing the motherboard
- Wear a grounding strap attached to a grounded device to avoid damage from static electricity
- Discharge static electricity by touching the metal case of a safely grounded object before working on the motherboard
- Leave components in the static-proof bags they came in
- Hold all circuit boards by the edges. Do not bend circuit boards

Choosing a Computer Case

There are many types of computer cases on the market. The motherboard complies with the specifications for the Micro ATX system case. First, some features on the motherboard are implemented by cabling connectors on the motherboard to indicators and switches on the system case. Make sure that your case supports all the features required. Secondly, 661GX-M7 supports one or two floppy diskette drives and four enhanced IDE drives. Make sure that your case has sufficient power and space for all drives that you intend to install.

Most cases have a choice of I/O templates in the rear panel. Make sure that the I/O template in the case matches the I/O ports installed on the rear edge of the motherboard.

This motherboard carries a Micro ATX form factor of 244 x 244 mm. Choose a case that accommodates this form factor.

Installing the Motherboard in a Case

Refer to the following illustration and instructions for installing the motherboard in a case.

Most system cases have mounting brackets installed in the case, which correspond the holes in the motherboard. Place the motherboard over the mounting brackets and secure the motherboard onto the mounting brackets with screws.

Ensure that your case has an I/O template that supports the I/O ports and expansion slots on your motherboard.

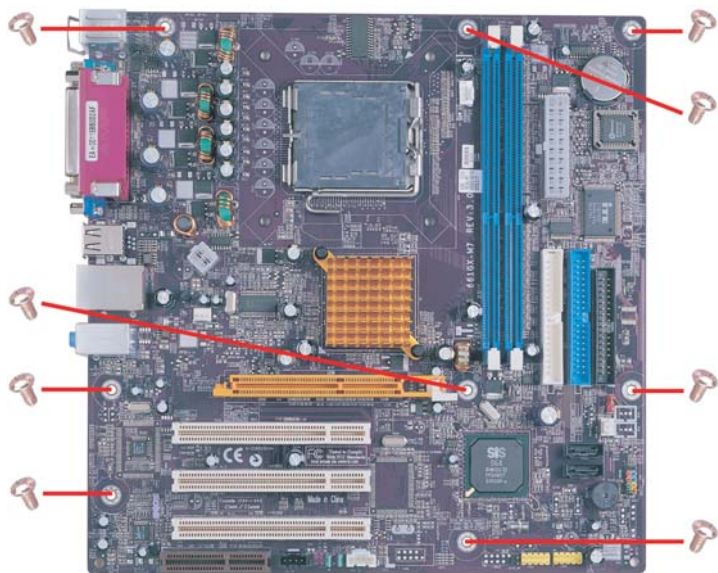

Do not over-tighten the screws as this can stress the motherboard.

Checking Jumper Settings

This section explains how to set jumpers for correct configuration of the motherboard.

Setting Jumpers

Use the motherboard jumpers to set system configuration options. Jumpers with more than one pin are numbered. When setting the jumpers, ensure that the jumper caps are placed on the correct pins.

The illustrations show a 2-pin jumper. When the jumper cap is placed on both pins, the jumper is SHORT. If you remove the jumper cap, or place the jumper cap on just one pin, the jumper is OPEN.

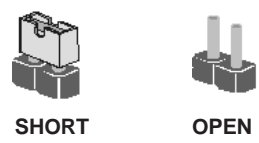

This illustration shows a 3-pin jumper. Pins 1 and 2 are SHORT

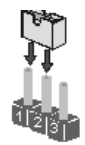

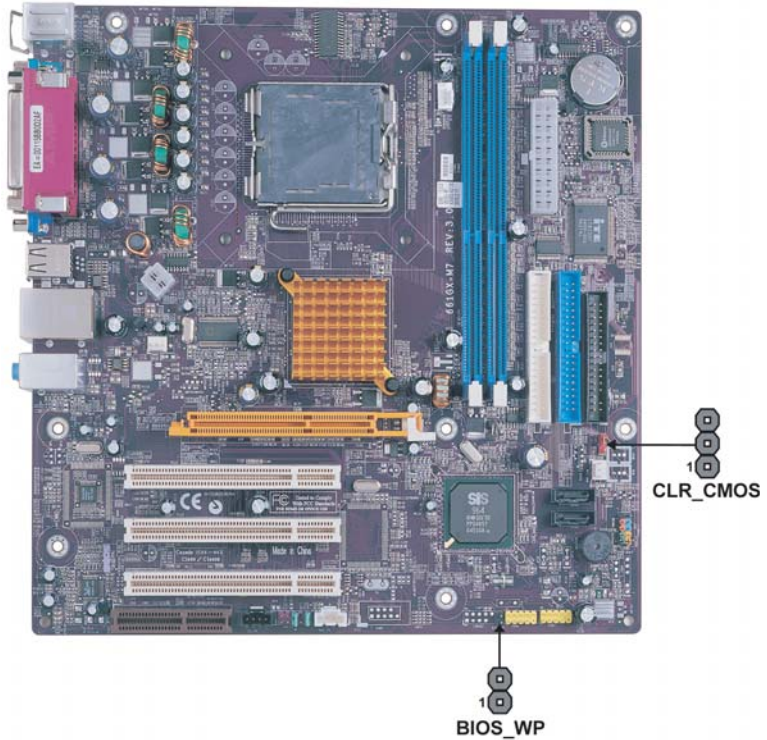

Checking Jumper Settings

The following illustration shows the location of the motherboard jumpers. Pin 1 is labeled.



Jumper Settings

Jumper	Type	Description	Setting (default)	
CLR_CMOS	3-pin	CLEAR CMOS	1-2: CLEAR 2-3: NORMAL Before clearing the CMOS, make sure to turn off the system.	CLR_CMOS  1
BIOS_WP	2-pin	BIOS PROTECT	Open: WRITE ENABLE Short: WRITE DISABLE	BIOS_WP  1

Connecting Case Components

After you have installed the motherboard into a case, you can begin connecting the motherboard components. Refer to the following:

- 1 Connect the CPU cooling fan cable to **CPU_FAN**.
- 2 Connect the power cooling fan connector to **PWR_FAN**.
- 3 Connect the system cooling fan connector to **SYS_FAN**.
- 4 Connect the case switches and indicator LEDs to the **PANEL1**.
- 5 Connect the standard power supply connector to **ATX_POWER**.
- 6 Connect the auxiliary case power supply connector to **ATX12V**.

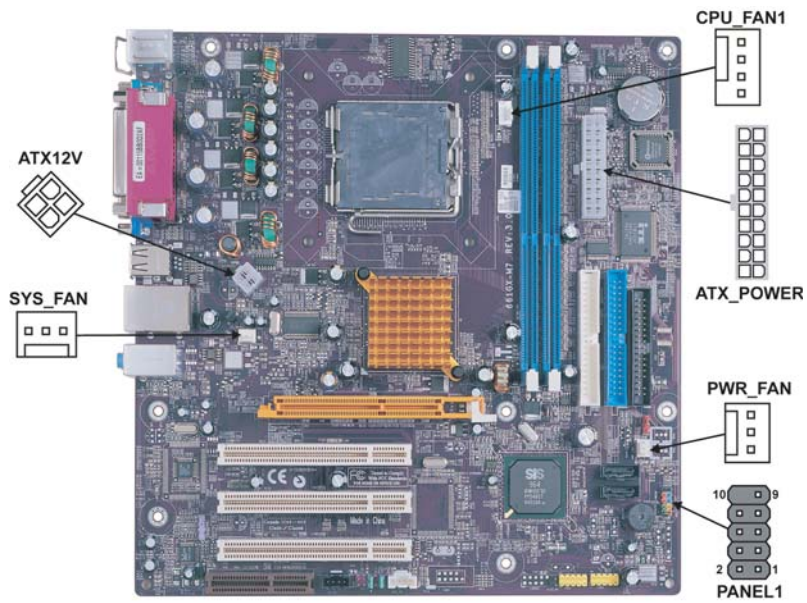

CPU_FAN: CPU Cooling Fan Connector

Pin	Signal Name	Function
1	GND	System Ground
2	+12V	Power +12V
3	Sense	Sensor
4	Control	FAN Control Signal



Users please note that the fan connector supports the CPU cooling fan of 1.1A ~ 2.2A (26.4W max) at +12V.

SYS_FAN/PWR_FAN: FAN Power Connectors

Pin	Signal Name	Function
1	GND	System Ground
2	+12V	Power +12V
3	Sense	Sensor

ATX_POWER: ATX 20-pin Power Connector

Pin	Signal Name	Pin	Signal Name
1	+3.3V	11	+3.3V
2	+3.3V	12	-12V
3	Ground	13	Ground
4	+5V	14	PS ON#
5	Ground	15	Ground
6	+5V	16	Ground
7	Ground	17	Ground
8	PWRGD	18	-5V
9	+5VSB	19	+5V
10	+12V	20	+5V

ATX12V: ATX 12V Power Connector

Pin	Signal Name
1	Ground
2	Ground
3	+12V
4	+12V

Front Panel Header

The front panel connector (PANEL1) provides a standard set of switch and LED connectors commonly found on ATX or Micro ATX cases. Refer to the table below for information:

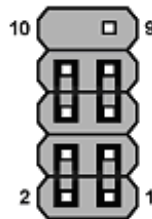

PANEL1

Pin	Signal	Function	Pin	Signal	Function
1	HD_LED_P	Hard disk LED+	2	FP PWR/SLP	*MSG LED+
3	HD_LED_N	Hard disk LED-	4	FP PWR/SLP	*MSG LED-
5	RST_SW_N	Reset Switch	6	PWR_SW_P	Power Switch
7	RST_SW_P	Reset Switch	8	PWR_SW_N	Power Switch
9	RSVD	Reserved	10	Key	No pin

* MSG LED (dual color or single color)

Hard Drive Activity LED

Connecting pins 1 and 3 to a front panel mounted LED provides visual indication that data is being read from or written to the hard drive. For the LED to function properly, an IDE drive should be connected to the onboard IDE interface. The LED will also show activity for devices connected to the SCSI (hard drive activity LED) connector.

Power/Sleep/Message waiting LED

Connecting pins 2 and 4 to a single or dual-color, front panel mounted LED provides power on/off, sleep, and message waiting indication.

Reset Switch

Supporting the reset function requires connecting pin 5 and 7 to a momentary-contact switch that is normally open. When the switch is closed, the board resets and runs POST.

Power Switch

Supporting the power on/off function requires connecting pins 6 and 8 to a momentary-contact switch that is normally open. The switch should maintain contact for at least 50 ms to signal the power supply to switch on or off. The time requirement is due to internal debounce circuitry. After receiving a power on/off signal, at least two seconds elapses before the power supply recognizes another on/off signal.

Installing Hardware

Installing the Processor



Caution: When installing a CPU heatsink and cooling fan make sure that you DO NOT scratch the motherboard or any of the surface-mount resistors with the clip of the cooling fan. If the clip of the cooling fan scrapes across the motherboard, you may cause serious damage to the motherboard or its components.

On most motherboards, there are small surface-mount resistors near the processor socket, which may be damaged if the cooling fan is carelessly installed.

Avoid using cooling fans with sharp edges on the fan casing and the clips. Also, install the cooling fan in a well-lit work area so that you can clearly see the motherboard and processor socket.

Before installing the Processor

This motherboard automatically determines the CPU clock frequency and system bus frequency for the processor. You may be able to change these settings by making changes to jumpers on the motherboard, or changing the settings in the system Setup Utility. We strongly recommend that you do not over-clock processors or other components to run faster than their rated speed.



Warning: Over-clocking components can adversely affect the reliability of the system and introduce errors into your system. Over-clocking can permanently damage the motherboard by generating excess heat in components that are run beyond the rated limits.

Installing the Motherboard

This motherboard has a LGA775 processor socket. When choosing a processor, consider the performance requirements of the system. Performance is based on the processor design, the clock speed and system bus frequency of the processor, and the quantity of internal cache memory and external cache memory.

CPU Installation Procedure

The following illustration shows CPU installation components.

- A. Unload the cap
 - Use thumb & forefinger to hold the lifting tab of the cap.
 - Lift the cap up and remove the cap completely from the socket.
- B. Open the load plate
 - Use thumb & forefinger to hold the hook of the lever, pushing down and pulling aside unlock it.
 - Lift up the lever.
 - Use thumb to open the load plate. Be careful not to touch the contacts.
- C. Install the CPU on the socket
 - Orientate CPU package to the socket. Make sure you match triangle marker to pin 1 location.
- D. Close the load plate
 - Slightly push down the load plate onto the tongue side, and hook the lever.
 - CPU is locked completely.
- E. Apply thermal grease on top of the CPU.
- F. Fasten the cooling fan supporting base onto the CPU socket on the motherboard.
- G. Make sure the CPU fan is plugged to the CPU fan connector. Please refer to the CPU cooling fan user's manual for more detail installation procedure.



To achieve better airflow rates and heat dissipation, we suggest that you use a high quality fan with 3800 rpm at least. CPU fan and heatsink installation procedures may vary with the type of CPU fan/heatsink supplied. The form and size of fan/heatsink may also vary.

Installing Memory Modules

This motherboard accommodates two memory modules. It can support two 184-pin 2.5V unbuffered DIMM, DDR400/333/266. The total memory capacity is 2GB.

DDR SDRAM memory module table

Memory module	Memory Bus
<i>DDR266</i>	<i>133MHz</i>
<i>DDR333</i>	<i>166MHz</i>
<i>DDR400</i>	<i>200MHz</i>

You must install at least one module in any of the three slots. Each module can be installed with 128 MB to 1 GB of memory; total memory capacity is 2GB.



Do not remove any memory module from its antistatic packaging until you are ready to install it on the motherboard. Handle the modules only by their edges. Do not touch the components or metal parts. Always wear a grounding strap when you handle the modules.

Installation Procedure

Refer to the following to install the memory modules.

- 1 This motherboard supports unbuffered DDR SDRAM only.
- 2 Push the latches on each side of the DIMM slot down.
- 3 Align the memory module with the slot. The DIMM slots are keyed with notches and the DIMMs are keyed with cutouts so that they can only be installed correctly.
- 4 Check that the cutouts on the DIMM module edge connector match the notches in the DIMM slot.
- 5 Install the DIMM module into the slot and press it firmly down until it seats correctly. The slot latches are levered upwards and latch on to the edges of the DIMM.
- 6 Install any remaining DIMM modules.

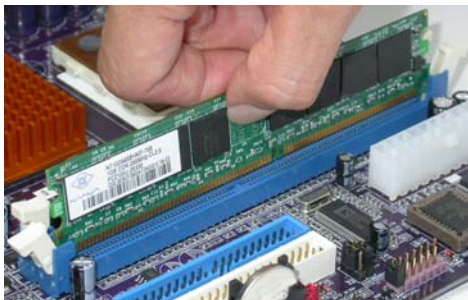

Table A: DDR (memory module) QVL (Qualified Vendor List)

The following DDR400 memory modules have been tested and qualified for use with this motherboard.

Size	Vendor	Module Name
256MB	Hynix	HY5DU56822BT-D43
	GEIL	G208L364D1TG5NKT3C
	GEIL	GE16L6464D2WL5NKT3H66
	Kingston	D3208DL2T-5 0323PT01
	Kingston	Winbond W942508BH-5
	Kingston	Samsung K4H560838D-TCC4
	Samsung	K4H560838E-TCCC
	Ramaxel	Samsung K4H560838D-TCC4
	Ramaxel	MIC_R 46V32M8TG-5BC
	Soutec	M2G9108AKAS09F083S9DT
512MB	Hynix	HY5DU56822BT-D43
	GEIL	GE16L6464D2WL5NKT3H66
	GEIL	G216L6464D2TG5NKT2L
	Kingston	Winbond W942508BH-5
	Kingston	Samsung K4H560838D-TCC4
	Samsung	K4H560838E-TCCC
	TwinMOS	M2G9J16AKATT9F083S9DT
	Kingmax	KDL388P4EA-50
	CORSAIR	PLATNUM CMX512-3200C2PT

Installing a Hard Disk Drive/CD-ROM/SATA Hard Drive

This section describes how to install IDE devices such as a hard disk drive and a CD-ROM drive.

About IDE Devices

Your motherboard has a primary and secondary IDE channel interface (IDE1 and IDE2). An IDE ribbon cable supporting two IDE devices is bundled with the motherboard.



You must orient the cable connector so that the pin1 (color) edge of the cable corresponds to the pin 1 of the I/O port connector.

IDE1: Primary IDE Connector

The first hard drive should always be connected to IDE1.



IDE2: Secondary IDE Connector

The second drive on this controller must be set to slave mode. The configuration is the same as IDE1.

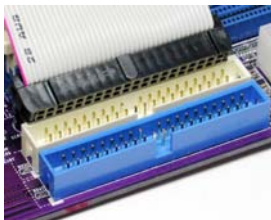

IDE devices enclose jumpers or switches used to set the IDE device as MASTER or SLAVE. Refer to the IDE device user's manual. Installing two IDE devices on one cable, ensure that one device is set to MASTER and the other device is set to SLAVE. The documentation of your IDE device explains how to do this.

About SATA Connectors

Your motherboard features two SATA connectors supporting a total of two drives. SATA refers to Serial ATA (Advanced Technology Attachment) is the standard interface for the IDE hard drives which are currently used in most PCs. These connectors are well designed and will only fit in one orientation. Locate the SATA connectors on the motherboard (see page 20) and follow the illustration below to install the SATA hard drives.

Installing Serial ATA Hard Drives

To install the Serial ATA (SATA) hard drives, use the SATA cable that supports the Serial ATA protocol. This SATA cable comes with an SATA power cable. You can connect either end of the SATA cable to the SATA hard drive or the connector on the motherboard.



SATA cable (optional)



SATA power cable (optional)

Refer to the illustration below for proper installation:

- 1 Attach either cable end to the connector on the motherboard.
- 2 Attach the other cable end to the SATA hard drive.
- 3 Attach the SATA power cable to the SATA hard drive and connect the other end to the power supply.



This motherboard does not support the "Hot-Plug" function.

Installing a Floppy Diskette Drive

The motherboard has a floppy diskette drive (FDD) interface and ships with a diskette drive ribbon cable that supports one or two floppy diskette drives. You can install a 5.25-inch drive and a 3.5-inch drive with various capacities. The floppy diskette drive cable has one type of connector for a 5.25-inch drive and another type of connector for a 3.5-inch drive.



You must orient the cable connector so that the pin 1 (color) edge of the cable corresponds to the pin 1 of the I/O port connector.

FDD: Floppy Disk Connector

This connector supports the provided floppy drive ribbon cable. After connecting the single end to the onboard floppy connector, connect the remaining plugs on the other end to the floppy drives correspondingly.

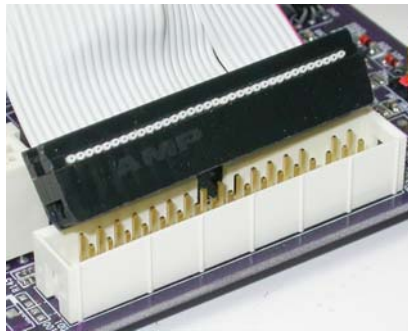

Installing Add-on Cards

The slots on this motherboard are designed to hold expansion cards and connect them to the system bus. Expansion slots are a means of adding or enhancing the motherboard's features and capabilities. With these efficient facilities, you can increase the motherboard's capabilities by adding hardware that performs tasks that are not part of the basic system.

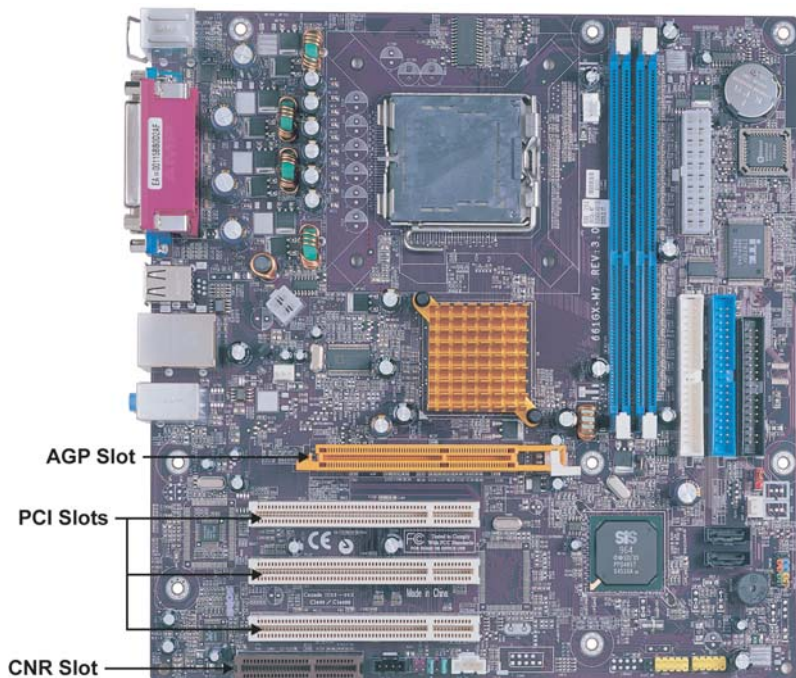

AGP Slot The AGP slot is used to install a graphics adapter that supports the 8X/4X AGP specification. It is AGP 3.0 compliant.

PCI Slots This motherboard is equipped with three standard PCI slots. PCI stands for Peripheral Component Interconnect and is a bus standard for expansion cards, which for the most part, is a supplement of the older ISA bus standard. The PCI slots on this board are PCI v2.3 compliant.

CNR1 slot This slot is used to insert CNR cards with Modem and Audio functionality.



Before installing an add-on card, check the documentation for the card carefully. If the card is not Plug and Play, you may have to manually configure the card before installation.

Installing the Motherboard

Follow these instructions to install an add-on card:

- 1 Remove a blanking plate from the system case corresponding to the slot you are going to use.
- 2 Install the edge connector of the add-on card into the expansion slot. Ensure that the edge connector is correctly seated in the slot.
- 3 Secure the metal bracket of the card to the system case with a screw.



For some add-on cards, for example graphics adapters and network adapters, you have to install drivers and software before you can begin using the add-on card.

Connecting Optional Devices

Refer to the following for information on connecting the motherboard's optional devices:

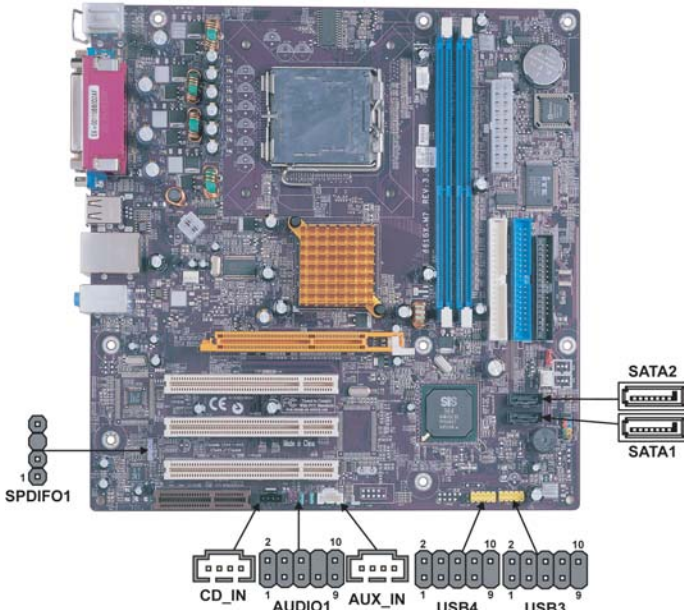

Installing the Motherboard

AUDIO1: Front Panel Audio header

This header allows the user to install auxiliary front-oriented microphone and line-out ports for easier access.

Pin	Signal Name	Function
1	AUD_MIC	Front Panel Microphone input signal
2	AUD_GND	Ground used by Analog Audio Circuits
3	AUD_MIC_BIAS	Microphone Power
4	AUD_VCC	Filtered +5V used by Analog Audio Circuits
5	AUD_F_R	Right Channel audio signal to Front Panel
6	AUD_RET_R	Right Channel Audio signal to Return from Front Panel
7	REVD	Reserved
8	Key	No Pin
9	AUD_F_L	Left Channel Audio signal to Front Panel
10	AUD_RET_L	Left Channel Audio signal to Return from Front Panel

CD_IN: Analog audio input connector

Pin	Signal Name	Function
1	CD in_L	CD In left channel
2	GND	Ground
3	GND	Ground
4	CD in_R	CD In right channel

SATA1/SATA2: Serial ATA connectors

These connectors are used to support the new Serial ATA devices for the highest data transfer rates (150 MB/s), simpler disk drive cabling and easier PC assembly. It eliminates limitations of the current Parallel ATA interface. But maintains register compatibility and software compatibility with Parallel ATA.

Pin	Signal Name	Pin	Signal Name
1	Ground	2	TX+
3	TX-	4	Ground
5	RX-	6	RX+
7	Ground	-	-

USB3/USB4: Front Panel USB header

The motherboard has four USB ports installed on the rear edge I/O port array. Additionally, some computer cases have USB ports at the front of the case. If you have this kind of case, use auxiliary USB connector to connect the front-mounted ports to the motherboard.

Pin	Signal Name	Function
1	USBPWR	Front Panel USB Power
2	USBPWR	Front Panel USB Power
3	USB_FP_P0-	USB Port 0 Negative Signal
4	USB_FP_P1-	USB Port 1 Negative Signal
5	USB_FP_P0+	USB Port 0 Positive Signal
6	USB_FP_P1+	USB Port 1 Positive Signal
7	GND	Ground
8	GND	Ground
9	Key	No pin
10	USB_FP_OC0	Overcurrent signal



Please make sure that the USB cable has the same pin assignment as indicated above. A different pin assignment may cause damage or system hang-up.

AUX_IN: Auxiliary In connector (optional)

This connector is an additional line-in audio connector. It allows you to attach a line-in cable when your rear line-in jack is set as line out port for 4-channel function.

Pin	Signal Name	Function
1	AUX_L	AXU In left channel
2	GND	Ground
3	GND	Ground
4	AUX_R	AXU In right channel

SPDIF01: SPDIF out header

This is an optional header that provides an S/PDIF (Sony/Philips Digital Interface) output to digital multimedia device through optical fiber or coaxial connector.

Pin	Signal Name	Function
1	SPDIF	SPDIF digital output
2	+5VA	5V analog Power
3	Key	No pin
4	GND	Ground

Connecting I/O Devices

The backplane of the motherboard has the following I/O ports:

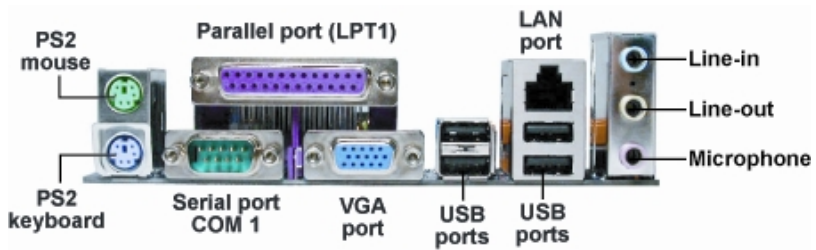

- PS2 Mouse** Use the upper PS/2 port to connect a PS/2 pointing device.
- PS2 Keyboard** Use the lower PS/2 port to connect a PS/2 keyboard.
- Parallel Port (LPT1)** Use LPT1 to connect printers or other parallel communications devices.
- Serial Port (COM1)** Use the COM port to connect serial devices such as mice or fax/modems. COM1 is identified by the system as COM1/3.
- VGA Port** Connect your monitor to the VGA port.
- LAN Port (optional)** Connect an RJ-45 jack to the LAN port to connect your computer to the Network.
- USB Ports** Use the USB ports to connect USB devices.
- Audio Ports** Use the three audio ports to connect audio devices. The first jack is for stereo line-in signal. The second jack is for stereo line-out signal. The third jack is for microphone.

This concludes Chapter 2. The next chapter covers the BIOS.

Memo

Chapter 3

Using BIOS

About the Setup Utility

The computer uses the latest Award BIOS with support for Windows Plug and Play. The CMOS chip on the motherboard contains the ROM setup instructions for configuring the motherboard BIOS.

The BIOS (Basic Input and Output System) Setup Utility displays the system's configuration status and provides you with options to set system parameters. The parameters are stored in battery-backed-up CMOS RAM that saves this information when the power is turned off. When the system is turned back on, the system is configured with the values you stored in CMOS.

The BIOS Setup Utility enables you to configure:

- Hard drives, diskette drives and peripherals
- Video display type and display options
- Password protection from unauthorized use
- Power Management features

The settings made in the Setup Utility affect how the computer performs. Before using the Setup Utility, ensure that you understand the Setup Utility options.

This chapter provides explanations for Setup Utility options.

The Standard Configuration

A standard configuration has already been set in the Setup Utility. However, we recommend that you read this chapter in case you need to make any changes in the future.

This Setup Utility should be used:

- when changing the system configuration
- when a configuration error is detected and you are prompted to make changes to the Setup Utility
- when trying to resolve IRQ conflicts
- when making changes to the Power Management configuration
- when changing the password or making other changes to the Security Setup

Entering the Setup Utility

When you power on the system, BIOS enters the Power-On Self Test (POST) routines. POST is a series of built-in diagnostics performed by the BIOS. After the POST routines are completed, the following message appears:

Press DEL to enter SETUP

Pressing the delete key accesses the BIOS Setup Utility:

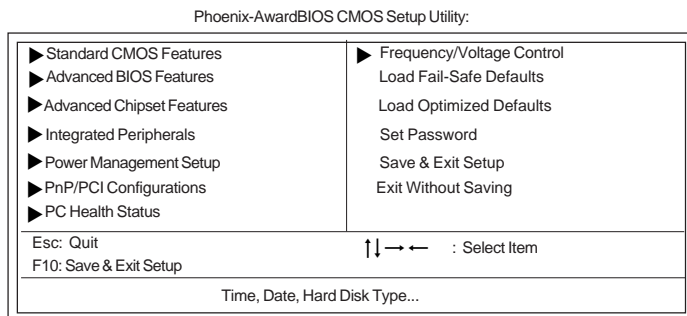
***BIOS Navigation Keys***

The BIOS navigation keys are listed below:

KEY	FUNCTION
ESC	Exits the current menu
←↑↓→	Scrolls through the items on a menu
+/-/PU/PD	Modifies the selected field's values
F10	Saves the current configuration and exits setup
F1	Displays a screen that describes all key functions
F5	Loads previously saved values to CMOS
F6	Loads a minimum configuration for troubleshooting
F7	Loads an optimum set of values for peak performance

Updating the BIOS

You can download and install updated BIOS for this motherboard from the manufacturer's Web site. New BIOS provides support for new peripherals, improvements in performance, or fixes for known bugs. Install new BIOS as follows:

- 1 If your motherboard has a BIOS protection jumper, change the setting to allow BIOS flashing.
- 2 If your motherboard has an item called Firmware Write Protect in Advanced BIOS features, disable it. (Firmware Write Protect prevents BIOS from being overwritten.)
- 3 Create a bootable system disk. (Refer to Windows online help for information on creating a bootable system disk.)
- 4 Download the Flash Utility and new BIOS file from the manufacturer's Web site. Copy these files to the system diskette you created in Step 3.
- 5 Turn off your computer and insert the system diskette in your computer's diskette drive. (You might need to run the Setup Utility and change the boot priority items on the Advanced BIOS Features Setup page, to force your computer to boot from the floppy diskette drive first.)
- 6 At the A:\ prompt, type the Flash Utility program name and press <Enter>.
- 7 Type the filename of the new BIOS in the "File Name to Program" text box. Follow the onscreen directions to update the motherboard BIOS.
- 8 When the installation is complete, remove the floppy diskette from the diskette drive and restart your computer. If your motherboard has a Flash BIOS jumper, reset the jumper to protect the newly installed BIOS from being overwritten.

Using BIOS

When you start the Setup Utility, the main menu appears. The main menu of the Setup Utility displays a list of the options that are available. A highlight indicates which option is currently selected. Use the cursor arrow keys to move the highlight to other options. When an option is highlighted, execute the option by pressing <Enter>.

Some options lead to pop-up dialog boxes that prompt you to verify that you wish to execute that option. Other options lead to dialog boxes that prompt you for information.

Some options (marked with a triangle ►) lead to submenus that enable you to change the values for the option. Use the cursor arrow keys to scroll through the items in the submenu.

In this manual, default values are enclosed in parenthesis. Submenu items are denoted by a triangle ►.

Standard CMOS Features

This option displays basic information about your system.

Phoenix-AwardBIOS CMOS Setup Utility
Standard CMOS Features

Date (mm:dd:yy) Wed, Feb 25 2004	Item Help
Time (hh:mm:ss) 9 : 33 : 26	Menu Level ▶
▶ IDE Channel 0 Master	Change the day, month, year and century
▶ IDE Channel 0 Slave	
▶ IDE Channel 1 Master	
▶ IDE Channel 1 Slave	
IDE Channel 2 Master	
IDE Channel 3 Master	
Drive A [1.44M, 3.5 in.]	
Drive B [None]	
Floppy 3 Mode Support [Disabled]	
Video [EGA/VGA]	
Halt On [All Errors]	
Base Memory 640K	
Extended Memory 65535K	
Total Memory 1024K	

↑ ↓ → ← : Move Enter: Select +/-/PU/PD: Value F10: Save ESC: Exit F1: General Help
F5: Previous Values F6: Fail-Safe Defaults F7: Optimized Defaults

Date and Time

The Date and Time items show the current date and time on the computer. If you are running a Windows OS, these items are automatically updated whenever you make changes to the Windows Date and Time Properties utility.

▶ IDE Devices (None)

Your computer has two IDE channels (Primary and Secondary) and each channel can be installed with one or two devices (Master and Slave). Use these items to configure each device on the IDE channel.

This motherboard features two SATA connectors supporting two SATA drives. SATA refers to Serial ATA (Advanced Technology Attachment), the standard interface for the IDE hard drives which are currently used in most PCs.

Phoenix-AwardBIOS CMOS Setup Utility
IDE Channel 0 Maser

IDE HDD Auto-Detection [Press Enter]	Item Help
IDE Channel 0 Master [Auto]	Menu Level ▶▶
Access Mode [Auto]	To auto-detect the HDD's size, head... on this channel
Capacity 0MB	
Cylinder 0	
Head 0	
Precomp 0	
Landing Zone 0	
Sector 0	

↑ ↓ → ← : Move Enter: Select +/-/PU/PD: Value F10: Save ESC: Exit F1: General Help
F5: Previous Values F6: Fail-Safe Defaults F7: Optimized Defaults

IDE HDD Auto-Detection

Press <Enter> while this item is highlighted to prompt the Setup Utility to automatically detect and configure an IDE device on the IDE channel.



If you are setting up a new hard disk drive that supports LBA mode, more than one line will appear in the parameter box. Choose the line that lists LBA for an LBA drive.

IDE Channel 0/1 Master/Slave/ IDE Drive(Auto)

Leave this item at Auto to enable the system to automatically detect and configure IDE devices on the channel. If it fails to find a device, change the value to Manual and then manually configure the drive by entering the characteristics of the drive in the items described below. Please noted that if you choose IDE Channel 2/3 Master, the item may change to Extended IDE Drive.

Refer to your drive's documentation or look on the drive casing if you need to obtain this information. If no device is installed, change the value to None.



Before attempting to configure a hard disk drive, ensure that you have the configuration information supplied by the manufacturer of your hard drive. Incorrect settings can result in your system not recognizing the installed hard disk.

Access Mode (Auto)

This item defines ways that can be used to access IDE hard disks such as LBA (Large Block Addressing). Leave this value at Auto and the system will automatically decide the fastest way to access the hard disk drive. If you choose IDE Channel 2/3 Master, the item only have Large and Auto.

Press <Esc> to return to the Standard CMOS Features page.

Drive A/Drive B (1.44M, 3.5 in./None)

These items define the characteristics of any diskette drive attached to the system. You can connect one or two diskette drives.

Floppy 3 Mode Support (Disabled)

Floppy 3 mode refers to a 3.5-inch diskette with a capacity of 1.2 MB. Floppy 3 mode is sometimes used in Japan.

Video (EGA/VGA)

This item defines the video mode of the system. This motherboard has a built-in VGA graphics system; you must leave this item at the default value.

Halt On (All Errors)

This item defines the operation of the system POST (Power On Self Test) routine. You can use this item to select which types of errors in the POST are sufficient to halt the system.

Base Memory, Extended Memory, and Total Memory

These items are automatically detected by the system at start up time. These are display-only fields. You cannot make changes to these fields.

Press <Esc> to return to AwardBIOS CMOS Setup Utility page.

Advanced BIOS Features

This option defines advanced information about your system.

Phoenix-AwardBIOS CMOS Setup Utility
Advanced BIOS Features

<ul style="list-style-type: none"> ▶ CPU Feature [Press Enter] ▲ ▶ Hard Disk Boot Priority [Press Enter] CPU L1 & L2 Cache [Enabled] CPU L3 Cache [Enabled] Hyper-Threading Technology [Enabled] Quick Power On Self Test [Enabled] First Boot Device [Floppy] Second Boot Device [Hard Disk] Third Boot Device [CDROM] Boot Other Device [Enabled] Swap Floppy Drive [Disabled] Boot Up Floppy Seek [Disabled] Boot Up NumLock Status [On] Gate A20 Option [Fast] Typematic Rate Setting [Disabled] x Typematic Rate (Chars/Sec) 6 x Typematic Delay (Msec) 250 Security Option [Setup] 	<p>Item Help</p> <hr/> <p>Menu Level ▶</p>
--	--

↑↓ ← → : Move Enter: Select +/-/PU/PD:Value F10:Save ESC:Exit F1: General Help
F5:Previous Values F6:Fail-Safe Defaults F7:Optimized Defaults

▶ CPU Feature (Press Enter)

Users please note that this function is only available for Prescott CPUs. Scroll to this item and press <Enter> to view the following screen:

Phoenix-AwardBIOS CMOS Setup Utility
CPU Feature

<ul style="list-style-type: none"> Thermal Management [Thermal Monitor 1] TM2 Bus Ratio [0 X] TM2 Bus VID [0.8375V] Limit CPUID MaxVal [Disabled] Execute Disable Bit [Disabled] 	<p>Item Help</p> <hr/> <p>Menu Level ▶▶</p> <p>Thermal Monitor 1 (On die throttling)</p> <p>Thermal Monitor 2 Ratio & VID transition</p>
---	--

↑↓ ← → : Move Enter: Select +/-/PU/PD:Value F10:Save ESC:Exit F1: General Help
F5:Previous Values F6:Fail-Safe Defaults F7:Optimized

Thermal Management (Thermal Monitor 1)

This item displays CPU's temperature and enables you to set a safe temperature to Prescott CPU.

TM2 Bus Ratio (0X)

This item represents the frequency (bus ratio) of the throttled performance state that will be initiated when the on-die sensor goes from not hot to hot).

TM2 Bus VID (0.8375V)

This item represents the voltage of the throttled performance state that will be initiated when the on-die sensor goes from not hot to hot.

Limit CPUID MaxVal (Disabled)

This item can support Prescott CPUs for old OS. Users please note that under NT 4.0, it must be set “Enabled”, while under WinXP, it must be set “Disabled”.

Execute Disable Bit (Disabled)

This item is a security feature that helps you protect your CPU and operating system against malicious software executing code. This item is available when CPU supports the feature.

Press <Esc> to return to the Advanced Chipset Features page.

▶ Hard Disk Boot Priority (Press Enter)

Scroll to this item and press <Enter> to view the following screen:

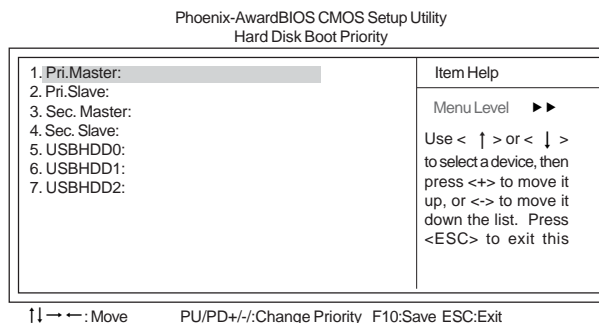
**CPU L1&L2 Cache (Enabled)**

All processors that can be installed in this mainboard use internal level 1 (L1) and external level 2 (L2) cache memory to improve performance. Leave this item at the default value for better performance.

CPU L3 Cache (Enabled)

This item is only available when processors support L3. Some high-end processors support L3. If the CPU do support L3, you may set this item to enable or disable. Leave this item at the default value for better performance.

Hyper-Threading Technology (Enabled)

This item is only available when the chipset supports Hyper-Threading and you are using a Hyper-Threading CPU.

Quick Power On Self Test (Enabled)

Enable this item to shorten the power on testing (POST) and have your system start up faster. You might like to enable this item after you are confident that your system hardware is operating smoothly.

First/Second/Third Boot Device (Floppy/Hard Disk/CDROM)

Use these three items to select the priority and order of the devices that your system searches for an operating system at start-up time.

Boot Other Device (Enabled)

When enabled, the system searches all other possible locations for an operating system if it fails to find one in the devices specified under the First, Second, and Third boot devices.

Swap Floppy Drive [Disabled]

If you have two floppy diskette drives in your system, this item allows you to swap the assigned drive letters so that drive A becomes drive B, and drive B becomes drive A.

Boot Up Floppy Seek (Disabled)

If this item is enabled, it checks the size of the floppy disk drives at start-up time. You don't need to enable this item unless you have a legacy diskette drive with 360K capacity.

Boot Up NumLock Status (On)

This item defines if the keyboard Num Lock key is active when your system is started.

Gate A20 Option (Fast)

This item defines how the system handles legacy software that was written for an earlier generation of processors. Leave this item at the default value.

ATA 66/100 IDE Cable Msg. (Enabled)

This item enables or disables the ATA 66/100 IDE Cable Msg. This message will appear during reboot when you use 40-pin cable on your 66/100 hard disks.

Typematic Rate Setting (Disabled)

If this item is enabled, you can use the following two items to set the typematic rate and the typematic delay settings for your keyboard.

- **Typematic Rate (Chars/Sec):** Use this item to define how many characters per second are generated by a held-down key.
- **Typematic Delay (Msec):** Use this item to define how many milliseconds must elapse before a held-down key begins generating repeat characters.

Security Option (Setup)

If you have installed password protection, this item defines if the password is required at system start up, or if it is only required when a user tries to enter the Setup Utility.

APIC Mode (Enabled)

This item allows you to enable or disable the APIC (Advanced Programmable Interrupt Controller) mode. APIC provides symmetric multi-processing (SMP) for systems, allowing support for up to 60 processors.

MPS Version Control For OS (1.4)

The BIOS supports versions 1.1 and 1.4 of the Intel multiprocessor specification. Select the version supported by the operation system running on the computer.

OS Select For DRAM > 64 MB (Non-OS2)

This item is only required if you have installed more than 64 MB of memory and you are running the OS/2 operating system. Otherwise, leave this item at the default.

HDD S.M.A.R.T Capability (Disabled)

The S.M.A.R.T. (Self-Monitoring, Analysis, and Reporting Technology) system is a diagnostics technology that monitors and predicts device performance. S.M.A.R.T. software resides on both the disk drive and the host computer.

Video BIOS Shadow (Enabled)

This item determines whether the BIOS will be copied to RAM for faster execution.

Press <Esc> to return to Advanced BIOS Features screen.

Advanced Chipset Features

These items define critical timing parameters of the motherboard. You should leave the items on this page at their default values unless you are very familiar with the technical specifications of your system hardware. If you change the values incorrectly, you may introduce fatal errors or recurring instability into your system.

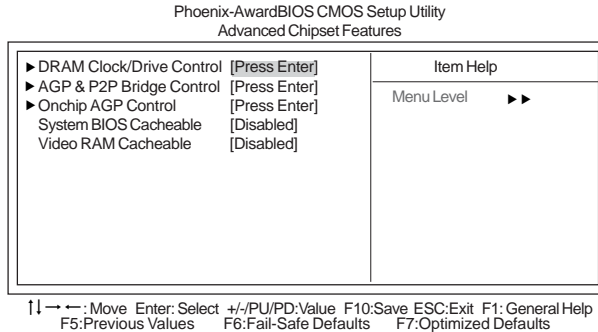

▶ DRAM Clock/Drive Control (Press Enter)

Scroll to this item and press <Enter> to view the following screen:

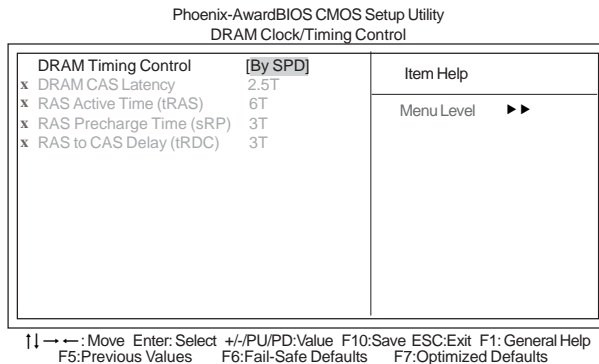

DRAM Timing Control (By SPD)

Enables you to select the CAS latency time in HCLKs of 2, 2.5, or 3. The value is set at the factory depending on the DRAM installed. Do not change the values in this field unless you change specifications of the installed DRAM or the installed CPU.

- **DRAM CAS Latency (2.5T):** This item controls the timing delay (in clock cycles) before the DRAM starts a read command after receiving it.
- **RAS Active Time (tRAS) (6T):** This item allows you to set the amount of time a RAS can be kept open for multiple accesses. High figures will improve performance.

- **RAS Precharge Time (tRP) (3T)** This is the duration of the time interval during which the Row Address Strobe signal to a DRAM is held low during normal Read and Write Cycles. This is the minimum interval between completing one read or write and starting another from the same (non-page mode) DRAM. Techniques such as memory interleaving, or use of Page Mode DRAM are often used to avoid this delay. Some chipsets require this parameter in order to set up the memory configuration properly. The RAS Precharge value is typically about the same as the RAM Access (data read/write) time.
- **RAS to CAS Delay (tRCD) (3T)**: This is the amount of time a CAS is performed after a RAS. This lower the better, but some DRAM does not support low figures.

Press <Esc> to return to the Advanced Chipset Features page.

▶AGP & P2P Bridge Control (Press Enter)

Scroll to this item and press <Enter> to view the following screen:

Phoenix-Award BIOS CMOS Setup Utility
AGP & P2P Bridge Control

AGP Aperture Size	[128M]	Item Help
Graphic Windows WR Combin	[Enabled]	
AGP Fast Write Support	[Disabled]	
AGP Data Rate	[Auto]	Menu Level ▶▶

↑↓←→ : Move Enter: Select +/-/PU/PD: Value F10: Save ESC: Exit F1: General Help
F5: Previous Values F6: Fail-Safe Defaults F7: Optimized Defaults

AGP Aperture Size(128MB)

This setting controls just how much system RAM can be allocated to AGP for video purposes. The aperture is a portion of the PCI memory address range dedicated to graphics memory address space. Host cycles that hit the aperture range are forwarded to the AGP without any translation.

Graphic Window WR Combin (Enabled)

Use this item to enable or disable CPU support for WR Combin feature.

AGP Fast Write Support (Disabled)

This item lets you enable or disable the caching of display data for the video memory of the processor.

AGP Data Rate (Auto)

This item allows users to set the AGP Data Rate by, Auto, 1X, 2X, 4X, or 8X, depending on what speed the AGP card supports.

Press <Esc> to return to the Advanced Chipset Features screen.

► OnChip AGP Control

Scroll to this item and press <Enter> to view the following screen:

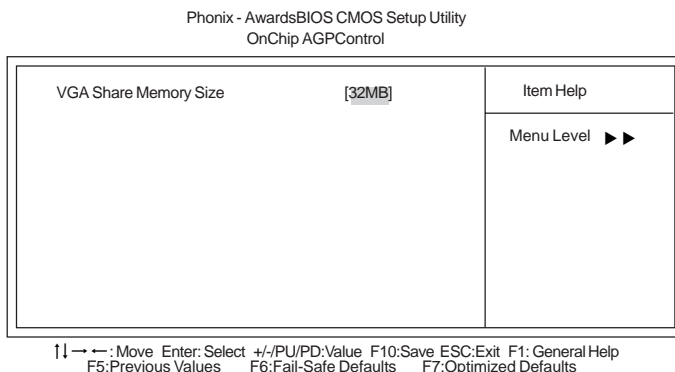

VGA Share Memory Size (32MB)

This item allows you to select the shared memory size for VGA usage.

Press <Esc> to return to the Advanced Chipset Features screen.

System BIOS Cacheable (Disabled)

This feature is only valid when the system BIOS is shadowed. It enables or disables the caching of the system BIOS ROM at **F0000h-FFFFFh** via the L2 cache. This greatly speeds up accesses to the system BIOS.

Video RAM Cacheable (Disabled)

This feature enables or disables the caching of the video RAM at **A0000h-AFFFFh** via the L2 cache.

Integrated Peripherals

These options display items that define the operation of peripheral components on the system's input/output ports.

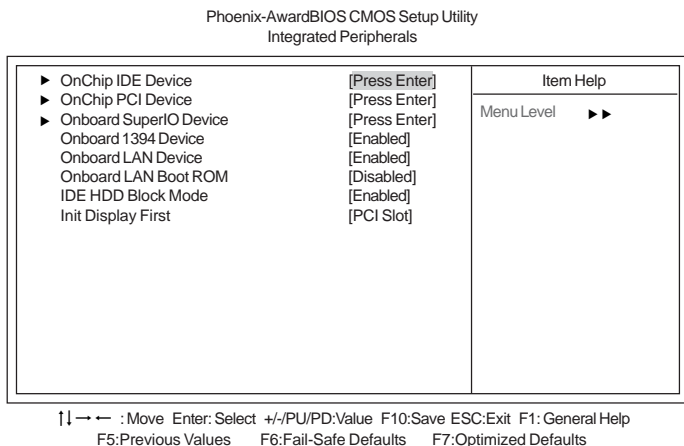

▶ OnChip IDE Device (Press Enter)

Scroll to this item and press <Enter> to view the following screen:

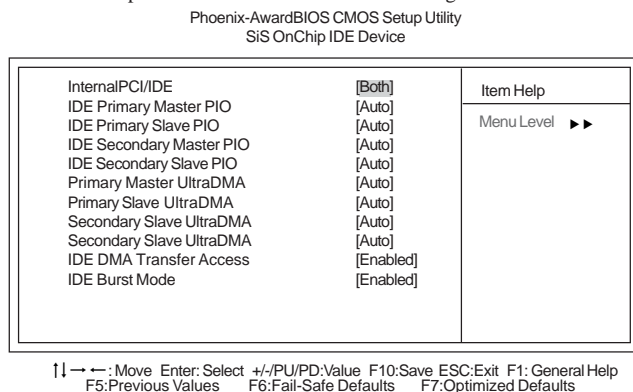

Internal PCI/IDE (Both)

Use these items to enable or disable the internal PCI IDE channels that are integrated on the mainboard.

IDE Primary/Secondary Master/Slave PIO (Auto)

Each IDE channel supports a master device and a slave device. These four items let you assign which kind of PIO (Programmed Input/Output) is used by IDE devices. Choose Auto to let the system auto detect which PIO mode is best, or select a PIO mode from 0-4.

IDE Primary/Secondary Master/Slave UltraDMA (Auto)

This mainboard supports UltraDMA technology, which provides faster access to IDE devices. If you install a device that supports UltraDMA, change the item on this list to Auto. You may have to install the UltraDMA driver supplied with this mainboard in order to use an UltraDMA device.

IDE DMA Transfer Access (Enabled)

This item allows you to enabled the transfer access of the IDE DMA.

IDE Burst Mode (Enabled)

This option, when enabled will instruct the system to send every write transaction to the write buffer. Burststable transactions then burst onto the PCI bus and nonburststable transactions do not.

Press <Esc> to return to the **Integrated Peripherals** page.

► OnChip PCI Device (Press Enter)

Scroll to this item and press <Enter> to view the following screen:

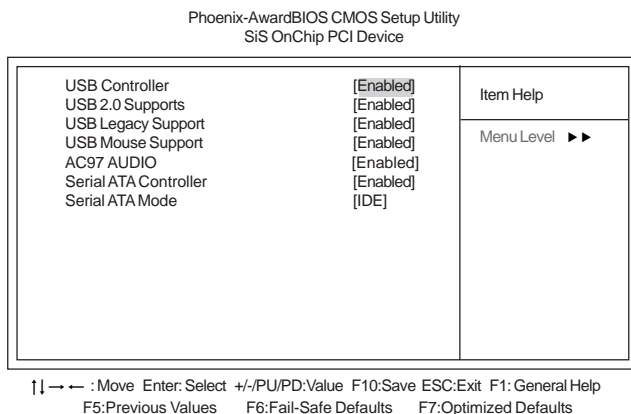
**USB Controller (Enabled)**

Enables or disables the onboard USB controller. We recommend users keep the default value. Disabling it might cause the USB devices not to work properly.

USB 2.0 Supports (Enabled)

This item enables or disables the onboard USB 2.0.

USB Legacy Support (Enabled)

Enable this item if you plan to use a keyboard connected through the USB port in a legacy operating system (such as DOS) that does not support Plug and Play.

USB Mouse Support (Enabled)

Enable this item if you plan to use a mouse connected through the USB port in a legacy operating system (such as DOS) that does not support Plug and Play.

AC97 AUDIO (Enabled)

Enables or disables the onboard AC 97 audio function. Disable this item if you are going to install a PCI audio add-on card.

Serial ATA Controller (Enabled)

Enables or disables the onboard Serial ATA controller. Enable this item if you are to install SATA devices onboard.

Serial ATA Mode (IDE)

Use this item to define the onboard SATA mode. Set this item to RAID if you are to activate the RAID function of the SATA devices.

Press <Esc> to return to the **Integrated Peripherals** page.

► Onboard SuperIO Device (Press Enter)

Scroll to this item and press <Enter> to view the following screen:

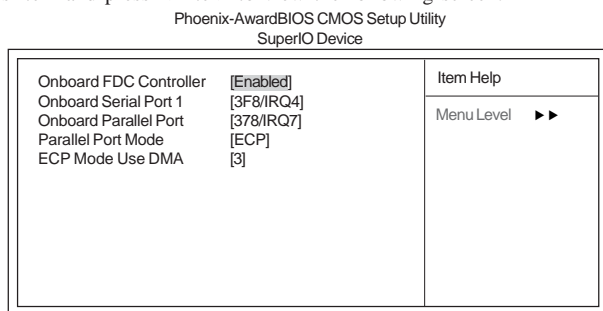

↑↓ ← → : Move Enter: Select +/-/PU/PD: Value F10: Save ESC: Exit F1: General Help
F5: Previous Values F6: Fail-Safe Defaults F7: Optimized Defaults

Onboard FDC Controller (Enabled)

This option enables the onboard floppy disk drive controller.

Onboard Serial Port 1 (3F8/IRQ4)

This option is used to assign the I/O address and interrupt request (IRQ) for onboard serial port 1 (COM1).

Onboard Parallel Port (378/IRQ7)

This option is used to assign the I/O address and interrupt request (IRQ) for the onboard parallel port.

Parallel Port Mode (ECP)

Enables you to set the data transfer protocol for your parallel port. There are four options: SPP (Standard Parallel Port), EPP (Enhanced Parallel Port), ECP (Extended Capabilities Port) and ECP+EPP.

SPP allows data output only. Extended Capabilities Port (ECP) and Enhanced Parallel Port (EPP) are bi-directional modes, allowing both data input and output. ECP and EPP modes are only supported with EPP- and ECP-aware peripherals.

ECP Mode Use DMA (3)

When the onboard parallel port is set to ECP mode, the parallel port can use DMA 3 or DMA 1.

Press <Esc> to return to the **Integrated Peripherals** page.

Onboard 1394 Device (Enabled)

Use this item to enable and disable the onboard 1394 function.

Onboard LAN Device (Enabled)

Use this item to enable and disable the onboard LAN function.

Onboard LAN Boot ROM (Disabled)

Use this item to enable or disable the booting from the onboard LAN or a network add-in card with a remote boot ROM installed.

Init Display First (PCI Slot)

Use this item to specify whether your graphics adapter is installed in one of the PCI slots or is integrated on the mainboard.

IDE HDD Block Mode (Enabled)

Enable this field if your IDE hard drive supports block mode. Block mode enables BIOS to automatically detect the optimal number of block read and writes per sector that the drive can support. It also improves the speed of access to IDE devices.

Power Management Setup

This option lets you control system power management. The system has various power-saving modes including powering down the hard disk, turning off the video, suspending to RAM, and software power down that allows the system to be automatically resumed by certain events.

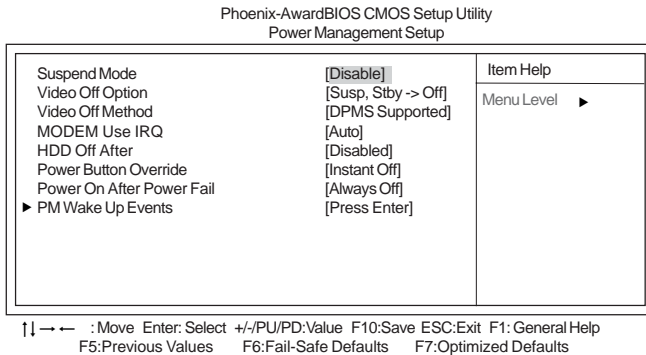

Suspend Mode (Disabled)

The CPU clock will be stopped and the video signal will be suspended if no Power Management events occur for a specified length of time. Full power function will return when a Power Management event is detected.

Video Off Option (Susp, Stby → Off)

This option defines if the video is powered down when the system is put into suspend mode.

Video Off Method (DPMS Supported)

This item defines how the video is powered down to save power. This item is set to DPMS (Display Power Management Software) by default.

MODEM Use IRQ (Auto)

If you want an incoming call on a modem to automatically resume the system from a power-saving mode, use this item to specify the interrupt request line (IRQ) that is used by the modem. You might have to connect the fax/modem to the motherboard Wake On Modem connector for this feature to work.

HDD Off After (Disable)

The IDE hard drive will spin down if it is not accessed within a specified length of time. Options are from 1 Min to 15 Min and Disable.

Power Button Override (Instant Off)

Under ACPI (Advanced Configuration and Power management Interface) you can create a software power down. In a software power down, the system can be resume by Wake Up Alarms. This item lets you install a software power down that is controlled by the power button on your system. If the item is set to Instant-Off, then the power button causes a software power down. If the item is set to Delay 4 Sec. then you have to hold the power button down for four seconds to cause a software power down.

Power On After Power Fail (Always Off)

This item enables your computer to automatically restart or return to its last operating status after power returns from a power failure.

► PM Wake Up Events (Press Enter)

Phoenix-AwardBIOS CMOS Setup Utility
PM Wake Up Events

IRQ [3-7, 9-15], NMI	[Enabled]	Item Help
IRQ 8 Break Suspend	[Disabled]	
Resume By RING	[Disabled]	
Resume By MACPME	[Enabled]	
Resume by PCI PME	[Enabled]	
Power Up by Alarm	[Disabled]	
Month Alarm	Na	
Day of Month Alarm	0	
Time (hh:mm:ss) Alarm	0 : 0 : 0	
Reload Global Timer Events		
Primary IDE	[Disabled]	
Secondary IDE	[Disabled]	
FDD, COM, LPT Port	[Disabled]	
PCI PIRQ[A-D]#	[Disabled]	
		Menu Level ►►

↑ | ← → : Move Enter: Select +/-/PU/PD:Value F10:Save ESC:Exit F1: General Help
F5:Previous Values F6:Fail-Safe Defaults F7:Optimized Defaults

IRQ [3-7, 9-15], NMI (Enabled)

This option determines whether any activity for IRQ 3-7/9-15 will cause the system to wake from a power saving mode.

IRQ 8 Break Suspend (Disabled)

Determines whether the system will monitor IRQ 8 activity and wake the system from a power saving mode when IRQ 8 is activated.

Resume By Ring (Disabled)

Use this item to enable LAN or modem activity to wakeup the system from a power saving mode.

Resume By MACPME (Enabled)

Use this item to enable MAC activity to wake up the system from a power saving mode.

Resume By PCI PME (Enabled)

This item allows users to enable or disable PCI activity to wakeup the system from a power saving mode.

Power Up by Alarm (Disabled)

When set to Enabled, the following three fields become available: Month Alarm, Day of Month Alarm, and Time Alarm Upon arrival of the alarm time, it will instruct the system to wake up. When set to 0 (zero) for the day of the month, the alarm will power on your system every day at the specified time.

**** Reload Global Timer Events ****

Global Timer (power management) events are I/O events whose occurrence can prevent the system from entering a power saving mode or can awaken the system from such a mode. In effect, the system remains alert for anything that occurs to a device that is configured as Enabled, even when the system is in a power-down mode.

Primary/Secondary IDE 1/0 (Disabled)

When these items are enabled, the system will restart the power-saving timeout counters when any activity is detected on any of the drives or devices on the primary or secondary IDE channels.

FDD, COM, LPT Port (Disabled)

When this item is enabled, the system will restart the power-saving timeout counters when any activity is detected on the floppy disk drive, serial ports, or the parallel port.

PCI PIRQ[A-D]# (Disabled)

When disabled, any PCI device set as the Master will not power on the system.

Press <Esc> to return to Power Management Setup page.

PNP/PCI Configurations

These options configure how PnP (Plug and Play) and PCI expansion cards operate in your system. Both the the ISA and PCI buses on the motherboard use system IRQs (Interrupt ReQuests) and DMAs (Direct Memory Access). You must set up the IRQ and DMA assignments correctly through the PnP/PCI Configurations Setup utility for the motherboard to work properly. Selecting PnP/PCI Configurations on the main program screen displays this menu:

Phoenix-AwardBIOS CMOS Setup Utility
PnP/PCI Configurations

		Item Help
Reset Configuration Data	[Disabled]	
Resources Controlled By X IRQ Resources	[Auto(ESCD)] Press Enter	Menu Level ▶▶
PCI/VGA Palette Snoop	[Disabled]	Default is Disabled. Select Enabled to reset Extended System Configuration Data (ESCD) when you exit Setup if you have installed a new add-on and the system reconfiguration has caused such a serious conflict that the OS cannot boot
Assign IRQ For USB	[Enabled]	
INT Pin 1 Assignment	[Auto]	
INT Pin 2 Assignment	[Auto]	
INT Pin 3 Assignment	[Auto]	
INT Pin 4 Assignment	[Auto]	
INT Pin 5 Assignment	[Auto]	
INT Pin 6 Assignment	[Auto]	
INT Pin 7 Assignment	[Auto]	
INT Pin 8 Assignment	[Auto]	

↑↓ → ← : Move Enter: Select +/-/PU/PD: Value F10: Save ESC: Exit F1: General Help
F5: Previous Values F6: Fail-Safe Defaults F7: Optimized Defaults

Reset Configuration Data (Disabled)

If you enable this item and restart the system, any Plug and Play configuration data stored in the BIOS Setup is cleared from memory.

Resources Controlled By Auto (Auto(ESCD))

You should leave this item at the default Auto (ESCD). Under this setting, the system dynamically allocates resources to Plug and Play devices as they are required.

If you cannot get a legacy ISA (Industry Standard Architecture) expansion card to work properly, you might be able to solve the problem by changing this item to Manual, and then opening up the IRQ Resources submenu.

- **IRQ Resources (Press Enter):** In the IRQ Resources submenu, if you assign an IRQ to Legacy ISA, then that Interrupt Request Line is reserved for a legacy ISA expansion card. Press <Esc> to close the IRQ Resources submenu.

PCI/VGA Palette Snoop (Disabled)

This item is designed to overcome problems that can be caused by some non-standard VGA cards. This board includes a built-in VGA system that does not require palette snooping so you must leave this item disabled.

Assign IRQ For USB (Enabled)

Names the interrupt request (IRQ) line assigned to the USB on your system. Activity of the selected IRQ always awakens the system.

INT Pin 1-8 Assignment (Auto)

Identifies the interrupt request (IRQ) line assigned to a device connected to the PCI interface of your system.

PC Health Status

On motherboards that support hardware monitoring, this item lets you monitor the parameters for critical voltages, temperatures and fan speeds.

Phoenix-AwardBIOS CMOS Setup Utility
PC Health Status

Shutdown Temperature	[Disabled]	Item Help
CPU Core Voltage		
DDR Voltage		Menu Level ▶
Vcc 3.3V		
Vcc 5.0V		
+12V		
Voltage Battery		
CPU Temperature		
System Temperature		
CPU FAN Speed		
SYS FAN Speed		
PWR FAN Speed		

↑↓←→ : Move Enter: Select +/-/PU/PD:Value F10:Save ESC:Exit F1: General Help
F5:Previous Values F6:Fail-Safe Defaults F7:Optimized Defaults

Shutdown Temperature (Disabled)

Enables you to set the maximum temperature the system can reach before powering down.

System Component Characteristics

These fields provide you with information about the systems current operating status. You cannot make changes to these fields.

- CPU Core Voltage
- DDR Voltage
- 3.3V
- 5.0
- +12V
- Voltage Battery
- CPU Temperature
- System Temperature
- CPU FAN Speed
- SYS FAN Speed
- PWR FAN Speed

Frequency/Voltage Control

This item enables you to set the clock speed and system bus for your system. The clock speed and system bus are determined by the kind of processor you have installed in your system.

Phoenix-AwardBIOS CMOS Setup Utility Frequency/Voltage Control

CPU Clock Ratio	[0 X]	Item Help
Auto Detect DIMM/PCI Clk	[Enabled]	
Spread Spectrum	[Enabled]	
Clock Control By	[Auto]	Menu Level ▶
x Async AGP/PCI/SRC Clk	Disabled	
x CPU Frequency	100	
x CPU:DRAM Frequency Ratio	SPD	
DRAM Frequency		

↑↓ → ← : Move Enter: Select +/-/PU/PD:Value F10:Save ESC:Exit F1:General Help
F5:Previous Values F6:Fail-Safe Defaults F7:Optimized Defaults

CPU Clock Ratio (0 X)

Use the CPU Host/SDRAM/PCI Clock to set the frontside bus frequency for the installed processor (usually 133 MHz, 100 MHz or 66 MHz). Then use *CPU Clock Ratio Jumpless* to set a multiple. The multiple times the frontside bus must equal the core speed of the installed processor e.g., **3.5 (multiple) x 100 MHz (frontside bus) = 350 MHz (installed processor clock speed)**.

Auto Detect DIMM/PCI Clk (Enabled)

When this item is enabled, BIOS will disable the clock signal of free DIMM/PCI slots.

Spread Spectrum (Enabled)

If you enable spread spectrum, it can significantly reduce the EMI (Electro-Magnetic Interference) generated by the system.

Clock Control By (Auto)

Use this item to set the CPU Host Clock frequency to Auto or by manual setting. Select “Manual” to activate the following items and set each item manually.

Load Fail-Safe Defaults

This option opens a dialog box that lets you install fail-safe defaults for all appropriate items in the Setup Utility: Press <Y> and the <Enter> to install the defaults. Press <N> and then <Enter> to not install the defaults. The fail-safe defaults place no great demands on the system and are generally stable. If your system is not functioning correctly, try installing the fail-safe defaults as a first step in getting your system working properly again. If you only want to install fail-safe defaults for a specific option, select and display that option, and then press <F6>.

Load Optimized Defaults

This option opens a dialog box that lets you install optimized defaults for all appropriate items in the Setup Utility. Press <Y> and then <Enter> to install the defaults. Press <N> and then <Enter> to not install the defaults. The optimized defaults place demands on the system that may be greater than the performance level of the components, such as the CPU and the memory. You can cause fatal errors or instability if you install the optimized defaults when your hardware does not support them. If you only want to install setup defaults for a specific option, select and display that option, and then press <F7>.

Set Password

When this function is selected, the following message appears at the center of the screen to assist you in creating a password.

ENTER PASSWORD

Type the password, up to eight characters, and press <Enter>. The password typed now will clear any previously entered password from CMOS memory. You will be asked to confirm the password. Type the password again and press <Enter>. You may also press <Esc> to abort the selection. To disable password, just press <Enter> when you are prompted to enter password. A message will confirm the password being disabled. Once the password is disabled, the system will boot and you can enter BIOS Setup freely.

PASSWORD DISABLED

If you have selected “**System**” in “Security Option” of “BIOS Features Setup” menu, you will be prompted for the password every time the system reboots or any time you try to enter BIOS Setup. If you have selected “**Setup**” at “Security Option” from “BIOS Features Setup” menu, you will be prompted for the password only when you enter BIOS Setup.

Supervisor Password has higher priority than User Password. You can use Supervisor Password when booting the system or entering BIOS Setup to modify all settings. Also you can use User Password when booting the system or entering BIOS Setup but can not modify any setting if Supervisor Password is enabled.

Save & Exit Setup

Highlight this item and press <Enter> to save the changes that you have made in the Setup Utility and exit the Setup Utility. When the Save and Exit dialog box appears, press <Y> to save and exit, or press <N> to return to the main menu.

Exit Without Saving

Highlight this item and press <Enter> to discard any changes that you have made in the Setup Utility and exit the Setup Utility. When the Exit Without Saving dialog box appears, press <Y> to discard changes and exit, or press <N> to return to the main menu.



If you have made settings that you do not want to save, use the “Exit Without Saving” item and press <Y> to discard any changes you have made.

This concludes Chapter 3. Refer to the next chapter for information on the software supplied with the motherboard.

Memo

Chapter 4

Using the Motherboard Software

About the Software CD-ROM

The support software CD-ROM that is included in the motherboard package contains all the drivers and utility programs needed to properly run the bundled products. Below you can find a brief description of each software program, and the location for your motherboard version. More information on some programs is available in a README file, located in the same directory as the software.



Never try to install all software from folder that is not specified for use with your motherboard.

Before installing any software, always inspect the folder for files named README.TXT, INSTALL.TXT, or something similar. These files may contain important information that is not included in this manual.

Auto-installing under Windows 98/ME/2000/XP

The Auto-install CD-ROM makes it easy for you to install the drivers and software for your motherboard.



If the Auto-install CD-ROM does not work on your system, you can still install drivers through the file manager for your OS (for example, Windows Explorer). Refer to the Utility Folder Installation Notes later in this chapter.

The support software CD-ROM disc loads automatically under Windows 98/ME/2000/XP. When you insert the CD-ROM disc in the CD-ROM drive, the autorun feature will automatically bring up the install screen. The screen has three buttons on it, Setup, Browse CD and Exit.

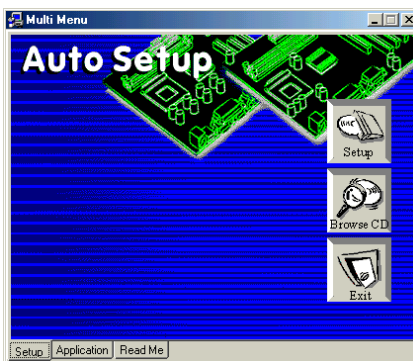

If the opening screen does not appear; double-click the file "setup.exe" in the root directory.

Setup Tab

Setup	Click the Setup button to run the software installation program. Select from the menu which software you want to install.
Browse CD	<p>The Browse CD button is the standard Windows command that allows you to open Windows Explorer and show the contents of the support CD.</p> <p>Before installing the software from Windows Explorer, look for a file named README.TXT, INSTALL.TXT or something similar. This file may contain important information to help you install the software correctly.</p> <p>Some software is installed in separate folders for different operating systems, such as DOS, WIN NT, or WIN98/95. Always go to the correct folder for the kind of OS you are using.</p> <p>In install the software, execute a file named SETUP.EXE or INSTALL.EXE by double-clicking the file and then following the instructions on the screen.</p>
Exit	The EXIT button closes the Auto Setup window.

Application Tab

Lists the software utilities that are available on the CD.

Read Me Tab

Displays the path for all software and drivers available on the CD.

Running Setup

Follow these instructions to install device drivers and software for the motherboard:

1. Click **Setup**. The installation program begins:

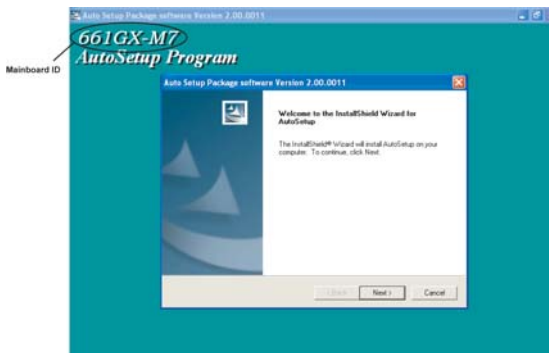

The following screens are examples only. The screens and driver lists will be different according to the motherboard you are installing.

The motherboard identification is located in the upper left-hand corner.

Using the Motherboard Software

2. Click **Next**. The following screen appears:

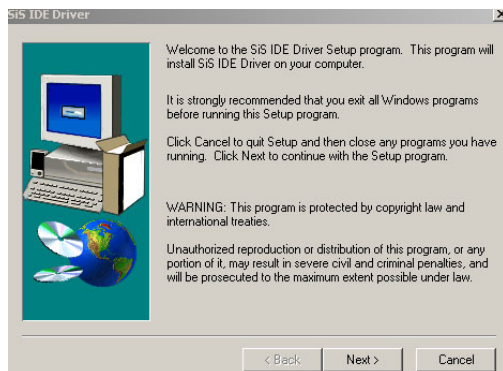

3. Check the box next to the items you want to install. The default options are recommended.
4. Click **Next** run the Installation Wizard. An item installation screen appears:

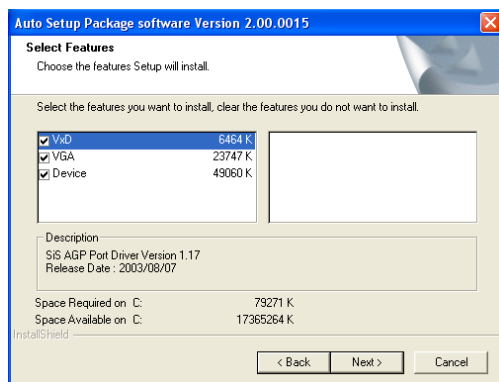

5. Follow the instructions on the screen to install the items.

Drivers and software are automatically installed in sequence. Follow the onscreen instructions, confirm commands and allow the computer to restart a few times to complete the installation.

Manual Installation

Insert the CD in the CD-ROM drive and locate the PATH.DOC file in the root directory. This file contains the information needed to locate the drivers for your motherboard.

Look for the chipset and motherboard model; then browse to the directory and path to begin installing the drivers. Most drivers have a setup program (SETUP.EXE) that automatically detects your operating system before installation. Other drivers have the setup program located in the operating system subfolder.

If the driver you want to install does not have a setup program, browse to the operating system subfolder and locate the readme text file (README.TXT or README.DOC) for information on installing the driver or software for your operating system.

Utility Software Reference

All the utility software available from this page is Windows compliant. They are provided only for the convenience of the customer. The following software is furnished under license and may only be used or copied in accordance with the terms of the license.



These software(s) are subject to change at anytime without prior notice. Please refer to the support CD for available software.

AMI/AWARD Flash Memory Utility

This utility lets you erase the system BIOS stored on a Flash Memory chip on the motherboard, and lets you copy an updated version of the BIOS to the chip. Proceed with caution when using this program. If you erase the current BIOS and fail to write a new BIOS, or write a new BIOS that is incorrect, your system will malfunction. Refer to Chapter 3, Using BIOS for more information.

WinFlash Utility

The Award WinFlash utility is a Windows version of the DOS Award BIOS flash writer utility. The utility enables you to flash the system BIOS stored on a Flash Memory chip on the motherboard while in a Windows environment. This utility is currently available for WINXP\ME\2000\98SE. To install the WinFlash utility, run WINFLASH.EXE from the following directory: \UTILITY\WINFLASH 1.51

This concludes Chapter 4.

Chapter 5

SiS 964 SATA RAID Setup Guide

Introduction for SiS964 SATA RAID Function

The 964 S-ATA controller only support two serial ATA on two independent ports. The Serial ATA RAID is designed to provide a cost-effective, high performance RAID solution that adds performance and/or reliability to PC desktops and/or servers using Serial ATA/150 hard disks.

Serial ATA RAID function supports striping (RAID 0), mirroring (RAID 1), and span (JBOD). Please note that the function supports hard disk drives only and the 964 S-ATA controller don't support Striping + mirroring (Raid 0+1).

With striping, identical drives can read and write data in parallel to increase performance. Mirroring increases read performance through load balancing and elevator sorting while creating a complete backup of your files. Span would increase the logic hard disk space.

Serial ATA RAID striped arrays can double the sustained data transfer rate of Serial ATA/150. Serial ATA RAID fully supports Serial ATA/150 specification of up to 150MB/sec per drive, depending on individual drive specifications.

Features

- The SiS 964 controller only support two Serial ATA (Serial ATA RAID) drivers.
- Support RAID function: RAID 0, RAID 1, JBOD.
- Support bootable disk.
- Windows-based RAID Utility software tool (only support Windows XP and 2000).
- BIOS Utility.

Support Operating Systems

Support Microsoft Windows 98/98SE/ME/2000 Professional and Server/XP.

What is RAID?

This section will give you an overview about the RAID system and introduce the basic background and glossary which you need to know before using "SiS RAID Controller Application".

- 1 **RAID:** (Redundant Array of Independent Disk Drives) use jointly several hard drives to increase data transfer rates and data security. It depends on the number of drives present and RAID function you select to fulfill the security or performance purposes or both.
- 2 **RAID 0:** Also known as "Striping". All of the data are distributed evenly to all of the existing drives. You gain benefits on performance because the data transfer rate is multiplied by the number of drives. However, RAID 0 has high risks of data security. All of the stored data will be lost if even any one drive in the RAID set crashes.
- 3 **RAID 1:** Also known as "Mirroring". Two hard drives are required. The goal of RAID 0 is to ensure data security. Data is written to two or more drives synchronously. That is, 100% duplication of data from one drive to another.

- 4 **JBOD:** (Just a Bunch of Drives). Also known as “Spanning”. Two or more hard drives are required. Several hard disk types configured as a single hard disk. The hard drives are simply hooked up in series. This expands the capacity of your drive and results in a useable total capacity. However, JBOD will not increase any performance or data security.

Installing Software Drivers

SiS provides RAID driver for SiS 964 SATA with RAID function.

- 1 For RAID function, SiS 964 support RAID0, RAID1 and JBOD by software RAID driver only.
- 2 Support the function of installing windows to RAID array.

New Windows 2000/XP Installation

- 1 Start the installation:
Boot from the CD-ROM. Press F6 when the message “Press **F6** key if you need to install third party SCSI or RAID driver” appears.
- 2 When the Windows 2000/XP Setup window is generated, press **S** key to specify an Additional Device(s).
- 3 Insert the driver diskette into drive A: and press Enter.
- 4 Choose one of the following items:
“WinXP SiS Raid/IDE Controller”,
“Win2000 SiS Raid/IDE Controller”,
that appears on screen, and then press the Enter key.
- 5 Press Enter to continue with installation or if you need to specify any additional devices to be installed, do so at this time. Once all devices are specified, Press Enter to continue with installation.
- 6 From the Windows 2000/XP Setup screen, press the Enter key. Setup will now load all device files and then continue the Windows 2000/XP installation.
- 7 Please install the driver package again (ex. SiS RAID driver v1.00) while the operation system has been setup.



If you would like to install windows to any RAID set, you should create RAID from BIOS utility or SiS 964 RAID Utility first and then follow the steps above.

Existing Windows 2000/XP/98/Me Installation

- 1 Install the driver by executing SiS driver setup utility.
- 2 The drivers will be automatically installed.

Confirming Windows 2000/XP Driver Installation

- 1 From Windows 2000/XP, open the Control Panel from “My Computer” followed by the System icon.
- 2 Choose the “Hardware” tab, then click the “Device Manager” tab.
- 3 Click the “+” in front of “SCSI and RAID Controllers” hardware type. The driver **“SiS 180 Raid Controller”** should appear.

Confirming Windows 98/Me Driver Installation

- 1 From Windows 98/Me, open the Control Panel from "My Computer" followed by the System icon.
- 2 Choose the "Device Manager" tab.
- 3 Click the "+" in front of "IDE ATA/ATAPI Controllers" hardware type. The driver "SiS 180 IDE Dual Channel" and "SiS 180 IDE/RAID Controller" should appear.

BIOS Utility Operation

BIOS Utility supports windows 2000/XP/98/Me.

Starting BIOS Utility

- 1 Boot your system. If this is the first time you have booted with the SiS 964 and the drives installed, the BIOS will display the following:

Silicon Integrated Systems Corp. RAID BIOS Setting Utility v0.XX
(c) 2003-2005 Silicon Integrated Systems Corp. All Rights Reserved.

Press <Ctrl.<S> to run BIOS Setting Utility

- 2 Press <Ctrl-S> keys to display the SiS 964 Utility Main Menu.

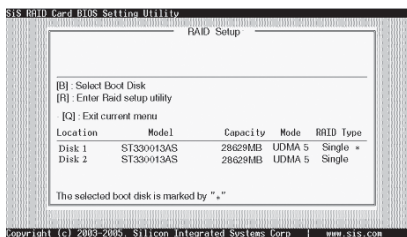

- 3 You can press key to select the boot disk on the 964 controller. The yellow highlight will show on the disk and you can switch it to select the disk you wanted. Press "Enter" key to select it and the selected boot device will be marked by "*". The default boot device will be set as **Disk 1**.
- 4 Press <R> to display the RAID setup menu below. This is the fastest and easiest method to creating your first array.

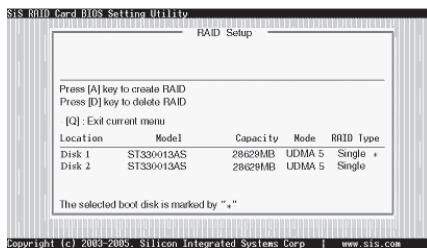

Create RAID

- SIS 964 controller support RAID 0, RAID 1 and JBOD.

Creating a RAID 0 (Stripe) Array for Performance

- SIS 180 enables users to create striped arrays with 2, 3, or 4 drives.
- SIS 964 only supports 2 SATA drivers to create a stripe array.

To create an array for best performance, follow these steps:

- 1 Press <A> to start creating a RAID array.
- 2 Press <2> and <Enter> to select RAID 0.

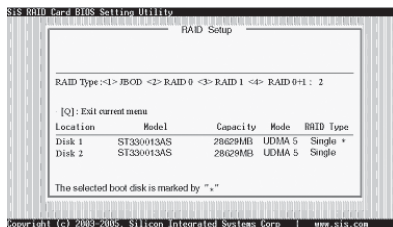

- 3 You will have two selections to create a RAID 0 array. **The default value is <1>**. If you select <1>**Auto Create**, you can create a RAID 0 array faster and easier. The Blocksize will be selected by its default value "64K". The result after creating will be show on **step 8**. Besides, you also can select <2>**Manual Create**, see following steps.

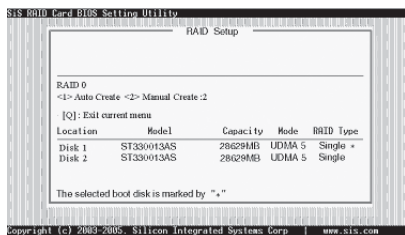

- 4 Press <1>-<5> keys and <Enter> to select Block Size. (Default:64K)

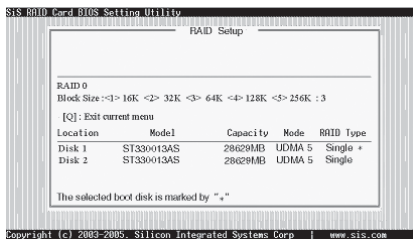

- 5 Use <↑ > <↓ > to select disk, and press <Enter> to select disk, <Q> to exit. When you press <Enter> on the disk you wanted, the RAID Type will be changed from Single to RAID 0. An the disk you select first will be the SOURCE disk.

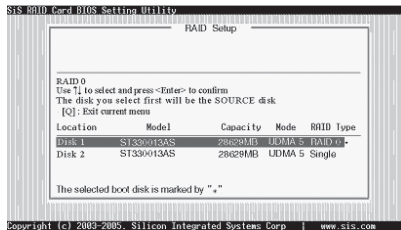

- 6 Next, you will see a message “Split the SOURCE(DISK x) data to RAID disks?”. Press <N> and <Enter> to create RAID 0 array only or press <Y> and <Enter> to split the data from source disk to other disks.

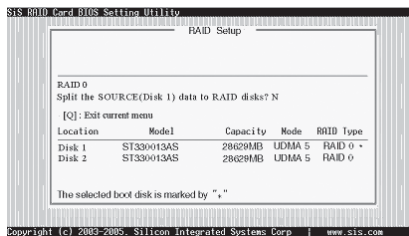

- 7 Starting splitting action, the following frame will be shown.

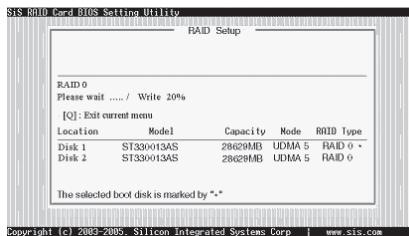

- 8 After all steps finished, press ,<Q> until escape the setup menu and RAID 0 array will be show on the top of the main frame.

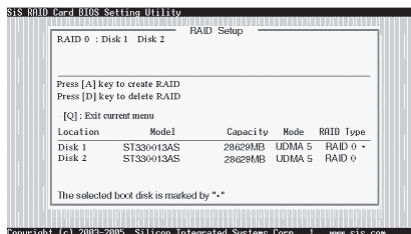

- 9 Press <Q> again to exit this BIOS utility and the red message frame will show. Press <Y> and <Enter> to save changes.
- 10 Once the array has been created, you will need to FDISK and format the array as if it were a new single hard drive.

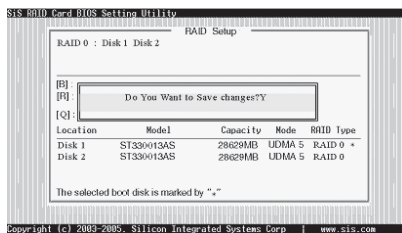

Creating a RAID 1 (Mirror) Array



SIS 964/180 enables users to create Mirror arrays with 2 drives only.

To create a Mirror array, follow these steps:

- 1 Press <A> to start creating a RAID array.
- 2 Press <3> and <Enter> to select Mirror.

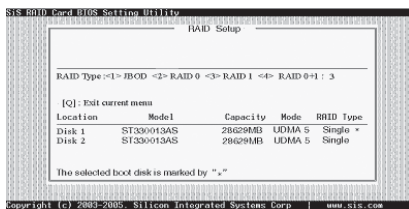

- 3 You will have two selections to create a RAID 1 array. **The default value is <1>**. If you select <1>**Auto Create**, you can create a RAID 1 array faster and easier. The result after creating will be show on **step 7**. Besides, you also can select <2>**Manual Create**, see following steps.

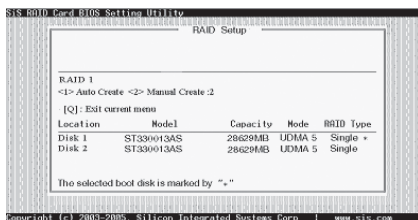

- 4 Use <↑> <↓> to select disk, and press <Enter> to select disk, <Q> to exit. When you press <Enter> on the disk you wanted, the RAID Type will be changed from **Single** to **RAID 1**. The same as RAID 0, the disk you select first will be the SOURCE disk.

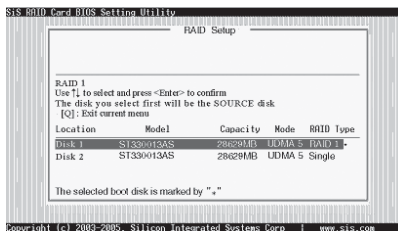

- 5 Next, you will see a message "Duplicate the SOURCE (DISK x) data to RAID disks?". Press <N> and <Enter> to create RAID 1 array only or press <Y> and <Enter> to duplicate the data from source disk to mirror disk.

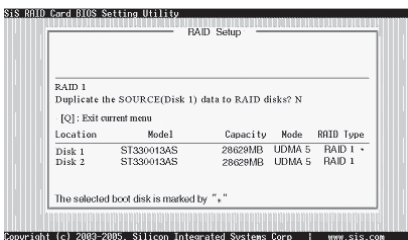

- 6 Starting duplicating action, the following frame will be showing.

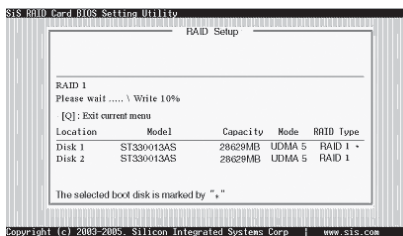

- 7 After all steps finished, press <Q> until escape the setup menu and RAID 1 array will be show on the top of the main frame.

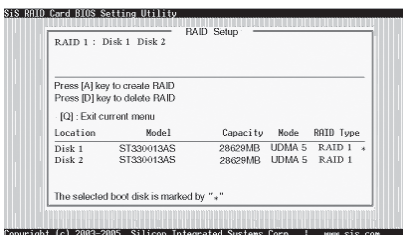

- 8 Press <Q> again to exit this BIOS utility and the red message frame will show as the same as the creation of the RAID 0 array. Press <Y> and <Enter> to save changes.
- 9 Once the array has been created, you will need to FDISK and format the array as if it were a new single hard drive.

Creating a JBOD Array



- 1 SIS 180 enables users to create JBOD arrays with 2,3, or 4 drives.
- 2 SIS 964 only supports 2 SATA drivers to create a JBOD arrays.

To create an JBOD array, follow these steps:

- 1 Press <A> to start creating a RAID array.
- 2 Press <1> and <Enter> to select JBOD.
- 3 You will have two selections to create a JBOD array. **The default value is <1>**. If you select <1>**Auto Create**, you can create a JBOD array faster and easier. The result after creating will be show on **step 5**. Besides, you also can select <2>**Manual Create**, see following steps.

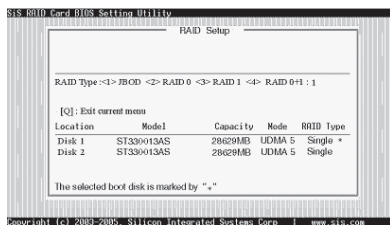

- 4 Use <↑> <↓> to select disk, and press <Enter> to select disk, <Q> to exit. When you press <Enter> on the disk you wanted, the RAID Type will be changed from **Single** to **JBOD**.

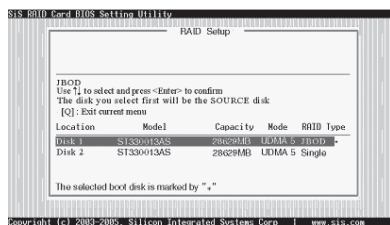

- 5 After all steps finished, press <Q> until escape the setup menu and JBOD array will be show on the top of the main frame.

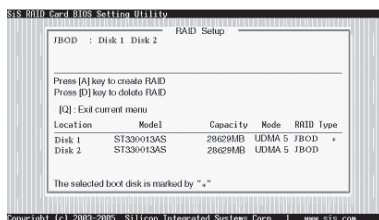

- 6 Press <Q> again to exit this BIOS utility and the red message frame will show as the same age as the creation of the RAID 0 array. Press <Y> and <Enter> to save changes.
- 7 Once the array has been created, you will need to FDISK and format the array as if it were a new single hard drive.

This concludes Chapter 5.

Caractéristiques

Processeur

Cette carte mère utilise un type LGA775 de Pentium 4 présentant les fonctionnalités suivantes :

- Reçoit des processeurs Intel P4/Celeron
- Support un bus système (FSB) de 533MHz
- Supporte le CPU de technologie "Hyper-Threading"

La technologie "Hyper-Threading" permet au système d'exploitation de penser qu'il est connecté à deux processeurs, permettant d'exécuter deux threads en parallèle, à la fois sur des processeurs 'logiques' dans le même processeur physique.

Chipset

La SiS 661GX Northbridge (NB) et SiS964 Southbridge (SB) sont basés sur une architecture novatrice et dimensionnable avec une fiabilité et des performances prouvées.

SiS661GX(NB)

- Supporte 12 transactions remarquables et une exécution hors norme
- Intègre le SiS MuTIOL 1G haut débit s'interconnectant au média d'E/S SiS964 MuTIOL 1G avec bus de données bidirectionnel pour réaliser une bande passante de 1Go/s en mode 133 MHz x 4.
- Supporte l'interface AGP 8X/4X avec Fast Write Transaction
- Supporte les SDRAM DDR400/333/266
- Supporte un Accélérateur Graphique 3D/2D de hautes performances 256bits et de haute qualité

SiS964(SB)

- Entretien simultané pour tous les Périphériques DMA: Contrôleurs IDE Doubles, contrôleur SATA , trois contrôleurs d'hôte USB 2.0 /1.1 et un contrôleur d'hôte USB 2.0, Contrôleur MAC LAN et Contrôleur DMA Audio/Modem.
- Conforme aux spécifications PCI 2.3.
- Conforme aux spécifications ATA 1.0 Série, supporte le mode d'économie d'énergie.
- Conforme à AC'97 v2.3 supportant 6 Canaux de sorties audio et Modem V.90 HSP.
- Contrôleur USB 2.0 intégré avec trois hubs racine et huit ports de fonction.

Mémoire

- Supporte le module mémoire DDR SDRAM 400/333/266 MHz
- Peut recevoir deux SDRAM DDR DIMM sans mémoire tampon de 2.5 volts
- Jusqu'à 1 Go par DIMM avec une taille de mémoire maximum de 2 Go

Graphiques

- Intégré dans un moteur 256 bits 3D hautes performances, prenant en charge Ultra-AGP II™ avec une bande passante allant jusqu'à 2,7Go/s
- Intégré dans un moteur 3D de haute qualité, prenant en charge une taille de texture jusqu'à 2048x2048
- Prend en charge le décodage VCD, DVD et HDTV

Audio

- Conforme au CODEC AC'97 V2.3
- Prend en charge le CODEC audio 6 canaux destiné aux systèmes multimédia PC
- Offre trois entrées stéréo de niveau de ligne analogique avec contrôle de volume 5 bits: Ligne d'entrée, CD, AUX
- Prend en charge la fonction de sortie S/PDIF

Options d'Extensions

La carte mère est livrée avec les options d'extensions suivantes:

- Un logement compatible AGP 3.0 avec vitesse 8X/4X (supporte la carte 1.5V AGP seulement)
- Trios logement conforme PCI v2.3 32 bits
- Deux embases basses IDE de 40 broches prenant en charge jusqu'à quatre périphériques IDE
- Une interface de lecteur de disquette
- Deux connecteurs SATA à 7 broches
- Un logement Communications Network Riser (CNR)

Cette carte mère prend en charge la maîtrise de bus Ultra DMA avec des vitesses de transfert de 133/100/66 Mo/s.

LAN Interne (Optionnel)

Le LAN interne offre les caractéristiques suivantes:

- Supporte le fonctionnement en Auto-négociation N-way en 10Mb/s et 100Mb/s
- Supporte le fonctionnement en half/full duplex
- Supporte la fonction Wake-On-LAN (WOL) -réveil par appel réseau et le réveil à distance
- Supporte le mode de coupure d'alimentation

E/S intégrées

La carte mère comporte un ensemble complet de connecteurs et de ports E/S :

- Deux ports PS/2 pour souris et clavier
- Un port série
- Un port parallèle
- Un port VGA
- Quatre ports USB
- Un port LAN (optionnel)
- Prise audio pour micro, entrée de ligne et sortie de ligne

Microprogramme BIOS

La carte mère utilise Award BIOS qui permet à l'utilisateur de configurer bon nombre de fonctions du système, dont :

- Gestion d'alimentation
- Alertes de réveil
- Paramètres de CPU
- Synchronisation de CPU et de mémoire

Le micro-programme peut également être utilisé pour définir les paramètres pour différentes vitesses d'horloge de processeur.



Certaines spécifications matérielles et certains éléments logiciels sont susceptibles de modification sans préavis.

Leistungsmerkmale

Prozessor

Das Motherboard verwendet einen LGA775 Typ Pentium 4 mit den folgenden Eigenschaften:

- Nimmt Intel P4/Celeron Prozessoren auf
- Unterstützt einen Systembus (FSB) mit 533 MHz
- Unterstützt CPU mit "Hyper-Threading"-Technologie

"Hyper-Threading"-Technologie läßt das Betriebssystem glauben, es sei an zwei Prozessoren angeschlossen, was zwei parallele Threads auf separaten 'logischen' Prozessoren im selben physischen Prozessor erlaubt.

Chipsatz

Die SiS661GX Northbridge (NB) und SiS964 Southbridge (SB) basieren auf einer innovativen und skalierbaren Architektur mit bewiesener Zuverlässigkeit und Leistung.

- SiS661GX(NB)**
- Unterstützt 12 hervorragende Tätigkeiten und eine sehr gute Abfertigung.
 - Anpassung des hochleistungsfähigen SiS MuTIOL 1G, welcher sich mit dem SiS964 MuTIOL 1G media I/O zusammenschließt, mit zweiseitigem 16-Bit Data-Bus zur Erlangung von 1GB/s Bandbreite im 133 MHz x 4 Modus.
 - Unterstützt AGP 8X/4X-Interface mit Fast Write-Abwicklung
 - Unterstützt DDR400/333/266 SDRAM
 - Unterstützt eines hochleistungsfähigen 256 bits und qualitativ hochwertigen 3D/2D-Grafikbeschleunigers

- SiS964(SB)**
- Gleichzeitige Bedienung aller DMA-Geräte: Duale IDE-Controller, SATA-Controller, drei USB 2.0/1.1 Host-Controller, LAN MAC-Controller und Audio/Modem DMA-Controller
 - Gemäß Spezifikationen von PCI 2.3.
 - Gemäß Serial ATA 1.0 Spezifikationen, unterstützt den Stromsparmodus .
 - Gemäß AC'97 v2.3 welcher 6 Audio-Output-Kanäle und ein V.90 HSP-Modem unterstützt.
 - Onboard-USB 2.0-Controller mit drei Root Hub und acht Port.

Speicher

- Unterstützt DDR400/333/266 MHz DDR SDRAM-Speichermodule
- Nimmt zwei ungepufferte DIMM mit 2.5 Volt DDR SDRAM auf
- Bis zu 1 GB pro DIMM mit einer maximalen Speichergröße von bis zu 2GB

Grafik

- Integrierter hochleistungsfähiger 256-Bit 3D-Engine, unterstützt Ultra-AG-P11™ mit einer Bandbreite von bis zu 2.7GB/s
- Integrierter Qualitäts-3D-Engine, unterstützt eine Texturgröße von bis zu 2048x2048
- Unterstützt VCD-, DVD- und HDTV-Dekodierung

Audio

- Entspricht AC' 97 V2.3 CODEC
- Unterstützt 6-Kanal Audio CODEC, entwickelt für Multimedia PC-Systeme
- Stellt drei analoge Line-Level Stereoeingänge mit 5-bit Lautstärkeregelung zur Verfügung: Line-in, CD, AUX
- Unterstützt S/PDIF Ausgangsfunktion

Erweiterungsmöglichkeiten

Das Motherboard bietet die folgenden Erweiterungsoptionen:

- Einen AGP 3.0 Steckplatz, gemäß Sockel mit 8X/4X Geschwindigkeit (unterstützt nur 1.5V AGP Interface)
- Drei 32-bit PCIv2.3-Steckplätze
- Zwei 40-Pin IDE-Flach-Header, die bis zu vier IDE-Geräte unterstützen
- Eine Schnittstelle für ein Floppydiskettenlaufwerk
- Zwei 7-Pin SATA Anschlüsse
- Einen Steckplatz für Communications Network Riser (CNR)

Das Motherboard unterstützt UltraDMA Bus Mastering mit einer Übertragungsrate von 133/100/66 MB/Sek.

Onboard LAN (Optional)

Das Onboard-LAN hat folgende Funktionen:

- Unterstützt 10Mb/Sek und 100Mb/Sek N-way Auto-negotiation Betrieb
- Unterstützt half/full duplex Betrieb
- Unterstützt Wake-On-LAN (WOL) Funktion und Remote Wake-up
- Unterstützt Abschaltfunktion

Integrierte I/O

Das Motherboard hat einen vollständigen Satz von I/O-Schnittstellen bzw. -Anschlüssen:

- Zwei PS/2-Anschlüsse für Maus und Tastatur
- Eine serielle Schnittstelle
- Eine parallele Schnittstelle
- Ein VGA-Anschluss
- Vier USB-Anschlüsse
- Ein LAN-Anschluss (optional)
- Audiobuchse für Mikrofon, Line-In und Line-Out

BIOS-Firmware

Das Motherboard verwendet Award BIOS, das es Benutzern gestattet, viele Systemfunktionen inkl. der Folgenden zu konfigurieren:

- Energieverwaltung
- Aufweckfunktionen
- CPU-Parameter
- CPU- und Arbeitsspeicherfrequenz

Die Firmware kann auch zur Einstellung von Parametern für verschiedene Prozessortaktgeschwindigkeiten verwendet werden.



Manche Hardwarespezifikationen und Softwareelemente können ohne Ankündigung geändert werden.

Caratteristiche

Processore

La scheda madre utilizza un tipo LGA775 di Pentium 4 che offre le seguenti caratteristiche:

- Alloggia processori Intel P4/Celeron
- Supporta un bus di sistema (FSB) fino a 533 MHz
- Supporta CPU con tecnologia "Hyper Threading"

La tecnologia "Hyper-Threading" (HT) abilita il sistema operativo a credere di essere collegato a due processori, consentendo di eseguire in parallelo due Thread, entrambi su processori "logici" separati, all'interno dello stesso processore fisico.

Chipset

I chipset SiS661GX Northbridge (NB) e SiS964 Southbridge (SB) sono basati su un'architettura innovativa e scalabile di provata affidabilità e di eccellenti prestazioni.

- SiS661GX (NB)**
- Supporto di 12 transazioni outstanding e "completion out-of-order".
 - É dotato di interconnessioni SiS964 MuTIOL 1G media I/O con bus dati birezionali a 16 bit in grado di garantire velocità di trasferimento dati pari a 1GB/s nella modalità 133 MHz x 4.
 - Supporta l'interfaccia AGP 8X/4X con Funzione Transizione Fast Write
 - Supporta DDR400/333/266 SDRAM.
 - Supporta grafico 3D/2D con prestazioni 256 bits e qualità elevate

- SiS964 (SB)**
- Supporto simultaneo di tutti i componenti DMA: doppio controller IDE, controller SATA, tre host controller USB 2.0/1.1, controller LAN MAC e controller DMA Audio/Modem
 - Conforme alle specifiche PCI 2.3.
 - Conforme alle specifiche Serial ATA 1.0, supporto delle modalità di risparmio energetico .
 - Conforme alle specifiche AC'97 v2.3 con il supporto di 6 canali audio in uscita e HSP-Modem V.90.
 - Controller USB 2.0 integrato con tre hub e otto porte funzione

Memoria

- Supporta un modulo di memoria SDRAM con DDR fino a 400/333/266 MHz
- Può alloggiare due DIMM SDRAM DDR unbuffered a 2.5 volt
- Fino a 1 GB per ciascun DIMM con una capacità massima di memoria di 2 GB

Grafica

- Motore 3D a 256 bit a elevate prestazioni integrato, con supporto di Ultra-AGPII™ con larghezza di banda fino a 2,7 GB/s
- Motore 3D di alta qualità integrato, con supporto di dimensioni di texture fino a 2048x2048
- Supporto di decodifica VCD, DVD e HDTV

Multi-Language Translation

Audio

- Conforme alla specifica AC'97 v2.3 CODEC
- Supporto di CODEC audio a 6 canali per sistemi PC multimediali
- Tre ingressi analogici stereo lineari con controllo volume a 5 bit: Line-In, CD, AUX
- Supporto di funzionalità S/PDIF in uscita

Opzioni d'espansione

La scheda madre è dotata delle seguenti opzioni di espansione

- Uno slot AGP 3.0 8X/4X(supporta solo l'interfaccia 1.5V AGP)
- Tre slots PCI v2.3 a 32 bit
- Due testate a passo profilo IDE a 40 per il supporto di fino a quattro dispositivi IDE
- Una interfaccia floppy disk
- Due connettori SATA a 7 pin.
- Una slot Communications e Network Riser (CNR)

La scheda madre supporta il bus mastering Ultra DMA con transfer rate 133/100/66 MB/sec.

LAN su scheda (Opzionale)

La scheda LAN integrata è dotata delle seguenti funzioni:

- Supporta operazioni di auto-negoziazione N-way a 10Mb/s e 100Mb/s
- Supporto operazioni half/full duplex
- Supporto funzione WOL (Wake on Lan) e wake up remoto
- Supporto modalità Power Down

I/O integrato

La scheda madre ha una serie completa di porte e connettori I/O:

- Due porte PS/2 per mouse e tastiera
- Una porta seriale
- Una porta parallela
- Una porta VGA
- Quattro porte USB
- Una porta LAN (opzionale)
- Connettori audio per microfono, ingresso linea ed uscita linea

Firmware BIOS

La scheda madre impiega il software Award BIOS che abilita gli utenti a configurare molte caratteristiche di sistema, tra cui sono incluse le seguenti:

- Risparmio energetico
- Allarmi di riattivazione
- Parametri CPU
- Temporizzazione di CPU e memoria

Il Firmware può anche essere utilizzato per impostare i parametri di diverse velocità di temporizzazione del processore.



Alcune specifiche hardware ed elementi software sono soggetti a modifica senza preavviso.

Características Procesador

Esta placa principal usa un tipo LGA775 de Pentium 4 que lleva las sigtes. características:

- Acomoda procesadores Intel P4/Celeron
- Soporta un sistema de bus (FSB) de 533MHz
- Soporta CPU de tecnología "Hyper-Threading"

La tecnología "Hyper-Threading" habilita el sistema operativo para que piense como si estuviera conectado a dos procesadores, que permite dos hilos a correr en paralelo, ambos en procesadores "lógicos" dentro del mismo procesador físico.

Chipset

Los chipsets Northbridge SiS661GX (NB) y Southbridge SiS964 (SB) están basados en una arquitectura innovadora y escalable con fiabilidad y rendimiento comprobados.

- | | |
|---------------------|---|
| SiS661GX(NB) | <ul style="list-style-type: none"> • Soporta 12 transacciones sobresalientes y terminación fuera de pedido. • Acomoda SiS MuTIOL 1G de alto rendimiento que interconecta al SiS964 MuTIOL 1G media I/O con bus de datos de 16-bit bidireccional para realizar ancho de banda de 1GB/s en modo 133 MHz x 4 mode. • Soporta la interfaz AGP 8X/4X c/ Transacción de Escritura Rápida • Soporta DDR400/333/266 SDRAM • Soporta un Acelerador de Gráficas 3D/2D de Alto Rendimiento 256bits & Alta Calidad |
| SiS964(SB) | <ul style="list-style-type: none"> • Servicio concurrente de todos los Dispositivos DMA : Controladores IDE Dual, controlador SATA, tres controladores anfitriones USB 2.0/1.1, controlador LAN MAC y Controlador DMA Audio/Modem • Conforme con la espec. PCI 2.3. • Conforme con la espec. Serial ATA 1.0, soporta modo de ahorro de energía . • Conforme con AC'97 v2.3 que soporta 6 Canales de salidas de sonido y V.90 HSP-Modem. • Controlador USB 2.0 integrado con tres hubs de raíz y ocho puertos funcionales |

Memoria

- Soporta DDR hasta módulo de memoria 400/333/266 MHz SDRAM
- Acomoda dos DIMM sin buffer de DDR SDRAM de 2.5 voltios
- Hasta 1 GB por DIMM con tamaño de memoria máximo hasta 2GB

Gráficas

- Una motor 3D de 256-bit de alto rendimiento incorporada, soporta Ultra-AGPII™ hasta una ancha de banda de 2.7GB/s
- Una motor 3D de alta calidad incorporada, soporta hasta el tamaño de textura de 2048x2048
- Soporta la decodificación de VCD, DVD y HDTV

Sonido

- Conforme con el CODEC AC'97 v2.3
- Soporta CODEC de audio de 6 canales diseñados para los sistemas multimedia
- Provee tres entradas en estéreo a nivel de línea analógicas con control de volumen de 5-bit: LINE-IN CD, AUX
- Soporta la función de salida S/PDIF

Opciones de expansión

La placa principal viene con las sigtes. opciones de expansión:

- Una ranura conforme con AGP 3.0 con la velocidad 8X/4X (soporta interfaz 1.5V AGP solamente)
- Tres ranuras conforme con 32-bit PCI v2.3
- Dos cabezales de bajo perfil IDE de 40-pin que soporta hasta cuatro dispositivos IDE
- Una interfaz de lector de floppy
- Dos conectores 7-pin SATA
- Una ranura de Communications Network Riser

La placa principal soporta mastering de bus Ultra DMA con índices de transferencia de 133/100/66 MB/s.

LAN en abordo (Optativo)

El LAN abordo provee las sigtes. características:

- Admite el funcionamiento de negociación automática de n vías de 10Mb/s y 100Mb/s
- Dúplex completo y medio
- Soporta la función Wake-On-LAN (WOL) y despertar remoto
- Soporta el modo apagado

I/O integrado

La placa base tiene un conjunto completo de puertos I/O y conectores:

- Dos puertos PS/2 para ratón y de teclado
- Un puerto serie
- Un puerto paralelo
- Un puerto VGA
- Cuatro puertos USB
- Un puerto LAN (optativo)
- Clavijas de audio para micrófono, entrada de línea y salida de línea

Firmware de BIOS

La placa base utiliza Award BIOS que permite a los usuarios configurar muchas funciones del sistema, incluyendo las siguientes:

- Administración de energía
- Alarmas de encendido
- Parámetros CPU
- Temporización de memoria y CPU

El firmware también puede utilizarse para ajustar los parámetros para diversas velocidades del reloj del procesador.



Algunas especificaciones de hardware y elementos de software están sujetos a cambios sin previo aviso.

Multi-Language Translation

Características

Processador

Esta motherboard usa um tipo de Pentium 4 LGA775 que possui as seguintes características:

- Acomoda processadores Intel Intel P4/Celeron
- Suporta um bus sistema (FSB) de 533MHz
- Suporta CPU de tecnologia "Hyper-Threading"

A tecnologia "Hyper-Threading" permite que o sistema operativo "pense" que está ligado a dois processadores, permitindo que sejam executados dois threads em paralelo, ambos em processadores

Chipset

O SiS661GX Northbridge (NB) e o SiS964 Southbridge (SB) baseia-se numa inovadora arquitectura escalável, com confiança e desempenho comprovados.

- SiS661GX(NB)**
- Suporta 12 transacções pendentes e conclusão "Fora de Serviço"
 - Acomoda um elevado rendimento da interligação do SiS MuTIOL 1G com o suporte de dados E/S do SiS964 MuTIOL 1G com bus de dados de 16 bits bidireccional para executar uma largura de banda de 1GB/s no modo 133 MHz x 4
 - Suporta AGP 8X/4X Interface com Transacção de Escrita Rápida
 - Suporta DDR400/333/266 SDRAM
 - Suporta Acelerador de Gráfico 3D/2D de Alta Performance 256 bits & Qualidade
- SiS964(SB)**
- Manutenção concorrente de todos os dispositivos DMA: Controladores IDE Duplos, controlador SATA, três controladores host USB 2.0/1.1, Controlador LAN MAC e Controlador DMA Áudio/Modem
 - Em conformidade com a especificação PCI 2.3
 - Série ATA 1.0, suporta o modo de poupança de energia
 - Compatível com AC'97 v2.3, suporta 6 canais de saída de áudio e a norma V.90 HSPModem
 - Controlador USB 2.0 Integrado com três hubs de raiz e oito portas de função

Memória

- Suporta o módulo de memória DDR400/333/266 MHz DDR SDRAM
- Acomoda dois DIMM sem polimento de 2.5 volt DDR SDRAM
- Até 1 GB por DIMM com tamanho de memória máxima de até 2 GB

Gráficos

- Incorporado com um dispositivo 3 D de 256 bits e de elevada performance, suportando Ultra-AGP II™ com até 2.7GB/seg. de largura de banda
- Incorporado com um dispositivo 3D de elevada qualidade, suportando até 2048x2048 de formato de textura
- Suporta descodificação VCD, DVD e HDTV

Multi-Language Translation

Áudio

- Cumpre com o AC'97 v2.3 CODEC
- Suporta CODEC áudio com 6 canais concebido para sistemas multimédia para PC
- Fornece três entradas estéreo nível de linha analógicas com controlo de volume de 5 bits: Line-in, CD, AUX
- Suporta uma função de saída S/PDIF

Opções de expansão

A placa principal vem equipada com as seguintes opções de expansão:

- Uma ranhura compatível com AGP 3.0 com uma velocidade de 8X/4X (suporta apenas 1.5V AGP)
- Três ranhuras compatíveis com PCI v2.3 de 32 bits
- Dois colectores de perfil baixo IDE com 40 pinos suportando até quatro dispositivos IDE
- Uma interface da unidade de disquete
- Dois conectores SATA de 7 pinos
- Uma ranhura de Aumento da Rede de Comunicações (CNR)

Esta motherboard suporta mastering bus Ultra DMA com taxas de transferência de 133/100/66MB/s.

LAN integrada (Opcional)

A LAN incorporada oferece as seguintes características:

- Suporta o funcionamento de negociação automática de 10Mb/s e 100Mb/s N-direcções
- Suporta o funcionamento meio/completo duplex
- Suporta a função Wake-On-LAN(WOL) e despertar remoto
- Suporta o modo de ausência de energia

E/S integradas

A placa principal conta com um conjunto completo de portas e conectores E/S:

- Duas portas PS/2 para o rato e o teclado
- Uma porta de série
- Uma porta paralela
- Uma porta VGA
- Quatro portas USB
- Uma porta LAN (opcional)
- Tomadas de áudio para microfone, linha de entrada e linha de saída

Firmware do BIOS

A placa principal usa o Award BIOS que permite aos usuários configurar vários recursos do sistema, como:

- Gerenciamento de energia
- Alarmes de reativação
- Parâmetros da CPU
- Sincronização da CPU e memória

O firmware também pode ser usado para definir os parâmetros de diferentes velocidades de clock do processador.



Alguns itens de software e especificação de hardware estão sujeitos a alterações sem prévio aviso.

機能 プロセッサ

このマザーボードにはLGA775 タイプのPentium 4 を取り付け可能で、次の特徴があります:

- Intel P4/Celeronプロセッサに対応
- 533 MHzのシステムバス(FSB)をサポート
- 塔nイバースレッド 技術をサポート

"Hyper-Threading"技術というのは、事実上1つのプロセッサ (物理上のプロセッサ) を、2つのプロセッサ (論理上のプロセッサ) が存在するようにオペレーションシステムに認識させることで、同一の物理上のプロセッサで2つの電算スレッドを同時に執行させる技術です。

チップセット

SiS661GX Northbridge(NB)およびSiS964 Southbridge(SB)チップセットは、実証された信頼性と性能を持つ革新的で拡張性のあるアーキテクチャに基づいています。

- SiS661GX(NB)**
- 12つの未解決トランザクション(outstanding transaction) と乱終了(out-of-order completion) に対応可能
 - 搭載している高性能 SiS MuTIOL 1G は、双方向16ビットバスで SiS964 MuTIOL 1G メディア I/O と相互に連結することにより、1GB/s bandwidth in 133 MHz x 4 モードで1G/秒の帯域幅を実現
 - 高速書き込み可能なAGP 8X/4Xインターフェースをサポートし
 - DDR400/333/266 SDRAM対応
 - 高性能を主眼とする256ビットのと高品質を主眼とする3D/2Dのグラフィック・アクセラレータをサポート
- SiS964 (SB)**
- すべてのDMAデバイスの同時稼働が可能、これらのデバイスにはテュアルIDE コントローラ、SATA コントローラ、3つのUSB 2.0/1.1 ホストコントローラ、LAN MAC コントローラ、およびオーディオ/モデムDMA コントローラがある
 - PCI 2.3仕様に準拠
 - シリアルATA 1.0仕様に準拠し、省電力モードをサポート
 - AC' 97 v2.3に準拠し、6 チャンネルオーディオ出力と V.90 HSP-モデムをサポート
 - 統合したUSB 2.0コントローラで、3つのルートハブと8つのポートを提供

メモリー

- 400 /333/266 MHz DDR SDRAMまでのDDRメモリモジュールに対応
- 2.5V仕様DDR SDRAM の非バッファードDIMMスロットを2つ備え
- それぞれのDIMMに1 GBのメモリー容量の搭載が可能で、合計2 GBまで可能

グラフィック

- 高性能の256ビット3Dエンジンを内蔵し、Ultra-AGP II™を最大2.7GB/秒の帯域幅までサポート
- 高品質3 D エンジンを内蔵し、最大2048x2048 までのテクスチャサイズをサポート
- VCD、DVD、およびHDTV のテコード機能をサポート

オーディオ

- AC'97 v2.3仕様に適合
- PCマルチメディアシステムの6チャンネルオーディオCODECをサポート
- 5ビット音声コントロール可能なアナログラインレベルのステレオ入力が3つ: ラインイン、CD、およびAUX
- S/PDIF出力をもサポート

拡張オプション

このメインボードには次の拡張オプションがあります:

- 8X/4Xモード対応のAGP3.0仕様スロット(1.5VAGPインターフェースのみに対応)が1つ
- 32ビットPCIスロットが3つ
- 2つの40ピンIDE low profile ヘッダーで4つまでのIDE装置の取り付けをサポート
- フロッピーディスクインターフェースが1つ
- 7ピンSATAコネクタが2つ
- CNR (Communication Networking Riser) スロットが1つ

このマザーボードは、133/100/66MB/秒の転送速度でのUltra DMA/バスマスタリングをサポートします。

オンボードLAN (オプション)

オンボードLANは、次の機能を提供します

- 10Mb/秒と100Mb/秒のN-ウェイ自動検出機能
- 半/全二重動作
- Wake-On-LAN (WOL) 機能とリモートwake-up機能
- 省電力モード

統合I/O

マザーボードには、次のI/Oポートやコネクタを揃えています

- マウスとキーボード用のPS/2ポートが2つ
- シリアルポート が1つ
- パラレルポート が1つ
- VGAポート が1つ
- USBポート が4つ
- LANポート が1つ(オプション)
- マイク、ラインイン、ラインアウト用オーディオジャック

BIOSファームウェア

本マザーボードはAward BIOSを採用することにより、次の機能を含めた多様なシステム構成を可能にしました

- 電源管理
- ウェークアップアラーム
- CPUパラメータ
- CPUおよびメモリのタイミング

さらに、所定のパラメータを設定することによって、プロセッサのクロック速度を変更することもできます。



一部のハードウェア仕様とソフトウェアアイテムは、予告なしに変更することがありますので、ご了承ください。

Multi-Language Translation

특징

프로세서

본 마더보드는 팬티엄 4 의 LGA775 을 사용하며 다음과 같은 특성을 지닙니다:

- Intel P4/Celeron 프로세서 사용
- 533 MHz 시스템 버스(FSB) 지원
- "Hyper-Threading" 기술 CPU 지원

"Hyper-Threading(HT)" 기술은 운영체제로 하여금 두 개의 프로세서에 연결된 것으로 인식하게 하여 동일한 물리적 프로세서 내의 각기 분리된 논리적 프로세서에서 두 개의 스레드를 병렬로 실행할 수 있게 합니다.

칩셋

SiS661GX Northbridge (NB) 와 SiS964 Southbridge (SB) 칩셋은 혁신적이고 범위성을 지닌 아키텍처를 바탕으로 인정된 신뢰성과 성능을 지닌다.

- SiS661GX(NB)**
- 12개의 우수한 transactions 과 out-of-order completion 지원
 - SiS MuTIOL 1G media I/O에 높은 처리량을 지닌 SiS964 MuTIOL 1G 인터커넥션과 쌍방향 16 비트 데이터 버스를 사용하여 133 MHz x 4 모드에서 1 GB/s 대역폭을 가능하게 한다.
 - AGP 8X/4X 인터페이스 / Fast Write Transaction 지원
 - DDR400/333/266 SDRAM 지원
 - 고성능 256 bits 및 고품질의 3D/2D 그래픽 지원
- SiS964(SB)**
- 모든 DMA 장치의 동시 사용: 듀얼 IDE 컨트롤러, SATA 컨트롤러, 3 개의 USB 2.0/1.1 호스트 컨트롤러, LAN MAC 컨트롤러 및 오디오/모뎀 DMA 컨트롤러
 - PCI 2.3 사양 호환.
 - 시리얼 ATA 1.0 사양 호환, 절전 모드 지원 .
 - 6 채널의 오디오 출력과 V.90 HSP-모뎀을 지원하는 AC'97 v2.3 호환.
 - 3 개의 루트 허브와 8 개의 기능 포트를 지닌 통합 USB 2.0 컨트롤러

메모리

- DDR 400/333/266 MHz DDR SDRAM 메모리 모듈 지원
- 2.5볼트 DDR SDRAM의 unbuffered DIMM 2 개 사용
- 각 DIMM 메모리 1 GB, 최대 메모리 크기 2GB

그래픽

- 고성능 256 비트 3D 엔진 내장, Ultra-AGP II™ 최대 대역폭 2.7GB/s 지원
- 고품질 3D 엔진 내장, 최대 텍스처 크기 2048x2048 지원
- VCD, DVD 및 HDTV 디코딩 지원

오디오

- AC'97 v2.3 코덱 부합
- PC 멀티미디어 시스템을 위해 디자인 된 6 채널 오디오 코덱 지원
- 5 비트 볼륨 컨트롤의 아날로그 라인 레벨 스테레오 입력 3개 : Line-in, CD, AUX
- S/PDIF 출력 기능 지원

확장 옵션

마더보드에는 다음과 같은 확장 옵션이 있습니다.

- 8X/4X 속도의 AGP 3.0 호환 슬롯 1개(1.5V AGP 인터페이스만 지원)
- 32 비트 PCI v2.3 호환 슬롯 3 개
- 2 개의 40 핀 IDE low profile 헤더, 최대 4 개의 IDE 장치 지원
- 플로피 디스크 드라이브 인터페이스 1 개
- 7핀 SATA 커넥터 2개
- Communications Network Riser (CNR) 슬롯 1 개

메인보드는 전송 속도 133/100/66 MB/s 의 Ultra DMA bus mastering 을 지원한다

온보드 LAN(선택 품목)

온보드 LAN에는 다음과 같은 특징이 있습니다.

- 10Mb/s 및 100 Mb/s 자동 조정 오퍼레이션 지원
- half/full duplex 오퍼레이션 지원
- Wake-On-LAN (WOL) 기능 및 원격 wake-up 지원
- 파워 다운 모드 지원

통합 I/O

마더보드에는 충분한 수의 I/O 포트 및 커넥터가 있습니다.

- 마우스 및 키보드용 PS/2 포트 2개
- 시리얼 포트 1개
- 병렬 포트 1개
- VGA 포트 1개
- USB 포트 4개
- LAN 포트 1개(선택 품목)
- 마이크, 라인 인 및 라인 아웃용 오디오 단자

바이오스 펌웨어

마더보드는 다음의 기능은 물론 많은 시스템 기능을 설정할 수 있게 하는 Award 바이오스를 사용합니다.

- 전원 관리
- 웨이크업(Wake-up) 경보
- CPU 매개 변수
- CPU 및 메모리 타이밍

펌웨어를 사용하여 다른 프로세서 클럭 속도에 대한 매개 변수를 설정할 수도 있습니다.



일부 하드웨어 사양 및 소프트웨어 항목은 사전 통보 없이 변경될 수 있습니다.

功能 處理器

本主機板適用於LGA775 型Pentium 4 且具有如下功能：

- 支援Intel P4/Celeron 處理器
- 支援高達533 MHz之系統匯流排(FSB)
- 支援使用高速執行緒(Hyper-Threading)技術之CPU

利用"超執行緒(HT)"技術,可使作業系統在相當於裝上了兩具處理器的狀態下運作: 利用一個實體處理器模擬出兩個獨立的"邏輯"處理器,同時執行兩個工作緒。

晶片組

SiS661GX北橋及SiS964南橋晶片組,採用了獨創且具有擴充功能的架構,能夠發揮最佳的穩定性及功能。

- SiS661GX(NB)**
 - 可處理12個未結束傳送(outstanding transactions)和不按序完成執行(out-of-order completion)
 - 配有高效能 SiS MuTIOL 1G,介以雙向16位元資料匯流排而與 SiS964 MuTIOL 1G media I/O 相連,在 133MHz × 4模式下提供1GB/秒的頻寬
 - 支援AGP 8X/4X 介面(有無快速功能均可)
 - 支援DDR400/333/266 SDRAM
 - 支援高性能256 位元及高品質的3D/2D繪圖加速器
- SiS964(SB)**
 - 同時對所有DMA裝置提供服務。這些裝置有雙IDE雙控制器、SATA 控制器、3個 USB 2.0/1.1 主控制器、LAN MAC 控制器、及音訊/數據機 DMA控制器
 - 符合 PCI 2.3規格
 - 符合序列ATA 1.0規格,並支援省電模式
 - 符合AC' 97 v2.3規格,支援6聲道音訊輸出及V.90 HSP數據機
 - 整合有USB 2.0控制器,具有3個集線器及8個連接埠

記憶體

- 支援DDR高達400 /333/266 MHz 之SDRAM記憶體模組
- 具有2個2.5伏特DDR SDRAM用的無緩衝DIMM
- 每一DIMM可支援1 GB記憶體模組,最大支援記憶體容量高達2GB

繪圖卡

- 內建一高效能256位元3D引擎,支援高達2.7GB/秒頻寬的Ultra-AGP™
- 內建一高品質3 D引擎,支援高達至2048x2048 紋理尺寸
- 支援VCD、DVD及HDTV 解碼功能

音效

- 相容於AC'97 2.3版CODEC規格
- 支援為個人電腦多媒體系統設計的6聲道音訊CODEC功能
- 提供具有5位元音量控制功能的3種類比線級立體音效輸入：LINE-IN、CD、及AUX
- 支援S/PDIF輸出功能

擴充選項

主機板機載有下列擴充選項功能：

- 1個支援8X/4X 模式的AGP 3.0相容插槽(僅支援1.5伏特電壓規格介面)
- 3個32位元PCI插槽
- 2個40針IDE短鐵接頭，可支援高達4個IDE裝置
- 1個軟體機介面
- 2個7針SATA插頭
- 1個通訊網路附加卡(Communications Network Riser, CNR)插槽

主機板也支援Ultra DMA 匯流排主控功能，可提供133 / 100 / 66 MB/sec之傳輸速率。

機載LAN(選項)

機載 LAN功能具有如下功能：

- 支援 10 Mb秒及100 Mb秒N向自動辨識連線功能
- 支援半/全雙工
- 支援Wake-On-LAN (WOL)功能及遠端wake-up功能
- 支援省電(power down)模式

整合 I/O

主機板具有一組齊全的 I/O 連接埠及連接頭：

- 2 個 PS/2 埠，供滑鼠與鍵盤使用
- 1 個串列埠
- 1 個平行埠
- 1 個VGA埠
- 4 個USB埠
- 1 個區域網路埠 (選項)
- 麥克風音頻插座、線級輸入及線級輸出

BIOS 韌體

本主機板使用 Award BIOS，使用者可以組態設定許多系統功能，包括如下：

- 電源管理
- 喚醒警鈴
- CPU 參數
- CPU 及記憶體の時脈定時

此外，也可藉由參數的設定，調整處理器的時脈速度。



部份硬體規格和軟體內容可能會在未經通知的情況下更動，敬請見諒。

功能

处理器

此主板使用 LGA775 型 Pentium 4 CPU，具备以下特点：

- 支持 Intel P4/Celeron 处理器
- 支持 533 MHz 系统总线 (FSB)
- 支持“多线程”技术 CPU

“多线程”技术可以让操作系统认为自己连接了两个处理器，允许两个线程并行运行，每个线程位于同一处理器中的单独“逻辑”处理器中。

芯片组

SiS661GX 北桥 (NB) 和 SiS964 南桥 (SB) 芯片组是基于一种新型的、可扩展的架构，能提供已经证明的可靠性和高性能。

SiS661GX(NB)

- 支持 12 个未决事务处理和故障完成
- 支持高吞吐量 SiS MuTIOL 1G 与 SiS964 MuTIOL 1G 媒体 I/O 互连 (带双向 16 位数据总线，在 133 MHz x 4 模式下提供 1GB/s 带宽)
- 支持带快写处理功能的 AGP 8X/4X 接口
- 支持 DDR400/333/266 SDRAM
- 支持高性能 256 位和高品质的 3D/2D 图形加速器

SiS964(SB)

- 所有 DMA 设备的并发服务：双 IDE 控制器、SATA 控制器、3 个 USB 2.0/1.1 主控器、LAN MAC 控制器和音频/调制解调器 DMA 控制器
- 符合 PCI 2.3 规格
- 符合串行 ATA 1.0 规格，支持节电模式
- 符合 AC'97 v2.3 (支持 AC'97 扬声器 6 通道输出) 标准和 V.90 HSP 标准
- 集成 USB 2.0 控制器，带有 3 个 Root Hub 和 8 个功能端口

内存

- 支持 DDR400/333/266 MHz DDR SDRAM 内存模块
- 支持 2 个 2.5 volt DDR SDRAM 非缓冲 DIMM 插槽
- 每个 DIMM 最大支持 1 GB，总共可支持 2 GB

图形

- 内建高性能 256 位 3D 引擎，支持 Ultra-AGPITM，最高带宽 2.7GB/s
- 内建高质量 3 D 引擎，支持 2048x2048 纹理尺寸
- 支持 VCD、DVD 和 HDTV 解码

音频

- 符合AC'97 v2.3 编解码器规格
- 支持为PC多媒体系统设计的 6 声道音频编解码器
- 提供 3 路带 5 位音量控制的模拟线路电平立体声输入：线入、CD 和 AUX
- 支持 S/PDIF 输出功能

扩展选项

此主板提供如下扩展选项：

- 1 个 8X/4X AGP 3.0 插槽(只支持 1.5V AGP 接口)
- 3 个 32 位 PCI v2.3 扩展槽
- 2 个 40-pin IDE 紧凑型接口，支持 4 个 IDE 设备
- 1 个软驱接口
- 2 个 7-pin SATA 接口
- 1 个通信网络转接 (CNR) 插槽

此主板支持 Ultra DMA 总线控制，传输速率可达 133 / 100 / 66 MB/sec。

Onboard LAN (可选)

板上集成的 LAN 提供以下功能

- 支持 10Mb/s 和 100Mb/s N 路自协商工作
- 支持半双工/全双工工作
- 支持 LAN 唤醒 (WOL) 功能和远程唤醒功能
- 支持省电模式

集成 I/O

此主板具有完整的 I/O 端口和插孔：

- 2 个用于连接鼠标和键盘的 PS/2 端口
- 1 个串口
- 1 个并口
- 1 个 VGA 端口
- 4 个 USB 端口
- 1 个 LAN 端口 (可选)
- 麦克风、线入和线出声音插孔

BIOS

此主板使用 Award BIOS，可以让用户自己配置以下系统功能：

- 电源管理
- 唤醒报警
- CPU 参数
- CPU 和记忆定时

还可用于设置不同处理器时钟速度的参数



某些硬件规格和软件项目若有更改恕不另行通知。

Характеристики

Процессор

Плата построена на базе процессора Pentium 4 LGA775 и обладает следующими характеристиками:

- Размещает процессоры Intel P4/Celeron
- Поддерживает системные шины (FSB) с частотой 533MHz
- Поддерживает технологию CPU "Hyper-Threading"

Технология "Hyper-Threading" убеждает операционную систему в том, что в машине имеется два процессора; это позволяет параллельно обслуживать два процесса, причем каждый из процессов обслуживается отдельным «логическим» процессором в пределах одного физического процессора.

Чипсет

Чипсеты SiS661GX «Северный мост» (Northbridge, NB) и SiS964 «Южный мост» (Southbridge, SB) построены с использованием инновационной масштабируемой архитектуры, обеспечивающей высокую надежность и производительность.

- SiS661GX(NB)**
 - Поддерживает одновременное выполнение 12 операций и внеочередное завершение операций
 - Размещает высокопропускное соединение SiS MuTIOL 1G с мостиком SiS964 MuTIOL 1G с двусторонней 16-битной шиной данных и обеспечивает скорость передачи данных 1 ГБ/с в режиме 133 МГц x4
 - Поддерживает интерфейс AGP 8X/4X с технологией Fast Write
 - Поддерживает DDR400/333/266 SDRAM
 - Поддержка высокопроизводительного 256-битного акселератора высококачественной графики 3D/2D
- SiS964(SB)**
 - Параллельное обслуживание всех DMA-устройств : Двойной IDE-контроллер, SATA-контроллер, три USB 2.0/1.1 хост-контроллера, контроллер LAN MAC и аудио/модем DMA-контроллер
 - Совместимость с PCI 2.3
 - Совместимость со спецификацией Serial ATA 1.0, поддержка режима энергосбережения
 - Совместимо с AC'97 v2.3б поддерживает 6 – канальный аудиовыход AC'97 и модем V.90 HSP
 - Встроенный контроллер USB 2.0 с трехканальным концентратором и восьмью функциональными портами

Память

- Поддерживает модули памяти DDR400/333/266 МГц DDR SDRAM
- Размещает Два модуля небуферируемой памяти DIMM с 2.5 volt DDR SDRAM
- Поддерживает до 1 Гб DIMM при максимальном объеме памяти 2 Гб

Графика

- Встроенный высокопроизводительный 256-битный модуль 3D графики, поддержка технологии Ultra-AGP II™ со скоростью трансфера до 2.7 Гб/с
- Встроенный 256-битный модуль высококачественной 3D графики, поддержка размеров текстуры до 2048x2048
- Поддержка декодирования VCD, DVD и HDTV

Multi-Language Translation

Аудио

- Совместимость с AC'97 V2.3 CODEC
- Поддержка 6-канального аудио-CODEC для компьютерных мультимедиа систем
- Три аналоговых стереовхода с 5-битной регуляцией громкости: LINE-IN, CD, AUX
- Поддержка выхода S/PDIF

Возможности расширения

Существуют следующие опции расширения данной материнской платы:

- Один слот, совместимый с AGP 3.0, обеспечивающий скорость 8X/4X (Поддерживает только интерфейс 1.5V AGP)
- Три 32-битных слотов PCI v2.3
- Два 40-штырьковых низкопрофильных разъема IDE с поддержкой до четырех устройств IDE
- Один разъем для накопителя на гибких дисках
- Два разъема 7-pin SATA
- Один слот CNR

Плата поддерживает захват управления шиной Ultra DMA со скоростью передачи 133/100/66 МБ/с.

Встроенный сетевой адаптер LAN (опционально)

Встроенный сетевой адаптер LAN обладает следующими характеристиками:

- Поддерживает автоматическое определение скорости и режима соединения 10Mb/s и 100Mb/s
- Поддерживает режимы Half/Full duplex
- Поддерживает функции Wake-On-LAN и remote wake-up
- Поддержка режима выключения электропитания

Интегрированный вход/выход

Плата снабжена полным набором портов входа/выхода и разъемов:

- Два порта PS/2 для подключения мыши и клавиатуры
- Один серийный порт
- Один параллельный порт
- Один порт VGA
- Четыре порта USB
- Один порт LAN (опционально)
- Гнездо для подключения микрофона, гнезда аудио-входа и выхода

BIOS

Плата работает под Award BIOS, который позволяет пользователю конфигурировать различные характеристики системы:

- Управление питанием
- Сигналы пробуждения системы
- Параметры CPU
- Время доступа для CPU и памяти

BIOS допускает также установку параметров для различных частот процессора.



Некоторые параметры платы и характеристики ее программного обеспечения могут быть изменены без предварительного уведомления.

Cechy

Procesor

Ta płyta główna zaopatrzona jest w procesor Pentium 4 typu LGA775 i charakteryzuje się następującymi cechami:

- Przystosowana do obsługi procesorów Intel P4/Celeron
- Obsługuje szynę systemową (FSB) 533MHz
- Zabezpiecza technologią CPU "Hyper-Threading"

Technologia "Hyper-Threading" powoduje, że system "myśli", że posiada dwa procesory i wykonuje równolegle dwa procesy; za wykonanie każdego procesu odpowiedzialny jest jeden z dwóch "logicznych" procesorów w ramach jednego fizycznego procesora

Chipset

Mostek północny (NB) SiS661GX i mostek południowy (SB) SiS964 chipsetu oparty jest na nowatorskiej i skalowalnej architekturze o sprawdzonej niezawodności i funkcjonalności.

- SiS661GX(NB)**
- Obsługuje wykonywanie 12 równoległych operacji i zakończenie operacji po za kolejnością
 - Obsługuje szybkie łącze SiS MuTIOL 1G z SiS964 MuTIOL 1G media I/O z dwukierunkową 16-bitową szyną danych, zabezpiecza szybkość przesyłu 1GB/s w trybie 133 MHz x4
 - Obsługuje interfejs AGP 8X/4X z technologią Fast Write
 - Obsługuje DDR400/333/266 SDRAM
 - Obsługa zintegrowanego akseleratora 256-bitowej grafiki 3D/2D
- SiS964(SB)**
- Obsługuje wszystkie współczesne urządzenia DMA: kontrolery dual IDE, kontrolery SATA, trzy kontrolery USB 2.0/1.1, kontroler LAN MAC i kontroler audio/modem DMA
 - Zgodny z PCI w wersji 2.3
 - Zgodnie z protokołem Serial ATA 1.0 zapewnia tryb oszczędności energii
 - Zgodny z AC'97 w wersji 2.3, obsługuje 6 kanałowe wyjście AC'97 audio oraz HSP-modem V.90.
 - Zintegrowany kontroler USB 2.0 z trójdrożnym rozdzielnikiem i ośmifunkcyjnym złączem

Pamięć

- Obsługuje pamięć DDR400/333/266 MHz DDR SDRAM
- Mieści 2 moduły niebuforowanej pamięci DIMM lub 2.5 volt DDR SDRAM
- Akceptuje DIMM do 1GB, a maksymalna pamięć do 2GB

Grafika

- Zintegrowany 256-bitowy procesor grafiki 3D, obsługa Ultra-AGP II™ o szybkości transferu danych do 2.7 GB/s
- Zintegrowany procesor grafiki 3 D, obsługa tekstur do 2048x2048
- Obsługa dekodowania sygnałów VCD, DVD i HDTV

Audio

- Zgodność z AC'97 V2.3 CODEC
- Obsługa 6-kanalowego audio-CODEC dla multimedialnych systemów komputerowych
- Trzy analogowe linie wejścia stereo z 5-bitową regulacją głośności: LINE-IN, CD, AUX
- Obsługa funkcji wyjścia S/PDIF

Możliwości rozbudowy

Płyta główna wyposażona jest w następujące gniazda:

- Jedno gniazdo zgodne z AGP 3.0 o szybkości 8X/4X (obsługuje tylko karty AGP zasilane 1.5V).
- Trzy 32-bitowych gniazd PCI zgodnych z wersją 2.3.
- Dwa 40-nóżkowe niskoprofilowe złącza IDE obsługujące do czterech urządzeń IDE
- Jedno złącze obsługujące stacje dyskietek
- Dwa 7-nóżkowe złącza SATA
- Jedno gniazdo CNR opcjonalnie

Płyta główna obsługuje magistralę Ultra DMA o szybkościach przesyłu 133/100/66MB/s.

Zintegrowana obsługa sieci LAN (opcjonalnie)

Zintegrowana obsługa sieci LAN posiada następujące właściwości:

- Obsługuje N-drożne automatycznie ustalone operacje z szybkościami 10Mb/s i 100Mb/s
- Zdolność Half/Full duplex
- Obsługuje funkcję Wake-On-LAN i zdalnie sterowane wake-up (uruchamianie komputera)
- Obsługuje automatyczne wyłączenie zasilania

Zintegrowane We/Wy

Płyta główna wyposażona jest w pełny zestaw gniazd i złączy We/Wy:

- Dwa gniazda PS/2 dla myszy i klawiatury
- Jedno gniazdo szeregowe
- Jedno gniazdo równoległe
- Jedno gniazdo VGA
- Cztery gniazda USB
- Jedno gniazdo LAN (opcjonalnie)
- Gniazdo wejściowe mikrofonowe, gniazdo wejściowe i wyjściowe dźwięku (audio)

Firmowy BIOS

Płyta główna wyposażona jest w BIOS firmy Award, który pozwala użytkownikowi konfigurować wiele cech systemu włączając w to następujące właściwości:

- Zarządzanie poborem mocy
- Alarmy typu Wake-up
- Parametry pracy procesora
- Ustalenia szybkości pracy procesora i pamięci

BIOS może być używany do ustalania parametrów wpływających na szybkości pracy zegara procesora.



Niektóre parametry dotyczące płyty i jej oprogramowania mogą ulec zmianie bez uprzedniego powiadomienia.

Multi-Language Translation

Vlastnosti

Procesor

Tato základní deska je určena pro procesory Pentium 4 LGA775 a může nabídnout následující vlastnosti:

- Použití pro procesory Intel P4/Celeron s jádrem
- Podporuje taktování systémové sběrnice (FSB) na frekvenci 533 MHz
- Podporuje technologii CPU „Hyper-Threading“

Technologie „Hyper-Threading“ umožňuje operačnímu systému pracovat tak, jako by byl připojen ke dvěma procesorům, protože je možné pracovat se dvěma toky programového kódu (vlákny) paralelně najednou, přičemž jsou k dispozici samostatné „logické“ procesory umístěné v rámci jednoho fyzického procesoru.

Čipová sada

Čipová sada SiS661GX s northbridge (NB) a southbridge (SB) SiS964 je založena na inovativní a škálovatelné architektuře s ověřenou spolehlivostí a výkonem.

- SiS661GX(NB)**
- Podpora 12 nevyřešených transakcí a nedokončených funkcí.
 - Podpora vysoké průchodnosti SiS MuTIOL 1G s propojením na mediální vstup/výstup SiS964 MuTIOL 1G s obousměrnou 16bitovou datovou sběrnicí k zajištění šířky pásma 1 GB/s na frekvenci 133 MHz x 4.
 - Podpora rozhraní AGP 8X/4X s rychlým zápisem
 - Podpora paměťových modulů DDR400/333/266 SDRAM
 - Podpora vysoce výkonného 256bitového 3D/2D grafického akcelerátoru s vysokou kvalitou
- SiS964(SB)**
- Současná obsluha všech zařízení DMA: duální řadiče IDE, řadič SATA, tři hostitelské řadiče USB 2.0/1.1, řadič LAN MAC a řadič audio/modemu DMA
 - Splňuje požadavky standardu PCI 2.3
 - Splňuje požadavky standardu Serial ATA 1.0, podporuje režim řízení spotřeby energie
 - Splňuje požadavky standardu AC'97 v2.3 s podporou 6kanálového zvuku AC'97 a modemu V.90 HSP
 - Integrovaný řadič USB 2.0 se třemi kořenovými rozbočovači a osmi funkčními porty.

Paměť

- Podporuje paměťové moduly DDR SDRAM, 400/333/266 MHz
- Umožňuje použití až dvě modulů DIMM DDR SDRAM bez vyrovnávací paměti, 2,5 V
- Až 1 GB paměti na jeden modul DIMM s maximální velikostí paměti do 2 GB

Grafika

- Vestavěné vysoce výkonné 256bitové 3D grafické jádro, s podporou Ultra-AGPII s šířkou pásma až 2,7 GB/s
- Vestavěné vysoce kvalitní 3D jádro, podporující velikost textur až 2 048 x 2 048 obrazových bodů
- Podpora dekodování VCD, DVD a HDTV

Audio kodek

- Splňuje požadavky standardu kodeku AC'97 v2.3
- Podpora 6kanálového zvukového kodeku určeného pro multimediální PC systémy
- Nabízí tři analogové linkové stereo vstupy s 5bitovým řízením hlasitosti: LINE-IN, CD, AUX
- Podpora výstupní funkce S/PDIF

Možnosti rozšíření

Základní deska je dodávána s následujícími možnostmi rozšíření

- Jeden slot AGP 3.0 s přenosovými rychlostmi 8x/4x (podpora rozhraní – pouze 1,5 V AGP)
- Tři 32bitové patice PCI v2.3
- Dva nízkoprofilové 40kolíkové konektory IDE podporující připojení čtyř zařízení standardu IDE
- Jedno rozhraní pro disketovou mechaniku
- Dva 7kolíkové konektory SATA
- Jedna patice CNR

Základní deska podporuje řízení sběrnice Ultra DMA s přenosovými rychlostmi 133/100/66 MB/s.

Vestavění síťové rozhraní LAN (volitelně)

Vestavěné síťové rozhraní LAN nabízí následující možnosti:

- Podpora 10Mb/s a 100Mb/s N-cestného automatického přepínání provozu
- Možnost polovičního a plného duplexu
- Podpora funkce Wake-On-LAN a aktivace na dálku
- Podpora režimu vypínání systému

Integrovaný vstup/výstup

Základní deska je vybavena kompletní sadou vstupních portů a konektorů I/O:

- Dva porty PS/2 pro myš a klávesnici
- Jeden sériový port
- Jeden paralelní port
- Jeden port VGA
- Čtyři porty USB
- Jeden port LAN (volitelně)
- Zvukové konektory pro mikrofon, zvukový vstup a výstup

Firmware BIOS

Základní deska využívá BIOS formy Award, který uživateli umožňuje nakonfigurovat mnoho systémových parametrů, včetně následujících:

- Řízení spotřeby
- Alarmy při spouštění systému
- Parametry CPU
- Časování CPU a paměti

Firmware může být rovněž použit k nastavení parametrů pro různé taktovací frekvence procesoru.



Některé technické parametry hardware a software se mohou měnit bez předchozího upozornění.

Multi-Language Translation

Caracteristici

Procesorul

Această placă de bază utilizează Pentium 4 de tipul LGA775, având următoarele caracteristici:

- Funcționează cu procesoare Intel P4/Celeron
- Funcționează cu bus sistem (FSB) de 533 MHz
- Este compatibilă cu unități centrale dotate cu tehnologia „Hyper-Threading”

Tehnologia „Hyper-Threading” permite sistemului de operare să funcționeze ca și cum ar exista două procesoare, putând fi rulate în paralel două fire, fiecare pe câte un procesor „logic” separat, aflate pe același procesor fizic.

Setul de chipuri

Seturile de chipuri SiS661GX Northbridge (NB) și SiS964 Southbridge (SB) se bazează pe o arhitectură inovatoare și scalabilă, care s-a impus deja prin fiabilitate și performanță.

- SiS661GX(NB)**
 - Suportă 12 tranzacții nesoluționate și finalizarea corectării erorilor
 - Funcționează cu SiS MuTIOL 1G de mare capacitate pentru interconectarea cu I/O SiS964 MuTIOL 1G pentru suporturi cu bus sistem bidirecțional pe 16 biți, cu lățime de bandă de 1 GB/s în modul 133 MHz x4
 - suportă interfață AGP 8X/4X cu tranzacția de scriere rapidă
 - Suportă module SDRAM DDR400/333/266
 - Suport pentru accelerator grafic de înaltă performanță pe 256 biți și 3D/2D de cea mai bună calitate
- SiS964(SB)**
 - Deservire concurentă a tuturor aparatelor DMA: controlere IDE duale, controler SATA, trei controlere gazdă USB 2.0/1.1, controler LAN MAC și controler DMA Audio/Modem
 - Compatibil cu specificația PCI 2.3
 - Compatibil cu specificația Serial ATA 1.0, suportând modul de funcționare economicos
 - Compatibilă cu AC'97, versiunea 2.3, suportând 6 canale pentru ieșiri difuzor AC'97 și modem HSP V.90
 - Controler USB 2.0 integrat, cu trei socluri de bază și opt porturi funcționale

Memoria

- Suportă module de memorie DDR SDRAM DDR400/333/266 MHz
- Funcționează cu două module DDR SDRAM DIMM de 2,5 V, fără zonă tampon
- Suportă module de până la 1 GB, cu capacitate maximă de 2 GB

Grafică

- Motor 3D incorporat pe 256 biți de înaltă performanță incorporat, suportând Ultra-AGPII™ cu lățime de bandă de până la 2,7 GB/s
- Motor 3D incorporat de cea mai bună calitate, suportând dimensiuni de textură de până la 2048x2048
- Suportă decodificare VCD, DVD și HDTV

Multi-Language Translation

Audio

- Compatibil cu CODEC AC'97, versiunea 2.3
- Suportă CODEC audio de 6 canale, destinat sistemelor multimedia ale calculatoarelor
- Asigură trei linii intrare stereo analoge, cu control al volumului pe 5 biți: LINE-IN, CD, AUX
- Suportă funcția de ieșire S/PDIF

Opțiuni de extindere

Placa de bază este dotată următoarele posibilități de extindere:

- Un slot compatibili cu AGP 3.0 cu viteze de 8X/4X (suportă doar interfață AGP de 1,5 V)
- Trei sloturi PCI de 32 biți compatibile cu versiunea 2.3
- Două socluri IDE plate de 40 care suportă cel mult patru unități IDE
- O interfață pentru unitate floppy
- Două conecitoare SATA 7
- Un slot CNR

Această placă de bază suportă Ultra DMA bus mastering cu viteza de transfer de 133/100/66MB/s.

Onboard LAN (opțional)

Onboard LAN are următoarele caracteristici:

- Suportă operații de autonegociere N-way de 10 Mb/s și 100 Mb/s
- Posibilitate de semi-duplex sau duplex total
- Suportă funcția Wake-On-LAN și trezirea de la distanță
- Suportă modul deconectare de la sursă

I/O integrată

Placa de bază este dotată cu un set complet de porturi și conecitoare I/O:

- Două porturi PS/2, pentru mouse și tastatură
- Un port serial
- Un port paralel
- Un port VGA
- Patru porturi USB
- Un port LAN (opțional)
- Mufe audio pentru microfon, intrare și ieșire audio

Firmware BIOS

Această placă de bază utilizează Award BIOS, care permite utilizatorului să configureze mai mulți parametri ai sistemului, cum ar fi:

- Gestionarea energiei
- Alarame de trezire
- Parametri CPU
- Temporizare CPU și memorie

Acest firmware poate fi utilizat și pentru a seta parametrii diferitelor frecvențe de comandă ale procesorului.



Anumite specificații hardware și elemente de software pot fi modificate fără înștiințare prealabilă.

Multi-Language Translation

Спецификация

Процесор

Тази дънна платка използва Pentium 4 тип LGA775 със следните спецификации:

- поддръжка на процесори Intel P4/Celeron
- поддръжка на системна шина със скорост 533MHz
- поддръжка на процесори с технология "Hyper-Threading"

Технологията "Hyper-Threading" позволява да се "излъже" операционната система, че работи на два процесора, което дава възможност за паралелното изпълнение на две задачи на два отделни "логически" процесора в един и същ физически процесор.

Чипсет

Чипсетът със северен мост SiS661GX и южен мост SiS964 е изграден на базата на оригинална архитектура с възможност за надстройка с доказана надеждност и производителност.

- SiS661GX(NB)**
- Поддръжка на 12 неизпълнени транзакции и out-of-order completion
 - Високоскоростен интерфейс SiS MuTIOL 1G за връзка с южния мост SiS964, SiS MuTIOL 1G media I/O с двупосочна 16 битова шина за данни и скорост 1GB/s в режим 133 MHz x 4.
 - Поддръжка на интерфейс AGP 8X/4X с Fast Write Transaction
 - Поддръжка на модули памет DDR400/333/266 SDRAM
 - поддръжка на високопроизводителен 256-bit 3D/2D графичен ускорител

- SiS964(SB)**
- Едновременна поддръжка на всички DMA устройства: два IDE контролера, SATA контролер, три USB 2.0/1.1 host контролера, LAN MAC контролер и Audio/Modem DMA контролер.
 - поддръжка на шината PCI 2.3
 - съвместимост със спецификацията Serial ATA 1.0 с поддръжка на икономичен режим на запазване
 - Съвместимост със спецификацията AC'97 v2.3 с поддръжка на 6-канално аудио и модем V.90 HSP
 - Интегриран USB 2.0 контролер с три колектора и осем функционални порта

Памет

- Поддръжка на модули памет DDR400/333/266 MHz DDR SDRAM
- Поддръжка на два небуферирани DIMM / 2.5 volt DDR SDRAM
- Поддръжка до 1 GB на слот DIMM с максимален капацитет до 2 GB

Графичен чип

- интегрирано висококачествено 256-bit 3D графично ядро с поддръжка на Ultra-AGPII™ и честотна лента до 2.7GB/s
- интегрирано висококачествено 3D графично ядро с поддръжка на текстури с размер до 2048x2048
- Поддръжка на декодиране на VCD, DVD и HDTV

Audio

- съвместимост с AC'97 V2.3 CODEC
- поддръжка на 6-канален аудио CODEC специално създаден за мултимедийни системи
- Включва три аналогови линейни стерео входа с 5-битов контрол на силата на звука: LINE-IN, CD, AUX
- поддръжка на функцията S/PDIF Out

Възможности за разширяване

Дънната платка има следните разширителни възможности:

- Един слот AGP 3.0 със скорост 8X/4X (поддържа само интерфейс 1.5V AGP)
- Три слота 32-bit PCI v2.3
- Два нископрофилни 40-pin IDE колектора с поддръжка на четири IDE устройства
- един конектор за флопидисково устройство
- два 7-щифтови SATA конекторас
- един слот CNR

Дънната платка поддържа шина Ultra DMA 133/100/66/33MB/s.

Интегриран мрежов контролер (опция)

Спецификация на интегрирания мрежов контролер:

- поддръжка на 10Mb/s и 100Mb/s, N-Way Auto-negotiation operation
- Half/Full duplex
- поддръжка на функция за "събуждане" Wake-On-LAN и дистанционен wake-up
- Поддръжка на режим "power down"

Интегриран Вход/Изход контролер

Дънната платка има пълен набор от I/O портове и конектори:

- два PS/2 порта за мишка и клавиатура
- един сериен порт
- един паралелен порт
- един VGA порт
- четири USB порта
- един LAN порт (опция)
- Аудио жакове за микрофон, линеен вход и линеен изход

BIOS Firmware

Дънната платка използва Award BIOS с възможност за различни системни настройки, включително

- управление на захранването
- Wake-up аларми
- параметри на процесора
- синхронизиране на процесора и паметта

настройка на скоростта на часовника на процесора



Хардуерните и софтуерни спецификации и параметри могат да бъдат изменени без предупреждение.

Jellemző

Processzor

Ez az alaplap LGA775 típusú Pentium 4 számára készült, és a következő jellemzőkkel bír:

- Intel P4/Celeron processzorokkal működik
- 533 MHz sebességű rendszerbuszt (FSB) támogat
- Támogatja a „Hyper-Threading” technológiát használó központi egységeket

A „Hyper-Threading” technológia által az operációs rendszer úgy működik, mintha két processzorral rendelkezne, ami két szál párhuzamos futását teszi lehetővé két független, ugyanazon fizikai processzoron található „logikai” processzoron.

Lapkakészlet

Az SiS661GX Northbridge (NB) és SiS964 Southbridge (SB) lapkakészletek egy újító és méretezhető, nagy megbízhatóságú és teljesítőképességű architektúrára épülnek.

- SiS661GX(NB)**
- 12 elintézetlen műveletet és hibajavítás befejezését támogatja
 - Nagy teljesítményű SiS MuTIOL 1G, amely a SiS964 MuTIOL 1G I/O hordozóhoz egy kétirányú, 16 bites adatbusszal csatlakozik, 1 GB/s sávszélesség elérésére 133 MHz-es 4-szeres módban.
 - Támogatja a Fast Write (gyors írás) műveletet használó AGP 8X/4X interfészt
 - DDR400/333/266 SDRAM modulokkal kompatibilis
 - Nagyteljesítményű 256 bites és csúcsmínőségű 3D/2D grafikus gyorsító támogatása

- SiS964(SB)**
- Az összes DMA eszköz egyidejű kiszolgálása: duál IDE vezérlők, a SATA vezérlő, három 2.0/1.1 USB gazda vezérlő, LAN MAC vezérlő, valamint Audio/Modem DMA vezérlő
 - Kompatibilis a PCI 2.3-as specifikációjával
 - Kompatibilis a soros ATA 1.0 szabvánnyal, az energiatakarékos üzemmódot is támogatja
 - Kompatibilis az AC'97 2.3-as verziójával, amely 6 csatornás AC'97 hangszóró kimenetet és V.90 HSP modemet támogat
 - Beépített USB 2.0 vezérlő, amely három alaphub-bal és nyolc funkcionális porttal rendelkezik

Memória

- DDR400/333/266 MHz-es DDR SDRAM memóriamodulokat támogat
- Két puffer nélküli 2,5 V-os DDR SDRAM DIMM modullal működik
- Maximum 1 GB-os DIMM egységeket támogat, maximális memória 2 GB

Grafika

- Beépített csúcsteljesítményű 256 bites 3D motor, akár 2,7 GB/s sávszélességű Ultra-AGP II™ támogatása
- Beépített csúcsmínőségű 3D motor, maximum 2048x2048-as mintázati méret támogatásával
- VCD, DVD és HDTV dekódolás támogatása

Audio

- Kompatibilis az AC'97 2.3-as CODEC változatával
- A számítógép multimédiás rendszereinek szánt hat csatornás audio CO-DEC-et támogat
- Három analóg sztereo bemenetet biztosít 5 bites hangerő vezérléssel: AUDIO BEMENET, CD, AUX
- Támogatja az S/PDIF kimeneti funkciót

Bővítési lehetőségek

Az alaplap a következő bővítési lehetőségekkel rendelkezik:

- Egy AGP 3.0 változattal kompatibilis 8-szoros/4-szeres sebességű foglalatot támogat (csak 1,5 V-os AGP interfészt támogat)
- Három 32 bites, a PCI 2.3-as verziójával kompatibilis foglalattal rendelkezik
- Két 40 tűs lapos IDE foglalat, amelyek maximum négy IDE egységet képesek kiszolgálni
- Egy hajlékonylemez meghajtó interfész
- Két 7 tűs SATA csatlakozó
- Egy CNR foglalat

Ez az alaplap a 133/100/66 MB/s átviteli sebességű Ultra DMA 'bus mastering' megoldást is támogatja.

Alaplapon levő LAN (választható)

Az alaplapon levő LAN jellemzői:

- 10Mb/s és 100Mb/s N-Way automatikus beállítással
- Teljes/fél duplex lehetőség
- Támogatja a Wake-On-LAN funkciót és a távoli ébresztést
- A kikapcsolási módot támogatja

Beépített I/O

Az alaplapot az I/O portok és csatlakozók teljes készletével szerelték fel:

- Két PS/2 port az egér és a billentyűzet számára
- Egy soros port
- Egy párhuzamos port
- Egy VGA port
- Négy USB port
- Egy LAN port (választható)
- Audio csatlakozók mikrofon, bemenet és kimenet számára

BIOS Firmware

Az alaplapon levő Award BIOS segítségével a felhasználó a rendszer sok paraméterét állíthatja be, például:

- Energiagazdálkodás
- Ébresztési riasztások
- CPU paraméterek
- CPU és memória időzítés

A firmware segítségével a processzor órajel-frekvenciáinak paramétereit is beállíthatják.



Bizonyos hardverjellemzők és szoftverelemek előzetes bejelentés nélkül módosulhatnak.