



SL-65MIV-C/65MIV2

USER MANUAL V1.2

NOTICE

Product Model	: SL-65MIV-C / 65MIV2
Manual Revision	: V1.2
Release Date	: May 2001

This Users' Guide & Technical Reference is to help system manufacturers and end-users set up and install the mainboard.

Every effort has been made to ensure that the information in this manual is accurate. Soltek Computer Inc. is not responsible for printing or clerical errors. Information in this document is subject to change without notice and does not represent a commitment on the part of Soltek Computer Inc.

No part of this manual may be reproduced, transmitted, translated into any language in any form or by any means, electronic or mechanical, including photocopying and recording, for any purpose without the express written permission of Soltek Computer Inc.

Companies and products mentioned in this manual are for identification purpose only. Product names appearing in this manual may or may not be registered trademarks or copyrights of their respective companies.

Soltek Computer inc. Provides this manual "As is" without warranty of any kind, either express or implied, including but not limited to the implied warranties or conditions of merchantability or fitness for a particular purpose. In no event shall Soltek Computer inc. be liable for any loss or profits, loss of business, loss of use or data, interruption of business, or for indirect, special, incidental, or consequential damages of any kind, even if Soltek Computer inc. has been advised of the possibility of such damages arising from any defect or error in this manual or product.

Copyright © 2001 Soltek Computer Inc. All Rights Reserved.

- Intel, Celeron, Pentium II, Pentium III are trademarks of Intel Corporation.
- VIA, PM133, APOLLO PRO 133, VT82C694X and VT82C686A are trademarks of VIA Corporation.
- S3 Savage4 is trademarks of S3 Corporation.

SOLTEK AROUND THE WORLD

SOLTEK COMPUTER INC.

Address : 7F, No. 306-3, Ta-Tung Rd, Sec.1, Hsi-Chih, Taipei-Hsien, Taiwan, R.O.C.
Telephone : 886-2-2642-9060
Fax : 886-2-2642-9065
E-mail : sales@soltek.com.tw
Web site : <http://www.soltek.com.tw>

SOUL TECHNOLOGY EUROPE B.V.

Address : Hongkongstraat 55 3047 BR, Rotterdam, The Netherlands
Telephone : 31-10-2457492
Fax : 31-10-2457493
E-mail : sales@soultech-europe.com
Web site : <http://www.soultech-europe.com>

CONTENT

CHAPTER 1	INTRODUCTION	8
1- 1	MAINBOARD SPECIFICATION	9
1-1-1	CPU	9
1-1-2	CHIPSET	9
1-1-3	AWARD BIOS V6.0, SUPPORTING	9
1-1-4	EXPANSION SLOTS	9
1-1-5	ADVANCED HIGH-PERFORMANCE DRAM CONTROLLER	9
1-1-6	MULTI-I/O FUNCTION	9
1-1-7	INTEGRATED SAVAGE4 2D/3D/VIDEO ACCELERATOR	10
1-1-8	SOUND CONTROLLER	10
1-1-9	FULL FEATURED ACCELERATED GRAPHICS PORT (AGP) CONTROLLER	10
1-1-10	POWER MANAGEMENT	10
1-1-11	FORM FACTOR	11
1-1-12	HARDWARE MONITORING	11
1-1-13	OTHERS	11
1-2	MAINBOARD LAYOUT	12
1-2-1	MAINBOARD LAYOUT --- 65MIV-C	12
1-2-2	MAINBOARD LAYOUT --- 65MIV2	13
1-3	CHIPSET DIAGRAM	14
1-4	HIGH SCREEN RESOLUTION CRT SUPPORT	15
1-5	MOTHERBOARD SPECIFICATION TABLE	16
CHAPTER 2	HARDWARE SETUP	18
2- 1	CPU INSTALLATION	19
2- 2	MEMORY INSTALLATION	20
2- 3	HDD/FDD INSTALLATION	21
2-4	CPU BUS RATIO SELECT	23
2-4-1	BUS FREQUENCY SELECT	23
2- 5	JUMPER SETTING FOR DEVICES ON BOARD:	24

2-5-1 JUMPER JBAT1 FOR CLEARING CMOS DATA: 24

2-5-2 JP4/JP5 USB PORT SELECT 25

2-5-3 JP9 POWER LOST RESUME 25

2-6 CONNECTORS CONFIGURATIONS 26

2-6-1 ONBOARD FAN (JFAN1/JFAN2) 26

2-6-2 CD-ROM AUDIO CONNECTOR (JCD1/JCD2) 27

2-6-3 WAKE ON LAN FUNCTION (WOL1) 27

2-6-4 THERMAL SENSOR CONNECTOR (RT2) – FOR 65MIV2 ONLY 28

2-6-5 HEADER J2&J3 29

2-6-6 CHASSIS PANEL CONNECTOR 33

2-6-7 ATX POWER SUPPLY CONNECTOR 34

2-6-8 PS/2 MOUSE AND PS/2 KEYBOARD 34

2-6-9 SECOND USB HEADER (USB2) 35

2-6-10 SERIAL PORT CONNECTOR 36

2-6-11 FLAT-PANEL DISPLAY CONNECTOR (DVC1) – FOR 65MIV2 ONLY .. 37

2-6-12 IRQS DESCRIPTION FOR VARIOUS DEVICES 38

CHAPTER 3 SOFTWARE SETUP 41

ABOUT SUPPORT CD 41

3-1 VIA CHIPSET DRIVER INSTALLATION (4-IN-1 DRIVER) 42

3-2 ON BOARD VGA DRIVER INSTALLATION 45

3-2-1 INSTALL PM133 VGA DRIVER FOR WINDOWS 95/98/98SE 45

3-2-2 INSTALL PM133 VGA DRIVER FOR WINDOWS NT4.0 45

3-2-3 INSTALL PM133 VGA DRIVER FOR WINDOWS ME 46

3-2-4 INSTALL PM133 VGA DRIVER FOR WINDOWS 2000 47

3-3 AC97 AUDIO CODEC DRIVER INSTALLATION 48

3-4 HARDWARE MONITOR DRIVER INSTALLATION 50

CHAPTER 4 BIOS SETUP 53

THE BIOS 53

4-1 WHAT IS BIOS SETUP 54

4-2 HOW TO RUN BIOS SETUP 54

4-3 WHAT IS CMOS 54

4-4 WHAT IS POST 54

4-5 BIOS UPGRADE 54

 4-5-1 BEFORE UPGRADING BIOS 55

 4-5-2 UPGRADE PROCESS 55

4-6 BIOS SETUP-- CMOS SETUP UTILITY 59

 4-6-1 STANDARD CMOS SETUP 60

 4-6-2 ADVANCED BIOS FEATURES 63

 4-6-3 ADVANCED CHIPSET FEATURES 68

 4-6-4 INTEGRATED PERIPHERALS 74

 4-6-5 POWER MANAGEMENT SETUP 78

 4-6-6 PNP / PCI CONFIGURATION 85

 4-6-7 SMARTDOC ANTI-BURN SHIELD 88

 4-6-8 FREQUENCY/VOLTAGE CONTROL 90

 4-6-9 LOAD OPTIMIZED DEFAULTS 93

 4-6-10 SET SUPERVISOR / USER PASSWORD 93

 4-6-11 SAVE & EXIT SETUP 94

 4-6-12 EXIT WITHOUT SAVING 94

APPENDICES 95

APPENDIX-1 TECHNICAL TERMS INTRODUCTION 96

APPENDIX-2 IDENTIFYING BIOS VERSION AND BIOS PART
 NUMBER 97

APPENDIX-3 IDENTIFYING MAINBOARD \ MODEL NUMBER 99

ITEMLIST CHECKUP

- Mainboard
- Support CD
- User's Manual
- Bundled Bonus Pack CD
- Bundled Bonus Pack Manual
- Temperature Sensor Cable
(for 65MIV2 only)
- ATA66/100 IDE Cable
- RS232 Cable
- FDD Cable

CHAPTER 1

INTRODUCTION

- This chapter briefly introduces the characteristics of this mainboard. It includes the information regarding the chipset, CPU types, built-in functions and layout. Users will have more ideas about mainboards after reading this chapter.

THIS CHAPTER CONTAINS THE FOLLOWING TOPICS :

- 1-1 MAINBOARD SPECIFICATION**
- 1-2 MAINBOARD LAYOUT**
- 1-3 CHIPSET DIAGRAM**
- 1-4 HIGH SCREEN RESOLUTION CRT SUPPORT**
- 1-5 MOTHERBOARD SPECIFICATION TABLE**

1- 1 MAINBOARD SPECIFICATION

1-1-1 CPU

- Supporting Intel® FC-PGA370 Pentium® III up to 1GHz.
- Supporting Celeron™ & PPGA370 Celeron processors up to 850MHz.
- Supporting VIA Cyrix III processors up to 800MHz.
- Supporting 66 to 200 MHz system bus speed.
- Supporting processor voltage Auto-Detect circuit.

1-1-2 CHIPSET

- North Bridge - VIA 8605 PM133.
- South Bridge - VIA VT82C686A (65MIV-C).
VIA VT82C686B (65MIV2).

1-1-3 AWARD BIOS V6.0, SUPPORTING

- Plug & Play V1.0.
- Flash Memory for easy upgrade.
- Year 2000 compliant.
- BIOS writing protection.
- SMARTDOC ANTI-BURN SHIELD.
- RedStorm Overclocking Tech.

1-1-4 EXPANSION SLOTS

- Three PCI bus Mater slots.
- One AGP 4x mode slot.
- Three DIMM slots.
- One DVC1 slot. (for 65MIV2 only)

1-1-5 ADVANCED HIGH-PERFORMANCE DRAM

CONTROLLER

- Supporting PC133 and PC100 SDRAM and Virtual Channel Memory (VCM) SDRAM up to 3 DIMMs.
- 64-bit data width and 3.3V DRAM interface.
- Supporting up to 1.5 GB memory space.
- Supporting different DRAM types used in mixed combinations.
- PCI-2.2 compliant, 32 bit 3.3V PCI interface with 5V tolerant inputs .

1-1-6 MULTI-I/O FUNCTION

- Two Ultra DMA 33 / 66 Master Mode PCI EIDE ports. (for 65MIV-C only)
- Two Ultra DMA 33 / 66/100 Master Mode PCI EIDE ports. (for 65MIV2 only)

- Two UART's for Complete Serial Ports.
- One dedicated IR connector:
 - A third serial port dedicated to IR function either through the two complete serial ports or the third dedicated port Infrared-IrDA (HPSIR) and ASK (Amplitude Shift Keyed) IR.
- Multi-mode parallel connector supporting:
 - Standard mode, ECP and EPP support.
- Floppy Disk connector supporting:
 - Two FDDs with drive swap function.
- Universal Serial Bus connector supporting:
 - USB v1.1 and Intel Universal HCI v1.1 compatible.
 - 2 built-in USB connectors, in addition to one internal USB header which requires a USB cable to support 2 more optional USB ports.
- PS/2 Keyboard connector.
- PS/2 Mouse connector.

1-1-7 INTEGRATED SAVAGE4 2D/3D/VIDEO ACCELERATOR

- Optimized Share Memory Architecture (SMA).
- 2 to 32MB frame buffer using system memory.
- Single cycle 128-bit 3D architecture.
- Full AGP 4x, including sideband addressing and execute mode.
- Floating point triangle setup engine.
- 8M triangles/second setup engine.
- 140M pixels/second trilinear fill rate.
- 2D/3D resolutions up to 1920x1440.

1-1-8 SOUND CONTROLLER

- SoundBlaster Pro Hardware and Direct Sound Ready AC'97 Digital Audio Controller with Codec Onboard.

1-1-9 FULL FEATURED ACCELERATED GRAPHICS PORT (AGP) CONTROLLER

- Synchronous and pseudo-synchronous with the host CPU bus with optimal skew control PCI AGP CPU Mode 33/66/100 MHz DDR 3x synchronous.
- Support 66MHz 1x/2x/4x modes for AD and SBA signaling.
- AGP v2.0 compliant.

1-1-10 POWER MANAGEMENT

- ACPI 1.0 compliant (Advanced Configuration and Power Interface).
- APM V1.2 compliant (Legacy power management).

- Supporting Wake On LAN (WOL) & Wake On Modem.
- Supporting real time clock (RTC) with date alarm, month alarm, and century field.

1-1-11 FORM FACTOR

- ATX form factor, 4 layer PCB.
- Mainboard size: 22.0cm X24.5cm.

1-1-12 HARDWARE MONITORING

- Programmable control, status, to provide monitoring and alarm for flexible desktop management of hardware temperature. (software included in support CD)
- 5 positive voltage statuses monitoring.
- 2 fan speeds statuses monitoring.
- 2 temperature statuses monitoring. (for 65MIV2 only)

1-1-13 OTHERS

- Clock generator supporting 1 MHz linear clock setting.

1-2 MAINBOARD LAYOUT

1-2-1 MAINBOARD LAYOUT --- 65MIV-C

- Default Setting: Intel Celeron 300A/66 MHz

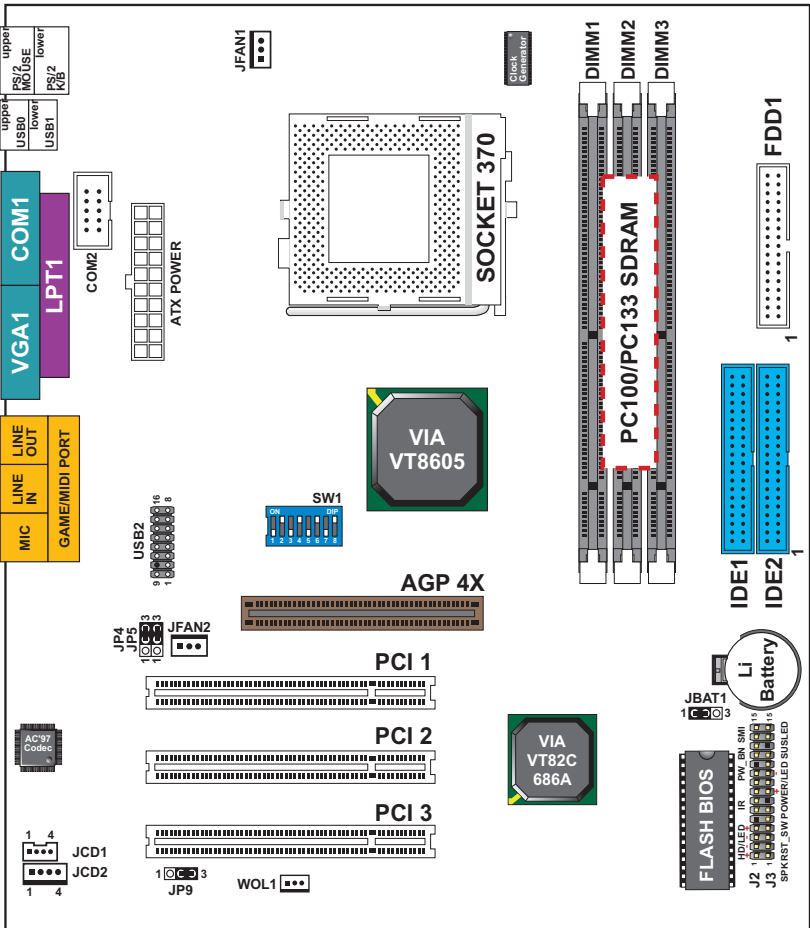

1-3 CHIPSET DIAGRAM

- The VT8605 is a high performance, cost-effective and energy efficient SMA chip set for the implementation of AGP / PCI / LPC desktop personal computer system with 66MHz, 100MHz, and 133MHz CPU host bus (“Front Side Bus”) frequencies and based on 64-bit Socket-370 (Intel Pentium III, Celeron) super-scalar processors. VT8605 is the VIA part number.

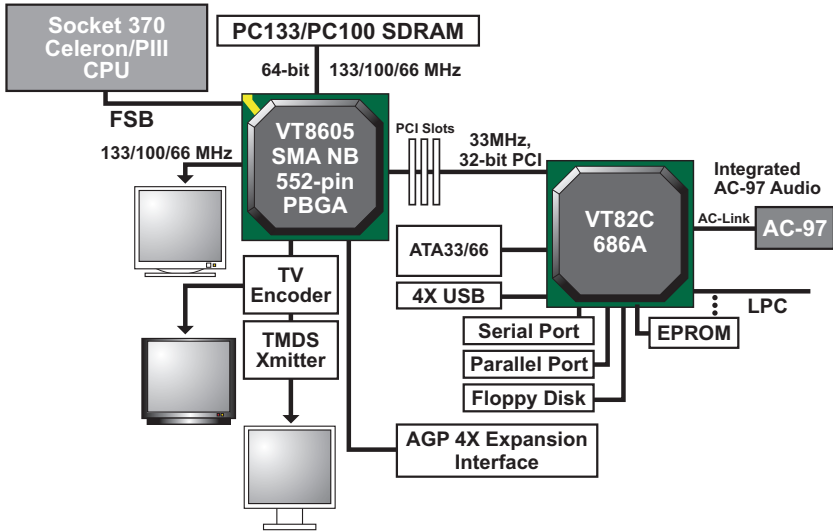

**VT8605 System Block Diagram with VT82C686A
PCI-TO-ISA South Bridge**

1-4 HIGH SCREEN RESOLUTION CRT SUPPORT

Resolution Supported	System Memory Frame Buffer Size (8MB Default)		
	4MB	8MB	16/32MB
640x480x8 /16/ 32	4MB	8MB	16/32MB
800x600x8 /16/ 32	✓	✓	✓
1024x768x8 /16/ 32	✓	✓	✓
1280x1024x8	✓	✓	✓
1280x1024x16	✓	✓	✓
1280x1024x32		✓	✓
1600x1200x8	✓	✓	✓
1600x1200x16	✓	✓	✓
1600x1200x32		✓	✓
1920x1440x8	✓	✓	✓
1920x1440x16		✓	✓

High Screen Resolution CRT Support

1-5 MOTHERBOARD SPECIFICATION TABLE

Model	65MIV-C	65MIV2
North bridge	VIA VT8605	
South bridge	VIA VT82C686A	VIA VT82C686B
Memory	Supports PC133 and PC100 SDRAM and Virtual Channel Memory (VCM) up to 1.5GB 3 DIMM Slots	
AGP Interface	AGP 4X Mode	
On-chip Graphics	S3 SAVAGE 4 AGP 4X	
Audio	Build-in AC97 codec	
IDE	2 x Ultra ATA33/66 IDE ports	2 x Ultra ATA33/66/100 IDE ports
I/O	4 x USB ports, 1 x FDD port, 2 x COM ports, 1 x LPT port, 1 x IrDA, 1 PS/2 Mouse, 1 PS/2 K/B	
PCI slot	3 x PCI Master Slots	
VD-Tech	Optional	
Temperature Monitoring	None	Yes
BIOS writing Protection	Yes	
FLAT-PANEL Display Connector	None	Yes

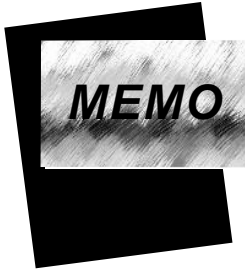

CHAPTER 2 _____

HARDWARE SETUP

ATTENTION !!!

1. Please refer to your processor installation or other documentation attached with your CPU for more detailed installing instruction.
2. Installing a heat sink and cooling fan is necessary for proper heat dissipation from your CPU. Incorrect installation may result in overheating and damage of your CPU.
3. Before changing the setting of CPU Vcore from BIOS program, user SHOULD make sure of correct specification both of CPU CLOCK and RATIO. Incorrect setting may cause damage to your CPU.

THIS CHAPTER CONTAINS THE FOLLOWING TOPICS :

- 2-1 CPU INSTALLATION**
- 2-2 MEMORY INSTALLATION**
- 2-3 HDD/FDD INSTALLATION**
- 2-4 FOR CPU FREQUENCY AND VOLTAGE**
- 2-5 FOR DEVICE ON BOARD**
- 2-6 CONNECTORS CONFIGURATION**

2- 1 CPU INSTALLATION

WARNING !!!

*Never run you processor without the heat sink properly and firmly attached.
PERMANENT DAMAGE WILL RESULT!*

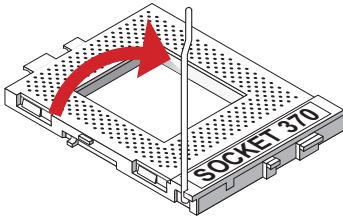

1

- Pull out the lever from the socket, and then raise the lever up to a 90-degree angle.

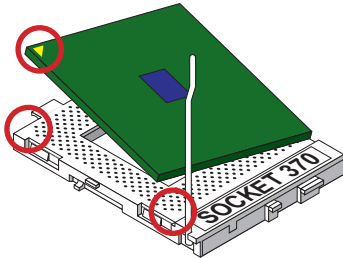

2

- Take notice of the red circles as shown below. While inserting the CPU into the socket, you can find out there is a definite pin orientation for CPU and socket.

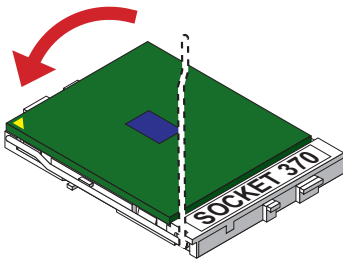

3

- Make sure that the CPU is placed into the socket tightly. Then lower down the lever to complete the CPU installation.

2- 2 MEMORY INSTALLATION

WARNING !!!

- Make sure that you unplug your power supply when adding or removing memory modules or other system components, failure to do so may cause severe damage to both your mainboard and expansion cards.
- Be careful when inserting or removing DIMM, forcing a DIMM in or out of a socket can be damaged the memory module or the socket. Some of DIMMs contain EDO or FTP DRAM that accept only 5V power. These DIMM types are incompatible with the mainboard, the M/B only supports 3.3V true SDRAM DIMMs.

Installing DIMM

- Make sure you have the correct memory module type for your mainboard.
- Insert the module(s) as shown below, DIMMs have 168-pins and two notches that will be matched by the onboard DIMM socket. Memory modules are installed by inserting them straight into the slot until they “click” in the right place. They only fit in one direction, so do not force them in by a wrong direction.

168-Pin DIMM Notch Key Definitions(3.3V)

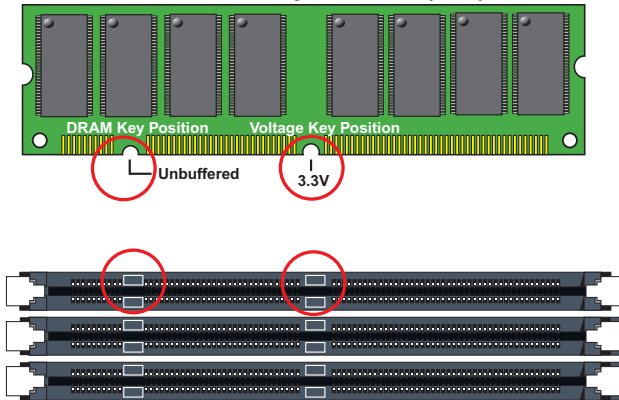

Removing DIMM

- Press down the holding clips on both sides of a DIMM socket and the module will be released from it.

2- 3 HDD/FDD INSTALLATION

- To install HDD (Hard Disk Drive), you may connect the cable's blue connector to the mainboard's primary (IDE1) or secondary IDE connector, and then connect the gray connector to your slave device and the black connector to your master device. If you install two hard disks , you must configure the second drive to Slave mode by setting its jumper accordingly. Please refer to your hard disk documentation for the jumper settings.

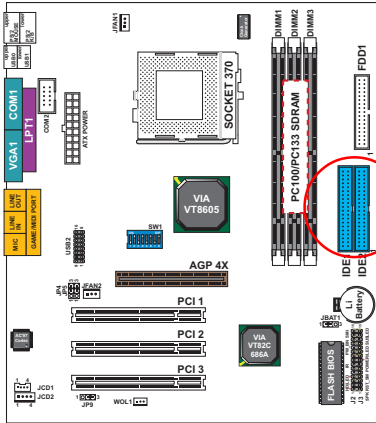

Hard Disk Drive Connector:
Orient the red line on the IDE ribbon cable to Pin1.

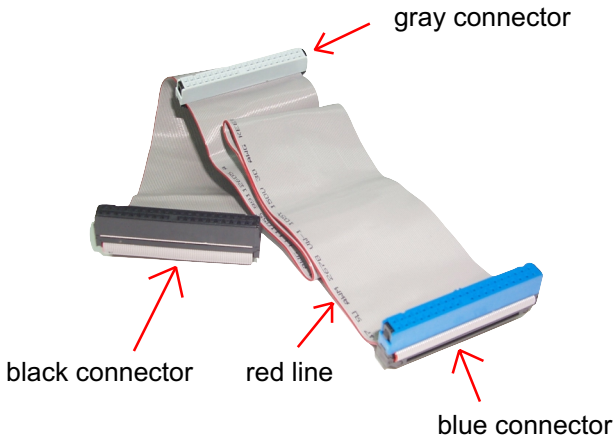

IDE Cable

65MIV-C / 65MIV2

- To install FDD (Floppy Disk Drive), connect the end with single connector to the mainboard, and connect other end with two connectors to the floppy drives.

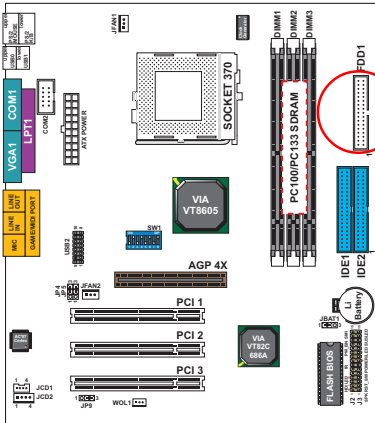

Floppy Disk Drive Connector:
Orient the red line on the floppy ribbon cable to Pin1.

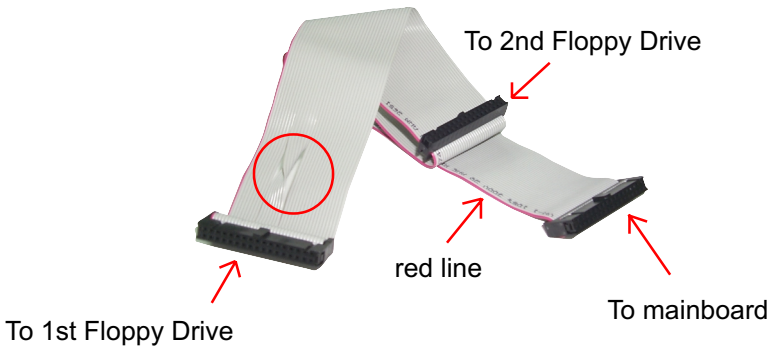

FDD Cable

2- 5 JUMPER SETTING FOR DEVICES ON BOARD:

- The following diagrams show the location for jumper blocks on the mainboard.

CAUTION

- *Do not remove the jumper when power is on. Always make sure the power is off before changing any jumpers. Otherwise, mainboard could be damaged.*
- *All jumper pins with block marks are closed pins.*

2-5-1 JUMPER JBAT1 FOR CLEARING CMOS DATA:

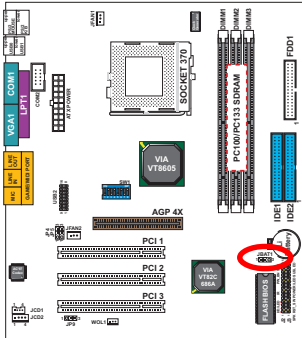





Clear CMOS Data	JBAT1  1 3
Retain Data (default)	JBAT1  1 3

A battery should be used to supply the power for the CMOS RAM to retain mainboard configuration.

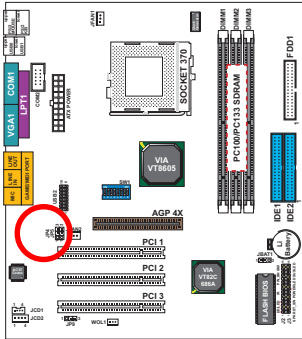
NOTE : *You can clear CMOS by setting pin 2-3 closed when the system is POWER OFF. Then, return to pin 1-2 closed position (default). You may damage the mainboard if clearing the CMOS with POWER ON. Unplugging the power cord from power supply before clearing CMOS will be the safest bet for user.*



2-5-2 JP4/JP5 USB PORT SELECT

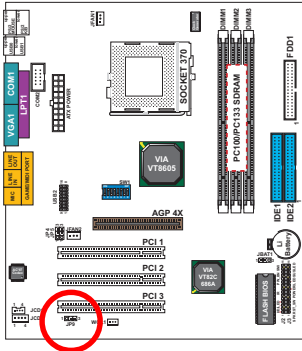

Redirect USB port 2 to USB 2 connector (default)	JP4 ³  ³ JP5 ₁  ₁
Redirect USB port 2 to AGP	JP4 ³  ³ JP5 ₁  ₁

2-5-3 JP9 POWER LOST RESUME



Normal (default)	JP9 1  3
Enabled	JP9 1  3



This jumper allows user to use the switch of ATX power supply to control ON/OFF directly instead of using the power switch on the mainboard.

2-6 CONNECTORS CONFIGURATIONS

- This section lists out all connectors configurations for users' reference:

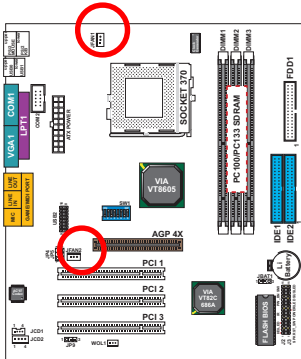
2-6-1 ONBOARD FAN (JFAN1/JFAN2)



CPU FAN	JFAN1	
SYSTEM FAN	JFAN2	

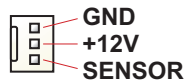

These connectors support CPU/System cooling fan with +12V. When connecting wire to FAN connectors, users should pay attention that the red wire is for the positive current and should be connected to pin +12V, and the black wire is Ground and should be connected to pin GND. If your mainboard has Hardware Monitor chipset on-board, you must use a specially designed fan with speed sensor to take advantage of this function.

For fans with speed sensors, the rotation of the fan blades will send out 2 electric pulses, by which system Hardware Monitor will work out the fan rotation speed.

NOTE 1 : Always consult vendor for proper CPU cooling fan.

NOTE 2 : CPU FAN supports the FAN control. You can install PC Alert utility. This will automatically control the CPU FAN speed according to the actual CPU temperature.

2-6-2 CD-ROM AUDIO CONNECTOR (JCD1/JCD2)

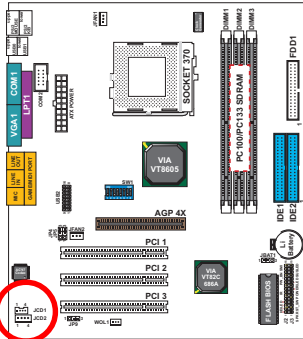

PIN NO.	JCD1	JCD2
PIN 1	Left Channel	Left Channel
PIN 2	GND	GND
PIN 3	GND	Right Channel
PIN 4	Right Channel	GND

2-6-3 WAKE ON LAN FUNCTION (WOL1)

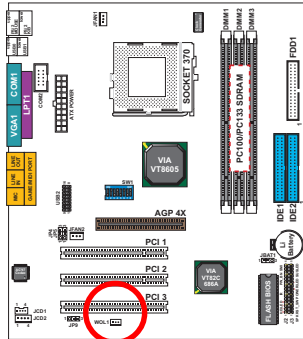

Connect the Wake On LAN[□] signal from LAN card[□] to WOL1



This connector connects to a LAN card with a Wake On LAN output. The connector powers up the system when a wake-up packet or signal is received through the LAN card.

This feature requires that Wake On LAN feature is enabled in the BIOS setting called "Power Management Setup" and that your system must have an ATX power supply with at least 720mA / +5V standby power.

2-6-4 THERMAL SENSOR CONNECTOR (RT2) --- FOR 65MIV2 ONLY

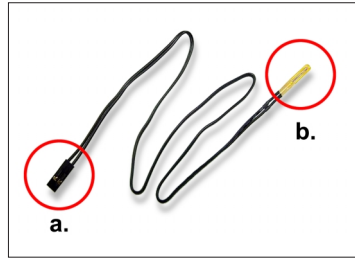
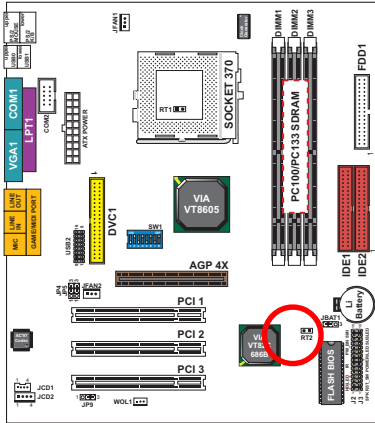

We provide a thermal cable in the mainboard package. This thermal cable is to monitor device which will generate a lot of heat, such as HDD, graphics card etc.. Please connect one end of the thermal cable (A) to mainboard RT2 header, and tape the other end of thermal cable (B) on to the device which you want to monitor. After you finish the thermal cable installation, you will see the detected temperature in BIOS setup or Hardware monitor utility.

2-6-5 HEADER J2&J3

- Header J2&J3 includes seven connectors for different functions:

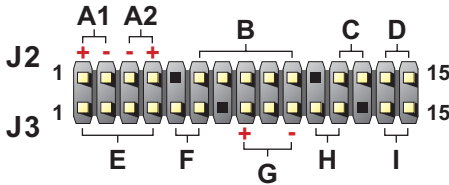

- A1 : 1st HDD LED
- A2 : 2nd HDD LED
- B : INFRARED (IR)
- C : POWER SWITCH
- D : SMI
- E : SPEAKER
- F : RESET SWITCH
- G : POWER LED
- H : NONE
- I : SUSPEND LED

1.

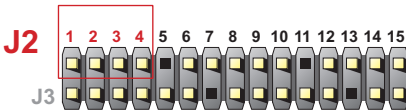

HDD LED CONNECTOR	
PIN 1	Logic High (+)
PIN 2	HDD LED SIGNAL
PIN 3	HDD LED SIGNAL
PIN 4	Logic High (+)
DESCRIPTION	This connector supplies power to the cabinet's IDE activity LED. Read and write activity by devices connected to the Primary or Secondary IDE connector will cause the LED to light up.

2.

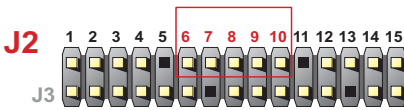

INFRARED CONNECTOR	
PIN 6	INFRARED TRANSMIT SIGNAL
PIN 7	GND
PIN 8	INFRARED RECEIVE SIGNAL
PIN 9	NONE
PIN 10	Vcc
DESCRIPTION	<p>This connector supports an optional wireless transmitting and receiving infrared module. This module mounts to a small opening on system cases that support this feature.</p> <p>User must also configure the setting through BIOS program "Peripheral Setup" to select whether UART2 is directed for use with COM2 or IrDA.</p> <p>Use the five pins and connect a ribbon cable from the module to the motherboard's IR connector according to the pin definitions.</p>

3.



ATX POWER SWITCH	
PIN 12	ATX POWER SWITCH
PIN 13	GND
DESCRIPTION	<p>The system power is controlled by a momentary switch connected to this lead.</p> <p>Pressing the button once will switch the system between ON and SOFT OFF.</p> <p>Pushing the switch while in the ON mode for more 4 seconds will turn the system off.</p> <p>The system power LED shows the status of the system's power.</p>

4.



SMI CONNECTOR	
PIN 14	SMI(System Management Interrupt) SIGNAL
PIN 15	GND
DESCRIPTION	<p>This allows user to manually place the system into a suspend mode or "Green" mode, where system activity is decreased to save electricity and prolong the life of certain components when the system is not in use. This 2-pin connector connects to the case-mounted suspend switch. If you do not have a switch for the connector, you may use the "Turbo Switch".</p> <p>SMI is activated when it detects a short to open moment and therefore leaving it shorted will not cause any problems. This may require one or two presses depending on the position of the switch. Wake-Up can be controlled by settings in the BIOS but the keyboard will always allow wake-up(the SMI lead cannot wake up the system).</p>

5.

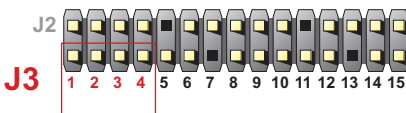

SPEAKER CONNECTOR	
PIN 1	SPEAKER SIGNAL
PIN 2	NONE
PIN 3	GND
PIN 4	Vcc
DESCRIPTION	<p>This SPEAKER connector connects to the case-mounted speaker. Two sources (LINE OUT and SPEAKER) allow you to hear system beeps and warnings. Only SPEAKER allows you to hear system beeps before the integrated audio has been properly initialized.</p>

6.

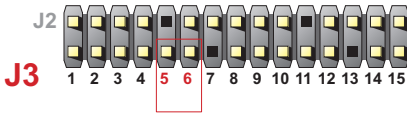

RESET SWITCH CONNECTOR	
PIN 5	RESET SIGNAL
PIN 6	GND
DESCRIPTION	RESET SWITCH connector connects to the case-mounted reset switch for rebooting your system without having to turn off your power switch. This is a preferred method of reboot to prolong the life of the system's power supply.

7.

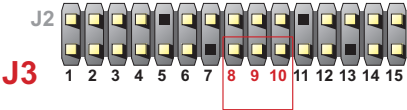

POWER LED CONNECTOR	
PIN 8	Vcc
PIN 9	NONE
PIN 10	GND
DESCRIPTION	This Power LED connector connects the system power LED, which lights when the system is powered on and blinks when it is in sleep mode.

8.



SUSPEND LED	
PIN 14	SUSPEND LED SIGNAL
PIN 15	GND
DESCRIPTION	Connect to Suspend indicator light.

2-6-6 CHASSIS PANEL CONNECTOR

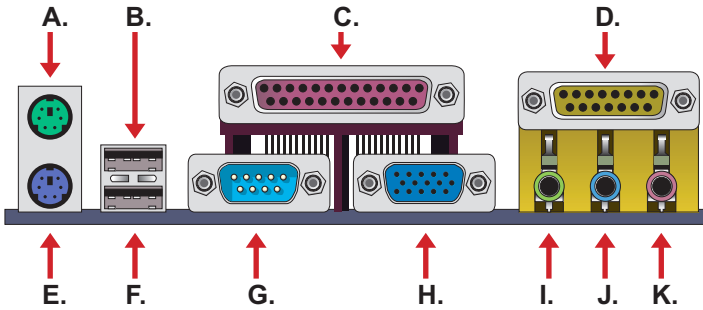

- A : PS/2 MOUSE PORT
- B : USB 0 PORT
- C : LPT1 PORT
- D : GAME/MIDI PORT
- E : PS/2 KEYBOARD PORT
- F : USB 1 PORT
- G : COM1 PORT
- H : VGA PORT
- I : LINE / SPEAKER OUT
- J : LINE IN
- K : MICROPHONE INPUT

2-6-7 ATX POWER SUPPLY CONNECTOR

- This connector is connected to an ATX power supply by a plug from the power supply. The plug can only be inserted in a specific orientation because of the different hole sizes. Find the proper orientation and push down the plug firmly to make sure that all pins are aligned.
- Your power supply should support at least 10mA on the 5V standby voltage. There may be difficulty to turn on the system power if the power supply does not support the load.
- **For Wake On LAN function, the power supply should support at least 720mA current.**

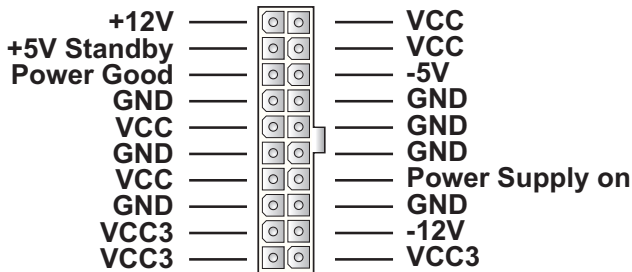

2-6-8 PS/2 MOUSE AND PS/2 KEYBOARD

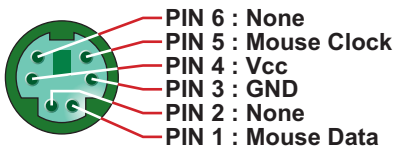

PS/2 MOUSE

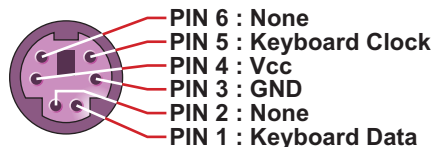

PS/2 KEYBOARD

2-6-9 SECOND USB HEADER (USB2)

- This header is for the additional USB cable to provide you two additional USB ports. Users can order the additional USB cable from your mainboard dealers or venders.

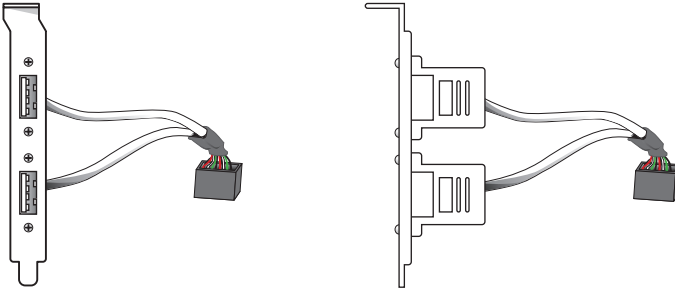

Additional USB Cable (Optional)

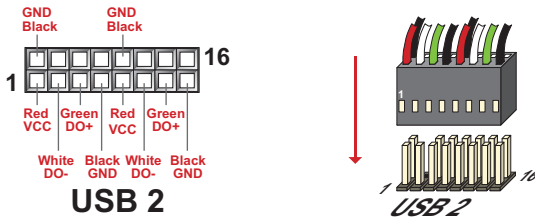

USB2 HEADER

- When plugging the USB cable to USB2 header, users must make sure the red wire is connected to the first pin.

2-6-10 SERIAL PORT CONNECTOR

- The first serial port COM1 is ready for a mouse or other serial devices. The second serial port COM2 is available by using a RS232 serial cable connecting from the mainboard to an expansion slot opening.

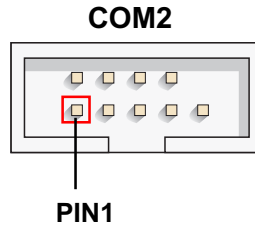
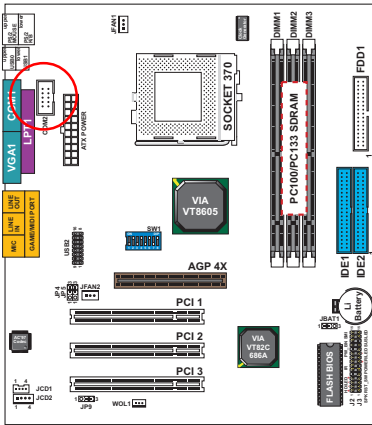

Serial Port Connector:
Orient the red line on the serial ribbon cable to PIN1.

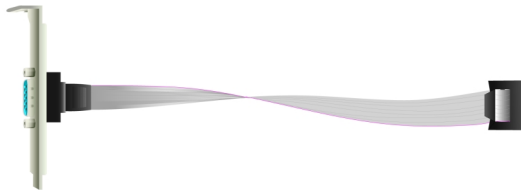

RS232 SERIAL CABLE

2-6-11 FLAT-PANEL DISPLAY CONNECTOR (DVC1) --- FOR 65MIV2 ONLY

- This motherboard provides a special socket “**DVC1**”. Which has the capability of displaying graphics on TFT flat panel desktop monitors using a 12-bit digital interface to an external encoder. The motherboard also supports auto expansion and centering of all VGA text and graphics modes to ensure that the entire flat panel display will be utilized. All resolutions are supports up to 1280x1024. The solution is Digital Visual Interface 1.0 specification compliant.

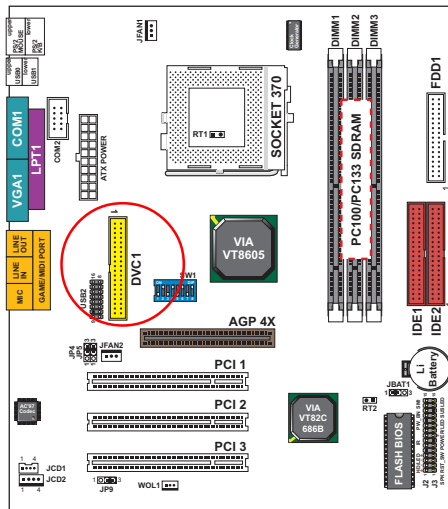

2-6-12 IRQs DESCRIPTION FOR VARIOUS DEVICES

IRQ	Function Description	Priority
IRQ 0	System Timer	1
IRQ 1	Keyboard Controller	2
IRQ 2	Programmable Interrupt	N/A
IRQ 3	Serial Port (COM 2)	11
IRQ 4	Serial Port (COM 1)	12
IRQ 5		13
IRQ 6	Floppy Disk Controller	14
IRQ 7	Parallel Port (LPT1)	15
IRQ 8	Real Time Clock (RTC)	3
IRQ 9		4
IRQ 10		5
IRQ 11		6
IRQ 12	PS/2 Mouse Port	7
IRQ 13	Coprocessor	8
IRQ 14	Primary IDE Channel	9
IRQ 15	Secondary IDE Channel	10

- Both ISA and PCI expansion cards require IRQs. System IRQs are available to cards installed in the ISA expansion bus first and then any remaining IRQs are available to PCI cards. Currently, there are two types of ISA cards.
- The original ISA expansion card design, now referred to as “Legacy” ISA card, requires you to configure the card’s jumpers manually and then install it in any available slot on the ISA bus. To see a map of your used and free IRQs in Windows 98, please click the *My Computer* → *Control Panel* → *system*, in which you can see the *Device Manager* tab. Double click on a specific hardware device to display the *Resources* tab which shows the Interrupt number and address. Double-Clicking the first option *Computers* of the *Device Manager* screen to see all the interrupts and addresses for your system. Make sure that ISA devices should not share IRQ with other devices; otherwise your computer will get into trouble when those two devices are used at the same time.

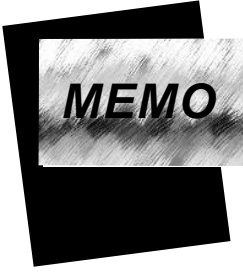

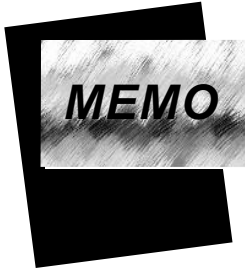

CHAPTER 3

SOFTWARE SETUP

ABOUT SUPPORT CD

- In Support CD, it contains most information for users' requirement, such as Acrobat Reader, BIOS, Users' full version Manual, Driver, Hardware Monitor (if motherboard supports this function), Patch, and Utilities etc., User can browse the CD and get further details in regard of our motherboard. Of course, welcome to vendor's website for latest release.

THIS CHAPTER CONTAINS THE FOLLOWING TOPICS :

- 3-1 VIA 4-IN-1 DRIVER INSTALLATION
- 3-2 ONBOARD VGA DRIVER INSTALLATION
- 3-3 AC'97 AUDIO CODEC INSTALLATION
- 3-4 HARDWARE MONITOR INSTALLATION

3-1 VIA CHIPSET DRIVER INSTALLATION (4-IN-1 DRIVER)

1

- Please put the Support CD into the CD-ROM drive.
- When a welcome window appears on the screen, choose **“Install Driver”**.

2

- Click on the **“VIA Chipset Driver”**.

3

- Click on the **“4-in-1 driver”**.

4

- Click on the **“Install via 4-in-1 driver”** to continue.

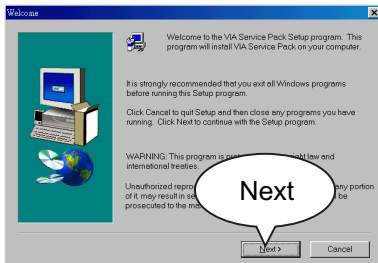

5

- When the welcome screen appears, press **Next** button to continue.

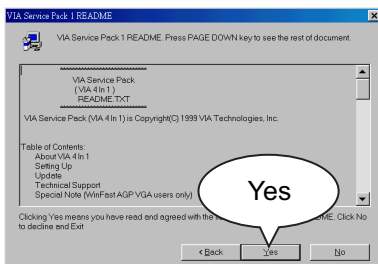

6

- **“VIA Service Pack README”** screen will appear, please click the **“Yes”** button to continue.

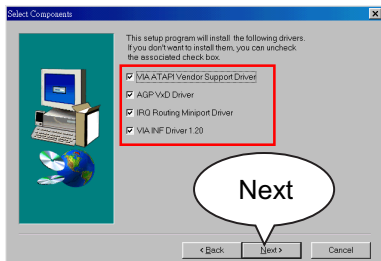

7 • Press select the checkbox as below:

- Bus Master PCI IDE Driver
- AGP VxD Driver
- VIA Chipset Function's Registry
- IRQ Routing Miniport Driver

Note: For users who are upgrading VIA Drivers, we recommend to install the 4-in-1 as it will automatically detect and update the necessary drivers.

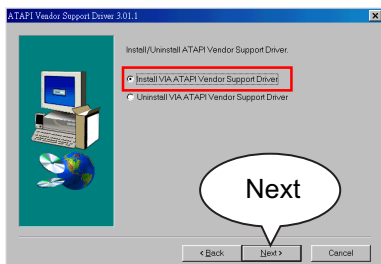

8 • Select “Install VIA ATAPI Vendor Support Driver” checkbox, then click the “Next” button to continue.

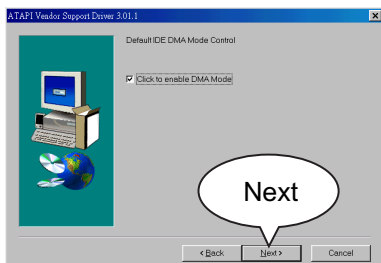

9 • Click on “Click to enable DMA Mode” checkbox to enable DMA function, then click the “Next” button to continue.

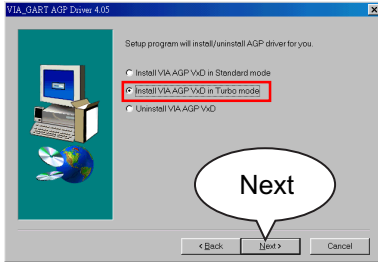

- 10**
- Select “Install VIA AGP VxD” in turbo mode and press **Next** button to continue.

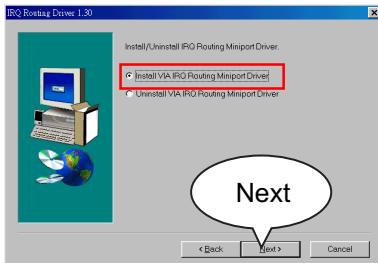

- 11**
- Select “Install VIA IRQ Routing Miniport Driver” checkbox, then click the “Next” button to continue.

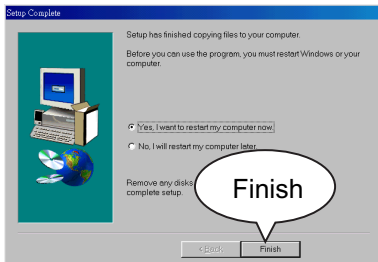

- 12**
- After all these setup procedures have finished, please restart your computer by clicking on **Finish**.

3-2 ON BOARD VGA DRIVER INSTALLATION

- We provide a simple process for user to install VGA driver. Whichever Microsoft Windows operating system user adopts, the installations are similar to each other as shown below.

3-2-1 INSTALL PM133 VGA DRIVER FOR WINDOWS 95/98/98SE

- 1** • Please put the Support CD into the CD-ROM drive.
 - When a welcome window appears on the screen, choose **“Install Driver”**.
 - 2** • Click on the **“VIA chipsets Driver”**.
 - 3** • Click on the **“VIA PM133 VGA Driver”** to continue.
 - 4** • Click on the **“Install VGA Driver for Win95/98/98SE”**.
 - 5** • Follow the instruction on screen to complete the installation, after which please restart your PC.
-

3-2-2 INSTALL PM133 VGA DRIVER FOR WINDOWS NT4.0

- 1** • Please put the Support CD into the CD-ROM drive.
 - When a welcome window appears on the screen, choose **“Install Driver”**.
- 2** • Click on the **“VIA chipsets Driver”**.

- 3** • Click on the “**VIA PM133 VGA Driver**” to continue.
 - 4** • Click on the “**Install VGA Driver for NT4.0**”.
 - 5** • Follow the instruction on screen to complete the installation, after which please restart your PC.
-

3-2-3 INSTALL PM133 VGA DRIVER FOR WINDOWS ME

- 1** • Please put the Support CD into the CD-ROM drive.
 - When a welcome window appears on the screen, choose “**Install Driver**”.
 - 2** • Click on the “**VIA chipsets Driver**”.
 - 3** • Click on the “**VIA PM133 VGA Driver**” to continue.
 - 4** • Click on the “**Install VGA Driver for Windows ME**”.
 - 5** • Follow the instruction on screen to complete the installation, after which please restart your PC.
-

3-2-4 INSTALL PM133 VGA DRIVER FOR WINDOWS 2000

1

- Please put the Support CD into the CD-ROM drive.
- When a welcome window appears on the screen, choose **“Install Driver”**.

2

- Click on the **“VIA chipsets Driver”**.

3

- Click on the **“VIA PM133 VGA Driver”** to continue.

4

- Click on the **“Install VGA Driver for Win2000”**.

5

- Follow the instruction on screen to complete the installation, after which please restart your PC.

3-3 AC97 AUDIO CODEC DRIVER INSTALLATION

- 1 • Please put the Support CD into the CD-ROM drive.
- When a welcome window appears on the screen, choose “**Install Driver**”.

- 2 • Click on the “**VIA chipsets Driver**”.

- 3 • Click on the “**AC'97 driver**”.

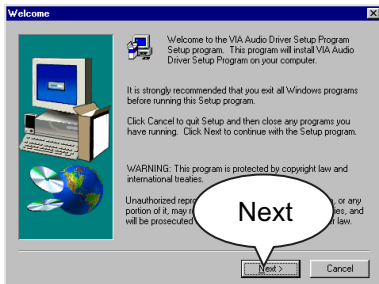

- 4 • When “**Welcome to VIA Audio Driver Setup Program**” appears, please click on the **Next** button to continue.

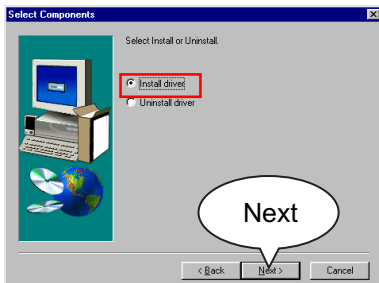

- 5 • When asking you install or remove the audio driver, please select “**Install**” and press **Next** button to continue.

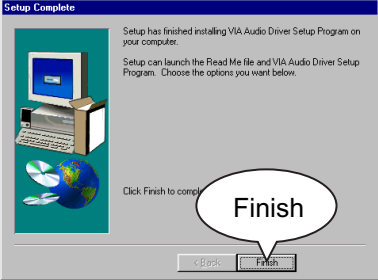

6

- Please click the “Finish” button to complete setup.

3-4 HARDWARE MONITOR DRIVER INSTALLATION

- 1 • Please put the Support CD into the CD-ROM drive.
 - When a welcome window appears on the screen, choose “**Install Driver**”.
- 2 • Click on the “**VIA chipsets Driver**”.
- 3 • Click on the “**Hardware Monitor Utility**”.

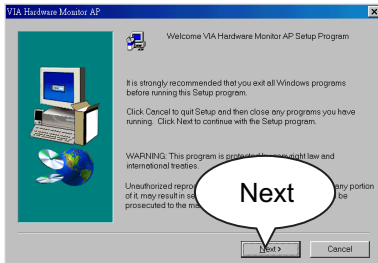

- 4 • When “Welcome VIA Hardware Monitor AP Setup Program” screen appears, please click on the **Next** button to continue.

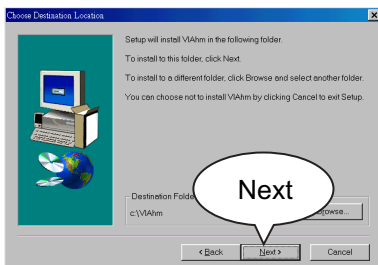

- 5 • The default destination is **C:\VIAhm**, then press **Next** button to continue.

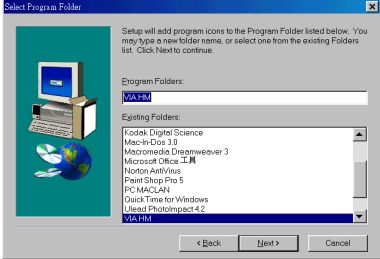

6

- Press **Next** button to finish the Hardware Monitor setup process.

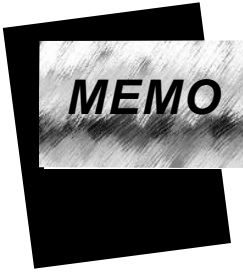

CHAPTER 4

BIOS SETUP

THE BIOS

- BIOS stands for Basic Input and Output System. It is sometimes called ROM BIOS because it is stored in a Read-Only Memory (ROM) chip on the mainboard. BIOS is the first program to run when you turn on your computer.
- BIOS performs the following functions:
 1. Initializing and testing hardware in your computer (a process called “POST”, for Power On Self Test).
 2. Loading and running your operating system.
 3. Helping your operating system and application programs to manage your PC hardware by means of a set of routines called BIOS Run-Time Service.

THIS CHAPTER CONTAINS THE FOLLOWING TOPICS :

- 4-1 WHAT IS BIOS SETUP
- 4-2 HOW TO RUN BIOS SETUP
- 4-3 WHAT IS CMOS
- 4-4 WHAT IS POST
- 4-5 BIOS UPGRADE
- 4-6 BIOS SETUP

4-1 WHAT IS BIOS SETUP

- BIOS Setup is an interactive BIOS program that you need to run when:
 1. Changing the hardware of your system. (for example: installing a new Hard Disk etc..)
 2. Modifying the behavior of your computer. (for example: changing the system time or date, or turning special features on or off etc..)
 3. Enhancing your computer's behavior. (for example: speeding up performance by turning on shadowing or cache)

4-2 HOW TO RUN BIOS SETUP

- To access BIOS setup menu, press < DEL > key after "POST", and before the OS is loaded. The BIOS usually display the following message:

Press DEL to enter SETUP

4-3 WHAT IS CMOS

- CMOS is the memory maintained by a battery. The BIOS uses CMOS to store the settings you have selected in SETUP. The CMOS also maintains the internal clock. Every time you turn on your computer, the BIOS Looks into CMOS for the settings you have selected and configures your computer accordingly. If the battery is out of power, the CMOS data will be lost and POST will issue a "CMOS invalid" or "CMOS checksum invalid" message. If this happens, you have to replace the battery and do some proper settings in SETUP.

4-4 WHAT IS POST

- POST is an acronym for Power On Self Test. POST will that all things the BIOS does before the operating system is started. Each of POST routines is assigned a POST code, a unique number which is sent to I/O port 080h before the routine is executed.

4-5 BIOS UPGRADE

- System BIOS is incorporated into a Flash memory component of the mainboard. Flash BIOS allows user to upgrade BIOS without the need to

replace an EPROM component.

- The upgrade utility can be loaded on a floppy diskette and used to provide the capability to save, verify, and update the system BIOS. The upgrade utility can also be run from a hard disk drive or a network drive.

4-5-1 BEFORE UPGRADING BIOS

- It is highly recommended that you save a copy of the original mainboard BIOS along with a Flash EPROM Programming utility (AWDFLASH.EXE) to a bootable floppy disk in case you need to reinstall the BIOS later.

4-5-2 UPGRADE PROCESS

***Note:** Normally, to upgrade BIOS is unnecessary if the system is working fine without any problem. Users should not upgrade the BIOS unless you experience incompatible problems or need to create new features. However, please read all information in this section before upgrading.*

“AWDFLASH.EXE” is a Flash EPROM Programming utility that updates the BIOS by uploading a new BIOS file to the programmable flash ROM on the mainboard, This program works in **DOS environment only, the utility can not be executed in win95/98, ME, NT or WINDOWS 2000 environment.**

Upgrading the system BIOS

Step 1. Please visit the board maker’s website, download latest BIOS file and award flash utility “AWDFLASH.EXE”. The BIOS file format will be *.bin, of which “*” stands for the specific file name.

Step 2. Create a bootable diskette. Then copy the BIOS file and award flash utility “AWDFLASH.EXE” into the diskette.

Step 3. Insert the diskette into drive A, reboot your system and boot from the diskette.

Step 4. Type **awdf flash *.bin /sn/py/cc** and then press <Enter> to run BIOS upgrade program. (*.bin depends on your mainboard model and version code. Instead of typing “*”, you should type the specific file name for your

specific mainboard.)

Step 5. Please press <F1> or <F10> to exit or reset your system, **Warning !** If the message **“Write Fail”** appears while Award “FLASH MEMORY WRITER” is verifying Flash memory, just repeat the process. Please DO NOT reset or turn off the system. If the award memory flash utility is not able to update the BIOS successfully, your system may not be able to boot up.

Step 6. You will need a message “CMOS checksum error-Default loaded” during booting the system. Press to run CMOS setup utility, then reload “LOAD SETUP DEFAULTS” or **“Load Optimized Defaults”** and save this change.

Figure 4-5-1 Award Flash Memory Writer Start Screen

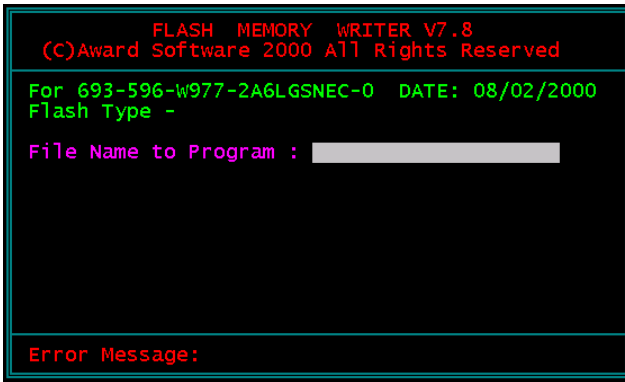
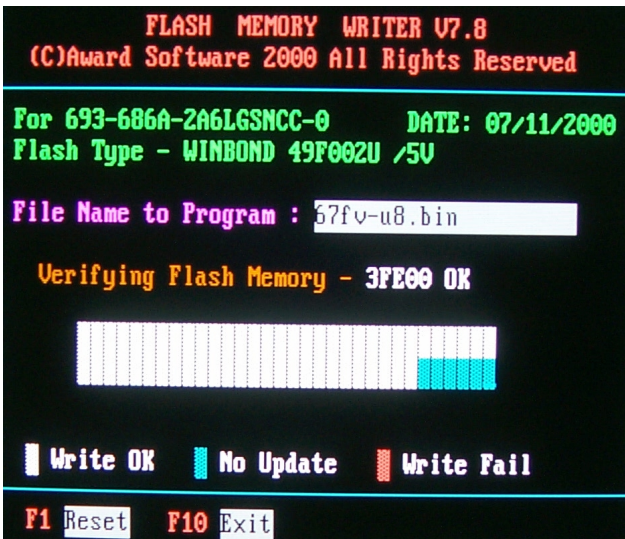

Figure 4-5-2 Award Flash Memory Writer Complete Screen



The parameters of AWDFLASH.EXE

/sn: No original BIOS backup

/py: Program flash memory

/cc: Clear CMOS data (and update data automatically) after programming

NOTE: Users can type AWDFLASH /? to get further details about the parameters. Incorrect usage of the parameter will damage the BIOS information, so we strongly recommend users to leave parameters alone unless you fully understand their function.

4-6 BIOS SETUP — CMOS SETUP UTILITY

- This VIA PM-133 mainboard comes with the AWARD BIOS from AWARD Software Inc. Enter the CMOS Setup Utility Main Menu by:

1. Turn on or reboot your system. After a series of diagnostic checks, the following message will appear:

PRESS TO ENTER SETUP

2. Press the key and the main program screen will appear as follows.

CMOS Setup Utility - Copyright (C) 1984 - 2001 Award Software

<ul style="list-style-type: none"> ▶ Standard CMOS Features ▶ Advanced BIOS Features ▶ Advanced Chipset Features ▶ Integrated Peripherals ▶ Power Management Setup ▶ PnP/PCI Configurations ▶ SmartDoc Anti-burn Shield 	<ul style="list-style-type: none"> ▶ Frequency/Voltage Control Load Optimized Defaults Set Supervisor Password Set User Password SAVE & EXIT SETUP EXIT WITHOUT SAVING
Esc : Quit F9 : Menu in BIOS ↑↓→← : Select Item F10 : Save & Exit Setup	
Time, Date, Hard Disk Type...	

3. Use the arrow keys on your keyboard to select an option, and press <Enter>. Modify the system parameters to reflect the options installed in your system.
4. You may return to the Main Menu anytime by pressing <ESC>.
5. In the Main Menu, “SAVE AND EXIT SETUP” saves your changes and reboots the system, and “EXIT WITHOUT SAVING” ignores your changes and exits the program.

4-6-1 STANDARD CMOS SETUP

- Standard CMOS Setup records some basic system hardware configuration and sets the system clock and error handling. You only need to modify the configuration values of this option if you want to change your system hardware configuration or when the data stored in the CMOS memory gets lost or damaged.

Run the STANDARD CMOS SETUP as follows:

1. Choose “STANDARD CMOS SETUP” from the Main Menu and a list of options will appear:

CMOS Setup Utility - Copyright (C) 1984-2001 Award Software
Standard CMOS Features

Date (mm:dd:yy)	Mon, January 1 2001	Item Help
Time (hh:mm:ss)	9 : 52 : 15	Menu Level ▶
▶ IDE Primary Master	Press Enter 13022 MB	
▶ IDE Primary Slave	Press Enter None	
▶ IDE Secondary Master	Press Enter None	
▶ IDE Secondary Slave	Press Enter None	
Drive A	1.44M, 3.5 in.	
Drive B	None	
Video	EGA/VGA	
Halt On	All Errors	
Base Memory	640K	
Extended Memory	31744K	
Total Memory	32768K	

↑↓←→:Move Enter::Select +/-/PU/PD:Value F10:Save ESC:Exit F1:General Help
F5:Previous Values F6:Fail-Safe Defaults F7:Optimized Defaults

2. Use one of the arrow keys to move between options and modify the selected options by using PgUp / PgDn / + / - keys.

<F1>: “Help” gives options available for each item.

<F5>: Get the previous values. These values are the values with which the user starts the current session.

<F6>: Load all options with the BIOS default values.

<F7>: Load all options with the Setup default values.

Date (mm:dd:yy) The BIOS determines the day of the week from the other date information. This field is for information only.

Press the left or right arrow key to move to the desired field (date, month, year). Press the PgUp or PgDn key to increment the setting, or type the desired value into the field.

Time (hh:mm:ss) The time format is based on the 24-hour military-time clock. For example, 1 P.M. is 13:00:00. Press the left or right arrow key to move to desired field. Press the PgUp or PgDn key to increment the setting, or type the desired value into the field.

**Primary / Secondary
Master / Slave** This field records the specifications for all non-SCSI hard disk drives installed in your system. Refer to the respective documentation on how to install the drives.

Drive A / Drive B Set this field to the type(s) of floppy disk drive(s) installed in your system. The choices are:

360KB, 5.25in.;

1.2MB, 5.25in.;

720KB, 3.5in.;

1.44MB, 3.5in.;

2.88MB, 3.5in.;

None.

Video Set this field to the type of video display card installed in the system. The choices are:

Monochrome;

Color 40x25;

VGA / EGA;

Color 80x25.

Halt On Set this warning feature for the type of errors that will cause the system to halt. The choices are:
 All Errors;
 Post stops for all error.
 No Errors;
 Post does not stop for any error.
 All, But Keyboard;
 Post stops for all, but not for keyboard error.
 All, But Diskette;
 Post stops for all, but not for Diskette error.
 All, But Disk / Key;
 Post stops for all, but not for Disk / Keyboard.

CMOS Setup Utility - Copyright (C) 1984-2001 Award Software
 IDE Primary Master

IDE HDD Auto-Detection	Press Enter	Item Help
IDE Primary Master	Auto	Menu Level ▶▶
Access Mode	Auto	
Capacity	13022 MB	
Cylinder	25232	
Head	16	
Precomp	0	
Landing Zone	25231	
Sector	63	

↑↓←→:Move Enter:Select +/-/PU/PD:Value F10:Save ESC:Exit F1:General Help
 F5:Previous Values F6:Fail-Safe Defaults F7:Optimized Defaults

3. Press <ESC> to return to the Main Menu when you finish setting up all items.

4-6-2 ADVANCED BIOS FEATURES

- ADVANCED BIOS FEATURES improves your system performance or sets up system features according to your preference.

Run the ADVANCED BIOS FEATURES as follows:

1. Choose “ADVANCED BIOS FEATURES” from the Main Menu and a list of options will appear:
2. Use one of the arrow keys to move between options and modify the selected options by using PgUp / PgDn / + / - keys.

<F1>: “Help” gives options available for each item.

<F5>: Get the previous values. These values are the values with which the user starts the current session.

<F6>: Load all options with the BIOS default values.

<F7>: Load all options with the Setup default values.

CMOS Setup Utility - Copyright (C) 1984-2001 Award Software
Advanced BIOS Features

		Item Help
Virus Warning	Disabled	Menu Level ▶
CPU Internal Cache	Enabled	
External Cache	Enabled	
CPU L2 Cache ECC Checking	Enabled	
Process or Number Feature	Disabled	
Quick Power On Self Test	Enabled	
First Boot Device	Floppy	
Second Boot Device	HDD-0	
Third Boot Device	CDROM	
Boot Other Device	Enabled	
Swap Floppy Drive	Disabled	
Boot Up Floppy Seek	Disabled	
Boot Up NumLock Status	On	
Gate A20 Option	Fast	
Typematic Rate Setting	Disabled	
× Typematic Rate (Chars/Sec)	6	
× Typematic Delay (Msec)	250	
Security Option	Setup	
OS Select For DRAM > 64MB	Non-OS2	
Video BIOS Shadow	Enabled	
C8000-CBFFF Shadow	Disabled	
CC000-CFFFF Shadow	Disabled	
D0000-D3FFF Shadow	Disabled	
D4000-D7FFF Shadow	Disabled	
D8000-DBFFF Shadow	Disabled	
DC000-DFFFF Shadow	Disabled	

↑↓→←:Move Enter:Select +/-/PU/PD:Value F10:Save ESC:Exit F1:General Help
F5:Previous Values F6:Fail-Safe Defaults F7:Optimized Defaults

- Virus Warning** Enabled: Activates automatically when the system boots up showing a warning message if anything attempts to access the boot sector or hard disk partition table.
- Disabled: No warning message will appear when there is something attempting to access the boot sector or hard disk partition table.

NOTE: Many diagnostic (or boot manager) programs which attempt to access the boot sector table can cause the above warning message. If you will be running such a program, we recommend that you disable the virus protection first.

- CPU Internal Cache/ External Cache** Cache memory is additional memory that is much faster than conventional DRAM (system memory). CPUs from 486-type up contain internal cache memory, and most, but not all, modern PCs have additional (external) cache memory. When the CPU requests data, the system transfers the requested data from the main DRAM into cache memory, for even faster access by the CPU.
- CPU L2 Cache ECC Checking** When you select *Enabled*, it will speed up memory checking when the external cache contains ECC SRAMs.
- The choices: Enabled; Disabled.
- Processor Number Feature** Choose Disabled or Enabled. When enabled, the processor serial number will display during the boot up screen.
- Quick Power On Self Test** Select Enabled to reduce the amount of time required to run the power-on self-test (POST). A quick POST skips certain steps. We recommend that you normally enable quick POST. Better to find a problem during POST than lose data during your work.

- First/Second/Third/Other Boot Device** The BIOS attempts to load the operating system from the devices in the sequence selected in these items. The choices: Floppy; LS/ZIP; HDD; SCSI; CDROM; Disabled.
- Swap Floppy Drive** When enabled, floppy drives A and B will be exchanging without any physical connection and modification on the cables.
- Boot Up Floppy Seek** Enabled : During POST, BIOS checks the track number of the floppy disk drive to see whether it is 40 or 80 tracks.
Disabled: During POST, BIOS will not check the track number of the floppy disk drive.
- Boot Up NumLock Status** Toggle between On or Off to control the state of the NumLock key when the system boots. When toggled On, the numeric keypad generates numbers instead of controlling cursor operations.
- Gate A20 Option** Gate A20 refers to the way the system addresses memory above 1 MB (extended memory). When set to *Fast*, the system chipset controls Gate A20. When set to *Normal*, a pin in the keyboard controller controls Gate A20. Setting Gate A20 to *Fast* improves system speed, particularly with OS/2 and Windows.
- Typematic Rate Setting** When *Disabled*, the following two items (Typematic Rate and Typematic Delay) are irrelevant. Keystroke repeats at a rate determined by the keyboard controller in your system.
When *Enabled*, you can select a typematic rate and typematic delay.
- Typematic Rate (Chars / Sec)** When the typematic rate setting is enabled, you can select a typematic rate (the rate at which character repeats when you hold down a key) of 6, 8, 10, 12, 15, 20, 24, or 30 characters per second.

Typematic Delay (Msec) Choices: 250; 500; 750; 1000. This option sets the time interval for displaying the first and the second characters. If enabled, the time interval is optional.

Security Option If you have set a password, select whether the password is required every time the System boots, or only when you enter setup.
The choices: system; setup.

OS Select For DRAM > 64MB Select OS2 only if you are running OS/2 operating system with greater than 64MB of RAM on your system.

Video BIOS Shadow Enabled, Video BIOS is copied to shadow RAM for improving performance.
The choices: Enabled; Disabled.

C8000-CBFFF to DC000-DFFFF Shadow These options are used to copy firmware from other expansion card ROMs to system RAM.

3. Press <ESC> to return to the Main Menu when you finish setting up all items.

4-6-3 ADVANCED CHIPSET FEATURES

- ADVANCED CHIPSET FEATURES is used to modify the values of chipset registers. These registers control the system options.

Run the ADVANCED CHIPSET FEATURES as following:

1. Choose "ADVANCED CHIPSET FEATURES" from the Main Menu and a list of options will appear:
2. Use one of the arrow keys to move between options and modify the selected options by using PgUp / PgDn / + / - keys.

<F1>: "Help" gives options available for each item.

<F5>: Get the previous values. These values are the values with which the user starts the current session.

<F6>: Load all options with the BIOS default values.

<F7>: Load all options with the Setup default values.

CMOS Setup Utility - Copyright (C) 1984-2001 Award Software
Advanced Chipset Features

		Item Help
DRAM Timing by SPD	Disabled	Menu Level ▶
DRAM Clock	Host CLK	
SDRAM Cycle Length	3	
Bank Interleave	Disabled	
DRAM Drive Strength	Auto	
DRAM Drive Value	2F	
× Memory Hole	Disabled	
P2C/C2P Concurrency	Enabled	
Fast R-W Turn Around	Disabled	
System BIOS Cacheable	Disabled	
Video RAM Cacheable	Disabled	
Frame Buffer Size	8M	
AGP Aperture Size	64M	
AGP-4X Mode	Enabled	
AGP Driving Control	Auto	
AGP Driving Value	DA	
× AGP Fast Write	Disabled	
OnChip USB	Enabled	
OnChip USB 2	Enabled	
USB Keyboard Support	Disabled	
USB Mouse Support	Disabled	
OnChip Sound	Auto	
OnChip Modem	Disabled	
CPU to PCI Write Buffer	Enabled	
PCI Dynamic Bursting	Disabled	
PCI Master 0 WS Write	Enabled	
PCI Delay Transaction	Enabled	
PCI#2 Access #1 Retry	Enabled	
AGP Master 1 WS Write	Disabled	
AGP Master 1 WS Read	Disabled	
CPU Vcore Select	Default	

↑↓→←:Move Enter:Select +/-/PU/PD:Value F10:Save ESC:Exit F1:General Help
F5:Previous Values F6:Fail-Safe Defaults F7:Optimized Defaults

DRAM Timing by SPD When this item is Enabled, DRAM Timing is set by SPD. SPD (Serial Presence Detect) is located on the memory modules, BIOS reads information coded in SPD during system boot up.

DRAM Clock This item allows you to control the DRAM speed.
The choices: Host Clock; HCLK+33M; HCLK-33M.

SDRAM Cycle Length Select CAS latency time in HCLKs of 2 or 3. The system designer already set the values. Do not change the default value unless you change specifications of the installed DRAM or the installed CPU.

Bank Interleave Please use default setting.
The choices: Disabled; 2 Bank; 4 Bank.

DRAM Drive Strength Leave this item at Auto mode.
The choices: Auto; Manual.

DRAM Drive Value When “DRAM Drive Strength” is set to “Auto”, this item will be unable to be selected. We don’t recommend user to adjust this item.

Memory Hole In order to improve performance, certain space in memory is reserved for ISA cards. This memory must be mapped into the memory space below 16MB.
The choices: 15M-16M; Disabled.

P2C/C2P Concurrency This item allows you to enable/disable the PCI to CPU, CPU to PCI concurrency.
The choices: Enabled; Disabled.

Fast R-W Turn Around This item controls the DRAM timing. It allows you to enable / disable the fast read / write turn around.
The choices: Enabled; Disabled.

System BIOS Cacheable selecting Enabled allows caching of the system BIOS ROM at F0000h-FFFFFh, resulting in better system performance.

- Video RAM Cacheable** Selecting Enabled allows caching of the video memory (RAM) at A0000h to AFFFFh, resulting in better video performance.
However, check your AGP manual to find out if any compatibility problem exists.
- Frame Buffer size** This option allows you select memory size shared to on-chip graphics.
- AGP Aperture Size** Series of options are available: 4, 8, 16, 32, 64, 128 or 256 MB. Memory mapped and graphics data structures can reside in a Graphics Aperture. This area is like a linear buffer. BIOS will automatically report the starting address of this buffer to the O.S. The default setting is 64MB.
- AGP-4X Mode** This item allows user enable/disable the AGP 4X (133MHz clock)mode.
The choices: Enabled; Disabled.
- AGP Driving Control** This item allows you to adjust the AGP driving force. Choose "*Manual*" to key in a AGP Driving Value in the next selection. This field is recommended to set to "*Auto*" for avoiding any error in your system.
The choices: Manual; Auto.
- AGP Driving Value** This item allows you to adjust the AGP driving force.
The choices: Min=0000 ~ Max=00FF.
- AGP Fast Write** This item will enable the AGP model into fast write mode.
- OnChip USB/USB2** This should be enabled if our system has a USB installed on the system board and you wish to use it. Even when so equipped, if you add a higher performance controller, you will need to disable this feature.
The choices: Enabled; Disabled.
- USB Keyboard Support** Enable function when the USB keyboard is being used. When the AT keyboard is being used, choose disabled.
The choices:Enabled; Disabled.

- USB Mouse Support** Select Enabled if your system contains a Universal Serial Bus (USB) controller and you have a USB mouse.
The choices: Enabled; Disabled.
- OnChip Sound** Select Enabled to use the on-chip Audio capability of your system. Most of the following field do not appear when this field is Disabled. For user who wants to use another sound card, this field must be Disabled.
- OnChip Modem** Select Enabled to use the on-chip Modem capability of your system. This field must be Disabled, if there is NO AMR modem card installed.
The choices: Auto; Disabled.
- CPU to PCI Write Buffer** When this field is Enabled, writes from the CPU to the PCI bus are buffered, to compensate for the speed differences between the CPU and the PCI bus. When Disabled, the writes are not buffered and the CPU must wait until the write is complete before starting another write cycle.
The choices: Enabled; Disabled.
- PCI Dynamic Bursting** When Enabled, every write transaction goes to the write buffer. Bursting transactions then burst on the PCI bus and non-bursting transactions don't.
The choices: Enabled; Disabled.
- PCI Master 0 WS Write** When Enabled, writes to the PCI bus are executed with zero wait states.
The choice: Enabled, Disabled.
- PCI Delay Transaction** Leave this field at default
The choice: Enabled, Disabled.
- PCI # 2 Access # 1 Retry** Leave this field at default
The choice: Enabled, Disabled(default).
- AGP Master 1 WS Write** Leave this field at default
The choice: Enabled, Disabled(default).

AGP Master 1 WS Leave this field at default
Read The choice: Enabled, Disabled(default).

CPU Vcore Select This item allows users to adjust the CPU Vcore voltage. The instant damage of CPU is due to the wrong Vcore voltage setting, so we highly recommend that user should leave this item to Default setting unless you fully understand it.

3. Press <ESC> to return to the Main Menu when you finish setting up all items.

4-6-4 INTEGRATED PERIPHERALS

- INTEGRATED PERIPHERALS option allows you to get some information inside your system when it is working.

Run the INTEGRATED PERIPHERALS as follows:

1. Choose “INTEGRATED PERIPHERALS” from the Main Menu and a list of options will appear:

CMOS Setup Utility - Copyright (C) 1984-2001 Award Software
Integrated Peripherals

		Item Help
On-Chip IDE Channel 0	Enabled	
On-Chip IDE Channel 1	Enabled	Menu Level ▶
IDE Prefetch Mode	Enabled	
Primary Master PIO	Auto	
Primary Slave PIO	Auto	
Secondary Master PIO	Auto	
Secondary Slave PIO	Auto	
Primary Master UDMA	Auto	
Primary Slave UDMA	Auto	
Secondary Master UDMA	Auto	
Secondary Slave UDMA	Auto	
Init Display First	PCI Slot	
IDE HDD Block Mode	Enabled	
Onboard FDD Controller	Enabled	
Onboard Serial Port 1	Auto	
Onboard Serial Port 2	Auto	
UART 2 Mode	Standard	
× IR Function Duplex	Half	
× TX, RX inverting enable	No, Yes	
Onboard Parallel Port	378/IRQ7	
Onboard Parallel Mode	Normal	
ECP Mode Use DMA	3	
Parallel Port EPP Type	EPP1.9	
Onboard Legacy Audio	Enabled	
Sound Blaster	Disabled	
SB I/O Base Address	220H	
SB IRQ Select	IRQ 5	
SB DMA Select	DMA 1	
MPU-401	Disabled	
MPU-401 I/O Address	330-333H	
Game Port (200-207H)	Enabled	

↑↓→←:Move Enter:Select +/-/PU/PD:Value F10:Save ESC:Exit F1:General Help
F5:Previous Values F6:Fail-Safe Defaults F7:Optimized Defaults

2. Use one of the arrow keys to move between options and modify the selected options by using PgUp / PgDn / + / - keys.

<F1>: "Help" gives options available for each item.

<F5>: Get the previous values. These values are the values with which the user starts the current session.

<F6>: Load all options with the BIOS default values.

<F7>: Load all options with the Setup default values.

OnChip IDE Channel 0/1 The chipset contains a PCI IDE interface with support from two IDE channels. Select Enabled to activate the first and/or the second IDE interface. Select Disabled to inactivate an interface if you install a primary and/or second add-on IDE interface.
The choices: Enabled; Disabled.

IDE Prefetch Mode The on-board IDE drive supports IDE prefetching for faster drive accesses. If the IDE device doesn't support prefetching, set this field to Disabled.
The choices: Enabled; Disabled.

Primary Choose Auto or Mode 0~4. The BIOS will detect the
Master / Slave PIO HDD mode type automatically when you choose Auto.
Secondary You need to set to a lower mode than Auto when your
Master / Slave PIO hard disk becomes unstable.
The choices: Auto; Mode 0; Mode 1; Mode 2;
Mode 3; Mode 4.

Primary Ultra DMA33/66/100 implementation is possible only
Master / Slave UDMA if your IDE hard drive supports it, if the operating environment includes a DMA drive, and if your system
Secondary software both support Ultra DMA33/66/100. Select
Master / Slave UDMA "Auto" to enable BIOS support.
The choices: Auto; Disabled.

Init Display First Initialize the AGP video display before initializing any other display device on the system. Thus the AGP display becomes the primary display.
The choices: PCI Slot; AGP.

IDE HDD Block Mode Block mode is also called block transfer, multiple commands, or multiple sector read/write. If your IDE hard drive supports block mode (most new drives do), select Enabled for automatic detection of the optimal number of block read/write per sector the drive can support.

The choices: Enabled; Disabled.

Onboard FDD Controller Select Enabled if your system has a floppy drive controller (FDC) installing in the system board and you want to use it. If you install add-in FDC or the system has no floppy drive, select Disabled in this field.

The choices: Enabled; Disabled.

Onboard Serial Port 1 / Port 2 Select an address and corresponding interrupt for the first and second serial ports.

The choices: 3F8/IRQ4; 2E8/IRQ3; 3E8/IRQ4; 2F8/IRQ3; Disabled; Auto.

UART 2 Mode The second serial port on your system may offer a variety of infrared port modes. Click here for a description of various modes. (Click your browser's Back button, or your right mouse button, to return to this page.)

The choices: Standard; HPSIR; ASKIR.

IR Function Duplex This item allows you to select the IR half / full duplex function.

The choices: Half; Full.

TX, RX inverting enable This item allows you to enable the TX, RX inverting which depends on different H/W requirement. This field is not recommended to change its default setting.

The choices: "No, No"; "No, Yes"; "Yes, No"; "Yes, Yes".

Onboard Parallel Port Select a logical LPT port name and matching address for the physical parallel (printer) port.

The choices: 378H/IRQ7; 278H/IRQ5; 3BC/IRQ7; Disabled.

Onboard Paralle Mode Select an operating mode for the onboard parallel (printer) port. Select Normal, Compatible, or SPP unless you are certain your hardware and software both support one of the other available modes.
The choices: SPP; EPP; ECP; ECP + EPP.

ECP Mode Use DMA Select a DMA channel for the parallel port for use during ECP mode.
The choices: 3; 1.

Parallel Port EPP Type Select EPP port type 1.7 or 1.9
The choices: EPP1.7; 1.9.

Onboard Legacy Audio This field controls the on-board audio.

- Sound Blaster
- SB I/O Base Address
- SB IRQ Select
- SB DMA Select
- MPU-401
- MPU-401 I/O Address
- Game Port (200-207H)

3. Press <ESC> to return to the Main Menu when you finish setting up all items.

4-6-5 POWER MANAGEMENT SETUP

- POWER MANAGEMENT SETUP allows you to set the system’s power saving functions.

Run the POWER MANAGEMENT SETUP as follows:

1. Choose “POWER MANAGEMENT SETUP” from the Main Menu and a list of options will appear:

CMOS Setup Utility - Copyright (C) 1984-2001 Award Software
Power Management Setup

ACPI Function	Enabled	Item Help
▶ Power Management	Press Enter	Menu Level ▶
ACPI Suspend Type	S1 (POS)	
PM Control by APM	Yes	
Video Off Option	Suspend --> Off	
Video Off Method	V/H SYNC+Blank	
MODEM Use IRQ	3	
Soft-Off by PWRBTN	Instand-Off	
State After Power Failure	Auto	
▶ Wake Up Events	Press Enter	

↑↓→←:Move Enter:Select +/-/PU/PD:Value F10:Save ESC:Exit F1:General Help
F5:Previous Values F6:Fail-Safe Defaults F7:Optimized Defaults

2. Use one of the arrow keys to move between options and modify the selected options by using PgUp / PgDn / + / - keys.

<F1>: “Help” gives options available for each item.

<F5>: Get the previous values. These values are the values with which the user starts the current session.

<F6>: Load all options with the BIOS default values.

<F7>: Load all options with the Setup default values.

ACPI Function Select Enabled only if your computer's operating system supports the Advanced Configuration and Power Interface (ACPI) specification. Currently, Windows NT 5.0 support ACPI.

- Press <Enter> on the Power Management item, then there appears a list of options for you to configure further setting.

CMOS Setup Utility - Copyright (C) 1984-2001 Award Software
Power Management

Power Management	User Define	Item Help
HDD Power Down	Disable	Menu Level ▶
Doze Mode	Disable	
Suspend Mode	Disable	

↑↓→←:Move Enter:Select +/-/PU/PD:Value F10:Save ESC:Exit F1:General Help
F5:Previous Values F6:Fail-Safe Defaults F7:Optimized Defaults

Power Management This option allows you to select the type (or degree) of power saving for Doze, Standby, and Suspend modes.

This table describes each power management mode:

Max Saving	Maximum power savings. Only Available for SL CPUs. Inactivity period is 1 minute in each mode.
User Define	Set each mode individually. Select time-out periods in the section for each mode, stated below.
Min Saving	Minimum power savings. Inactivity period is 1 hour in each mode (except the hard drive).

HDD Power Down After the selected period of drive inactivity, the hard disk drive powers down while all other devices remain active.

Doze Mode After the selected period of system inactivity, the CPU clock runs at slower speed while all other devices still operate at full speed.

Suspend Mode After the selected period of system inactivity, all devices except the CPU shut off.

ACPI Suspend Type This item shows ACPI suspend type.

PM Control by APM If Advanced Power Management (APM) is installed on your system, selecting “Yes” gives better power savings.
The Choices: Yes; No.

Video Off Option When enabled, this feature allows the VGA adapter to operate in a power saving mode.

Always On	Monitor will remain on during power saving modes.
Suspend --> Off	Monitor blanked when the systems enters the Suspend mode.
Susp, Stby --> Off	Monitor blanked when the system enters either Suspend or Standby modes.

Video Off Method This determines the manner in which the monitor is blanked.

V/H SYNC + Blank	This selection will cause the system to turn off the vertical and horizontal synchronization ports and write blanks to the video buffer.
Blank Screen	This option only writes blanks to the video buffer.
DPMS	Select this option if your monitor supports the Display Power Management Signaling (DPMS) standard of the Video Electronics Standards to select video power management values.

MODEM Use IRQ This determines the IRQ which the MODEM can use. The choices: 3; 4; 5; 7; 9; 10; 11; NA.

Soft-Off by PWR-BTTN When Enabled, turning the system off with the on/off button places the system in a very low-power-usage state, with only enough circuitry receiving power to detect power button activity or Resume by Ring activity.

State after Power Failure This field lets you determine the state that your PC returns to after a power failure. If set to off, the PC will not boot after a power failure. If set to On, the PC will restart after a power failure.

- Press <Enter> on the Wake Up Events item, then there appears a list of options for you to configure further setting.

Wake Up Events Enable or turn on the interrupts that you want to awaken the system from a reduced-power mode. Disable or turn off the interrupts that you do not want to awaken the system from a reduced-power mode.

CMOS Setup Utility - Copyright (C) 1984-2001 Award Software
Wake Up Events

VGA	OFF	Item Help
LPT & COM	LPT/COM	Menu Level ▶
HDD & FDD	ON	
PCI Master	OFF	
PowerOn by PCI Card	Disabled	
Wake Up On LAN/Ring	Disabled	
RTC Alarm Resume	Disabled	
Date (of Month)	0	
Resume Time (hh:mm:ss)	0 0 0	
Primary INTR	ON	
IRQ Activity Monitoring	Press Enter	

↑↓→←:Move Enter:Select +/-/PU/PD:Value F10:Save ESC:Exit F1:General Help
F5:Previous Values F6:Fail-Safe Defaults F7:Optimized Defaults

VGA When Enabled, you can set the VGA awakens the system.

LPT & COM When LPT & COM is ON, any activity from one of the listed system peripheral devices or IRQs wakes up the system.

HDD & FDD When HDD & FDD is ON, any activity from one of the listed system peripheral devices wakes up the system.

PCI Master When PCI Master is ON, any activity from one of the listed system peripheral devices wakes up the system.

PowerOn PCI Card Leave this field at default

Wake Up On LAN/Ring An input signal on the serial Ring Indicator (RI) line (in other words, an incoming call on the modem) awakens the system from a soft off state.
The choices: Enabled; Disabled.

RTC Alarm Resume When Enabled, you can set the data and time at which the RTC (Real Time Clock) alarm awakens the system from suspend mode.
The choices: Disabled; Enabled.

Date (of Month) Set a certain date when RTC Alarm Resume option is Enabled to awaken the system. This option is concurrent with Resume Time option.

Resume Time (hh:mm:ss) Set a certain time when RTC Alarm Resume option is Enabled to awaken the system. This option is concurrent with Date option.

Primary INTR Leave this field at default

IRQS Activity Monitoring The following is a list of IRQ's (Interrupt ReQuests), which can be exempted much as the COM ports and LPT ports above can. When an I/O device wants to gain the attention of the operating system, it signals this by causing an IRQ to occur. When the operating system is ready to respond to the request, it interrupts itself and performs the service. When set On, activity will neither prevent the system from going into a power management mode nor awaken it.

CMOS Setup Utility - Copyright (C) 1984-2001 Award Software
IRQ Activity Monitoring

		Item Help
IRQ 3 (COM2)	Enabled	Menu Level ▶
IRQ 4 (COM1)	Enabled	
IRQ 5 (LPT2)	Enabled	
IRQ 6 (Floppy Disk)	Enabled	
IRQ 7 (LPT1)	Enabled	
IRQ 8 (RTC Alarm)	Disabled	
IRQ 9 (IRQ2 Redir)	Disabled	
IRQ 10 (Reserved)	Disabled	
IRQ 11 (Reserved)	Disabled	
IRQ 12 (PS/2 Mouse)	Enabled	
IRQ 13 (Coprocessor)	Disabled	
IRQ 14 (Hard Disk)	Enabled	
IRQ 15 (Reserved)	Disabled	

↑↓→←:Move Enter:Select +/-/PU/PD:Value F10:Save ESC:Exit F1:General Help
F5:Previous Values F6:Fail-Safe Defaults F7:Optimized Defaults

3. Press <ESC> to return to the Main Menu when you finish setting up all items.

4-6-6 PNP / PCI CONFIGURATION

- PNP/PCI CONFIGURATION allows you to modify the system's power saving functions.

Run the PNP/PCI CONFIGURATION as follows:

1. Choose "PNP/PCI CONFIGURATION" from the Main Menu and a list of options will appear:

CMOS Setup Utility - Copyright (C) 1984-2001 Award Software
PnP/PCI Configurations

PNP OS Installed	No	Item Help
Reset Configuration Data	Disabled	Menu Level ▶
Resources Controlled By	Auto(ESCD)	
× IRQ Resources	Press Enter	
× DMA Resources	Press Enter	
PCI/VGA Palette Snoop	Disabled	
Assign IRQ For VGA	Enabled	
Assign IRQ For USB	Enabled	

↑↓→←:Move Enter:Select +/-/PU/PD:Value F10:Save ESC:Exit F1:General Help
F5:Previous Values F6:Fail-Safe Defaults F7:Optimized Defaults

2. Use one of the arrow keys to move between options and modify the selected options by using PgUp / PgDn / + / - keys.

<F1>: "Help" gives options available for each item.

<F5>: Get the previous values. These values are the values with which the user starts the current session.

<F6>: Load all options with the BIOS default values.

<F7>: Load all options with the Setup default values.

PNP OS Installed Select Yes if the system operating environment is Plug-and Play aware (e.g., Windows 95).

NOTE: BIOS will automatically disable all PnP resources except the boot device card when you select Yes on Non-PnP operating system.

Reset Configuration Data Normally, you leave this *Disabled*. Select *Enabled* to reset Extended System Configuration Data (ESCD), when you exit Setup if you have installed a new add-on and the system reconfiguration has caused such a serious conflict that the operating system cannot boot.

Resource Controlled By Choose Manual or Auto. The BIOS checks the IRQ / DMA channel number on the ISA and PCI card manually set up if you choose Manual, and the IRQ / DMA channel number will be checked automatically if you choose Auto.

IRQ Resources Press Enter. Please refer to the list below:

CMOS Setup Utility - Copyright (C) 1984-2001 Award Software
IRQ Resources

IRQ-3 assigned to	PCI/ISA PnP	Item Help
IRQ-4 assigned to	PCI/ISA PnP	Menu Level ▶
IRQ-5 assigned to	PCI/ISA PnP	
IRQ-7 assigned to	PCI/ISA PnP	
IRQ-9 assigned to	PCI/ISA PnP	
IRQ-10 assigned to	PCI/ISA PnP	
IRQ-11 assigned to	PCI/ISA PnP	
IRQ-12 assigned to	PCI/ISA PnP	
IRQ-14 assigned to	PCI/ISA PnP	
IRQ-15 assigned to	PCI/ISA PnP	

↑↓→←:Move Enter:Select +/-/PU/PD:Value F10:Save ESC:Exit F1:General Help
F5:Previous Values F6:Fail-Safe Defaults F7:Optimized Defaults

DMA Resources Press Enter. Please refer to the list below:

CMOS Setup Utility - Copyright (C) 1984-2001 Award Software
DMA Resources

DMA-0 assigned to	PCI/ISA PnP	Item Help
DMA-1 assigned to	PCI/ISA PnP	Menu Level ▶
DMA-3 assigned to	PCI/ISA PnP	
DMA-5 assigned to	PCI/ISA PnP	
DMA-6 assigned to	PCI/ISA PnP	
DMA-7 assigned to	PCI/ISA PnP	

↑↓→←:Move Enter:Select +/-/PU/PD:Value F10:Save ESC:Exit F1:General Help
F5:Previous Values F6:Fail-Safe Defaults F7:Optimized Defaults

PCI/VGA Palette Snoop This option allows the BIOS to preview VGA status, and to modify the information delivered from the feature Connector of the VGA card to MPEG card. This option can solve the display inversion to black after you have used MPEG card.

Assign IRQ for VGA Select *Enabled* if you system has a VGA controller and you have one or more USB devices connected. If you are not using your system's VGA controller, select *Disabled* to free the IRQ resource.

Assign IRQ for USB Select *Enabled* if you system has a USB controller and you have one or more USB devices connected. If you are not using your system's USB controller, select *Disabled* to free the IRQ resource.

3. Press <ESC> to return to the Main Menu when you finish setting up all items.

4-6-7 SMARTDOC ANTI-BURN SHIELD

- This section helps you to get more information about your system including CPU temperature, FAN speed and voltage. It is recommended that you contact your mainboard supplier to get proper values about the setting of the CPU temperature.

Run the “SMARTDOC ANTI-BURN SHIELD” as follows:

1. Choose “SMARTDOC ANTI-BURN SHIELD” from the Main Menu and a list of options will appear:

CMOS Setup Utility - Copyright (C) 1984-2001 Award Software
SmartDoc Anti-Burn Shield

Current CPU Temp.	36 °C/96 °F (for 65MIV2 only)	Item Help
Current System Temp.	°C/32 °F (for 65MIV2 only)	Menu Level ▶
Current CPUFAN1 Speed	5120 RPM	
Current CPUFAN2 Speed	0 RPM	
Vcore	1.53V	
VDD	3.34V	
3.3V	3.28V	
5V	5.00V	
12V	11.76V	

↑↓→← :Move Enter:Select +/-/PU/PD:Value F10:Save ESC:Exit F1:General Help
F5:Previous Values F6:Fail-Safe Defaults F7:Optimized Defaults

2. Use one of the arrow keys to move between options and modify the selected options by using PgUp / PgDn / + / - keys.

<F1>: “Help” gives options available for each item.

<F5>: Get the previous values. These values are the values with which the user starts the current session.

<F6>: Load all options with the BIOS default values.

<F7>: Load all options with the Setup default values.

Current CPU Temp. Shows current CPU temperature.
(for 65MIV2 only)

Current System Temp. Shows current system temperature.
(for 65MIV2 only)

Current CPUFAN1 Speed Shows current CPUFAN1 speed. The fan must provide rotary pulse. (Normally this type of fan has a three-wire connector)

Current CPUFAN2 Speed Shows current CPUFAN2 speed. The fan must provide rotary pulse. (Normally this type of fan has a three-wire connector)

Vcore/VDD/3.3V/5V/12V Shows actual voltage value of power supply.

- Press <ESC> to return to the Main Menu when you finish setting up all items.

4-6-8 FREQUENCY/VOLTAGE CONTROL

Run the "FREQUENCY/VOLTAGE CONTROL" as follows:

1. Choose "FREQUENCY/VOLTAGE CONTROL" from the Main Menu and a list of options will appear:

CMOS Setup Utility - Copyright (C) 1984-2001 Award Software
Frequency Control

Auto Detect DIMM/PCI CLK	Enabled	Item Help
Spread Spectrum	Disabled	Menu Level ▶
CPU Host/PCI Clock	66	

↑↓→←:Move Enter:Select +/-/PU/PD:Value F10:Save ESC:Exit F1:General Help
F5:Previous Values F6:Fail-Safe Defaults F7:Optimized Defaults

2. Use one of the arrow keys to move between options and modify the selected options by using PgUp / PgDn / + / - keys.

<F1>: "Help" gives options available for each item.

<F5>: Get the previous values. These values are the values with which the user starts the current session.

<F6>: Load all options with the BIOS default values.

<F7>: Load all options with the Setup default values.

Auto Detect DIMM/PCI CLK This item allows you to enable/disable to detection of DIMM/PCI Clock.
The choices: Enabled; Disabled.

Spread Spectrum Modulated This item allows you to enable/disable the spread spectrum modulate.
The choices: Enabled; Disabled.

CPU Host/PCI Clock This item allows you to select CPU/PCI frequency.
The choices: 66~200Mhz.

- Press <ESC> to return to the Main Menu when you finish setting up all items.

4-6-9 LOAD OPTIMIZED DEFAULTS

- When you press <Enter> on this item, you will get a confirmation dialog box with a message similar to:

`" Load Optimized Defaults (Y / N) ? N "`

"Y" is for "Yes", and "N" is for "No".

- Pressing "Y" loads the BIOS default values that are factor settings for optimal performance of system operations.

4-6-10 SET SUPERVISOR / USER PASSWORD

- These two options allow you to set your system passwords. Normally, the supervisor has a higher priority to change the CMOS setup option than the users. The way to set up the passwords for both Supervisor and Users are as follows:

1. Choose "Change Password" in the Main Menu and press <Enter>. Then the following message appears:

"Enter Password : "

2. The first time you run this option, enter your password up to 8 characters and press <Enter>. (The screen does not display the entered characters.)
3. After you enter the password, the following message appears prompting you to confirm the password:

"Confirm Password : "

4. Enter the same password "exactly" the same as you have just typed to confirm the password and press <Enter>.
5. Move the cursor to Save & Exit Setup to save the password.
6. If you need to delete the password entered before, choose the Supervisor Password and press <Enter>. It will delete the password that you have entered before.
7. Move the cursor to Save & Exit Setup to save the option you have just configured; otherwise the old password will still be there the next time you turn your system on.
8. Press <Enter> to exit to the Main Menu.

NOTE: *If you forget or lose the password, the only way to access the system is to clear the CMOS RAM. All setup informations will be lost and you need to run the BIOS setup program again.*

4-6-11 SAVE & EXIT SETUP

- SAVE & EXIT SETUP allows you to save all modifications you have specified into the CMOS memory. Highlight this option on the Main Menu and the following message appears:

`"SAVE to CMOS and EXIT (Y/N) ? Y "`

"Y" is for "Yes", and "N" is for "No".

- Press <Enter> key to save the configuration changes.
-

4-6-12 EXIT WITHOUT SAVING

- EXIT WITHOUT SAVING option allows you to exit the Setup Utility without saving the modifications that you have specified. Highlight this option on the Main Menu and the following message appears:

`"Quit Without Saving (Y/N) ? N "`

"Y" is for "Yes", and "N" is for "No".

- You may change the prompt to "Y" and press <Enter> key to leave this option .
-

APPENDICES

THIS CHAPTER CONTAINS THE FOLLOWING TOPICS :

APPENDIX-1 TECHNICAL TERMS INTRODUCTION

APPENDIX-2 IDENTIFYING BIOS VERSION

APPENDIX-3 IDENTIFYING MAINBOARD MODEL NUMBER

APPENDIX-1 TECHNICAL TERMS INTRODUCTION

Technical Terms Introduction	
Tech Term	Meaning
AGP	Accelerated Graphic Port
AMR	Audio Modem Riser
ACR	Advanced Communication Riser
CPU	Central Processing Unit
CMOS	Complementary Metal Oxide Semiconductor
CRIMM	Continuity RIMM
CNR	Communication and Networking Riser
DMA	Direct Memory Access
DMI	Desktop Management Interface
DIMM	Dual Inline Memory Module
DRAM	Dynamic Random Access Memory
DDR	Double Data Rate
ECP	Extended Capabilities Port
ESCE	Extended System Configuration Data
ECC	Error Check and Correct
EPP	Enhanced Parallel Port
FDD	Floppy Disk Device
IDE	Integrated Dual Channel Enhanced
IRQ	Interrupt ReQuest
I/O	Input/Output
LAN	Local Area Network
LBA	Logical Block Addressing
LED	Light Emitting Diode
MHz	Megahertz
PNP	Plug & Play
USB	Universal Serial Bus
VCM	Virtual Channel Memory

APPENDIX-2 IDENTIFYING BIOS VERSION AND BIOS PART NUMBER

When you boot up your computer, you may see a screen which tells your computer is phoenixnet™ enabled, please see the example below.

When the main screen Figure1 shows up, press “Tab” key to display BIOS information (Figure2).

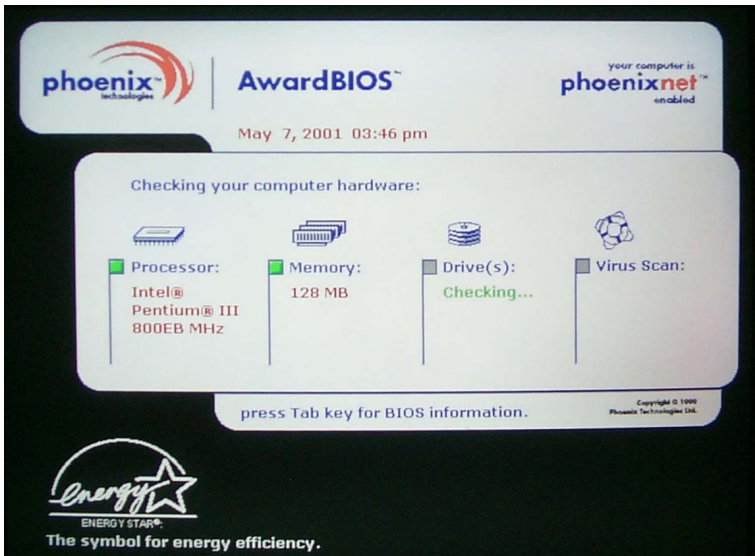

Figure 1 - Phoenixnet screen

Figure2 shown below displays the BIOS version and BIOS part number identification.

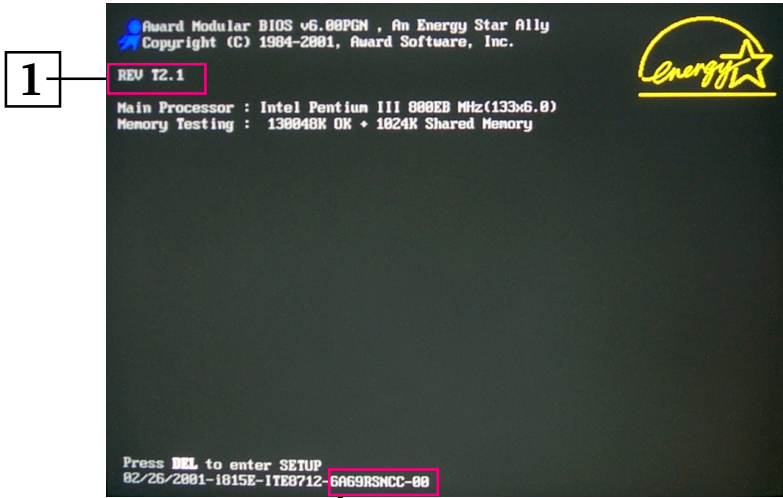
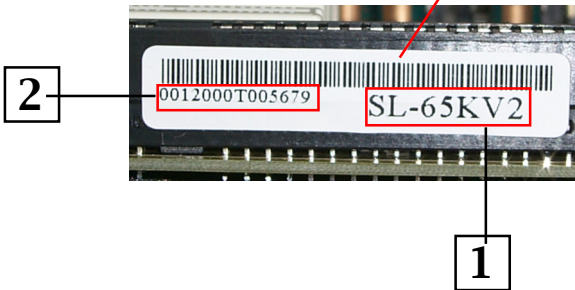
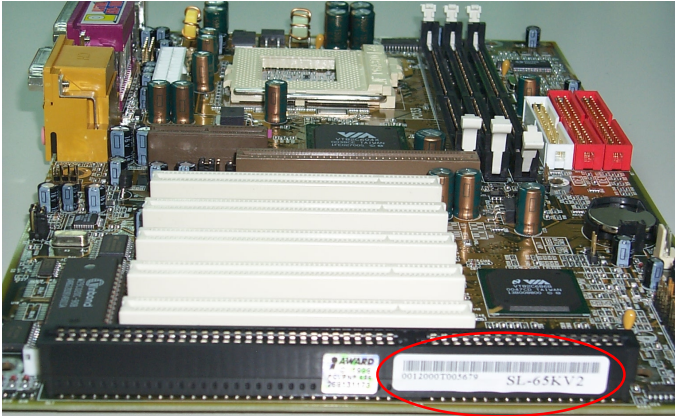

Figure 2

1. BIOS VERSION example: REV T2.1
2. BIOS ID STRING example: 6A69RSNCC

APPENDIX-3 IDENTIFYING MAINBOARD \ MODEL NUMBER

Usually the mainboard model number is labeled on the side of ISA slot or PCI slot, please see the picture shown below:



1. MAINBOARD MODEL NUMBER
example: SL-65KV2
2. MAINBOARD SERIAL NUMBER
example: 0012000T005679

