

MSI

845 Ultra-C
MS-6566 (v1.X) ATX Mainboard

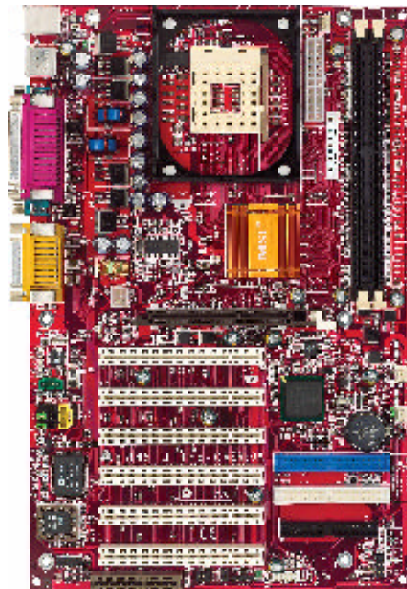

Version 1.0
G52-MA00498

ManualRev: 1.0
Release Date: Dec. 2001



FCC-B Radio Frequency Interference Statement

This equipment has been tested and found to comply with the limits for a class B digital device, pursuant to part 15 of the FCC rules. These limits are designed to provide reasonable protection against harmful interference when the equipment is operated in a commercial environment. This equipment generates, uses and can radiate radio frequency energy and, if not installed and used in accordance with the instruction manual, may cause harmful interference to radio communications. Operation of this equipment in a residential area is likely to cause harmful interference, in which case the user will be required to correct the interference at his own expense.

Notice 1

The changes or modifications not expressly approved by the party responsible for compliance could void the user's authority to operate the equipment.

Notice 2

Shielded interface cables and A.C. power cord, if any, must be used in order to comply with the emission limits.

VOIRLANOTICE D' INSTALLATIONAVANTDERACCORDERAURESEAU.

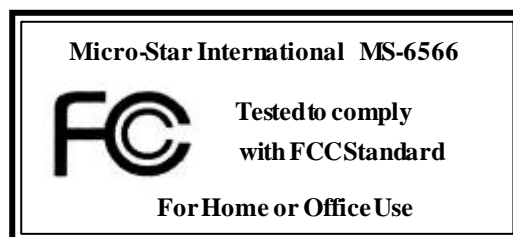

Edition

Dec. 2001

Copyright Notice

The material in this document is the intellectual property of **MICRO-STAR INTERNATIONAL**. We take every care in the preparation of this document, but no guarantee is given as to the correctness of its contents. Our products are under continual improvement and we reserve the right to make changes without notice.

Trademarks

All trademarks are the properties of their respective owners.

Intel® and Pentium® are registered trademarks of Intel Corporation.

PS/2 and OS/2 are registered trademarks of International Business Machines Corporation.

Windows® 95/98/2000/NT/XP are registered trademarks of Microsoft Corporation.

Netware® is a registered trademark of Novell, Inc.

Award® is a registered trademark of Phoenix Technologies Ltd.

AMI® is a registered trademark of American Megatrends Inc.

Revision History

Revision	Revision History	Date
V1.0	First release	Dec. 2001

Safety Instructions

1. Read the safety instructions carefully.
2. Save this User's Guide for possible use later.
3. Keep this equipment away from humidity.
4. Lay this equipment on a stable and flat surface before setting it up.
5. The openings on the enclosure are used for air convection and to prevent the equipment from overheating. Note: Do not cover the openings.
6. Make sure that the power voltage is within its safety range and has been adjusted properly to the value of 110/220V before connecting the equipment to the power inlet.
7. Place the powercord in a way that people are unlikely to step on it. Do not place anything on the power cord.
8. Always unplug the powercord before inserting any add-on card or module.
9. All cautions and warnings on the equipment should be noted.
10. Never pour any liquid into the opening that could damage the equipment or cause an electrical shock.
11. If any of the following situations arises, get the equipment checked by a service personnel:
 - the powercord or plug is damaged
 - liquid has penetrated into the equipment
 - the equipment has been exposed to moisture
 - the equipment has not work well or you can not get it work according to User's Guide
 - the equipment was dropped and damaged
 - the equipment has obvious signs of breakage
12. Do not leave the equipment in an unconditioned environment with a storage temperature of 60° C (140°F) or above, which may damage the equipment.



CAUTION: To prevent explosion caused by improper battery replacement, use the same or equivalent type of battery recommended by the manufacturer only.

CONTENTS

Chapter 1. Getting Started	1-1
Mainboard Specification	1-2
Mainboard Layout	1-4
Quick Components Guide	1-5
MSI Special Features	1-6
Fuzzy Logic™II	1-6
PC Alert™II	1-7
D-Bracket™.....	1-8
Live BIOS™Live Driver™.....	1-10
Chapter 2. Hardware Setup	2-1
Central Processing Unit: CPU	2-2
CPU Installation Procedures	2-2
Installing the CPU Fan	2-3
CPU Core Speed Derivation Procedure	2-4
Memory	2-5
Introduction to DDR SDRAM	2-5
DDR Module Combination	2-6
Installing DDR Modules	2-6
Power Supply	2-7
ATX 20-Pin Power Connector: JW1	2-7
ATX 12V Power Connector: JPW1	2-7
Back Panel	2-8
Mouse Connector: JKBMS1	2-8
Keyboard Connector: JKBMS1	2-9
USB Connectors	2-9
Serial Port Connector: COM A & COM B	2-10
Joystick/Midi Connectors	2-10

Audio Port Connectors	2-10
Parallel Port Connector: LPT1	2-11
Connectors	2-12
Floppy Disk Drive Connector: FDD1	2-12
IrDA Infrared Module Header: JIR1	2-12
Hard Disk Connectors: IDE1 & IDE2	2-13
CD-In Connector: JCD1	2-14
Aux Line-In Connector: JAUX1	2-14
Modem-In Connector: JMD1	2-14
Fan Power Connectors: CFAN1/SFAN1	2-15
Wake On Ring Connector: JWR1	2-16
PowerSaving Switch Connector: JGS1	2-16
Front Panel Connector: JFP1 & JFP2	2-17
Front Panel Audio Connector: JAUD1	2-18
Front USB Connectors: JUSB1	2-19
D-Bracket™ Connector: JDB1	2-20
Jumpers	2-21
Clear CMOS Jumper: JBAT1	2-21
Slots	2-22
AGP (Accelerated Graphics Port) Slot	2-22
PCI Slots	2-23
CNR (Communication Network Riser)	2-23
PCI Interrupt Request Routing	2-24
Chapter 3. AMI BIOS Setup	3-1
Entering Setup	3-2
Selecting the First Boot Device	3-2
Control Keys	3-3
Getting Help	3-3

The Main Menu	3-4
Standard CMOS Features	3-6
Advanced BIOS Features	3-8
Advanced Chipset Features	3-12
Power Management Setup	3-14
PNP/PCI Configurations	3-17
Integrated Peripherals	3-19
Hardware Monitor Setup	3-22
Load High Performance/BIOS Setup Defaults	3-24
Supervisor/User Password	3-25
IDE HDD AUTO Detection	3-27
Appendix A: MSI SmartKey	A-1
Installing MSI Smart Key	A-2
Using MSI Smart Key	A-3
Glossary	G-1

Getting Started

1

Thank you for purchasing the MS-6566 v1.X ATX mainboard. The MS-6566 v1.X is based on Intel® 845D & ICH2 chipsets for optimal system efficiency. Designed to fit the advanced Intel® Pentium® 4 processors in the 478 pin package, the MS-6566 delivers a high performance and professional desktop platform solution.

TOPICS

<i>Mainboard Specification</i>	<i>1-2</i>
<i>Mainboard Layout</i>	<i>1-4</i>
<i>Quick Components Guide</i>	<i>1-5</i>
<i>MSI Special Features</i>	<i>1-6</i>

Mainboard Specification

CPU

- Support Intel® Pentium® 4 processor in 478 pin package
- Support 1.3GHz, 1.4GHz, 1.5GHz, 1.6GHz, 1.7GHz, 1.8GHz, 1.9GHz, 2GHz, 2.2GHz and up* (* not tested yet)

Chipset

- Intel® 845 chipset (593 FC-BGA)
 - AGP 4x slot (1.5V only)
 - Support 100MHz FSB
 - Support 400MHz Intel NetBurst micro-architecture bus
- Intel® ICH2 chipset (360 EBGA)
 - AC'97 Controller Integrated
 - 2 full IDE channels, up to ATA 100
 - Low pin count interface for SIO

Main Memory

- Support two 184-pin DDR DIMM slots
- Support up to 2 GB memory size

Slots

- One AGP (Accelerated Graphics Port) 4x slot (1.5V only)
- Six PCI 2.2v 32-bit Master PCI bus slots
- One CNR (Communication Network Riser) slot

On-Board IDE

- An IDE controller on the ICH2 chipset provides IDE HDD/CD-ROM with PIO, Bus Master and Ultra DMA66/100 operation modes
- Can connect up to four IDE devices.



Note: The AGP slot **DOES NOT support 3.3V AGP card**. Use of 3.3V AGP card may cause damage to the mainboard.

On-Board Peripherals

● On-board Peripherals include:

- 1 floppy port supports 2 FDD with 360K, 720K, 1.2M, 1.44M and 2.88Mbytes
- 2 serial ports (COM 1 + COM 2)
- 1 parallel port supports SPP/EPP/ECP mode
- 4 USB ports (Rear x 2/ Front x 2)
- 1 Line-In/Line-Out/Mic-In/Game port

Audio

- ICH2 chip integrated
- AC'97 codec supports 2 channel Audio

BIOS

- The mainboard BIOS provides “Plug & Play” function which detects the peripherals devices and expansion cards of the board automatically
- The mainboard provides a Desktop Management Interface (DMI) function which records your mainboard specifications

Dimension

- ATX Form Factor 30.5cm x 20cm

Mounting

- 6 mounting holes

Others

- Vcore/Vio adjustable
- LAN/Modem Wake-up function
- ACPI support, including STR/STD
- PC 2001 compliant

Mainboard Layout

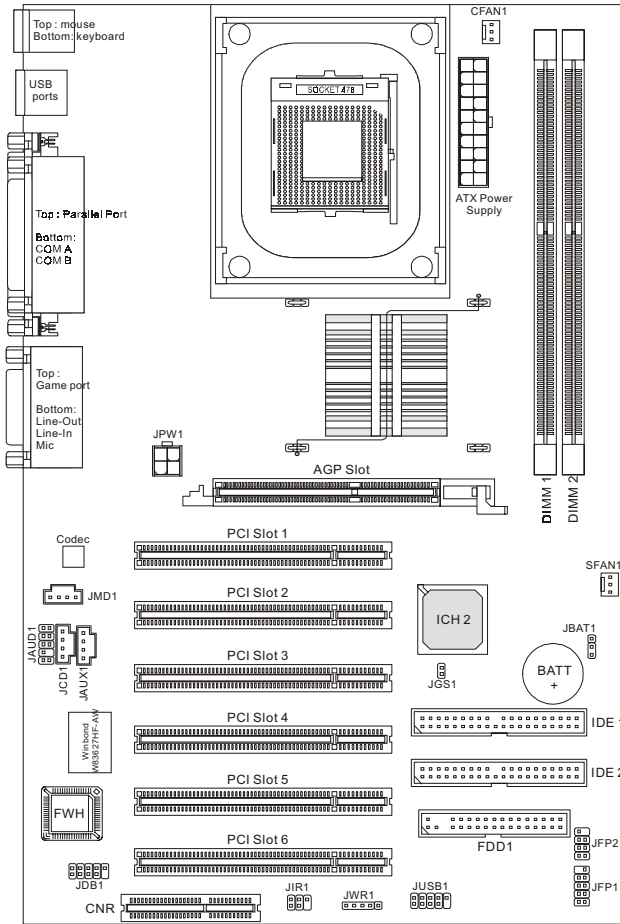

845 Ultra-C (MS-6566 v1.X) ATX Mainboard

Quick Components Guide

Component	Function	Reference
JW1	ATX 20-pin power connector	See p. 2-7
JPW1	ATX 12V power connector	See p. 2-7
JKBMS1	Mouse connector	See p. 2-8
JKBMS1	Keyboard connector	See p. 2-9
USB Connectors	Connecting to USB devices	See p. 2-9
COM A & COM B	Serial port connector	See p. 2-10
LPT1	Parallel port connector	See p. 2-11
FDD1	Floppy disk drive connector	See p. 2-12
JIR1	IrDA infrared module connector	See p. 2-12
IDE1~ IDE2	Hard disk connectors	See p. 2-13
JCD1	CD-in connector	See p. 2-14
JAUX1	Aux line-in connector	See p. 2-14
JMD1	Modem-in connector	See p. 2-14
CFAN1/SFAN1	Fan power connectors	See p. 2-15
JWR1	Wake on ring connector	See p. 2-16
JGS1	Power Saving Switch	See p. 2-16
JFP1/JFP2	Front panel connectors	See p. 2-17
JAUD1	Front panel audio connector	See p. 2-18
JUSB1	Front USB connector	See p. 2-19
JDB1	D-Bracket connector	See p. 2-20
JBAT1	Clear CMOS jumper	See p. 2-21
AGP Slot	Connecting to AGP card	See p. 2-22
PCI Slots	Connecting to expansion cards	See p. 2-23
CNR Slot	Connecting to expansion card	See p. 2-23

MSI Special Features

Fuzzy Logic™ III

The Fuzzy Logic™ III utility allows users to overclock the CPU FSB (Front Side Bus) frequency in the Windows environment. Select the CPU frequency you prefer and click *Go* to apply the frequency or click *Save* allowing the system to run at the specified frequency each time when the system is powered on.

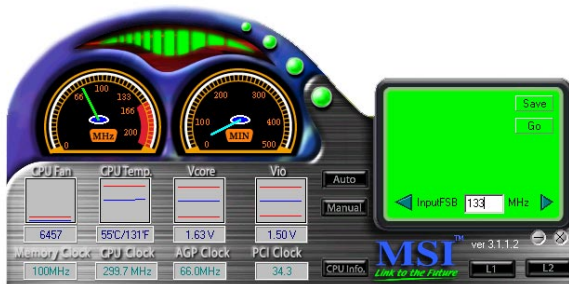

Features:

- Display Current System Status
 - CPU Fan
 - CPU Temp.
 - Vcore
 - Vio
 - Memory Clock
 - CPU Clock
 - AGP Clock
 - PCI Clock
- Adjust CPU FSB Frequency

PC Alert™ III

The PC Alert™ III is a utility you can find in the CD-ROM disk. The utility is just like your PC doctor that can detect the following PC hardware status during real time operation:

- * monitor CPU & system temperatures
- * monitor fan speed(s)
- * monitor system voltage
- * monitor chassis intrusion



If one of the items above is abnormal, the program main screen will be immediately shown on the screen, with the abnormal item highlighted in red. This will continue to be shown until users disable the warning.

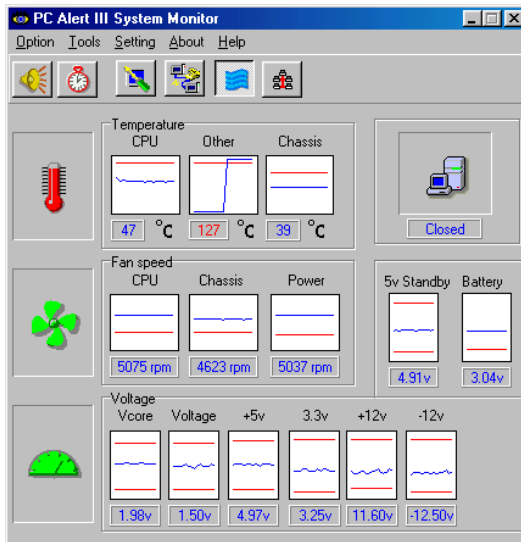

Note: Items shown on PC Alert III vary depending on your system's status.

D-Bracket™ (optional)





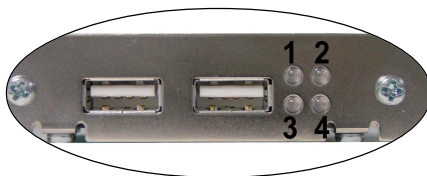



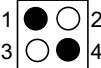

D-Bracket™ is an external USB bracket integrating four Diagnostic LEDs, which use graphic signal display to help users understand their system. The LEDs provide up to 16 combinations of signals to debug the system. The 4 LEDs can debug all problems that fail the system, such as VGA, RAM or other failures. This special feature is very useful for the overclocking users. These users can use the feature to detect if there are any problems or failures.

D-Bracket™



● Red ○ Green

D-Bracket	Description
	System Power ON - The D-LED will hang here if the processor is damaged or not installed properly.
	Early Chipset Initialization
	Memory Detection Test - Testing onboard memory size. The D-LED will hang if the memory module is damaged or not installed properly.
	Decompressing BIOS image to RAM for fast booting.
	Initializing Keyboard Controller.
	Testing VGA BIOS - This will start writing VGA sign-on message to the screen.

D-Bracket	Description
	<p>Processor Initialization</p> <p>- This will show information regarding the processor (like brand name, system bus, etc...)</p>
	<p>Testing RTC (Real Time Clock)</p>
	<p>Initializing Video Interface</p> <p>- This will start detecting CPU clock, checking type of video onboard. Then, detect and initialize the video adapter.</p>
	<p>BIOS Sign On</p> <p>- This will start showing information about logo, processor brand name, etc....</p>
	<p>Testing Base and Extended Memory</p> <p>- Testing base memory from 240K to 640K and extended memory above 1MB using various patterns.</p>
	<p>Assign Resources to all ISA.</p>
	<p>Initializing Hard Drive Controller</p> <p>- This will initialize IDE drive and controller.</p>
	<p>Initializing Floppy Drive Controller</p> <p>- This will initializing Floppy Drive and controller.</p>
	<p>Boot Attempt</p> <p>- This will set low stack and boot via INT 19h.</p>
	<p>Operating System Booting</p>

Live BIOS™/Live Driver™

The Live BIOS™ & Live Driver™ is a tool used to detect and update your BIOS and drivers online so that you don't need to search for the correct BIOS or drivers version through the whole web site. To use the function, you need to install the "MSI Live Update Series" application. After installation, the "MSI Live Update Series" icon (as the right view) will appear on the screen.



Double click the "MSI Live Update Series" icon, and the following screen will appear.



Four buttons are placed on the left column of the screen. Click the desired button to start the update process.

- **Live BIOS** – Updates the BIOS online. If your motherboard does not support the function, the "sorry" message is displayed.
- **Live Driver** – Updates the drivers online. If your motherboard does not support the function, the "sorry" message is displayed.
- **Live VGA BIOS** – Updates the VGA BIOS online. If your VGA device does not support the function, the "sorry" message appears.
- **Live VGA Driver** – Updates the VGA driver online. If your VGA device does not support the function, the "sorry" message is displayed.

For more information on the update instructions, insert the companion CD and refer to the "Live Update Series Guide" under the "Manual" tab.

Hardware Setup

2

This chapter provides you with the information about hardware setup procedures. While doing the installation, be careful in holding the components and follow the installation procedures. For some components, if you install in the wrong orientation, the components will not work properly.

Use a grounded wrist strap before handling computer components. Static electricity may damage the components.

TOPICS

<i>Central Processing Unit: CPU</i>	2-2
<i>Memory</i>	2-5
<i>Power Supply</i>	2-7
<i>Back Panel</i>	2-8
<i>Connectors</i>	2-12
<i>Jumpers</i>	2-21
<i>Slots</i>	2-22

Central Processing Unit: CPU

The mainboard supports Intel® Pentium® 4 processor in the 478 pin package. The mainboard uses a CPU socket called PGA478 for easy CPU installation. When you are installing the CPU, **make sure the CPU has a heat sink and a cooling fan attached on the top to prevent overheating.** If you do not find the heat sink and cooling fan, contact your dealer to purchase and install them before turning on the computer.

CPU Installation Procedures

1. Pull the lever sideways away from the socket. Then, raise the lever up to a 90-degree angle.
2. Look for the gold arrow. The gold arrow should point towards the lever pivot. The CPU will only fit in the correct orientation.
3. Hold the CPU down firmly, and then close the lever to complete the installation.

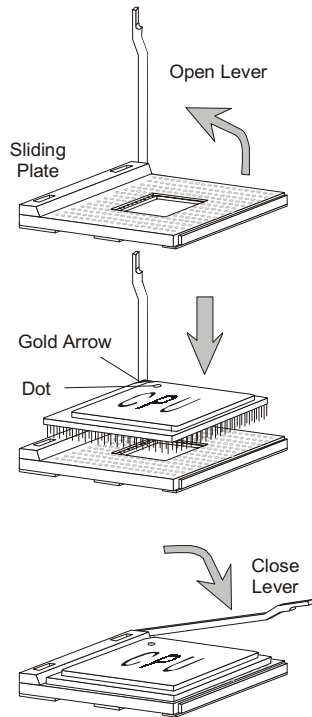

WARNING!

Overheating will seriously damage the CPU and system, always make sure the cooling fan can work properly to protect the CPU from overheating.

Installing the CPU Fan

As processor technology pushes to faster speeds and higher performance, thermal management becomes increasingly important. To dissipate heat, you need to attach the CPU cooling fan and heatsink on top of the CPU. Follow the instructions below to install the Heatsink/Fan:

1. Locate the CPU and its retention mechanism on the motherboard.
2. Position the heatsink onto the retention mechanism.

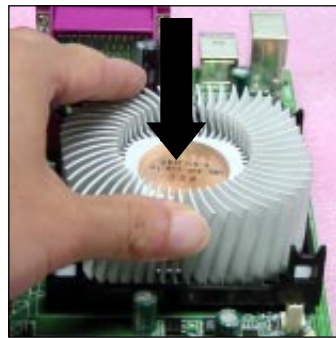
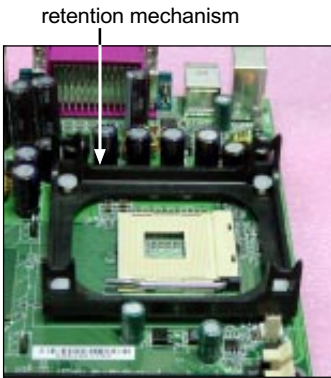

3. Mount the fan on top of the heatsink. Press down the fan until its four clips get wedged in the holes of the retention mechanism.
4. Press the two levers down to fasten the fan. Each lever can be pressed down in only ONE direction.

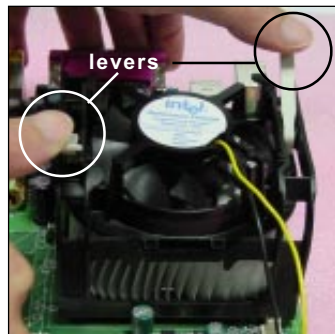
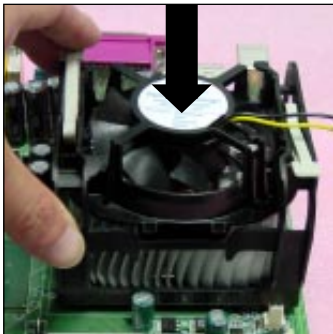

5. Connect the fan power cable from the mounted fan to the 3-pin fan power connector on the board.

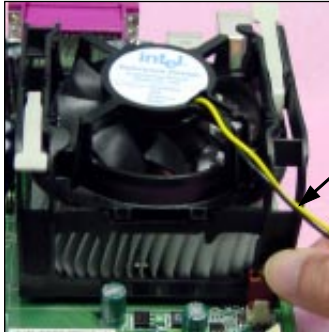

fan power cable

CPU Core Speed Derivation Procedure

If CPU Clock = 100MHz
Core/Bus ratio = 14
then CPU core speed = Host Clock x Core/Bus ratio
= 100MHz x 14
= 1.4GHz



Overclocking

This motherboard is designed to support overclocking. However, please make sure your components are able to tolerate such abnormal setting, while doing overclocking. Any attempt to operate beyond product specifications is not recommended. We do not guarantee the damages or risks caused by inadequate operation or beyond product specifications.

Memory

The mainboard provides 2 slots for 184-pin, 2.5V unbuffered DDR DIMM with 4 memory banks. You can install PC1600/PC2100 DDR SDRAM modules on the DDR DIMM slots (DDR 1~2). To operate properly, at least one DIMM module must be installed.

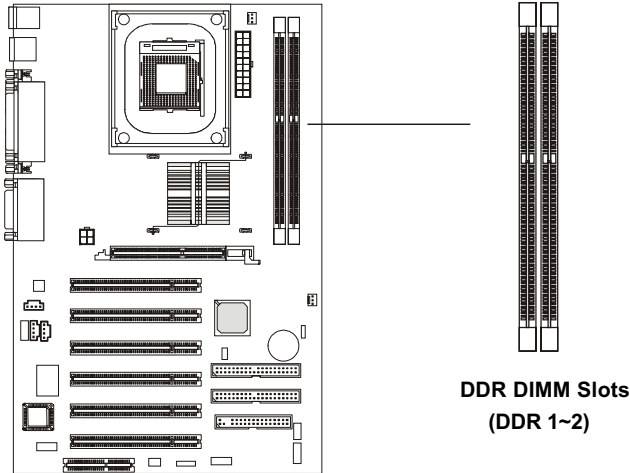

Introduction to DDR SDRAM

DDR (Double Data Rate) SDRAM is similar to conventional SDRAM, but doubles the rate by transferring data twice per cycle. It uses 2.5 volts as opposed to 3.3 volts used in SDR SDRAM, and requires 184-pin DIMM modules rather than 168-pin DIMM modules used by SDR SDRAM. High memory bandwidth makes DDR an ideal solution for high performance PC, workstations and servers.

DDR Module Combination

You can install either single-sided or double-sided 184-pin DDR DIMM modules into DDR DIMM slots to meet your needs. Different from the SDR DIMM, the DDR DIMM has only one notch on the center of module. The number of pins on either side of the breaks are different. The module will only fit in the right orientation.

You can install memory modules in any combination as follows:

Slot	Momory Module	Total Memory
Slot 1 (Bank 0 & 1)	64MB, 128MB, 256MB, 512MB, 1GB	64MB~1GB
Slot 2 (Bank 2 & 3)	64MB, 128MB, 256MB, 512MB, 1GB	64MB~1GB
Maximum System Memory Supported		64MB~2GB

Installing DDR Modules

1. The DDR DIMM has only one notch on the center of module. The module will only fit in the right orientation.
2. Insert the DIMM memory module vertically into the DIMM slot. Then push it in.

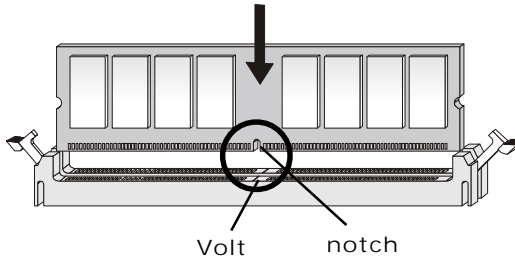

3. The plastic clip at each side of the DIMM slot will automatically close.

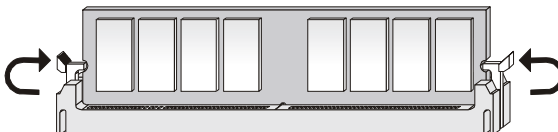

Power Supply

The mainboard supports ATX power supply for the power system. Before inserting the power supply connector, always make sure that all components are installed properly to ensure that no damage will be caused.

ATX 20-Pin Power Connector: JW1

This connector allows you to connect to an ATX power supply. To connect to the ATX power supply, make sure the plugs of the power supply is inserted in the proper orientation and the pins are aligned. Then push down the power supply firmly into the connector. The power connector supports **instant power on** function which means that system will boot up immediately when the power supply connector is inserted on the board.

ATX 12V Power Connector: JPW1

This 12V power connector is used to provide power to the CPU.

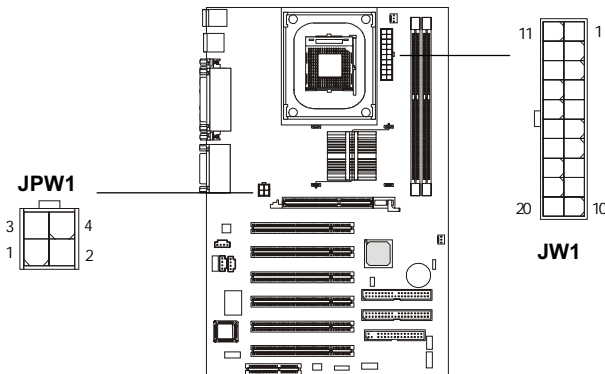

JPW1 Pin Definition

PIN	SIGNAL
1	GND
2	GND
3	12V
4	12V

JW1 Pin Definition

PIN	SIGNAL	PIN	SIGNAL
1	3.3V	11	3.3V
2	3.3V	12	-12V
3	GND	13	GND
4	5V	14	PS_ON
5	GND	15	GND
6	5V	16	GND
7	GND	17	GND
8	PW_OK	18	-5V
9	5V_SB	19	5V
10	12V	20	5V

Back Panel

The Back Panel provides the following connectors:

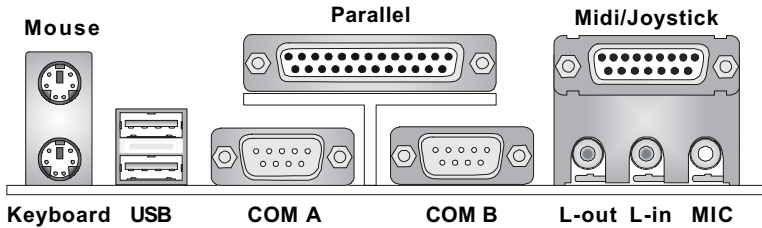

Mouse Connector: JKBMS1

The mainboard provides a standard PS/2[®] mouse mini DIN connector for attaching a PS/2[®] mouse. You can plug a PS/2[®] mouse directly into this connector. The connector location and pin assignments are as follows:

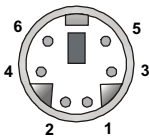

PS/2 Mouse (6-pin Female)

Pin Definition

PIN	SIGNAL	DESCRIPTION
1	Mouse DATA	Mouse DATA
2	NC	No connection
3	GND	Ground
4	VCC	+5V
5	Mouse Clock	Mouse clock
6	NC	No connection

Keyboard Connector: JKBMS1

The mainboard provides a standard PS/2[®] keyboard mini DIN connector for attaching a PS/2[®] keyboard. You can plug a PS/2[®] keyboard directly into this connector.

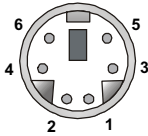

PS/2 Keyboard (6-pin Female)

Pin Definition

PIN	SIGNAL	DESCRIPTION
1	Keyboard DATA	Keyboard DATA
2	NC	No connection
3	GND	Ground
4	VCC	+5V
5	Keyboard Clock	Keyboard clock
6	NC	No connection

USB Connectors

The mainboard provides a UHCI (Universal Host Controller Interface) Universal Serial Bus root for attaching USB devices such as keyboard, mouse or other USB-compatible devices. You can plug the USB device directly into this connector.

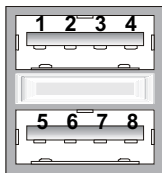

USB Ports

USB Port Description

PIN	SIGNAL	DESCRIPTION
1	VCC	+5V
2	-Data 0	Negative Data Channel 0
3	+Data 0	Positive Data Channel 0
4	GND	Ground
5	VCC	+5V
6	-Data 1	Negative Data Channel 1
7	+Data 1	Positive Data Channel 1
8	GND	Ground

Serial Port Connector: COM A & COM B

The mainboard offers two 9-pin male DIN connectors as serial ports COM A and COM B. The ports are 16550A high speed communication ports that send/receive 16 bytes FIFOs. You can attach a serial mouse or other serial devices directly to them.

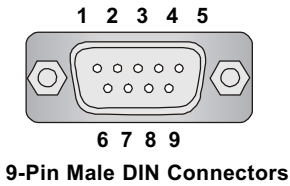

Pin Definition

PIN	SIGNAL	DESCRIPTION
1	DCD	Data Carry Detect
2	SIN	Serial In or Receive Data
3	SOUT	Serial Out or Transmit Data
4	DTR	Data Terminal Ready)
5	GND	Ground
6	DSR	Data Set Ready
7	RTS	Request To Send
8	CTS	Clear To Send
9	RI	Ring Indicate

Joystick/Midi Connectors

You can connect a joystick or game pad to this connector.

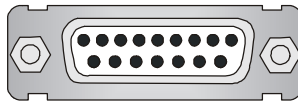

Audio Port Connectors

Line Out is a connector for Speakers or Headphones. **Line In** is used for external CD player, Tape player, or other audio devices. **Mic** is a connector for microphones.

1/8" Stereo Audio Connectors

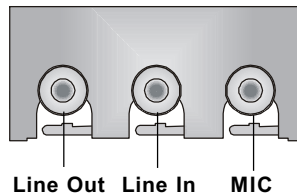

Parallel Port Connector: LPT1

The mainboard provides a 25-pin female centronic connector for LPT. A parallel port is a standard printer port that supports Enhanced Parallel Port (EPP) and Extended Capabilities Parallel Port (ECP) mode.

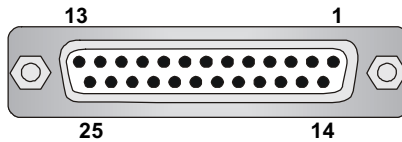

Pin Definition

PIN	SIGNAL	DESCRIPTION
1	STROBE	Strobe
2	DATA0	Data0
3	DATA1	Data1
4	DATA2	Data2
5	DATA3	Data3
6	DATA4	Data4
7	DATA5	Data5
8	DATA6	Data6
9	DATA7	Data7
10	ACK#	Acknowledge
11	BUSY	Busy
12	PE	PaperEnd
13	SELECT	Select
14	AUTO FEED#	AutomaticFeed
15	ERR#	Error
16	INIT#	Initialize Printer
17	SLIN#	Select In
18	GND	Ground
19	GND	Ground
20	GND	Ground
21	GND	Ground
22	GND	Ground
23	GND	Ground
24	GND	Ground
25	GND	Ground

Connectors

The mainboard provides connectors to connect to FDD, IDE HDD, case, modem, LAN, USB Ports, IR module and CPU/System FAN.

Floppy Disk Drive Connector: FDD1

The mainboard provides a standard floppy disk drive connector that supports 360K, 720K, 1.2M, 1.44M and 2.88M floppy disk types.

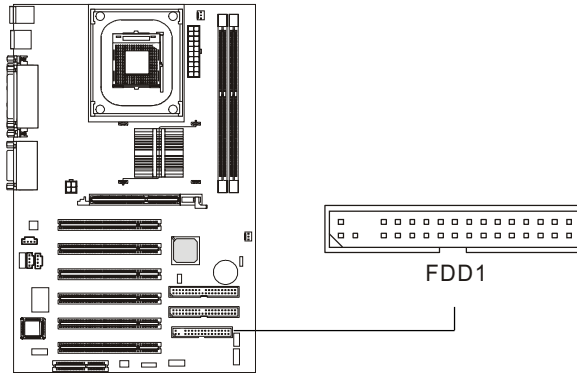

IrDA Infrared Module Header: JIR1

This connector allows you to connect to IrDA Infrared modules. You must configure the setting through the BIOS setup to use the IR function. The JIR1 is compliant to Intel Front Panel I/O Connectivity Design Guide.

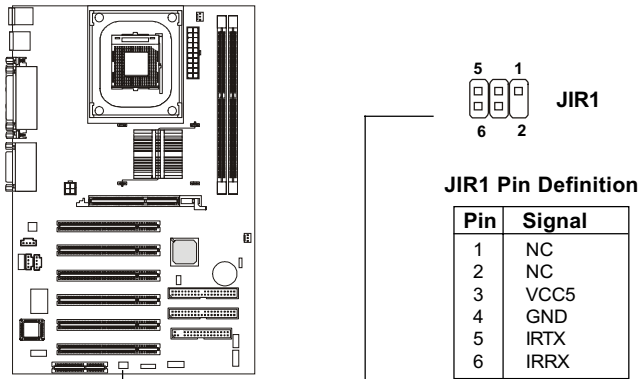

Hard Disk Connectors: IDE1 & IDE2

The mainboard has a 32-bit Enhanced PCI IDE and Ultra DMA 33/66/100 controller that provides PIO mode 0~4, Bus Master, and Ultra DMA/33/66/100 function. You can connect up to four hard disk drives, CD-ROM, 120MB Floppy (reserved for future BIOS) and other devices. These connectors support the provided IDE hard disk cable.

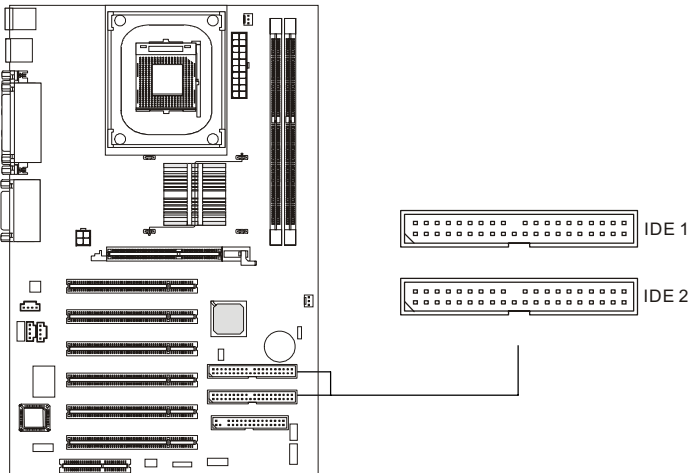

IDE1 (Primary IDE Connector)

The first hard drive should always be connected to IDE1. IDE1 can connect a Master and a Slave drive. You must configure second hard drive to Slave mode by setting the jumper accordingly.

IDE2 (Secondary IDE Connector)

IDE2 can also connect a Master and a Slave drive.



TIP:

If you install two hard disks on cable, you must configure the second drive to Slave mode by setting its jumper. Refer to the hard disk documentation supplied by hard disk vendors for jumper setting instructions.

CD-In Connector: JCD1

The connector is for CD-ROM audio connector.

Aux Line-In Connector: JAUX1

The connector is for DVD add-on card with Line-in connector.

Modem-In Connector: JMD1

The connector is for modem with internal audio connector.

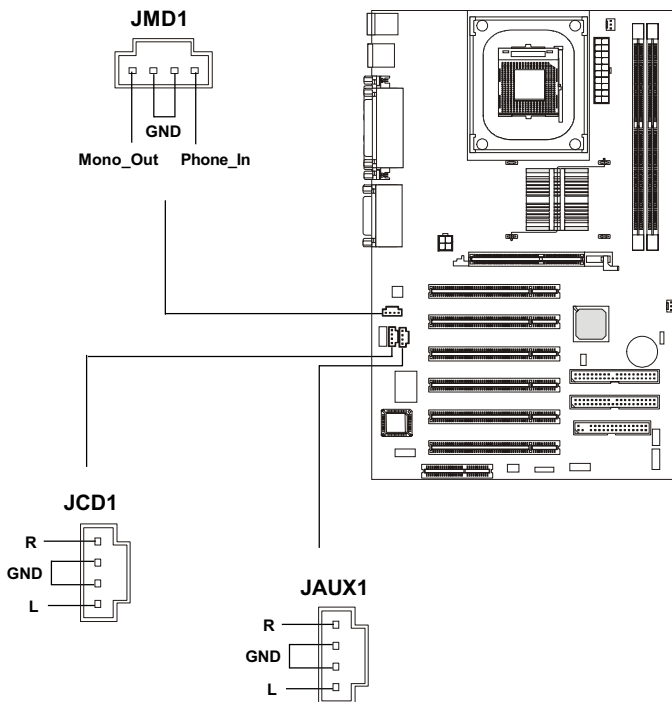

Fan Power Connectors: CFAN1/SFAN1

The CFAN1 (processor fan) and SFAN1 (system fan) support system cooling fan with +12V. It supports three-pin head connector. When connecting the wire to the connectors, always take note that the red wire is the positive and should be connected to the +12V, the black wire is Ground and should be connected to GND. If the mainboard has a System Hardware Monitor chipset on-board, you must use a specially designed fan with speed sensor to take advantage of the CPU fan control.

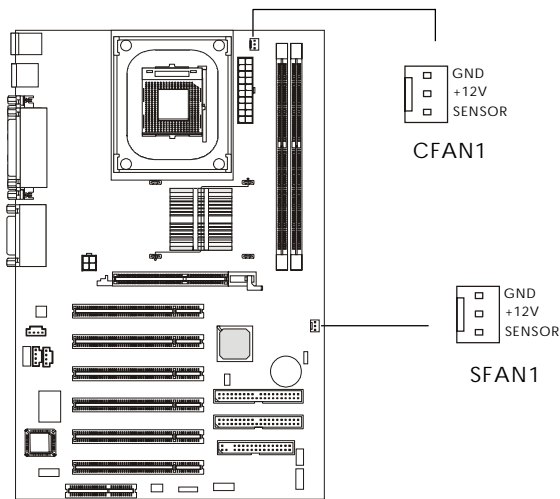

Note:

1. Always consult the vendor for proper CPU cooling fan.
2. CPU Fan supports the fan control. You can install the PC Alert utility that will automatically control the CPU Fan speed according to the actual CPU temperature.

Wake On Ring Connector: JWR1

This connector allows you to connect to a modem card with Wake On Ring function. The connector will power up the system when a signal is received through the modem card.

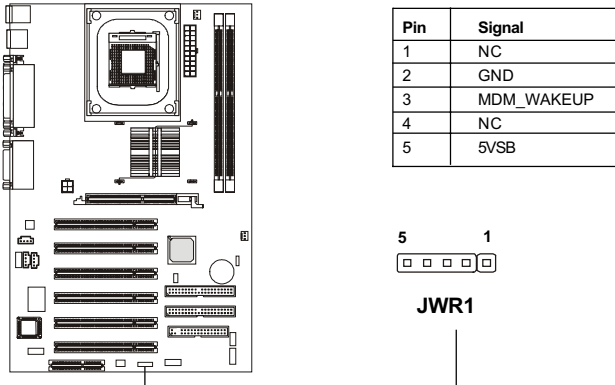

Power Saving Switch Connector: JGS1

Attach a power saving switch to this connector. Pressing the switch once will have the system enter the sleep/suspend state. Press any key to wake up the system.

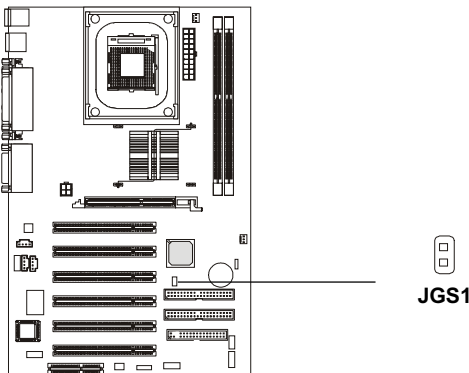

Front Panel Connector: JFP1 & JFP2

The mainboard provides two front panel connectors for establishing electrical connection to the front panel switches and LEDs. Users can choose either JFP1 or JFP2. Both JFP1 and JFP2 are compliant with Intel® Front Panel I/O Connectivity Design Guide.

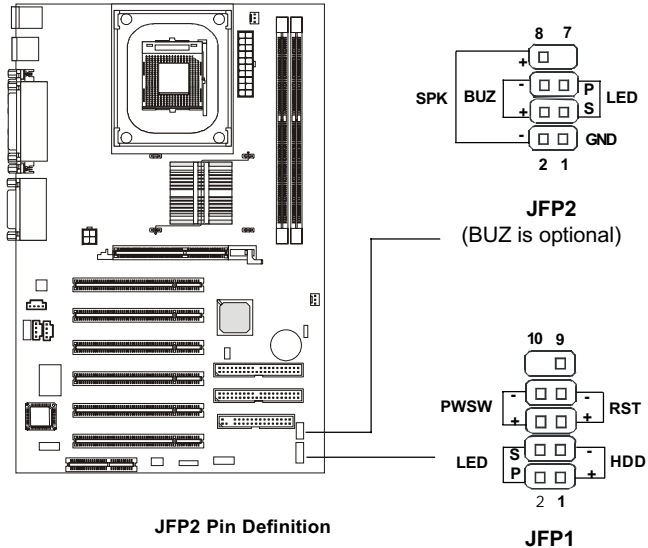

JFP2 Pin Definition

Pin	Signal	Pin	Signal
1	GND	5	PLED
2	SPK-	6	BUZ-
3	BUZ+	7	NC
4	SPK+	8	SPK+

JFP1 Switch/LED Front Panel Electrical Connection

PIN	SIGNAL	DESCRIPTION
1	HD_LED_P	Hard disk LED pull-up to +5V
2	FP_PWR/SLP	MSG LED pull-up to +5V
3	HD_LED_N	Hard disk active LED
4	FP_PWR/SLP	MSG LED pull-up to +5V
5	RST_SW_N	Reset Switch low reference pull-down to GND
6	PWR_SW_P	Power Switch high reference pull-up to +5V
7	RST_SW_P	Reset Switch high reference pull-up to +5V
8	PWR_SW_N	Power Switch low reference pull-down to GND
9	RSVD_DNU	Reserved. Do not use.

Front Panel Audio Connector: JAUD1

You can connect an optional audio connector to the JAUD1 front panel audio connector. The JAUD1 is compliant to Intel® Front Panel I/O Connectivity Design Guide.

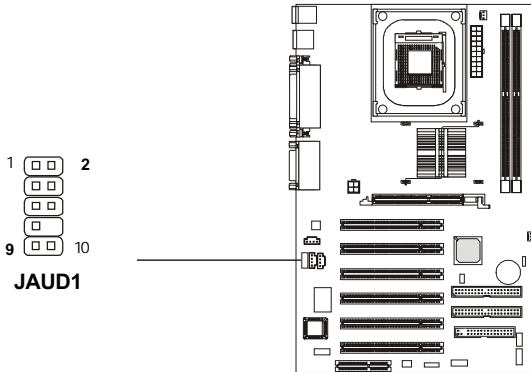

Pin Definition

PIN	SIGNAL	DESCRIPTION
1	AUD_MIC	Front panel microphone input signal
2	AUD_GND	Ground used by analog audio circuits
3	AUD_MIC_BIAS	Microphone power
4	AUD_VCC	Filtered +5V used by analog audio circuits
5	AUD_FPOUT_R	Right channel audio signal to front panel
6	AUD_RET_R	Right channel audio signal return from front panel
7	HP_ON	Reserved for future use to control headphone amplifier
8	KEY	No pin
9	AUD_FPOUT_L	Left channel audio signal to front panel
10	AUD_RET_L	Left channel audio signal return from front panel



CAUTION!!!

If you don't want to connect to the front audio header, pins 5 and 6, 9 and 10 have to be shorted by jumper caps in order to have signal output directed to the rear audio ports.

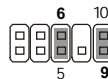

Front USB Connector: JUSB1

The mainboard provides a front Universal Serial Bus connector for you to connect to USB devices. The JUSB1 connector is compliant with Intel® Front Panel I/O Connectivity Design Guide.

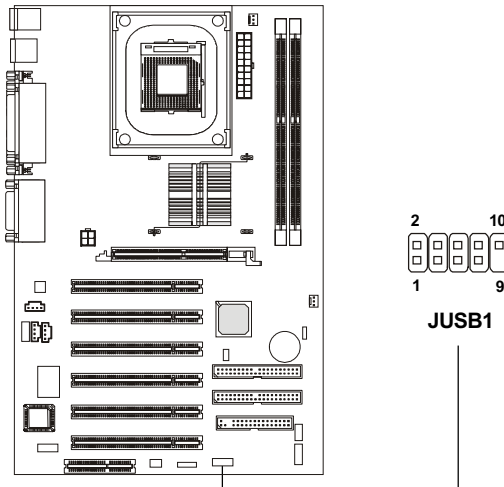

JUSB1 Pin Definition

Pin	Description	Pin	Description
1	USBPWR	2	USBPWR
3	USBP0-	4	USBP1-
5	USBP0+	6	USBP1+
7	GND	8	GND
9	NC	10	USBOC

D-Bracket™ Connector: JDB1

The mainboard comes with a JDB1 connector for you to connect to D-Bracket™. D-Bracket™ is a USB Bracket integrating four LEDs and allows users to identify system problem through 16 various combinations of LED signals. For definitions of 16 signal combinations, please refer to *Chapter 1. D-Bracket™*.

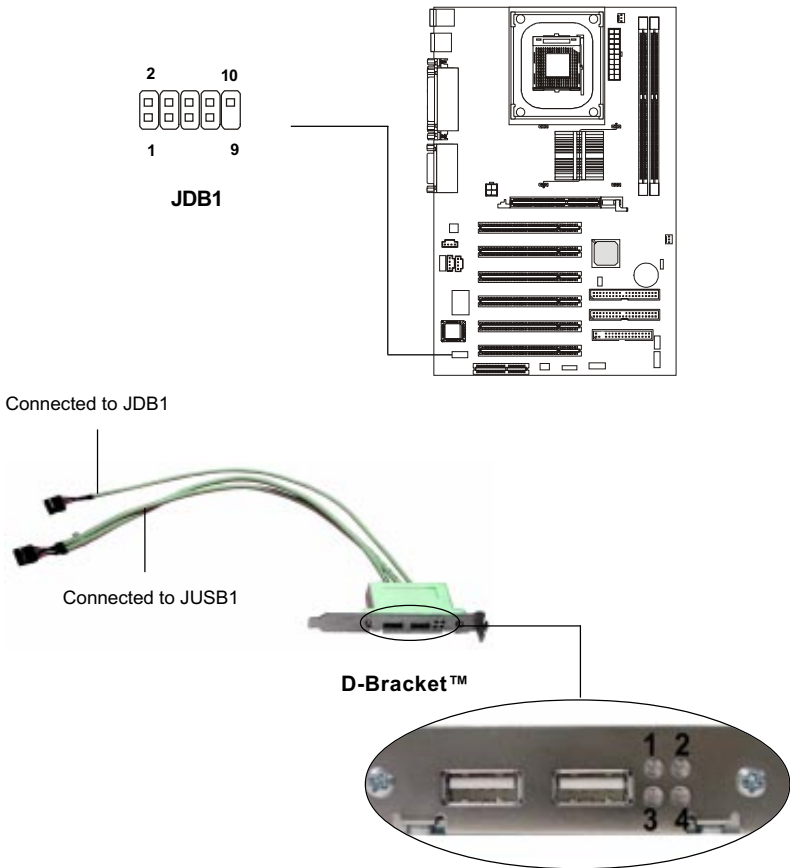

Jumpers

The motherboard provides one jumper for you to set the computer's function. This section will explain how to change your motherboard's function through the use of the jumper.

Clear CMOS Jumper: JBAT1

There is a CMOS RAM on board that has a power supply from external battery to keep the data of system configuration. With the CMOS RAM, the system can automatically boot OS every time it is turned on. That battery has long life time for at least 5 years. If you want to clear the system configuration, use the JBAT1 (Clear CMOS Jumper) to clear data. Follow the instructions below to clear the data:

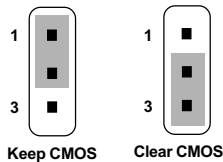
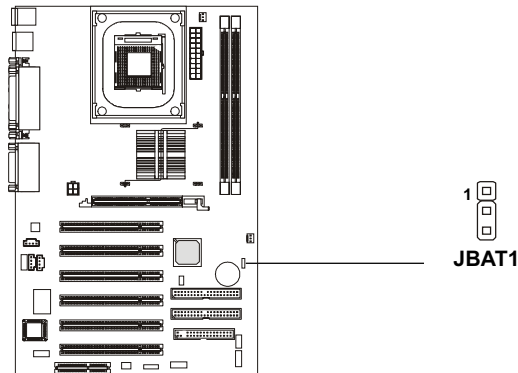

WARNING!

You can clear CMOS by shorting 2-3 pin while the system is off. Then return to 1-2 pin position. Avoid clearing the CMOS while the system is on; it will damage the mainboard.

Slots

The motherboard provides six 32-bit Master PCI bus slots, one AGP slot and one CNR slot.

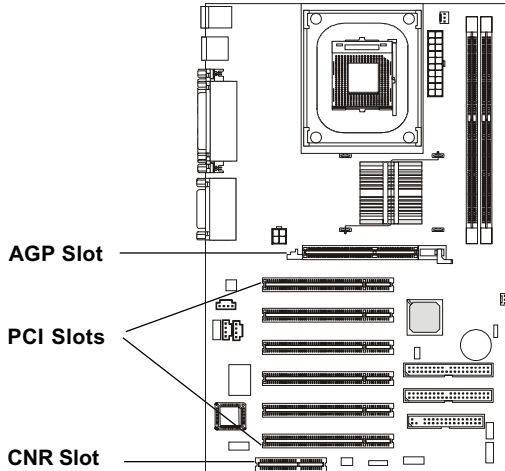

AGP (Accelerated Graphics Port) Slot

The AGP slot allows you to insert the AGP graphics card. AGP is an interface specification designed for the throughput demands of 3D graphics. It introduces a 66MHz, 32-bit channel for the graphics controller to directly access main memory and provides three levels of throughputs: 1x (266Mbps), 2x (533Mbps) and 4x (1.07Gbps).

Please note that the AGP slot does not support 3.3V AGP card. Use of 3.3V AGP card may cause damages to the mainboard. To avoid the risk of causing permanent damages to the mainboard, the AGP slot is protected with MSI electrical routing device. If users have inserted a 3.3V AGP card into the slot, the MSI routing device will disable the computer's boot-up system. Remove the 3.3V AGP card and the boot-up system will return to normal.



Attention!

DO NOT use the following AGP cards which would cause damages to the mainboard. The following list is subject to change without prior notice.

Model	AGP Chip
ATI Xpert2000	3D RAGE 128VR
ATI Rage Fury Maxx	3D RAGE 128 Pro
Diamond Monster Fusion	3DFX VooDoo Banshee
Hercules KYRO II 4500	
Leadtek Winfast VR300	SiS300
Matrox Millennium G400	G4+MDHA32G
STB 3Dfx VooDoo3 3500TV	3Dfx VooDoo 3500TV

PCI Slots

Six PCI slots allow you to insert the expansion cards to meet your needs. When adding or removing expansion cards, make sure that you unplug the power supply first. Meanwhile, read the documentation for the expansion card to make any necessary hardware or software settings for the expansion card, such as jumpers, switches or BIOS configuration.

CNR (Communication Network Riser)

The CNR slot allows you to insert the CNR expansion cards. CNR is a specially designed network, audio, or modem riser card for ATX family motherboards. Its main processing is done through software and controlled by the motherboard's chipset.

PCI Interrupt Request Routing

The IRQ, abbreviation of interrupt request line and pronounced I-R-Q, are hardware lines over which devices can send interrupt signals to the microprocessor. The PCI IRQ pins are typically connected to the PCI bus INT A# ~ INT D# pins as follows:

	Order 1	Order 2	Order 3	Order 4
PCI Slot 1	INT A#	INT B#	INT C#	INT D#
PCI Slot 2	INT B#	INT C#	INT D#	INT A#
PCI Slot 3	INT C#	INT D#	INT A#	INT B#
PCI Slot 4	INT D#	INT A#	INT B#	INT C#
PCI Slot 5	INT B#	INT C#	INT D#	INT A#
PCI Slot 6	INT A#	INT B#	INT C#	INT D#

AMI BIOS Setup **3**

This chapter provides information on the BIOS Setup program and allows you to configure the system for optimum use.

You may need to run the Setup program when:

- An error message appears on the screen during the system booting up, and requests you to run SETUP.
- You want to change the default settings for customized features.

TOPICS

<i>Entering Setup</i>	3-2
<i>The Main Menu</i>	3-4
<i>Standard CMOS Features</i>	3-6
<i>Advanced BIOS Features</i>	3-8
<i>Advanced Chipset Features</i>	3-12
<i>Power Management Setup</i>	3-14
<i>PNP/PCI Configurations</i>	3-17
<i>Integrated Peripherals</i>	3-19
<i>Hardware Monitor Setup</i>	3-22
<i>Load High Performance/BIOS Setup Defaults</i>	3-24
<i>Supervisor/User Password</i>	3-25
<i>IDE HDD AUTO Detection</i>	3-27

Chapter 3

Entering Setup

Power on the computer and the system will start POST (Power On Self Test) process. When the message below appears on the screen, press key to enter Setup.

DEL:Setup F11:Boot Menu F12:Network boot TAB:Logo

If the message disappears before you respond and you still wish to enter Setup, restart the system by turning it OFF and On or pressing the RESET button. You may also restart the system by simultaneously pressing <Ctrl>, <Alt>, and <Delete> keys.

Selecting the First Boot Device

You are allowed to select the 1st boot device without entering the BIOS setup utility by pressing <F11>. When the same message as listed above appears on the screen, press <F11> to trigger the boot menu.

The POST messages might pass by too quickly for you to respond in time. If so, restart the system and press <F11> after around 2 or 3 seconds to activate the boot menu similar to the following.

Select First Boot Device		
Floppy	:	1st Floppy
IDE-0	:	IBM-DTLA-307038
CDROM	:	ATAPI CD-ROM DRIVE 40X M
[Up/Dn] Select	[RETURN] Boot	[ESC] cancel

The boot menu will list all the bootable devices. Select the one you want to boot from by using arrow keys and then pressing <Enter>. The system will boot from the selected device. The selection will not make changes to the settings in the BIOS setup utility, so next time when you power on the system, it will still use the original first boot device to boot up.

Control Keys

<↑>	Move to the previous item
<↓>	Move to the next item
<←>	Move to the item in the left hand
<→>	Move to the item in the right hand
<Enter>	Select the item
<Esc>	Jumps to the Exit menu or returns to the main menu from a submenu
<+/PU>	Increase the numeric value or make changes
<-/PD>	Decrease the numeric value or make changes
<F5>	Restore the previous CMOS value from CMOS, only for Option Page Setup Menu
<F6>	Load High Performance Defaults
<F7>	Load BIOS Setup Defaults
<F10>	Save all the CMOS changes and exit

Getting Help

After entering the Setup utility, the first screen you see is the Main Menu.

MainMenu

The main menu displays the setup categories the BIOS supplies. You can use the arrow keys (↑↓) to select the item. The on-line description for the selected setup category is displayed at the bottom of the screen.

Default Settings

The BIOS setup program contains two kinds of default settings: the BIOS Setup and High Performance defaults. Bios Setup defaults provide stable but minimal performance settings for all devices and the system, while High Performance defaults provide the best system performance but may affect the system stability.

Chapter 3

The Main Menu

Once you enter AMIBIOS SIMPLE SETUP UTILITY, the Main Menu will appear on the screen. The Main Menu displays twelve configurable functions and two exit choices. Use arrow keys to move among the items and press <Enter> to enter the sub-menu.

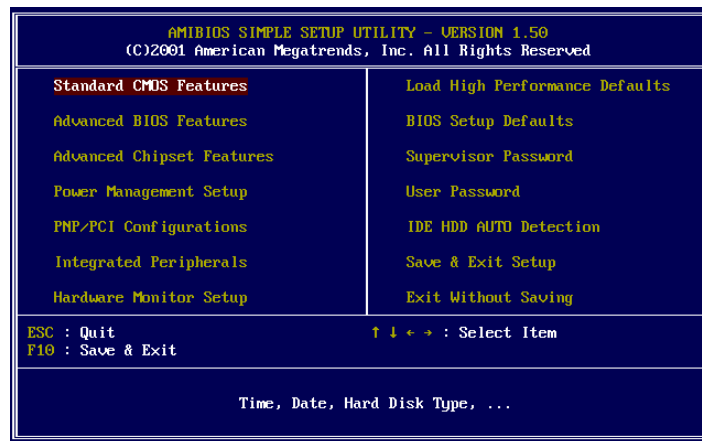

Standard CMOS Features

Use this menu for basic system configurations, such as time, date etc.

Advanced BIOS Features

Use this menu to setup the items of AMI® special enhanced features.

Advanced Chipset Features

Use this menu to change the values in the chipset registers and optimize your system's performance.

Power Management Setup

Use this menu to specify your settings for power management.

PNP/PCI Configurations

This entry appears if your system supports PnP/PCI.

AMI BIOS Setup

Integrated Peripherals

Use this menu to specify your settings for integrated peripherals.

Hardware Monitor Setup

This entry shows your PC's current status, and allows you to adjust CPU clock, core voltage, ratio and DDR voltage.

Load High Performance Defaults

Use this menu to load the BIOS values for the best system performance, but the system stability may be affected.

BIOS Setup Defaults

Use this menu to load factory default settings into the BIOS for stable system performance operations.

Supervisor Password

Use this menu to set Supervisor Password.

User Password

Use this menu to set User Password.

IDE HDD AUTO Detection

Use this menu to automatically detect hard drives.

Save & Exit Setup

Save changes to CMOS and exit setup.

Exit Without Saving

Abandon all changes and exit setup.

Chapter 3

Standard CMOS Features

The items inside STANDARD CMOS SETUP menu are divided into 9 categories. Each category includes none, one or more setup items. Use the arrow keys to highlight the item you want to modify and use the <PgUp> or <PgDn> keys to switch to the value you prefer.

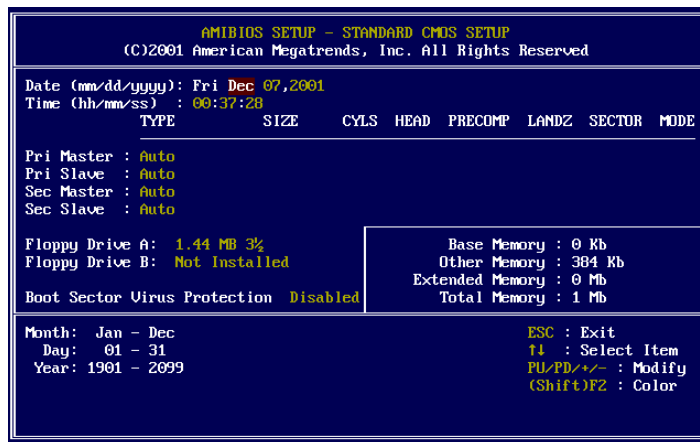

Date

This allows you to set the system to the date that you want (usually the current date). The format is <day><month><date><year>.

- day** Day of the week, from Sun to Sat, determined by BIOS. Read-only.
- month** The month from Jan. through Dec.
- date** The date from 1 to 31 can be keyed by numeric function keys.
- year** The year can be adjusted by users.

Time

This allows you to set the system time that you want (usually the current time). The time format is <hour><minute><second>.

AMI BIOS Setup

Pri Master/Pri Slave/Sec Master/Sec Slave

Press PgUp/<+> or PgDn/<-> to select the hard disk drive type. The specification of hard disk drive will show up on the right hand according to your selection.

<u>TYPE</u>	Type of the device.
<u>SIZE</u>	Capacity of the device.
<u>CYLS</u>	Number of cylinders.
<u>HEAD</u>	Number of heads.
<u>PRECOMP</u>	Write precompensation.
<u>LANDZ</u>	Cylinder location of Landing zone.
<u>SECTOR</u>	Number of sectors.
<u>MODE</u>	Access mode.

Floppy Drive A/B:

This item allows you to set the type of floppy drives installed. Available options: *Not Installed*, 360 KB 5¼ 1.2 MB 5¼ 720 KB 3½ 1.44 MB 3½ and 2.88 MB 3½.

Boot Sector Virus Protection

The item is to set the Virus Warning feature for IDE Hard Disk boot sector protection. When *Enabled*, BIOS will issue a virus warning message and beep if a write to the boot sector or the partition table of the HDD is attempted. Setting options: *Disabled* and *Enabled*.



Note: *This feature only protects the boot sector, not the whole hard disk.*

Chapter 3

Advanced BIOS Features



Quick Boot

Setting the item to *Enabled* allows the system to boot within 5 seconds since it will skip some check items. Available options: *Enabled* and *Disabled*.

Full Screen Logo Show

This item enables you to show the company logo on the bootup screen. Settings are:

- Disabled* Shows the POST messages at boot.
- Enabled* Shows a still image (logo) on the full screen at boot.

1st/2nd/3rd Boot Device

The items allow you to set the sequence of boot devices where AMIBIOS attempts to load the operating system. The settings are:

- IDE-0* The system will boot from the first HDD.
- IDE-1* The system will boot from the second HDD.
- IDE-2* The system will boot from the third HDD.
- IDE-3* The system will boot from the fourth HDD.
- Floppy* The system will boot from floppy drive.
- ARMD-FDD* The system will boot from any ARMD device, such

AMI BIOS Setup

	as LS-120 or ZIP drive, that functions as a floppy drive.
<i>ARMD-HDD</i>	The system will boot from ARMD device, such as MO or ZIP drive, that functions as hard disk drive.
<i>CDROM</i>	The system will boot from the CD-ROM.
<i>SCSI</i>	The system will boot from the SCSI.
<i>NETWORK</i>	The system will boot from the Network drive.
<i>BBS-0</i>	The system will boot from the first BBS (BIOS Boot Specification) compliant device.
<i>BBS-1</i>	The system will boot from the second BBS (BIOS Boot Specification) compliant device.
<i>BBS-2</i>	The system will boot from the third BBS (BIOS Boot Specification) compliant device.
<i>BBS-3</i>	The system will boot from the fourth BBS (BIOS Boot Specification) compliant device.
<i>Disabled</i>	Disable this sequence.



Note: Available settings for “1st/2nd/3rd Boot Device” vary depending on the bootable devices you have installed. For example, if you did not install a floppy drive, the setting “Floppy” does not show up.

Try Other Boot Devices

Setting the option to *Yes* allows the system to try to boot from other devices if the system fails to boot from the 1st/2nd/3rd boot device.

S.M.A.R.T. for Hard Disks

This allows you to activate the S.M.A.R.T. (Self-Monitoring Analysis & Reporting Technology) capability for the hard disks. S.M.A.R.T is a utility that monitors your disk status to predict hard disk failure. This gives you an opportunity to move data from a hard disk that is going to fail to a safe place before the hard disk becomes offline. Settings: *Enabled* and *Disabled*.

BootUp Num-Lock

This item is to set the Num Lock status when the system is powered on. Setting to *On* will turn on the Num Lock key when the system is powered on. Setting to *Off* will allow end users to use the arrowkeys on the numeric keypad. Setting options: *On* and *Off*.

Chapter 3

SwapFloppy

Setting to *Enabled* will swap floppy drives A: and B:.

Seek Floppy

This setting causes the BIOS to search for floppy disk drives at boot time. When enabled, the BIOS will activate the floppy disk drives during the boot process: the drive activity light will come on and the head will move back and forth once. First A: will be done and then B: if it exists. Setting options: *Disabled*, *Enabled*.

Password Check

This specifies the type of AMIBIOS password protection that is implemented. Setting options are described below.

Option	Description
Setup	The password prompt appears only when end users try to run Setup.
Always	A password prompt appears every time when the computer is powered on or when end users try to run Setup.

Boot OS/2 for DRAM > 64MB

This allows you to run the OS/2® operating system with DRAM larger than 64MB. When you choose *No*, you cannot run the OS/2® operating system with DRAM larger than 64MB. But it is possible if you choose *Yes*.

APIC Function

This field is used to enable or disable the APIC (Advanced Programmable Interrupt Controller). Due to compliance with PC2001 design guide, the system is able to run in APIC mode. Enabling APIC mode will expand available IRQ resources for the system. Settings: *Enabled* and *Disabled*.

MPS Table Version

This field allows you to select which MPS (Multi-Processor Specification) version to be used for the operating system. You need to select the MPS version supported by your operating system. To find out which version to use, consult the vendor of your operating system. Settings: *1.4* and *1.1*.

AMI BIOS Setup

L1 Cache

Cache memory is additional memory that is much faster than conventional DRAM (system memory). When the CPU requests data, the system transfers the requested data from the main DRAM into cache memory, for even faster access by the CPU. The setting enables/disables the internal cache (also known as L1 or level 1 cache). Setting to *Enabled* will speed up the system performance.

Flash Protection

This function protects the BIOS from accidental corruption by unauthorized users or computer viruses. When enabled, the BIOS' data cannot be changed when attempting to update the BIOS with a Flash utility. To successfully update the BIOS, you'll need to disable this Flash Protection function. Setting options: *Disabled, Enabled*.

System BIOS Cacheable

Selecting *Enabled* allows caching of the system BIOS ROM at F0000h-FFFFFh, resulting in better system performance. However, if any program writes to this memory area, a system error may result. Setting options: *Enabled, Disabled*.

Chapter 3

Advanced Chipset Features

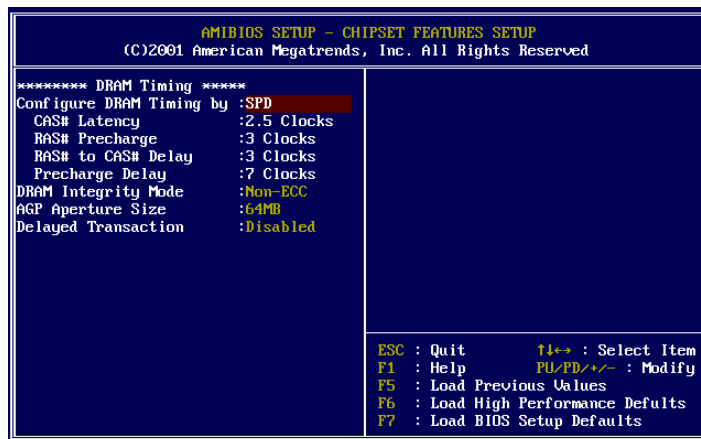

 **Note:** Change these settings only if you are familiar with the chipset.

Configure DRAM Timing by

This setting determines whether DRAM timing is controlled by the SPD (Serial Presence Detect) EEPROM on the DRAM module. Setting to *SPD* enables CAS# Latency, RAS# Precharge, RAS# to CAS# Delay, and Precharge Delay automatically to be determined by BIOS based on the configurations on the SPD. Selecting *Manual* allows users to configure these fields manually.

CAS# Latency

The field controls the CAS latency, which determines the timing delay before SDRAM starts a read command after receiving it. Setting options: *2.5 Clocks*, *2 Clocks*. *2 Clocks* increases system performance while *2.5 Clocks* provides more stable system performance.

RAS# Precharge

This setting controls the number of cycles for Row Address Strobe (RAS) to be allowed to precharge. If insufficient time is allowed for the RAS to accumulate its charge before DRAM refresh, refresh may be incomplete and DRAM may fail to retain data. This item applies only when synchronous DRAM is

AMI BIOS Setup

installed in the system. Setting options: *2 Clocks, 3 Clocks*.

RAS# to CAS# Delay

When DRAM is refreshed, both rows and columns are addressed separately. This setup item allows you to determine the timing of the transition from RAS (row address strobe) to CAS (column address strobe). The less the clock cycles, the faster the DRAM performance. Setting options: *3 Clocks, 2 Clocks*.

Precharge Delay

This setting controls the precharge delay, which determines the timing delay for DRAM precharge. Setting options: *5 Clocks, 6 Clocks, 7 Clocks*.

DRAM Integrity Mode

Select *ECC* (Error-Checking & Correcting Code) or *Non-ECC* according to the type of DRAM installed.

AGP Aperture Size

The field selects the size of the Accelerated Graphics Port (AGP) aperture. Aperture is a portion of the PCI memory address range dedicated for graphics memory address space. Host cycles that hit the aperture range are forwarded to the AGP without any translation. Settings: *4MB, 8MB, 16MB, 32MB, 64MB, 128MB, 256MB*.

Delayed Transaction

The chipset has an embedded 32-bit posted write buffer to support delayed transactions cycles. Select *Enabled* to support compliance with PCI specification version 2.1. Settings: *Enabled* and *Disabled*.

Chapter 3

Power Management Setup

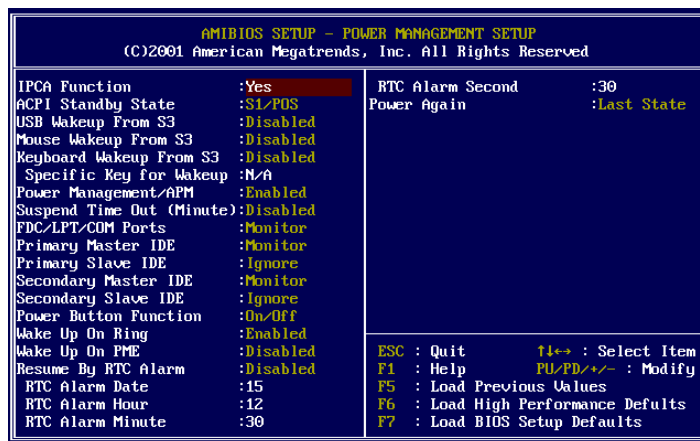

IPCA Function

This item is to activate the ACPI (Advanced Configuration and Power Management Interface) function. If your operating system is ACPI-aware, such as Windows 98SE/2000/ME, select *Yes*. Available options: *Yes* and *No*.

ACPI Standby State

This item specifies the power saving modes for ACPI function. Options are:

S1/POS The S1 sleep mode is a low power state. In this state, no system context is lost (CPU or chipset) and hardware maintains all system context.

S3/STR The S3 sleep mode is a lower power state where the information of system configuration and open applications/files is saved to main memory that remains powered while most other hardware components turn off to save energy. The information stored in memory will be used to restore the system when an “wake up” event occurs.

USB Wakeup From S3

This item allows the activity of the USB device to wake up the system from S3

AMI BIOS Setup

(Suspend to RAM) sleep state. Settings: *Enabled* and *Disabled*.

Mouse Wakeup From S3

This item allows the activity of the mouse to wake up the system from S3 (Suspend to RAM) sleep state. Settings: *Enabled* and *Disabled*.

Keyboard Wakeup From S3

This item allows the activity of the keyboard to wake up the system from S3 (Suspend to RAM) sleep state. Settings: *Enabled* and *Disabled*.

Specific Key for Wakeup

This setting allows users to set a specific key for the *Keyboard Wakeup From S3* function.

Power Management/APM

Setting to *Enabled* will activate an Advanced Power Management (APM) device to enhance Max Saving mode and stop CPU internal clock. Settings are *Disabled* and *Enabled*.

Suspend Time Out (Minute)

After the selected period of system inactivity, all devices except the CPU shut off. Settings are *Disabled*, *1*, *2*, *4*, *8*, *10*, *20*, *30*, *40*, *50*, and *60*.

FDC/LPT/COM Ports, Primary/Secondary Master/Slave IDE

These items specify if the BIOS will monitor the activity of the specified hardware peripheral or component. If set to *Monitor*, any activity detected on the specified hardware peripheral or component will wake up the system or prevent the system from entering the power saving modes. Settings: *Monitor* and *Ignore*.

Power Button Function

This feature sets the function of the power button. Settings are:

- | | |
|----------------|---|
| <i>On/Off</i> | The power button functions as normal on/off button. |
| <i>Suspend</i> | When you press the power button, the computer enters the suspend/sleep mode, but if the button is pressed for more than four seconds, the computer is turned off. |

Chapter 3

Wake Up On Ring

When setting to *Enabled*, the feature allows your system to be awakened from the powersaving modes through an incoming call from the modem. Settings: *Enabled* and *Disabled*.



Note: You need to install a modem supporting power on function for Wake Up On Ring function.

Wake Up On PME

When setting to *Enabled*, the feature allows your system to be awakened from the power saving modes through any event on PME (Power Management Event). Settings: *Enabled* and *Disabled*.

Resume By RTC Alarm

This is used to enable or disable the feature of booting up the system on a scheduled time/date from the soft off(S5) state. Settings: *Enabled* and *Disabled*.

RTC Alarm Date/Hour/Minute/Second

If *Resume By RTC Alarm* is set to *Enabled*, the system will automatically resume (boot up) on a specific date/hour/minute/second specified in these fields. Available settings for each item are:

Alarm Date	01 ~ 31, Every Day
Alarm Hour	00 ~ 23
Alarm Minute	00 ~ 59
Alarm Second	00 ~ 59



Note: If you change these settings, you must reboot the system until it enters the operating system and then power off the system. By doing so, the changed settings will come into effect next time when you power on the system.

Power Again

This setting specifies whether your system will reboot after a power failure or interrupts occurs. Available settings are:

<i>Power Off</i>	Leaves the computer in the power off state.
<i>Power On</i>	Reboots the computer.
<i>Last State</i>	Restores the system to the status before power failure or interrupt occurs.

PNP/PCI Configurations

This section describes configuring the PCI bus system and PnP (Plug & Play) feature. PCI, or Personal Computer Interconnect, is a system which allows I/O devices to operate at speeds nearing the speed the CPU itself uses when communicating with its special components. This section covers some very technical items and it is strongly recommended that only experienced users should make any changes to the default settings.

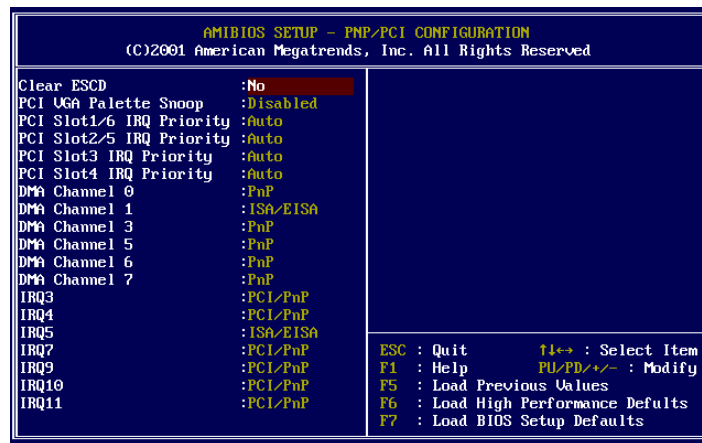

Clear ESCD

The ESCD (Extended System Configuration Data) NVRAM (Non-volatile Random Access Memory) is where the BIOS stores resource information for both PNP and non-PNP devices in a bit string format. When the item is set to *Yes*, the system will reset ESCD NVRAM right after the system is booted up and then set the setting of the item back to *No* automatically.

PCI VGA Palette Snoop

When set to *Enabled*, multiple VGA devices operating on different buses can handle data from the CPU on each set of palette registers on every video device. Bit 5 of the command register in the PCI device configuration space is the VGA Palette Snoop bit (0 is disabled). For example, if there are two VGA devices in the computer (one PCI and one ISA) and the:

Chapter 3

VGA Palette Snoop Bit Setting	Action
<i>Disabled</i>	Data read or written by the CPU is only directed to the PCI VGA device's palette registers.
<i>Enabled</i>	Data read or written by the CPU is directed to both the PCI VGA device's palette registers and the ISA VGA device's palette registers, permitting the palette registers of both VGA devices to be identical.

The setting must be set to *Enabled* if any ISA bus adapter in the system requires VGA palette snooping.

PCI Slot1/6 IRQ, PCI Slot2/5 IRQ, PCISlot3 IRQ, PCISlot4 IRQ

This item specifies the IRQ line for each PCI slot. Settings: *3, 4, 5, 7, 9, 10, 11* and *Auto*. Selecting *Auto* allows BIOS to automatically determine the IRQ line for each PCI slot.

DMA Channel 0/1/3/5/6/7

These items specify the bus that the system DMA (Direct Memory Access) channel is used.

The settings determine if AMIBIOS should remove a DMA from the available DMAs passed to devices that are configurable by the system BIOS. The available DMA pool is determined by reading the ESCD NVRAM. If more DMAs must be removed from the pool, the end user can reserve the DMA by assigning an *ISA/EISA* setting to it.

IRQ 3/4/5/7/9/10/11

These items specify the bus where the specified IRQ line is used.

The settings determine if AMIBIOS should remove an IRQ from the pool of available IRQs passed to devices that are configurable by the system BIOS. The available IRQ pool is determined by reading the ESCD NVRAM. If more IRQs must be removed from the IRQ pool, the end user can use these settings to reserve the IRQ by assigning an *ISA/EISA* setting to it. Onboard I/O is configured by AMIBIOS. All IRQs used by onboard I/O are configured as *PCI/PnP*. If all IRQs are set to *ISA/EISA*, and IRQ 14/15 are allocated to the onboard PCI IDE, IRQ 9 will still be available for PCI and PnP devices. Available settings: *ISA/EISA* and *PCI/PnP*.

Integrated Peripherals

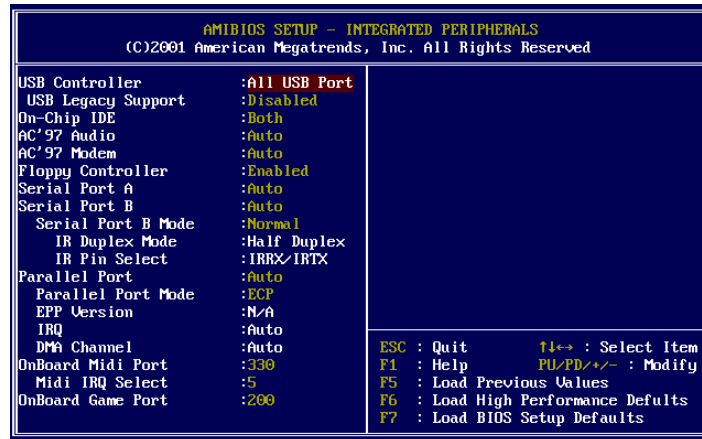

USB Controller

This setting is used to enable/disable the onboard USB controllers. Settings: *All USB Port, Disabled, USB Port 0&1, USB Port 2&3.*

USB Legacy Support

Set to *All Device* if your need to use any USB device in the operating system that does not support or have any USB driver installed, such as DOS and SCO Unix. Set to *No Mice* only if your want to use any USB device other than the USB mouse. Setting options: *Disabled, No Mice, All Device.*

On-Chip IDE

This setting controls the on-chip IDE controller. Setting options: *Disabled, Primary, Secondary, Both.*

AC'97 Audio

Auto allows the mainboard to detect whether an audio device is used. If the device is detected, the onboard AC'97 (Audio Codec'97) controller will be enabled; if not, it is disabled. Disable the controller if you want to use other controller cards to connect an audio device. Settings: *Auto, Disabled.*

AC'97 Modem

Auto allows the mainboard to detect whether a modem is used. If a modem is

Chapter 3

used, the onboard MC' 97 (Modem Codec' 97) controller will be enabled; if not, it is disabled. Disable the controller if you want to use other controller cards to connect to a modem. Settings: *Auto, Disabled*.

Floppy Controller

This is used to enable or disable the onboard Floppy controller.

Option	Description
Auto	BIOS will automatically determine whether to enable the onboard Floppy controller or not.
Enabled	Enables the onboard Floppy controller.
Disabled	Disables the onboard Floppy controller.

Serial Port A/B

These items specify the base I/O port addresses of the onboard Serial Port 1 (COM A)/Serial Port 2 (COM B). Selecting *Auto* allows AMIBIOS to automatically determine the correct base I/O port address. Settings: *Auto, 3F8/COM1, 2F8/COM2, 3E8/COM3, 2E8/COM4* and *Disabled*.

Serial Port B Mode

This item sets the operation mode for Serial Port B. Settings: *Normal, 1.6uS, 3/16 Baud* and *ASKIR* (the last three operation modes are setting options for IR function).

IR Duplex Mode

This field specifies a duplex value for the IR device connected to COM B. Full-Duplex mode permits simultaneous two-direction transmission. Half-Duplex mode permits transmission in one direction only at a time. Settings: *Half Duplex* and *Full Duplex*.

IR Pin Select

Set to *IRRX/IRTX* when using an internal IR module connected to the IR connector. Set to *SINB/SOUTB* when connecting an IR adapter to COM B.

Parallel Port

This field specifies the base I/O port address of the onboard parallel port. Selecting *Auto* allows AMIBIOS to automatically determine the correct base I/

AMI BIOS Setup

O port address. Settings: *Auto*, *378*, *278*, *3BC* and *Disabled*.

ParallelPort Mode

This item selects the operation mode for the onboard parallel port: *ECP*, *Normal*, *Bi-Dir* or *EPP*.

EPP Version

The item selects the EPP version used by the parallel port if the port is set to *EPP* mode. Settings: *1.7* and *1.9*.

IRQ

When *Parallel Port* is set to *Auto*, the item shows *Auto* indicating that BIOS determines the IRQ for the parallel port automatically.

DMA Channel

This feature needs to be configured only when *Parallel Port Mode* is set to the *ECP* mode. When Parallel Port is set to *Auto*, the field will show *Auto* indicating that BIOS automatically determines the DMA channel for the parallel port.

OnBoardMidi Port

The field specifies the base I/O port address for the onboard Midi Port.

Midi IRQ Select

The item is used to select the IRQ line for onboard Midi port.

OnBoard Game Port

This item is used to specify the address for the onboard game port.

Chapter 3

Hardware Monitor Setup

This section describes how to set the CPU FSB frequency, monitor the current hardware status including CPU/system temperatures, CPU/System Fan speeds, Vcore etc. Monitor function is available only if there is hardware monitoring mechanism on board.

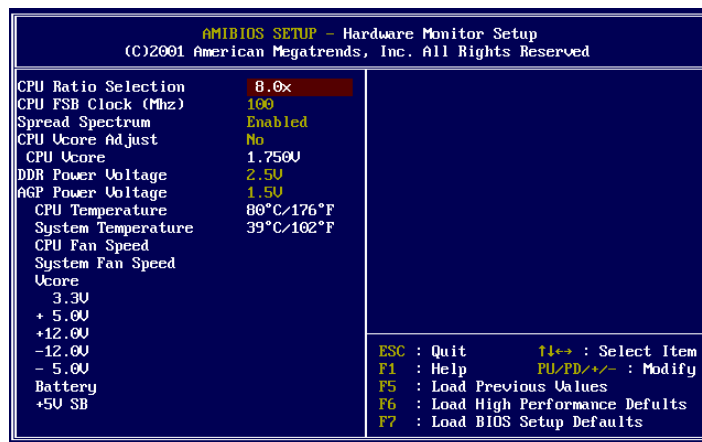

CPU Ratio Selection

This setting controls the multiplier that is used to determine the internal clock speed of the processor relative to the external or motherboard clock speed.

CPU FSB Clock (Mhz)

This setting allows you to select the CPU Front Side Bus clock frequency. Setting options: 100MHz~200MHz at 1MHz increment.

Spread Spectrum

When the motherboard clock generator pulses, the extreme values (spikes) of the pulses creates EMI (Electromagnetic Interference). The Spread Spectrum function reduces the EMI generated by modulating the pulses so that the spikes of the pulses are reduced to flatter curves. If you do not have any EMI problem, leave the setting at *Disabled* for optimal system stability and performance. But if you are plagued by EMI, setting to *Enabled* for EMI reduction. Remember to disable Spread Spectrum if you are overclocking because even a slight jitter can introduce a temporary boost in clock speed which

AMI BIOS Setup

may just cause your overclocked processor to lock up.

CPU Vcore Adjust

This setting is used to adjust the CPU core voltage (Vcore), making overclocking possible.



Note: Changing CPU Vcore could result in unstable system; therefore, it is not recommended to change the default setting for long-term purpose.

DDR/AGP Power Voltage

The item is to adjust the DDR/AGP voltage to increase the DDR/AGP rate. Modifying the setting may lead to unstable system, so changing the DDR/AGP Vcore for long-term use is not recommended.

CPU/System Temperature, CPU/System FanSpeed, Vcore, 3.3V, +5.0V, +12.0V, -12.0V, -5.0V, Battery, +5V SB

These items display the current status of all of the monitored hardware devices/components such as system voltages, temperatures and fan speeds.

Chapter 3

Load High Performance/BIOS Setup Defaults

The two options on the main menu allow users to restore all of the BIOS settings to High Performance defaults or BIOS Setup defaults. The High Performance Defaults are the default values set by the mainboard manufacturer for the best system performance but probably will cause a stability issue. The BIOS Setup Defaults are the default values also set by the mainboard manufacturer for stable performance of the mainboard.

When you select Load High Performance Defaults, a message as below appears:



Load High Performance Defaults (Y/N) ? H

Pressing ‘Y’ loads the default BIOS values that enable the best system performance but may lead to a stability issue.

When you select Load BIOS Setup Defaults, a message as below appears:



Load BIOS Setup Defaults (Y/N) ? H

Pressing ‘Y’ loads the default values that are factory settings for stable system performance.



*The option is for power or overclocking users only. Use of high performance defaults will tighten most timings to increase the system performance. Therefore, a high-end system configuration is a must, which means you need high-quality VGA adapter, RAM and so on. **We don't recommend that users should apply the high performance defaults in their regular systems.** Otherwise, the system may become unstable or even crash. If the system crashes or hangs after enabling the feature, please CLEAR CMOS DATA to resolve the problem. For more information, refer to “Clear CMOS Jumper:JBAT1” in Chapter 2.*

Supervisor/User Password

When you select Supervisor Password, a message as below will appear on the screen:



Enter current supervisor password:

When you select User Password, a message as below will appear on the screen:



Enter new user password:

Type the password, up to six characters in length, and press <Enter>. The password typed now will replace any previously set password from CMOS memory. You will be prompted to confirm the password. Retype the password and press <Enter>. You may also press <Esc> to abort the selection and not enter a password.

To clear a set password, just press <Enter> when you are prompted to enter the password. A message will show up confirming the password will be disabled. Once the password is disabled, the system will boot and you can enter Setup without entering any password.

When a password has been set, you will be prompted to enter it every time you try to enter Setup. This prevents an unauthorized person from changing any part of your system configuration.

Additionally, when a password is enabled, you can also have AMIBIOS to request a password each time the system is booted. This would prevent unau-

Chapter 3

thorized use of your computer. The setting to determine when the password prompt is required is the PASSWORDCHECK option of the ADVANCEDBIOS FEATURES menu. If the PASSWORD CHECK option is set to *Always*, the password is required both at boot and at entry to Setup. If set to *Setup*, password prompt only occurs when you try to enter Setup.



About Supervisor Password & User Password:

Supervisor password: Can enter and change the settings of the setup menu.

User password: Can only enter but do not have the right to change the settings of the setup menu.

IDE HDD AUTO Detection

You can use this utility to AUTOMATICALLY detect the characteristics of most hard drives.

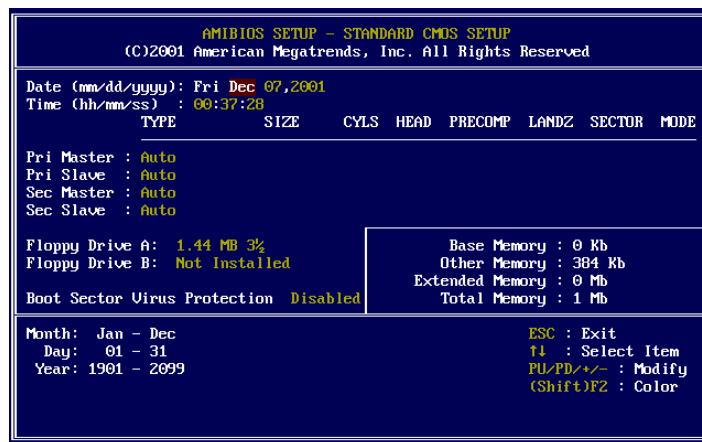

MSI Smart Key **A**

If security is important to you, the MSI Smart Key is the best solution to prevent your data in the computer from being accessed by unauthorized people.

In the public workspace, the passwords (BIOS password, system password, etc.) are not enough to keep your privacy. Do you believe that a hacker can easily enter your computer and monitor your confidential data? It happens everyday, everywhere; you just do not know... A password only stops them at the first gate. If this protection is broken, what else can you rely on?

The MSI Smart Key is a hardware device that provides you the complete and perfect protection on your system. Once the key is installed and setup, any unauthorized user absolutely can not access and use your computer without the key. The computer needs the key to boot up, and the operating system needs the key to work normally. Furthermore, if you have to leave your desktop for a while, you can simply unplug the key to keep your system in a safest status.

TOPICS

Installing MSI Smart Key A-2

Using MSI Smart Key A-3

Appendix A

Installing MSI Smart Key

Installation

Simply follow the few steps below, you can install the Smart Key into your computer very easily.

1. Turn off the computer.
2. Locate the USB port on your computer.
3. Connect the cable to the USB port, and then plug the Smart Key into the connector properly.
4. Turn on the computer, and now you can implement this powerful feature.



Note: After you have installed the Smart Key into your computer, the BIOS will detect it when the system boots up, and you have to enabled/disabled this function. Furthermore, you should install the dedicated software application in the operating system, which is provided by MSI, to obtain the overall protection on your system. The following sections will provide the detailed instructions for the BIOS setup and software installation.

System Requirements

Before you use the MSI Smart Key, please check the hardware, software and operating system requirements first.

Operating System	Windows 98/ME/2000/XP
Connector	USB port
Disk Space	At least 2 MB to install the software application

Using MSI Smart Key

BIOS Setup

When the Smart Key is inserted into your computer, the BIOS will detect it automatically. You can enable or disable the Smart Key through the BIOS setting. **Please note that it needs a personalized password to execute any kind of Smart Key setting;** so, keep the password firmly in mind. If, unfortunately, the Smart Key is lost or the password is missed, you can not enter the operating system successfully. At this time, contact your local dealer for further service.

Enable/Disable the Smart Key

The first time installation

1. Insert the Smart Key into the computer and turn on the power.
2. Press <F7> during system boot up.
3. The message as below appears on the screen asking you to enable or disable the key:

```
Welcome to MSI Smart Key, please press "Y" to begin,  
press "N" to exit
```

Type <Y> to enable it; type <N> to disable it and bypass the BIOS to enter the operating system. When you type <Y>, it shows the following message:

```
Please input your password and press "Enter"  
password:
```

Appendix A

4. Type the password, up to 8 characters, and press <Enter>, it will show the following message to ask you confirm the password:

```
Please input your password and press "Enter"
Confirm your password:
```

Type the password again and press <Enter>.

5. After the password is confirmed, the system will generate a set of random ID, and record this ID into the BIOS ROM and the memory chip on the key; it will show the following message when the Smart Key is enabled successfully:

```
Processing .....
You have enabled the Smart Key Successfully
```

Then, you can enter the operating system and start to work.



Note:

1. You should firmly remember the password you set; if the Smart Key is lost, you can get a new key from MSI, and turn on the computer with the original password.
2. To avoid the password from being forgotten, we provide the table below for you to keep note in this guide. Please write down the password and keep the guide properly.

--	--	--	--	--	--	--	--

3. After the Smart Key function is successfully configured under DOS, the system will automatically reset and enter the installed OS. Please **DO NOT** unplug the Smart Key until the system has entered the OS.

MSI Smart Key

Enable/disable Smart Key function

1. Turn on the computer with the Smart Key installed.
2. Press <F7> during system boot up.
3. The message as below appears on the screen asking you to enable or disable the key:

```
If you want to disable MSI Smart Key,  
please press "Y", or press "N" to exit
```

Type <Y> to disable it; type <N> to keep the function enabled and enter the operating system. When you type <Y>, it shows the following message:

```
Processing .....  
You have disabled the Smart Key Successfully
```

Then, you can enter the operating system and start to work.

Appendix A

Boot up with no key /wrong key/new key installed

Once the MSI Smart Key is enabled, always keep the key inserted in the computer. If the key is unplugged, the other user can not access the computer. The message as below appears during the system booting up:

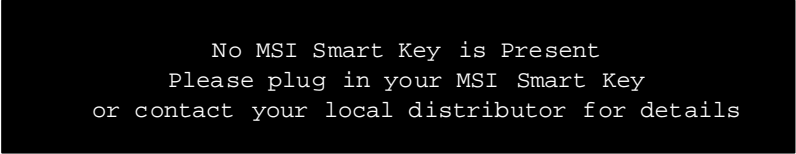

```
No MSI Smart Key is Present
Please plug in your MSI Smart Key
or contact your local distributor for details
```

The user have to find and re-plug the original key into the computer to continue booting up the system. If the wrong key or anew key* is inserted, it will show the message as below on the screen:

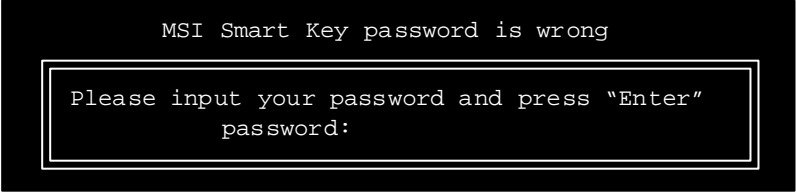

```
MSI Smart Key password is wrong
```

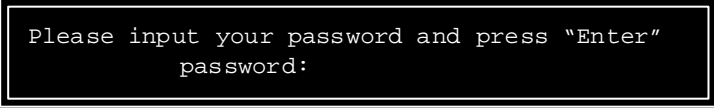

```
Please input your password and press "Enter"
password:
```

If the user remember the original password, typing in the password will allow the user to enter the operating system, and the system BIOS will copy the original password data into the wrong key/new key. Otherwise, the system will halt after entering the wrong password for three times.

** If, unfortunately, your Smart Key was lost , you have to purchase a new key from MSI as a replacement.*

Software Setup

When the Smart Key is inserted into your computer and the software application is installed in the operating system, it will serve as a safeguard for your system. When the key is unplugged, the operating system will enter protection status immediately and the mouse and keyboard will be locked; when the key is inserted again, the operating system will resume from the protected mode.

Installation

1. Install the Smart Key into the computer and turn on the power to enter the operating system successfully.
2. Insert the CD-ROM provided and the setup program will execute automatically. The welcome screen will appear as below:

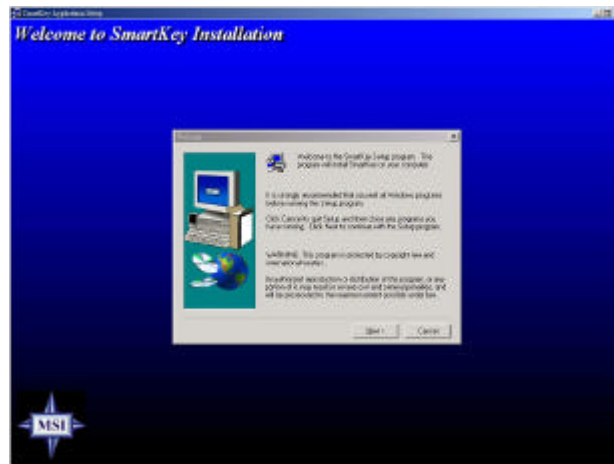

3. Press [Next >] to start the installation.

Appendix A

4. When the Software License Agreement window appears on the screen, press [Yes] to continue.

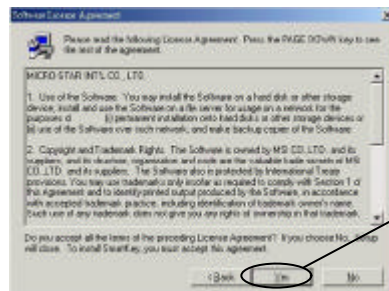

5. Choose the folder to install the software in your computer; simply press [Next >] to install it in the default folder.

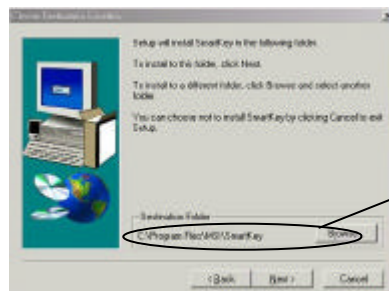

6. When the installation is completed, restart the computer as instructed.

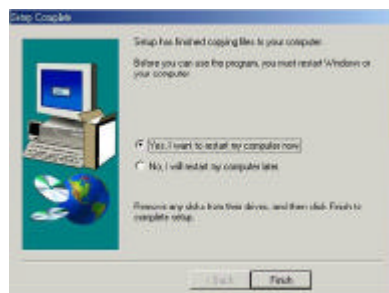

MSI Smart Key

Using the Software Application

1. When the program is installed in the operating system, it will embed in the system tray and show an icon as below:



SmartKeyicon

 **Note:** When the Smart Key function is disabled in BIOS, this program will not be launched in the operating system.

2. To launch the program's setup screen, simply left-click on the Smart Key icon in the system tray. The program's setup screen appears as below.



Programversion

This window contains the information of the program and the main options for the user to control: **Security Setting** and **Other**.

Appendix A

Security Setting

This option allows you to logon to Windows automatically. Select the “Auto Login” item and check the “Auto Logon to Windows” item in the Setting Page field to enable the function. Once the function is enabled and set properly, you do not have to type the user’s name and password everytime when entering Windows.



In Windows 2000, it will show the related fields when the “Auto Logon to Windows” is checked, you should fill in the correct information in these fields.



MSI Smart Key

Other

This option contains two items:

- 1) **Disable Screen Saver** allows you to enable/disable the screen saver program when the system is locked.



- 2) **Set Screen When System Locked** allows you to set the status when the Smart Key is unplugged and the system locked. You can set the monitor to display:

- a) blank screen
- b) the retaining screen when the system locked
- c) MSI Logo

The default setting is to show MSI Logo.



Appendix A

3. Press the “Apply Changes” button to enable the option you choose.

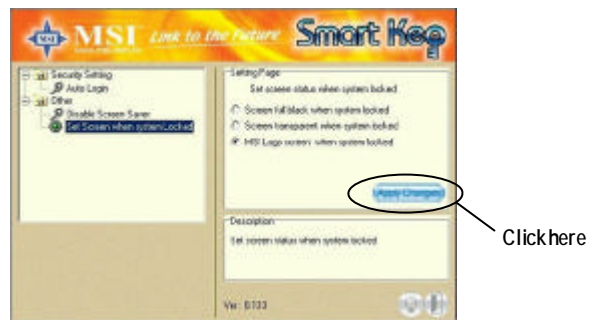

4. Press the “bulb” button at the right-bottom to hide the program in the system tray and keep on monitoring the system.



5. Press the “door” button at the right-bottom to exit the program.



Removing the Software Application

To remove the program, follow the steps below:

1. Click  and choose **Settings Control Panel**; double-click the **Add/Remove Programs** item to open the “Add/Remove Programs Properties” window.

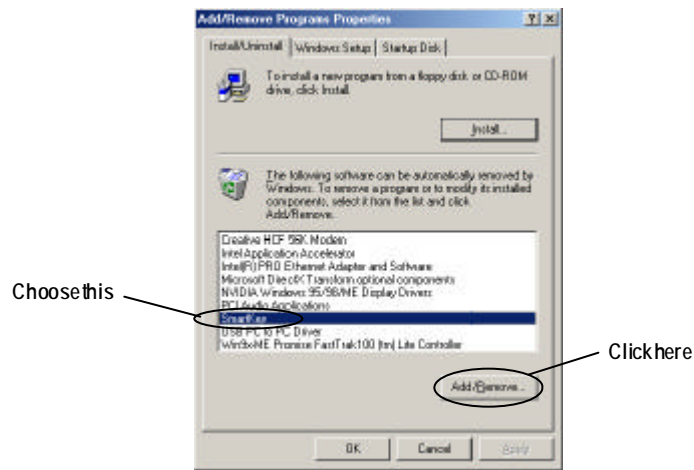

2. Select the “SmartKey” item in the field and click the [**Add/Remove...**]; when it shows the dialog box requiring your confirmation, press [**Yes**] to start removing the program as the on-screen instructions.

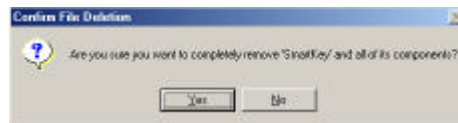

3. Restart the computer when the un-installation is completed.

Glossary

ACPI (*Advanced Configuration & Power Interface*)

This power management specification enables the OS (operating system) to control the amount of power given to each device attached to the computer. Windows 98/98SE, Windows 2000 and Windows ME can fully support ACPI to allow users managing the system power flexibly.

AGP (*Accelerated Graphics Port*)

A new, high-speed graphics interface that based on PCI construction and designed especially for the throughput demands of 3-D graphics. AGP provides a direct channel (32-bit wide bus) between the display controller and main memory for high graphics quality and performance.

ATX

A modern shape and layout of mainboard that supersedes the widely-used Baby AT form factor. It improves many placement of components and makes a more efficient design.

BIOS (*basic input/output system*)

On PCs, an essential software that contains all the control code of input/output interface (such as keyboard, disk drives, etc.). It executes hardware test on booting the system, starts the OS, and provides an interface between the OS and the components. The BIOS is stored in a ROM chip.

Bus

A set of hardware lines within the computer system, through which the data is transferred among different components. In a PC, the term **bus** usually refers to a local bus that connects the internal components to the CPU and main memory.

Cache

A special memory subsystem that is used to speed up the data transfer. It stores the contents of frequently accessed RAM locations and the addresses where these data items are stored.

Chipset

A collection of integrated chips designed to perform one or more related functions. For

Glossary

example, a modem chipset contains all the primary circuits for transmitting and receiving data; a PC chipset provides the electronic interfaces between all subsystems.

CMOS (*complementary metal-oxide semiconductor*)

CMOS is a widely used type of semiconductor, which features high speed and low power consumption. PCs usually contain a small amount of battery-powered CMOS memory to retain the date, time, and system setup parameters.

COM

In MS-DOS system, the name of a serial communications port. DOS supports four serial ports. For example, if a modem is connected to one serial port and a serial mouse to another, they are identified as COM1 and COM2.

DIMM (*dual in-line memory module*)

A small circuit board that holds memory chips. A *SIMM* (*single in-line memory module*) has a 32-bit path to the memory chips whereas a DIMM has 64-bit path.

DRAM (*Dynamic RAM*)

A most common type of computer memory. It usually uses one transistor and a capacitor to represent a bit. As the development of technology, the memory type and specification used in computer becomes variety, such as SDRAM, DDR SDRAM, and RDRAM. For further instruction, please see the table below:

Dynamic RAM (DRAM) Memory Technologies					
Type	First Used	Clock Rate	Bus* Width	Peak Bandwidth	Volts
FPM (60,70ns)	1990	25MHz	64 bits	200 MBps	5v
EDO (50,60,70ns)	1994	40MHz	64 bits	320 MBps	5v
SDRAM (66MHz)	1996	66MHz	64 bits	528 MBps	3.3v
SDRAM (100MHz)	1998	100MHz	64 bits	800 MBps	3.3v
SDRAM (133MHz)	1999	133MHz	64 bits	1.1 GBps	3.3v
RDRAM (Direct Rambus)	1999	400MHz	16 bits	1.6 GBps	2.5v
DDR SDRAM (100MHz)	2000	100MHz	64 bits	1.6 GBps	3.3v
DDR SDRAM (133MHz)	2000	133MHz	64 bits	2.1 GBps	3.3v

* Memory channel width (64 bits started with 75MHz Pentium)

Source: *Computer Desktop Encyclopedia*

ECC Memory (*error correcting code memory*)

A type of memory that contains special circuitry for testing the accuracy of data and correcting the errors on the fly.

IDE (*Integrated Drive Electronics*)

A type of disk-drive interface widely used to connect hard disks, CD-ROMs and tape drives to a PC, in which the controller electronics is integrated into the drive itself, eliminating the need for a separate adapter card. The IDE interface is known as the ATA (AT Attachment) specification.

IEEE 1394

A new, high speed external bus standard, also known as *FireWire* or *iLink*, which supports data transfer rates of up to 400 Mbps for connecting up to 63 external devices.

IrDA (*Infrared Data Association*)

A group of device vendors, including computer, component and telecommunications, who have developed a standard for transmitting data via infrared light waves. This enables you to transfer data from one device to another without any cables.

LAN (*local area network*)

A computer network that covers a relatively smaller area, such as in a building or an enterprise. It is made up of servers, workstations, shared resources, a network operating system and a communications link. These individual PCs and devices on a LAN are known as “nodes”, and are connected by cables to access data and devices anywhere on the LAN, so that many users can share expensive devices and data.

LED (*light emitting diode*)

A semiconductor device that converts electrical energy into light. Since it lights up (usually red) when electricity is passed through it, it is usually used for the activity lights on computer’s component, such as disk drivers.

LPT (*line printer terminal*)

Logical device name for a line printer; a name reserved by the MS-DOS for up to three parallel printer ports: LPT1, LPT2, and LPT3. It is frequently used by the OS to identify a printer.

Glossary

PCI (*Peripheral Component Interconnect*)

A local bus standard developed by Intel that first appeared on PCs in late 1993. PCI provides “plug and play” capability and allows IRQs to be shared. The PCI controller can exchange data with the system's CPU either 32 bits or 64 bits at a time.

PnP (*Plug and Play*)

A set of specifications that allows a PC to configure itself automatically to work with peripherals. The user can “plug” in a peripheral device and “play” it without configuring the system manually. To implement this useful feature, both the BIOS that supports PnP and a PnP expansion card are required.

POST (*Power On Self Test*)

During booting up your system, the BIOS executes a series of diagnostic tests, include checking the RAM, the keyboard, the disk drives, etc., to see if they are properly connected and operating.

PS/2 Port

A type of port developed by IBM for connecting a mouse or keyboard to a PC. The PS/2 port supports a mini DIN plug containing just 6 pins. Most modern PCs equipped with PS/2 ports so that the special port can be used by another device, such as a modem.

USB (*universal serial bus*)

A hardware interface for low-speed peripherals such as the keyboard, mouse, joystick, etc. USB provides a maximum bandwidth of 12 Mbit/sec (Mbps) for connecting up to 127 peripheral devices to PC. USB features hot swap capability and multiple data streams, allows external devices to be plugged in and unplugged without turning the system off.

Virus

A program or a piece of code that infects computer files by inserting in those files copies of itself. The virus code is buried within an existing program, and is activated when that program is executed. All the viruses are man-made, and often have damaging side effects.