

**MSI**  
MICRO-STAR INTERNATIONAL  
**MS-6398 (v2.X) ATX Mainboard**

845 Ultra  
845 Ultra-AR  
845 Ultra-ARU



**Version 2.0**  
**G52-MA00516**

Manual Rev: 2.0  
Release Date: Dec. 2001



**FCC-B Radio Frequency Interference Statement**

This equipment has been tested and found to comply with the limits for a class B digital device, pursuant to part 15 of the FCC rules. These limits are designed to provide reasonable protection against harmful interference when the equipment is operated in a commercial environment. This equipment generates, uses and can radiate radio frequency energy and, if not installed and used in accordance with the instruction manual, may cause harmful interference to radio communications. Operation of this equipment in a residential area is likely to cause harmful interference, in which case the user will be required to correct the interference at his own expense.

**Notice 1**

The changes or modifications not expressly approved by the party responsible for compliance could void the user's authority to operate the equipment.

**Notice 2**

Shielded interface cables and A.C. power cord, if any, must be used in order to comply with the emission limits.

**VOIR LA NOTICE D'INSTALLATION AVANT DE RACCORDER AU RESEAU.**

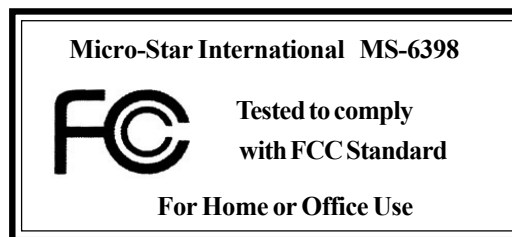

## **Edition**

Dec. 2001

## **Copyright Notice**

The material in this document is the intellectual property of **MICRO-STAR INTERNATIONAL**. We take every care in the preparation of this document, but no guarantee is given as to the correctness of its contents. Our products are under continual improvement and we reserve the right to make changes without notice.

## **Trademarks**

All trademarks used in this manual are the property of their respective owners.

Intel and Pentium are registered trademarks of Intel Corporation.

PS/2 and OS/2 are registered trademarks of IBM Corporation.

Windows 95/98/2000 and Windows NT are registered trademarks of Microsoft.

Netware is a registered trademark of Novell.

Award is a registered trademark of Award Software Inc.

## **Revision History**

<b>Revision</b>	<b>Revision History</b>	<b>Date</b>
V2.0	Changing to Full ATX form factor	Dec. 2001

## Safety Instructions

1. Always read the safety instructions carefully.
2. Keep this User's Manual for future reference.
3. Keep this equipment away from humidity.
4. Lay this equipment on a reliable flat surface before setting it up.
5. The openings on the enclosure are for air convection hence protects the equipment from overheating. **DO NOT COVER THE OPENINGS.**
6. Make sure the voltage of the power source and adjust properly 110/220V before connecting the equipment to the power inlet.
7. Place the power cord such a way that people can not step on it. Do not place anything over the power cord.
8. Always Unplug the Power Cord before inserting any add-on card or module.
9. All cautions and warnings on the equipment should be noted.
10. Never pour any liquid into the opening that could damage or cause electrical shock.
11. If any of the following situations arises, get the equipment checked by a service personnel:
  - The power cord or plug is damaged
  - Liquid has penetrated into the equipment
  - The equipment has been exposed to moisture
  - The equipment has not work well or you can not get it work according to User's Manual.
  - The equipment has dropped and damaged
  - If the equipment has obvious sign of breakage
12. **DO NOT LEAVE THIS EQUIPMENT IN AN ENVIRONMENT UNCONDITIONED, STORAGE TEMPERATURE ABOVE 60°C (140°F), IT MAY DAMAGE THE EQUIPMENT.**



**CAUTION:** Danger of explosion if battery is incorrectly replaced. Replace only with the same or equivalent type recommended by the manufacturer.

## CONTENTS

<b>Chapter 1. Getting Started .....</b>	<b>1-1</b>
Mainboard Specification .....	1-2
Mainboard Layout .....	1-4
Quick Components Guide .....	1-7
Key Features .....	1-8
MSI Special Features .....	1-9
Fuzzy Logic™ III .....	1-9
PC Alert™ III .....	1-10
D-Bracket™ .....	1-12
Live BIOS™/Live Driver™ .....	1-14
<b>Chapter 2. Hardware Setup .....</b>	<b>2-1</b>
Central Processing Unit: CPU .....	2-2
CPU Installation Procedures .....	2-2
Installing the CPU Fan .....	2-3
CPU Core Speed Derivation Procedure .....	2-4
Memory .....	2-5
Introduction to DDR SDRAM .....	2-5
DDR Module Combination .....	2-6
Installing DDR Modules .....	2-6
Power Supply .....	2-7
ATX 20-Pin Power Connector: JWR1 .....	2-7
ATX 12V Power Connector: JPW1 .....	2-7
Back Panel .....	2-8
Mouse Connector: JKBMS1 .....	2-8
Keyboard Connector: JKBMS1 .....	2-9
USB Connectors .....	2-9
Serial Port Connector: COM A & COM B .....	2-10
Joystick/Midi Connectors .....	2-10
Audio Port Connectors .....	2-10

Parallel Port Connector: LPT1 .....	2-11
Connectors .....	2-12
Floppy Disk Drive Connector: FDD1 .....	2-12
IrDA Infrared Module Header: IR2 .....	2-12
Hard Disk Connectors: IDE1 & IDE2 .....	2-13
ATA133 RAID Connectors: IDE3 & IDE4 .....	2-14
CD-In Connector: JCD1 .....	2-15
Aux Line-In Connector: JAUX1 .....	2-15
Modem-In Connector: JPHN1 .....	2-15
Fan Power Connectors: CFAN1/SFAN1/J7 .....	2-16
Wake On Ring Connector: JMDM1 .....	2-17
Wake On LAN Connector: JWOL1 .....	2-17
Front Panel Connector: JFP1 or F_P2 .....	2-18
Front Panel Audio Connector: JAU1 .....	2-19
Front USB Connectors: JUSB2/3/4 & USB3 .....	2-20
D-Bracket™ Connector: J10 .....	2-23
Jumpers .....	2-24
Clear CMOS Jumper: JBAT1 .....	2-24
Slots .....	2-25
AGP (Accelerated Graphics Port) Slot .....	2-25
PCI Slots .....	2-25
CNR (Communication Network Riser) .....	2-26
PCI Interrupt Request Routing .....	2-26
<b>Chapter 3. BIOS Setup .....</b>	<b>3-1</b>
Entering Setup .....	3-2
Control Keys .....	3-2
Getting Help .....	3-3
The Main Menu .....	3-4
Standard CMOS Features .....	3-6

Advanced BIOS Features .....	3-8
Advanced Chipset Features .....	3-12
Integrated Peripherals .....	3-14
Power Management Setup .....	3-18
PNP/PCI Configurations .....	3-22
PC Health Status .....	3-24
Frequency/Voltage Control .....	3-25
Load Fail-Safe/Optimized Defaults .....	3-27
Set Supervisor/User Password .....	3-28
<b>Appendix A: Using 4-/6-channel Audio Function .....</b>	<b>A-1</b>
Installing C-Media Drivers .....	A-2
Hardware Configuration .....	A-2
Software Configuration .....	A-3
<b>Appendix B: MSI Smart Key .....</b>	<b>B-1</b>
Installing MSI Smart Key .....	B-2
Using MSI Smart Key .....	B-3
<b>Glossary .....</b>	<b>G-1</b>

---

# Getting Started **1**

Thank you for purchasing the MS-6398 v2.X ATX mainboard. The MS-6398 v2.X series include 845 Ultra, 845 Ultra-AR, and 845 Ultra-ARU mainboards. The 845 Ultra is a standard version. In addition to standard features, the 845 Ultra-AR offers ATA133 RAID interface and the 845 Ultra-ARU supports ATA133 RAID and USB 2.0 technology. All three models are based on Intel® 82845 & 82801BA chipsets for optimal system efficiency. Designed to fit the advanced Intel® Pentium® 4 processors in the 478 pin package, the MS-6398 delivers a high performance and professional desktop platform solution.

## **TOPICS**

<i>Mainboard Specification</i>	<i>1-2</i>
<i>Mainboard Layout</i>	<i>1-4</i>
<i>Quick Components Guide</i>	<i>1-7</i>
<i>Key Features</i>	<i>1-8</i>
<i>MSI Special Features</i>	<i>1-9</i>



## Mainboard Specification

---

### CPU

- Supports Intel® Pentium® 4 processor in 478 pin package.
- Supports 1.5GHz, 1.6GHz, 1.7GHz, 1.8GHz, 1.9GHz, 2GHz, 2.1GHz, 2.2GHz and up.

### Chipset

- Intel® 845 chipset (593 FC-BGA)
  - Supports DDR SDRAM at 200/266MHz operation (DDR200/DDR266).
  - AGTL+ host bus with integrated termination supporting 32-bit host addressing.
  - 1.5V AGP interface with 4x data transfer and 4x fast write capability.
  - 8-bit, 66MHz 4x hub interface to the Intel ICH2.
- Intel® ICH2 chipset (360 EBGA)
  - Upstream hub interface for access to the Intel MCH.
  - 2-channel Ultra ATA/100 Bus Master IDE controller.
  - USB controller 1.1 (expanded capabilities for 4 ports).
  - I/O APIC.
  - SMBus controller.
  - FWH interface.
  - LPC interface.
  - AC'97 2.1 interface.
  - PCI 2.2 interface.
  - Integrated system management controller.

### Main Memory

- Supports four memory banks using three 184-pin DDR DIMM.
- Supports up to 2GB PC2100/PC1600 DDR SDRAMs.
- Supports 2.5v DDR SDRAM.

### Slots

- One AGP (Accelerated Graphics Port) 4x slot (1.5V only).
- Five PCI 2.2 32-bit Master PCI bus slots (support 3.3V/5V PCI bus interface).
- One CNR (Communication Network Riser) slot.



**Note:** The AGP slot **DOES NOT support 3.3V AGP card**. Use of 3.3V AGP card may cause damage to the mainboard.

**On-Board IDE**

- An IDE controller on the ICH2 chipset provides IDE HDD/CD-ROM with PIO, Bus Master and Ultra DMA66/100 operation modes.
- Can connect up to four IDE devices.
- ATA133 RAID supported by Promise PDC20276 (for *845 Ultra-AR* & *845 Ultra-ARU* only).

**USB Interface**

- 845 Ultra/ 845 Ultra-AR
  - 4 USB 1.1 ports (Rear \* 2/ Front \* 2).
- 845 Ultra-ARU
  - 4 USB 2.0 ports (Front \* 4/ optional USB 2.0 Bracket available upon request, please refer to *Chapter 2. Hardware Setup* for further details).
  - 4 USB 1.1 ports (Rear \* 2/ Front \* 2).

**On-Board Peripherals**

- On-Board Peripherals include:
  - 1 floppy port supports 2 FDDs with 360K, 720K, 1.2M, 1.44M and 2.88Mbytes.
  - 2 serial ports (COM A + COM B).
  - 1 parallel port supports SPP/EPP/ECP mode.
  - 1 IrDA connector for SIR/ASKIR/HPSIR.
  - 1 D-Bracket™ pin header.
  - 1 audio/game port.

**Audio**

- C-Media CMI8738 / PCI-6ch supports 2/4/6 ch speaker.

**BIOS**

- The mainboard BIOS provides “Plug & Play” BIOS which detects the peripheral devices and expansion cards of the board automatically.
- The mainboard provides a Desktop Management Interface (DMI) function which records your mainboard specifications.

**Dimension**

- Full ATX Form Factor: 30.5cm x 25cm.

**Mounting**

- 9 mounting holes.

Chapter 1

# Mainboard Layout

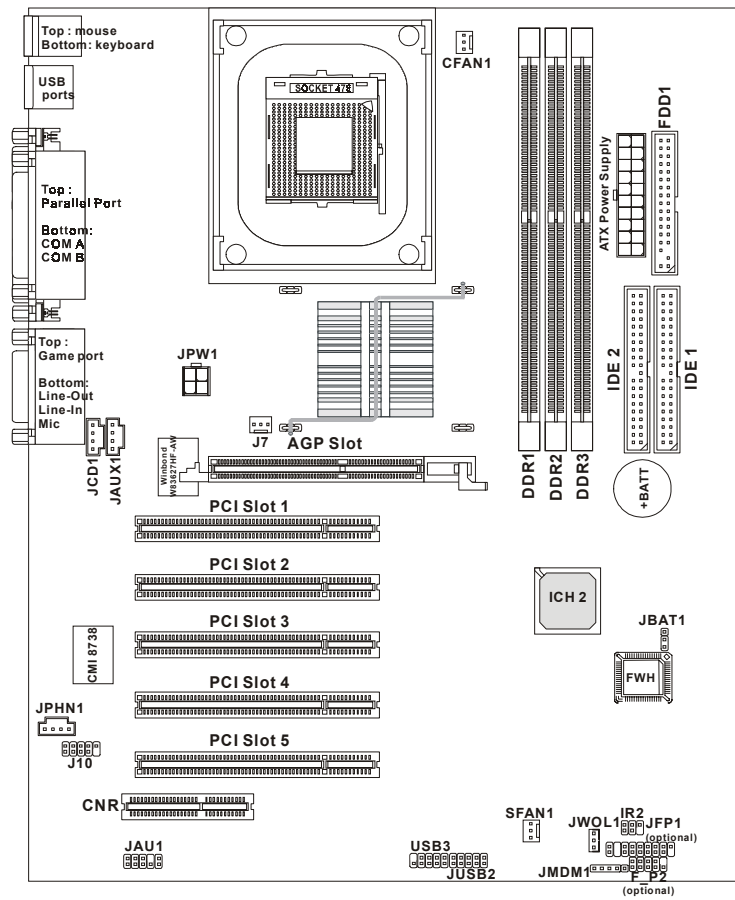

845 Ultra (MS-6398 v2.X) ATX Mainboard

Getting Started

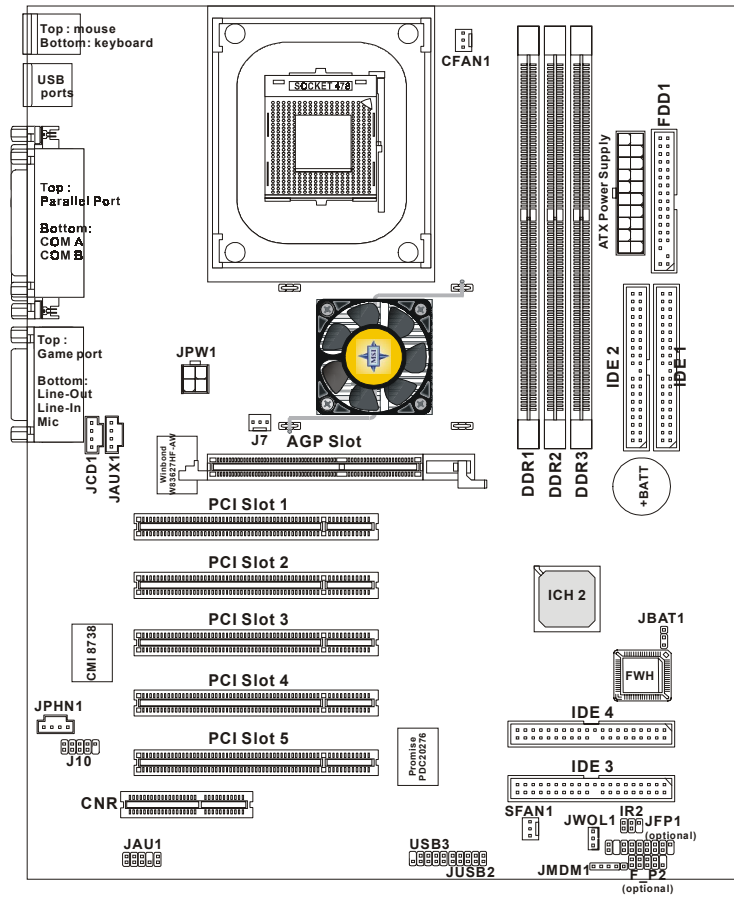

845 Ultra-AR (MS-6398 v2.X) ATX Mainboard

Chapter 1

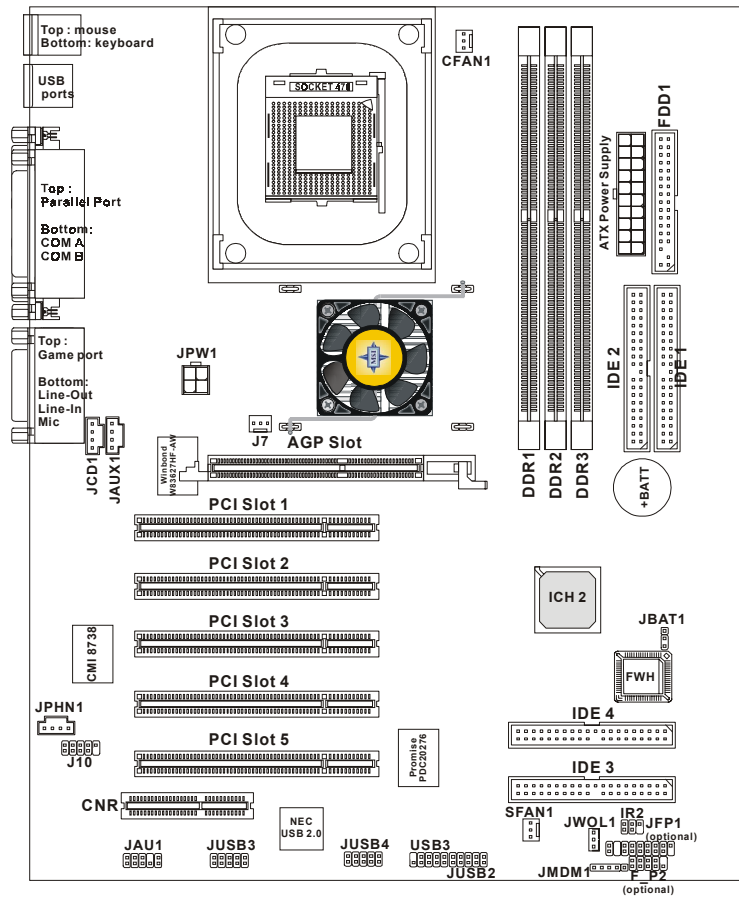

845 Ultra-ARU (MS-6398 v2.X) ATX Mainboard

## Quick Components Guide

---

Component	Function	Reference
JWR1	ATX 20-pin power connector	See p. 2-7
JPW1	ATX 12V power connector	See p. 2-7
JKBMS1	Mouse connector	See p. 2-8
JKBMS1	Keyboard connector	See p. 2-9
USB Connectors	Connecting to USB devices	See p. 2-9
COM A & COM B	Serial port connector	See p. 2-10
LPT1	Parallel port connector	See p. 2-11
FDD1	Floppy disk drive connector	See p. 2-12
IR2	IrDA infrared module connector	See p. 2-12
IDE1~ IDE2	Hard disk connectors	See p. 2-13
IDE3~IDE4	ATA133 RAID connectors	See p. 2-14
JCD1	CD-in connector	See p. 2-15
JAUX1	Aux line-in connector	See p. 2-15
JPHN1	Modem-in connector	See p. 2-15
CFAN1/SFAN1	Fan power connectors	See p. 2-16
JMDM1	Wake on ring connector	See p. 2-17
JWOL1	Wake on LAN connector	See p. 2-17
JFP1/F_P2	Front panel connector	See p. 2-18
JAU1	Front panel audio connector	See p. 2-19
JUSB2/3/4 & USB3	Front USB connectors	See p. 2-20
J10	D-Bracket connector	See p. 2-23
JBAT1	Clear CMOS jumper	See p. 2-24
AGP Slot	Connecting to AGP cards	See p. 2-25
PCI Slots	Connecting to expansion cards	See p. 2-25
CNR Slot	Connecting to expansion cards	See p. 2-26

## Chapter 1

### Key Features

---

- Full ATX Form Factor
- CPU: Intel® Pentium® 4 processor in the 478 pin package
- ATA133 RAID supported by Promise PDC20276 (for 845 Ultra-AR & 845 Ultra-ARU only).
- USB 2.0 technology (for 845 Ultra-ARU only)
- C-Media CMI8738/PCI-6ch supports 2/4/6 channel speaker
- Fuzzy Logic™ III
- Live BIOS™ / Live Driver™
- Smart Key™ - the best solution to prevent unauthorized access to your PC
- PC Alert™ III system hardware monitor
- D-Bracket™
- LAN Wake Up Function
- Modem (Internal/External) Ring Wake Up Function
- Suspend to RAM/Disk
- PC2001 Compliant

## MSI Special Features

---

### Fuzzy Logic™ III

The Fuzzy Logic™ III utility allows users to overclock the CPU FSB (Front Side Bus) frequency in the Windows environment. Select the CPU frequency you prefer and click *Go* to apply the frequency or click *Save* allowing the system to run at the specified frequency each time when the system is powered on.

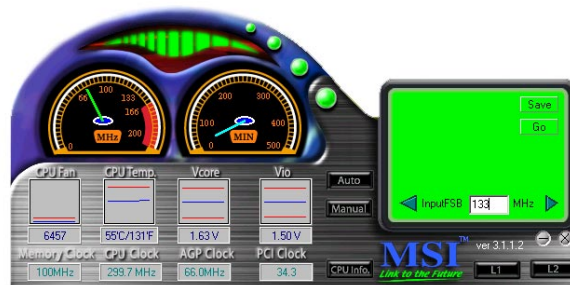

#### Features:

- Display Current System Status
  - CPU Fan
  - CPU Temp.
  - Vcore
  - Vio
  - Memory Clock
  - CPU Clock
  - AGP Clock
  - PCI Clock
- Adjust CPU FSB Frequency



## Chapter 1

### PC Alert™ III

The PC Alert™ III is a utility you can find in the CD-ROM disk. The utility is just like your PC doctor that can detect the following PC hardware status during real time operation:

- \* monitor CPU & system temperatures
- \* monitor fan speed(s)
- \* monitor system voltage
- \* monitor chassis intrusion

If one of the items above is abnormal, the program main screen will be immediately shown on the screen, with the abnormal item highlighted in red. This will continue to be shown until users disable the warning.

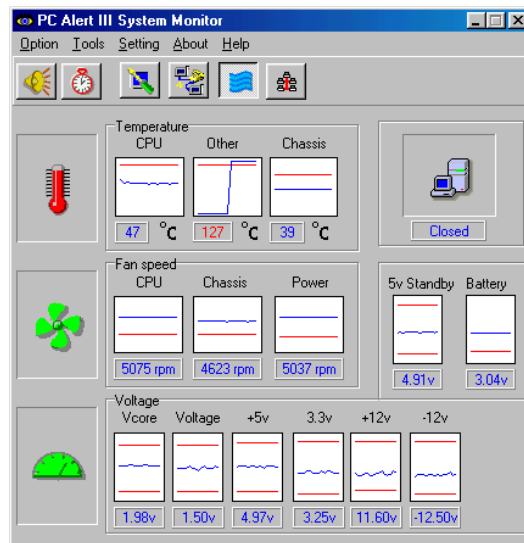

 **Note:** Items shown on PC Alert III vary depending on your system's status.

## *Getting Started*



### **Features:**

- Network Management
  - Monitoring & remote control
- Basic System Utilities
  - Scandisk & Defragment to maintain your HDD
- 3D Graphics Design
  - Enables a more friendly user interface
- Software Utilities
  - SoftCooler Optimized Cooling

Chapter 1

**D-Bracket™**

D-Bracket™ is an external USB bracket integrating four Diagnostic LEDs, which use graphic signal display to help users understand their system. The LEDs provide up to 16 combinations of signals to debug the system. The 4 LEDs can debug all problems that fail the system, such as VGA, RAM or other failures. This special feature is very useful for the overclocking users. These users can use the feature to detect if there are any problems or failures.



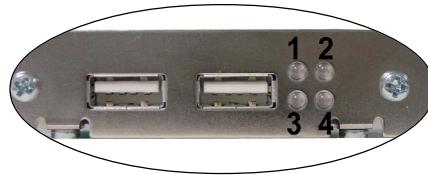







**D-Bracket™**



● Red      ○ Green

D-Bracket	Description
	<p>System Power ON</p> <p>- The D-LED will hang here if the processor is damaged or not installed properly.</p>
	<p>Early Chipset Initialization</p>
	<p>Memory Detection Test</p> <p>- Testing onboard memory size. The D-LED will hang if the memory module is damaged or not installed properly.</p>
	<p>Decompressing BIOS image to RAM for fast booting.</p>
	<p>Initializing Keyboard Controller.</p>
	<p>Testing VGA BIOS</p> <p>- This will start writing VGA sign-on message to the screen.</p>

*Getting Started*

D-Bracket	Description
 <p>1 ● ○ 2 3 ○ ● 4</p>	<p>Processor Initialization</p> <p>- This will show information regarding the processor (like brand name, system bus, etc...)</p>
	<p>Testing RTC (Real Time Clock)</p>
	<p>Initializing Video Interface</p> <p>- This will start detecting CPU clock, checking type of video onboard. Then, detect and initialize the video adapter.</p>
	<p>BIOS Sign On</p> <p>- This will start showing information about logo, processor brand name, etc....</p>
	<p>Testing Base and Extended Memory</p> <p>- Testing base memory from 240K to 640K and extended memory above 1MB using various patterns.</p>
	<p>Assign Resources to all ISA.</p>
	<p>Initializing Hard Drive Controller</p> <p>- This will initialize IDE drive and controller.</p>
	<p>Initializing Floppy Drive Controller</p> <p>- This will initializing Floppy Drive and controller.</p>
	<p>Boot Attempt</p> <p>- This will set low stack and boot via INT 19h.</p>
	<p>Operating System Booting</p>

## Chapter 1

### Live BIOS™/Live Driver™

The Live BIOS™ & Live Driver™ is a tool used to detect and update your BIOS and drivers online so that you don't need to search for the correct BIOS or drivers version through the whole web site. To use the function, you need to install the "MSI Live Update Series" application. After installation, the "MSI Live Update Series" icon (as the right view) will appear on the screen.



Double click the "MSI Live Update Series" icon, and the following screen will appear.

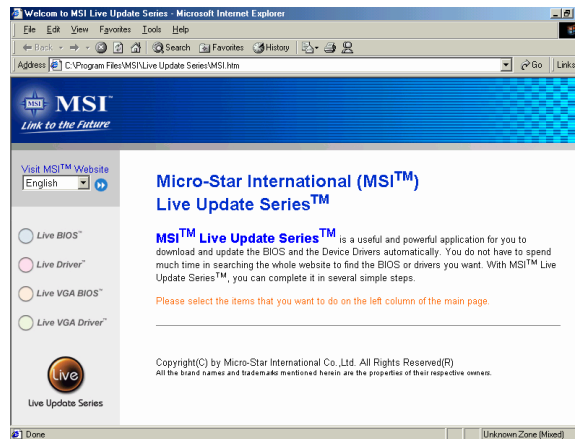

Four buttons are placed on the left column of the screen. Click the desired button to start the update process.

- **Live BIOS** – Updates the BIOS online. If your motherboard does not support the function, the "sorry" message is displayed.
- **Live Driver** – Updates the drivers online. If your motherboard does not support the function, the "sorry" message is displayed.
- **Live VGA BIOS** – Updates the VGA BIOS online. If your VGA device does not support the function, the "sorry" message appears.
- **Live VGA Driver** – Updates the VGA driver online. If your VGA device does not support the function, the "sorry" message is displayed.

For more information on the update instructions, insert the companion CD and refer to the "Live Update Series Guide" under the "Manual" tab.

---

# *Hardware Setup* **2**

This chapter provides you with the information about hardware setup procedures. While doing the installation, be careful in holding the components and follow the installation procedures. For some components, if you install in the wrong orientation, the components will not work properly.

Use a grounded wrist strap before handling computer components. Static electricity may damage the components.

## **TOPICS**

<i>Central Processing Unit: CPU</i>	2-2
<i>Memory</i>	2-5
<i>Power Supply</i>	2-7
<i>Back Panel</i>	2-8
<i>Connectors</i>	2-12
<i>Jumpers</i>	2-24
<i>Slots</i>	2-25

## Chapter 2

### Central Processing Unit: CPU

The mainboard supports Intel® Pentium® 4 processor in the 478 pin package. The mainboard uses a CPU socket called PGA478 for easy CPU installation. When you are installing the CPU, **make sure the CPU has a heat sink and a cooling fan attached on the top to prevent overheating.** If you do not find the heat sink and cooling fan, contact your dealer to purchase and install them before turning on the computer.

#### CPU Installation Procedures

1. Pull the lever sideways away from the socket. Then, raise the lever up to a 90-degree angle.
2. Look for the dot/cut edge. The dot/cut edge should point towards the lever pivot. The CPU will only fit in the correct orientation.
3. Hold the CPU down firmly, and then close the lever to complete the installation.

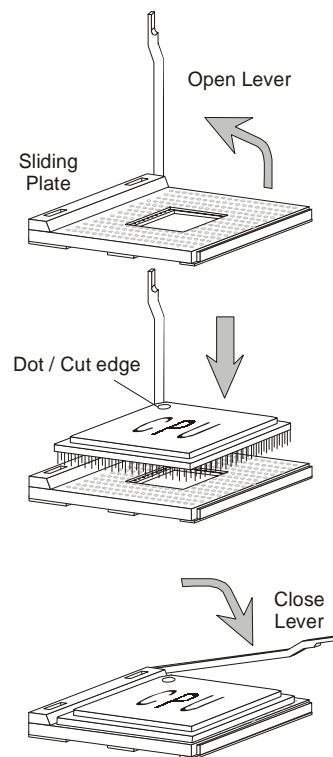

**WARNING!**

*Overheating will seriously damage the CPU and system, always make sure the cooling fan can work properly to protect the CPU from overheating.*

**Installing the CPU Fan**

As processor technology pushes to faster speeds and higher performance, thermal management becomes increasingly important. To dissipate heat, you need to attach the CPU cooling fan and heatsink on top of the CPU. Follow the instructions below to install the Heatsink/Fan:

- 1.** Locate the CPU and its retention mechanism on the motherboard.
- 2.** Position the heatsink onto the retention mechanism.

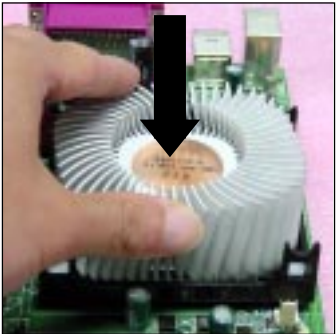
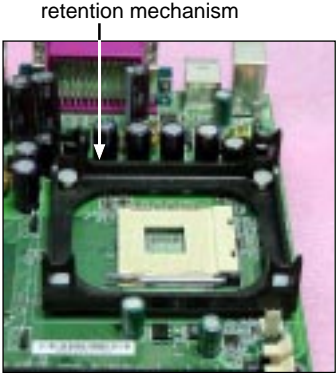

- 3.** Mount the fan on top of the heatsink. Press down the fan until its four clips get wedged in the holes of the retention mechanism.
- 4.** Press the two levers down to fasten the fan. Each lever can be pressed down in only ONE direction.

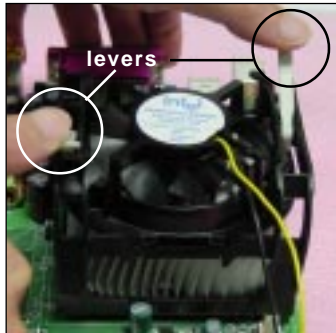
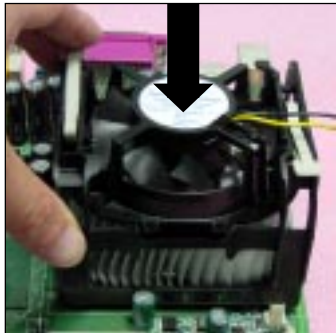



## Chapter 2

5. Connect the fan power cable from the mounted fan to the 3-pin fan power connector on the board.

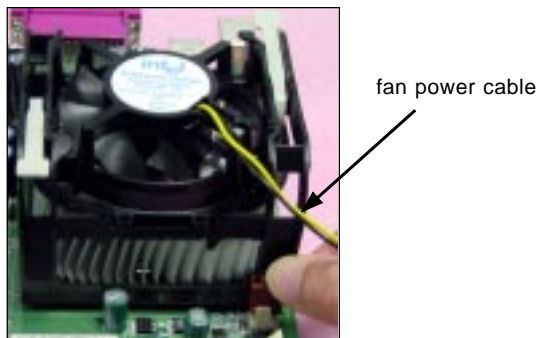

---

### CPU Core Speed Derivation Procedure

**If** CPU Clock = 100MHz  
Core/Bus ratio = 14  
**then** CPU core speed = Host Clock x Core/Bus ratio  
= 100MHz x 14  
= 1.4GHz



#### **Overclocking**

*This motherboard is designed to support overclocking. However, please make sure your components are able to tolerate such abnormal setting, while doing overclocking. Any attempt to operate beyond product specifications is not recommended. We do not guarantee the damages or risks caused by inadequate operation or beyond product specifications.*

## Memory

The mainboard provides 3 slots for 184-pin, 2.5V DDR DIMM with 4 memory banks. You can install PC1600/PC2100 DDR SDRAM modules on the DDR DIMM slots (DDR 1~3). To operate properly, at least one DIMM module must be installed.

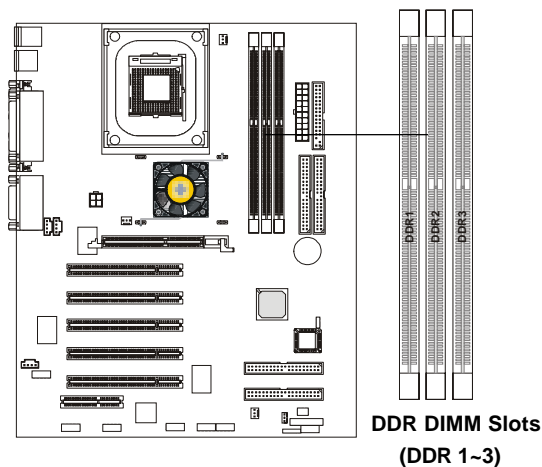

### Introduction to DDR SDRAM

DDR (Double Data Rate) SDRAM is similar to conventional SDRAM, but doubles the rate by transferring data twice per cycle. It uses 2.5 volts as opposed to 3.3 volts used in SDR SDRAM, and requires 184-pin DIMM modules rather than 168-pin DIMM modules used by SDR SDRAM. Two types of DDR are available at the time of writing: PC1600 & PC2100. PC1600 DDR SDRAM running at 100MHz will produce about 1.6GB/s memory bandwidth. PC2100 running at 133MHz will produce 2.1GB/s memory bandwidth. High memory bandwidth makes DDR an ideal solution for high performance PC, workstations and servers.

 *Note: DIMM 1~3 is separately 2-memory-bank capable. But as Intel® 82845 chipset supports only 4 DDR memory banks, the total memory banks installed cannot exceed the maximum quantity of 4. Improper memory installation may possibly cause malfunction.*

## Chapter 2

### DDR Module Combination

To enable normal operation, at least one DIMM module should be installed on the motherboard. As Intel® 82845 chipset supports 4 DDR memory banks at its maximum, the system memory installed can be up to 2GB.

All three slots can be single-sidedly or double-sidedly installed with 184-pin DDR DIMM modules. Please especially note that DDR 1 alone occupies two memory banks; the rest two banks are shared by DDR 2 & DDR 3. You may install memory modules in the following combination:

Slot	Combination		
	1	2	3
DDR 1	S/D	S/D	S/D
DDR 2	D	S	
DDR 3		S	D
Total Memory	64MB~2GB	64MB~2GB	64MB~2GB

S (Single Side): 64MB ~ 512MB

D (Double Side): 128MB ~ 1GB

### Installing DDR Modules

1. The DDR DIMM has only one notch on the center of module. The module will only fit in the right orientation.
2. Insert the DIMM memory module vertically into the DIMM slot. Then push it in.

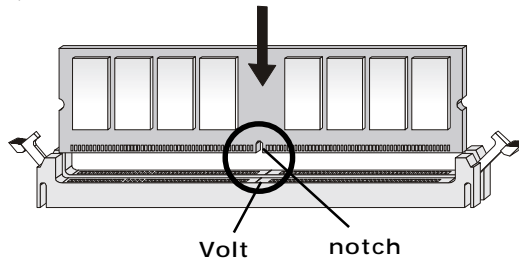

3. The plastic clip at each side of the DIMM slot will automatically close.

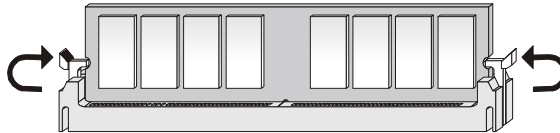

## Power Supply

The mainboard supports ATX power supply for the power system. Before inserting the power supply connector, always make sure that all components are installed properly to ensure that no damage will be caused.

### ATX 20-Pin Power Connector: JWR1

This connector allows you to connect to an ATX power supply. To connect to the ATX power supply, make sure the plugs of the power supply is inserted in the proper orientation and the pins are aligned. Then push down the power supply firmly into the connector. The power connector supports **instant power on** function which means that system will boot up immediately when the power supply connector is inserted on the board.

### ATX 12V Power Connector: JPW1

This 12V power connector is used to provide power to the CPU.

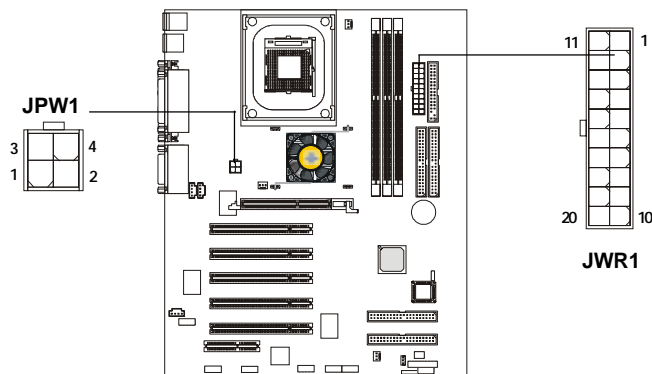

JPW1 Pin Definition

PIN	SIGNAL
1	GND
2	GND
3	12V
4	12V

JWR1 Pin Definition

PIN	SIGNAL	PIN	SIGNAL
1	3.3V	11	3.3V
2	3.3V	12	-12V
3	GND	13	GND
4	5V	14	PS_ON
5	GND	15	GND
6	5V	16	GND
7	GND	17	GND
8	PW_OK	18	-5V
9	5V_SB	19	5V
10	12V	20	5V

## Chapter 2

### Back Panel

---

The Back Panel provides the following connectors:

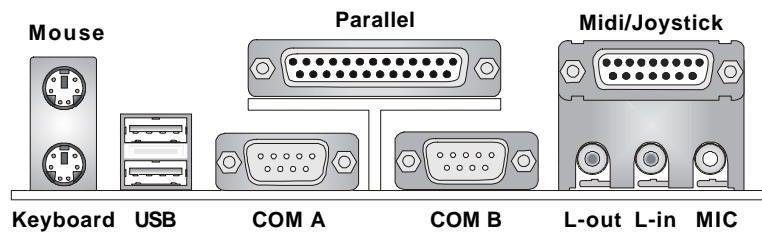

---

#### Mouse Connector: JKBMS1

The mainboard provides a standard PS/2<sup>®</sup> mouse mini DIN connector for attaching a PS/2<sup>®</sup> mouse. You can plug a PS/2<sup>®</sup> mouse directly into this connector. The connector location and pin assignments are as follows:

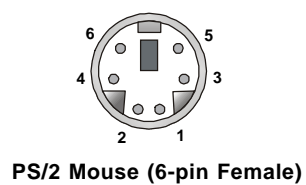

PS/2 Mouse (6-pin Female)

Pin Definition

PIN	SIGNAL	DESCRIPTION
1	Mouse DATA	Mouse DATA
2	NC	No connection
3	GND	Ground
4	VCC	+5V
5	Mouse Clock	Mouse clock
6	NC	No connection

**Keyboard Connector: JKBMS1**

The mainboard provides a standard PS/2<sup>®</sup> keyboard mini DIN connector for attaching a PS/2<sup>®</sup> keyboard. You can plug a PS/2<sup>®</sup> keyboard directly into this connector.

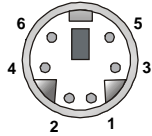

**PS/2 Keyboard (6-pin Female)**

**Pin Definition**

PIN	SIGNAL	DESCRIPTION
1	Keyboard DATA	Keyboard DATA
2	NC	No connection
3	GND	Ground
4	VCC	+5V
5	Keyboard Clock	Keyboard clock
6	NC	No connection

**USB Connectors**

The mainboard provides a UHCI (Universal Host Controller Interface) Universal Serial Bus root for attaching USB devices such as keyboard, mouse or other USB-compatible devices. You can plug the USB device directly into this connector.

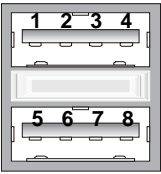

**USB Ports**

**USB Port Description**

PIN	SIGNAL	DESCRIPTION
1	VCC	+5V
2	-Data 0	Negative Data Channel 0
3	+Data0	Positive Data Channel 0
4	GND	Ground
5	VCC	+5V
6	-Data 1	Negative Data Channel 1
7	+Data 1	Positive Data Channel 1
8	GND	Ground

## Chapter 2

### Serial Port Connector: COM A & COM B

The mainboard offers two 9-pin male DIN connectors for serial port COM A and COM B. The ports are 16550A high speed communication ports that send/receive 16 bytes FIFOs. You can attach a serial mouse or other serial devices directly to them.

Pin Definition		
PIN	SIGNAL	DESCRIPTION
1	DCD	Data Carry Detect
2	SIN	Serial In or Receive Data
3	SOUT	Serial Out or Transmit Data
4	DTR	Data Terminal Ready)
5	GND	Ground
6	DSR	Data Set Ready
7	RTS	Request To Send
8	CTS	Clear To Send
9	RI	Ring Indicate

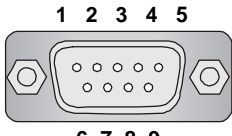

1 2 3 4 5  
6 7 8 9

9-Pin Male DIN Connectors

---

### Joystick/Midi Connectors

You can connect a joystick or game pad to this connector.

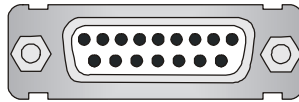

### Audio Port Connectors

**Line Out** is a connector for Speakers or Headphones. **Line In** is used for external CD player, Tape player, or other audio devices. **Mic** is a connector for microphones.

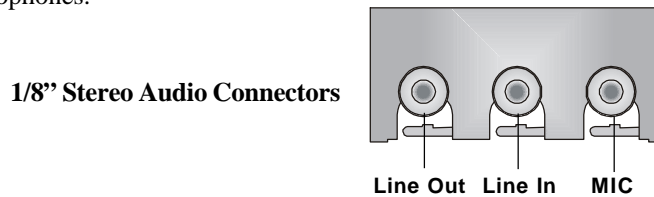

 *Note: Details on the application of 6-channel audio can be acquired in Appendix A.*

**Hardware Setup**

**Parallel Port Connector: LPT1**

The mainboard provides a 25-pin female centronic connector for LPT. A parallel port is a standard printer port that supports Enhanced Parallel Port (EPP) and Extended Capabilities Parallel Port (ECP) mode.

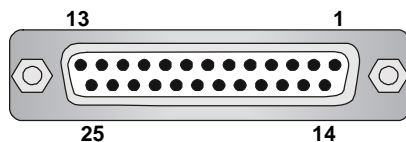

**Pin Definition**

PIN	SIGNAL	DESCRIPTION
1	STROBE	Strobe
2	DATA0	Data0
3	DATA1	Data1
4	DATA2	Data2
5	DATA3	Data3
6	DATA4	Data4
7	DATA5	Data5
8	DATA6	Data6
9	DATA7	Data7
10	ACK#	Acknowledge
11	BUSY	Busy
12	PE	Paper End
13	SELECT	Select
14	AUTO FEED#	Automatic Feed
15	ERR#	Error
16	INIT#	Initialize Printer
17	SLIN#	Select In
18	GND	Ground
19	GND	Ground
20	GND	Ground
21	GND	Ground
22	GND	Ground
23	GND	Ground
24	GND	Ground
25	GND	Ground



## Chapter 2

### Connectors

The mainboard provides connectors to connect to FDD, IDE HDD, case, modem, LAN, USB Ports, IR module and CPU/System FAN.

#### Floppy Disk Drive Connector: FDD1

The mainboard provides a standard floppy disk drive connector that supports 360K, 720K, 1.2M, 1.44M and 2.88M floppy disk types.

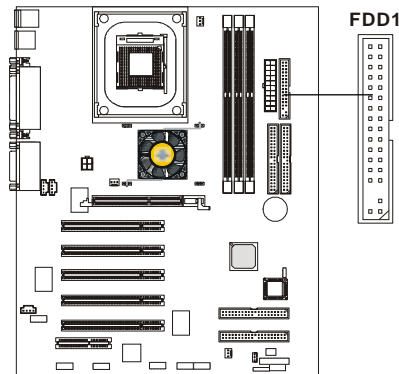

#### IrDA Infrared Module Header: IR2

This connector allows you to connect to IrDA Infrared modules. You must configure the setting through the BIOS setup to use the IR function. The IR2 is compliant to Intel Front Panel I/O Connectivity Design Guide.

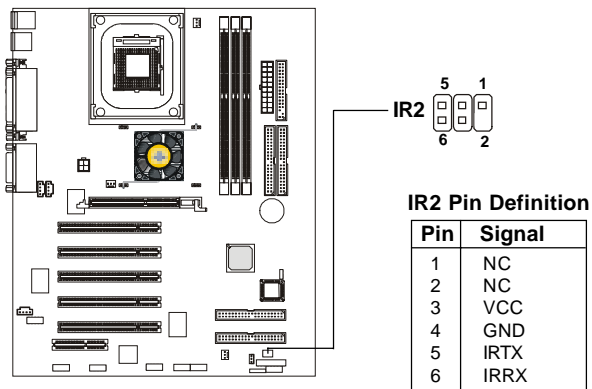

### **Hard Disk Connectors: IDE1 & IDE2**

The mainboard has a 32-bit Enhanced PCI IDE and Ultra DMA 33/66/100 controller that provides PIO mode 0~4, Bus Master, and Ultra DMA/33/66/100 function. You can connect up to four hard disk drives, CD-ROM, 120MB Floppy (reserved for future BIOS) and other devices. These connectors support the provided IDE hard disk cable.

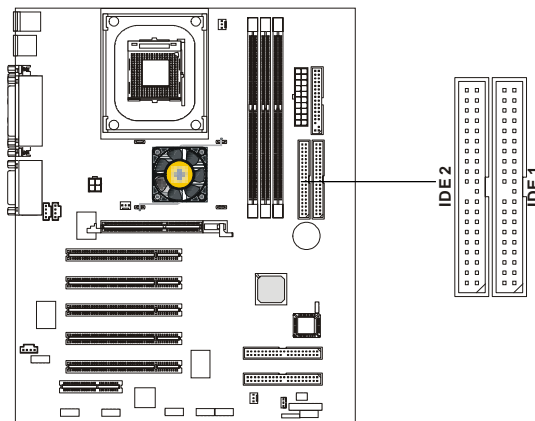

#### **IDE1 (Primary IDE Connector)**

The first hard drive should always be connected to IDE1. IDE1 can connect a Master and a Slave drive. You must configure second hard drive to Slave mode by setting the jumper accordingly.

#### **IDE2 (Secondary IDE Connector)**

IDE2 can also connect a Master and a Slave drive.



#### **TIP:**

*If you install two hard disks on cable, you must configure the second drive to Slave mode by setting its jumper. Refer to the hard disk documentation supplied by hard disk vendors for jumper setting instructions.*

## Chapter 2

### ATA133 RAID Connectors: IDE3 & IDE4

(for 845 Ultra-AR & 845 Ultra-ARU only)

The 845 Ultra-AR & 845 Ultra-ARU mainboards offer high-end Ultra ATA/133 RAID (0 or 1) hard drive interface specifications supported through Promise® PDC20276 controller.

The Ultra ATA/133 interface boosts data transfer rates between the computer and the hard drive up to 133 megabytes (MB) per second. The new interface is one-third faster than earlier record-breaking Ultra ATA/100 technology and is backwards-compatible with the existing Ultra ATA interface.

The low-cost RAID (Redundant Array of Independent Disks) solution integrates two IDE RAID connectors that support PIO mode 0-4, Bus Master, and Ultra DMA 33/66/100/133 modes. The IDE RAID connectors allow you to connect Ultra ATA/DMA hard disks and use RAID technology (RAID 0 striping or RAID 1 mirroring) for high performance, data security and fault tolerance.

#### ATA133 RAID Connectors

- You can connect a Master drive to each IDE RAID connector.
- The two connectors support **hard disk drives** only.
- For more information on ATA133 RAID, please refer to *ATA133 RAID 0 or 1 Quick User's Guide*.

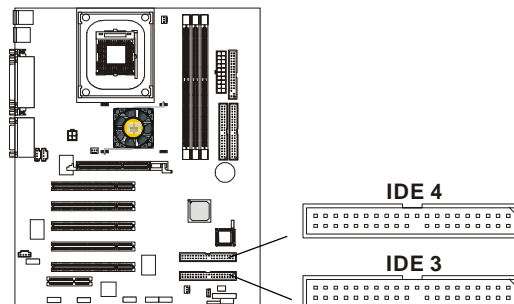

#### TIP:

If you install two hard disks on cable, you must configure the second drive to Slave mode by setting its jumper. Refer to the hard disk documentation supplied by hard disk vendors for jumper setting instructions.

**CD-In Connector: JCD1**

The connector is for CD-ROM audio connector.

**Aux Line-In Connector: JAUX1**

The connector is for DVD add-on card with Line-in connector.

**Modem-In Connector: JPHN1**

The connector is for modem with internal audio connector.

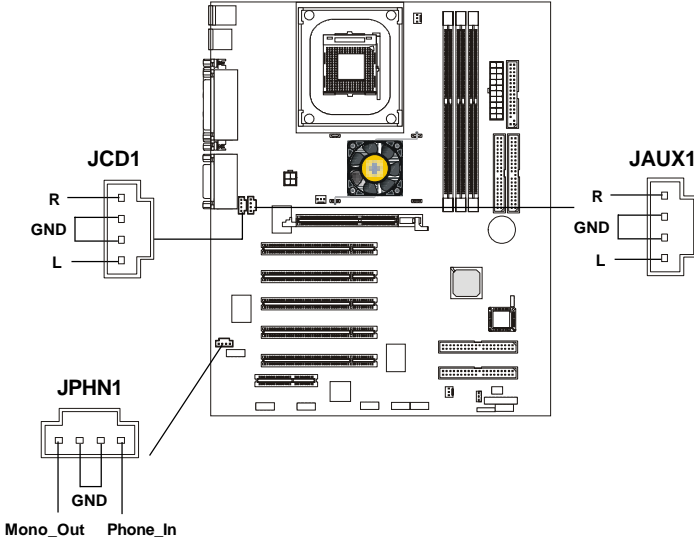

## Chapter 2

### Fan Power Connectors: CFAN1/SFAN1/J7

The CFAN1 (processor fan), J7 (chipset fan) & SFAN1 (system fan) support system cooling fan with +12V. It supports three-pin head connector. When connecting the wire to the connectors, always take note that the red wire is the positive and should be connected to the +12V, the black wire is Ground and should be connected to GND. If the mainboard has a System Hardware Monitor chipset on-board, you must use a specially designed fan with speed sensor to take advantage of the CPU fan control.

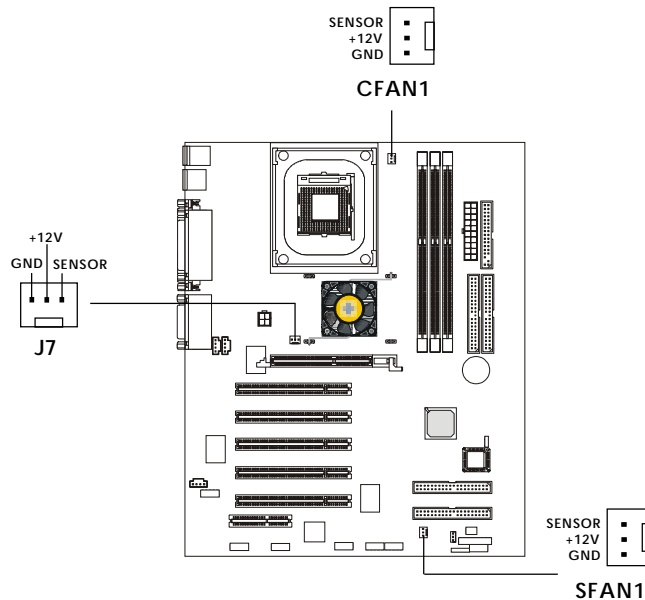

#### Note:

1. Always consult the vendor for proper CPU cooling fan.
2. CPU Fan supports the fan control. You can install the PC Alert utility that will automatically control the CPU Fan speed according to the actual CPU temperature.

**Hardware Setup**

**Wake On Ring Connector: JMDM1**

This connector allows you to connect to a modem card with Wake On Ring function. The connector will power up the system when a signal is received through the modem card.

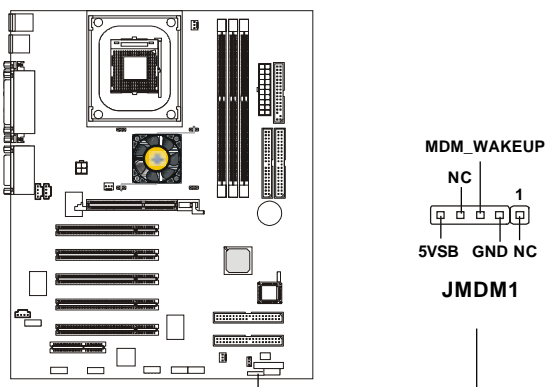

**Wake On LAN Connector: JWOL1**

This connector allows you to connect to a LAN card with Wake On LAN function. You can wake up the computer via remote control through a local area network.

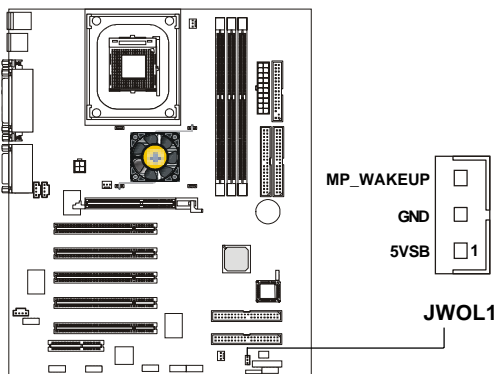

## Chapter 2

### Front Panel Connector: JFP1 or F\_P2

The mainboard provides one front panel connector for electrical connection to the front panel switches and LEDs. Users can choose either the JFP1 or the F\_P2 depending on their needs. The difference between JFP1 & F\_P2 is that F\_P2 is compliant with Intel® Front Panel I/O Connectivity Design Guide.

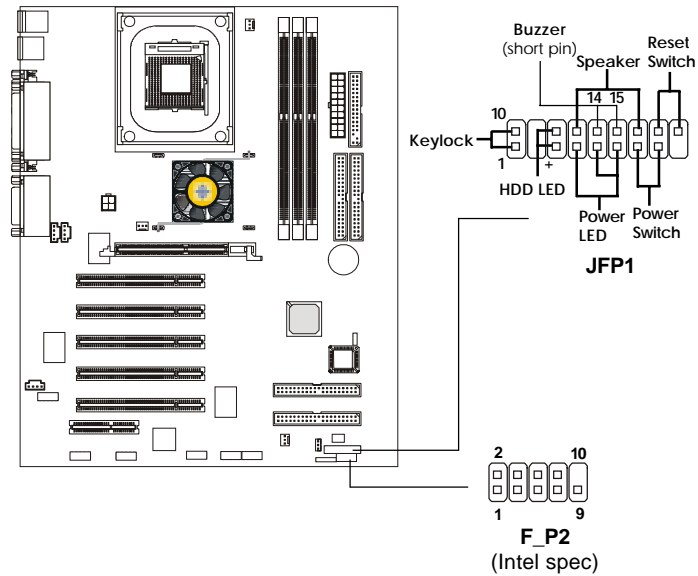

**F\_P2 Pin Definition**

PIN	SIGNAL	DESCRIPTION
1	HD_LED_P	Hard disk LED pull-up
2	FP PWR/SLP	MSG LED pull-up
3	HD_LED_N	Hard disk active LED
4	FP PWR/SLP	MSG LED pull-up
5	RST_SW_N	Reset Switch low reference pull-down to GND
6	PWR_SW_P	Power Switch high reference pull-up
7	RST_SW_P	Reset Switch high reference pull-up
8	PWR_SW_N	Power Switch low reference pull-down to GND
9	RSVD_DNU	Reserved. Do not use.

### Front Panel Audio Connector: JAU1

You can connect an optional audio connector to the JAU1 front panel audio connector. The JAU1 is compliant to Intel® Front Panel I/O Connectivity Design Guide.

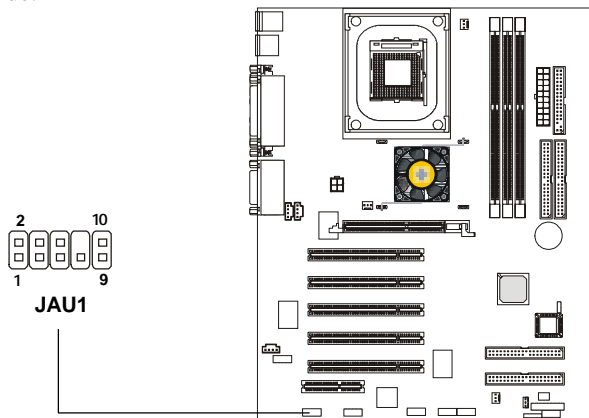

#### Pin Definition

PIN	SIGNAL	DESCRIPTION
1	AUD_MIC	Front panel microphone input signal
2	AUD_GND	Ground used by analog audio circuits
3	AUD_MIC_BIAS	Microphone power
4	AUD_VCC	Filtered +5V used by analog audio circuits
5	AUD_FPOUT_R	Right channel audio signal to front panel
6	AUD_RET_R	Right channel audio signal return from front panel
7	HP_ON	Reserved for future use to control headphone amplifier
8	KEY	No pin
9	AUD_FPOUT_L	Left channel audio signal to front panel
10	AUD_RET_L	Left channel audio signal return from front panel



#### **CAUTION!!!**

If you don't want to connect to the front audio header, pins 5 and 6, 9 and 10 have to be shorted by jumper caps in order to have signal output directed to the rear audio ports.

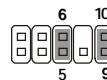



## Chapter 2

### Front USB Connectors: JUSB2/3/4 & USB3

Depending on the model you have purchased, your mainboard could provide ONE or THREE USB (Universal Serial Bus) pin headers that allow you to connect optional USB ports for front panel.

#### 845 Ultra/ 845 Ultra-AR

##### USB 1.1:

The 845 Ultra & 845 Ultra-AR mainboards come with one standard USB 1.1 pin header USB3 that is compliant with Intel® I/O Connectivity Design Guide. An optional JUSB2 header (MSI spec) would be available upon request.

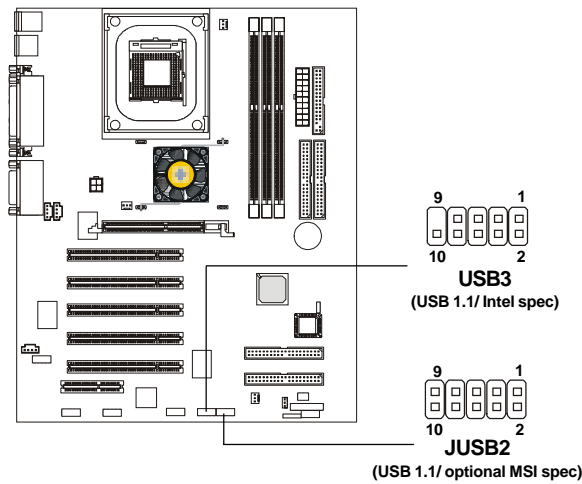

**USB3 Pin Definition**

Pin	Description	Pin	Description
1	VCC	2	VCC
3	USB0-	4	USB1-
5	USB0+	6	USB1+
7	GND	8	GND
9	NC	10	OC0

**JUSB2 Pin Definition**

Pin	Description	Pin	Description
1	VCC	2	GND
3	USB0-	4	GND
5	USB0+	6	USB1+
7	GND	8	USB1-
9	GND	10	VCC

**845 Ultra-ARU**

**USB 1.1:**

The 845 Ultra-ARU mainboard comes with one standard USB 1.1 pin header USB3 that is compliant to Intel® I/O Connectivity Design Guide. An optional JUSB2 header (MSI spec) would be available upon request.

**USB 2.0:**

The 845 Ultra-ARU additionally provides two USB 2.0 pin headers JUSB3 & JUSB4 (optional USB 2.0 Bracket available). USB 2.0 technology increases data transfer rate up to a maximum throughput of 480Mbps, which is 40 times faster than USB 1.1, and is ideal for connecting high-speed USB interface peripherals such as **USB HDD, digital cameras, MP3 players, printers, modems and the like**. It is not recommended to connect low-speed USB legacy keyboard and mouse to the USB 2.0 ports. You should connect the USB legacy devices to the USB rear ports.

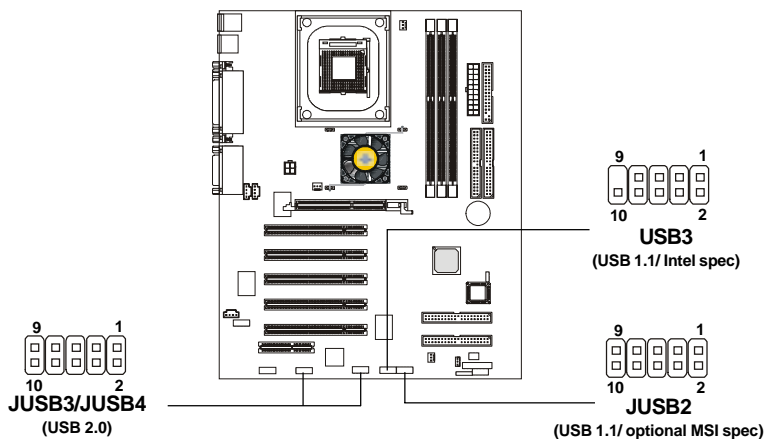

**USB3 Pin Definition**

Pin	Description	Pin	Description
1	VCC	2	VCC
3	USB0-	4	USB1-
5	USB0+	6	USB1+
7	GND	8	GND
9	NC	10	OC0

**JUSB2/3/4 Pin Definition**

Pin	Description	Pin	Description
1	VCC	2	GND
3	USB0-	4	GND
5	USB0+	6	USB1+
7	GND	8	USB1-
9	GND	10	VCC

## Chapter 2

### To Attach the Optional USB 2.0 Ports:

1. Take out the USB 2.0 bracket
2. Locate the JUSB3 and JUSB4 pin headers on the motherboard.
3. Connect the USB cables from USB 2.0 bracket to the JUSB3 and JUSB4 connectors separately.

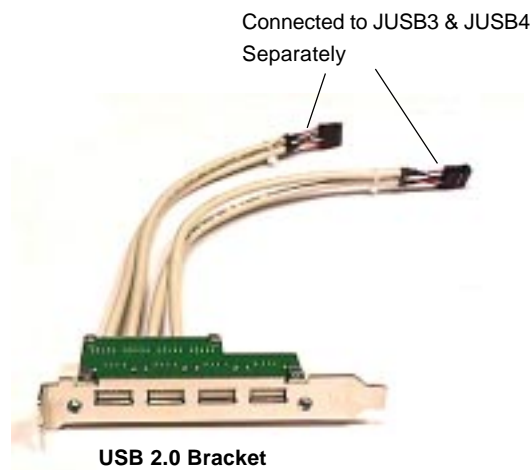

4. Place the USB 2.0 Bracket into the appropriate slot of the system case.



**Note:** The USB 2.0 controller is backwards compatible with USB 1.1 spec. To use the USB 2.0 ports, you still need to install USB 2.0 driver, which is supplied by Microsoft for Windows® 2000 and XP. If you have any problems regarding USB 2.0 driver, please visit Microsoft website for more information.

**D-Bracket™ Connector: J10**

The mainboard comes with a J10 connector for you to connect to D-Bracket™. D-Bracket™ is a USB Bracket integrating four LEDs and allows users to identify system problem through 16 various combinations of LED signals. For definitions of 16 signal combinations, please refer to *Chapter 1. D-Bracket™*.

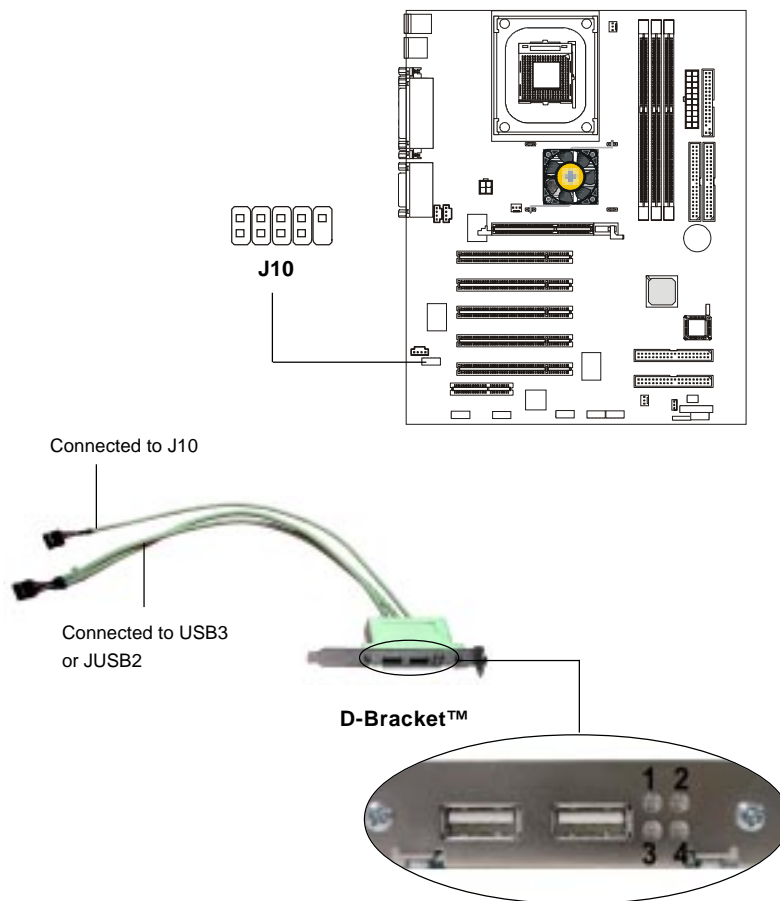

## Chapter 2

# Jumpers

The motherboard provides one jumper for you to set the computer's function. This section will explain how to change your motherboard's function through the use of the jumper.

### Clear CMOS Jumper: JBAT1

There is a CMOS RAM on board that has a power supply from external battery to keep the data of system configuration. With the CMOS RAM, the system can automatically boot OS every time it is turned on. That battery has long life time for at least 5 years. If you want to clear the system configuration, use the JBAT1 (Clear CMOS Jumper ) to clear data. Follow the instructions below to clear the data:

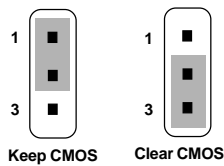
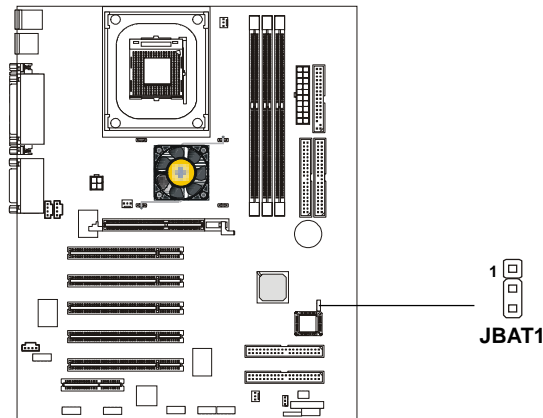

**WARNING!**

*You can clear CMOS by shorting 2-3 pin while the system is off. Then return to 1-2 pin position. Avoid clearing the CMOS while the system is on; it will damage the mainboard.*

## Slots

---

The motherboard provides five 32-bit Master PCI bus slots, one AGP slot and one CNR slot.

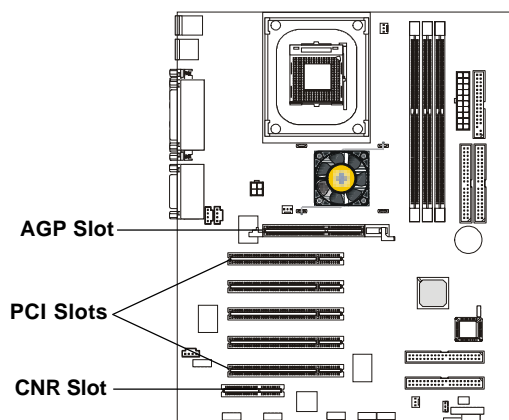

### AGP (Accelerated Graphics Port) Slot

The AGP slot allows you to insert the AGP graphics card. AGP is an interface specification designed for the throughput demands of 3D graphics. It introduces a 66MHz, 32-bit channel for the graphics controller to directly access main memory and provides three levels of throughputs: 1x (266Mbps), 2x (533Mbps) and 4x (1.07Gbps).

 **WARNING!** *The AGP slot **DOES NOT support 3.3V AGP card**. Use of 3.3V AGP card may cause damages to the mainboard. To identify the spec of your AGP card, refer to the documentation supplied with the AGP card or check the view of its contact pins (golden fingers) before you install it.*

### PCI Slots

Five PCI slots allow you to insert the expansion cards to meet your needs. When adding or removing expansion cards, make sure that you unplug the power supply first. Meanwhile, read the documentation for the

## **Chapter 2**

expansioncard to make any necessary hardware or software settings for the expansion card, such as jumpers, switches or BIOS configuration.

### **CNR (Communication Network Riser)**

The CNR slot allows you to insert the CNR expansion cards. CNR is a specially designed network, audio, or modem riser card for ATX family motherboards. Its main processing is done through software and controlled by the motherboard's chipset.

### **PCI Interrupt Request Routing**

The IRQ, abbreviation of interrupt request line and pronounced I-R-Q, are hardware lines over which devices can send interrupt signals to the microprocessor. The PCI IRQ pins are typically connected to the PCI bus INT A# ~ INT D# pins as follows:

	Order 1	Order 2	Order 3	Order 4
PCI Slot 1	INT A#	INT B#	INT C#	INT D#
PCI Slot 2	INT B#	INT C#	INT D#	INT A#
PCI Slot 3	INT C#	INT D#	INT A#	INT B#
PCI Slot 4	INT D#	INT A#	INT B#	INT C#
PCI Slot 5	INT B#	INT C#	INT D#	INT A#

---

# BIOS Setup 3

This chapter provides information on the BIOS Setup program and allows you to configure the system for optimum use.

You may need to run the Setup program when:

- An error message appears on the screen during the system booting up, and requests you to run SETUP.
- You want to change the default settings for customized features.

## TOPICS

<i>Entering Setup</i>	3-2
<i>The Main Menu</i>	3-4
<i>Standard CMOS Features</i>	3-6
<i>Advanced BIOS Features</i>	3-8
<i>Advanced Chipset Features</i>	3-12
<i>Integrated Peripherals</i>	3-14
<i>Power Management Setup</i>	3-18
<i>PNP/PCI Configurations</i>	3-22
<i>PC Health Status</i>	3-24
<i>Frequency/Voltage Control</i>	3-25
<i>Load Fail-Safe/Optimized Defaults</i>	3-27
<i>Set Supervisor/User Password</i>	3-28



### Chapter 3

## Entering Setup

---

Power on the computer and the system will start POST (Power On Self Test) process. When the message below appears on the screen, press <DEL> key to enter Setup.

Press DEL to enter SETUP

If the message disappears before you respond and you still wish to enter Setup, restart the system by turning it OFF and On or pressing the RESET button. You may also restart the system by simultaneously pressing <Ctrl>, <Alt>, and <Delete> keys.

### Control Keys

<↑>	Move to the previous item
<↓>	Move to the next item
<←>	Move to the item in the left hand
<→>	Move to the item in the right hand
<Enter>	Select the item
<Esc>	Jumps to the Exit menu or returns to the main menu from a submenu
<+/PU>	Increase the numeric value or make changes
<-/PD>	Decrease the numeric value or make changes
<F1>	General help, only for Status Page Setup Menu and Option Page Setup Menu
<F5>	Restore the previous CMOS value from CMOS, only for Option Page Setup Menu
<F6>	Load the default CMOS value from Fail-Safe default table, only for Option Page Setup Menu
<F7>	Load Optimized defaults
<F10>	Save all the CMOS changes and exit

## Getting Help

After entering the Setup menu, the first menu you will see is the Main Menu.

### Main Menu

The main menu lists the setup functions you can make changes to. You can use the control keys (↑↓) to select the item. The on-line description of the highlighted setup function is displayed at the bottom of the screen.

### Sub-Menu

If you find a right pointer symbol (as shown in the right view) appears to the left of certain fields that means a sub-menu containing additional options can be launched from this field. You can use control keys (↑↓) to highlight the field and press <Enter> to call up the sub-menu. Then you can use the control keys to enter values and move from field to field within a sub-menu. If you want to return to the main menu, just press <Esc>.

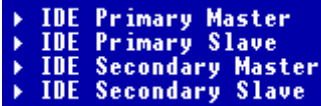

```
▶ IDE Primary Master
▶ IDE Primary Slave
▶ IDE Secondary Master
▶ IDE Secondary Slave
```

### General Help <F1>

The BIOS setup program provides a General Help screen. You can call up this screen from any menu by simply pressing <F1>. The Help screen lists the appropriate keys to use and the possible selections for the highlighted item. Press <Esc> to exit the Help screen.

## Chapter 3

### The Main Menu

---

Once you enter Award® BIOS CMOS Setup Utility, the Main Menu (Figure 1) will appear on the screen. The Main Menu allows you to select from twelve setup functions and two exit choices. Use arrow keys to select among the items and press <Enter> to accept or enter the sub-menu.



#### Standard CMOS Features

Use this Menu for basic system configurations.

#### Advanced BIOS Features

Use this menu to set the Advanced Features available on your system.

#### Advanced Chipset Features

Use this menu to change the values in the chipset registers and optimize your system's performance.

#### Integrated Peripherals

Use this menu to specify your settings for integrated peripherals.

#### Power Management Setup

Use this menu to specify your settings for power management.

## ***BIOS Setup***

### **PnP/PCI Configurations**

This entry appears if your system supports PnP/PCI.

### **PC Health Status**

This entry shows your PC health status.

### **Frequency/Voltage Control**

Use this menu to specify your settings for frequency/voltage control.

### **Load Fail-Safe Defaults**

Use this menu to load the BIOS default values for minimal but stable system performance.

### **Load Optimized Defaults**

Use this menu to load the BIOS default values that are factory settings for optimal system operations.

### **Set Supervisor/User Password**

Use this menu to set User and Supervisor Passwords.

### **Save & Exit Setup**

Save CMOS value changes to CMOS and exit setup.

### **Exit Without Saving**

Abandon all CMOS value changes and exit setup.

## Chapter 3

### Standard CMOS Features

The items in Standard CMOS Features Menu are divided into 10 categories. Each category includes no, one or more than one setup items. Use the arrow keys to highlight the item and then use the <PgUp> or <PgDn> keys to select the value you want in each item.



#### Date

The date format is <day><month> <date> <year>.

**day** Day of the week, from Sun to Sat, determined by BIOS. Read-only.

**month** The month from Jan. through Dec.

**date** The date from 1 to 31 can be keyed by numeric function keys.

**year** The year, depends on the year of the BIOS

#### Time

The time format is <hour> <minute> <second>.

#### IDE Primary/Secondary Master/Slave

Press PgUp/<+> or PgDn/<-> to select Manual, None, Auto type. Note that the specifications of your drive must match with the drive table. The hard disk will not work properly if you enter improper information for this category. If your hard disk drive type is not matched or listed, you can use Manual to define your own drive type manually.

If you select Manual, related information is asked to be entered to the follow-

## **BIOS Setup**

ing items. Enter the information directly from the keyboard. This information should be provided in the documentation from your hard disk vendor or the system manufacturer.

If the controller of HDD interface is SCSI, the selection shall be "None".

If the controller of HDD interface is CD-ROM, the selection shall be "None".

<b>Access Mode</b>	The settings are CHS, LBA, Large, Auto.
<b>Capacity</b>	The formatted size of the storage device.
<b>Cylinder</b>	Number of cylinders.
<b>Head</b>	Number of heads.
<b>Precomp</b>	Write precompensation.
<b>Landing Zone</b>	Cylinder location of the landing zone.
<b>Sector</b>	Number of sectors.

### **Drive A/B**

This item allows you to set the type of floppy drives installed. Available options are *None*, *360K, 5.25 in.*, *1.2M, 5.25 in.*, *720K, 3.5 in.*, *1.44M, 3.5 in.*, *2.88M, 3.5 in.*

### **Video**

The setting controls the type of video adapter used for the primary monitor of the system. Available options are *EGA/VGA*, *CGA 40*, *CGA 80* and *Mono*.

### **Halt On**

The setting determines whether the system will stop if an error is detected at boot. Available options are:

<i>All Errors</i>	The system stops when any error is detected.
<i>No Errors</i>	The system doesn't stop for any detected error.
<i>All, But Keyboard</i>	The system doesn't stop for a keyboard error.
<i>All, But Diskette</i>	The system doesn't stop for a disk error.
<i>All, But Disk/Key</i>	The system doesn't stop for either a disk or a keyboard error.

## Chapter 3

### Advanced BIOS Features



#### Quick Boot

The setting allows the system to skip certain tests while booting. This will decrease the time needed to boot the system. Setting options: *Enabled*, *Disabled*.

#### Anti-Virus Protection

The item is to set the Virus Warning feature for IDE Hard Disk boot sector protection. If the function is enabled and any attempt to write data into this area is made, BIOS will display a warning message on screen and beep. Settings: *Disabled* and *Enabled*.

#### CPU L1 & L2 Cache

Cache memory is additional memory that is much faster than conventional DRAM (system memory). When the CPU requests data, the system transfers the requested data from the main DRAM into cache memory, for even faster access by the CPU. The settings enable/disable the internal cache (also known as L1 or level 1 cache) and external cache (also known as L2 or level 2 cache). Setting options: *Disabled*, *Enabled*.

#### Fast Boot

The setting enables the fastest boot to OS. HDD will be the first boot device if

## **BIOS Setup**

previous boot is successful to OS that supports Simple Boot Flag Spec. Setting options: *Enabled, Disabled*.

### **1st/2nd/3rd Boot Device**

The items allow you to set the sequence of boot devices where BIOS attempts to load the disk operating system. The settings are:

<i>Floppy</i>	The system will boot from floppy drive.
<i>LS120</i>	The system will boot from LS-120 drive.
<i>HDD-0</i>	The system will boot from the first HDD.
<i>SCSI</i>	The system will boot from the SCSI.
<i>CDROM</i>	The system will boot from the CD-ROM.
<i>HDD-1</i>	The system will boot from the second HDD.
<i>HDD-2</i>	The system will boot from the third HDD.
<i>HDD-3</i>	The system will boot from the fourth HDD.
<i>ZIP</i>	The system will boot from ATAPI ZIP drive.
<i>LAN</i>	The system will boot from the Network drive.
<i>Disabled</i>	Disable this sequence.

### **Boot Other Device**

Setting the option to *Enabled* allows the system to try to boot from other device if the system fails to boot from the 1st/2nd/3rd boot device.

### **SwapFloppy**

Setting to *Enabled* will swap floppy drives A: and B:.

### **Seek Floppy**

Setting to *Enabled* will make BIOS seek floppy drive A: before booting the system. Settings: *Disabled* and *Enabled*.

### **BootUpNum-LockLED**

This item is to set the Num Lock status when the system is powered on. Setting to *On* will turn on the Num Lock key when the system is powered on. Setting to *Off* will allow end users to use the arrow keys on the numeric keypad. Settings: *On* and *Off*.

### **Gate A20 Option**

This item is to set the Gate A20 status. A20 refers to the first 64KB of extended memory. When the default value *Fast* is selected, the Gate A20 is controlled by Port92 or chipset specific method resulting in faster system performance. When



### Chapter 3

*Normal* is selected, A20 is controlled by a keyboard controller or chipset hardware.

#### **Typematic Rate Setting**

This item is used to enable or disable the typematic rate setting including Typematic Rate & Typematic Delay.

#### **Typematic Rate (Chars/Sec)**

After *Typematic Rate Setting* is enabled, this item allows you to set the rate (characters/second) at which the keys are accelerated. Settings: *6, 8, 10, 12, 15, 20, 24* and *30*.

#### **Typematic Delay (Msec)**

This item allows you to select the delay between when the key was first pressed and when the acceleration begins. Settings: *250, 500, 750* and *1000*.

#### **Security Option**

This specifies the type of BIOS password protection that is implemented. Settings are described below:

<b>Option</b>	<b>Description</b>
<i>Setup</i>	The password prompt appears only when end users try to run Setup.
<i>System</i>	A password prompt appears every time when the computer is powered on or when end users try to run Setup.

#### **APICFunction**

This field is used to enable or disable the APIC (Advanced Programmable Interrupt Controller). Due to compliance with PC2001 design guide, the system is able to run in APIC mode. Enabling APIC mode will expand available IRQ resources for the system. Settings: *Enabled* and *Disabled*.

#### **MPS Table Version**

This field allows you to select which MPS (Multi-Processor Specification) version to be used for the operating system. You need to select the MPS version supported by your operating system. To find out which version to use, consult the vendor of your operating system. Settings: *1.4* and *1.1*.

## ***BIOS Setup***

### **Boot OS/2 For DRAM > 64MB**

This allows you to run the OS/2<sup>®</sup> operating system with DRAM greater than 64MB. Setting options: *Yes, No*.

### **Hard Disk S.M.A.R.T.**

This allows you to activate the S.M.A.R.T. (Self-Monitoring Analysis & Reporting Technology) capability for the hard disks. S.M.A.R.T is a utility that monitors your disk status to predict hard disk failure. This gives you an opportunity to move data from a hard disk that is going to fail to a safe place before the hard disk becomes offline. Settings: *Enabled* and *Disabled*.

## Chapter 3

### Advanced Chipset Features

The Advanced Chipset Features Setup option is used to change the values of the chipset registers. These registers control most of the system options in the computer.



 *Note: Change these settings only if you are familiar with the chipset.*

#### Configure DRAM Timing

This setting determines whether DRAM timing is configured by reading the contents of the SPD (Serial Presence Detect) EPROM on the DRAM module. Selecting *By SPD* makes the following settings automatically determined by BIOS according to the configurations on the SPD.

##### CAS# Latency

This setting controls the CAS latency, which determines the timing delay before SDRAM starts a read command after receiving it. Setting options: 1.5, 2, 2.5. 1.5 increases system performance while 2.5 provides more stable system performance.

##### Precharge Delay

This setting controls the number of clock cycles for DRAM to be allowed to precharge from the active state. Setting options: 7, 6, 5.

## ***BIOS Setup***

### **RAS# to CAS# Delay**

When DRAM is refreshed, both rows and columns are addressed separately. This setup item allows you to determine the timing of the transition from RAS (row address strobe) to CAS (column address strobe). The less the clock cycles, the faster the DRAM performance. Setting options: 3, 2.

### **RAS# Precharge**

This item controls the number of cycles for Row Address Strobe (RAS) to be allowed to precharge. If insufficient time is allowed for the RAS to accumulate its charge before DRAM refresh, refresh may be incomplete and DRAM may fail to retain data. This item applies only when synchronous DRAM is installed in the system. The settings are: 2 and 3.

### **DRAM Data Integrity Mode**

Select *ECC* (Error-Checking & Correcting Code) or *Non-ECC* according to the type of DRAM installed.

### **DRAM Frequency**

This setting is used to configure the clock frequency of the installed SDRAM.

### **Delayed Transaction**

The chipset has an embedded 32-bit posted write buffer to support delayed transactions cycles so that transactions to and from the ISA bus are buffered and PCI bus can perform other transactions while the ISA transaction is underway. Select *Enabled* to support compliance with PCI specification version 2.1. The settings are: *Enabled* and *Disabled*.

### **AGP Aperture Size (MB)**

This setting controls just how much system RAM can be allocated to AGP for video purposes. The aperture is a portion of the PCI memory address range dedicated to graphics memory address space. Host cycles that hit the aperture range are forwarded to the AGP without any translation. The option allows the selection of an aperture size of 4, 8, 16, 32, 64, 128, and 256 (MB).

## Chapter 3

# Integrated Peripherals



### On-Chip Primary/Secondary PCI IDE

The integrated peripheral controller contains an IDE interface with support for two IDE channels. Choose *Enabled* to activate each channel separately.

### IDE Primary/Secondary Master/Slave PIO

The four items allow you to set a PIO (Programmed Input/Output) mode for each of the four IDE devices that the onboard IDE interface supports. *Modes 0~4* provide increased performance. In *Auto* mode, BIOS automatically determines the best mode for each IDE device.

### IDE Primary/Secondary Master/Slave UDMA

Ultra DMA implementation is possible only if your IDE device supports it and your operating environment contains a DMA driver. If both your hard drive and software support Ultra DMA 33, select *Auto* to enable BIOS support.

## **BIOS Setup**

### **USB Controller**

Select *Enabled* if your system contains a Universal Serial Bus (USB) controller and you have USB peripherals. The settings are: *Enabled, Disabled*.

### **USB Keyboard Support**

Set to *Enabled* if your need to use a USB keyboard in the operating system that does not support or have any USB driver installed, such as DOS and SCO Unix.

### **Init Display First**

This item specifies which VGA card is your primary graphics adapter. Settings: *PCI Slot* and *AGP*.

### **AC'97 Modem**

*Auto* allows the mainboard to detect whether a modem is used. If a modem is used, the onboard MC'97 (Modem Codec'97) controller will be enabled; if not, it is disabled. Disable the controller if you want to use other controller cards to connect to a modem. Settings: *Auto* and *Disabled*.

### **Onboard Audio Chip**

This setting enables/disables the onboard sound chip. Setting options: *Enabled, Disabled*.

### **IDE HDD Block Mode**

This allows your hard disk controller to use the fast block mode to transfer data to and from the hard disk drive. Block mode is also called block transfer, multiple commands or multiple sector read/write. *Enabled* enables IDE controller to use block mode; *Disabled* allows the controller to use standard mode.

### **Floppy Controller**

The item is used to enable or disable the onboard Floppy controller. Select *Enabled* when you have installed a floppy disk drive and want to use it.

### **Serial Port A/B**

The items specify the base I/O port address and IRQ for the onboard Serial Port A/Serial Port B. Selecting *Auto* allows BIOS to automatically determine the correct base I/O port address. Settings: *Disabled, 3F8/IRQ4, 2F8/IRQ3, 3E8/IRQ4, 2E8/IRQ3* and *Auto*.

## Chapter 3

### Serial Port B Mode

The field allows you to specify the operation mode for serial port “COM B”. Settings are:

*Normal:* RS-232C Serial Port  
*IrDA:* IrDA-compliant Serial Infrared Port  
*ASKIR:* Amplitude Shift Keyed Infrared Port

### RxD, TxD Active

This setting controls the receiving and transmitting speed of the IR peripheral in use. Setting options: *Hi/Hi, Hi/Lo, Lo/Hi, Lo/Lo*.

### IR Transmission Delay

This setting determines whether the IR transmission rate will be delayed while converting to receiving mode. Setting options: *Disabled, Enabled*.

### IRDuplexMode

This setting controls the operating mode of IR transmission/reception. Setting options: *Full, Half*. Under Full Duplex mode, synchronous, bi-directional transmission/reception is allowed. Under Half Duplex mode, only asynchronous, bi-directional transmission/reception is allowed.

### IR Pin Select

Please consult your IR peripheral documentation to select the correct setting of the TxD and RxD signals. Setting options: *RxD2/TxD2, IR-Rx2Tx2*.

### Parallel Port

This specifies the I/O port address and IRQ of the onboard parallel port. Settings: *378/IRQ7, 278/IRQ5, 3BC/IRQ7* and *Disabled*.

### Parallel Port Mode

*SPP* : Standard Parallel Port  
*EPP* : Enhanced Parallel Port  
*ECP* : Extended Capability Port  
*ECP + EPP*: Extended Capability Port + Enhanced Parallel Port  
*SPP/EPP/ECP/ECP+EPP*

To operate the onboard parallel port as Standard Parallel Port only, choose “SPP.” To operate the onboard parallel port in the EPP mode simultaneously, choose “EPP.” By choosing “ECP”, the onboard parallel port will operate in ECP mode only. Choosing “ECP + EPP” will allow the onboard parallel port to support both the ECP and EPP modes simultaneously.

## ***BIOS Setup***

### **EPP Version**

The onboard parallel port is EPP Spec. compliant, so after the user chooses the onboard parallel port with the EPP function, the following message will be displayed on the screen: "EPP Mode Select." At this time either EPP 1.7 spec or EPP 1.9 spec can be chosen.

### **ECP Mode Use DMA**

The ECP mode has to use the DMA channel, so choose the onboard parallel port with the ECP feature. After selecting it, the following message will appear: "ECP Mode Use DMA." At this time, the user can choose between DMA channel 3 or 1.



## Chapter 3

# Power Management Setup

The Power Management Setup allows you to configure your system to most effectively save energy while operating in a manner consistent with your own style of computer use.

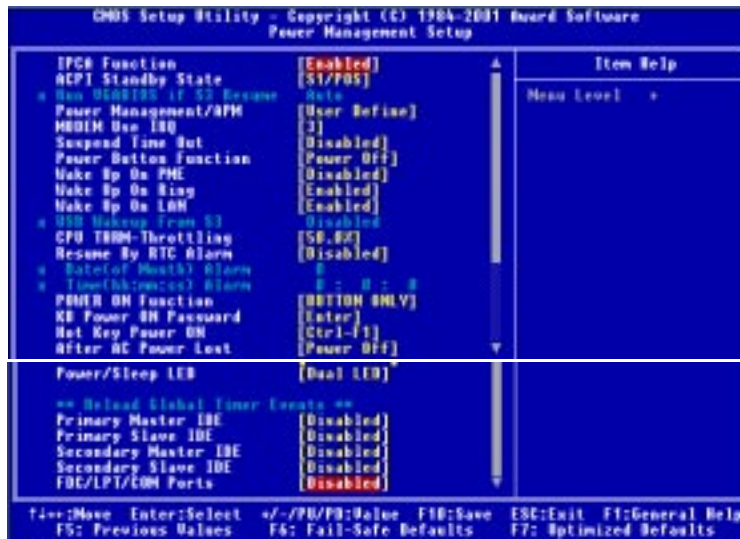

### APCA Function

This item is to activate the ACPI (Advanced Configuration and Power Management Interface) Function. If your operating system is ACPI-aware, such as Windows 98SE/2000/ME, select *Enabled*. Settings: *Enabled* and *Disabled*.

### ACPI Standby State

This item specifies the power saving modes for ACPI function. Options are:

- S1/POS** The S1 sleep mode is a low power state. In this state, no system context (CPU or chipset) is lost and hardware maintains all system context.
- S3/STR** The S3 sleep mode is a power-down state in which power is supplied only to essential components such as main memory and wake-capable devices and all system context is saved to main memory. The information stored in

## **BIOS Setup**

memory will be used to restore the PC to the previous state when an “wake up” event occurs.

### **Run VGA BIOS If S3 Resume**

This setting allows the system to initialize the VGA BIOS from S3 (Suspend to RAM) sleep state and only works when the *ACPI Standby State* is set to *S3/STR*. Setting options: *Auto, Yes, No*.

### **Power Management/APM**

This item is used to select the degree (or type) of power saving and is related to these modes: Suspend Mode and HDD Power Down. There are three options for power management:

- Min Saving* Minimum Power Management. Suspend Mode = 1 Hour.
- Max Saving* Maximum Power Management. Suspend Mode = 1 Min.
- User Define* Allows end users to configure each mode separately.

### **Modem Use IRQ**

Name the interrupt request (IRQ) line assigned to the modem (if any) on your system. Activity of the selected IRQ always awakens the system. Settings are *3, 4, 5, 7, 9, 10, 11* and *NA*.

### **Suspend Time Out**

If system activity is not detected for the length of time specified in this field, all devices except CPU will be shut off. Settings are *Disabled, 1 Min, 2 Min, 4 Min, 8 Min, 12 Min, 20 Min, 30 Min, 40 Min* and *1 Hour*.

### **Power Button Function**

This setting determines the function of the power button. When set to *Power Off*, the power button works as normal power off button. When set to *Suspend*, the computer will enter the suspend/sleep mode if you press the power button. But if the button is pressed for more than four seconds, the computer is turned off. Setting options: *Power Off, Suspend*.

### **Wake Up On PME, Wake Up On Ring, Wake Up On LAN, USB Wakeup From S3**

These fields specify whether the system will be awakened from power saving modes when activity or input signal of the specified hardware peripheral or component is detected.

## Chapter 3



*Note: To use the function of “Wake Up On Ring” and “Wake Up On LAN”, you need to install a modem/LAN card supporting power on function.*

### **CPU THRM-Throttling**

The item allows you to specify the CPU speed (at percentage) to which it will slow down when the CPU reaches the predetermined overheat temperature. Settings range from 12.5% to 87.5% at 12.5% increment.

### **Resume by RTC Alarm**

The field is used to enable or disable the feature of booting up the system on a scheduled time/date.

#### **Date (of Month) Alarm**

The field specifies the date for Resume by Alarm. Settings: 0~31.

#### **Time (hh:mm:ss) Alarm**

The field specifies the time for *Resume by Alarm*. Format is <hour> <minute><second>.

### **POWER ON Function**

This setting controls which part on the PS/2 mouse or keyboard can power on the system. Settings: *Password, Hot KEY, Mouse Left, Mouse Right, BUTTON ONLY* and *Keyboard 98*. Please note that this function will only work under S3 mode.

#### **KB Power ON Password**

If *POWER ON Function* is set to *Password*, then you can set a password in the field for the PS/2 keyboard to power on the system. Please note that this function will only work under S3 mode.

#### **Hot Key Power ON**

If *POWER ON Function* is set to *Hot KEY*, you can assign a hot key combination in the field for the PS/2 keyboard to power on the system. Settings: *Ctrl-F1* through *Ctrl-F12*. Please note that this function will only work under S3 mode.

#### **After AC Power Lost**

This setting specifies whether your system will reboot after a power failure or interrupts occurs. Available settings are:

## ***BIOS Setup***

<i>Power Off</i>	Leaves the computer in the power off state.
<i>Power On</i>	Reboots the computer.
<i>Last State</i>	Restores the system to the status before power failure or interrupt occurs.

### **Power/Sleep LED**

This item configures how the system uses power LED on the case to indicate the sleep state. Available options are:

<i>Single LED</i>	The power LED blinks to indicate the sleep state without changing its color.
<i>Dual LED</i>	The power LED changes its color to indicate the sleep state.

### **Reload Global Timer Events: Primary/Secondary Master/Slave IDE, FDC/LPT/COMPorts**

Global Timer Events are I/O events whose occurrence can prevent the system from entering a power saving mode or can awaken the system from such a mode. In effect, the system remains alert for anything which occurs to a device that is configured as *Enabled*, even when the system is in a power down mode.

## Chapter 3

### PNP/PCI Configurations

This section describes configuring the PCI bus system. PCI, or **P**eripheral **C**omponent **I**nterconnect, is a system which allows I/O devices to operate at speeds nearing the speed the CPU itself uses when communicating with its own special components. This section covers some very technical items and it is strongly recommended that only experienced users should make any changes to the default settings.

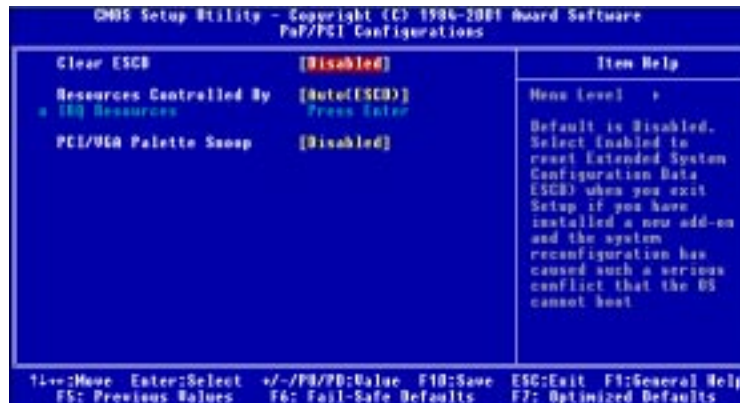

#### Clear ESCD

Normally, you leave this field *Disabled*. Select *Enabled* to reset Extended System Configuration Data (ESCD) when you exit Setup if you have installed a new add-on and the system reconfiguration has caused such a serious conflict that the operating system can not boot. The settings are: *Enabled* and *Disabled*.

#### Resource Controlled By

The Award Plug and Play BIOS has the capacity to automatically configure all of the boot and Plug and Play compatible devices. However, this capability means absolutely nothing unless you are using a Plug and Play operating system such as Windows® 95/98. If you set this field to “manual” choose specific resources by going into each of the sub menu that follows this field (a sub menu is preceded by a “>”). The settings are: *Auto (ESCD)*, *Manual*.

#### IRQ Resources

The items are adjustable only when *Resources Controlled By* is set to *Manual*.

## **BIOS Setup**

Press <Enter> and you will enter the sub-menu of the items. IRQ Resources list IRQ 3/4/5/7/9/10/11/12/14/15 for users to set each IRQ a type depending on the type of device using the IRQ. Settings are:

- PCI Device* For Plug & Play compatible devices designed for PCI bus architecture.
- Reserved* The IRQ will be reserved for further request.

### **PCI/VGA Palette Snoop**

When set to *Enabled*, multiple VGA devices operating on different buses can handle data from the CPU on each set of palette registers on every video device. Bit 5 of the command register in the PCI device configuration space is the VGA Palette Snoop bit (0 is disabled). For example, if there are two VGA devices in the computer (one PCI and one ISA) and the:

<b>VGA Palette Snoop Bit Setting</b>	<b>Action</b>
<i>Disabled</i>	Data read or written by the CPU is only directed to the PCI VGA device's palette registers.
<i>Enabled</i>	Data read or written by the CPU is directed to both the PCI VGA device's palette registers and the ISA VGA device's palette registers, permitting the palette registers of both VGA devices to be identical.

The setting must be set to *Enabled* if any ISA bus adapter in the system requires VGA palette snooping.

## Chapter 3

### PC Health Status

---

This section shows the status of your CPU, fan, warning for overall system status.



#### CPU Critical Temperature

If the CPU temperature reaches the upper limit preset in this setting, the warning mechanism will be activated. This helps you to prevent the CPU overheat problem.

#### Current System/CPU Temperature, System/CPU Fan, Vcore, 3.3V, +5V, +12V, -12V, -5V, VBAT(V), 5VSB(V)

These items display the current status of all of the monitored hardware devices/components such as system voltages, temperatures and fan speeds.

#### CPU Shutdown Temperature

This option is for setting the shutdown temperature level for the processor. When the processor reaches the temperature you set, the system will be shut down.

## Frequency/Voltage Control

This section describes how to set the Chassis Intrusion feature, CPU FSB frequency, monitor the current hardware status including CPU/system temperatures, CPU/System Fan speeds, Vcore etc. Monitor function is available only if there is hardware monitoring mechanism onboard.



### CPU Ratio Selection

This setting controls the multiplier that is used to determine the internal clock speed of the processor relative to the external or motherboard clock speed.

### Auto Detect PCI Clock

This option allows you to enable/disable the feature of auto detecting the clock frequency of the installed PCI bus. The settings are: *Enabled*, *Disabled*.

### Spread Spectrum

When the motherboard's clock generator pulses, the extreme values (spikes) of the pulses creates EMI (Electromagnetic Interference). The Spread Spectrum function reduces the EMI generated by modulating the pulses so that the spikes of the pulses are reduced to flatter curves. If you do not have any EMI problem, leave the setting at *Disabled* for optimal system stability and performance. But if you are plagued by EMI, setting to *Enabled* for EMI reduction. Remember to disable Spread Spectrum if you are overclocking because even a slight jitter can introduce a temporary boost in clockspeed which may just cause your overclocked processor to lock up.



## **Chapter 3**

### **CPU Host/3V66/PCI Clock**

This setting controls the clock frequency of the CPU host bus (FSB)/3V66/PCI bus on the motherboard.

### **CPU Vcore Adjust**

This setting allows you to adjust the CPU core voltage from *1.475V* to *1.6V*. Please note that it may be dangerous to adjust the Vcore over 10%.



*Note: Changing CPU Vcore could result in unstable system; therefore, it is not recommended to change the default setting for long-term purpose.*

## **Load Fail-Safe/Optimized Defaults**

---

The two options on the main menu allow users to restore all of the BIOS settings to the default Fail-Safe or Optimized values. The Optimized Defaults are the default values set by the mainboard manufacturer specifically for optimal performance of the mainboard. The Fail-Safe Defaults are the default values set by the BIOS vendor for stable system performance.

When you select Load Fail-Safe Defaults, a message as below appears:



Pressing *Y* loads the BIOS default values for the most stable, minimal system performance.

When you select Load Optimized Defaults, a message as below appears:



Pressing *Y* loads the default factory settings for optimal system performance.

## Chapter 3

### Set Supervisor/User Password

---

When you select this function, a message as below will appear on the screen:



Type the password, up to six characters in length, and press <Enter>. The password typed now will replace any previously set password from CMOS memory. You will be prompted to confirm the password. Retype the password and press <Enter>. You may also press <Esc> to abort the selection and not enter a password.

To clear a set password, just press <Enter> when you are prompted to enter the password. A message will show up confirming the password will be disabled. Once the password is disabled, the system will boot and you can enter Setup without entering any password.

When a password has been set, you will be prompted to enter it every time you try to enter Setup. This prevents an unauthorized person from changing any part of your system configuration.

Additionally, when a password is enabled, you can also have AMIBIOS to request a password each time the system is booted. This would prevent unauthorized use of your computer. The setting to determine when the password prompt is required is the *Security Option* of the *ADVANCED BIOS FEATURES* menu. If the *Security Option* is set to *Always*, the password is required both at boot and at entry to Setup. If set to *Setup*, password prompt only occurs when you try to enter Setup.



#### **About Supervisor Password & User Password:**

*Supervisor password:* Can enter and change the settings of the setup menu.

*User password:* Can only enter but do not have the right to change the settings of the setup menu.

---

## *Using 4-/6-channel Audio Function* **A**

The mainboard comes with C-Media 6-channel audio function, which allows you to attach 4 or 6 speakers for better space sound effect. The section will tell you how to activate 4-/6-channel audio function.

**TOPICS**

<i>Installing C-Media Drivers</i>	A-2
<i>Hardware Configuration</i>	A-2
<i>Software Configuration</i>	A-3

## Appendix A

### Installing C-Media Drivers

---

The mainboard is able to transform the audio connectors on the back panel from 2-channel to 4-/6-channel. To use the function, you need to install the C-Media drivers.

#### To install C-Media drivers:

1. Insert the companion CD into the CD-ROM drive. The setup screen will automatically appear.
2. Click on **C-Media Sound Drivers**.
3. Follow the on-screen instructions to complete installation.
4. Restart the system.



**Note:** For Windows NT4.0, you need to install the C-Media Sound Drivers *manually*.

### Hardware Configuration

---

After installing the C-Media drivers, you can attach the speakers for 4-/6-channel audio output. Always connect the speakers to the LINE OUT connectors. Different connector configurations for 2-/4-/6-channel operations are listed below:

#### 2-Channel

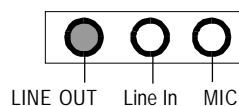

In 2-channel configuration, Line Out, Line In and MIC functions all exist.

#### 4-Channel

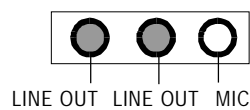

When set to 4-channel configuration, LINE IN function DOES NOT WORK any more.

#### 6-Channel

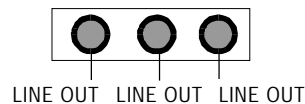

When set to 6-channel configuration, LINE IN and MIC functions DO NOT WORK anymore.

## Software Configuration

---

To have 4-/6-channel audio work, you must set appropriate configuration in the C-Media software application.

**To set the multi-channel configuration:**

1. Click the C-Media Mixer icon  from the window tray on the bottom.
2. The following screen appears. Click the indicated button.



Click here

3. The “Advanced” window appears.



4. Select 5.1 for 6-channel or 4 for 4-channel audio output.
5. Click OK.

---

# *MSI Smart Key* **B**

If security is important to you, the MSI Smart Key is the best solution to prevent your data in the computer from being accessed by unauthorized people.

In the public workspace, the passwords (BIOS password, system password, etc.) are not enough to keep your privacy. Do you believe that a hacker can easily enter your computer and monitor your confidential data? It happens everyday, everywhere; you just do not know... A password only stops them at the first gate. If this protection is broken, what else can you rely on?

The MSI Smart Key is a hardware device that provides you the complete and perfect protection on your system. Once the key is installed and setup, any unauthorized user absolutely can not access and use your computer without the key. The computer needs the key to boot up, and the operating system needs the key to work normally. Furthermore, if you have to leave your desktop for a while, you can simply unplug the key to keep your system in a safest status.

## **TOPICS**

<i>Installing MSI Smart Key</i>	<i>B-2</i>
<i>Using MSI Smart Key</i>	<i>B-3</i>

## Installing MSI Smart Key

---

### Installation

Simply follow the few steps below, you can install the Smart Key into your computer very easily.

1. Turn off the computer.
2. Locate the USB port on your computer.
3. Connect the cable to the USB port, and then plug the Smart Key into the connector properly.
4. Turn on the computer, and now you can implement this powerful feature.



*Note: After you have installed the Smart Key into your computer, the BIOS will detect it when the system boots up, and you have to enabled/disabled this function. Furthermore, you should install the dedicated software application in the operating system, which is provided by MSI, to obtain the overall protection on your system. The following sections will provide the detailed instructions for the BIOS setup and software installation.*

### System Requirements

Before you use the MSI Smart Key, please check the hardware, software and operating system requirements first.

Operating System	Windows 98/ME/2000/XP
Connector	USB port
Disk Space	At least 2 MB to install the software application



## Using MSI Smart Key

---

### BIOS Setup

When the Smart Key is inserted into your computer, the BIOS will detect it automatically. You can enable or disable the Smart Key through the BIOS setting. **Please note that it needs a personalized password to execute any kind of Smart Key setting;** so, keep the password firmly in mind. If, unfortunately, the Smart Key is lost or the password is missed, you can not enter the operating system successfully. At this time, contact your local dealer for further service.

### Enable/Disable the Smart Key

#### The first time installation

1. Insert the Smart Key into the computer and turn on the power.
2. Press <F7> during system boot up.
3. The message as below appears on the screen asking you to enable or disable the key:

```
Welcome to MSI Smart Key, please press "Y" to begin,  
press "N" to exit
```

Type <Y> to enable it; type <N> to disable it and bypass the BIOS to enter the operating system. When you type <Y>, it shows the following message:

```
Please input your password and press "Enter"  
password:
```

*Appendix B*

4. Type the password, up to 8 characters, and press <Enter>, it will show the following message to ask you confirm the password:



Type the password again and press <Enter>.

5. After the password is confirmed, the system will generate a set of random ID, and record this ID into the BIOS ROM and the memory chip on the key; it will show the following message when the Smart Key is enabled successfully:

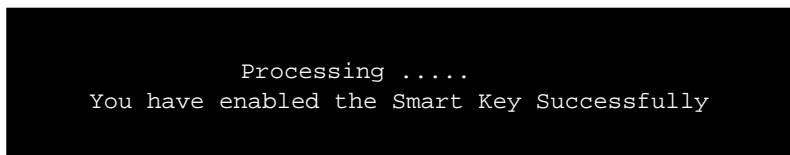

Then, you can enter the operating system and start to work.



**Note:**

1. You should firmly remember the password you set; if the Smart Key is lost, you can get a new key from MSI, and turn on the computer with the original password.
2. To avoid the password from being forgotten, we provide the table below for you to keep note in this guide. Please write down the password and keep the guide properly.

--	--	--	--	--	--	--	--

3. After the Smart Key function is successfully configured under DOS, the system will automatically reset and enter the installed OS. Please **DO NOT** unplug the Smart Key until the system has entered the OS.

**Enable/disable Smart Key function**

1. Turn on the computer with the Smart Key installed.
2. Press <F7> during system boot up.
3. The message as below appears on the screen asking you to enable or disable the key:

```
If you want to disable MSI Smart Key,  
please press "Y", or press "N" to exit
```

Type <Y> to disable it; type <N> to keep the function enabled and enter the operating system. When you type <Y>, it shows the following message:

```
Processing .....  
You have disabled the Smart Key Successfully
```

Then, you can enter the operating system and start to work.

## Appendix B

### Boot up with no key /wrong key/new key installed

Once the MSI Smart Key is enabled, always keep the key inserted in the computer. If the key is unplugged, the other user can not access the computer. The message as below appears during the system booting up:

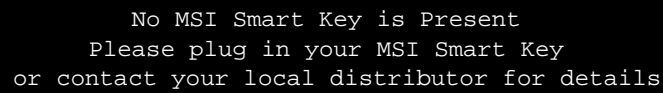

```
No MSI Smart Key is Present
Please plug in your MSI Smart Key
or contact your local distributor for details
```

The user have to find and re-plug the original key into the computer to continue booting up the system. If the wrong key or a new key\* is inserted, it will show the message as below on the screen:

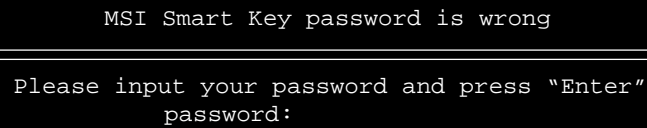

```
MSI Smart Key password is wrong

Please input your password and press "Enter"
password:
```

If the user remember the original password, typing in the password will allow the user to enter the operating system, and the system BIOS will copy the original password data into the wrong key/new key. Otherwise, the system will halt after entering the wrong password for three times.

*\* If, unfortunately, your Smart Key was lost , you have to purchase a new key from MSI as a replacement.*

## Software Setup

When the Smart Key is inserted into your computer and the software application is installed in the operating system, it will serve as a safeguard for your system. When the key is unplugged, the operating system will enter protection status immediately and the mouse and keyboard will be locked; when the key is inserted again, the operating system will resume from the protected mode.

## Installation

1. Install the Smart Key into the computer and turn on the power to enter the operating system successfully.
2. Insert the CD-ROM provided and the setup program will execute automatically. The welcome screen will appear as below:

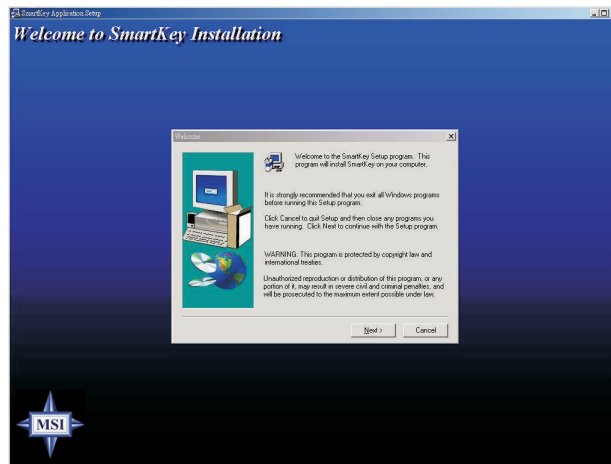

3. Press [ Next > ] to start the installation.

## Appendix B

4. When the Software License Agreement window appears on the screen, press [ Yes ] to continue.

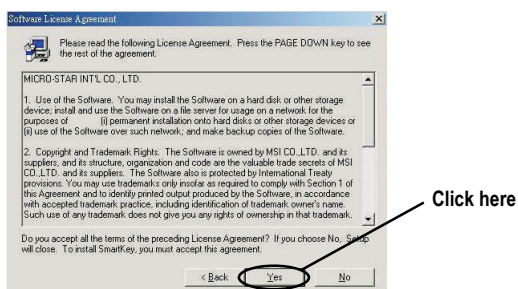

5. Choose the folder to install the software in your computer; simply press [ Next > ] to install it in the default folder.

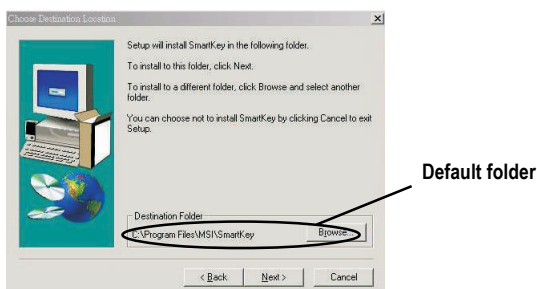

6. When the installation is completed, restart the computer as instructed.



### Using the Software Application

1. When the program is installed in the operating system, it will embed in the system tray and show an icon as below:

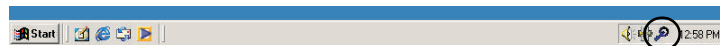

Smart Key icon

 **Note:** When the Smart Key function is disabled in BIOS, this program will not be launched in the operating system.

2. To launch the program's setup screen, simply left-click on the Smart Key icon in the system tray. The program's setup screen appears as below.

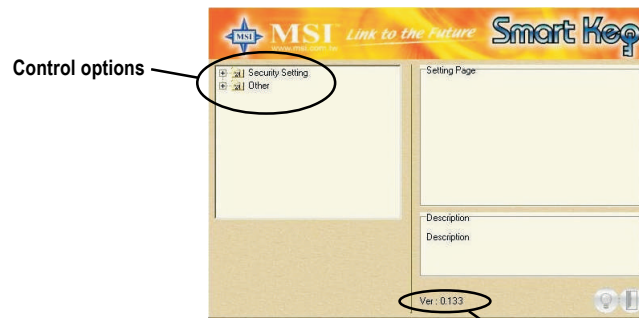

Program version

This window contains the information of the program and the main options for the user to control: **Security Setting** and **Other**.

## Appendix B

### Security Setting

This option allows you to logon to Windows automatically. Select the “Auto Login” item and check the “Auto Login to Windows” item in the Setting Page field to enable the function. Once the function is enabled and set properly, you do not have to type the user’s name and password everytime when entering Windows.

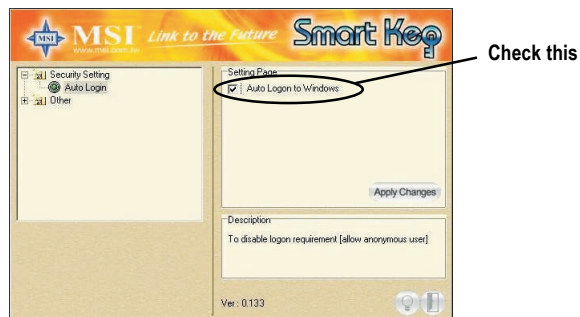

In Windows 2000, it will show the related fields when the “Auto Login to Windows” is checked, you should fill in the correct information in these fields.





**Other**

This option contains two items:

- 1) **Disable Screen Saver** allows you to enable/disable the screen saver program when the system is locked.



- 2) **Set Screen When System Locked** allows you to set the status when the Smart Key is unplugged and the system locked. You can set the monitor to display:

- a) blank screen
- b) the retaining screen when the system locked
- c) MSI Logo

The default setting is to show MSI Logo.

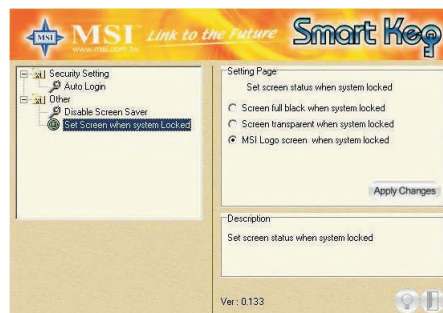

Appendix B

3. Press the “Apply Changes” button to enable the option you choose.

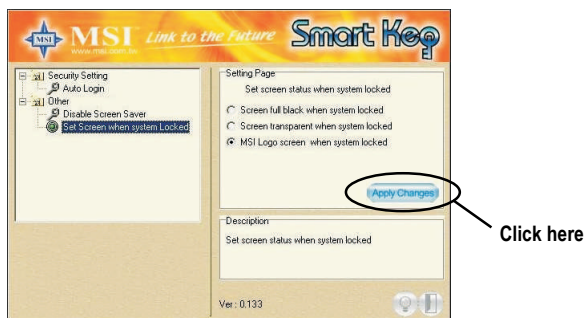

4. Press the “bulb” button at the right-bottom to hide the program in the system tray and keep on monitoring the system.



5. Press the “door” button at the right-bottom to exit the program.

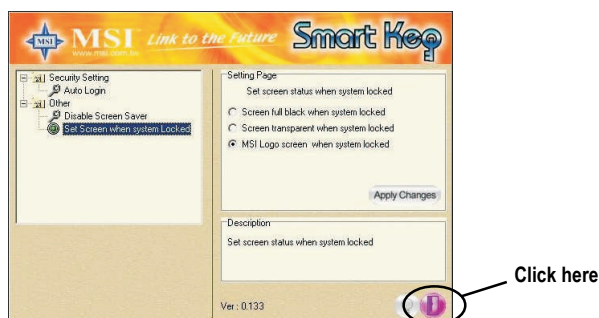

## Removing the Software Application

To remove the program, follow the steps below:

1. Click  and choose **Settings** → **Control Panel**; double-click the **Add/Remove Programs** item to open the “Add/Remove Programs Properties” window.

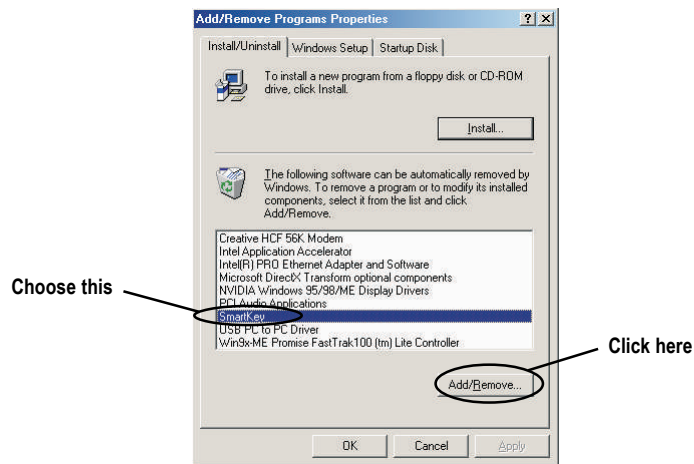

2. Select the “SmartKey” item in the field and click the [ Add/ Remove... ]; when it shows the dialog box requiring your confirmation, press [ Yes ] to start removing the program as the on-screen instructions.

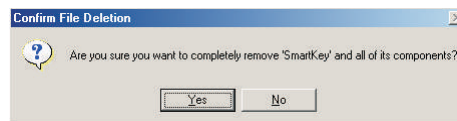

3. Restart the computer when the un-installation is completed.

# *Glossary*

**ACPI** (*Advanced Configuration & Power Interface*)

This power management specification enables the OS (operating system) to control the amount of power given to each device attached to the computer. Windows 98/98SE, Windows 2000 and Windows ME can fully support ACPI to allow users managing the system power flexibly.

**AGP** (*Accelerated Graphics Port*)

A new, high-speed graphics interface that based on PCI construction and designed especially for the throughput demands of 3-D graphics. AGP provides a direct channel (32-bit wide bus) between the display controller and main memory for high graphics quality and performance.

**ATX**

A modern shape and layout of mainboard that supersedes the widely-used Baby AT form factor. It improves many placement of components and makes a more efficient design.

**BIOS** (*basic input/output system*)

On PCs, an essential software that contains all the control code of input/output interface (such as keyboard, disk drives, etc.). It executes hardware test on booting the system, starts the OS, and provides an interface between the OS and the components. The BIOS is stored in a ROM chip.

**Bus**

A set of hardware lines within the computer system, through which the data is transferred among different components. In a PC, the term *bus* usually refers to a local bus that connects the internal components to the CPU and main memory.

**Cache**

A special memory subsystem that is used to speed up the data transfer. It stores the contents of frequently accessed RAM locations and the addresses where these data items are stored.

**Chipset**

A collection of integrated chips designed to perform one or more related functions. For

## Glossary

example, a modem chipset contains all the primary circuits for transmitting and receiving data; a PC chipset provides the electronic interfaces between all subsystems.

### **CMOS** (*complementary metal-oxide semiconductor*)

CMOS is a widely used type of semiconductor, which features high speed and low power consumption. PCs usually contain a small amount of battery-powered CMOS memory to retain the date, time, and system setup parameters.

### **COM**

In MS-DOS system, the name of a serial communications port. DOS supports four serial ports. For example, if a modem is connected to one serial port and a serial mouse to another, they are identified as COM1 and COM2.

### **DIMM** (*dual in-line memory module*)

A small circuit board that holds memory chips. A *SIMM* (*single in-line memory module*) has a 32-bit path to the memory chips whereas a DIMM has 64-bit path.

### **DRAM** (*Dynamic RAM*)

A most common type of computer memory. It usually uses one transistor and a capacitor to represent a bit. As the development of technology, the memory type and specification used in computer becomes variety, such as SDRAM, DDR SDRAM, and RDRAM. For further instruction, please see the table below:

Dynamic RAM (DRAM) Memory Technologies					
Type	First Used	Clock Rate	Bus* Width	Peak Bandwidth	Volts
FPM (60,70ns)	1990	25MHz	64 bits	200 MBps	5v
EDO (50,60,70ns)	1994	40MHz	64 bits	320 MBps	5v
SDRAM (66MHz)	1996	66MHz	64 bits	528 MBps	3.3v
SDRAM (100MHz)	1998	100MHz	64 bits	800 MBps	3.3v
SDRAM (133MHz)	1999	133MHz	64 bits	1.1 GBps	3.3v
RDRAM (Direct Rambus)	1999	400MHz	16 bits	1.6 GBps	2.5v
DDR SDRAM (100MHz)	2000	100MHz	64 bits	1.6 GBps	3.3v
DDR SDRAM (133MHz)	2000	133MHz	64 bits	2.1 GBps	3.3v

\* Memory channel width (64 bits started with 75MHz Pentium)

Source: *Computer Desktop Encyclopedia*

## *Glossary*

### **ECC Memory** (*error correcting code memory*)

A type of memory that contains special circuitry for testing the accuracy of data and correcting the errors on the fly.

### **IDE** (*Integrated Drive Electronics*)

A type of disk-drive interface widely used to connect hard disks, CD-ROMs and tape drives to a PC, in which the controller electronics is integrated into the drive itself, eliminating the need for a separate adapter card. The IDE interface is known as the ATA (AT Attachment) specification.

### **IEEE 1394**

A new, high speed external bus standard, also known as *FireWire* or *iLink*, which supports data transfer rates of up to 400 Mbps for connecting up to 63 external devices.

### **IrDA** (*Infrared Data Association*)

A group of device vendors, including computer, component and telecommunications, who have developed a standard for transmitting data via infrared light waves. This enables you to transfer data from one device to another without any cables.

### **LAN** (*local area network*)

A computer network that covers a relatively smaller area, such as in a building or an enterprise. It is made up of servers, workstations, shared resources, a network operating system and a communications link. These individual PCs and devices on a LAN are known as “nodes”, and are connected by cables to access data and devices anywhere on the LAN, so that many users can share expensive devices and data.

### **LED** (*light emitting diode*)

A semiconductor device that converts electrical energy into light. Since it lights up (usually red) when electricity is passed through it, it is usually used for the activity lights on computer’s component, such as disk drivers.

### **LPT** (*line printer terminal*)

Logical device name for a line printer; a name reserved by the MS-DOS for up to three parallel printer ports: LPT1, LPT2, and LPT3. It is frequently used by the OS to identify a printer.

## *Glossary*

### **PCI** (*Peripheral Component Interconnect*)

A local bus standard developed by Intel that first appeared on PCs in late 1993. PCI provides “plug and play” capability and allows IRQs to be shared. The PCI controller can exchange data with the system's CPU either 32 bits or 64 bits at a time.

### **PnP** (*Plug and Play*)

A set of specifications that allows a PC to configure itself automatically to work with peripherals. The user can "plug" in a peripheral device and "play" it without configuring the system manually. To implement this useful feature, both the BIOS that supports PnP and a PnP expansion card are required.

### **POST** (*Power On Self Test*)

During booting up your system, the BIOS executes a series of diagnostic tests, include checking the RAM, the keyboard, the disk drives, etc., to see if they are properly connected and operating.

### **PS/2 Port**

A type of port developed by IBM for connecting a mouse or keyboard to a PC. The PS/2 port supports a mini DIN plug containing just 6 pins. Most modern PCs equipped with PS/2 ports so that the special port can be used by another device, such as a modem.

### **USB** (*universal serial bus*)

A hardware interface for low-speed peripherals such as the keyboard, mouse, joystick, etc. USB provides a maximum bandwidth of 12 Mbit/sec (Mbps) for connecting up to 127 peripheral devices to PC. USB features hot swap capability and multiple data streams, allows external devices to be plugged in and unplugged without turning the system off.

### **Virus**

A program or a piece of code that infects computer files by inserting in those files copies of itself. The virus code is buried within an existing program, and is activated when that program is executed. All the viruses are man-made, and often have damaging side effects.