

MSI KT3 Ultra2 Series

MICRO-STAR INTERNATIONAL

MS-6380E (v1.X) ATX Mainboard

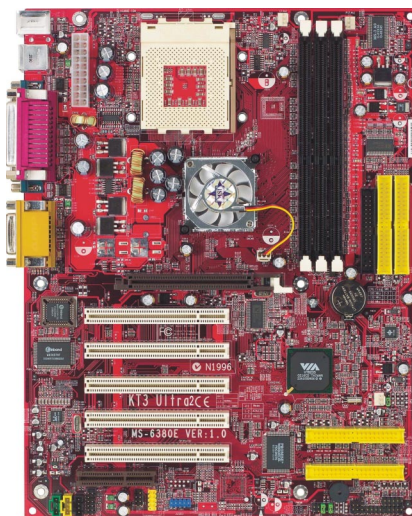

Version 1.3
G52-MA00598

Manual Rev: 1.3
Release Date: June 2002



FCC-B Radio Frequency Interference Statement

This equipment has been tested and found to comply with the limits for a class B digital device, pursuant to part 15 of the FCC rules. These limits are designed to provide reasonable protection against harmful interference when the equipment is operated in a commercial environment. This equipment generates, uses and can radiate radio frequency energy and, if not installed and used in accordance with the instruction manual, may cause harmful interference to radio communications. Operation of this equipment in a residential area is likely to cause harmful interference, in which case the user will be required to correct the interference at his own expense.

Notice 1

The changes or modifications not expressly approved by the party responsible for compliance could void the user's authority to operate the equipment.

Notice 2

Shielded interface cables and A.C. power cord, if any, must be used in order to comply with the emission limits.

VOIR LA NOTICE D'INSTALLATION AVANT DE RACCORDER AU RESEAU.

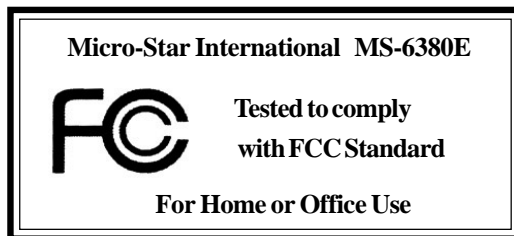

Edition

June 2002

Copyright Notice

The material in this document is the intellectual property of **MICRO-STAR INTERNATIONAL**. We take every care in the preparation of this document, but no guarantee is given as to the correctness of its contents. Our products are under continual improvement and we reserve the right to make changes without notice.

Trademarks

All trademarks are the properties of their respective owners.

AMD, Athlon and Duron are registered trademarks of AMD Corporation.
PS/2 and OS[®]/2 are registered trademarks of International Business Machines Corporation.

Windows[®] 98/2000/NT/ME/XP are registered trademarks of Microsoft Corporation.

Netware[®] is a registered trademark of Novell, Inc.

Award[®] is a registered trademark of Phoenix Technologies Ltd.

AMI[®] is a registered trademark of American Megatrends Inc.

Revision History

Revision	Revision History	Date
1.3	Modify chipset and USB connectors Add JBT2	June 2002

Safety Instructions

1. Always read the safety instructions carefully.
2. Keep this User's Manual for future reference.
3. Keep this equipment away from humidity.
4. Lay this equipment on a reliable flat surface before setting it up.
5. The openings on the enclosure are for air convection hence protects the equipment from overheating. **DO NOT COVER THE OPENINGS.**
6. Make sure the voltage of the power source and adjust properly 110/220V before connecting the equipment to the power inlet.
7. Place the power cord such a way that people can not step on it. Do not place anything over the power cord.
8. Always Unplug the Power Cord before inserting any add-on card or module.
9. All cautions and warnings on the equipment should be noted.
10. Never pour any liquid into the opening that could damage or cause electrical shock.
11. If any of the following situations arises, get the equipment checked by a service personnel:
 - The power cord or plug is damaged
 - Liquid has penetrated into the equipment
 - The equipment has been exposed to moisture
 - The equipment has not work well or you can not get it work according to User's Manual.
 - The equipment has dropped and damaged
 - If the equipment has obvious sign of breakage
12. **DO NOT LEAVE THIS EQUIPMENT IN AN ENVIRONMENT UNCONDITIONED, STORAGE TEMPERATURE ABOVE 60°C (140°F), IT MAY DAMAGE THE EQUIPMENT.**



CAUTION: Danger of explosion if battery is incorrectly replaced. Replace only with the same or equivalent type recommended by the manufacturer.

CONTENTS

Chapter 1. Getting Started	1-1
Mainboard Specification	1-2
Mainboard Layout	1-4
Quick Components Guide	1-6
MSI Special Features	1-7
PC Alert™ III	1-7
Fuzzy Logic™ 4	1-8
Live BIOS™/Live Driver™	1-9
D-Bracket™ 2(Optional)	1-10
S-Bracket (Optional)	1-12
MSI DVD (5.1 Channel)	1-13
CPU Thermal Protection	1-15
Chapter 2. Hardware Setup	2-1
Central Processing Unit: CPU	2-2
CPU Installation Procedures	2-2
CPU Core Speed Derivation Procedure	2-4
CPU Clock Frequency Selection through BIOS	2-4
Memory	2-5
Introduction to DDR SDRAM	2-5
DIMM Module Combination	2-6
Installing DDR Modules	2-6
Power Supply	2-7
ATX 20-Pin Power Connector: JWR1	2-7
Back Panel	2-8
Mouse Connector	2-8
Keyboard Connector	2-9
USB Connectors	2-9
Serial Port Connectors: COM A & COM B	2-10
Joystick/Midi Connector	2-10

Parallel Port Connector: LPT1	2-11
Audio Port Connectors	2-12
Connectors	2-13
Floppy Disk Drive Connector: FDD1	2-13
Hard Disk Connectors: IDE1 & IDE2	2-14
ATA133 RAID Connectors: IDE3 & IDE4	2-15
Fan Power Connectors: CFAN1/SFAN1/PSFAN1/NBFAN1	2-16
Front Panel Connectors: JFP1 & JFP2	2-17
Front Panel Audio Connector: JAUD1	2-18
Front USB Connectors: JUSB2/3	2-19
CD-In Connector: JCD	2-21
Aux Line-In Connector: JAUX (optional)	2-21
Modem-In Connector: JMDM (optional)	2-21
D-Bracket™ Connector: JLED	2-22
S-Bracket Connector: JSP3	2-23
IrDA Infrared Module Header: JIR1	2-24
Chassis Intrusion Switch Connector: J3	2-24
Wake On Ring Connector: JMDM1	2-25
Bluetooth Connector: JBT2 (optional)	2-26
Jumpers	2-27
Clear CMOS Jumper: JBAT1	2-27
Slots	2-28
AGP (Accelerated Graphics Port) Slot	2-28
PCI Slots	2-28
CNR (Communication Network Riser) Slot	2-28
PCI Interrupt Request Routing	2-29
Chapter 3. BIOS Setup	3-1
Entering Setup	3-2
Selecting the First Boot Device	3-2
Control Keys	3-3

Getting Help	3-3
The Main Menu	3-4
Standard CMOS Features	3-6
Advanced BIOS Features	3-8
Advanced Chipset Features	3-13
Power Management Features	3-18
PNP/PCI Configurations	3-22
Integrated Peripherals	3-24
PC Health Status	3-27
Frequency/Voltage Control	3-28
Set Supervisor/User Password	3-30
Load High Performance/BIOS Setup Defaults	3-31
Appendix. Using 4- or 6-Channel Audio Function	A-1
Installing the Audio Driver	A-2
Installation for Windows 98SE/ME/2000/XP	A-2
Using 4- or 6-Channel Audio Function	A-4
Attaching Speakers	A-4
Selecting 4- or 6-Channel Setting	A-9
Testing the Connected Speakers	A-11
Testing Each Speaker:	A-11
Playing KaraOK	A-12
Playing KaraOK:	A-12
Glossary	G-1

Getting Started

1

Thank you for purchasing KT3 Ultra2 (MS-6380E v1.X) series motherboard. The KT3 Ultra2 (MS-6380E v1.X) series ATX mainboard is a high-performance computer mainboard based on **VIA® Apollo KT333 & VT8235** chipsets and designed for the **AMD® Athlon™, Athlon™ XP or Duron™** (PGA) processor for value business/personal desktop markets.

There are two models available for KT3 Ultra2 series mainboards. They are **KT3 Ultra2** and **KT3 Ultra2-R**. KT3 Ultra2 is the standard version with common features most motherboards have. As for KT3 Ultra2-R, it integrates ATA133 RAID on the board in addition to the standard features.

TOPICS

<i>Mainboard Specification</i>	<i>1-2</i>
<i>Mainboard Layout</i>	<i>1-4</i>
<i>Quick Components Guide</i>	<i>1-5</i>
<i>MSI Special Features</i>	<i>1-6</i>

Mainboard Specification

CPU

- Supports Socket A (Socket-462) for AMD® Athlon™/Athlon™ XP/Duron™ processor
- Supports 800MHz up to 1.8GHz (Athlon™ XP 2200+) processor

Chipset

- VIA® KT333 chipset
 - FSB @200/266 MHz
 - AGP 4X and PCI Advanced high performance memory controller
- VIA® VT8235 chipset
 - Integrated Direct Sound AC97 audio
 - Dual channel Ultra DMA 33/66/100/133 master mode EIDE controller
 - ACPI
 - Integrated USB 2.0 controller

Clock Generator

- 100/133 MHz clocks are supported.

Main Memory

- Supports six memory banks using three 184-pin DDR DIMMs
- Supports a maximum memory size up to 3GB
- Supports 2.5V DDR SDRAM DIMM

Slots

- One AGP slot
 - AGP (Accelerated Graphics Port) specification compliant
 - Supports AGP 2.0 1x/2x/4x
- Five 32-bit PCI bus slots (support 3.3v/5v PCI bus interface)
- One CNR (Communication Network Riser) slot

On-Board IDE

- An IDE controller on the VT8235 chipset provides IDE HDD/CD-ROM with PIO, Bus Master and Ultra DMA133/100/66/33 operation modes
- Can connect up to four IDE devices

On-Board Peripherals

- On-Board Peripherals include:
 - 1 floppy port supports 2 FDDs with 360K, 720K, 1.2M, 1.44M and

- 2.88Mbytes
- 2 serial ports (COM A + COM B)
- 1 parallel port supports SPP/EPP/ECP mode
- 1 IrDA connector for SIR/ASKIR/HPSIR
- 1 audio/game port
- 1 D-Bracket™ pinheader
- 1 S-Bracket pinheader

Promise 20276 On-Board (KT3 Ultra2-R)

- Q Supports ATA133 RAID 0 or 1
 - Q The two ATA133 RAID connectors support hard disk drives only
- Note: Only two hard disk drives will adopt the RAID function.*

USB Interface

- Q Supports USB 2.0 and downward compatible with USB 1.1

Bluetooth

- Q 1 bluetooth connector for wireless connection (bluetooth module optional)

Audio

- Q Realtek ALC650 6-channel audio
 - SPDIF out (through S-Bracket only)

BIOS

- Q The mainboard BIOS provides “Plug & Play” BIOS which detects the peripheral devices and expansion cards of the board automatically.
- Q The mainboard provides a Desktop Management Interface (DMI) function which records your mainboard specifications.

Dimension

- Q ATX Form Factor: 30.4 cm (L) x 23.5 cm (W)

Mounting

- Q 6 mounting holes

Others

- Q Modem (External/Internal) Ring Wake Up Function
- Q PCI 2.2 LAN Wake Up Function

Mainboard Layout

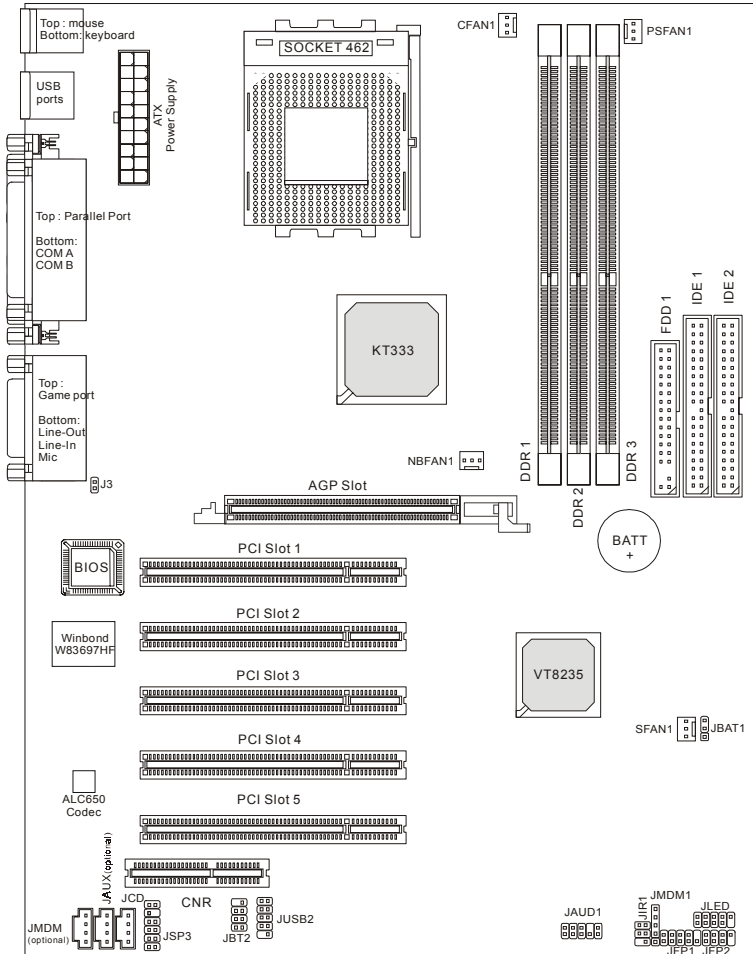

KT3 Ultra2 (MS-6380E) ATX Mainboard

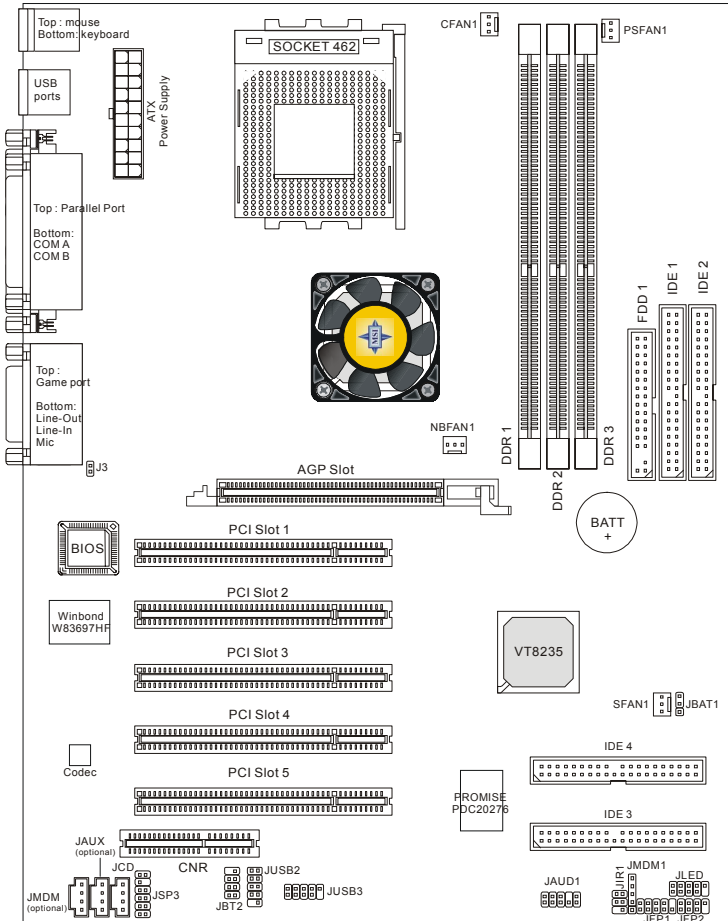

KT3 Ultra2-R (MS-6380E) ATX Mainboard

Quick Components Guide

Component	Function	Reference
JWR1	ATX 20-pin power connector	See p. 2-7
JKBMS1	Mouse connector	See p. 2-8
JKBMS1	Keyboard connector	See p. 2-9
COM A & COM B	Serial port connector	See p. 2-10
LPT1	Parallel port connector	See p. 2-11
FDD1	Floppy disk drive connector	See p. 2-13
IDE1~ IDE2	Hard disk connectors	See p. 2-14
IDE3~ IDE4	ATA133 RAID connectors	See p. 2-15
CFAN1/SFAN1/PSFAN1/ NBFAN1	Fan power connectors	See p. 2-16
JFP1 & JFP2	Front panel connectors	See p. 2-17
JAUDI	Front panel audio connector	See p. 2-18
JUSB2 & JUSB3	Front USB connectors	See p. 2-19
JCD/JAUX/JMDM	CD-in/Aux Line-in/Modem-in	See p. 2-21
JLED	D-Bracket 2 connector	See p. 2-22
JSP3	S-Bracket connector	See p. 2-23
JIR1	IrDA infrared module connector	See p. 2-24
J3	Chassis intrusion switch	See p. 2-24
JMDM1	Wake on ring connector	See p. 2-25
JBT2	Bluetooth connector	See p. 2-26
JBAT1	Clear CMOS jumper	See p. 2-27
AGP/PCI/CNR	Connecting expansion cards	See p. 2-28

MSI Special Features

PC Alert™ III

The PC Alert™ III is a utility you can find in the CD-ROM disk. The utility is just like your PC doctor that can detect the following PC hardware status during real time operation:

- * monitor CPU & system temperatures
- * monitor fan speed(s)
- * monitor system voltage
- * monitor chassis intrusion

If one of the items above is abnormal, the program main screen will be immediately shown on the screen, with the abnormal item highlighted in red. This will continue to be shown until user disables the warning.

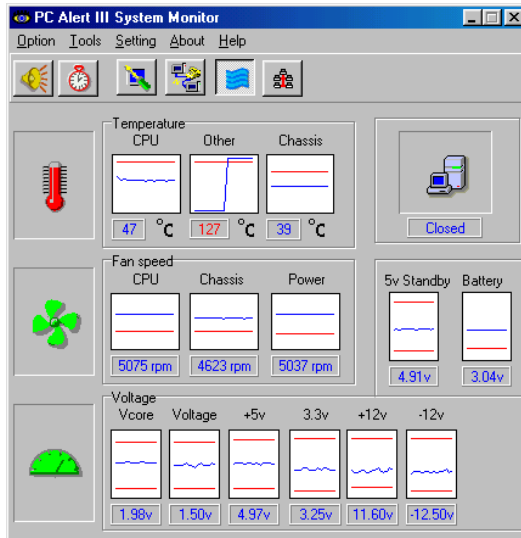

Note: Items shown on PC Alert III vary depending on your system's status.

Fuzzy Logic™4

The *Fuzzy Logic™ 4* utility is a user friendly tool that allows users to view and adjust the current system status. To overclock the CPU FSB (Front Side Bus) frequency under the Windows operating system, click **FSB** and use the right and left arrow keys to select the desired FSB, and then click **Apply** to apply the new setup value. To enable the system running at the specified FSB every time when you click **Turbo**, click **Save** to save the desired FSB first. If you want to know the maximal CPU overclocking value, click **Auto** to start testing. The CPU FSB will automatically increase the testing value until the PC reboots. After rebooting, click **Turbo** to apply the test result. Click **Default** to restore the default values.



Features:

- MSI Logo links to the MSI Web site
- CPU Speed allows users to adjust the CPU speed through CPU Multiplier and FSB
- Voltage allows user to adjust the voltage of CPU/Memory/AGP
- MSI Info provides information about the mainboard, BIOS and OS
- CPU Info provides detailed information about the CPU
- CPU Fan Speed shows the current running speed of CPU Fan
- CPU Temp. shows the current CPU temperature



Note: To adjust the options under **CPU Speed** and **Voltage**, use the right and left arrow keys to select the desired value and then click **Apply** to run the setup value.

Live BIOS™/Live Driver™

The Live BIOS™/Live Driver™ is a tool used to detect and update your BIOS/drivers online so that you don't need to search for the correct BIOS/driver version throughout the whole Web site. To use the function, you need to install the "MSI Live Update Series 2" application. After the installation, the "MSI Live Update Series 2" icon (as shown on the right) will appear on the screen.



Double click the "MSI Live Update Series 2" icon, and the following screen will appear:

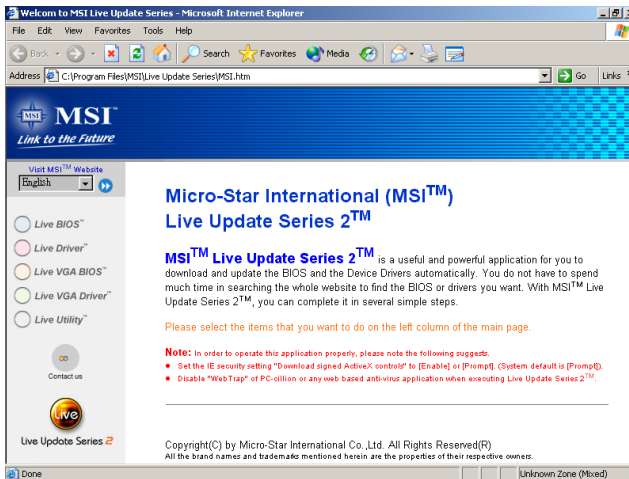

Five buttons are placed on the leftmost pane of the screen. Click the desired button to start the update process.

- **Live BIOS** – Updates the BIOS online.
- **Live Driver** – Updates the drivers online.
- **Live VGA BIOS** – Updates the VGA BIOS online.
- **Live VGA Driver** – Updates the VGA driver online.
- **Live Utility** – Updates the utilities online.

If the product you purchased does not support any of the functions listed above, a "sorry" message is displayed. For more information on the update instructions, insert the companion CD and refer to the "Live Update Series Guide" under the "Manual" Tab.

D-Bracket™ 2 (optional)

D-Bracket™ 2 is an external USB bracket integrating four Diagnostic LEDs, which use graphic signal display to help users understand their system. The LEDs provide up to 16 combinations of signals to debug the system. The 4 LEDs can debug all problems that fail the system, such as VGA, RAM or other failures. This special feature is very useful for the overclocking users. These users can use the feature to detect if there are any problems or failures.

D-Bracket™ 2 supports both USB 1.1 & 2.0 spec.

D-Bracket™ 2

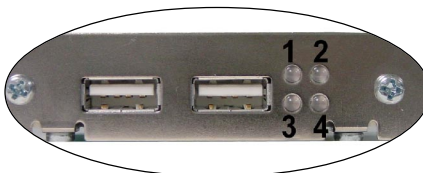









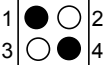

Red



Green

D-Bracket™2	Description
	<p>System Power ON</p> <p>- The D-LED will hang here if the processor is damaged or not installed properly.</p>
	<p>Early Chipset Initialization</p>
	<p>Memory Detection Test</p> <p>- Testing onboard memory size. The D-LED will hang if the memory module is damaged or not installed properly.</p>
	<p>Decompressing BIOS image to RAM for fast booting.</p>
	<p>Initializing Keyboard Controller.</p>
	<p>Testing VGA BIOS</p> <p>- This will start writing VGA sign-on message to the screen.</p>

D-Bracket™2	Description
 <p>1 ● ○ 2 3 ○ ● 4</p>	<p>Processor Initialization</p> <p>- This will show information regarding the processor (like brand name, system bus, etc...)</p>
	<p>Testing RTC (Real Time Clock)</p>
	<p>Initializing Video Interface</p> <p>- This will start detecting CPU clock, checking type of video onboard. Then, detect and initialize the video adapter.</p>
	<p>BIOS Sign On</p> <p>- This will start showing information about logo, processor brand name, etc....</p>
	<p>Testing Base and Extended Memory</p> <p>- Testing base memory from 240K to 640K and extended memory above 1MB using various patterns.</p>
	<p>Assign Resources to all ISA.</p>
	<p>Initializing Hard Drive Controller</p> <p>- This will initialize IDE drive and controller.</p>
	<p>Initializing Floppy Drive Controller</p> <p>- This will initializing Floppy Drive and controller.</p>
	<p>Boot Attempt</p> <p>- This will set low stack and boot via INT 19h.</p>
	<p>Operating System Booting</p>

S-Bracket (Optional)

S-Bracket is a bracket which provides 2 SPDIF jacks for digital audio transmission and 2 analog Line-Out connectors for additional 4-channel analog audio output. With the S-Bracket, your system will be able to perform 6-channel audio operation for wonderful surround sound effect, or connect to Sony & Philips Digital Interface (SPDIF) speakers for audio transmission with better quality.

The S-Bracket offers two types of SPDIF connectors: one for optical fiber and the other for coaxial connection. Select the appropriate one to meet your own need. For more information on S-Bracket, refer to *Appendix. Using 4- or 6-Channel Audio Function.*

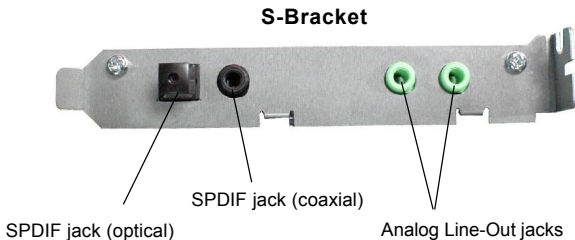

MSI DVD (5.1 Channel)

The motherboard comes with MSI DVD application which supports 5.1 channel (6-channel audio) operation. The accompanying MSI DVD is a convenient tool to meet increasing demands for home entertainment.



Note: MSI DVD supports Dolby Digital format only. To view DTS-formatted video, you should convert it to Dolby Digital format first.



To play DVD with 6-channel audio output, you must configure both the MSI DVD application and the audio codec's software utility. Otherwise, the 6-channel audio function will not work properly. For information on how to select 6-channel mode in the audio software utility, refer to *Appendix. Using 4- or 6-Channel Audio Function.*

Follow the procedures below to enable 6-channel support with MSI DVD:

1. Click on this button  from the control panel of MSI DVD.
2. Click the **Audio** tab.
3. Select **6 speaker mode (5.1 channel)**.

Chapter 1

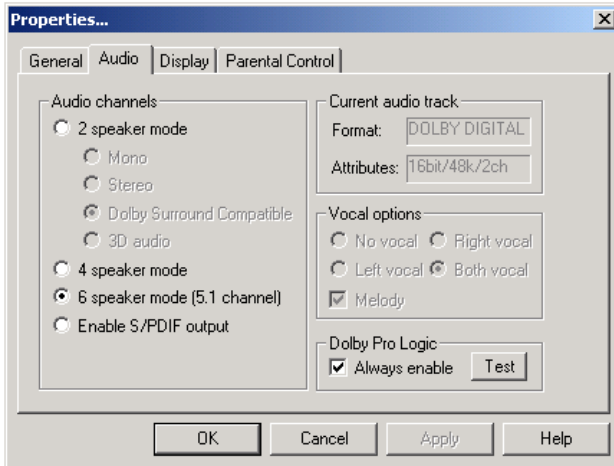

4. Click **OK**.

For more information about MSI DVD, you can refer to the online help coming with the application.

To enter the online help:

1. Click on the icon  at the bottom-right corner of the control panel.
2. The following window appears.

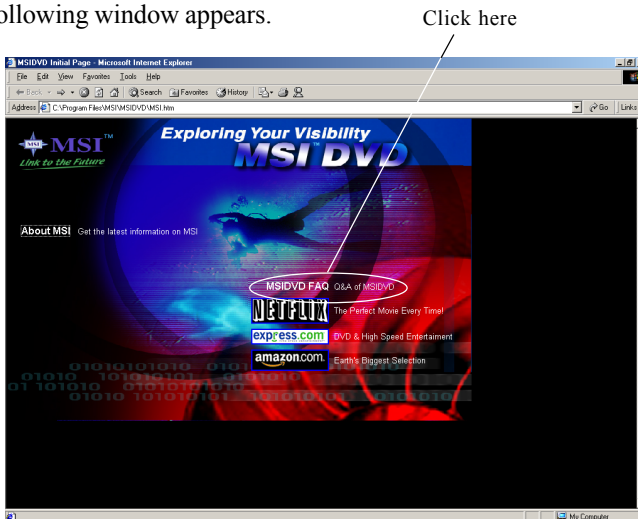

3. Click **MSIDVD FAQ**.

CPU Thermal Protection

Aimed to prevent the CPU from overheating, MSI has developed a CPU Thermal Protection mechanism for AMD Athlon XP CPU platform. This CPU Thermal Protection mechanism works on a thermal signal sensor. If the mechanism senses an abnormal temperature rise, it will automatically shut down the system and the CPU temperature will then drop down and resume normal. With this unique feature, users can better protect their CPU. Please note that this feature is for AMD Athlon XP CPU only.

Hardware Setup **2**

This chapter provides you with the information about hardware setup procedures. While doing the installation, be careful in holding the components and follow the installation procedures. For some components, if you install in the wrong orientation, the components will not work properly.

Use a grounded wrist strap before handling computer components. Static electricity may damage the components.

TOPICS

<i>Central Processing Unit: CPU</i>	2-2
<i>Memory</i>	2-5
<i>Power Supply</i>	2-7
<i>Back Panel</i>	2-8
<i>Connectors</i>	2-13
<i>Jumpers</i>	2-27
<i>Slots</i>	2-28

Central Processing Unit: CPU

The mainboard supports AMD® Athlon™, Athlon™ XP and Duron™ processors in the 462 pin package. The mainboard uses a CPU socket called Socket A for easy CPU installation. When you are installing the CPU, **make sure the CPU has a heat sink and a cooling fan attached on the top to prevent overheating.** If you do not find the heat sink and cooling fan, contact your dealer to purchase and install them before turning on the computer.

CPU Installation Procedures

1. Pull the lever sideways away from the socket. Then, raise the lever up to a 90-degree angle.
2. Look for the cut edge. The cut edge should point towards the lever pivot. The CPU will only fit in the correct orientation.
3. Hold the CPU down firmly, and then close the lever to complete the installation.

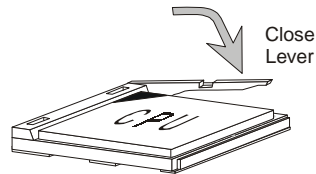
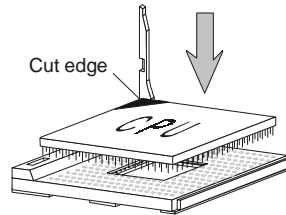
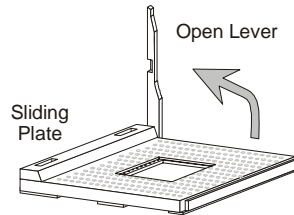

WARNING!

Overheating will seriously damage the CPU and system, always make sure the cooling fan can work properly to protect the CPU from overheating.



WARNING! Thermal Issue for CPU

As processor technology pushes to faster speeds and higher performance, thermal management becomes increasingly crucial when building computer systems. Maintaining the proper thermal environment is key to reliable operation. As such, the processor must be maintained in the specified thermal requirements.

AMD Athlon™/Duron™/Athlon™ XP processor with a speed of **600MHz and above** requires LARGER heatsink and fan. You also need to add thermal grease between the CPU and heatsink to improve heat dissipation. Then, make sure that the CPU and heatsink are securely fastened and in good contact with each other. These are needed to prevent damaging the processor and ensuring reliable operation. If you want to get more information on the proper cooling, you can visit AMD's website for reference.

CPU Core Speed Derivation Procedure

If CPU Clock = 100MHz
Core/Bus ratio = 7
then CPU core speed = Host Clock x Core/Bus ratio
= 100MHz x 7
= 700MHz

CPU Clock Frequency Selection through BIOS

The hardware configuration for CPU clock frequency of the motherboard is set to 100MHz by default. Therefore, to make a 133MHz CPU run at 133MHz when it is installed on the board, you have to adjust the CPU clock frequency in the BIOS setup utility.

To set the clock frequency for the installed CPU, refer to *Frequency/Voltage Control* in *Chapter 3. BIOS Setup*.



WARNING!

Replacing CPU

While replacing the CPU, always turn off the ATX power supply or unplug the power supply's power cord from grounded outlet first to ensure the safety of CPU.

Overclocking

*This motherboard is designed to support overclocking. However, please make sure your components are able to tolerate such abnormal setting, while doing overclocking. Any attempt to operate beyond product specifications is not recommended. **We do not guarantee the damages or risks caused by inadequate operation or beyond product specifications.***

Memory

The mainboard provides 3 sockets for 184-pin DDR SDRAM DIMM (Double In-Line Memory Module) modules and supports the memory size up to 3GB. You can install PC2700/DDR333, PC2100/DDR266 or PC1600/DDR200 modules on the DDR DIMM slots (DIMM 1~3).

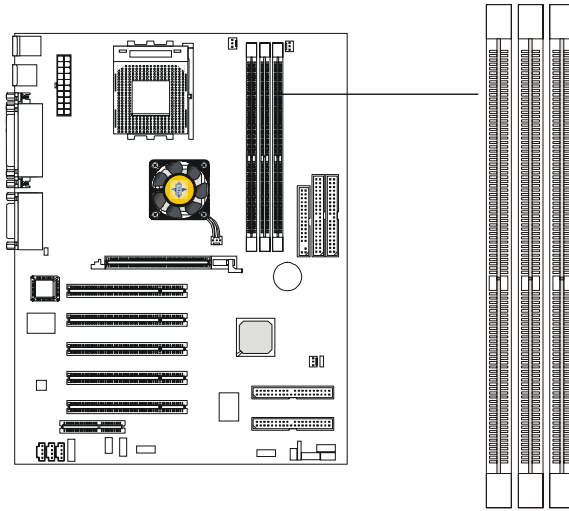

**DDR DIMM Slots
(DIMM 1~3)**

Introduction to DDR SDRAM

DDR (Double Data Rate) SDRAM is similar to conventional SDRAM, but doubles the rate by transferring data twice per cycle. It uses 2.5 volts as opposed to 3.3 volts used in SDR SDRAM, and requires 184-pin DIMM modules rather than 168-pin DIMM modules used by SDR SDRAM. High memory bandwidth makes DDR an ideal solution for high performance PC, workstations and servers.

DIMM Module Combination

Install at least one DIMM module on the slots. Memory modules can be installed on the slots in any order. You can install either single- or double-sided modules to meet your own needs.

Memory modules can be installed in any combination as follows:

Slot	Memory Module	Total Memory
DIMM 1 (Bank 0 & 1)	S/D	64MB~1GB
DIMM 2 (Bank 2 & 3)	S/D	64MB~1GB
DIMM 3 (Bank 4 & 5)	S/D	64MB~1GB
Maximum System Memory Supported		64MB~3GB

S: Single Side

D: Double Side

Installing DDR Modules

1. The DDR DIMM has only one notch on the center of module. The module will only fit in the right orientation.
2. Insert the DIMM memory module vertically into the DIMM slot. Then push it in until the golden finger on the memory module is deeply inserted in the socket.

 *TIP: You can barely see the golden finger if the module is properly inserted in the socket.*

3. The plastic clip at each side of the DIMM slot will automatically close.

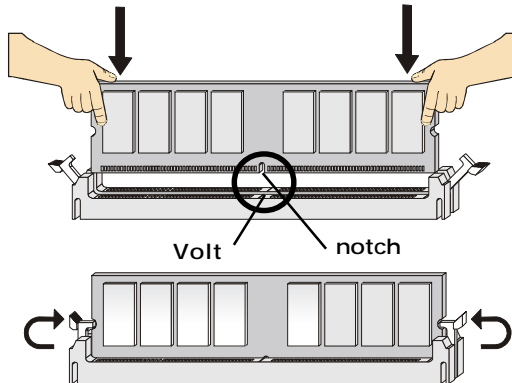

Power Supply

The mainboard supports ATX power supply for the power system. Before inserting the power supply connector, always make sure that all components are installed properly to ensure that no damage will be caused.

ATX 20-Pin Power Connector: JWR1

This connector allows you to connect to an ATX power supply. To connect to the ATX power supply, make sure the plug of the power supply is inserted in the proper orientation and the pins are aligned. Then push down the power supply firmly into the connector.

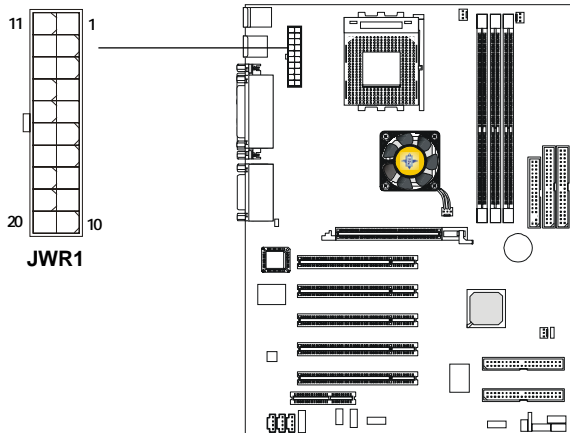

JWR1 Pin Definition

PIN	SIGNAL	PIN	SIGNAL
1	3.3V	11	3.3V
2	3.3V	12	-12V
3	GND	13	GND
4	5V	14	PS_ON
5	GND	15	GND
6	5V	16	GND
7	GND	17	GND
8	PW_OK	18	-5V
9	5V_SB	19	5V
10	12V	20	5V

Back Panel

The Back Panel provides the following connectors:

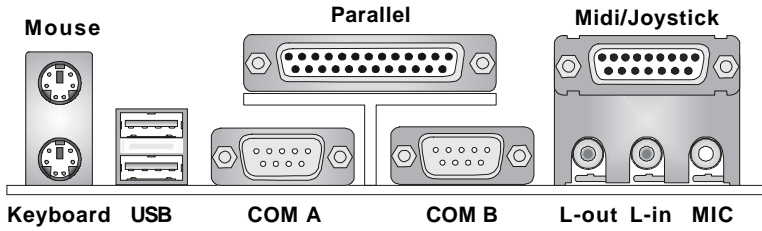

Mouse Connector: JKBMS1

The mainboard provides a standard PS/2[®] mouse mini DIN connector for attaching a PS/2[®] mouse. You can plug a PS/2[®] mouse directly into this connector. The connector location and pin assignments are as follows:

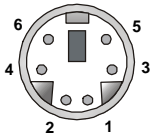

PS/2 Mouse (6-pin Female)

Pin Definition

PIN	SIGNAL	DESCRIPTION
1	Mouse DATA	Mouse DATA
2	NC	No connection
3	GND	Ground
4	VCC	+5V
5	Mouse Clock	Mouse clock
6	NC	No connection

Keyboard Connector: JKBMS1

The mainboard provides a standard PS/2® keyboard mini DIN connector for attaching a PS/2® keyboard. You can plug a PS/2® keyboard directly into this connector.

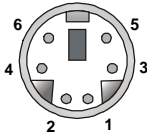

PS/2 Keyboard (6-pin Female)

Pin Definition

PIN	SIGNAL	DESCRIPTION
1	Keyboard DATA	Keyboard DATA
2	NC	No connection
3	GND	Ground
4	VCC	+5V
5	Keyboard Clock	Keyboard clock
6	NC	No connection

USB Connectors

The mainboard provides a UHCI (Universal Host Controller Interface) Universal Serial Bus root for attaching USB devices such as keyboard, mouse or other USB-compatible devices. You can plug the USB device directly into the connector.

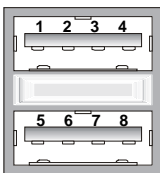

USB Ports

USB Port Description

PIN	SIGNAL	DESCRIPTION
1	VCC	+5V
2	-Data 0	Negative Data Channel 0
3	+Data 0	Positive Data Channel 0
4	GND	Ground
5	VCC	+5V
6	-Data 1	Negative Data Channel 1
7	+Data 1	Positive Data Channel 1
8	GND	Ground

Chapter 2

Serial Port Connectors: COM A & COM B

The mainboard offers two 9-pin male DIN connectors as serial port COM A & COM B. The ports are 16550A high speed communication ports that send/receive 16 bytes FIFOs. You can attach a serial mouse or other serial devices directly to the connectors.

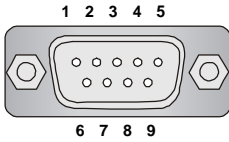

9-Pin Male DIN Connector

Pin Definition

PIN	SIGNAL	DESCRIPTION
1	DCD	Data Carry Detect
2	SIN	Serial In or Receive Data
3	SOUT	Serial Out or Transmit Data
4	DTR	Data Terminal Ready)
5	GND	Ground
6	DSR	Data Set Ready
7	RTS	Request To Send
8	CTS	Clear To Send
9	RI	Ring Indicate

Joystick/Midi Connector

You can connect a joystick or game pad to this connector.

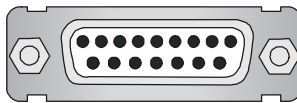

Parallel Port Connector: LPT1

The mainboard provides a 25-pin female centronic connector as LPT. A parallel port is a standard printer port that supports Enhanced Parallel Port (EPP) and Extended Capabilities Parallel Port (ECP) mode.

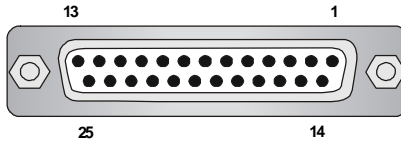

Pin Definition

PIN	SIGNAL	DESCRIPTION
1	STROBE	Strobe
2	DATA0	Data0
3	DATA1	Data1
4	DATA2	Data2
5	DATA3	Data3
6	DATA4	Data4
7	DATA5	Data5
8	DATA6	Data6
9	DATA7	Data7
10	ACK#	Acknowledge
11	BUSY	Busy
12	PE	Paper End
13	SELECT	Select
14	AUTO FEED#	Automatic Feed
15	ERR#	Error
16	INIT#	Initialize Printer
17	SLIN#	Select In
18	GND	Ground
19	GND	Ground
20	GND	Ground
21	GND	Ground
22	GND	Ground
23	GND	Ground
24	GND	Ground
25	GND	Ground

Chapter 2

Audio Port Connectors

Line Out is a connector for Speakers or Headphones. **Line In** is used for external CD player, Tape player, or other audio devices. **Mic** is a connector for microphones.

1/8" Stereo Audio Connectors

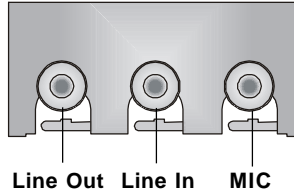

TIP:

The mainboard offers support for 6-channel audio operation and can turn rear audio connectors from 2-channel to 4-/6-channel audio. For more information on the issue, refer to Appendix. Using 4- or 6-Channel Audio Function.

Connectors

The mainboard provides connectors to connect to FDD, IDE HDD, case, modem, LAN, USB Ports, IR module and CPU/System/Power Supply FAN.

Floppy Disk Drive Connector: FDD1

The mainboard provides a standard floppy disk drive connector that supports 360K, 720K, 1.2M, 1.44M and 2.88M floppy disk types.

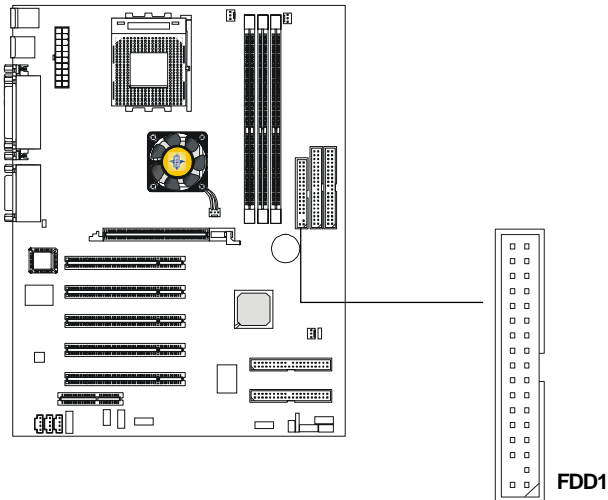

Hard Disk Connectors: IDE1 & IDE2

The mainboard has a 32-bit Enhanced PCI IDE and Ultra DMA 33/66/100/133 controller that provides PIO mode 0~4, Bus Master, and Ultra DMA 33/66/100/133 function. You can connect up to four hard disk drives, CD-ROM, 120MB Floppy (reserved for future BIOS) and other devices. These connectors support the provided IDE hard disk cable.

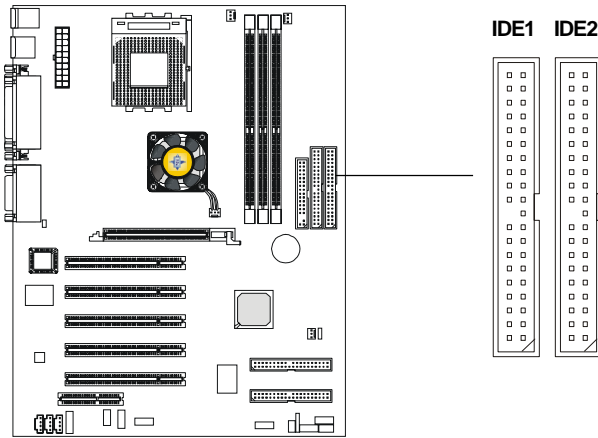

IDE1 (Primary IDE Connector)

The first hard drive should always be connected to IDE1. IDE1 can connect a Master and a Slave drive. You must configure second hard drive to Slave mode by setting the jumper accordingly.

IDE2 (Secondary IDE Connector)

IDE2 can also connect a Master and a Slave drive.



TIP:

If you install two hard disks on cable, you must configure the second drive to Slave mode by setting its jumper. Refer to the hard disk documentation supplied by hard disk vendors for jumper setting instructions.

ATA133 RAID Connectors: IDE3 & IDE4

The mainboard offers high-end Ultra ATA/133 RAID (0 or 1) hard drive interface specifications supported through Promise® PDC20276 controller .

The Ultra ATA/133 interface boosts data transfer rates between the computer and the hard drive up to 133 megabytes (MB) per second. The new interface is one-third faster than earlier record-breaking Ultra ATA/100 technology and is backward compatible with the existing Ultra ATA interface.

The low-cost RAID (Redundant Array of Independent Disks) solution integrates two IDE RAID connectors that support PIO mode 0-4, Bus Master, and Ultra DMA 33/66/100/133 modes. The IDE RAID connectors allow you to connect Ultra ATA/DMA hard disks and use RAID technology (RAID 0 striping or RAID 1 mirroring) for high performance, data security and fault tolerance.

ATA133 RAID Connectors:

- You can connect a Master drive to each IDE RAID connector.
- The two connectors support **hard disk drives** only.
- For more information on ATA133 RAID, please refer to *ATA133 RAID 0 or 1 Quick User's Guide*.

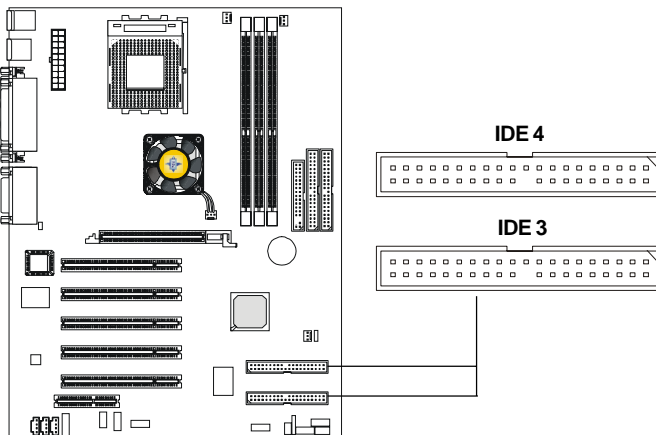

TIP:

If you install two hard disks on cable, you must configure the second drive to Slave mode by setting its jumper. Refer to the hard disk documentation supplied by hard disk vendors for jumper setting instructions.

Fan Power Connectors: CFAN1/SFAN1/PSFAN1/NBFAN1

The CFAN1 (processor fan), SFAN1 (system fan), PSFAN1 (power supply fan) and NBFAN1 (chipset fan) support system cooling fan with +12V. It supports three-pin head connector. When connecting the wire to the connectors, always take note that the red wire is the positive and should be connected to the +12V, the black wire is Ground and should be connected to GND. If the mainboard has a System Hardware Monitor chipset on-board, you must use a specially designed fan with speed sensor to take advantage of the CPU fan control.

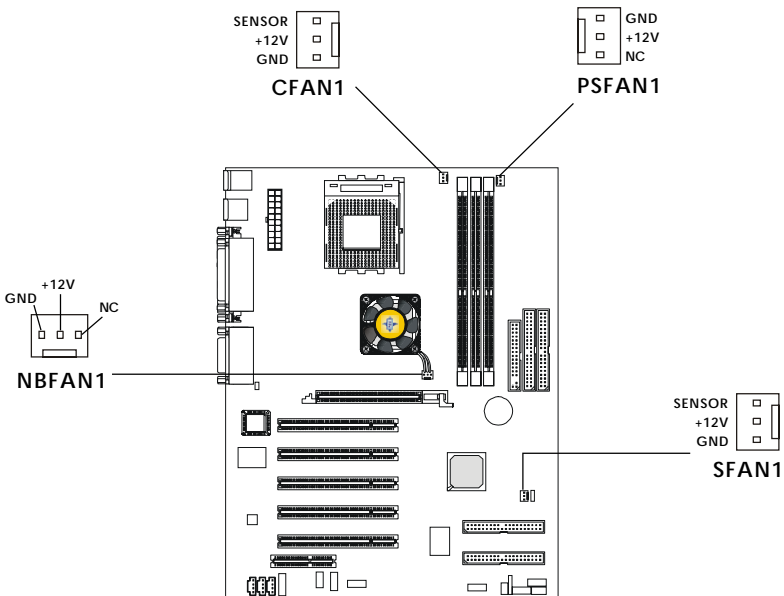

Note:

1. Always consult the vendor for proper CPU cooling fan.
2. CPU Fan supports the fan control. You can install the PC Alert utility that will automatically control the CPU Fan speed according to the actual CPU temperature.

Front Panel Connectors: JFP1 & JFP2

The mainboard provides two front panel connectors for electrical connection to the front panel switches and LEDs. JFP1 and FJP2 are compliant with Intel® Front Panel I/O Connectivity Design Guide.

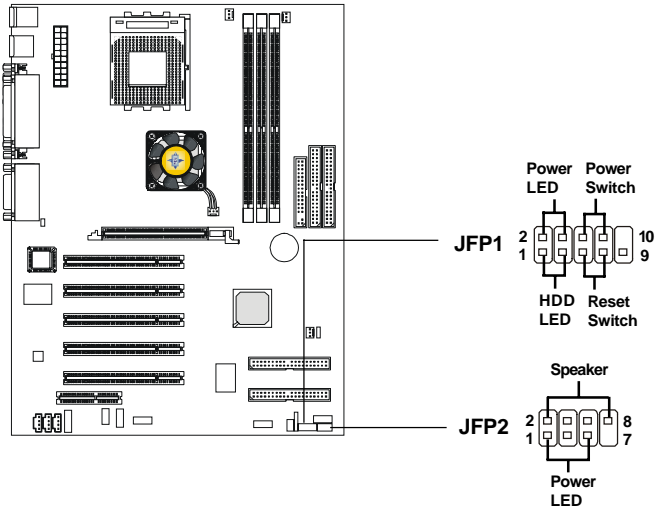

JFP1 Pin Definition

PIN	SIGNAL	DESCRIPTION
1	HD_LED_P	Hard disk LED pull-up
2	FP PWR/SLP	MSG LED pull-up
3	HD_LED_N	Hard disk active LED
4	FP PWR/SLP	MSG LED pull-up
5	RST_SW_N	Reset Switch low reference pull-down to GND
6	PWR_SW_P	Power Switch high reference pull-up
7	RST_SW_P	Reset Switch high reference pull-up
8	PWR_SW_N	Power Switch low reference pull-down to GND
9	RSVD_DNU	Reserved. Do not use.

JFP2 Pin Definition

PIN	SIGNAL	PIN	SIGNAL
1	GND	2	SPK-
3	SLED	4	BUZ+
5	PLED	6	BUZ-
7	NC	8	SPK+

Front Panel Audio Connector: JAUD1

The JAUD1 front panel audio connector allows you to connect to the front panel audio and is compliant with Intel® Front Panel I/O Connectivity Design Guide.

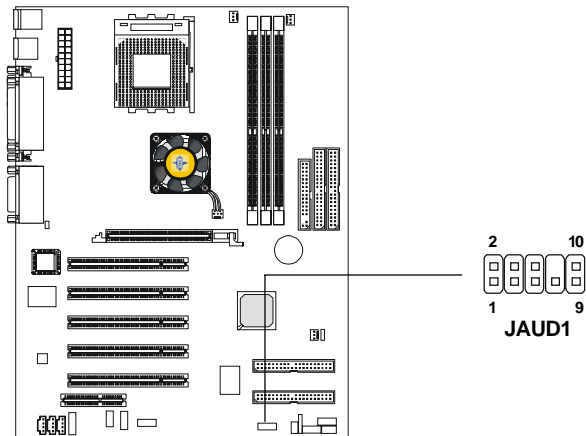

Pin Definition

PIN	SIGNAL	DESCRIPTION
1	AUD_MIC	Front panel microphone input signal
2	AUD_GND	Ground used by analog audio circuits
3	AUD_MIC_BIAS	Microphone power
4	AUD_VCC	Filtered +5V used by analog audio circuits
5	AUD_FPOUT_R	Right channel audio signal to front panel
6	AUD_RET_R	Right channel audio signal return from front panel
7	HP_ON	Reserved for future use to control headphone amplifier
8	KEY	No pin
9	AUD_FPOUT_L	Left channel audio signal to front panel
10	AUD_RET_L	Left channel audio signal return from front panel



Note:

If you don't want to connect to the front audio header, pins 5 & 6, 9 & 10 have to be jumpered in order to have signal output directed to the rear audio ports. Otherwise, the Line-Out connector on the back panel will not function.

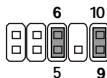

Front USB Connectors: JUSB2/3

The mainboard provides two USB 2.0 pin headers *JUSB2* & *JUSB3* (optional USB 2.0 bracket available) that are compliant with Intel® I/O Connectivity Design Guide. USB 2.0 technology increases data transfer rate up to a maximum throughput of 480Mbps, which is forty times faster than USB 1.1, and is ideal for connecting high-speed USB interface peripherals such as **USB HDD, digital cameras, MP3 players, printers, modems and the like**. It is not recommended to connect the low-speed USB legacy keyboard or mouse to the USB 2.0 port. You should connect the USB legacy devices to the USB rear ports.

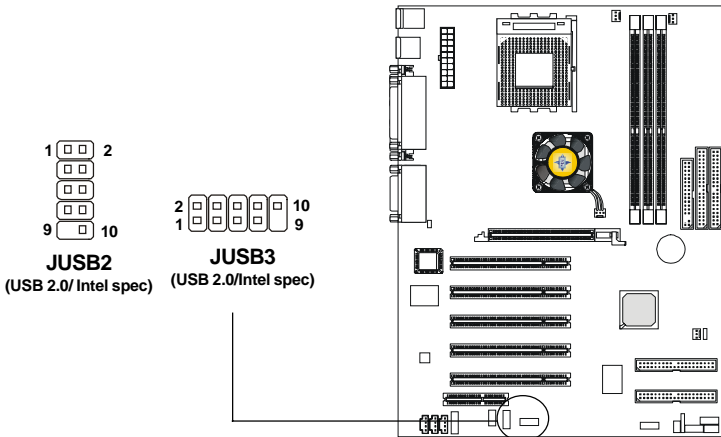

JUSB2/3 Pin Definition

PIN	SIGNAL	PIN	SIGNAL
1	USBPWR	2	USBPWR
3	USBP2-	4	USBP3-
5	USBP2+	6	USBP3+
7	GND	8	GND
9	NC	10	USBOC

Chapter 2

To Attach the Optional USB 2.0 Ports:

1. Take out the USB 2.0 bracket
2. Locate the blue USB pinheader (JUSB3) on the motherboard.
3. Connect the USB cable from USB 2.0 bracket to the JUSB3 pinheader.

Connected to JUSB3 (the
USB pinheader in blue color)

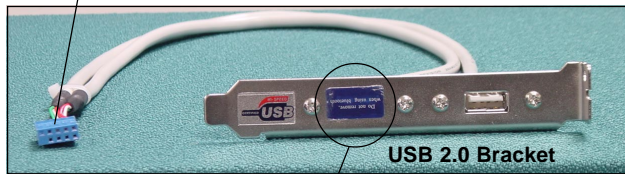

This USB 2.0 port will not function when a Bluetooth module is connected to the onboard Bluetooth pinheader JBT2. If no Bluetooth function is applied, remove the sticker to utilize this port.

4. Place the USB 2.0 bracket into the appropriate slot of the system case.



Note: The USB 2.0 controller is downward compatible with USB 1.1 spec. To use the USB 2.0 ports, you still need to install the USB 2.0 driver, which is supplied by Microsoft for Windows® 2000 and XP. If you have any questions regarding the USB 2.0 driver, please visit the Microsoft Web site for more information.

CD-In Connector: JCD

The connector is for CD-ROM audio connector.

Aux Line-In Connector: JAUX (optional)

The connector is for DVD add-on card with Line-in connector.

Modem-In Connector: JMDM (optional)

The connector is for modem with internal audio connector.

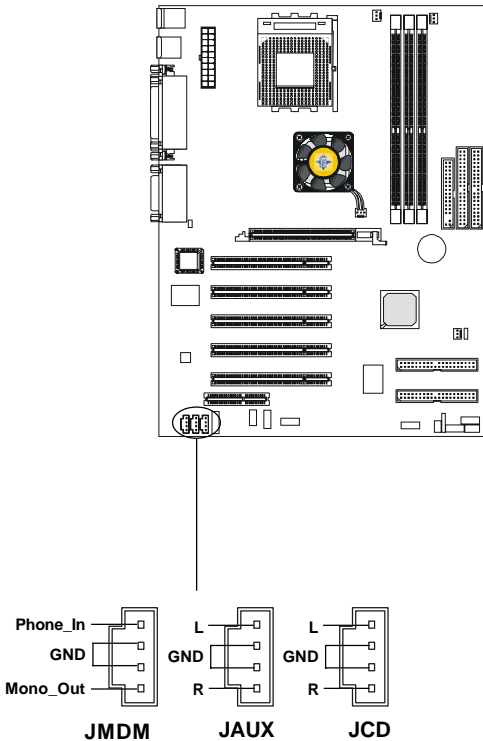

Chapter 2

D-Bracket™ 2 Connector: JLED

The mainboard comes with a JLED connector for you to connect to D-Bracket™ 2. D-Bracket™ 2 is a USB Bracket integrating four LEDs and allows users to identify system problem through 16 various combinations of LED signals. For definitions of signal combinations, please refer to *D-Bracket™ 2* in *Chapter 1*.

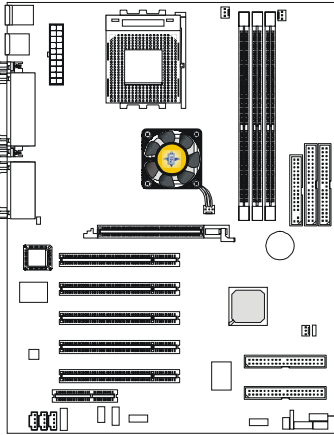

JLED Pin Definition

Pin	Signal
1	DBG1 (high for green color)
2	DBR1 (high for red color)
3	DBG2 (high for green color)
4	DBR2 (high for red color)
5	DBG3 (high for green color)
6	DBR3 (high for red color)
7	DBG4 (high for green color)
8	DBR4 (high for red color)
9	Key
10	NC



JLED

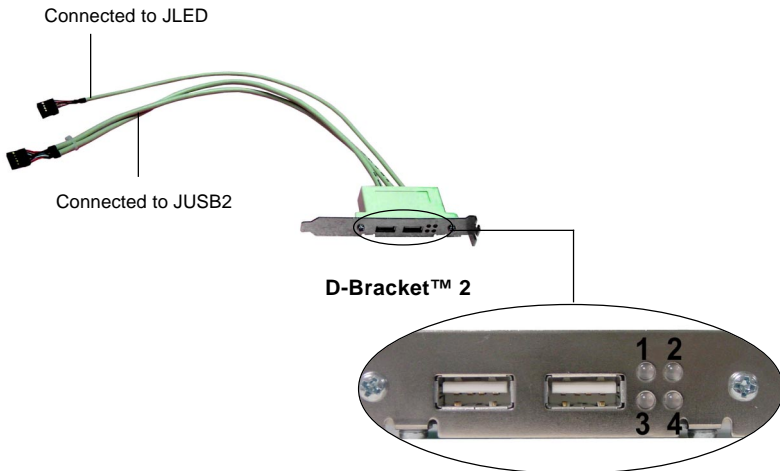

S-Bracket Connector: JSP3

The connector allows you to connect a S-Bracket for Sony & Philips Digital Interface (SPDIF). The S-Bracket offers 2 SPDIF jacks for digital audio transmission (one for optical fiber connection and the other for coaxial), and 2 analog Line-Out jacks for 4-channel audio output.

To attach the fiber-optic cable to optical SPDIF jack, you need to remove the plug from the jack first. The two SPDIF jacks support *SPDIF output* only. For more information on the S-Bracket, refer to *Appendix. Using 4- or 6-Channel Audio Function.*

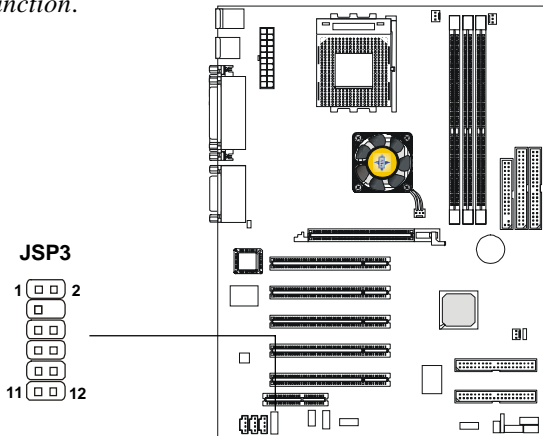

JSP3 Pin Definition

PIN	SIGNAL	DESCRIPTION	PIN	SIGNAL	DESCRIPTION
1	VCC5	VCC 5V	2	VDD3	VDD 3.3V
3	SPDFO	S/PDIF output	4	(No Pin)	Key
5	GND	Ground	6	SPDFI	S/PDIF input
7	LFE-OUT	Audio bass output	8	SOUT-R	Audio right surrounding output
9	GET-OUT	Audio center output	10	SOUT-L	Audio left surrounding output
11	GND	Ground	12	GND	Ground

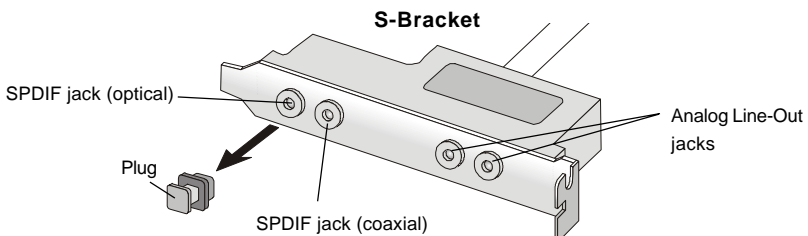

IrDA Infrared Module Header: JIR1

The connector allows you to connect to IrDA Infrared module. You must configure the setting through the BIOS setup to use the IR function. JIR1 is compliant with Intel® Front Panel I/O Connectivity Design Guide.

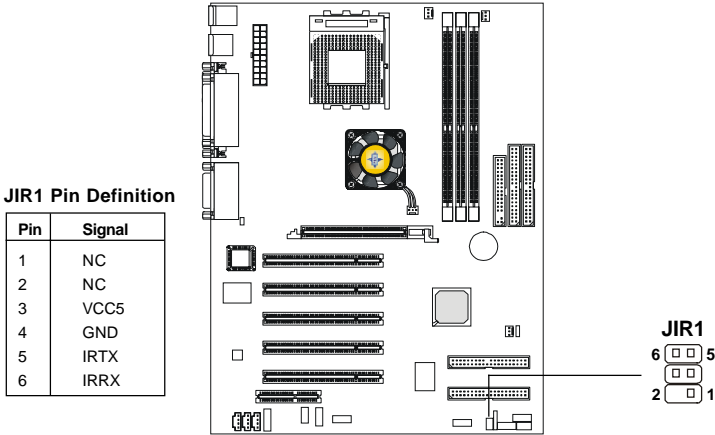

Chassis Intrusion Switch Connector: J3

This connector is connected to a 2-pin chassis switch. If the chassis is opened, the switch will be short. The system will record this status and show a warning message on the screen. To clear the warning, you must enter the BIOS utility and clear the record. J3 is compliant with Intel® Front Panel I/O Connectivity Design Guide.

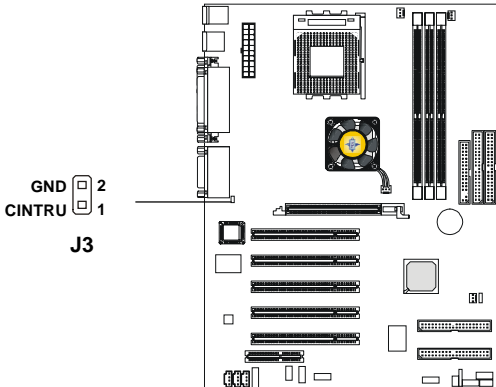

Wake On Ring Connector: JMDM1

This connector allows you to connect to a modem card with Wake On Ring function. The connector will power up the system when a signal is received through the modem card. JMDM1 is compliant with Intel® Front Panel I/O Connectivity Design Guide.

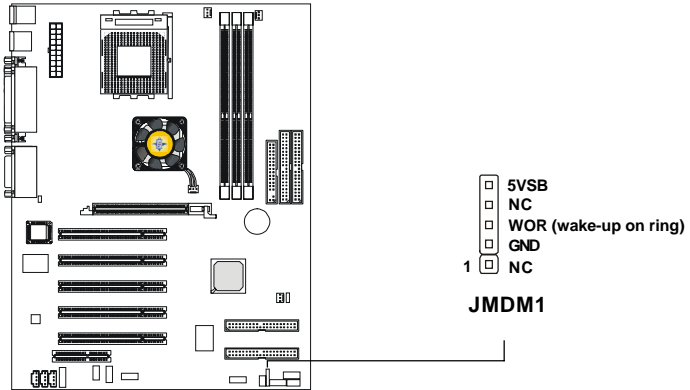

Bluetooth Connector: JBT2 (optional)

This connector is used to connect a bluetooth module for wireless connection.

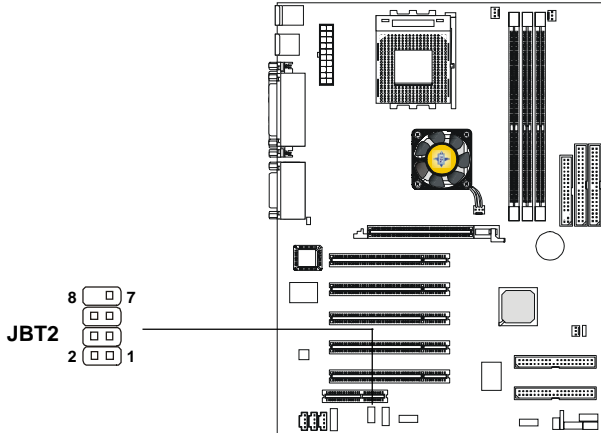

JBT2 Pin Definition

PIN	SIGNAL	PIN	SIGNAL
1	5VDUAL	2	3VDUAL
3	D+ (USB signal)	4	GND
5	D- (USB signal)	6	GND
7	GND	8	NC



Note:

1. Because the bluetooth connector shares the USB interface with blue-colored USB2.0 connector, the bottommost USB2.0 port will not function when you attach a bluetooth module to this connector.
2. Please refer to **PC2PC Bluetooth Quick User's Guide** for information on the bluetooth module.

Jumpers

The motherboard provides the following jumpers for you to set the computer's function. This section will explain how to change your motherboard's function through the use of jumpers.

Clear CMOS Jumper: JBAT1

There is a CMOS RAM on board that has a power supply from external battery to keep the data of system configuration. With the CMOS RAM, the system can automatically boot OS every time it is turned on. If you want to clear the system configuration, use the JBAT1 (Clear CMOS Jumper) to clear data. Follow the instructions below to clear the data:

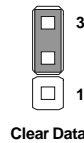
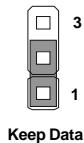
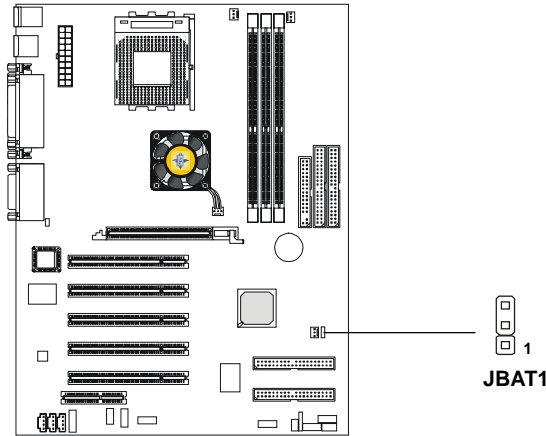

You can clear CMOS by shorting 2-3 pin while the system is off. Then return to 1-2 pin position. Avoid clearing the CMOS while the system is on; it will damage the mainboard.

Slots

The motherboard provides one AGP slot, five 32-bit Master PCI bus slots, and one CNR slot.

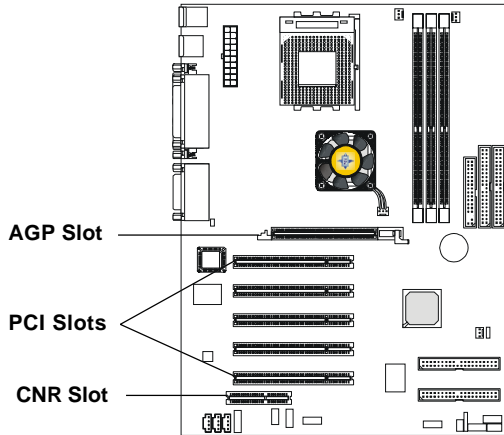

AGP (Accelerated Graphics Port) Slot

The AGP slot allows you to insert the AGP graphics card. AGP is an interface specification designed for the throughput demands of 3D graphics. It introduces a 66MHz, 32-bit channel for the graphics controller to directly access main memory and provides three levels of throughputs: 1x (266Mbps), 2x (533Mbps) and 4x (1.07Gbps).

PCI Slots

Five PCI slots allow you to insert the expansion cards to meet your needs. When adding or removing expansion cards, make sure that you unplug the power supply first. Meanwhile, read the documentation for the expansion card to make any necessary hardware or software settings for the expansion card, such as jumpers, switches or BIOS configuration.

CNR (Communication Network Riser) Slot

The CNR slot allows you to insert the CNR expansion cards. CNR is a specially designed network, audio, or modem riser card for ATX family motherboards. Its main processing is done through software and controlled by the motherboard's chipset. Please note the CNR slot of the mainboard **supports audio and modem only**.

PCI Interrupt Request Routing

The IRQ, abbreviation of interrupt request line and pronounced I-R-Q, are hardware lines over which devices can send interrupt signals to the microprocessor. The “AGP/PCI/Promise” IRQ pins are typically connected to the PCI bus INT A# ~ INT D# pins as follows:

	Order 1	Order 2	Order 3	Order 4
PCI Slot 1	INT A#	INT B#	INT C#	INT D#
PCI Slot 2	INT B#	INT C#	INT D#	INT A#
PCI Slot 3	INT C#	INT D#	INT A#	INT B#
PCI Slot 4	INT D#	INT A#	INT B#	INT C#
PCI Slot 5	INT B#	INT C#	INT D#	INT A#
AGP	INT A#	INT B#		
Promise ATA 133	INT D#			

The mainboard supports PCI Slot 1~5 Bus Master.

BIOS Setup

3

This chapter provides information on the BIOS Setup program and allows you to configure the system for optimum use.

You may need to run the Setup program when:

- An error message appears on the screen during the system booting up, and requests you to run SETUP.
- You want to change the default settings for customized features.

TOPICS

<i>Entering Setup</i>	3-2
<i>The Main Menu</i>	3-4
<i>Standard CMOS Features</i>	3-6
<i>Advanced BIOS Features</i>	3-8
<i>Advanced Chipset Features</i>	3-13
<i>Power Management Features</i>	3-18
<i>PNP/PCI Configurations</i>	3-22
<i>Integrated Peripherals</i>	3-24
<i>PC Health Status</i>	3-27
<i>Frequency/Voltage Control</i>	3-28
<i>Set Supervisor/User Password</i>	3-30
<i>Load High Performance/BIOS Setup Defaults</i>	3-31

Entering Setup

Power on the computer and the system will start POST (Power On Self Test) process. When the message below appears on the screen, press key to enter Setup.

DEL:Setup F11:Boot Menu F12:Network boot TAB:Logo

If the message disappears before you respond and you still wish to enter Setup, restart the system by turning it OFF and On or pressing the RESET button. You may also restart the system by simultaneously pressing <Ctrl>, <Alt>, and <Delete> keys.

Selecting the First Boot Device

You are allowed to select the 1st boot device without entering the BIOS setup utility by pressing <F11>. When the same message as listed above appears on the screen, press <F11> to trigger the boot menu.

The POST messages might pass by too quickly for you to respond in time. If so, restart the system and press <F11> after around 2 or 3 seconds to activate the boot menu similar to the following.

Select First Boot Device		
Floppy	:	1st Floppy
IDE-0	:	IBM-DTLA-307038
CDROM	:	ATAPI CD-ROM DRIVE 40X M
[Up/Dn] Select	[RETURN] Boot	[ESC] cancel

The boot menu will list all the bootable devices. Select the one you want to boot from by using arrow keys and then pressing <Enter>. The system will boot from the selected device. The selection will not make changes to the settings in the BIOS setup utility, so next time when you power on the system, it will still use the original first boot device to boot up.

Control Keys

<↑>	Move to the previous item
<↓>	Move to the next item
<←>	Move to the item in the left hand
<→>	Move to the item in the right hand
<Enter>	Select the item
<Esc>	Jumps to the Exit menu or returns to the main menu from a submenu
<+/PU>	Increase the numeric value or make changes
<-/PD>	Decrease the numeric value or make changes
<F5>	Restore the previous CMOS value from CMOS, only for Option Page Setup Menu
<F6>	Load High Performance Defaults
<F7>	Load BIOS Setup Defaults
<F10>	Save all the CMOS changes and exit

Getting Help

After entering the Setup utility, the first screen you see is the Main Menu.

Main Menu

The main menu displays the setup categories the BIOS supplies. You can use the arrow keys (↑↓) to select the item. The on-line description for the selected setup category is displayed at the bottom of the screen.

Default Settings

The BIOS setup program contains two kinds of default settings: the BIOS Setup and High Performance defaults. BIOS Setup defaults provide stable performance settings for all devices and the system, while High Performance defaults provide the best system performance but may affect the system stability.

Chapter 3

The Main Menu

Once you enter AMIBIOS NEW SETUP UTILITY, the Main Menu will appear on the screen. The Main Menu displays twelve configurable functions and two exit choices. Use arrow keys to move among the items and press <Enter> to enter the sub-menu.



Standard CMOS Features

Use this menu for basic system configurations, such as time, date etc.

Advanced BIOS Features

Use this menu to setup the items of AMI® special enhanced features.

Advanced Chipset Features

Use this menu to change the values in the chipset registers and optimize your system's performance.

Power Management Features

Use this menu to specify your settings for power management.

PNP/PCI Configurations

This entry appears if your system supports PnP/PCI.

Integrated Peripherals

Use this menu to specify your settings for integrated peripherals.

PC Health Status

This entry shows your PC health status.

Frequency/Voltage Control

Use this menu to specify your settings for frequency/voltage control.

Set Supervisor Password

Use this menu to set Supervisor Password.

Set User Password

Use this menu to set User Password.

Load High Performance Defaults

Use this menu to load the BIOS values for the best system performance, but the system stability may be affected.

Load BIOS Setup Defaults

Use this menu to load factory default settings into the BIOS for stable system performance operations.

Save & Exit Setup

Save changes to CMOS and exit setup.

Exit Without Saving

Abandon all changes and exit setup.

Chapter 3

Standard CMOS Features

The items inside STANDARD CMOS SETUP menu are divided into 9 categories. Each category includes none, one or more setup items. Use the arrow keys to highlight the item you want to modify and use the <PgUp> or <PgDn> keys to switch to the value you prefer.

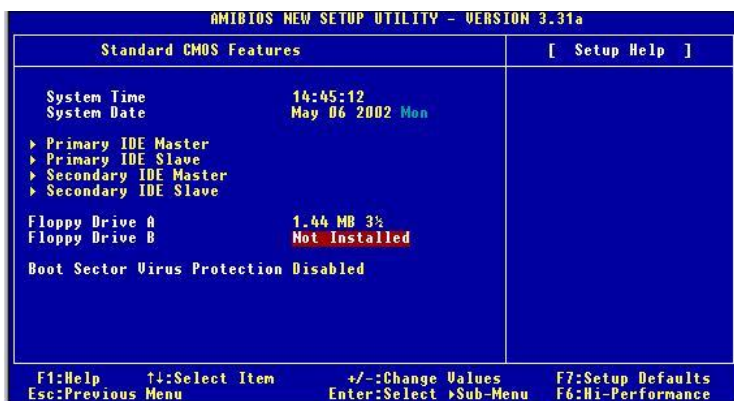

Date

This allows you to set the system to the date that you want (usually the current date). The format is <day><month> <date> <year>.

day Day of the week, from Sun to Sat, determined by BIOS. Read-only.

month The month from Jan. through Dec.

date The date from 1 to 31 can be keyed by numeric function keys.

year The year can be adjusted by users.

Time

This allows you to set the system time that you want (usually the current time). The time format is <hour> <minute> <second>.

Pri Master/Pri Slave/Sec Master/Sec Slave



Press PgUp/<+> or PgDn/<-> to select the hard disk drive type. The specification of hard disk drive will show up on the right hand according to your selection.

Type	Select how to define the HDD parameters
Cylinders	Enter cylinder number
Heads	Enter head number
Write Precompensation	Enter write precomp cylinder
Sectors	Enter sector number
Maximum Capacity	Read the maximal HDD capacity
LBA Mode	Select <i>Auto</i> for a hard disk > 512 MB under Windows and DOS, or <i>Disabled</i> under Nerware and UNIX
Block Mode	Select <i>Auto</i> to enhance the hard disk performance
Fast Programmed I/O Modes	Select <i>Auto</i> to enhance hard disk performance by optimizing the hard disk timing
32 Bit Transfer Mode	Enable 32 bit to maximize the IDE had disk data transfer rate

Floppy Drive A:/B:

This item allows you to set the type of floppy drives installed. Available options: *Not Installed*, *1.2 MB 5¼*, *720 KB 3½*, *1.44 MB 3½* and *2.88 MB 3½*.

Boot Sector Virus Protection

The item is to set the Virus Warning feature for IDE Hard Disk boot sector protection. When *Enabled*, BIOS will issue a virus warning message and beep if a write to the boot sector or the partition table of the HDD is attempted. Setting options: *Disabled* and *Enabled*.



Note: This feature only protects the boot sector, not the whole hard disk.

Advanced BIOS Features



Quick Boot

Setting the item to *Enabled* allows the system to boot within 5 seconds since it will skip some check items. Available options: *Enabled, Disabled*.

Full Screen Logo Show

This item enables you to show the company logo on the bootup screen. Settings are:

- Enabled* Shows a still image (logo) on the full screen at boot.
- Disabled* Shows the POST messages at boot.

Boot Sequency

Press <Enter> to enter the sub-menu screen.

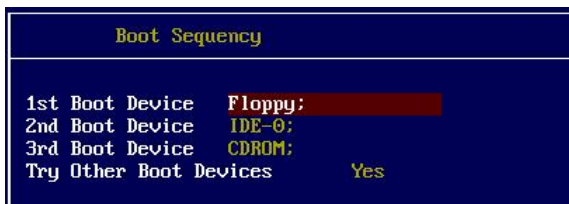

1st/2nd/3rd Boot Device

The items allow you to set the sequence of boot devices where AMIBIOS attempts to load the operating system. The settings are:

- IDE-0* The system will boot from the first HDD.
- IDE-1* The system will boot from the second HDD.
- IDE-2* The system will boot from the third HDD.
- IDE-3* The system will boot from the fourth HDD.
- Floppy* The system will boot from floppy drive.
- ARMD-FDD* The system will boot from any ARMD device, such as LS-120 or ZIP drive, that functions as a floppy drive.
- ARMD-HDD* The system will boot from ARMD device, such as MO or ZIP drive, that functions as hard disk drive.
- CDROM* The system will boot from the CD-ROM.
- Legacy SCSI* The system will boot from the SCSI.
- Legacy NETWO* The system will boot from the Network drive.
- BBS-0* The system will boot from the first BBS (BIOS Boot Specification) compliant device.
- BBS-1* The system will boot from the second BBS (BIOS Boot Specification) compliant device.
- BBS-2* The system will boot from the third BBS (BIOS Boot Specification) compliant device.
- BBS-3* The system will boot from the fourth BBS (BIOS Boot Specification) compliant device.
- USB FDD* The system will boot from USB-interfaced floppy drive.
- USB CDROM* The system will boot from the USB-interfaced CD-ROM.
- USB HDD* The system will boot from the USB-interfaced HDD.
- USB RMD-FDD* The system will boot from any USB-interfaced ARMD device, such as LS-120 or ZIP drive, that functions as a floppy drive.
- USB RMD-HDD* The system will boot from USB-interfaced ARMD device, such as MO or ZIP drive, that functions as hard disk drive.
- Disabled* Disable this sequence.

Chapter 3



Note: Available settings for “1st/2nd/3rd Boot Device” vary depending on the bootable devices you have installed. For example, if you did not install a floppy drive, the setting “Floppy” does not show up.

Try Other Boot Devices

Setting the option to *Yes* allows the system to try to boot from other devices if the system fails to boot from the 1st/2nd/3rd boot device.

S.M.A.R.T. for Hard Disks

This allows you to activate the S.M.A.R.T. (Self-Monitoring Analysis & Reporting Technology) capability for the hard disks. S.M.A.R.T. is a utility that monitors your disk status to predict hard disk failure. This gives you an opportunity to move data from a hard disk that is going to fail to a safe place before the hard disk becomes offline. Settings: *Enabled, Disabled*.

BootUpNum-Lock

This item is to set the Num Lock status when the system is powered on. Setting to *On* will turn on the Num Lock key when the system is powered on. Setting to *Off* will allow end users to use the arrow keys on the numeric keypad. Setting options: *On, Off*.

Floppy Drive Swap

Setting to *Enabled* will swap floppy drives A: and B:.

Floppy Drive Seek

This setting causes the BIOS to search for floppy disk drives at boot time. When enabled, the BIOS will activate the floppy disk drives during the boot process: the drive activity light will come on and the head will move back and forth once. First A: will be done and then B: if it exists. Setting options: *Disabled, Enabled*.

Primary Display

This configures the primary subsystem in the computer. Available options: *Mono (monochrome), CGA40x25, CGA80x25, VGA/EGA, Absent*.

Password Check

This specifies the type of AMIBIOS password protection that is implemented. Setting options are described below.

Option	Description
Setup	The password prompt appears only when end users try to run Setup.
Always	A password prompt appears every time when the computer is powered on or when end users try to run Setup.

Boot To OS/2

This allows you to run the OS/2® operating system with DRAM larger than 64MB. When you choose *No*, you cannot run the OS/2® operating system with DRAM larger than 64MB. But it is possible if you choose *Yes*.

Internal Cache

Cache memory is additional memory that is much faster than conventional DRAM (system memory). When the CPU requests data, the system transfers the requested data from the main DRAM into cache memory, for even faster access by the CPU. The setting controls the internal cache (also known as L1 or level 1 cache). Setting to *WriteBack* will speed up the system performance.

System BIOS Cacheable

Selecting *Enabled* allows caching of the system BIOS ROM at F0000h-FFFFFh, resulting in better system performance. However, if any program writes to this memory area, a system error may result. Setting options: *Enabled*, *Disabled*.

C000, 32k Shadow

This item specifies how the contents of the adapter ROM named in the item are handled. Settings are described below:

Option	Description
Disabled	The specified ROM is not copied to RAM.
Enabled	The contents of specified ROM are copied to RAM for faster system performance.
Cached	The contents of specified ROM are not only copied to RAM, the contents of the ROM area can be written to and read from cache memory.

Chapter 3

APIC Function

This field is used to enable or disable the APIC (Advanced Programmable Interrupt Controller). Due to compliance to PC2001 design guide, the system is able to run in APIC mode. Enabling APIC mode will expand available IRQs resources for the system. Settings: *Enabled, Disabled*.

MPS Table Version

This field allows you to select which MPS (Multi-Processor Specification) version to be used for the operating system. You need to select the MPS version supported by your operating system. To find out which version to use, consult the vendor of your operating system. Settings: *1.4, 1.1*.

Advanced Chipset Features

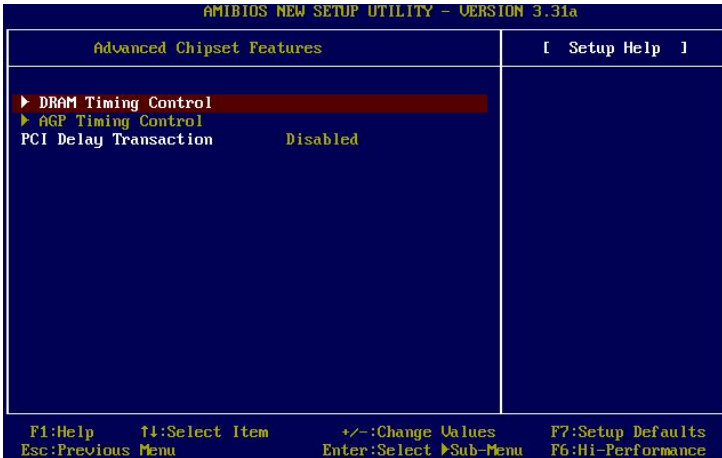

 *Note: Change these settings only if you are familiar with the chipset.*

DRAM Timing Control

Press <Enter> and the following sub-menu appears.

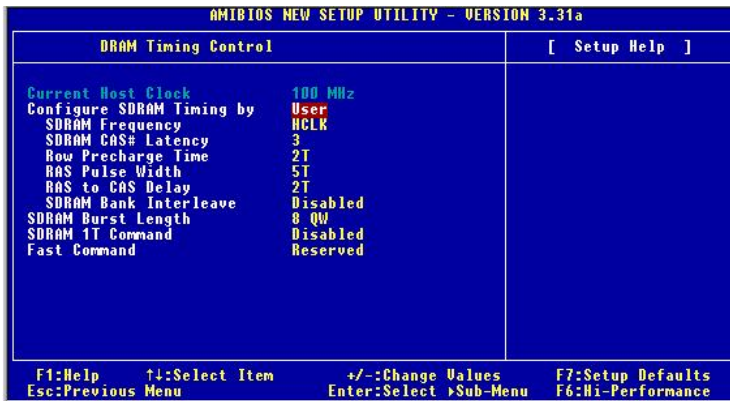

Current Host Clock

This item shows the current CPU frequency.

Chapter 3

Configure SDRAM Timing by

Selects whether DRAM timing is controlled by the SPD (Serial Presence Detect) EEPROM on the DRAM module. Setting to *SPD* enables SDRAM Frequency, SDRAM CAS# Latency, Row Precharge Time, RAS Pulse Width, RAS to CAS Delay and SDRAM Bank Interleave automatically to be determined by BIOS based on the configurations on the SPD. Selecting *User* allows users to configure these fields manually.

SDRAMFrequency

Use this item to configure the clock frequency of the installed SDRAM. Settings options: *SPD*, *HCLK*, *HCLK+33*, *HCLK+66*.

SDRAM CAS# Latency

This controls the timing delay (in clock cycles) before SDRAM starts a read command after receiving it. Settings: 2, 3 (clocks). 2 (clocks) increases the system performance the most while 3 (clocks) provides the most stable performance.

Row Precharge Time

This item controls the number of cycles for Row Address Strobe (RAS) to be allowed to precharge. If insufficient time is allowed for the RAS to accumulate its charge before DRAM refresh, refresh may be incomplete and DRAM may fail to retain data. This item applies only when synchronous DRAM is installed in the system. Available settings: *2T*, *3T*.

RAS Pulse Width

This setting allows you to select the number of clock cycles allotted for the RAS pulse width, according to DRAM specifications. The less the clock cycles, the faster the DRAM performance. Settings: *6T*, *5T*.

RAS to CAS Delay

This field allows you to set the number of cycles for a timing delay between the CAS and RAS strobe signals, used when DRAM is written to, read from or refreshed. Fast speed offers faster performance while slow speed offers more stable performance. Settings: *3T*, *2T*.

SDRAM Bank Interleave

This field selects 2-bank or 4-bank interleave for the installed SDRAM. Disable the function if 16MB SDRAM is installed.

Settings: *Disabled*, *2-Way* and *4-Way*.

SDRAM Burst Length

This setting allows you to set the size of Burst-Length for DRAM. Bursting feature is a technique that DRAM itself predicts the address of the next memory location to be accessed after the first address is accessed. To use the feature, you need to define the burst length, which is the actual length of burst plus the starting address and allows internal address counter to properly generate the next memory location. The bigger the size, the faster the DRAM performance. Settings: *4 QW*, *8 QW*.

SDRAM1T Command

This setting controls the SDRAM command rate. Selecting *Enabled* allows SDRAM signal controller to run at 1T (T=clock cycles) rate. Selecting *Disabled* makes SDRAM signal controller run at 2T rate. *1T* is faster than *2T*. Setting options: *Disabled*, *Enabled*.

FastCommand

This item controls the internal timing of CPU. Selecting *Ultra* allows CPU to handle data/instructions at the fastest speed. *Fast* enables CPU to handle at a faster speed, while *Normal* let CPU handle them at the slowest rate.

AGP Timing Control

Press <Enter> and the following sub-menu appears.

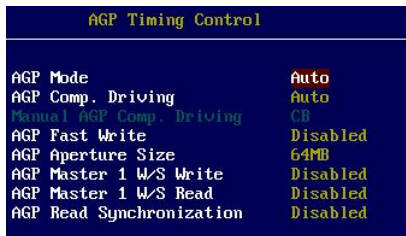

AGPMode

The item sets an appropriate mode for the installed AGP card. Setting options: *1x*, *2x*, *4x*, *Auto*. Select *4x* only if your AGP card supports it.

Chapter 3

AGP Comp. Driving

This field is used to adjust the AGP driving force. Selecting *Manual* allows you to select an AGP driving force in **Manual AGP Comp. Driving**. It is strongly recommended to select *Auto* to avoid causing any system error.

Manual AGP Comp. Driving

This item specifies an AGP driving force.

AGP Fast Write

This field enables or disables the AGP Fast Write feature. The Fast Write technology allows the CPU to write directly to the graphics card without passing anything through the system memory and improves the AGP 4X speed. Select *Enabled* only when the installed AGP card supports the function.

AGP Aperture Size

This setting controls just how much system RAM can be allocated to AGP for video purposes. The aperture is a portion of the PCI memory address range dedicated to graphics memory address space. Host cycles that hit the aperture range are forwarded to the AGP without any translation. The option allows the selection of an aperture size of *4MB, 8MB, 16MB, 32MB, 64MB, 128MB, and 256 MB*.

AGP Master 1 W/S Write

The field allows users to insert one wait state into the AGP write cycle. Settings: *Enabled, Disabled*.

AGP Master 1 W/S Read

The field allows users to insert one wait state into the AGP read cycle. Settings: *Enabled, Disabled*.

AGP Read Synchronization

The field allows you to enable or disable the AGP Read Synchronization feature. Settings: *Enabled, Disabled*.

PCIDelay Transaction

The chipset has an embedded 32-bit posted write buffer to support delayed

transactions cycles so that transactions to and from the ISA bus are buffered and PCI bus can perform other transactions while the ISA transaction is underway. Select *Enabled* to support compliance with PCI specification version 2.1. Setting options: *Enabled, Disabled*.

Power Management Features

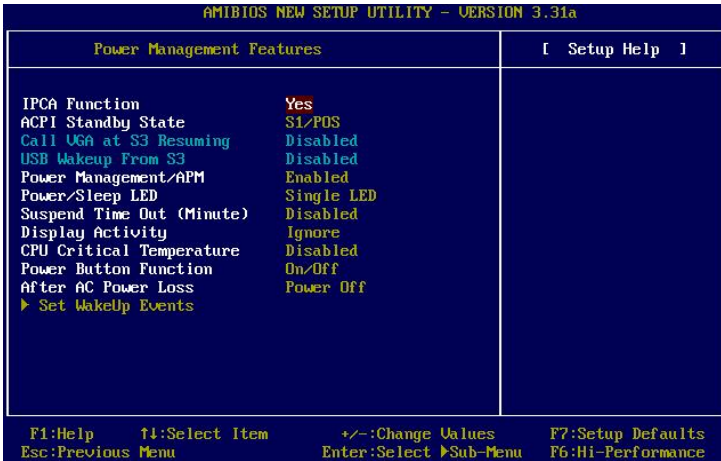

(S3-related functions described in this section are available only when your BIOS supports S3 sleep mode.)

IPCA Function

This item is to activate the ACPI (Advanced Configuration and Power Management Interface) function. If your operating system is ACPI-aware, such as Windows 98SE/2000/ME, select *Yes*. Available options: *Yes*, *No*.

ACPI Standby State

This item specifies the power saving modes for ACPI function. If your operating system supports ACPI, such as Windows 98SE, Windows ME and Windows 2000, you can choose to enter the Standby mode in S1(POS) or S3(STR) fashion through the setting of this field. Options are:

- S1/POS* The S1 sleep mode is a low power state. In this state, no system context is lost (CPU or chipset) and hardware maintains all system context.

- S3/STR* The S3 sleep mode is a lower power state where the information of system configuration and open applications/files is saved to main memory that remains powered while most other hardware components turn off to save energy.

The information stored in memory will be used to restore the system when a “wake up” event occurs.

Auto BIOS determines the best mode automatically.

Call VGA at S3 Resuming

Selecting *Enabled* allows BIOS to call VGA BIOS to initialize the VGA card when system wakes up (resume) from S3 sleep state. The system resume time is shortened when you disable the function, but system will need an AGP driver to initialize the VGA card. Therefore, if the AGP driver of the card does not support the initialization feature, the display may work abnormally or not function after resuming from S3.

USB Wakeup From S3

This item allows the activity of the USB device to wake up the system from S3 (Suspend to RAM) sleep state. Settings: *Enabled, Disabled*.

Power Management/APM

Setting to *Enabled* will activate an Advanced Power Management (APM) device to enhance Max Saving mode and stop CPU internal clock. Settings: *Disabled, Enabled*.

Power/Sleep LED

This item configures how the system uses power LED on the case to indicate the sleep/suspend state. Available options are:

Single LED The power LED turns off to indicate the sleep/suspend state.

Dual LED The power LED changes its color to indicate the sleep/suspend state.

Suspend Time Out (Minute)

After the selected period of system inactivity, all devices except the CPU shut off. Settings: *Disabled, 1, 2, 4, 8, 10, 20, 30, 40, 50, 60*.

Display Activity

These items specify if the BIOS will monitor the activity of the specified hardware peripheral or component. If set to *Monitor*, any activity detected on the specified hardware peripheral or component will wake up the system or prevent the system from entering the power saving modes. Settings: *Monitor, Ignore*.

Chapter 3

CPU Critical Temperature

If the CPU temperature reaches the upper limit preset in this setting, the warning mechanism will be activated. This helps you to prevent the CPU overheating problem.

Power Button Function

This feature sets the function of the power button. Settings are:

<i>On/Off</i>	The power button functions as normal power off button.
<i>Suspend</i>	When you press the power button, the computer enters the suspend/sleep mode, but if the button is pressed for more than four seconds, the computer is turned off.

After AC Power Loss

This setting specifies whether your system will reboot after a power failure or interrupt occurs. Available settings are:

<i>Power Off</i>	Leaves the computer in the power off state.
<i>Power On</i>	Reboots the computer.
<i>Last State</i>	Restores the system to the previous status before power failure or interrupt occurred.

Set Wake Up Events

Press <Enter> and the following sub-menu appears.



**Resume On KBC (with “Wake-Up Key” and “Wake-Up Password”),
Resume On PS/2 Mouse**

These fields specify whether the system will be awakened from power saving modes when activity or input signal of the specified hardware peripheral or component is detected. Settings: *S3, Disabled*.



Note:

1. For “Wake-Up Key” function, the option “Specific Key” refers to the password you specify in the “Wake-Up Password” field. Once you set up a password, it will disable “Resume on PS/2 Mouse”.
2. For “Resume On PS/2 Mouse” function, you need to click the mouse to power on the system if the function is enabled.

Wake Up On Ring/PME

When setting to *Enabled*, these two features allow your system to be awakened from the power saving modes through modem or any event on PME (Power Management Event). Both features support S1~S5 modes. However, to enable the “Wake Up On Ring” feature, you need to install a modem card supporting power on function. Settings: *Enabled, Disabled*.

Resume By Alarm

This is used to enable or disable the feature of booting up the system on a scheduled time/date from the soft off (S5) state. Settings: *Enabled, Disabled*.

Alarm Date/Hour/Minute/Second

If *Resume By Alarm* is set to *Enabled*, the system will automatically resume (boot up) on a specific date/hour/minute/second specified in these fields. Available settings for each item are:

Alarm Date	01 ~ 31, Every Day
Alarm Hour	00 ~ 23
Alarm Minute	00 ~ 59
Alarm Second	00 ~ 59



Note: If you have changed this setting, you must let the system boot up until it enters the operating system, before this function will work.

PNP/PCI Configurations

This section describes configuring the PCI bus system and PnP (Plug & Play) feature. PCI, or **P**eripheral **C**omponent **I**nterconnect, is a system which allows I/O devices to operate at speeds nearing the speed the CPU itself uses when communicating with its special components. This section covers some very technical items and it is strongly recommended that only experienced users should make any changes to the default settings.

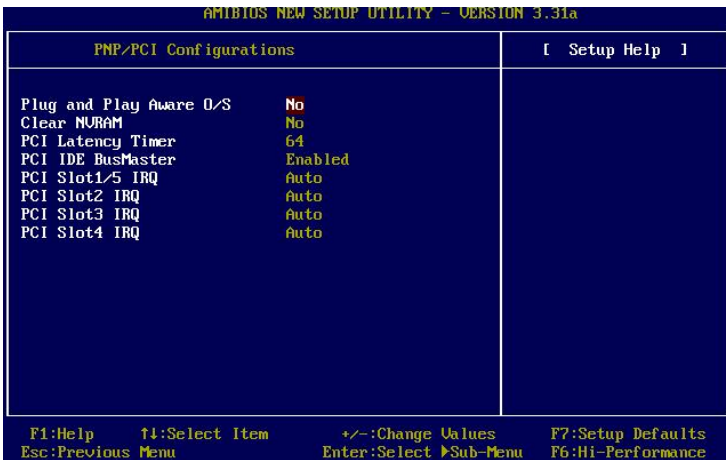

Plug and Play Aware O/S

When set to *Yes*, BIOS will only initialize the PnP cards used for booting (VGA, IDE, SCSI). The rest of the cards will be initialized by the PnP operating system like Windows® 98, 2000 or ME. When set to *No*, BIOS will initialize all the PnP cards. Select *Yes* if the operating system is Plug & Play.

Clear NVRAM

The ESCD (Extended System Configuration Data) NVRAM (Non-volatile Random Access Memory) is where the BIOS stores resource information for both PNP and non-PNP devices in a bit string format. When the item is set to *Yes*, the system will reset ESCD NVRAM right after the system is booted up and then set the setting of the item back to *No* automatically.

PCILatency Timer

This item controls how long each PCI device can hold the bus before another takes over. When set to higher values, every PCI device can conduct transactions for a longer time and thus improve the effective PCI bandwidth. For better PCI performance, you should set the item to higher values. Settings range from 32 to 248 at a 32 increment.

PCIIDE BusMaster

Set this option to *Enabled* to specify that the IDE controller on the PCI local bus has bus mastering capability. Settings options: *Disabled, Enabled*.

PCI Slot1/5 IRQ, PCI Slot2 IRQ, PCI Slot3 IRQ, PCI Slot4 IRQ

These items specify the IRQ line for each PCI slot. Setting options: 3, 4, 5, 7, 9, 10, 11, *Auto*. Selecting *Auto* allows BIOS to automatically determine the IRQ line for each PCI slot.

Integrated Peripherals

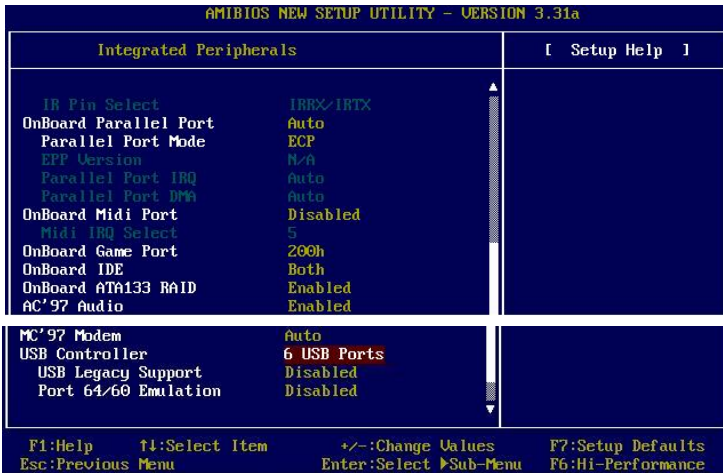

FDCFunction

This is used to enable or disable the onboard Floppy controller.

Option	Description
Auto	BIOS will automatically determine whether to enable the onboard Floppy controller or not.
Enabled	Enables the onboard Floppy controller.
Disabled	Disables the onboard Floppy controller.

Serial Port 1/2

These items specify the base I/O port addresses of the onboard Serial Port 1 (COM A)/Serial Port 2 (COM B). Selecting *Auto* allows AMIBIOS to automatically determine the correct base I/O port address. Settings: *Auto*, *3F8/COM1*, *2F8/COM2*, *3E8/COM3*, *2E8/COM4* and *Disabled*.

Serial Port2 Mode

This item sets the operation mode for Serial Port 2. Settings: *Normal*, *1.6uS*, *3/16 Baud* and *ASKIR* (the last three operation modes are setting options for IR function).

IR Pin Select

Set to *IRRX/IRTX* when using an internal IR module connected to the IR header. Set to *SINB/SOUTB*. when connecting an IR adapter to COMB.

OnBoard Parallel Port

This field specifies the base I/O port address of the onboard parallel port. Selecting *Auto* allows AMIBIOS to automatically determine the correct base I/O port address. Settings: *Auto, 378, 278, 3BC, Disabled*.

Parallel Port Mode

This item selects the operation mode for the onboard parallel port: *ECP, Normal, Bi-Dir* or *EPP*.

EPP Version

The item selects the EPP version used by the parallel port if the port is set to *EPP* mode. Settings: *1.7, 1.9*.

Parallel Port IRQ

When *OnBoard Parallel Port* is set to *Auto*, the item shows *Auto* indicating that BIOS determines the IRQ for the parallel port automatically.

Parallel Port DMA

This feature needs to be configured only when *Parallel Port Mode* is set to the *ECP* mode. When Parallel Port is set to *Auto*, the field will show *Auto* indicating that BIOS automatically determines the DMA channel for the parallel port.

OnBoard Midi Port

The field specifies the base I/O port address for the onboard Midi Port.

Midi IRQ Select

The item is used to select the IRQ line for onboard Midi port.

OnBoard Game Port

This item is used to specify the address for the onboard game port.

OnBoardIDE

This setting controls the onboard IDE controller. Setting options: *Disabled, Primary, Secondary, Both*.

Chapter 3

OnBoard ATA133 RAID (Optional)

This setting controls the onboard RAID controller. The field appears only when your mainboard supports IDE RAID function. Setting options: *Disabled, Enabled*.

AC'97 Audio

The item is used to enable or disable the onboard AC'97 (Audio Codec'97) controller. Disable the controller if you want to use other controller cards to connect an audio device. Settings: *Enabled, Disabled*.

MC'97Modem

Auto allows the mainboard to detect whether a modem is used. If a modem is detected, the onboard MC'97 (Modem Codec'97) controller will be enabled; if not, it is disabled. Disable the controller if you want to use other controller cards to connect a modem. Settings: *Auto, Enabled, Disabled*.

USB Controller

This setting is used to enable/disable the onboard USB ports. Setting options: *2 Ports, 4 Ports, 6 Ports*.

USB Legacy Support

Set to *All Device* if you need to use any USB device in the operating system that does not support or have any USB driver installed, such as DOS and SCO Unix. Set to *No Mice* only if you want to use any USB device other than the USB mouse.

Port 64/60 Emulation

This field controls the USB Port 64/60 Emulation function. When the function is enabled, the USB keyboard is allowed to type some special combination keys.

PC Health Status

This section shows the status of your CPU, fan, overall system status, etc. Monitor function is available only if there is hardware monitoring mechanism onboard.

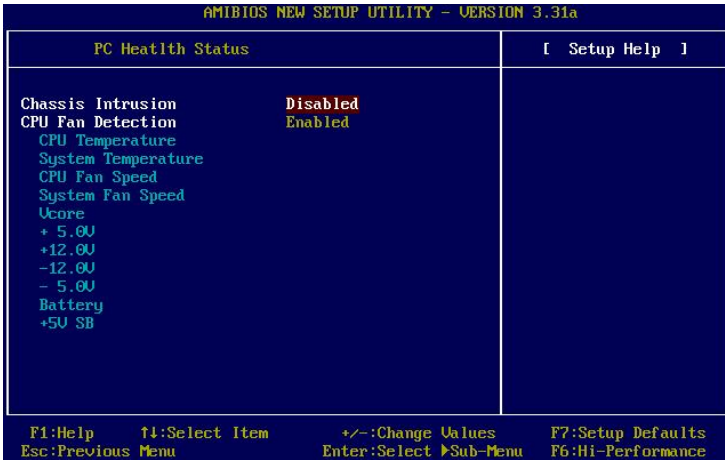

Chassis Intrusion

The field enables or disables the feature of recording the chassis intrusion status and issuing a warning message if the chassis is once opened. To clear the warning message, set the field to *Reset*. The setting of the field will automatically return to *Enabled* later. Settings: *Enabled, Reset, Disabled*.

CPU Fan Detection

When enabled, the system will automatically monitor the CPU fan during boot-up. If it detects that the CPU fan is not rotating, the system will show an error message on the screen and halt the boot-up process. **The function is built with CPU fan power connector (CFAN1) only** and enables you to protect the CPU from possible overheating problem. If you don't connect the CPU fan to the CPU fan power connector, we recommend disabling the feature. Settings: *Enabled, Disabled*.

CPU/System Temperature, CPU/System Fan Speed, Vcore, +5.0V, +12.0V, -12.0V, -5.0V, Battery, +5V SB

These items display the current status of all of the monitored hardware devices/components such as CPU voltages, temperatures and all fans' speeds.

Frequency/Voltage Control

Use this menu to specify your settings for frequency/voltage control.

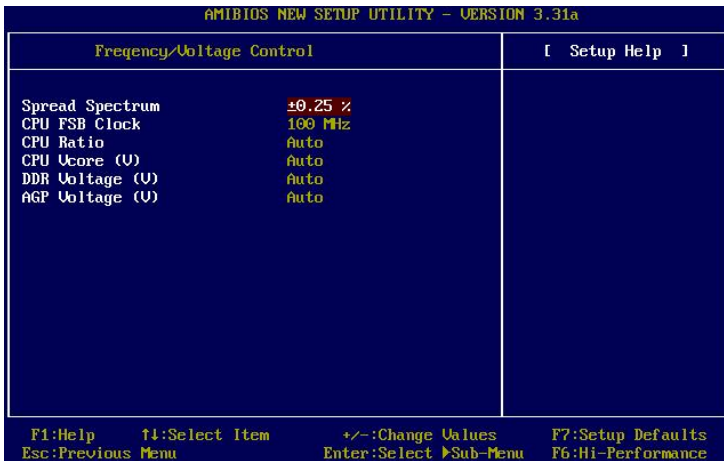

Spread Spectrum

When the motherboard's clock generator pulses, the extreme values (spikes) of the pulses creates EMI (Electromagnetic Interference). The Spread Spectrum function reduces the EMI generated by modulating the pulses so that the spikes of the pulses are reduced to flatter curves. If you do not have any EMI problem, leave the setting at *Disabled* for optimal system stability and performance. But if you are plagued by EMI, setting to *Enabled* for EMI reduction. Remember to disable Spread Spectrum if you are overclocking because even a slight jitter can introduce a temporary boost in clockspeed which may just cause your overclocked processor to lock up.

CPU FSB Clock

This item allows you to select the CPU Front Side Bus clock frequency (in MHz). Setting options range from 100 to 220. If you install a CPU other than 100MHz FSB, you should change the setting to corresponding FSB frequency; otherwise, the CPU will run at the default configuration 100MHz. The field allows you to overclock the processor by adjusting the FSB clock to a higher frequency.

CPU Ratio/Vcore (V)

The items are used to adjust the CPU clock multiplier (ratio) and CPU core voltage (Vcore). These fields provide users a tool to overclock the system.



*Warning: Changing CPU Ratio/Vcore could result in the instability of the system; therefore, it is **NOT** recommended to change the default setting for long-term usage.*

DDR Voltage (V)

Adjusting the DDR voltage can increase the DDR speed. Any changes made to this setting may cause a stability issue, so ***changing the DDR voltage for long-term purpose is NOT recommended.***

AGP Voltage (V)

AGP voltage is adjustable in the field, allowing you to increase the performance of your AGP display card when overclocking, but the stability may be affected.

Set Supervisor/User Password

When you select this function, a message as below will appear on the screen:



Type the password, up to six characters in length, and press <Enter>. The password typed now will replace any previously set password from CMOS memory. You will be prompted to confirm the password. Retype the password and press <Enter>. You may also press <Esc> to abort the selection and not enter a password.

To clear a set password, just press <Enter> when you are prompted to enter the password. A message will show up confirming the password will be disabled. Once the password is disabled, the system will boot and you can enter Setup without entering any password.

When a password has been set, you will be prompted to enter it every time you try to enter Setup. This prevents an unauthorized person from changing any part of your system configuration.

Additionally, when a password is enabled, you can also have AMIBIOS to request a password each time the system is booted. This would prevent unauthorized use of your computer. The setting to determine when the password prompt is required is the PASSWORD CHECK option of the ADVANCED BIOS FEATURES menu. If the PASSWORD CHECK option is set to *Always*, the password is required both at boot and at entry to Setup. If set to *Setup*, password prompt only occurs when you try to enter Setup.



About Supervisor Password & User Password:

Supervisor password: Can enter and change the settings of the setup menu.

User password: Can only enter but do not have the right to change the settings of the setup menu.

Load High Performance/BIOS Setup Defaults

The two options on the main menu allow users to restore all of the BIOS settings to High Performance defaults or BIOS Setup defaults. The High Performance Defaults are the values set by the mainboard manufacturer for the best system performance but probably will cause a stability issue. The BIOS Setup Defaults are the default values also set by the mainboard manufacturer for stable performance of the mainboard.

When you select Load High Performance Defaults, a message as below appears:

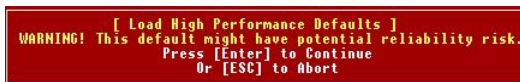

Pressing ‘Enter’ loads the default BIOS values that enable the best system performance but may lead to a stability issue.



The option is for power or overclocking users only. Use of high performance defaults will tighten most timings to increase the system performance. Therefore, a high-end system configuration is a must, which means you need high-quality VGA adapter, RAM and so on. We don't recommend that users should apply the high performance defaults in their regular systems. Otherwise, the system may become unstable or even crash. If the system crashes or hangs after enabling the feature, please CLEAR CMOS DATA to resolve the problem. For more information, refer to "Clear CMOS Jumper:JBAT1" in Chapter 2.

When you select Load BIOS Setup Defaults, a message as below appears:

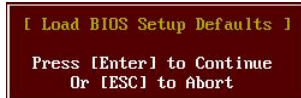

Pressing ‘Enter’ loads the default values that are factory settings for stable system performance.

Appendix: Using 4- or 6-Channel Audio Function

The motherboard comes with Realtek ALC650 chip, which provides support for 6-channel audio output, including 2 Front, 2 Rear, 1 Center and 1 Subwoofer channel. ALC650 allows the board to attach 4 or 6 speakers for better surround sound effect. The section will tell you how to install and use 4-/6-channel audio function on the board.

TOPICS

<i>Installing the Audio Driver</i>	<i>A-2</i>
<i>Using 4-/6-Channel Audio Function</i>	<i>A-4</i>
<i>Testing the Connected Speakers</i>	<i>A-11</i>
<i>Playing KaraOK</i>	<i>A-12</i>

Installing the Audio Driver

You need to install the driver for Realtek ALC650 chip to function properly before you can get access to 4-/6-channel audio operations. Follow the procedures described below to install the drivers for different operating systems.

Installation for Windows 98SE/ME/2000/XP

For Windows® 2000, you must install Windows® 2000 Service Pack2 or later before installing the driver.

The following illustrations are based on Windows® XP environment and could look slightly different if you install the drivers in different operating systems.

1. Insert the companion CD into the CD-ROM drive. The setup screen will automatically appear.
2. Click **Avance ALC650 Sound Drivers**.

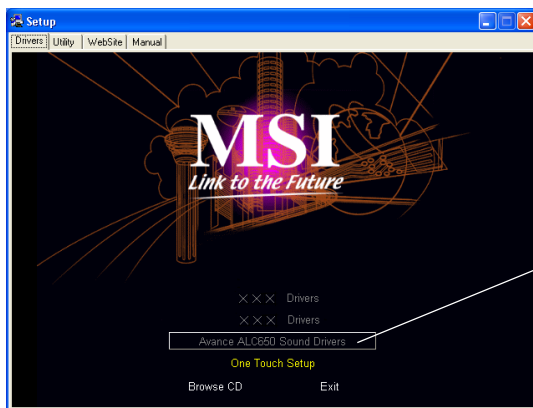

3. Click **Next** to start installing files into the system.

Using 4- or 6-Channel Audio Function

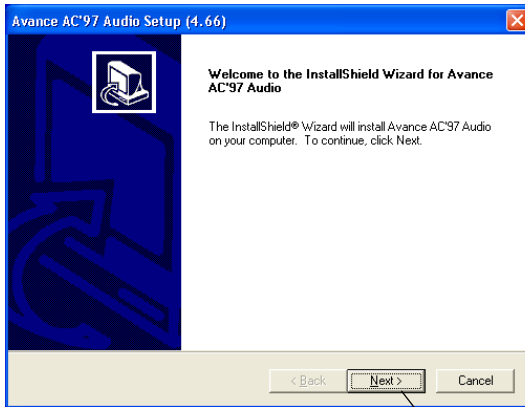

Click here

4. Click **Finish** to restart the system.

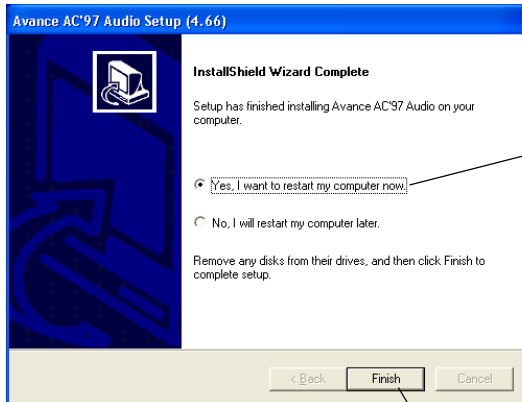

Select this option

Click here

Using 4- or 6-Channel Audio Function

After installing the audio driver, you are able to use the 4-/6-channel audio feature now. To enable 4- or 6-channel audio operation, first connect 4 or 6 speakers to the appropriate audio connectors, and then select 4- or 6-channel audio setting in the software utility.

There are two ways to utilize the function and connect the speakers to your computer:

- *Use the optional S-Bracket.* If your motherboard supports S-Bracket and you have installed S-Bracket in the computer, you can connect two speakers to back panel's Line-Out connector, and the rest of speakers to S-Bracket.
- *Use the back panel only.* If you do not have a S-Bracket, you can connect all speakers to the audio connectors on the back panel.

Attaching Speakers

To perform multichannel audio operation, connect multiple speakers to the system. You should connect the same number of speakers as the audio channels you will select in the software utility.



Note:

If the Center and Subwoofer speaker exchange their audio channels when you play video or music on the computer, a converter may be required to exchange center and subwoofer audio signals. You can purchase the converter from a speaker store .

Using S-BRACKET connectors:

S-Bracket is an optional accessory. It gives access to analog and digital audio output by integrating both SPDIF (Sony & Philips Digital Interface) and analog LINE OUT connectors. To use the S-Bracket, you should select correct setting in the software utility. For information about the setting, refer to *Selecting 4- or 6-Channel Setting* later in the section.

Connector configurations for 2-, 4- and 6-channel using S-Bracket are described below:

2-Channel Analog Audio Output

We recommend that you should still attach the speakers to BACK PANEL's Line Out connector during 2-channel audio mode even though S-Bracket's Line Out connectors function properly.

- 1 Line Out (*Front channels*)
- 2 Line In
- 3 MIC

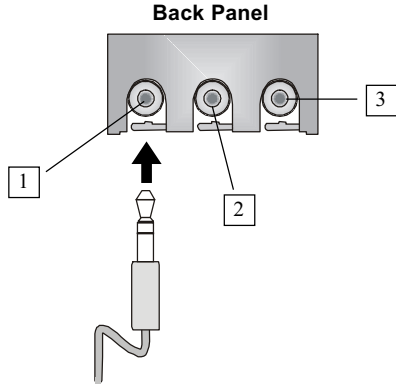

4-Channel Analog Audio Output

- 1 Line Out (*Front channels*)
- 2 Line In
- 3 MIC
- 4 Optical SPDIF jack
- 5 Coaxial SPDIF jack
- 6 Line Out (*Center and Subwoofer channel*)
- 7 Line Out (*Rear channels*)

Description:
Connect two speakers to back panel's Line Out connector and two speakers to one Line Out connector of S-Bracket.

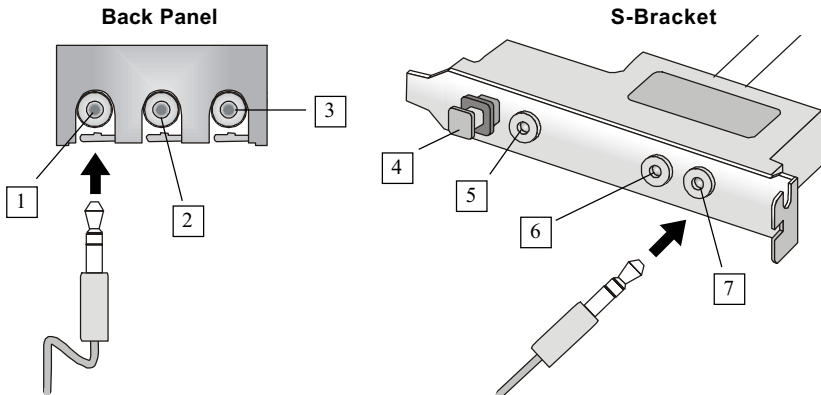

6-Channel Analog Audio Output

- 1 Line Out (*Front channels*)
- 2 Line In
- 3 MIC
- 4 Optical SPDIF jack
- 5 Coaxial SPDIF jack
- 6 Line Out (*Center and Subwoofer channel*)
- 7 Line Out (*Rear channels*)

Description:

Connect two speakers to back panel's Line Out connector and four speakers to both Line Out connectors of S-Bracket.

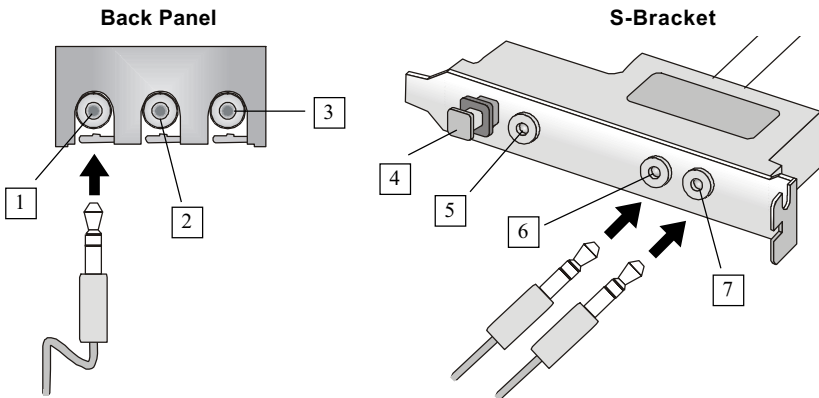

Digital Audio Output (2-Channel only)

For digital audio output, use the SPDIF (Sony & Philips Digital Interface) connectors supplied by *S-Bracket*. First, connect the SPDIF speakers to the appropriate SPDIF jack, and then select the audio channel you desire through the control panel of speakers. The SPDIF connectors support 2-channel audio operation only.

S-Bracket offers two types of SPDIF jacks: one for fiber-optic cable and the other for coaxial cable. Select the connector according to the type of your SPDIF speakers.

Using 4- or 6-Channel Audio Function

- 1 Optical SPDIF jack
- 2 Coaxial SPDIF jack
- 3 Line Out
- 4 Line Out

Description:

Select the correct type of SPDIF jack to connect SPDIF speakers. For optical connection, remove the plug from the S-Bracket before inserting the fiber-optic cable to it.

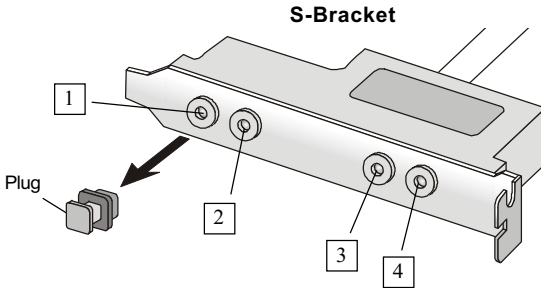

Using BACK PANEL connectors only:

The audio connectors on the back panel already provide 2-channel analog audio output function. The back panel's audio connectors can be transformed to 4-/6-channel analog audio connectors automatically when you select correct setting in the software utility. For information about the setting, refer to *Selecting 4- or 6-Channel Setting* later in the section.

Make sure all speakers are connected to *Line Out* connectors. Diverse connector configurations for 2-, 4- and 6-channel using back panel connectors are described below:

2-Channel Analog Audio Output

- 1 Line Out (*Front channels*)
- 2 Line In
- 3 MIC

Description:

Line Out, Line In and MIC functions all exist under 2-channel configuration.

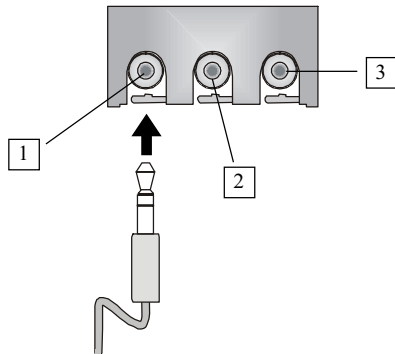

4-Channel Analog Audio Output

- 1 Line Out (*Front channels*)
- 2 Line Out (*Rear channels*)
- 3 MIC

Description:
Line In is converted to Line Out function under 4-channel configuration.

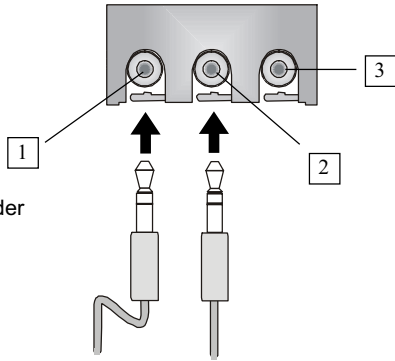

6-Channel Analog Audio Output

- 1 Line Out (*Front channels*)
- 2 Line Out (*Rear channels*)
- 3 Line Out (*Center and Subwoofer channel*)

Description:
Both Line In and MIC are converted to Line Out function under 6-channel configuration.

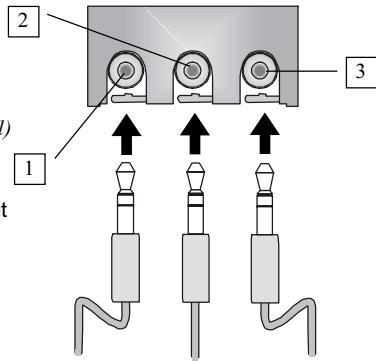

Selecting 4- or 6-Channel Setting

1. Click the audio icon  from the window tray at the bottom of the screen.
2. Select any surround sound effect you prefer from the “Environment” pull-down menu under the **Sound Effect** tab.

Click here and the pull-down menu will appear

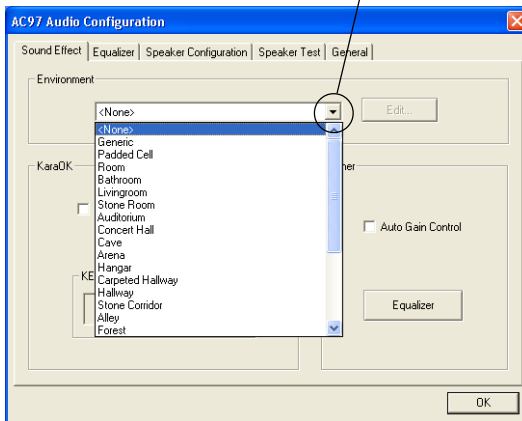

2. Click the **Speaker Configuration** tab.

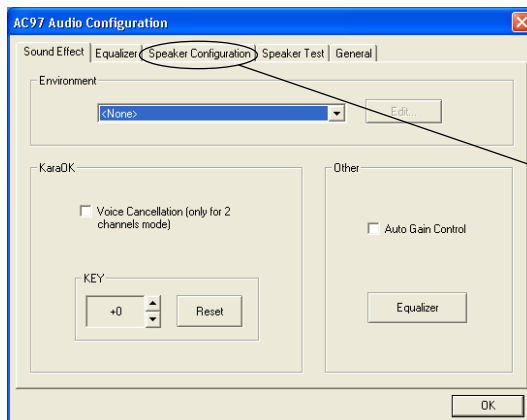

Click here

3. The following window appears.

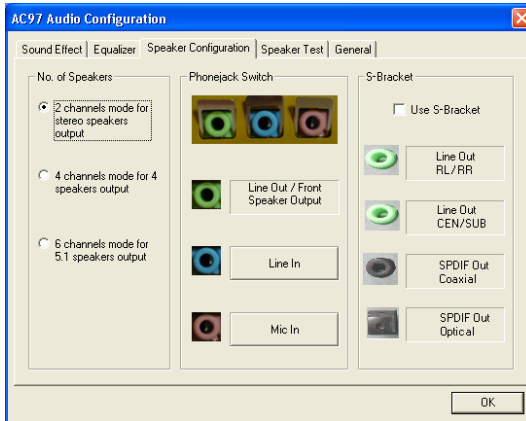

4. Select the multi-channel operation you prefer from **No. of Speakers**.
5. Select the audio device that you wish to use as audio output connectors. There are two options for this:

Use S-Bracket Make sure **Use S-Bracket** is NOT selected if you want to use audio connectors on the back panel only.

 Refer to “Using **BACK PANEL** connectors only” earlier in the section for how to attach speakers.

Use S-Bracket Select **Use S-Bracket** if you want to use audio connectors supplied by the connected S-Bracket.

 Refer to “Using **S-BRACKET** connectors” earlier in the section for how to attach speakers.

6. Click **OK**.



Note:

It is useless to select “Use S-Bracket” if your motherboard does not support or have the S-Bracket installed in the system.

Testing the Connected Speakers

To ensure 4- or 6-channel audio operation works properly, you may need to test each connected speaker to make sure every speaker work properly. If any speaker fails to sound, then check whether the cable is inserted firmly to the connector or replace the bad speakers with good ones.

Testing Each Speaker:

1. Click the audio icon  from the window tray at the bottom of the screen.
2. Click the **Speaker Test** tab.
3. The following window appears.

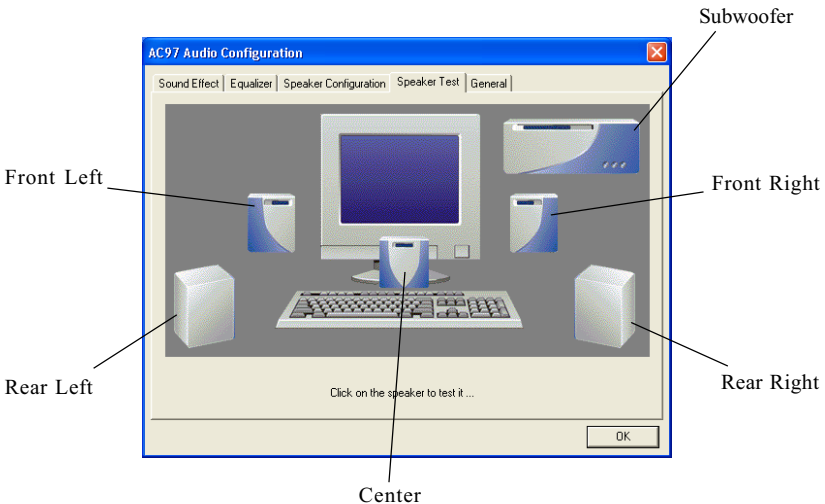

4. Select the speaker which you want to test by clicking on it.



Note:

6 speakers appear on the "Speaker Test" window only when you select "6 channels mode" in the "No. of Speakers" column. If you select "4 channels mode", only 4 speakers appear on the window.

Playing KaraOK

The KaraOK function will automatically remove human voice (lyrics) and leave melody for you to sing the song. **The function is applied only for 2-channel audio operation**, so make sure “2 channels mode” is selected in the “No. of Speakers” column before playing KaraOK.

Playing KaraOK:

1. Click the audio icon  from the window tray at the bottom of the screen.
2. Make sure the **Sound Effect** tab is selected.
3. Select **Voice Cancellation** in the “KaraOK” column.

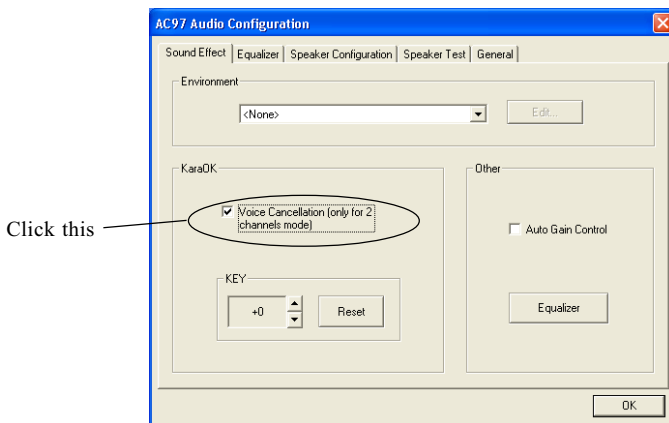

3. Click **OK**.

Glossary

ACPI (*Advanced Configuration & Power Interface*)

This power management specification enables the OS (operating system) to control the amount of power given to each device attached to the computer. Windows 98/98SE, Windows 2000 and Windows ME can fully support ACPI to allow users managing the system power flexibly.

AGP (*Accelerated Graphics Port*)

A new, high-speed graphics interface that based on PCI construction and designed especially for the throughput demands of 3-D graphics. AGP provides a direct channel (32-bit wide bus) between the display controller and main memory for high graphics quality and performance.

ATX

A modern shape and layout of mainboard that supersedes the widely-used Baby AT form factor. It improves many placement of components and makes a more efficient design.

BIOS (*basic input/output system*)

On PCs, an essential software that contains all the control code of input/output interface (such as keyboard, disk drives, etc.). It executes hardware test on booting the system, starts the OS, and provides an interface between the OS and the components. The BIOS is stored in a ROM chip.

Bus

A set of hardware lines within the computer system, through which the data is transferred among different components. In a PC, the term **bus** usually refers to a local bus that connects the internal components to the CPU and main memory.

Cache

A special memory subsystem that is used to speed up the data transfer. It stores the contents of frequently accessed RAM locations and the addresses where these data items are stored.

Chipset

A collection of integrated chips designed to perform one or more related functions. For

Glossary

example, a modem chipset contains all the primary circuits for transmitting and receiving data; a PC chipset provides the electronic interfaces between all subsystems.

CMOS (*complementary metal-oxide semiconductor*)

CMOS is a widely used type of semiconductor, which features high speed and low power consumption. PCs usually contain a small amount of battery-powered CMOS memory to retain the date, time, and system setup parameters.

COM

In MS-DOS system, the name of a serial communications port. DOS supports four serial ports. For example, if a modem is connected to one serial port and a serial mouse to another, they are identified as COM1 and COM2.

DIMM (*dual in-line memory module*)

A small circuit board that holds memory chips. A *SIMM* (*single in-line memory module*) has a 32-bit path to the memory chips whereas a DIMM has 64-bit path.

DRAM (*Dynamic RAM*)

A most common type of computer memory. It usually uses one transistor and a capacitor to represent a bit. As the development of technology, the memory type and specification used in computer becomes variety, such as SDRAM, DDR SDRAM, and RDRAM. For further instruction, please see the table below:

Dynamic RAM (DRAM) Memory Technologies					
Type	First Used	Clock Rate	Bus* Width	Peak Bandwidth	Volts
FPM (60,70ns)	1990	25MHz	64 bits	200 MBps	5v
EDO (50,60,70ns)	1994	40MHz	64 bits	320 MBps	5v
SDRAM (66MHz)	1996	66MHz	64 bits	528 MBps	3.3v
SDRAM (100MHz)	1998	100MHz	64 bits	800 MBps	3.3v
SDRAM (133MHz)	1999	133MHz	64 bits	1.1 GBps	3.3v
RDRAM (Direct Rambus)	1999	400MHz	16 bits	1.6 GBps	2.5v
DDR SDRAM (100MHz)	2000	100MHz	64 bits	1.6 GBps	2.5v
DDR SDRAM (133MHz)	2000	133MHz	64 bits	2.1 GBps	2.5v

* Memory channel width (64 bits started with 75MHz Pentium)

Source: *Computer Desktop Encyclopedia*

ECC Memory (*error correcting code memory*)

A type of memory that contains special circuitry for testing the accuracy of data and correcting the errors on the fly.

IDE (*Integrated Drive Electronics*)

A type of disk-drive interface widely used to connect hard disks, CD-ROMs and tape drives to a PC, in which the controller electronics is integrated into the drive itself, eliminating the need for a separate adapter card. The IDE interface is known as the ATA (AT Attachment) specification.

IEEE 1394

A new, high speed external bus standard, also known as *FireWire* or *iLink*, which supports data transfer rates of up to 400 Mbps for connecting up to 63 external devices.

IrDA (*Infrared Data Association*)

A group of device vendors, including computer, component and telecommunications, who have developed a standard for transmitting data via infrared light waves. This enables you to transfer data from one device to another without any cables.

LAN (*local area network*)

A computer network that covers a relatively smaller area, such as in a building or an enterprise. It is made up of servers, workstations, shared resources, a network operating system and a communications link. These individual PCs and devices on a LAN are known as “nodes”, and are connected by cables to access data and devices anywhere on the LAN, so that many users can share expensive devices and data.

LED (*light emitting diode*)

A semiconductor device that converts electrical energy into light. Since it lights up (usually red) when electricity is passed through it, it is usually used for the activity lights on computer’s component, such as disk drivers.

LPT (*line printer terminal*)

Logical device name for a line printer; a name reserved by the MS-DOS for up to three parallel printer ports: LPT1, LPT2, and LPT3. It is frequently used by the OS to identify a printer.

Glossary

PCI (*Peripheral Component Interconnect*)

A local bus standard developed by Intel that first appeared on PCs in late 1993. PCI provides “plug and play” capability and allows IRQs to be shared. The PCI controller can exchange data with the system's CPU either 32 bits or 64 bits at a time.

PnP (*Plug and Play*)

A set of specifications that allows a PC to configure itself automatically to work with peripherals. The user can “plug” in a peripheral device and “play” it without configuring the system manually. To implement this useful feature, both the BIOS that supports PnP and a PnP expansion card are required.

POST (*Power On Self Test*)

During booting up your system, the BIOS executes a series of diagnostic tests, include checking the RAM, the keyboard, the disk drives, etc., to see if they are properly connected and operating.

PS/2 Port

A type of port developed by IBM for connecting a mouse or keyboard to a PC. The PS/2 port supports a mini DIN plug containing just 6 pins. Most modern PCs equipped with PS/2 ports so that the special port can be used by another device, such as a modem.

USB (*universal serial bus*)

A hardware interface for low-speed peripherals such as the keyboard, mouse, joystick, etc. USB provides a maximum bandwidth of 12 Mbit/sec (Mbps) for connecting up to 127 peripheral devices to PC. USB features hot swap capability and multiple data streams, allows external devices to be plugged in and unplugged without turning the system off.

Virus

A program or a piece of code that infects computer files by inserting in those files copies of itself. The virus code is buried within an existing program, and is activated when that program is executed. All the viruses are man-made, and often have damaging side effects.