

CONTENTS

COMPONENT LOCATION DIAGRAM.....	A
CHECK LIST OF THE PACKAGING.....	B
CONNECTORS DESCRIPTION	C
TABLE OF CONTENTS.....	1
HOW TO USE THIS MANUAL.....	2
CHAPTER 1 Introduction.....	3
1-1 System Features	3
German.....	4
French	5
Spanish.....	6
Italian.....	7
1-2 Software Power Off Control.....	9
1-3 Fan Off Control.....	9
1-4 Running 100MHz CPU Bus (JP11).....	10
1-5 Keyboard & PS/2 Mouse Power On (JP9).....	11
1-6 Wake-On-LAN	12
1-7 Thermister (optional).....	12
1-8 LDCM (LANDesk Client Manager, optional).....	13
CHAPTER 2 Installation.....	14
2-1 Installation Procedure	14
2-2 CPU Installation.....	14
2-2-1 Core/Bus Freq. Ratio.....	14
2-2-2 CPU Setting.....	15
2-3 System Memory Installation	16
2-4 IDE Driver Installation.....	17
2-5 Sound Driver Installation.....	17
2-6 VGA Driver Installation.....	18
2-7 Hardware Doctor Installation.....	18
CHAPTER 3 Award BIOS Setup.....	19
3-1 Update BIOS Procedure	20
3-1-2 Update Microcode API.....	21
3-2 Award System BIOS Configuration Setup	22
Appendix A How to Install Pentium[®] II/III Celeron[®] and Processors with SECC2 Package	
Appendix B How to Setup Thermister (optional)	

Appendix C Technical Support Request Form**HOW TO USE THIS MANUAL**

This manual is written in a user-friendly style. It would be advisable for users to read it in an orderly sequence :

1. For Hardware Information:

Read **Page A: COMPONENT LOCATION DIAGRAM**, **Page B: CHECK LIST OF THE PACKAGING** and **Page C: CONNECTORS DESCRIPTION**.

2. For Mainboard and System Features:

Read “**Chapter 1 Introduction**” in detail, and you will find helpful information on mainboard and system features. Especially, when you want to do some feature setup, detailed instructions are provided therein to help you through.

3. For CPU, Memory and Drivers Installation:

Read “**Chapter 2 Installation**” for your CPU, memory and application drivers installation. Detailed instructions are provided to guide all kinds of users.

4. For BIOS Update and Setup:

Read “**Chapter 3 Award BIOS Setup**” for updating your mainboard BIOS and setting up your BIOS Configuration.

5. For Installing Pentium[®] II/III, Celeron or Processors with SECC2 Package:

Read **APPENDIX A** for setting up Intel Pentium[®] III, Pentium[®] II, Celeron[™], or processors with SECC2 package.

6. For Installing Thermister:

Read **APPENDIX B** for thermister installation. You will find that the self-explanatory drawings enclosed therein make the job easy and simple.

7. For other Technical Support:

Read **APPENDIX C**, fill and send the Request Form to your dealer for other technical support.

It is often heard that the default setting on a mainboard is not what user expects. A user-friendly manual would be the handiest assistant to help change the on-board configuration or default setting. In case this manual cannot solve all your problems, please ask your dealer for help and be sure the warranty on your system is still valid.

REMARK: Intel[®] is a registered trademark of Intel Corporation.

All other brands and product names are registered trademarks of their respective companies.

CHAPTER 1 INTRODUCTION

Welcome to utilize 6254M mainboard, the Intel 440BX chipset supporting both 66MHz and 100MHz Front Side Bus Pentium®II/III CPU. It also has the built-in Yamaha YMF 724/740 3D PCI sound chip and Voodoo3 VGA chip. The Yamaha YMF 724/740 sound chip is using PCI interface which allows your computer to perform 3D stereo sound. And the Voodoo3 3D VGA chip working with AGP interface technique allows users to have 2D/3D display resolution without plug any of VGA cards.





















1-1 System Features

- ☐ CPU Slot supporting Intel Pentium®III CPU 450MHz to 550MHz, Pentium®II CPU 233MHz to 450MHz and Intel Celeron™ CPU 266MHz to 466MHz.
- ☐ Intel 440BX AGPset.
- ☐ Yamaha YMF 724/740 3D PCI Sound Chip.
- ☐ Onboard 3Dfx Voodoo3 with onboard 16MB SGRAM.
- ☐ Four 168-pin DIMM Sockets in four banks of 64-bit wide path up to 512MB SDRAM or 1GB registered SDRAM (with parity chip ECC support).
- ☐ Built-in Switching Voltage Regulator.(VRM 8.2 SPEC.)
- ☐ Auto-detect CPU core voltage range from 1.8V to 3.5V.
- ☐ Two 16-bit ISA slots and four PCI slots compliance with reversion 2.2 of the PCI Local Bus specification.
- ☐ Dual Master IDE connectors support Ultra DMA/33 (33MB/sec), up to four devices in two channels for connecting high capacity hard disk, CD-ROM, LS-120MB floppy drive, tape backup etc.
- ☐ Winbond 83977 high-speed Ultra Multi-I/O chipset.
- ☐ ATX Power Connector.
- ☐ USB (Universal Serial Bus) Connector supporting up to 127 peripheral devices.
- ☐ PS/2 Keyboard Connector and PS/2 Mouse Connector.
- ☐ Infrared Transfer (IrDA TX/RX) Connector.
- ☐ One FDD Port supporting two devices available for 1.2MB, 1.44MB and 2.88MB.
- ☐ Two 16550A fast UARTs compatible Serial Ports.
- ☐ One EPP/ECP mode Parallel Printer Port.
- ☐ Software Power Off Control; Modem Ring On; SB-Link; Keyboard & PS/2 Power On; Wake-On-LAN functions.
- ☐ Built-in Hardware Health Monitor chip. (optional)
- ☐ Intel LDCM software. (optional)
- ☐ ATX Form Factor; Hardware Dimension is 305mm x 210mm. (12" x 8.26")

1-1 Systemmerkmale (German)

- ☐ CPU Slot unterstützt Intel Pentium III CPU 450MHz zu 550MHz, Pentium II CPU 233MHz zu 450MHz und Intel Celeron CPU 266MHz zu 466MHz .
- ☐ Intel 440BX AGPset .
- ☐ YAMAHA YMF 724/740 dreidimensional PCI Sound Chip .
- ☐ An Board dreidimensional fx Voodoo3 mit 16MB SGRAM .
- ☐ Vier 168-pin DIMM Sockets in vier Banks für 64-bit Breit ausgedehnte Bahn hoch bis zu 512MB SDRAM oder 1GB registriert SDRAM (mit ECC Chip in Gleichheit unterstützt) .
- ☐ Built-in schaltet den Voltageregulator .(VRM 8.2 SPEC)
- ☐ Selbstnachweisend CPU Kernvoltage variiert zwischen 1.8V und 3.5V .
- ☐ Zwei 16-bit ISA Slots und vier PCI Slots sind Wünschen gemäß der Umkehrung 2.2 für PCI Lokalbus in Spezifizierung .
- ☐ Dual Master IDE Anschlußstück unterstützen Ultra DMA/33 (3MB/sec), hoch bis zu vier Vorrichtungen in zwei Kanälen , das Einsetzen der Hardscheibe ist in hoher Aufnahmefähigkeit, CD-Rom, LS-120MB Softwaredrive , Tapeserven etc.
- ☐ Winbond 83977 hohe-Tempi Ultra multi-I/O Chipset .
- ☐ ATX Power schließen sich an .
- ☐ USB (universale Seriennummer-Bus) Anschlußstück wird Randverrichtung hoch bis zu 127 untergestützt .
- ☐ PS/2 Keyboard Anschlußstück und PS/2 Mouse Anschlußstück .
- ☐ Übertragend(IrDA TX/RX) Anschlußstück .
- ☐ One FDD Schließloch unterstützt zwei verwendbare Vorrichtungen für 1.2MB , 1.44MB und 2.88MB.
- ☐ Zwei 16550A rapide UARTs vertragende Seriennummer der Schließlöchern .
- ☐ Ein EPP/ECP Model mit parallelem Printerschließloch .
- ☐ Abschalten zu Software ist kontrolliertbar ; Modem mit Signalklang ; SB-Anschließen ; Keyboard und PS/2 Einschalten ;
- ☐ Wake-On-LAN Funktion .
- ☐ Konstruktion -in Hardware mit gesundheitlichem Monitor Chip. (freigestellt)
- ☐ Intel LDCM Software .(freigestellt)
- ☐ ATX Form Faktor ; Hardware Dimension ist 305mm x 210mm. (12" x 8.26")

1-1 Caractéristiques du Système (French)

-  Socle CPU supportant un CPU d'Intel Pentium® III 450Mhz à 550Mhz, un CPU d'Intel Pentium® II 233Mhz à 450Mhz et un CPU d'Intel Celeron™ 266Mhz à 466Mhz.
-  Puce Intel 440BX AGP.
-  Puce sonore YMF 724/740 3D PCI de YAMAHA.
-  3 Dfx Voodoo3 Sur Carte avec 16MB de SGRAM Sur Carte.
-  Quatre Socles DIMM 168-broches dans quatre banques d'une piste de 64-bit sur 512MB de SDRAM ou 1GB de SDRAM enregistrée (avec support ECC de puce par paire).
-  Régulateur de voltage interchangeable incorporé (VRM 8.2 SPEC).
-  Gamme du voltage détecté par le CPU de 1,8V à 3,5V.
-  Deux socles ISA 16-bit et quatre socles PCI conformes avec l'inversion 2.2 des spécifications du Bus PCI Local.
-  Double connecteurs maîtres IDE avec support d'Ultra DMA/33 (33MB/sec.) sur quatre périphériques dans deux chaînes pour connecter un disque dur de grande capacité, un lecteur de CD-ROM, de disquette LS-120MB, une machine pour copie de secours, etc.
-  Jeu de puces Ultra Multi-I/O haute vitesse Winbond 83977.
-  Connecteur d'alimentation ATX.
-  Connecteur USB (Bus Sériel Universel) supportant plus de 127 périphériques.
-  Connecteur de clavier PS/2 et connecteur de souris PS/2.
-  Connecteur de transfert d'infrarouge (IrDA TX/RX).
-  Un port FDD supportant deux périphériques disponibles pour 1,2MB, 1,44MB et 2,88MB.
-  Deux ports sériels compatibles 16550A fast UARTs.
-  Un Port d'Imprimante Parallèle mode EPP/ECP.
-  Logiciel de contrôle d'arrêt; Sonnerie de modem; Lien SB; Clavier & PS/2 Marche; Fonctions LAN de Réveil.
-  Puce d'état du moniteur et du matériel (optionnelle).
-  Logiciel Intel LDCM (optionnel).
-  Facteur de Forme ATX; dimensions du matériel: 305mm x 210mm (12" x 8,26").

1-1 Características del Sistema (Spanish)

- ☐ Ranura CPU soporta Intel Pentium®III CPU 450Mhz a 550Mhz, Pentium®II CPU 233Mhz a 450Mhz e Intel Celeron™ CPU 266Mhz a 466Mhz.
- ☐ Intel 440BX AGPset.
- ☐ Chip de sonido Yamaha YMF 724/740 3D PCI
- ☐ 3Dfx Voodoo3 abordo con 16MB SGRAM abordo
- ☐ Cuatro Casquillos 168-pin DIMM en cuatro bancos de 64-bit camino ancho hasta 512MB SDRAM o 1GB registrado SDRAM (con soporte de chip de paridad ECC)
- ☐ Regulador de Voltaje Incorporado (VRM 8.2 SPEC.)
- ☐ Autodetección de rango de voltaje central de CUP de 1.8V a 3.5V
- ☐ Dos ranuras 16-bit ISA y cuatro ranuras PCI conforme a la reversión 2.2 de la especificación de PCI Local Bus
- ☐ Conectores IDE Master Duales soportan Ultra DMA/33 (33MB/seg.), hasta cuatro dispositivos en dos canales para conectar disco rígido de alta capacidad, CD-ROM, lector de floppy LS-120MB, respaldo de cinta, etc.
- ☐ Chipset Ultra Multi-I/O de alta velocidad Winbond 83977.
- ☐ Conector de alimentación ATX.
- ☐ Conector USB (Bus Serial Universal) que soporta hasta 127 dispositivos periféricos.
- ☐ Contector de Teclado PS/2 y Conector de Ratón PS/2.
- ☐ Conector de Transferencia Infrarroja (IrDA TX/RX).
- ☐ Un puerto FDD que soporta dos dispositivos disponibles para 1.2MB, 1.33MB y 2.88MB.
- ☐ Dos Puertos Seriales 16550A fast UARTs compatibles.
- ☐ Un Puerto de Impresora Paralelo en modalidad EPP/ECP.
- ☐ Control de Apagado en Software; Encendido de Módem; SB-Link; Teclado & Encendido PS/2; Despertar en LAN.
- ☐ Chip de Monitor de Salud de Hardware incorporado, (opcional)
- ☐ Software Intel LDCM, (opcional)
- ☐ Factor de Forma ATX; Dimensión de Hardware es 305mm x 210mm (12" x 8.26")

1-1 Caratteristiche del Sistema (Italian)

- ☐ La slot CPU supporta micro-processor Intel Pentium III Cpu da 450 Mhz a 550 Mhz, Pentium II CPU da 233 Mhz a 450 Mhz ed Intel Celeron CPU da 266 Mhz a 466 Mhz.
- ☐ Set Intel 440BX AGP.
- ☐ PCI Chip suono Yamaha YMF 724/740 3D.
- ☐ 3Dfx Voodoo3 caricato con 16MB SGRAM caricate.
- ☐ Quattro prese DIMM a 168 pin, a disposizione quadrupla, con 64 bit di ampiezza fino a 512MB SDRAM oppure 1GB registrato SDRAM (con chip parità supporto ECC).
- ☐ Regolatore Voltaggio Aggiustabile internamente costruito (VRM 8.2 SPEC.)
- ☐ Auto-lettura voltaggio interno CPU con ampiezza da 1.8V a 3.5V.
- ☐ Due prese ISA da 16-bit e quattro prese PCI conformi a reversione 2.2 della specifica di PC Local Bus.
- ☐ Connettori Dual Master IDE supportanti Ultra DMA/33 (33 MB/sec), fino a due dispositivi in due canali per la connessione di hard disk ad alta capacità, CD-ROM, floppy drive LS-120 MB, backup di nastro, ecc.
- ☐ Winbond 83977 alta velocità Ultra Multi-I/O chipset.
- ☐ Connettore di alimentazione ATX.
- ☐ Connettore USB (Universal Serial Bus = Bus Seriale Universale) in grado di supportare un massimo di a 127 dispositivi periferici.
- ☐ Connettore Tastiera PS/2 e Connettore Mouse PS/2.
- ☐ Connettore Transfer Infrarossi (IrDA TX/RX).
- ☐ Un porto FDD che supporta due dispositivi disponibile per 1.2MB, 1.44MB e 2.88MB.
- ☐ Due Porti Seriali compatibili con 16550A fast UARTs
- ☐ Un porto con mode EPP/ECP Stampante Parallela.
- ☐ Dispositivo controllo spegnimento software; accensione suono Modem; SB-Link; accensione tastiera e PS/2; funzioni Wake-On-LAN.
- ☐ Chip per controllo di condizione dell' Hardware (Hardware Health Control - opzionale).
- ☐ Software Intel LDCM (opzionale).
- ☐ Fattore Forma ATX; le dimensioni dell' hardware sono 305mm x 210mm (12" x 8.26").

Voodoo III – 2000/3000 Features

- ☞ Fully integrated 128-bit
- ☞ VGA/2D/3D/Video accelerator
- ☞ True Multi-texturing-2 textures/ clock
- ☞ 3Dfx Voodoo compatibility.
- ☞ 2X AGP with sidebands.
- ☞ DVD Acceleration.
- ☞ Digital video output for NTSC, PAL and SECAM TV-out support.
- ☞ Digital LCD support (LCDfx™)
- ☞ DirectX 6, Open GL, Glide 2.x/3.x support.
- ☞ 0.25 Micron, 5-layer metal CMOS technology.
- ☞ 2000: 4 million triangles/sec., 250 Megatexels/sec.
3000: >7 million triangles/sec., > 366 Megatexels/sec.
- ☞ 2000: 300MHz RAMDAC, 2048x1536@65Hz.
3000: 350MHz RAMDAC, 2048x1536@75Hz.
- ☞ 2000: 125MHz Core Graphics Clock
3000: 183MHz Core Graphics Clock

Audio Features

- ☞ True Full Duplex Playback and Capture with different Sampling Rate
- ☞ Maximum 32-voice XG capital Wavetable
- ☞ Synthesizer including GM compatibility
- ☞ DirectSound Hardware Acceleration
- ☞ DirectMusic Hardware Acceleration
- ☞ Downloadable Sound (DLS) level-1
- ☞ Genuine OPL3
- ☞ Hardware Sound Blaster Pro compatibility
- ☞ Joystick
- ☞ Supporting PC/PCI and Distributed DMA for legacy DMAC (8237) emulation
- ☞ Supporting Serialized IRQ
- ☞ Supporting AC-2 Interface (AC-Link)
- ☞ Single Crystal operation (24.576MHz)
- ☞ 5V Power supply for I/O; 3.3V Power supply for Internal core logic

1-2 Software Power Off Control

The mainboard design supports Software Power Off Control feature through the SMM code in the BIOS under Windows 95/98, and MS-DOS operation system environment.

First, you should connect the power switch cable to the connector “PS-ON” on the mainboard. In the BIOS screen of POWER MANAGEMENT SETUP’, choose “User Define” (or “Min. Power Saving” or “Max. Power Saving”) in ‘Power Manager’ and pick up “Yes” in ‘PM Control by APM’.

In Windows 95/98, if you would like to power off the system, you just need to choose “shutdown the computer ?” in the “Shut Down Windows“ from Windows 95/98. Then the system power will be off directly, and become to the stand-by status. If you would like to restart the system, just press the power switch button, and the system will be powered on.

Note : If you are going to leave your system idle for several days, we suggest you use hardware power off to shutdown your system.

Status	Power LED Light	Turbo LED Light
Software power off control	Blinking (JP5, pin1-2) Light off (JP5, pin2-3)	Light off
APM mode	Light on	Light on
System running	Light on	Light on

* Under Software power off control, the status of Power LED Light depends on the setting of JP5.

If you set JP5 to “pin1-2” position, it is blinking. Otherwise, it is light off.

1-3 Fan Off Control

With fan-off function, the CPU cooling fan can turn off automatically even when the system is in suspend mode. This function is able to reduce energy consumption and system noise.

Because it is a feature of advanced BIOS, you should set this option enabled through “Power Management Setup” from the BIOS setup screen.

1-4 Running 100 MHz CPU Bus (with JP11)

The mainboard provides **Jumper 11** that allows you to set your CPU host clock and perform CPU overclock function. There are two ways to set CPU host clock at 'closed' and 'open'. When setting 'closed', the system will automatically detect the CPU host clock, for instance 66MHz and 100MHz. Another way is to set **Jumper 11** at 'open' for 66MHz CPU overclock to 100MHz.

We recommend that users should use Intel Pentium® II/III 100 MHz CPU, running at 350, 400, 450 and 500MHz internal clock speed. Moreover, the SDRAM memory module must be 8 nano-second (Maximum Frequency 125 MHz) speed of memory –die or less. However, based on Intel's design, we don't recommend users to run over 100MHz CPU host bus.

Please note that the default setting of Jumper 11 is 'closed'.

Jumper 11	BASE CLK
Closed	Auto (default)
Open	Overclock (66MHz→100MHz)

(a) Pin Closed

(b) Pin Open

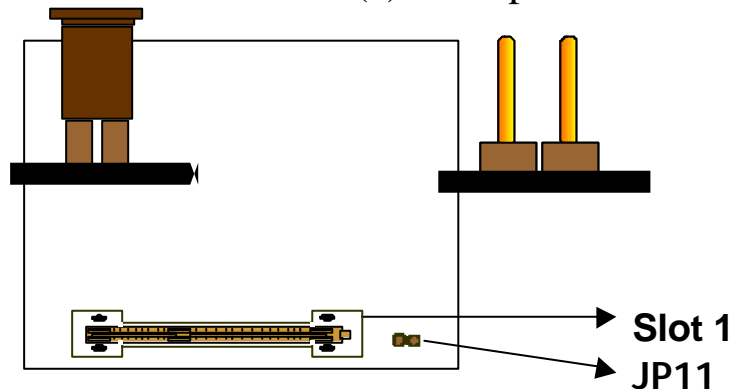

★ If you would like to run over 100MHz CPU host bus, like 112 and 124MHz, please set "CPU Clock Frequency" in "CHIPSET FEATURES SETUP" from the BIOS setup screen. If the system can't boot up with the clock frequency that you set to, you can clear the set frequency by pressing the 'Insert' key on keyboard. After restarting the system, you have the system operating at the default frequency.

1-5 Keyboard & PS/2 Mouse Power On (with JP9)

With ATX Power Supply and Jumper 9 set to Pin 1-2 closed, 6254M Mainboard is enabled to Keyboard & PS/2 Mouse Power On functions :

JP 9	KB & PS/2 Mouse Wakeup
1-2	Enable
2-3	Disable

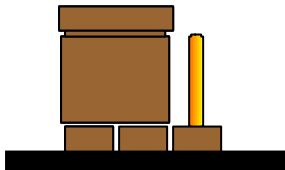

(a) Enable (1-2 closed)

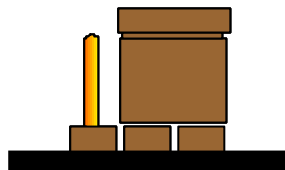

(b) Disable (2-3 closed)

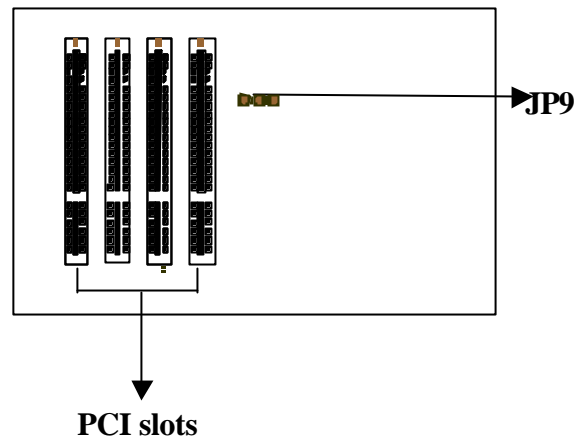

The default Power On function is “Button Only”. That means, we can only turn our computer on and off by pressing the “Power Button”. If we want to enable KB & PS/2 Mouse Power On function, we first have to set JP9 to Pin 1-2 closed, and then go to “Power On Function” in “Integrated Peripherals” of Award BIOS Setup. At the line “Power On Function”, we can press “Page Up” or Page Down” to make the following selections:

1. Password(via Keyboard):

When user selects “Password”, it will show “Enter Password:”. After user has typed the password, screen will show “ Confirm Password:” and user has to type the same password to confirm it. Save selection and shut down system. Now computer will only be powered on by entering correct password.

In case the set password is forgotten, carry out “Clear CMOS” (Page 14) to clear password, or computer can not be powered on.

2. Hot Key (via Keyboard):

When user selects this option, screen will show another line : “Hot Key Power ON : Ctrl-F1”. User can select from “Ctrl-F1” to “Ctrl-F12” as Hot Key by pressing PageUp / PageDown. After fixing Hot Key, save selection and shut down system. Now computer will only be powered on by pressing the correct Hot Key.

3. Mouse Left, Mouse Right (via PS/2 Mouse):

This function is available via PS/2 mouse only. User can select either “Mouse Left” or “Mouse Right” from the “Power On Function” line. After picking either option, save selection and shut down system. Now computer will only be powered on by double-clicking the correct PS/2 Mouse button.

Do not slide the mouse when you click; or you can't power on the system.

4. **Button Only (via Power Button):** “Button Only” is default setting, at which computer can only be on/off via Power Button.

1-6 Wake-On-LAN

The remote Wake-On-LAN (WOL) mode of operation is a mechanism that uses Advanced Micro Device Magic Packet technology to power on a sleeping workstation on the network. This mechanism is accomplished when the LAN card receives a specific packet of information, called a Magic Packet, addressed to the node on the network. For additional protection, Secure ON is an optional security feature that can be added to the Magic Packet that requires a password to power on the sleeping workstation. When LAN card is in remote Wake-On-LAN mode, main system power can be shut down leaving power only for the LAN card and auxiliary power recondition.

The LAN card performs no network activities while in the remote Wake-On-LAN mode of operation. It only monitors the network for receipt of a Magic Packet. If a Magic Packet is addressed to the LAN card on the network, the LAN card wake up the system. If the Secure ON feature has been enabled, the password added to the Magic Packet is also verified prior to waking up the system.

You should select two kinds of PCI Ethernet cards with WOL function. One is Intel and the other is with PME signal supporting. And you can set “Wake Up On LAN” this function enabled through “Power Management Setup” from the BIOS setup screen.

1-7 Thermister (optional)

If Hardware Monitor is built onboard, CPU temperature can be monitored by setting up the Thermister.

When setting up the thermister (refer to Appendix B), the BIOS will load the CPU temperature automatically. A warning beep sound will be sent out if the user set the option on. If the CPU is overheated, the user will get the warning. Then you should shut down computer and check your devices. Or contact you dealer for further help if CPU temperature persists.

Note: If you would like to enable the function of hardware monitor, to set up thermister beforehand is necessary. RT2 is the thermister connector.

1-8 LDCM LANDesk Client Manager (optional)

The mainboard built-in controller supports Intel LDCM. LDCM can satisfy users who want manageable systems that can interact automatically with the user. Client manager is the answer, enabling both administrators and clients to manage systems. The features of LDCM are as following :

View system inventory

Client Manager enables you to view hundreds of inventoried items. Some of these items are software related, while many others are hardware related.

View DMI-compliant component information

Client manager enables you to view component information that is compliant with the Desktop Manager Interface DMI . This means you can manage third-party DMI-compliant components which did not include Client manager.

Back up and restore system configuration files.

Client Manager enables you back up and restore system configuration files. Whenever you plan on changing the system configuration , you can make a backup set. If the system no longer works correctly, after you the change the system configuration , you can simply restore the system configuration with the backup set.

Troubleshoot

Since Client manager enables you to view the system inventory, you can easily troubleshoot system problems.

Receive notifications for system events

Client manager enables you to receive notification of certain system events. For example, if the system is running low on virtual memory, you are notified of the potential problem.

Transfer files to and from client workstations

As an administrator, you have the ability to transfer files to and from client workstation. This is helpful, for example, when you need to update a client workstation driver.

Remotely reboot client workstations

Administrator also have the ability to remotely reboot a workstation. This is helpful when you want your system configuration changes to take effect.

CHAPTER 2 INSTALLATION

2-1 INSTALLATION PROCEDURE

Before installing the computer, please prepare all components such as CPU, DRAM; peripherals such as hard disk, keyboard, CD-ROM and accessories such as cables. Then, install the system as following:

- ❶ Plug CPU/ heat sink (refer to Pentium® II/III & Celeron™ installation guide, **Appendix A**), and DRAM modules on the mainboard.
- ❷ Set DIP switch & jumpers based on your configuration.
- ❸ Plug add-on cards into PCI/ISA slots, if needed.
- ❹ Connect cables to peripheral devices, especially for power supply.
- ❺ Make sure all components and devices are well connected, turn on the power and setup System BIOS based on your configuration.
- ❻ Install peripheral devices, add-on card drivers and test them.
- ❼ If all of above procedures are running successfully, turn the power off and screw the chassis cover to the chassis, and then connect external devices which are cabled to the system.

2-2 CPU INSTALLATION

The mainboard has built-in VID (Voltage Identify) function to automatically detect CPU voltages. Thus you do not have to set the CPU voltage setting.

2-2-1 CPU Core/Bus Freq. Ratio :



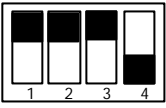
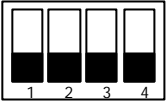
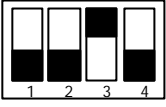
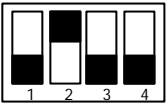
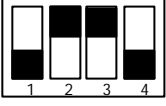
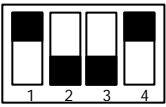
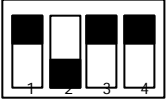
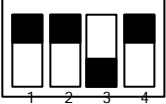

SW1	1-1	1-2	1-3	1-4
3.0x	ON	ON	OFF	OFF
3.5x	ON	ON	ON	OFF
4.0x	OFF	OFF	OFF	OFF
4.5x	OFF	OFF	ON	OFF
5.0x	OFF	ON	OFF	OFF
5.5x	OFF	ON	ON	OFF
6.0x	ON	OFF	OFF	ON
6.5x	ON	OFF	ON	ON
7.0x	ON	ON	OFF	ON
7.5x	ON	ON	ON	ON
8.0x	OFF	OFF	OFF	ON

2-2-2 CPU Setting

a. For 233~333MHz Intel Pentium[®] II & 266~466MHz Celeron[™] CPUs.

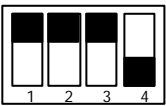
INTERNAL CPU CLOCK	SW1
233MHz (66x3.5)	ON  OFF
266MHz (66x4.0)	ON  OFF
300MHz (66x4.5)	ON  OFF
333MHz (66x5.0)	ON  OFF
366MHz (66x5.5)	ON  OFF
400MHz (66x6.0)	ON  OFF
433MHz (66x6.5)	ON  OFF
466MHz (66x7.0)	ON  OFF

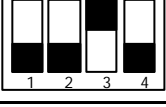
b. For 350~450MHz Intel Pentium[®] II and 450~550MHz Pentium[®] III CPUs.

INTERNAL CPU CLOCK	SW1
350MHz (100x3.5)	ON  OFF
400MHz (100x4.0)	ON  OFF
450MHz (100x4.5)	ON  OFF
500MHz (100x5.0)	ON  OFF
550MHz (100x5.5)	ON  OFF

2-3 SYSTEM MEMORY INSTALLATION

The Mainboard provides four 168-pin DIMM sockets for system memory expansion from 8MB to 512MB SDRAM, 1GB registered SDRAM or 1GB EDO DRAM. (EDO DRAM is available for 66MHz processors only.) These four DIMMs are arranged to four banks, please refer to page A.

Bank/DIMM	Memory Module	Total Memory
Bank0/DIMM1	8/16/32/64/128/256MB	8MB~256MB
Bank1/DIMM2	8/16/32/64/128/256MB	8MB~256MB
Bank2/DIMM3	8/16/32/64/128/256MB	8MB~256MB
Bank3/DIMM4	8/16/32/64/128/256MB	8MB~256MB
Total System Memory		8MB~1GB

DRAM type, size, parity supported:

- ⌚ EDO DRAM: for 66MHz system frequency only
- ⌚ Unbuffered, registered SDRAM with SPD
- ⌚ Both parity or non-parity are available.
- ⌚ 3.3V, Single/double-side, 8/16/32/64/128/256Mbytes
(Max. memory size: 256MB registered SDRAM or EDO DRAM)
- ⌚ Both 4Mbx4 and 16Mbx4 (Each side has 16 chips.) SDRAM devices are supported in the form of Registered DIMMs only.

◆ *For 66MHz host bus CPUs use 12ns or faster DIMM module;*

◆ *For 100MHz host bus CPUs use 10ns or faster and PC-100 compliant modules .*

⌚ SPD (Serial Presence Detect)

This EPROM contains speed and design information of the memory module. The mainboard may get optimal performance via accessing the data of SPD.

⌚ ECC (Error Check and Correction)

This mainboard can support the ECC function while utilizing parity modules. To enable this function, users must set “DRAM Data Integrity Mode” to “ECC” through “Chipset Features Setup” from the BIOS setup screen. All in all, ECC’s function is to detect and correct the errors of transfer data.

2-4 IDE DRIVER INSTALLATION

Setup for Windows 95/98 :

1. Start Windows 95/98.
2. Put the All-In-One CD into your CD-ROM drive.
3. Select “START”, “RUN”.
4. Type “D:\IDE\WIN95\SETUP.EXE” or “E:\IDE\WIN95\SETUP.EXE”.
(If your operating system is Win95, please type “D or E:\winp2x4.exe” before you install IDE driver.)
5. Restart the computer, then follow the instructions on your screen to install new IDE driver we offer in the All-In-One CD.
6. Exit Windows 95/98, turn power off; then turn power on.

2-5 YAMAHA SOUND DRIVER INSTALLATION

2-5-1 Installing Yamaha 724/740 PCI Driver for WinNT

Yamaha Sound 724/740 PCI Driver for WinNT is included in the Driver/Utility CD under the autorun main menu “**Install Yamaha 724/740 PCI Driver**”. To install this driver, just take the following steps:

1. Start WinNT 4.0 and insert the Driver/Utility CD into your CD-ROM Drive.
2. The screen will automatically show the autorun main menu which includes “Install Yamaha 724/740 PCI Driver”.
3. Click this item and “Yamaha DS-XG Setup” screen will display.
4. Click “Windows NT4.0 Driver” and driver setup will automatically start to run.
5. Follow the instructions on the autorun screen until setup is complete.
6. Restart your system to put the sound driver into effect.

2-5-2 Installing Yamaha 724/740 PCI Driver for Win95/98

1. Start your Win95/98 and insert the Driver/Utility CD into CD-ROM Drive.
2. The screen will automatically show the autorun main menu which includes “Install Yamaha 724/740 PCI Driver”.
3. Click this item and “Yamaha DS-XG Setup” screen will display.
4. Click “Windows 95/98 Driver” and driver setup will automatically start to run.
5. Follow the instructions on the autorun screen until setup is complete.
Restart your computer to put the sound driver into effect.

2-6 VOODOO III AGP DRIVER INSTALLATION

2-6-1 Installing Voodoo III AGP Driver for Win95/98

1. Start your Win95/98 and insert the Driver/Utility CD into CD-ROM Drive.
2. The screen will automatically show the autorun main menu which includes “Install Voodoo III AGP Driver”.
3. Click this item to begin installing the driver.
4. Click “Drivers Setup” and driver setup will automatically start to run.
5. Follow the instructions on the autorun screen until setup is complete.

2-6-2 Installing Voodoo III AGP Driver for WinNT

1. Start your WinNT and insert the Driver/Utility CD into CD-ROM Drive.
2. The screen will automatically show the autorun main menu which includes “Install Voodoo III AGP Driver”.
3. Click this item to begin installing.
4. Click “Drivers Setup” and driver setup will automatically start to run.
5. Follow the instructions on the autorun screen.
6. Choose 3Dfx Interactive Inc. Voodoo3 2000 or 3000 depends on your chipset type.
7. Follow the instructions on the autorun screen until setup is completed.

2-7 HARDWARE DOCTOR INSTALLATION

► Setup for Win95/98 or WinNT

1. Start Windows95/98 or WinNT.
2. Insert All-In-One CD into your CD-ROM drive.
3. Choose “Install Hardware Monitor” in the installation main menu.
4. Follow the instructions on the autorun screen until setup is completed.

Note: After finishing Hardware Doctor installation, in WinNT you must restart your computer, but in Win95/98 you don't have to.

CHAPTER 3 AWARD BIOS SETUP

Award BIOS manufacturer provides access to the system BIOS through the hardware and software on the mainboard. The hardware consists of a Flash ROM and the software is a group of programs that are installed in the ROMBIOS along with all the other data the BIOS must contain.

After the BIOS is updated, if you want to clear the old setup data stored in the CMOS, then you can clear CMOS.

NOTE : In case CMOS should be cleared, unplug the power cord, set Jumper 8 2-3 closed for at least 5 seconds, put it back to 1-2 position and plug the power cord again.

	JP8
Normal	1-2
Clear CMOS	2-3

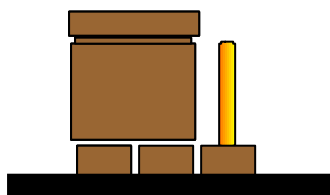

Normal (Pin 1-2 closed)

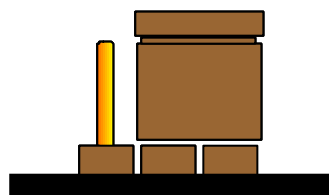

Clear CMOS (Pin 2-3 closed)

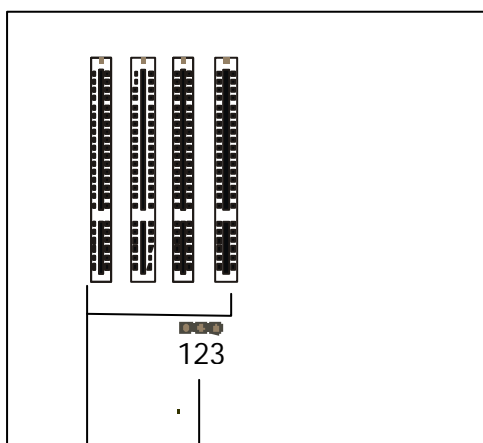

PCI Slots JP 8

3-1 UPDATE BIOS PROCEDURE

If the BIOS needs to be updated, you can get a CD with the updated BIOS utility in the package. The updated BIOS utility includes :

“awdf flash.exe” -- BIOS update utility program
“awdf flash.doc”

The update procedure is as following:

1. Boot the system to DOS mode in a normal manner.
2. Insert the updated CD to drive D (or E).
3. Change working directory to CD-ROM drive, D or E, which contains the update BIOS CD. -- Type “d:\” or “e: \”, then press “ENTER”.
4. Type “cd flash”, then press “ENTER”.
5. Type “awdf flash”, then press “ENTER”-- for running the BIOS update utility.
6. Type “(update BIOS file name with version number).bin”, ENTER.
7. If you do not want to save the old BIOS, type “N” when the screen displays the message : " Do you want to save BIOS (Y/N) ?".
8. Type “Y” when the screen shows the message : " Are you sure to program (Y/N) ?".
9. Follow instructions displayed on the screen. DO NOT remove the update BIOS CD from the CD-ROM drive nor turn the system power off until the BIOS update is completed.
10. Turn the power off. Clear the data in CMOS according to the procedure described in the previous page.
11. Turn the system power on and test that your system is working properly.

3-1-1 UPDATE MICROCODE API

Intel also provides MICROCODE API (Applications Programming Interface) for Pentium® II/III processor-based mainboard user to update data block in BIOS quickly and easily. (You can find this utility in the All-In-One CD in the mainboard package).

The BIOS code on the Pentium® II/III processor-based mainboards contains data that is specific to each silicon stepping of the processor. Integrators must ensure that this BIOS stepping data matches the used processor stepping. When the BIOS does not contain stepping data that matches the processor stepping, integrators must update the data in the BIOS before shipping the system. Historically, Pentium® II/III systems have been updated by replacing the entire BIOS with a new revision of BIOS that contains the correct stepping data.

Intel's BIOS update API allows just the stepping data within the BIOS to be updated as needed. Mainboards that contain a BIOS with the Intel-defined BIOS update API can be quickly and easily updated, if required, without obtaining a complete BIOS upgrade. Using this utility, integrators can easily verify that the correct stepping data is present in all Pentium® II/III processor-based mainboards. However, if the stepping data requires to be updated, the mainboard BIOS must contain the Intel-defined BIOS update API, otherwise a complete BIOS upgrade is required from the mainboard vendor.

Since API program can only be executed under **DOS Real Mode**, you must **enter Real Mode first** and load the API program to Drive C.

To load the program to C by following steps:

- (1) Type " md c:\ api " and press Enter. Directory "api" is made in Drive C now.
- (2) Insert the Driver/Utility CD into CD ROM Drive E.
- (3) Then type " copy e:\api*. * c:\api " and press Enter.
(API program is loaded to Drive C now.)
- (4) Type " C:\ api \checkup " to execute this program.

The main menu should now be displayed with the following four options :

- 1) Check and load update
- 2) Specify stepping data file [current : pep.pdb]
- 3) Help
- 4) Quit without loading update

Select 1 to know the stepping filename, select 2 to load right patch code, then select 1 to update proper patch code. Now, the screen will show the message "please remove the CD from CD-ROM drive". Then cold boot (mechanical power off) system to continue. For more information, please refer to "CHECKUP.HLP" file.

3-2 SYSTEM BIOS CONFIGURATION SETUP

The following pages explain how to set up the BIOS configuration under the Award BIOS. The SETUP program is stored in the Read-Only-Memory (ROM) on the mainboard. To do the SETUP procedure, press the key when the system is booting up. The following main menu will appear. Please select " STANDARD CMOS SETUP" to enter the next screen.

ROM PCI/ISA BIOS	
CMOS SETUP UTILITY	
AWARD SOFTWARE, INC.	
STANDARD CMOS SETUP	INTEGRATED PERIPHERALS
BIOS FEATURES SETUP	SUPERVISOR PASSWORD
CHIPSET FEATURES SETUP	USER PASSWORD
POWER MANAGEMENT SETUP	IDE HDD AUTO DETECTION
PNP/PCI CONFIGURATION	SAVE & EXIT SETUP
LOAD BIOS DEFAULTS	EXIT WITHOUT SAVING
LOAD SETUP DEFAULTS	
ESC: Quit	↑↓→←:Select Item
F10: Save & Exit Setup	(Shift) F2 : Change Color
Time, Date, Hard Disk Type	

The section on the bottom of the main menu explains how to control this screen. The other section displays the items highlighted in the list.

STANDARD CMOS SETUP This screen records some basic hardware information, and sets the system clock and error handling. These records can be lost or corrupted if the on-board battery has failed or is weak.

ROM PCI/ISA BIOS
STANDARD CMOS SETUP
 AWARD SOFTWARE, INC.

Date (mm:dd:yy) : Mon, Jun 7 1999	
Time(hh:mm:ss) : 13 : 37 : 14	
HARD DISKS	TYPE SIZE CYLS HEAD PRECOMP LANDZ SECTOR MODE
Primary Master	: Auto 0 0 0 0 0 0 Auto
Primary Slave	: Auto 0 0 0 0 0 0 Auto
Secondary Master	: Auto 0 0 0 0 0 0 Auto
Secondary Slave	: Auto 0 0 0 0 0 0 Auto
Drive A : 1.44M, 3.5 in.	
Drive B : None	Base Memory : 640K
Floppy 3 Mode Support : Disabled	Extended memory : 7168K
Video : EGA/VGA	Other Memory : 384K
Halt On: All Errors	-----
	Total Memory : 8192K
ESC : Quit	↑↓→←:Select Item PU/PD/+/- : Modify
F1 : Help	(Shift) F2 : Change Color

Date The date format is <day>,<date>,<month>,<year>. Press<F3> to show the calendar.

day	The day, from Sun to Sat, determined by the BIOS and is displayed-only
date	The date, from 1 to 31
month	The month, Jan. through Dec.
year	The year, from 1900 to 2099

Time The time format is <hour><minute><second>. The time is calculated based on the 24-hour military-time clock. For example, 1p.m. is 13:00:00.

Primary Master Primary; Slave Secondary Master Secondary Slave

These categories identify the types of the 2 channels that have been installed in the computer. There are 45 predefined types and 4 user definable types for Enhanced IDE BIOS. Type 1 to 45 which are predefined. Type ‘user’ which is user-definable. Press PgUp/PgDn to select a numbered hard disk type or type the number and press <Enter>.

If you select '**Auto**', the BIOS will detect the HDD & CD-ROM Drive automatically at the POST stage and show the IDE for HDD & CD-ROM Drive. If you select '**user**', you will need to know the information listed below. This information should be from your hard disk vender or dealer. Then enter the figure directly and press <Enter>. If the controller of the HDD interface is ESDI, the selection shall be '**Type 1**'; if SCSI, the selection shall be '**None**'. If no device is installed select '**NONE**' and press <Enter>.

Type	drive type
SIZE	automatically adjusts
CYLS	number of cylinders
HEAD	number of heads
PRECOMP	write precom
LANDZ	landing zone
SECTOR	number of sectors
MODE	mode type

Drive A, Drive B This category identifies the types of floppy disk drive A or drive B that has been installed in the computer.

None	No floppy drive installed
360K, 5.25 in	5.25" PC-type 360KB capacity
1.2M, 5.25 in	5.25" AT-type 1.2MB capacity
720K, 3.5 in	3.5" double-side 720KB capacity
1.44M, 3.5 in	3.5" double-side 1.44MB capacity
2.88M, 3.5 in	3.5" double-side 2.88MB capacity

Floppy 3 Mode Support This is the Japanese standard floppy drive. This standard stores 1.2MB in a 3.5" diskette.

Video This category selects the type of video adapter used for the primary system monitor. Although secondary monitors are supported, you do not have to select the type in Setup.

EGA/VGA	Enhanced Graphics Adapter/Video Graphics Array. For EGA, VGA, SEGA, SVGA or PGA monitor adapters
CGA 40	Color Graphics Adapters, power up in 40 column mode
CGA 80	Color Graphics Adapters, power up in 80 column mode
MONO	Monochrome adapter, includes high resolution monochrome adapters

Halt On This category determines whether the computer will stop if an error is detected during power up.

No errors	The system boot will not be stopped for any error that may be detected.
All errors	When the BIOS detects a non-fatal error, the system will be stopped and you will be prompted.
All, But Keyboard	The system boot will not stop for a keyboard error. It will stop for all other errors.
All, But Diskette	The system boot will not stop for a disk error. It will stop for all other errors.
All, But Disk/Key	The system boot will not stop for a disk or keyboard error. It will stop for all other errors.

Memory This category is displayed only which is determined by POST (Power On Self Test) of the BIOS.

Base Memory The POST will determine the amount of base (or conventional) memory installed in the system. The value of the base memory is typically 512K or 640K based on the memory installed on the motherboard.

Extended Memory How much extended memory is present during the POST. This is the amount of memory located above 1MB in the CPU's memory address map.

Other Memory This refers to the memory located in the 640K to 1024K address space. This is memory that can be used for different applications. DOS uses this area to load device drivers in an effort to keep as much base memory free for application programs. The BIOS is the most frequent user of this RAM area since this is where it shadows RAM.

BIOS FEATURES SETUP This screen is a list of system configuration options. Some of them are defaults required by the mainboard's design, others depend on the features of your system.

ROM PCI/ISA BIOS

BIOS FEATURES SETUP

AWARD SOFTWARE, INC.

Virus Warning	: Disabled	Video BIOS Shadow	: Enabled
CPU L1 Cache	: Enabled	C8000-CBFFF Shadow	: Disabled
CPU L2 Cache	: Enabled	CC000-CFFFF Shadow	: Disabled
CPU L2 Cache ECC Checking	: Enabled	D0000-D3FFF Shadow	: Disabled
Processor Number Feature	: Enabled	D4000-D7FFF Shadow	: Disabled
Quick Power On Self Test	: Enabled	D8000-DBFFF Shadow	: Disabled
Boot Sequence	: A,C,SCSI	DC000-DFFFF Shadow	: Disabled
Swap Floppy Drive	: Disabled		
Boot Up Floppy Seek	: Enabled		
Boot Up NumLock Status	: On		
Gate A20 Option	: Fast		
Security Option	: Setup		
PCI/VGA Palette Snoop	: Disabled		
Assign IRQ For VGA	: Enabled		
Assign IRQ For USB	: Enabled	Esc : Quit	↑↓→←:Select Item
OS Select for DRAM>64MB	: Non-OS2	F1 : Help	PU/PD/+/- : Modify
HDD S.M.A.R.T. capability	: Disabled	F5 : Old Values (SHIFT)	F2 : Color
Report No FDD For WIN 95	: No	F6 : Load BIOS Defaults	
RTC Y2K Compliance	: Enabled	F7 : Load Setup Defaults	

Virus Warning When this item is enabled, the Award BIOS will monitor the boot sector and partition table of the hard disk drive for any attempt at modification. If an attempt is made, the BIOS will halt the system and the following error message will appear.

Afterwards, if necessary, you will be able to run an anti-virus program to locate and remove the problem before any damage is done.

! WARNING !

Disk boot sector is to be modified
Type 'Y' to accept write or 'N' to abort write
Award Software, Inc.

Enabled	Activates automatically when the system boots up. If anything attempts to access the boot sector or hard disk, partition table will cause a warning message to appear.
Disabled	No warning message will appear when anything attempts to access the boot sector or hard disk partition table.

Many disk diagnostic programs which attempt to access the boot sector table can cause the above warning message. If you will be running such a program, we recommend that you first disable Virus Protection beforehand.

CPU L1 Cache, L2 Cache These two categories speed up memory access. However, it depends on CPU/chipset design. The default value is ‘enabled’.

CPU L2 Cache ECC Checking When this item is enabled, it means the system supports Error Checking and Correcting (ECC) memory which can guard against data corruption.

Processor Number Feature The Processor Serial Number serves as an identifier for the Processor and its system and thus adds to the system security features. When this feature is “Enabled”, the Processor Serial Number is detectable and can be utilized in information Management etc. When “Disabled”, the Processor Serial Number is not detectable. This feature is built in Pentium®III Processor only.

Quick Power On Self Test This category speeds up Power On Self Test after you power up the computer. If you set “Enabled”, BIOS will shorten or skip some items under check during POST.

Boot Sequence This category determines which drive to search first for the Disk Operating System (i.e., DOS). The system will search those drives in order, Ex.: C, CDROM, A: System will first search for hard disk drive then CDROM drive, and the last is floppy disk drive.

Note: C is primary master; D is primary slave; E is secondary master, F is secondary slave.

Swap Floppy Drive This item allows you to determine whether to enable the swap floppy drive or not. The choice : Enabled/ Disabled.

Boot Up Floppy Seek During POST, the BIOS will determine if the floppy disk drive installed is 40 tracks (360K) or 80 tracks (720K, 1.2M, 1.44M)

Enabled	BIOS searches for floppy disk drive to determine if it is 40 or 80 tracks.
Disabled	BIOS will not search for the type of floppy disk drive by track number.

Boot Up NumLock Status This allows you to determine the default state of the numeric keypad. By default, the system boots up with NumLock on.

On	Keypad is for numeric keys.
Off	Keypad is for arrow keys.

Gate A20 Option This entry allows you to select how the gate A20 is handled. The gate A20 is a device used to address memory above 1 MB. Initially, the gate A20 was handled via a pin on the keyboard. Today, while keyboards still provide this support, it is more common and much faster for the system chipset to provide support for gate A20. Normal is keyboard; Fast is chipset.

Security Option This category allows you to limit access to the system and Setup, or just to Setup.

System	The system will not boot and access to Setup will be denied if the correct password is not entered at the prompt
Setup	The system will boot, but access to Setup will be denied if the correct password is not entered at the prompt

To disable the security, select PASSWORD SETTING at Main Menu, and then you will be asked to enter password. Do not type anything and just press <Enter>, it will disable the security. Once the security is disabled, the system will boot and you can enter Setup freely.

PCI/VGA Palette Snoop It determines whether the MPEG ISA/VGA cards can work with PCI/VGA or not.

Enabled	When PCI/VGA working with MPEG ISA/VGA Card
Disabled	When PCI/VGA not working with MPEG ISA/VGA Card

Assign IRQ for VGA When this items is enabled, the system will assign an IRQ for VGA. If disabled, VGA occupies no IRQ.

Assign IRQ for USB When this item is enabled, the system will assign an IRQ for USB. If disabled, USB occupies no IRQ.

OS Select for DRAM > 64MB This item allows you to access the memory that is over 64MB in OS/2. The choice : Non-OS2, OS2

HDD S.M.A.R.T. Capability Select Enabled if your Hard disk supports S.M.A.R.T.(Safe-Monitoring Analysis and Reporting Technology) function.

ReportNo FDD For WIN95 Set this item to Yes, BIOS will report FDD to Win95. If in standard CMOS setup, set Drive A to none and set this item to yes. Inside Win95, My Computer and File manager Disk(A:) will show Removable Disk (A:).

RTC Y2K Compliance Full Y2K system compliance supported.

Video BIOS Shadow Determines whether video BIOS will be copied to RAM. However it is optional depending on chipset design. Video Shadow will increase the video speed. The choice : Enabled/Disabled

C8000 – CBFFF Shadow; DC000 – DFFFF Shadow These categories determine whether option ROMs will be copied to RAM. An example of such option ROM would be the support of onboard SCSI. The choice : Enabled/Disabled

CHIPSET FEATURES SETUP This screen controls the setting for the chipset on the mainboard.

ROM PCI/ISA BIOS
CHIPSET FEATURES SETUP
 AWARD SOFTWARE, INC.

SDRAM CAS Latency Time	: 3	Clock/Spectrum Control	: Disabled/Off
SDRAM Precharge Control	: Disabled	CPU Clock/Spread Control	: 66MHz/Off
DRAM Data Integrity Mode	: Non-ECC	*Following menus are Optional*	
System BIOS Cacheable	: Disabled	*CPU Warning Temperature	: Disabled
Video BIOS Cacheable	: Disabled	*Shutdown Temperature	: 75 °C/ 167 °F
Video RAM Cacheable	: Disabled	*Current System Temp.	: 20 °C/ 68 °F
8-bit I/O Recovery Time	: 3	*Current VGA Temperature	: 20 °C/ 68 °F
16-bit I/O Recovery Time	: 2	*Current CPU Temperature	: 20 °C/ 68 °F
Memory Hole At 15M-16M	: Disabled	*Current Chassis FAN Speed	: 0 PRM
Passive Release	: Enabled	*Current Power FAN Speed	: 0 PRM
Delayed Transaction	: Disabled	*Current CPU FAN Speed	: 0 PRM
AGP Aperture Size (MB)	: 128	*Vcore : 2.80V	VTT(V) : 2.81V
Auto Detect DIMM/PCI CIK	: Disabled	*+3.3V : 3.45V	+5V : 4.91V
		*+12V : 12.22V	-12V : -11.76
		*-5V : -5.16V	
Following items for EDO DRAM Only			
EDO Auto Configuration	: Enabled	Esc: Quit	↑↓→← : Select Item
EDO DRAM Speed Selection	: 60ns	F1 : Help	PU/PD/+/-: Modify
EDO CASx# MA Wait State	: 1	F5 : Old Values	(Shift)F2 : Color
EDO RASx# Wait State	: 1	F6 : Load BIOS Defaults	
		F7 : Load Setup Defaults	

SDRAM CAS Latency Time You could select CAS latency time in HCLKS of 2/2 or 3/3. The system board designer should set the values in this field, depending on the DRAM installed. Do not change the values in this field unless you change specifications of the installed DRAM or the installed CPU. The choice : 2, 3.

SDRAM Precharge Control This option determines the action taken when a page miss occurs (SDRAM only).

DRAM Data Integrity Mode Select parity, ECC, or Disabled, depending on the type of DRAM installed in your system. The choice : ECC, Parity, Disabled.

System BIOS Cacheable Selecting Enabled allows the caching of the system BIOS ROM at F0000h-FFFFFh, resulting in better system performance. However, if any program writes to this memory area, a system error may result.

Video BIOS Cacheable Selecting Enabled allows the caching of the video BIOS ROM at F0000h-FFFFFh, resulting in better system performance. However, if any program writes to this memory area, a system error may result.

Video RAM Cacheable Selecting Enabled allows the caching of the video RAM, resulting in better system performance. However, if any program writes to this memory area, a system error may result.

8 Bit I/O Recovery Time The recovery time is the length of time, measured in CPU clocks, which the system will be delayed after the completion of an I/O request. This delay takes place because the CPU is operating so much faster than the input/output bus that the CPU must be delayed to allow for the completion of the I/O. This item allows you to determine the recovery time allowed for 8 bit I/O. Choices are from NA, 1 to 8 CPU clocks.

16BitI/ORecoveryTime This item allows you to determine the recovery time allowed for 16-bit I/O. Choices are from NA, 1 to 4 CPU clocks.

Memory Hole At 15M-16M In order to improve performance, certain space in memory can be reserved for ISA cards. This memory must be mapped into the memory below 16MB.

PassiveRelease When Enabled, CPU to PCI bus accesses are allowed during passive release. Otherwise, the arbiter only accepts another PCI master access to local DRAM. The choice : Enabled, disabled.

Delayed Transaction This chipset has an embedded 32-bit posted write buffer to support deadly transactions cycles. Select Enabled to support compliance with PCI specification version 2.1. The choice : Enabled, disabled space

AGP Aperture Size (MB) Select the size of the AGP aperture. The aperture is a portion of the PCI memory address range dedicated for graphics memory address space. Host cycle that hit the aperture range are forwarded to the AGP without any translation. See www.agpforum.org for AGP information. The choice 4, 8, 16, 32, 64, 128, 256.

EDO Auto Configuration The first chipset settings deal with CPU access to dynamic random access memory (DRAM). The default timings have been carefully chosen and should only be altered if data is being lost. Such a scenario might well occur if your system had mixed speed DRAM chips installed so that greater delays may be required to preserve the integrity of the data held in the slower memory chips.

EDO DRAM Speed Selection The DRAM speed is controlled by the DRAM timing Registers. The timings programmed into this register are dependent on the system design. Slower rates may be required in certain system designs to support loose layouts or slower memory. i.e. 50ns; 60ns

EDO CASx# MA Wait State This item allows you to select EDO CASx# MA Wait State. The choice : 1, 2

EDO RASx# Wait State This sets the relative delay between the row and column address strobes from DRAM (EDO). The choice : 1, 2

Auto Detect DIMM/PCI CLK If this item is enabled, the unused DIMM and PCI slot clock will be disabled. If this item is disabled the unused DIMM and PCI slot will still get the active clock signal.

Clock/ Spectrum Control When disabled/Off, the system will automatically set the base frequency according to the CPU type :

Pentium® II 233~333MHz & Celeron™ 266~466MHz: Set to 66MHz.

Pentium® II 350~450MHz and Pentium® III: Set to 100MHz.

When enabled, there is another item showed below: “CPU Clock/Spread Spectrum” for user to set the base frequency and enable/disable the clock generator spread spectrum manually.

CPU Clock/ Spread Spectrum Use this item to set CPU base clock frequency and Enable / Disable the clock generator spread spectrum which includes 66MHz/Off, 66MHz/On, 75MHz/On, 78MHz/Off, 81MHz/Off, 83MHz/On, 90MHz/On, 95MHz/On, 100MHz/Off, 100MHz/On, 105MHz/On, 110MHz/On, 112MHz/On, 113MHz/Off, 115MHz/On, 117MHz/Off, 118MHz/Off, 120MHz/On, 122MHz/Off, 124MHz/On, 126MHz/Off, 133MHz/Off, 133MHz/On, 135MHz/Off, 137MHz/Off, 138MHz/Off, 140MHz/On, 142MHz/Off, 144MHz/Off, 150MHz/On and 155MHz/Off.

Note: After you change the CPU Clock Frequency and the system can not start, please do the following procedures:

1. Turn the system off firstly.
2. Turn on the system. Then press and hold the “ Insert ” key at boot.
3. Select the proper frequency in the item of *CPU Host/PCI Clock*.
4. Save and Exit Setup.

The following functions are optional, and they show only when the monitoring IC exists on the mainboard. Please confirm this with your supplier.

CPU Warning Temperature When this item is enabled, we can set the CPU warning temperature. If the CPU temperature is higher than the setting temperature, the system will beep.

Shutdown Temperature If the CPU temperature is higher than the setting temperature, the system will shut down.

Current System Temperature This field displays the current system temperature if your computer contains a monitoring system.

Current CPU Temperature It shows the current system temperature.

Current VGA Temperature It shows the current VGA temperature.

Current Chassis FAN/Power FAN/CPU FAN Speed It shows the running speed of the chassis fan, power fan and CPU fan. The figure will be changing when the system is running. If you do not install the fan, the figure will show 0.

POWER MANAGEMENT SETUP This screen controls the 'green' features of this mainboard.

ROM PCI/ISA BIOS
POWER MANAGEMENT SETUP
 AWARD SOFTWARE, INC.

ACPI function	: Disabled	*Reload Global Timer Events*
Power Management	: User Define	IRQ [3-7, 9-15], NMI :Disabled
PM Control by APM	: Yes	Primary IDE 0 :Disabled
Video Off Method	: DPMS	Primary IDE 1 :Disabled
Video Off After	: Standby	Secondary IDE 0 :Disabled
Doze Mode	: Disabled	Secondary IDE 1 :Disabled
Standby Mode	: Disabled	Floppy Disk :Disabled
Suspend Mode	: Disabled	Serial Port :Enabled
HDD Power Down	: Disabled	Parallel Port :Disabled
Throttle Duty Cycle	: 62.5%	
PCI/VGA Act-Monitor	: Disabled	
Soft-Off by PWR-BTTN	: Instant-Off	
CPUFAN Off In Suspend	: Enabled	
PowerOn by Ring	: Disabled	Esc: Quit ↑↓→← :Select Item
Resume by Alarm	: Disabled	F1 : Help PU/PD/+/- : Modify
		F5 : Old Values (Shift) F2: Color
PCI PME# Function	: Disabled	F6 : Load BIOS Defaults
IRQ 8 Break Suspend	: Disabled	F7 : Load Setup Defaults

ACPI function This item is to set the ACPI (Advanced Configuration Power Interface) function enabled or disabled. The default setting is disabled.

Power Management This category allows you to select the type (or degree) of power saving and is directly related to the following modes : **Doze; Standby; Suspend; HDD Power Down.**

Min. Power Saving	Minimum power management. Doze =1hr.; Standby=1hr.; Suspend=1hr.; HDD Power Down=15min
Max. Power Saving	Doze=1min.; Standby=1min.; Suspend=1min.;HDD Power Down=1min
User Define	Allows you to set each mode individually. Each of the ranges is from 1min. to 1hr. except for HDD Power Down which ranges from 1 to 15min.

If you would like to use Software Power-off Control function, you should select “Yes” in PM Control by APM.

PM Control by APM When enabled, an Advanced Power Management mechanism will be activated to enhance the Max. Power Saving Mode and stop the CPU internal clock. If the Max. Power Saving is not enabled, this will be shown as Yes.

Video Off Method This determines the manner in which the monitor is blanked.

V/H SYNC + Blank	This selection will cause the system to turn off the vertical and horizontal sync. ports and write blanks to the video buffer.
Blank Screen	This option only writes blanks to the video buffer.
DPMS	Initial of “Display Power Management Signaling”.

Video off After When enabled, this feature allows the VGA adapter to operate in a power saving mode.

N/A	Monitor will remain on during power saving modes.
Suspend	Monitor is blanked when the system enters the Suspend mode.
Standby	Monitor is blanked when the system enters the Standby mode.
Doze	Monitor is blanked when the system enters any power saving mode.

The Following 4 modes are Green PC power saving functions which are only user configurable when ‘User Define’ power management has been selected.

➤ **Doze Mode** When enabled and after the set time of system inactivity, the CPU clock will run at slower speed while all other devices still operate at full speed.

➤ **Standby Mode** When enabled and after the set time of system inactivity, the fixed disk drive and the video will be shut off while all other devices still operate at full speed.

➤ **Suspend Mode** When enabled and after the set time of system inactivity, all devices except the CPU will be shut off.

➤ **HDD Power Down** When enabled and after the set time of system inactivity, the hard disk drive will be powered down while all other devices remain active.

Throttle Duty Cycle When the system enters Doze mode, the CPU clock runs only partial cycle. You may select the percentage of cycle that the clock runs.

PCI/ VGA Act-Monitor When Enabled, any video active restarts the global timer for standby mode.

Soft-Off by PWR-BTTN *Instant-off* : When push the power button, the system power will be off immediately. *Delay 4 sec* : when push the power button, it will enter suspend mode. We need to push the power button and hold it for 4 seconds to turn off the power.

CPUFAN Off In Suspend Enabled: under suspend mode, the CPU FAN will be turned off. Disabled: the CPU FAN won't be turned off.

PowerOn by Ring Enabled: when system is in suspend mode, it can be waked up by modem. Disabled: it cannot be waked up by modem.

Resume by Alarm When Enabled, two additional lines will be added to the screen :Date (of Month) Alarm; Time (hh:mm:ss) Alarm to let user set the desired date and time. After power off, the system will automatically power on at the specified date and time.

PCI PME# Function With PCI card supporting PCI Power Management capability and this item setting to Enabled, the system can be waked up by PCI card.

IRQ8 Break Suspend When enabled, the device which occupies the IRQ8 can wake up the system.

Reload Global Timer Events When enabled, an event occurring on each device listed below restarts the global time for Standby mode. IRQ [3-7, 9-15], NMI; Primary IDE 0; Primary IDE 1; Secondary IDE0; Secondary IDE1; Floppy Disk; Serial Port; Parallel Port

PNP/PCI CONFIGURATION This screen configures the PCI Bus slots.

ROM PCI/ISA BIOS
PNP/PCI CONFIGURATION
 AWARD SOFTWARE, INC.

PNP OS Installed : No Resources Controlled by : Auto Reset Configuration Data : Disabled	
Esc: Quit ↑↓→← :Select Item F1 : Help PU/PD/+/- : Modify F5 : Old Values (Shift) F2: Color F6 : Load BIOS Defaults F7 : Load Setup Defaults	

PNP OS Installed This item allows you to determine PnP OS or not. Choices are Yes or No.

Resource Controlled by The Award Plug and Play BIOS has the capability to automatically configure all of the boot and Plug & Play compliant devices. However, this capability means absolutely nothing unless you are using a Plug and Play OS such as Windows 95. Choices are Auto and Manual.

Reset Configuration Data This item allows you to determine whether to reset the configuration data or not.

IRQ3/4/5/7/9/10/11/12/14/15, DMA0/1/3/5/6/7 Assign to This item allows you to determine the IRQ/DMA assigned to the ISA bus and is not available to any PCI slot. Choices are Legacy ISA and PCI/ISA PnP.

Used MEM base addr This item allows you to determine which basic address will not be occupied by PCI card and leave these address for some special ISA card used only. Choices are N/A, C800, CC00, D000, D400, D800, DC00.

Used MEM Length This item determines the memory length of address which is for some special ISA Card used. Choices are 8K, 16K, 32K, 64K.

INTEGRATED PERIPHERALS This section page includes all the items of IDE hard drive and Programmed Input/Output features. See also Section “Chipset Features Setup”.

ROM PCI/ISA BIOS

INTEGRATED PERIPHERALS

AWARD SOFTWARE, INC.

IDE HDD Block Mode	: Enabled	Onboard Serial Port 2	: 3F8/IRQ3
IDE Primary Master PIO	: Auto	UART Mode Select	: Normal
IDE Primary Slave PIO	: Auto	RxD , TxD Active	: Hi, Lo
IDE Secondary Master PIO	: Auto	IR Transmission Delay	: Enabled
IDE Secondary Slave PIO	: Auto	Onboard Parallel Port	: 378/IRQ7
IDE Primary Master UDMA	: Auto	Onboard Parallel Mode	: ECP
IDE Primary Slave UDMA	: Auto	ECP Mode Use DMA	: 3
IDE Secondary Master UDMA	: Auto	EPP Mode Select	: EPP1.7
IDE Secondary Slave UDMA	: Auto	PWRON After PWR-Fail	: Off
On-Chip Primary PCI IDE	: Enabled		
On-Chip Secondary PCI IDE	: Enabled		
USB Keyboard Support	: Disabled		
Init Display first	: PCI Slot	Esc: Quit	↑↓→← : Select Item
Power On Function	: Button Only	F1 : Help	PU/PD/+/- : Modify
KBC input clock	: 8 MHz	F5 : Old Values	(Shift) F2: Color
Onboard FDC Controller	: Enabled	F6 : Load BIOS Defaults	
Onboard Serial Port 1	: 3F8/IRQ4	F7 : Load Setup Defaults	

IDE HDD Block Mode This allows your HD controller to use the fast block mode to transfer data to and from your HD drive.

Enabled	IDE controller uses block mode .
Disabled	IDE controller uses standard mode.

IDE Primary Master/Slave PIO IDE; Secondary Master/Slave PIO

PIO - Programmed Input/Output, it allows the BIOS to tell the controller what it wants and then let the controller and the CPU to complete the task by themselves. This is simpler and faster. Your system supports five modes, 0 - 4, which primarily differ in timing. When **Auto** is selected, the BIOS will select the best available mode.

IDE Primary Master/Slave UDMA; IDE Secondary Master/Slave UDMA Auto, will support the Ultra DMA function. Disabled, will not support the Ultra DMA function.

On-Chip Primary PCI IDE; On-Chip Secondary PCI IDE This setup item allows you to either enable or disable the primary/secondary controller. You might choose to disable the controller if you want to add higher performance or specialized controller.

USB Keyboard Support Enabled will support USB keyboard in Win95 2.1 and NT 5.0 or above operating system.

Init Display First If you set this item to PCI Slot, it will activate the PCI video card first in the multi-displayed environment. The choice: PCI Slot, AGP.

Power On Function

- **KB Power On Password:** This function is available with ATX power only. User can power on the system by setting a password via keyboard. Please refer to Page 7 “Password(via Keyboard) for setting the “Password Power-On “ function. If a set password is forgotten or can not be retrieved, please refer to Page 14 “Clear CMOS” to clear old password and set a new one.
- **Hot Key :** This is also an ATX Power supported function. Please refer to Page 7 “Hot Key (via Keyboard)” for setting this Hot Key Power-on function.
- **Mouse Left, Mouse Right :** This is also an ATX Power supported function. Please refer to Page 7 “Mouse Left, Mouse Right(via PS/2 Mouse)” for setting this PS/2 Power-on function. When using this Power-On function to shut or start your computer, your double-clicking the mouse button should not be interfered by any slight move or slide of the mouse.
- **BUTTON ONLY :** Only pressing power button can power the system.

KBC input clock Let user change the keyboard working clock.

On Board FDC Controller This item will enable or disable the floppy disk controller.

On Board Serial Port 1 User can select serial port IRQ. If set to Auto, system will assign an IRQ for it. Note : set to Auto is not recommended.

On Board Serial Port 2 User can select serial port IRQ. If set to Auto, system will assign an IRQ for it. Note : set to Auto is not recommended.

UART Mode Select This lets you select the Infrared mode. Choices are Normal, IrDA, and ASKIR. If you choose IrDA or ASKIR mode, the screen will show another two lines to let you choose 'RxD TxD Active' (Hi Lo; Lo Hi; Hi Hi; Lo Lo), and 'IR Transmission Delay' (Enabled/Disabled).

On Board Parallel Port Let user select IRQ for parallel port When Disabled, the parallel port will be disabled.

On Board Parallel Mode Let user select parallel port protocol. This item is not recommended to change except user has special request.

ECP Mode Use DMA Select a DMA channel for the port. Choices are 3, 1.

EPP Mode Select Let user select EPP version.

PWRON After PWR-Fail When Last State, this allows you to set whether you want your system to boot up after the power has been interrupted. "Always Off" leaves your system off after reapplying power.

ROM PCI/ISA BIOS
CMOS SETUP UTILITY
 AWARD SOFTWARE, INC.

STANDARD CMOS SETUP	INTEGRATED PERIPHERALS
BIOS FEATURES SETUP	SUPERVISOR PASSWORD
CHIPSET FEATURES SETUP	USER PASSWORD
POWER MANAGEMENT SETUP	IDE HDD AUTO DETECTION
PNP/PCI CONFIGURATION	SAVE & EXIT SETUP
LOAD BIOS DEFAULTS	EXIT WITHOUT SAVING
LOAD SETUP DEFAULTS	
ESC: Quit	↑↓→←:Select Item
F10: Save & Exit Setup	(Shift) F2 : Change Color
Time, Date, Hard Disk Type	

ROM PCI/ISA BIOS
CMOS SETUP UTILITY
 AWARD SOFTWARE, INC.

Hard Disks	Type	Size	CYLS	HEAD	PRECOMP	LANDZ	SECTOR	MODE
Primary Master :								
Select Primary Master Option (N=Skip) : N								
Options	Size	CYLS	Head	PRECOMP	LANDZ	Sector	Mode	
2(Y)	1337	648	64	0	2594	63	LBA	
1	1339	2595	16	65535	2594	63	NORMAL	
3	1338	1297	32	65535	2594	63	LARGE	
Note : Some OSes (like SCO-UNIX) must use "Normal" for installation								
ESC : Skip								

The last second item of the main menu is 'save and exit'. If you select this item and press 'Y', then these records will be saved in the CMOS memory on the mainboard. It will be checked every time you turn your computer on.

ROM PCI/ISA BIOS
CMOS SETUP UTILITY
 AWARD SOFTWARE, INC.

STANDARD CMOS SETUP	INTEGRATED PERIPHERALS
BIOS FEATURES SETUP	SUPERVISOR PASSWORD
CHIPSET FEATURES SETUP	USER PASSWORD
POWER MANAGEMENT SETUP	IDE HDD AUTO DETECTION
PNP/PCI CONFIGURATION	SAVE & EXIT SETUP
LOAD BIOS DEFAULTS	EXIT WITHOUT SAVING
LOAD SETUP DEFAULTS	
ESC: Quit	↑↓→←:Select Item
F10: Save & Exit Setup	(Shift) F2 : Change Color
Time, Date, Hard Disk Type	

ROM PCI/ISA BIOS
CMOS SETUP UTILITY
 AWARD SOFTWARE, INC.

STANDARD CMOS SETUP	INTEGRATED PERIPHERALS
BIOS FEATURES SETUP	PASSWORD SETTING
CHIPSET FEATURES SETUP	IDE HDD AUTO DETECTION
POWER MANAGEMENT SETUP	SAVE & EXIT SETUP
PNP/PCI CONFIGURATION	EXIT WITHOUT SAVING
LOAD BIOS DEFAULTS	SAVE to CMOS and EXIT (Y/N):Y
ESC: Quit	↑↓→←:Select Item
F10: Save & Exit Setup	(Shift) F2 : Change Color
Save Data to CMOS & Exit SETUP	

LOAD BIOS DEFAULTS When your mainboard has problems and needs to trouble shoot the system, you can use this function. The default values loaded only affect the BIOS Features Setup, Chipset Features Setup, Power Management Setup and PNP/PCI Configuration Setup. There is no effect on the Standard CMOS Setup. To use this function, select it from main menu and press <Enter>. A line will appear on the screen asking if you want to load the BIOS default values. Press <Yes> and <Enter> then the BIOS default values will be loaded.

LOAD SETUP DEFAULTS This allows you to load optimal settings which are stored in the BIOS ROM. The default values loaded only affect the BIOS Features Setup, Chipset Features Setup, Power Management Setup and PNP/PCI Configuration Setup. There is no effect on the Standard CMOS Setup. To use this function, select it from main menu and press <Enter>. A line will appear on the screen asking if you want to load the Setup default values. Press <Yes> and <Enter> then the Setup default values will be loaded.

SUPERVISOR PASSWORD / USER PASSWORD This allows you to set the password. The mainboard defaults with password disabled. If you set both supervisor and user passwords, only the supervisor password allows you to enter the BIOS SETUP program.

Enter/Change password: Enter the current password. And at the prompt, key-in your new password (up to eight alphanumeric characters), then press <Enter>. At the next prompt, confirm the new password by typing it again and press <Enter>.

Disable password : Press the <Enter> key instead of entering a new password when the 'Enter Password' dialog box appears. A message will appear for confirming that the password is disabled.



CAUTION: If you forget your password, you must clear CMOS first and restart system in order to set up password again. See "Clear CMOS" on Page 14.

IDE HDD AUTO DETECTION This allows you to detect the IDE hard disk driver's parameters and enter them into 'Standard CMOS Setup' automatically. If the auto-detected parameters displayed do not match the ones that should be used for your hard drive, do not accept them. Press <N> to reject the values and enter the correct ones manually on the Standard CMOS Setup screen.

SAVE & EXIT SETUP This allows you to save the new setting values in the CMOS memory and continue with the booting process. Select what you want to do, press <Enter>.

EXIT WITHOUT SAVING This allows you to exit the BIOS setup utility without

recording any new values or changing old ones.

Control Key Description

UP ARROW		Move to previous item
DOWN ARROW		Move to next item
LEFT ARROW		Move to the item in the left hand
RIGHT ARROW		Move to the item in the right hand
Esc KEY	Esc	Main Menu : Quit and not save changes Setup menu : Exit current page and return to main menu
PgUp KEY		Increase the numeric value or make changes
PgDn KEY		Decrease the numeric value or make changes
F1 KEY	Help	General help
F2 KEY	Shift +F2	Change color from total 16 colors
F5 KEY	Old Value	Restore the pervious CMOS value from CMOS
F6 KEY	Load BIOS default	Load the default CMOS value from BIOS default table
F7 KEY	Load setup default	Load Setup default
F10 KEY	Save & Exit Setup	Save all the CMOS changes and Exit setup, only for Main Menu