

615TCF/615TCS USER'S MANUAL

M/B For Socket 370 Pentium® III Processor

NO. G03-615CFR3A

Release date: May 2002

Trademark:

* Specifications and Information contained in this documentation are furnished for information use only, and are subject to change at any time without notice, and should not be construed as a commitment by manufacturer.

TABLE OF CONTENT

USER'S NOTICE	ii
MANUAL REVISION INFORMATION	1
THERMAL SOLUTIONS.....	1
CHAPTER 1 INTRODUCTION OF MOTHERBOARD	
1-1 FEATURE OF MOTHERBOARD.....	2
1-2 SPECIFICATION	3
1-3 PERFORMANCE LIST	4
1-3-1 615TCF/615TCS	4
1-4 LAYOUT DIAGRAM & JUMPER SETTING	5
CHAPTER 2 HARDWARE INSTALLATION	
2-1 HARDWARE INSTALLATION STEPS.....	7
2-2 CHECKING MOTHERBOARD'S JUMPER SETTING	7
2-3 INSTALL CPU	9
2-3-1 GLOSSARY	9
2-3-2 SETTING CPU BUS CLOCK & MEMORY CLOCK JUMPER.....	11
2-3-3 INSTALL CPU.....	12
2-3-4 OVERCLOCK RUNNING	12
2-4 INSTALL MEMORY	14
2-5 EXPANSION CARDS.....	15
2-5-1 PROCEDURE FOR EXPANSION CARD INSTALLATION.....	15
2-5-2 ASSIGNING IRQ FOR EXPANSION CARD.....	15
2-5-3 INTERRUPT REQUEST TABLE FOR THIS MOTHERBOARD.....	16
2-5-4 AIMM/AGP SLOT	16
2-6 CONNECTORS, HEADERS	17
2-6-1 CONNECTORS	17
2-6-2 HEADERS	19
2-7 STARTING UP YOUR COMPUTER.....	23
CHAPTER 3 INTRODUCING BIOS	
3-1 ENTERING SETUP.....	24
3-2 GETTING HELP.....	25
3-3 THE MAIN MENU	25
3-4 STANDARD CMOS FEATURES.....	27
3-5 ADVANCED BIOS FEATURES	28
3-6 ADVANCED CHIPSET FEATURES	31
3-6-1 SDRAM TIMING SETTING.....	32
3-7 INTEGRATED PERIPHERALS.....	33
3-7-1 ON-CHIP IDE FUNCTION.....	34
3-7-2 ON-CHIP SIO FUNCTION.....	35
3-7-3 ON-CHIP DEVICE FUNCTION	36
3-8 POWER MANAGEMENT SETUP.....	37

3-9 PNP/PCI CONFIGURATION SETUP.....	39
3-10 PC HEALTH STATUS.....	40
3-11 MISCELLANEOUS CONTROL	41
3-12 LOAD STANDARD/OPTIMIZED DEFAULTS	42
3-13 SET SUPERVISOR/USER PASSWORD	42

CHAPTER 4 DRIVER & FREE PROGRAM INSTALLATION

MAGIC INSTALL SUPPORTS WINDOWS 95/98/98SE/NT4.0/2000	43
4-1 INF INSTALL INTEL 815 CHIPSET SYSTEM DRIVER.....	44
4-2 IDE INSTALL INTEL ULTRA ATA STORAGE DRIVER.....	45
4-3 VGA INSTALL ON-BOARD VGA DRIVER.....	46
4-4 AC97 SOUND DRIVER AND THE PROGRAM INSTALL FOR EDITING/PLAYBACK	46
4-5 PC-HEALTH INSTALLS SMART GUARDIAN SOFTWARE FOR HARDWARE MONITORING DEVICE	47
4-6 PC-CILLIN INSTALL PC-CILLIN98 ANTI-VIRUS PROGRAM	48
4-7 MAGIC BIOS INSTALL BIOS LIVE UPDATE UTILTY	50
4-8 MICROSOFT DIRECTX 8.0 DRIVER	51
4-9 HOW TO UTILIZE ALSRACK EDITING & PLAYBACK UTILITY ...	52
4-10 HOW TO UTILIZE PC-HEALTH.....	52
4-11 HOW TO DISABLE ON-BOARD SOUND.....	53
4-12 HOW TO UPDATE BIOS	53

USER'S NOTICE

COPYRIGHT OF THIS MANUAL BELONGS TO **THE MANUFACTURER**. NO PART OF THIS MANUAL, INCLUDING THE PRODUCTS AND SOFTWARE DESCRIBED IN IT MAY BE REPRODUCED, TRANSMITTED OR TRANSLATED INTO ANY LANGUAGE IN ANY FORM OR BY ANY MEANS WITHOUT WRITTEN PERMISSION OF **THE MANUFACTURER**.

THIS MANUAL CONTAINS ALL INFORMATION REQUIRED TO USE THIS MOTHERBOARD AND WE DO ASSURE THIS MANUAL MEETS USER'S REQUIREMENT BUT WILL CHANGE, CORRECT ANY TIME WITHOUT NOTICE. **MANUFACTURER** PROVIDES THIS MANUAL "AS IS" WITHOUT WARRANTY OF ANY KIND, AND WILL NOT BE LIABLE FOR ANY INDIRECT, SPECIAL, INCIDENTAL OR CONSEQUENTIAL DAMAGES (INCLUDING DAMAGES FOR LOSS OF PROFIT, LOSS OF BUSINESS, LOSS OF USE OF DATA, INTERRUPTION OF BUSINESS AND THE LIKE).

PRODUCTS AND CORPORATE NAMES APPEARING IN THIS MANUAL MAY OR MAY NOT BE REGISTERED TRADEMARKS OR COPYRIGHTS OF THEIR RESPECTIVE COMPANIES, AND THEY ARE USED ONLY FOR IDENTIFICATION OR EXPLANATION AND TO THE OWNER'S BENEFIT, WITHOUT INTENT TO INFRINGE.

Manual Revision Information

Reversion	Revision History	Date
3.0	Third Edition	May 2002

Item Checklist

- Motherboard
- Cable for IDE/Floppy
- CD for motherboard utilities
- Cable for USB Port 3/4 (Option)
- User's Manual

Intel® Processor Family

Thermal Solutions

As processor technology pushes to faster speeds and higher performance, thermal management becomes increasingly crucial when building computer systems. Maintaining the proper thermal environment is key to reliable, long-term system operation. The overall goal in providing the proper thermal environment is keeping the processor below its specified maximum case temperature. Heatsinks induce improved processor heat dissipation through increased surface area and concentrated airflow from attached fans. In addition, interface materials allow effective transfers of heat from the processor to the heatsink. For optimum heat transfer, Intel recommends the use of thermal grease and mounting clips to attach the heatsink to the processor.

When selecting a thermal solution for your system, please refer to the website below for collection of heatsinks evaluated and recommended by Intel for use with Intel processors.

Vendor list for heatsink and fan of **Pentium® !!! processor**, please visit :
<http://developer.intel.com/design/Pentiumiii/components/index.htm>

Vendor list for heatsink and fan of **Intel® Celeron™ processor**, please visit :
<http://developer.intel.com/design/celeron/components/index.htm>

Chapter 1

Introduction of 615TCF/615TCS Motherboard

1-1 Feature of motherboard

The 615TCF/615TCS motherboard is design for use Intel's new generation Pentium processors, which utilize the Socket 370 design and the memory size expandable to 512MB.

This motherboard uses the newest Intel 815E B-Step/815EP B-Step chipset, supports Tualatin, Coppermine, Celeron processors whose 133MHz front side bus & 133MHz memory interface delivers a clear upgrade path to the future generation of 133MHz processors and PC-133 SDRAM. It offers ULTRA DMA 100MB/sec (ATA 100) to provide speedier HDD throughout that boosts overall system performance.

For 615TCF, with integrated 3D Graphic Acceleration, makes this board lower cost alternative to a video card. For those wanting even greater graphic performance, an AGP 4X slot is included on the board. This AGP slot will support either a 4X VGA card or a 4MB display cache AGP In-line Memory Module (AIMM).

And for 615TCS, this board provides on board AGP 4X slot for those wanting even greater graphic performance.

This board also integrated AC'97 2.1 CODEC on board which is fully compatible with Sound Blaster Pro[®] that gives you the best sound quality and compatibility. With 2 USB control as well as capability of expanding to 4 USB connectors, which guarantees this board to meet future USB demand. Moreover, this motherboard has built-in hardware monitor function that capable of monitor and protect your computer.

This motherboard provides high performance & meets future specification demand. It is really wise choice for your computer.

1-2 Specification

Spec	Description
------	-------------

Design	* Micro ATX form factor 4 layers PCB size: 24.5x19cm
Chipset	* Intel 815E B-Step Chipset for 615TCF * Intel 815EP B-Step chipset for 615TCS
Clock Generator	* ICS 950502 Clock Generator * Support 66/100/133MHz system Bus Clock (CPU Bus Clock) * Support CPU Frequency step by step setting in BIOS Setup * Support 100/133 MHz system Memory clock * Support 33MHz PCI Bus clock
CPU Socket	* Support Pentium® III 500~1GHz processor * Support Celeron™ 533~900MHz processor * Support 66, 100 and 133MHz CPU Bus clock * Reserves support for future Intel Pentium® III processors
Memory Socket	* 168-pin DIMM socket x2 * PC-100/PC-133 SDRAM * Expandable to 512MB * Support 3.3V SDRAM DIMM
Expansion Slot & Headers	* AGP/AIMM slot x1 support AGP 2.0 & 4X mode * 32-bit PCI slot x3 PCI-2.2 compliant * CNR slot x1
Integrate VGA (615TCF Only)	* 3D graphic acceleration * Expandable 4MB display cache by AIMM
Integrate IDE	* 2 channel of Bus Master IDE port supporting ULTRA DMA 33/66/100 mode devices
Audio	* AC'97 Digital Audio controller integrated * AC'97 Audio CODEC on board * Audio driver and utility included
BIOS	* Award 2Mb Flash ROM
Multi I/O	* PS/2 keyboard and PS/2 mouse connectors * Floppy disk drive connector x1 * Parallel port x1 * Serial port x2 * USB connector x2 * USB headers x2 (connecting cable option) * Audio connector (Line-in, Line-out, MIC & Game Port)

1-3 Performance List

1-3-1 615TCF/615TCS

The following performance data list is the testing result of some popular benchmark testing programs. These data are just referred by users, and there is no responsibility for different testing data values gotten by users (the different Hardware & Software configuration will result in different benchmark testing results.)

CPU: Intel PIII® 866MHz FC-PGA/Tualatin 933MHz FC-PGA2 package
DRAM: 128M SDRAM x2 (Hyundai GM 72V66841ET75)
VGA Expansion Card: Geforce 256 (1024x768 Hi-color) Driver V3.68
Hard Disk Driver: IBM DTLA-305040 (ATA 100)
BIOS: Award Optimal default
OS: Win 98SE

Performance Test Report

	866MHz (133/133) On Board VGA	866MHz (133/133) With Geforce 256	933MHz (133/133) With Geforce 256
3D Mark 99	1393	5923	5962
3D Mark 2000	945	4657	4737
3D Mark 2001	600	1834	1885
3D Winbench 99 V1.2	324	899	900
3D Winbench 2000	17.3	88.3	89.2
Final Reality	6.27	6.15	6.59
Winstone 99 V1.3	31.6	32.5	33.6
Content Creation Winstone 2000	34.2	35.5	37.6
Content Creation Winstone 2001	40.3	41.4	44.2
Business Winstone 2001	36.5	36.8	39.7
Winbench 99 :			
CPU Mark 99	74.8	76.9	83.7
FPU Winmark 99	4590	4590	5130
Business Disk Winmark99	5180	5110	5390
Hi-end Disk Winmark99	17800	17500	18400
Business Graphic Winmark	219	384	415
Hi-end Graphic Winmark	786	1030	1100
SYS Mark 2000 : SISMark 2000 Rating (Internet Content Creation / Office Productivity)			
Suites	165 (170/161)	172 (173/172)	185 (187/184)
Official	165 (171/161)	172 (172/172)	185 (187/183)
SISOFT Sandra 2001 :			
Dhrystone ALU MIPS	2346	2347	2620
Whetstone FPU MFLOPS	1163	1163	1252
Int ALU/RAM MB/S	288	326	356
Float FPU/RAM MB/S	325	374	377
QUAKE3 DEMO1 FPS	30.5	109.1	116.0
DEMO2 FPS	30.7	103.9	111.4

1-4 Layout Diagram & Jumper Setting

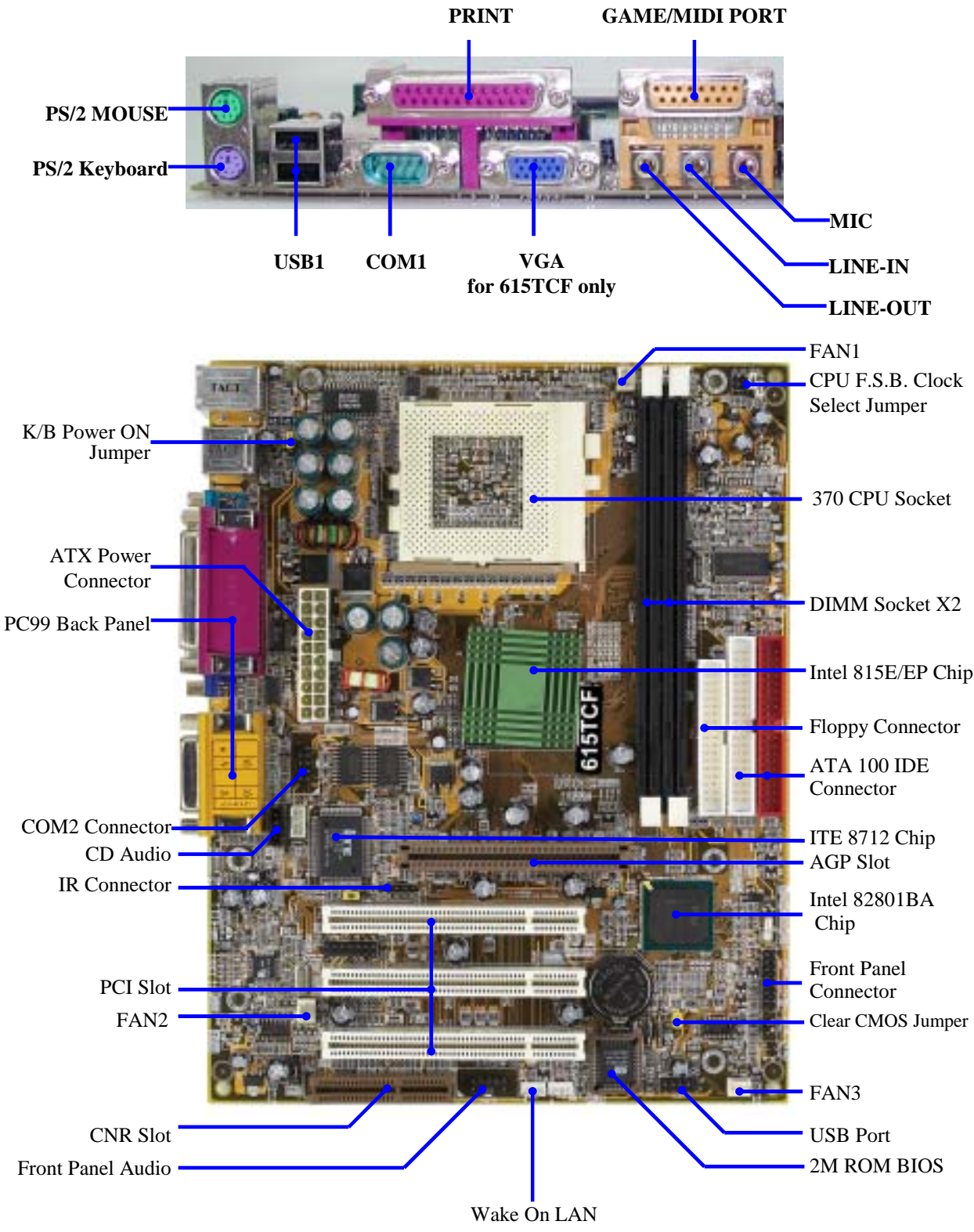

Jumpers

Jumper	Name	Description	Page
JS1, JS2	CPU & SDRAM Frequency Setting	3-pin Block	p.7



JS3, JS4		2-pin Block	
JK1	Keyboard Power ON Function Setting	3-pin Block	p.7
JBAT	CMOS RAM Clear	3-pin Block	p.8

Connectors

Connector	Name	Description	Page
ATX-PWR	ATX Power Connector	20-pin Block	p.17
PS2 KB/MOUSE	PS/2 Mouse & PS/2 Keyboard Connector	6-pin Female	p.17
USB1	USB Port Connector	4-pin Connector	p.17
PRINTER	Parallel Port Connector	25-pin Female	p.17
VGA	VGA Port Connector	15-pin Female	p.17
GAME	Audio/Game Connector	3 phone jack+15-pin Connector	p.17
COM1	Serial Port COM1 Connector	9-pin Connector	p.18
FLOPPY	Floppy Driver Connector	34-pin Block	p.18
IDE1	Primary IDE Connector	40-pin Block	p.18
IDE2	Secondary IDE Connector	40-pin Block	p.18

Headers

Header	Name	Description	Page
COM2	COM2 Headers	10-pin Block	p.19
USB2	USB Port Headers	10-pin Block	p.19
IDELED	IDE activity LED	2-pin Block	p.20
TBLED	Turbo LED switch	2-pin Block	p.20
RESET	Reset switch lead	2-pin Block	p.20
KEYLOCK	Keyboard lock switch	2-pin Block	p.20
SPKR	Speaker connector	4-pin Block	p.20
PWR LED	Power LED	2-pin Block	p.20
PWR BTN	Power Button	2-pin Block	p.20
WOL	Wake On-LAN Headers	3-pin Block	p.20
FAN1,FAN2,FAN3	FAN Speed Headers	3-pin Block	p.21
IR	IR infrared module Headers	5-pin Block	p.21
AUDIO	Line-In/Out, MIC Header	9-pin Block for Front Panel	p.22
CDIN2	CD Audio-In Headers	4-pin Block	p.22

Expansion Sockets

Socket/Slot	Name	Description	Page
ZIF Socket 370	CPU Socket	370-pin FC-PGA/PPGA CPU Socket	p.12
DIMM1, DIMM2	DIMM Module Socket	168-pin DIMM Module Expansion Socket	p.14
PCI1, PCI2, PCI3	PCI Slot	32-bit PCI Local Bus Expansion slots	p.15
AGP	AIMM /AGP 4X Mode Slot	AIMM & AGP Expansion Slot	p.16
CNR	CNR Slot	Communication Network Riser Slot	



For 615TCF Only

Chapter 2

Hardware installation

2-1 Hardware installation Steps

Before using your computer, you had better complete the following steps:

1. Check motherboard setting
2. Install CPU
3. Install Memory
4. Install Expansion cards
5. Connect Ribbon cables, Panel wires, and power supply
6. Setup BIOS
7. Install software driver & utility

2-2 Checking Motherboard's Jumper Setting

1. CPU Host/SDRAM Clock setting (3-pin): JS1, JS2, JS3, JS4

The motherboard's CPU & SDRAM memory clock adjusted through jumper JS1, JS2, JS3 & JS4. Table as below:

CPU/SDRAM (MHz)	JS1	JS2	JS3	JS4
* AUTO	ON	ON	1-2	1-2
66/100 (default)	OFF	OFF	2-3	2-3
100/100	OFF	OFF	2-3	1-2
133/100	OFF	OFF	1-2	1-2
133/133	OFF	OFF	1-2	2-3

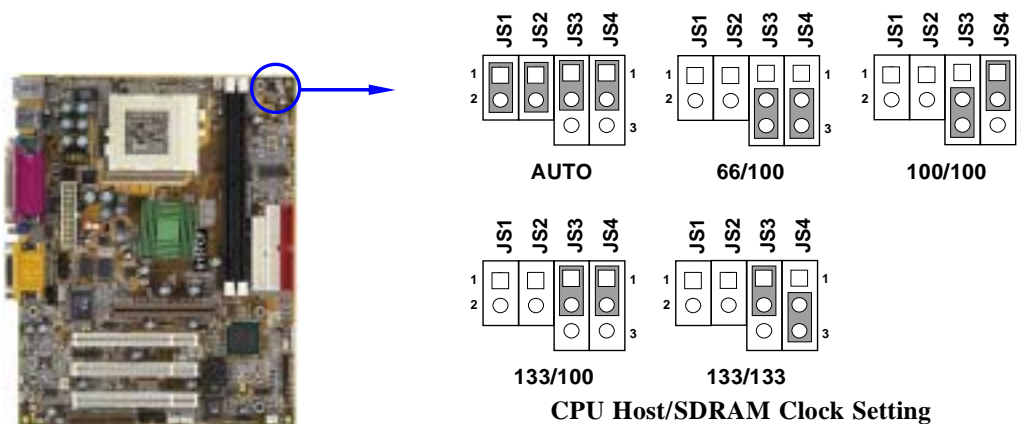

- * When jumper setting Auto it only can support CPU/SDRAM frequency at 66/100, 100/100, 133/100 MHz, we recommend setting 133/133 manually when use F.S.B. 133MHz CPU to increase performance.

In "Miscellaneous Control" section of CMOS Setup Utility, you can increase the CPU clock step by step increase for over clocking possibility. Please refer to [page 13](#) for more details.

2. Keyboard Power On Function setting (3-pin) : JK1

This allows you to disable the keyboard power on function. Set the jumper to enabled or disabled if you wish to use your keyboard (by pressing < >) to power on

your computer, this feature requires an ATX power supply that can supply at least 300mA on the +5VSB lead. The default is set on disable.

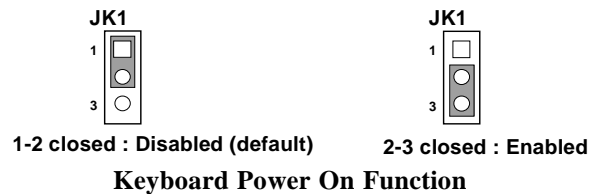
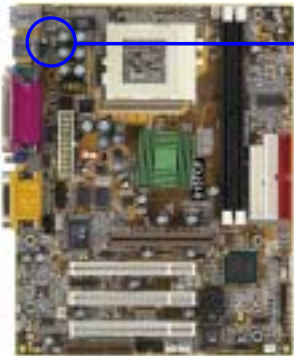

3. CMOS RAM Clear (3-pin) : JBAT

A battery must be used to retain the motherboard configuration in CMOS RAM short 1-2 pins of JBAT to store the CMOS data.

To clear the CMOS, follow the procedure below:

1. Turn off the system and unplug the AC power
2. Remove ATX power cable from ATX power connector
3. Locate JBAT and short pins 2-3 for a few seconds
4. Return JBAT to its normal setting by shorting pins 1-2
5. Connect ATX power cable back to ATX power connector

Note: When should clear CMOS

1. *Troubleshooting*
2. *Forget password*
3. *After over clocking system boot fail*

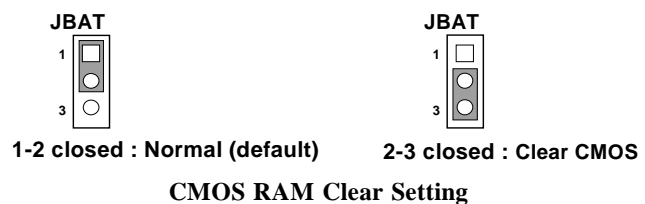
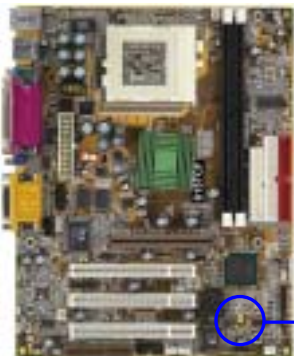

2-3 Install CPU

2-3-1 Glossary

Chipset (core logic) - two or more integrated circuits which control the interfaces between the system processor, RAM, I/O devices, and adapter cards.

Processor socket - the socket used to mount the system processor on the motherboard.

Slot (AGP, PCI, ISA, RAM) - the slots used to mount adapter cards and system RAM.

AGP - Accelerated Graphics Port - a high speed interface for video cards; runs at 1X (66MHz), 2X (133MHz), or 4X (266MHz).

PCI - Peripheral Component Interconnect - a high speed interface for video cards, sound cards, network interface cards, and modems; runs at 33MHz.

Serial Port - a low speed interface typically used for mouse and external modems.

Parallel Port - a low speed interface typically used for printers.

PS/2 - a low speed interface used for mouse and keyboards.

USB - Universal Serial Bus - a medium speed interface typically used for mouse, keyboards, scanners, and some digital cameras.

Sound (interface) - the interface between the sound card or integrated sound connectors and speakers, MIC, game controllers, and MIDI sound devices.

BIOS (Basic Input/Output System) - the program logic used to boot up a computer and establish the relationship between the various components.

Driver - software, which defines the characteristics of a device for use by another device or other software.

Processor - the "Central Processing Unit" (CPU); the principal integrated circuit used for doing the "computing" in "personal computer"

Front Side Bus Frequency

The working frequency of the motherboard, which is generated by the clock generator for CPU, DRAM and PCI BUS.

CPU L2 Cache

The flash memory inside the CPU, normally Pentium III CPU has 256K or above, while Celeron CPU will have 128K.

The way to recognize the specification of CPU from the packing Pentium III 370 pins FC-PGA

On the surface of the CPU as shown on the right picture, under the word of "PENTIUM III" the code is:

RB 80526 P2 866 256



-
-
- RB** : FC-PGA packing
 - P2** : P2-133MHz front side bus frequency
PY-100MHz front side bus frequency
 - 866** : CPU internal frequency, where here is 866MHz
 - 256** : the size of L2 cache, where here is 256K

Celeron FC-PGA

On the surface of the CPU as shown on the right picture, under the word of “Celeron” the code is:

566/128/66/1.5V

- 566** : CPU internal frequency, where here is 566MHz
- 128** : the size of L2 cache, where here is 128K
- 66** : front side bus frequency, where here is 66MHz
- 1.5V** : the voltage for the CPU



2-3-2 Setting CPU Bus Clock & Memory Clock Jumper

Setting the front side bus frequency and SDRAM frequency

The motherboard uses jumper JS2 and JS3 for the front side bus frequency and SDRAM frequency setting as shown from the table below:

CPU/SDRAM (MHz)	JS1	JS2	JS3	JS4
AUTO	ON	ON	1-2	1-2
66/100 (default)	OFF	OFF	2-3	2-3
100/100	OFF	OFF	2-3	1-2
133/100	OFF	OFF	1-2	1-2
133/133	OFF	OFF	1-2	2-3

Example: Using a Pentium® III 866 CPU with front side bus frequency of 133MHz and PC-133 SDRAM module, the setting of JS3 will be 1-2 and JS4 will be 2-3. This sets both CPU BUS CLOCK and SDRAM CLOCK to be 133MHz.

For experience user looking for over clocking possibility, please refer to sec 2-3-4.

2-3-3 Install CPU

This motherboard provides a ZIF socket 370. The CPU that comes with the motherboard should have a cooling FAN attached to prevent overheating. If this is not the case, then purchase a correct cooling FAN before you turn on your system.

WARNING! Be sure that there is sufficient air circulation across the processor's heatsink and CPU cooling FAN is working correctly, otherwise it may cause the processor and motherboard overheat and damage, you may install an auxiliary cooling FAN, if necessary.

To install a CPU, first turn off your system and remove its cover. Locate the ZIF socket and open it by first pulling the level sideways away from the socket then upward to a 90-degree angle. Insert the CPU with the correct orientation as shown below. The notched corner should point toward the end of the level. Because the CPU has a corner pin for two of the four corners, the CPU will only fit in the orientation as shown.

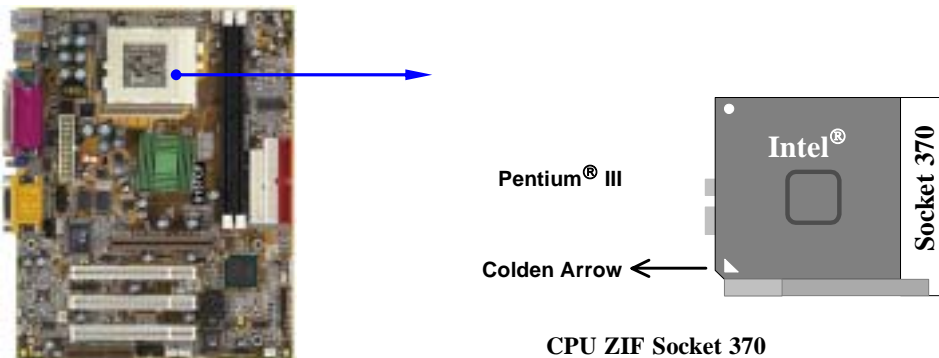

When you put the CPU into the ZIF socket. No forces require to insert of the CPU, then press the level to locate position slightly without any extra force.

2-3-4 Over clock Running

WARNING! This section is for experienced motherboard installer only. Over clocking can result in system instability or even shortening life of the processor.

After setting the Jumper JS3, JS4 you can choose over clock running by BIOS CMOS SETUP UTILITY. When you entered CMOS SETUP UTILITY, choose "Miscellaneous Control" you will see the screen as below then.

You can choose the situation you want to try.

CPU/SDRAM (MHz)	JS1	JS2	JS3	JS4
AUTO	ON	ON	1-2	1-2
66/100 (default)	OFF	OFF	2-3	2-3
100/100	OFF	OFF	2-3	1-2
133/100	OFF	OFF	1-2	1-2

133/133	OFF	OFF	1-2	2-3
---------	-----	-----	-----	-----

CMOS Setup Utility - Copyright(C) 1984-2000 Award Software
Miscellaneous Control

CyrixIII Clock Ratio Default Auto Detect DIMM/PCI Clk Enabled Spread Spectrum Disabled ** Current Host Clock is 66Mhz ** CPU Host/SDRAM/PCI Clock 66/100/33Mhz CPU Clock Ratio X 3	Item Help Menu Level > CyrixIII CPU Ratio Adjust
Move Enter:Select Item +/-/PU/PD:Value F10:Save ESC:Exit F1:General Help F5:Previous Values F6:Optimized Defaults F7:Standard Defaults	

By press PageDown/PageUp key you can change the CPU Host/SDRAM/PCI Clock
 When jumper setting CPU Host Clock 66MHz you can choose 66/100/33~99/133/49MHz
 When jumper setting CPU Host Clock 100MHz you can choose 100/100/33~132/132/44MHz
 When jumper setting CPU Host Clock 133MHz you can choose 133/133/33~166/166/41MHz

WARNING! The Design of this motherboard follows chipset and CPU vender's design guideline. Any attempts to push beyond product specification are not recommended and you are taking your own risk to damage your system or important data. Before over clocking, you must make sure your components are able to tolerate such abnormal setting, especially CPU, memory, hard disks, and VGA cards.

2-4 Install Memory

This motherboard provides **two** 168-pin DUAL INLINE MEMORY MODULES (DIMM) sites for memory expansion available from minimum memory size of 32MB to maximum memory size of 512MB SDRAM.

Valid Memory Configurations

DIMM SDRAM Clock	DIMM1	DIMM2
100MHz	DS	DS
	SS	SS
133MHz	DS	DS

	SS	SS
--	----	----

According the specification when SDRAM clock is 133MHz only can support 2 pcs Double Sided DIMMs

DS : Double Sided DIMM

SS : Single Sided DIMM

NOTE! Make sure the total installed memory does not exceeds 512MB, otherwise the system may hang during startup.

Generally, installing SDRAM modules to your motherboard is very easy, you can refer to figure 2-4 to see what a 168-Pin PC100 & PC133 SDRAM module looks like.

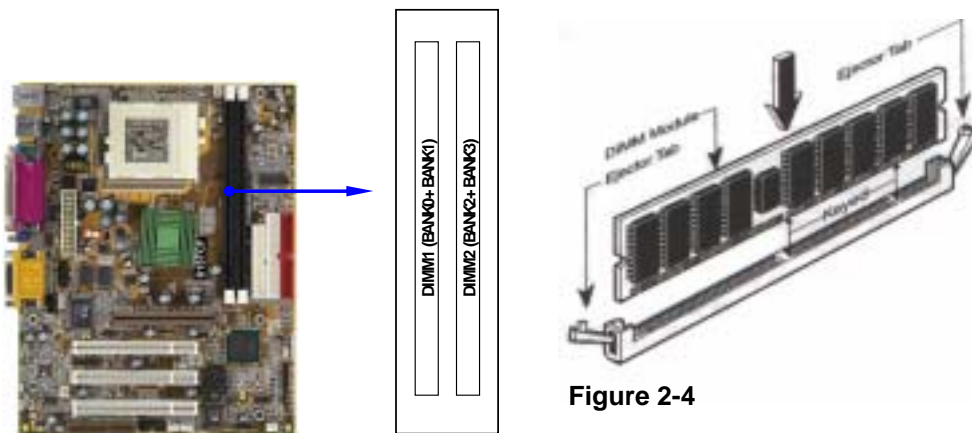

Figure 2-4

NOTE! When you install DIMM module fully into the DIMM socket the eject tab should be locked into the DIMM module very firmly and fit into its indentation on both sides.

WARNING! For the SDRAM CLOCK is set at 133MHz, use only PC133-compliant DIMMs. When this motherboard operate at 133Mhz, most system will not even boot if non-compliant modules are used because of the strict timing issues, if your DIMM are not PC133-compliant, set the SDRAM clock to 100MHz to ensure system stability.

2-5 Expansion Cards

WARNING! Turn off your power when adding or removing expansion cards or other system components. Failure to do so may cause severe damage to both your motherboard and expansion cards.

2-5-1 Procedure For Expansion Card Installation

1. Read the documentation for your expansion card and make any necessary hardware or software setting for your expansion card such as jumpers.
2. Remove your computer's cover and the bracket plate on the slot you intend to use.
3. Align the card's connectors and press firmly.
4. Secure the card on the slot with the screen you remove above.
5. Replace the computer system's cover.
6. Set up the BIOS if necessary.
7. Install the necessary software driver for your expansion card.

2-5-2 Assigning IRQs For Expansion Card

Some expansion cards need an IRQ to operate. Generally, an IRQ must exclusively assign to one use. In a standard design, there are 16 IRQs available but most of them are already in use.

Standard Interrupt Assignments

IRQ	Priority	Standard function
0	1	System Timer
1	2	Keyboard Controller
2	N/A	Programmable Interrupt
3 *	11	Communications Port (COM2)
4 *	12	Communications Port (COM1)
5 *	13	Sound Card (sometimes LPT2)
6	14	Floppy Disk Controller
7 *	15	Printer Port (LPT1)
8	3	System CMOS/Real Time Clock
9 *	4	ACPI Mode when enabled
10 *	5	IRQ Holder for PCI Steering
11 *	6	IRQ Holder for PCI Steering
12 *	7	PS/2 Compatible Mouse Port
13	8	Numeric Data Processor
14 *	9	Primary IDE Channel
15 *	10	Secondary IDE Channel

* These IRQs are usually available for ISA or PCI devices.

2-5-3 Interrupt Request Table For This Motherboard

Interrupt request are shared as shown the table below:

	INT A	INT B	INT C	INT D	INT E	INT F	INT G	INT H
Slot 1	√							
Slot 2		√						
Slot 3			√					

Onboard VGA								
Onboard USB 0								√
Onboard USB 1				√				
AC97/MC97		√						

IMPORTANT! If using PCI cards on shared slots, make sure that the drivers support “Shared IRQ” or that the cards don’t need IRQ assignments. Conflicts will arise between the two PCI groups that will make the system unstable or cards inoperable.

Note *1 Either AGP slot or onboard VGA can be active at the same time.

2-5-4 AIMM/AGP Slot

In both 615TCF and 615TCS you can plug a 4X AGP VGA Card into the AIMM/AGP Slot and the 615TCF will disable on board VGA automatically once you plug any VGA Card into the motherboard. The special function of 615TCF is support AGP Inline Memory Module in AIMM/AGP Slot. By plug in AGP Inline Memory Module which with 4MB of 133MHz SDRAM display cache, it will improve on board video graphic quality. If you are using 615TCF, on board VGA will disabled automatically once you plug any VGA card into the motherboard.

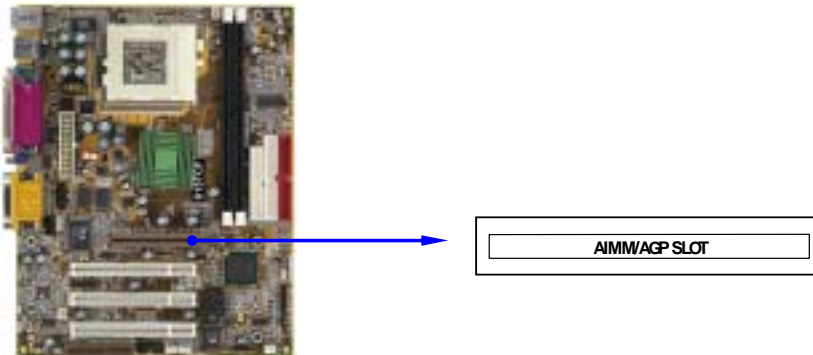

2-6 Connectors, Headers

2-6-1 Connectors

(1) Power Connector (20-pin block) : ATX-PWR

ATX Power Supply connector. This is a new defined 20-pins connector that usually comes with ATX case. The ATX Power Supply allows to use soft power on momentary switch that connect from the front panel switch to 2-pins Power On jumper pole on the motherboard. When the power switch on the back of the

ATX power supply turned on, the full power will not come into the system board until the front panel switch is momentarily pressed. Press this switch again will turn off the power to the system board.

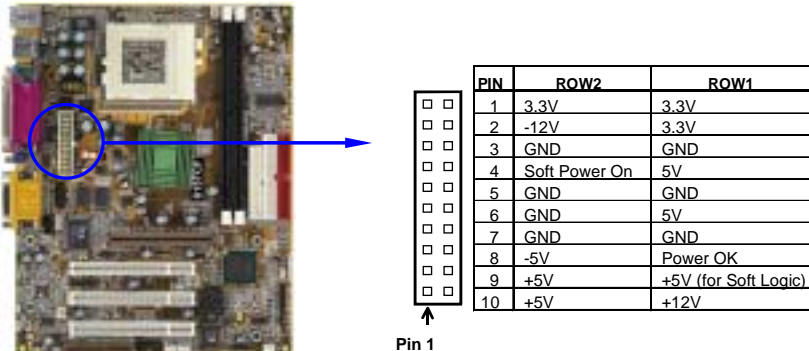

(2) PS/2 Mouse & PS/2 Keyboard Connector: PS2 KB/MOUSE

If you are using a PS/2 mouse, you must purchase an optional PS/2 mouse set which connects to the 5-pins block and mounts to an open slot on your computer's case.

(3) USB Port connector: USB1

The connectors are 4-pins connector that connect USB devices to the system board.

(4) Parallel Port Connector (25-pin female): PRINTER

Parallel Port connector is a 25-pin D-Subminiature Receptacle connector. The On-board Parallel Port can be disabled through the BIOS SETUP. Please refer to Chapter 3 "INTEGRATED PERIPHERALS SETUP" section for more detail information.

(5) VGA Connector (15-pin female): VGA (615TCF Only)

(6) Audio and Game Connector : GAME

This Connector are 3 phone Jack for LINE-OUT, LINE-IN, MIC and a 15-pin D-Subminiature Receptacle Connector for joystick/MIDI Device.

Line-out : Audio output to speaker

Line-in : Audio input to sound chip

MIC : Microphone Connector

Game/MIDI : For joystick or MIDI Device

(7) Serial Port COM1: COM1

COM1 is the 9-pin D-Subminiature mail connector. The On-board serial port can be disabled through BIOS SETUP. Please refer to Chapter 3 "INTEGRATED PERIPHERALS SETUP" section for more detail information.

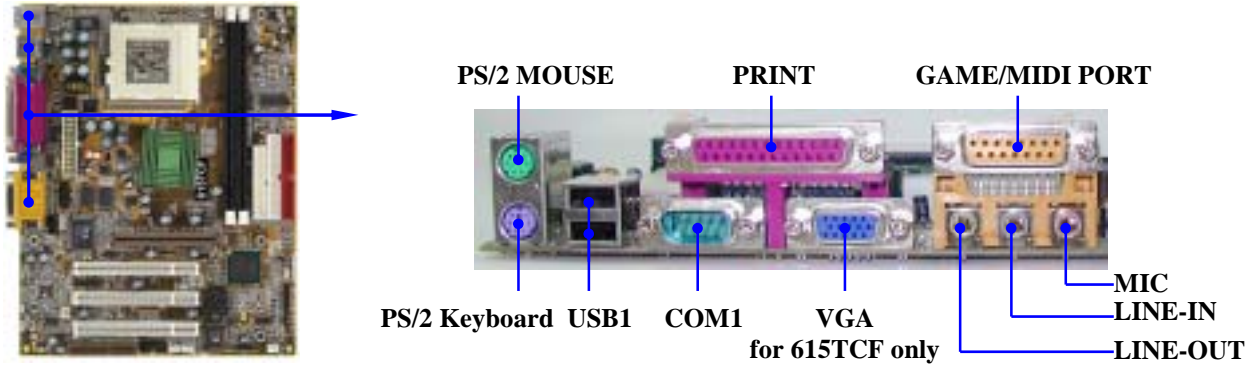

(8) Floppy drive Connector (34-pin block): FLOPPY

This connector supports the provided floppy drive ribbon cable. After connecting the single plug end to motherboard, connect the two plugs at other end to the floppy drives.

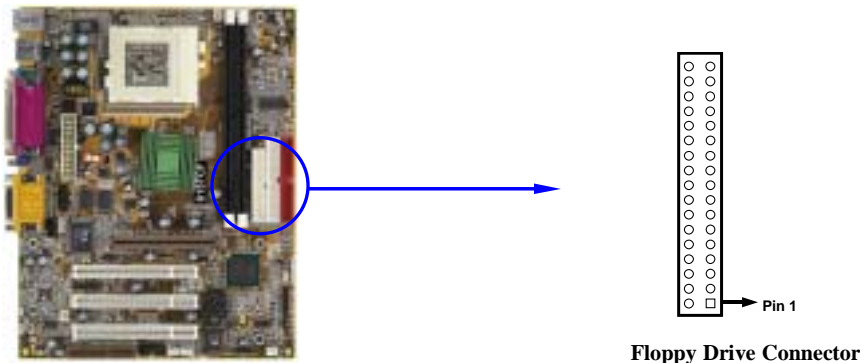

(9) Primary IDE Connector (40-pin block): IDE1

This connector supports the provided IDE hard disk ribbon cable. After connecting the single plug end to motherboard, connect the two plugs at other end to your hard disk(s). If you install two hard disks, you must configure the second drive to Slave mode by setting its jumpers accordingly. Please refer to the documentation of your hard disk for the jumper settings.

(10) Secondary IDE Connector (40-pin block): IDE2

This connector connects to the next set of Master and Slave hard disks. Follow the same procedure described for the primary IDE connector. You may also configure two hard disks to be both Masters using one ribbon cable on the primary IDE connector and another ribbon cable on the secondary IDE connector.

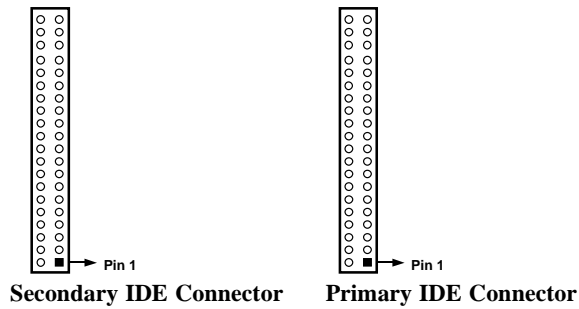
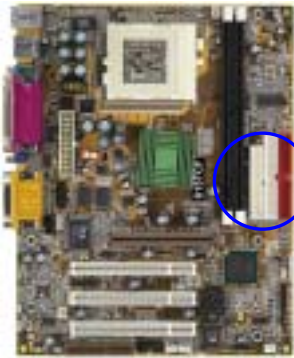

- Two hard disks can be connected to each connector. The first HDD is referred to as the “Master” and the second HDD is referred to as the “Slave”.
- For performance issues, we strongly suggest you don’t install a CD-ROM or DVD-ROM drive on the same IDE channel as a hard disk. Otherwise, the system performance on this channel may drop.

2-6-2 Headers

(1) COM2 Headers (10-pin) : COM2

This board has another serial port COM2, it come with cable providing serial port COM2.

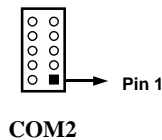
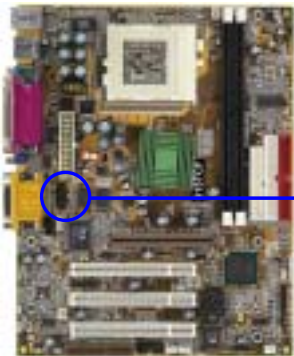

Note: Orient the read marking on the COM2 ribbon cable to pin 1

(2) USB Port Headers (10-pin) : USB2

These headers are used for connecting the additional USB port plug. By attaching an option USB cable, your can be provided with two additional USB plugs affixed to the back panel.

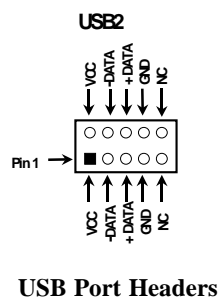

(3) **IDE Activity LED: IDELED**

This connector connects to the hard disk activity indicator light on the case.

(4) **Turbo LED switch: TBLED**

Since the motherboard's turbo function is always on. The turbo LED will remain constantly on while the system power is on. You may wish to connect the Power LED from the system case to this lead. See the figure below.

(5) **Reset switch lead: RESET**

This 2-pin connector connects to the case-mounted reset switch for rebooting your computer without having to turn off your power switch. This is a preferred method of rebooting in order to prolong the life of the system's power supply. See the figure below.

(6) **Keyboard lock switch: KEYLOCK**

This 2-pin connector connects to the case-mounted key switch for locking the keyboard for security purposes.

(7) **Speaker connector: SPKR**

This 4-pin connector connects to the case-mounted speaker. See the figure below.

(8) **Power LED: PWR LED**

The Power LED is light on while the system power is on. Connect the Power LED from the system case to this pin.

(9) **Power switch: PWR BTN**

This 2-pin connector connects to the case-mounted power switch to power ON/OFF the system.

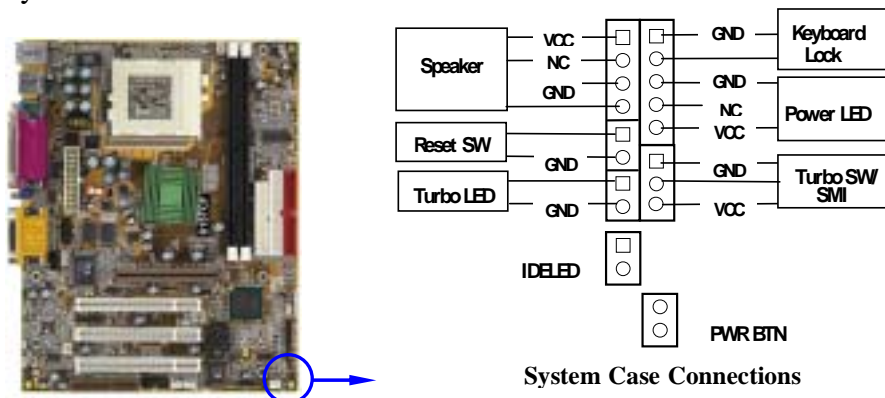

(10) **Wake On-LAN Headers (3-pin) : WOL**

This connector connects to a LAN card with a WAKE ON-LAN output. This connector power up the system when a wake up signal is received through the LAN card.

NOTE: This feature requires that BIOS Wake-Up by PCI Card is enabled.

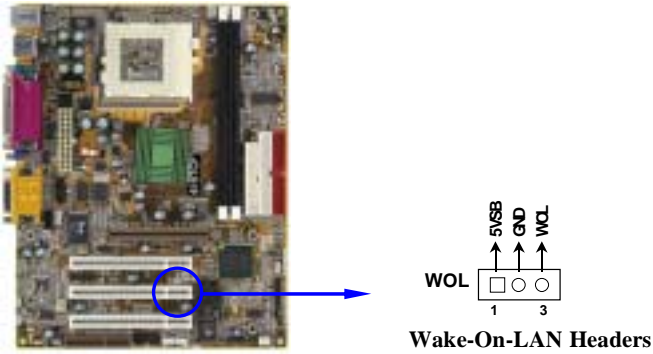

(11) FAN Speed Headers (3-pin) : FAN1, FAN2, FAN3

These connectors support cooling fans of 350mA (4.2 Watts) or less, depending on the fan manufacturer, the wire and plug may be different. The red wire should be positive, while the black should be ground. Connect the fan's plug to the board taking into consideration the polarity of connector.

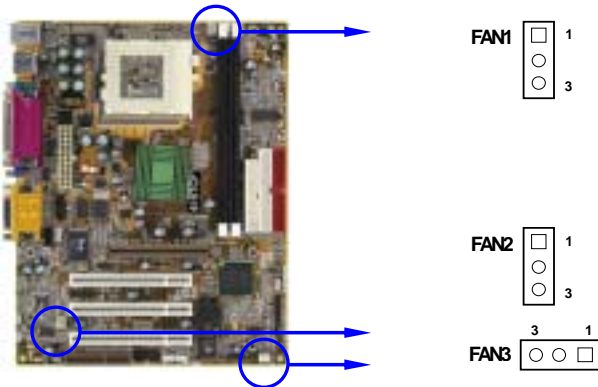

(12) IR infrared module Headers (5-pin) : IR

This connector supports the optional wireless transmitting and receiving infrared module. You must configure the setting through the BIOS setup to use the IR function.

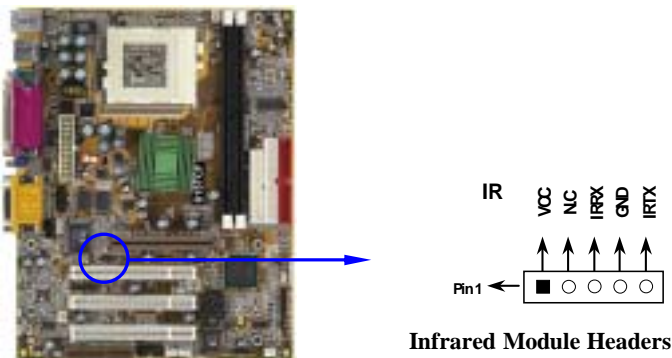

(13) Audio Front Panel Header (9-pin): AUDIO

This header connect to Front Panel Line-In, Line-out, MIC connector with cable.

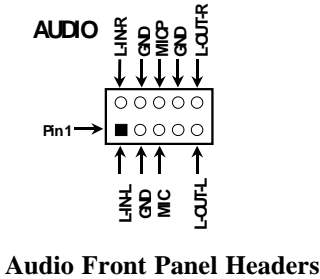

(14) CD Audio-In Headers (4-pin) : CDIN2

CDIN2 is the connector for CD-Audio Input signal. Please connect it to CD-ROM CD-Audio output connector.

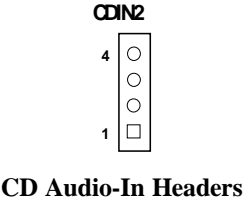
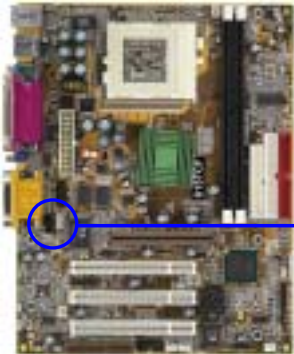

2-7 Starting Up Your Computer

1. After all connections are made, close your computer case cover.
2. Be sure all the switch are off, and check that the power supply input voltage is set to proper position, usually in-put voltage is 220V~240V or 110V~120V depending on your country's voltage used.
3. Connect the power supply cord into the power supply located on the back of your system case according to your system user's manual.
4. Turn on your peripheral as following order:
 - a. Your monitor.
 - b. Other external peripheral (Printer, Scanner, External Modem etc...)
 - c. Your system power. For ATX power supplies, you need to turn on the power supply and press the ATX power switch on the front side of the case.
5. The power LED on the front panel of the system case will light. The LED on the monitor may light up or switch between orange and green after the system is on. If it complies with green standards or if it is has a power standby feature. The system will then run power-on test. While the test are running, the BIOS will alarm beeps or additional message will appear on the screen.

If you do not see any thing within 30 seconds from the time you turn on the power. The system may have failed on power-on test. Recheck your jumper settings and connections or call your retailer for assistance.

Beep	Meaning
One short beep when displaying logo	No error during POST
Long beeps in an endless loop	No DRAM install or detected
One long beep followed by three short beeps	Video card not found or video card memory bad
High frequency beeps when system is working	CPU overheated System running at a lower frequency

6. During power-on, press <Delete> key to enter BIOS setup. Follow the instructions in BIOS SETUP.
7. **Power off your computer:** You must first exit or shut down your operating system before switch off the power switch. For ATX power supply, you can press ATX power switching after exiting or shutting down your operating system. If you use Windows 9X, click “**Start**” button, click “**Shut down**” and then click “**Shut down the computer?**” The power supply should turn off after windows shut down.

Chapter 3

Introducing BIOS

The BIOS is a program located on a Flash Memory on the motherboard. This program is a bridge between motherboard and operating system. When you start the computer, the BIOS program gain control. The BIOS first operates an auto-diagnostic test called POST (power on self test) for all the necessary hardware, it detects the entire hardware device and configures the parameters of the hardware synchronization. Only when these tasks are completed done it gives up control of the computer to operating system (OS). Since the BIOS is the only channel for hardware and software to communicate, it is the key factor for system stability, and in ensuring that your system performance as its best.

In the BIOS Setup main menu of Figure 3-1, you can see several options. We will explain these options step by step in the following pages of this chapter, but let us first see a short description of the function keys you may use here:

- Press <Esc> to quit the BIOS Setup.
- Press ↑↓←→ (up, down, left, right) to choose, in the main menu, the option you want to confirm or to modify.
- Press <F10> when you have completed the setup of BIOS parameters to save these parameters and to exit the BIOS Setup menu.
- Press Page Up/Page Down or +/- keys when you want to modify the BIOS parameters for the active option.

3-1 Entering Setup

Power on the computer and by pressing immediately allows you to enter Setup.

If the message disappears before your respond and you still wish to enter Setup, restart the system to try again by turning it OFF then ON or pressing the “RESET” button on the system case. You may also restart by simultaneously pressing <Ctrl>, <Alt> and <Delete> keys. If you do not press the keys at the correct time and the system does not boot, an error message will be displayed and you will again be asked to

Press <F1> to continue, <Ctrl-Alt-Esc> or to enter Setup

Integrated Peripherals

Use this menu to specify your settings for integrated peripherals.

Power Management Setup

Use this menu to specify your settings for power management.

PnP/PCI configurations

This entry appears if your system supports PnP/PCI.

PC Health Status

This entry shows your PC health status.

Miscellaneous Control

Use this menu to specify your settings for Miscellaneous Control.

Load Optimized Defaults

Use this menu to load the BIOS default values that are factory settings for optimal performances system operations.

Load Standard Defaults

Use this menu to load the BIOS default values for the minimal/stable performance system operation.

Set Supervisor/User Password

Use this menu to set User and Supervisor Passwords.

Save & Exit Setup

Save CMOS value changes to CMOS and exit setup.

Exit Without Saving

Abandon all CMOS value changes and exit setup.

3-4 Standard CMOS Features

The items in Standard CMOS Setup Menu are divided into several categories. Each category includes no, one or more than one setup items. Use the arrow keys to highlight the item and then use the <PgUp> or <PgDn> keys to select the value you want in each item.

CMOS Setup Utility - Copyright(C) 1984-2000 Award Software

Standard CMOS Features

Date (mm:dd:yy)	Wed, Jul, 12 2000	Item Help	
Time (hh:mm:ss)	16 : 18 : 49		
IDE Primary Master		Menu Level > Change the day, moth, Year and century	
IDE Primary Slave			
IDE Secondary Master			
IDE Secondary Slave			
Drive A	1.4M, 3.25 in.		
Drive B	None		
Video	EGA/VGA		
Halt On	All Errors		
Base Memory	640K		
Extended Memory	64512K		
Total Memory	65536K		
Move Enter:Select Item +/-/PU/PD:Value F10:Save ESC:Exit F1:General Help			
F5:Previous Values F6:Optimized Defaults F7:Standard Defaults			

Date

The date format is <day><month><date><year>.

Day Day of the week, from Sun to Sat, determined by BIOS. Read-only.

Month The month from Jan. through Dec.

Date The date from 1 to 31 can be keyed by numeric function keys.

Year The year depends on the year of the BIOS.

Time

The time format is <hour><minute><second>.

Primary Master/Primary Slave

Secondary Master/Secondary Slave

Press PgUp/<+> or PgDn/<-> to select Manual, None, Auto type. Note that the specifications of your drive must match with the drive table. The hard disk will not work properly if you enter improper information for this category. If your hard disk drive type is not matched or listed, you can use Manual to define your own drive type manually.

If you select Manual, related information is asked to be entered to the following items. Enter the information directly from the keyboard. This information should be provided in the documentation from your hard disk vendor or the system manufacturer.

If the controller of HDD interface is SCSI, the selection shall be "None".

If the controller of HDD interface is CD-ROM, the selection shall be “None”

Access Mode The settings are Auto Normal, Large, and LBA.
Cylinder number of cylinders
Head number of heads
Precomp write precomp
Landing Zone landing zone
Sector number of sectors

3-5 Advanced BIOS Features

CMOS Setup Utility - Copyright(C) 1984-2000 Award Software
 Advanced BIOS Features

Anti-Virus Protection	Disabled	Item Help	
PhoenixNet Support	Disabled		
CPU L1 Cache	Enabled	Menu Level > Allows you to choose the VIRUS warning feature for IDE Hard disk boot sector protection. If this function is enabled and someone attempt to write data into this area, BIOS will show a warning message on screen and alarm beep	
CPU L2 Cache	Enabled		
CPU L2 Cache ECC Checking	Disabled		
Processor Number Feature	Enabled		
Quick Power On Self Test	Enabled		
First Boot Device	Floppy		
Second Boot Device	HDD-0		
Third Boot Device	LS120		
Fouth Boot Device	Disabled		
Swap Floppy Drive	Disabled		
Boot Up Floppy Seek	Enabled		
Boot Up NumLock Status	On		
Gate A20 Option	Fast		
Typematic Rate Setting	Disabled		
Typematic Rate (Chars/Sec)	6		
Typematic Delay (Msec)	250		
Security Option	Setup		
OS Select For DRAM > 64MB	Non-OS2		
HDD S.M.A.R.T. Capability	Disabled		
Report No FDD For Win 95	No		
Move Enter:Select Item +/-/PU/PD=Value F10:Save ESC:Exit F1:General Help F5:Previous Values F6:Optimized Defaults F7:Standard Defaults			

Anti-Virus Protection

Allows you to choose the VIRUS Warning feature for IDE Hard Disk boot sector protection. If this function is enabled and someone attempt to write data into this area, BIOS will show a warning message on screen and alarm beep.

Disabled (default) No warning message to appear when anything attempts to access the boot sector or hard disk partition table.

Enabled Activates automatically when the system boots up causing a warning message to appear when anything attempts to access the boot sector of hard disk partition table.

CPU L1 Cache

The default value is Enabled.

Enabled (default) Enable cache

Disabled Disable cache

Note: The L1 cache is built in the processor.

CPU L2 Cache

Choose Enabled or Disabled. This option enables the Level 2 cache memory.

CPU L2 Cache ECC Checking

Choose Enabled or Disabled. This option enables the Level 2 cache memory ECC (error check correction).

Processor Number Feature

This option is for Pentium® III processor. During Enabled, this will check the CPU Serial number. Disabled this option if you don't want the system to know the Serial number.

Quick Power On Self-Test

This category speeds up Power On Self Test (POST) after you power on the computer. If this is set to Enabled. BIOS will shorten or skip some check items during POST.

Enabled (default) Enable quick POST

Disabled Normal POST

First/Second/Third/Fourth Boot Device

The BIOS attempts to load the operating system from the devices in the sequence selected in these items. The settings are Floppy, LS/ZIP, HDD-0/HDD-1/HDD-3, SCSI, CDROM, LAN and Disabled.

Swap Floppy Drive

Switches the floppy disk drives between being designated as A and B. Default is Disabled.

Boot Up Floppy Seek

During POST, BIOS will determine if the floppy disk drive installed is 40 or 80 tracks. 360K type is 40 tracks while 760K, 1.2M and 1.44M are all 80 tracks.

Boot Up NumLock Status

The default value is On.

On (default) Keypad is numeric keys.

Off Keypad is arrow keys.

Gate A20 Option

Normal The A20 signal is controlled by keyboard controller or chipset hardware.

Fast (default) The A20 signal is controlled by port 92 or chipset specific method.

Typematic Rate Setting

Keystrokes repeat at a rate determined by the keyboard controller. When enabled, the typematic rate and typematic delay can be selected. The settings are: Enabled/Disabled.

Typematic Rate (Chars/Sec)

Sets the number of times a second to repeat a keystroke when you hold the key down. The settings are: 6, 8, 10, 12, 15, 20, 24, and 30.

Typematic Delay (Msec)

Sets the delay time after the key is held down before it begins to repeat the keystroke. The settings are 250, 500, 750, and 1000.

Security Option

This category allows you to limit access to the system and Setup, or just to Setup.

System The system will not boot and access to Setup will be denied if the correct password is not entered at the prompt.

Setup (default) The system will boot, but access to Setup will be denied if the correct password is not entered prompt.

OS Select For DRAM > 64MB

Allows OS2[®] to be used with >64MB or DRAM. Settings are Non-OS/2 (default) and OS2. Set to OS/2 if using more than 64MB and running OS/2[®].

Report No FDD For Win 95

Whether report no FDD for Win 95 or not. The settings are: Yes, No.

3-6 Advanced Chipset Features

The Advanced Chipset Features Setup option is used to change the values of the chipset registers. These registers control most of the system options in the computer.

CMOS Setup Utility - Copyright(C) 1984-2000 Award Software
Advanced Chipset Features

On-Chip VGA Setting Press Enter SDRAM Timing Setting Press Enter System BIOS Cacheable Enabled Video BIOS Cacheable Enabled Memory Hole at 15M-16M Disabled CPU Latency Timer Disabled Delayed Transaction Disabled AGP Mode Select Auto AGP Graphics Aperture Size 64MB		Item Help
		Menu Level >
Move Enter:Select Item +/-/PU/PD:Value F10:Save ESC:Exit F1:General Help F5:Previous Values F6:Optimized Defaults F7:Standard Defaults		

Note: Change these settings only if you are familiar with the chipset.

SDRAM Timing Setting

Please refer to section 3-6-1

System BIOS Cacheable

Selecting Enabled allows caching of the system BIOS ROM at F0000h-FFFFFFh, resulting in better system performance. However, if any program writes to this memory area, a system error may result. The settings are: Enabled and Disabled.

Video BIOS Cacheable

Select Enabled allows caching of the video BIOS, resulting in better system performance. However, if any program writes to this memory area, a system error may result. The settings are: Enabled and Disabled.

Memory Hole At 15M-16M

You can reserve this area of system memory for ISA adapter ROM. When this area is reserved, it cannot be cached. The user information of peripherals that need to use this area of system memory usually discusses their memory requirements. The settings are: Enabled and Disabled.

CPU Latency Timer

During Enabled, A deferrable CPU cycle will only be Deferred after it has been in a Snoop Stall for 31 clocks and another ADS# has arrived. During Disabled, A deferrable CPU cycle will be Deferred immediately after the GMCH receives another ADS#.

Delayed Transaction

The chipset has an embedded 32-bit posted write buffer to support delay transactions cycles. Select Enabled to support compliance with PCI specification version 2.1. The settings are: Enabled and Disabled.

On-Chip Video Window Size

This option enabled/disabled the on-chip video windows size for VGA driver use. The settings are: enabled, Disabled.

AGP Graphics Aperture Size

This option determines the effective size of the graphics aperture used in the particular PAC configuration. The AGP aperture is memory-mapped, while graphics data structure can reside in a graphics aperture. The aperture range should be programmed as not cacheable in the processor cache, accesses with the aperture range are forwarded to the main memory, then PAC will translate the original issued address via a translation table that is maintained on the main memory. The option allows the selection of an aperture size of 32MB, 64MB.

3-6-1 SDRAM Timing Setting

CMOS Setup Utility - Copyright(C) 1984-2000 Award Software

SDRAM Timing Setting

SDRAM CAS Latency Time	3	Item Help
SDRAM Cycle Time Tras/Trc	6/8	
SDRAM RAS-to-CAS Delay	3	Menu Level >> When set to "Auto", BIOS will program this Timing mainly by the SPD method. SPD means "Serial Presence Detect", which enables the BIOS to access the manufacturer settings stored in DRAM module.
SDRAM RAS Precharge Time	3	
DRAM CTL Buffer strengths	Normal	
DRAM MD Buffer strengths	Normal	
Move Enter:Select Item +/-/PU/PD:Value F10:Save ESC:Exit F1:General Help		
F5:Previous Values F6:Optimized Defaults F7:Standard Defaults		

SDRAM CAS Latency Time

When synchronous DRAM is installed, the number of clock cycles of CAS latency depends on the DRAM timing. The settings are: 2 and 3.

SDRAM Cycle Time Tras/Trc

Select the number of SCLKs for an access cycle. The settings are: 5/7 and 6/8.

SDRAM RAS-to-CAS Delay

This field let's you insert a timing delay between the CAS and RAS strobe signals, used when DRAM is written to, read from, or refreshed. *Fast* gives faster performance; and *Slow* gives more stable performance. This field applies only when synchronous DRAM is installed in the system. The settings are: 2 and 3.

SDRAM RAS Precharge Time

If an insufficient number of cycles is allowed for the RAS to accumulate its charge before DRAM refresh, the refresh may be incomplete and the DRAM may fail to retain date. *Fast* gives faster performance; and *Slow* gives more stable performance. This field applies only when synchronous DRAM is installed in the system. The settings are: 2 and 3.

3-7 Integrated Peripherals

CMOS Setup Utility - Copyright(C) 1984-2000 Award Software
Integrated Peripherals

		Item Help
On-Chip IDE Function	Press Enter	
On-Chip SIO Function	Press Enter	
On-Chip Device Function	Press Enter	
Init Display First	PCI Slot	Menu Level >
Power On Function	BUTTON ONLY	
KB Power ON Password	Enter	
Hot Key Power ON	Ctrl-F1	
POWER After PWR-fail	off	
Move Enter:Select Item +/-/PU/PD:Value F10:Save ESC:Exit F1:General Help F5:Previous Values F6:Optimized Defaults F7:Standard Defaults		

On-Chip IDE Function

Please refer to section 3-7-1

On-Chip SIO Function

Please refer to section 3-7-2

On-Chip Device Function

Please refer to section 3-7-3

Init Display First

This item allows you to decide to activate whether PCI Slot or on-chip VGA first. The settings are: PCI Slot, AGP Slot, On-Chip VGA.

Power On Function

This function allows you to select the item to power on the system. The settings are: Button Only, Mouse Left, Mouse Right, Password, Hotkey, and keyboard 98.

Power After PWR-Fail

This option will determine how the system will power on after a power failure.

3-7-1 On-Chip IDE Function

CMOS Setup Utility - Copyright(C) 1984-2000 Award Software
On-Chip IDE Function

On-Chip Primary PCI IDE	Enabled	Item Help
On-Chip Secondary PCI IDE	Enabled	
IDE Primary Master PIO	Auto	Menu Level >>
IDE Primary Slave PIO	Auto	
IDE Secondary Master PIO	Auto	
IDE Secondary Slave PIO	Auto	
IDE Primary Master UDMA	Auto	
IDE Primary Slave UDMA	Auto	
IDE Secondary Master UDMA	Auto	
IDE Secondary Slave UDMA	Auto	
IDE 32-bit Transfer Mode	Enabled	
IDE HDD Block Mode	Enabled	
Delay For HDD (Secs)	0	
Move Enter:Select Item +/-/PU/PD:Value F10:Save ESC:Exit F1:General Help		
F5:Previous Values F6:Optimized Defaults F7:Standard Defaults		

On-Chip Primary/Secondary PCI IDE

The integrated peripheral controller contains an IDE interface with support for two IDE channels. Select *Enabled* to activate each channel separately. The settings are: Enabled and Disabled.

IDE Primary/Secondary Master/Slave PIO

The four IDE PIO (Programmed Input/Output) fields let you set a PIO mode (0-4) for each of the four IDE devices that the onboard IDE interface supports. Modes 0 through 4 provide successively increased performance. In Auto mode, the system automatically determines the best mode for each device. The settings are: Auto, Mode 0, Mode 1, Mode 2, Mode 3, Mode 4.

IDE Primary/Secondary Master/Slave UDMA

Ultra DMA/33 implementation is possible only if your IDE hard drive supports it and the operating environment includes a DMA driver (Windows 95 OSR2 or a third-party IDE bus master driver). If your hard drive and your system software both support Ultra DMA/33 and Ultra DMA/66, select Auto to enable BIOS support. The settings are: Auto, Disabled.

IDE HDD Block Mode

Block mode is also called block transfer, multiple commands, or multiple sector read/write. If your IDE hard drive supports block mode (most new drives do), select Enabled for automatic detection of the optimal number of block read/writes per sector the drive can support. The settings are: Enabled, Disabled.

3-7-2 On-Chip SIO Function

CMOS Setup Utility - Copyright(C) 1984-2000 Award Software
On-Chip SIO Function

Onboard FDD Controller	Enabled	Item Help
Onboard Serial Port 1	3F8/IRQ4	
Onboard Serial Port 2	2F8/IRQ3	
UART Mode Select	Normal	Menu Level >>
UR2 Duplex Mode	Half	
Onboard Parallel Port	378/IRQ7	
Parallel Port Mode	SPP	
ECP Mode Use DMA	3	
Move Enter:Select Item +/-/PU/PD:Value F10:Save ESC:Exit F1:General Help F5:Previous Values F6:Optimized Defaults F7:Standard Defaults		

Onboard FDC Controller

Select Enabled if your system has a floppy disk controller (FDD) installed on the system board and you wish to use it. If you install add-on FDC or the system has no floppy drive, select Disabled in this field. The settings are: Enabled and Disabled.

Onboard Serial Port 1/Port 2

Select an address and corresponding interrupt for the first and the second serial ports. The settings are: 3F8/IRQ4, 2E8/IRQ3, 3E8/IRQ4, 2F8/IRQ3, Disabled, Auto.

UART Mode Select

This item allows you to determine which InfraRed (IR) function of the onboard I/O chip, this functions uses.

Onboard Parallel Port

There is a built-in parallel port on the on-board Super I/O chipset that Provides Standard, ECP, and EPP features. It has the following option:

Disabled

(3BCH/IRQ7)/ Line Printer port 0

(278H/IRQ5)/ Line Printer port 2

(378H/IRQ7) Line Printer port 1

Parallel Port Mode

- SPP : Standard Parallel Port
- EPP : Enhanced Parallel Port
- ECP : Extended Capability Port

SPP/EPP/ECP/ECP+EPP

To operate the onboard parallel port as Standard Parallel Port only, choose “SPP.” To operate the onboard parallel port in the EPP modes simultaneously, choose “EPP.” By choosing “ECP”, the onboard parallel port will operate in ECP mode only. Choosing “ECP+EPP” will allow the onboard parallel port to support both the ECP and EPP modes simultaneously. The ECP mode has to use the DMA channel, so choose the onboard parallel port with the ECP feature. After selecting it, the following message will appear: “ECP Mode Use DMA” at this time, the user can choose between DMA channels 3 to 1. The onboard parallel port is EPP Spec. compliant, so after the user chooses the onboard parallel port with the EPP function, the following message will be displayed on the screen: “EPP Mode Select.” At this time either EPP 1.7 spec. or EPP 1.9 spec. can be chosen.

3-7-3 On-Chip Device Function

CMOS Setup Utility - Copyright(C) 1984-2000 Award Software
On-Chip Device Function

USB Controller Enabled USB Keyboard Support Disabled ** Onboard AC97 Codec is ALC100/200 ** AC97 Sound Enabled AC97 Modem Auto Game Port Address 201 Midi Port Address 330 Midi Port IRQ 10	Item Help Menu Level >>
Move Enter:Select Item +/-/PU/PD:Value F10:Save ESC:Exit F1:General Help F5:Previous Values F6:Optimized Defaults F7:Standard Defaults	

USB Controller

Select *Enabled* if your system contains a Universal Serial Bus (USB) controller and you have a USB peripherals. The settings are: Enabled, Disabled.

USB Keyboard Support

Select *Enabled* if your system contains a Universal Serial Bus (USB) controller and you have a USB keyboard. The settings are: Enabled, Disabled.

AC97 Sound

This item allows you to decide to enable/disable the 815 chipset family to support AC97 Audio. The settings are: Enabled, Disabled.

AC97 Modem

This item allows you to decide to enable/disable the 815 chipset family to support AC97 Modem. The settings are: Enabled, Disabled.

Game Port Address/Midi Port Address

This will determine which Address the Game Port/Midi Port will use.

3-8 Power Management Setup

The Power Management Setup allows you to configure your system to most effectively save energy saving while operating in a manner consistent with your own style of computer use.

CMOS Setup Utility - Copyright(C) 1984-2000 Award Software

Power Management Setup

ACPI Function	Enabled	Item Help
Power Management	User Define	
Video Off Method	DPMS	Menu Level >
Video Off In Suspend	Yes	
Suspend Type	Stop Grant	
MODEM Use IRQ	3	
Suspend Mode	Disabled	
HDD Power Down	Disabled	
Soft-off by PWR-BTTN	Instant-off	
Wake-Up by PCI card	Disabled	
Power On by Ring	Disabled	
Resume by Alarm	Disabled	
x Date (of Month) Alarm	0	
x Time (hh:mm:ss) Alarm	0 : 0 : 0	
> PM Timer Reload Events	Press Enter	
Move Enter:Select Item +/-/PU/PD:Value F10:Save ESC:Exit F1:General Help F5:Previous Values F6:Optimized Defaults F7:Standard Defaults		

ACPI Function

This item allows you to Enabled/Disabled the Advanced Configuration and Power Management (ACPI). The settings are Enabled and Disabled.

Power Management

This category allows you to select the type (or degree) of power saving which is directly related to the following modes:

1. Suspend Mode
2. HDD Power Down

There are three selections for Power Management, two of which have fixed mode settings.

Min Saving Minimum power management. Suspend Mode=1 hr., and HDD Power Down=15 min.

Max Saving Maximum power management. Suspend Mode=1 min., and HDD Power Down=1 min.

User Define(default) Allows you to set each mode individually. When not disabled, each of the ranges is from 1 min. to 1hr. except for HDD Power Down that ranges from 1 min. to 15 min. and disable.

Video Off Method

This determines the manner in which the monitor is blanked.

- V/H SYNC+Blank** This selection will cause the system to turn off the vertical and horizontal synchronization ports and write blanks to the video buffer.
- Blank Screen** This option only writes blanks to the video buffer.
- DPMS** (default) Initial display power management signaling.

Video Off In Suspend

This determines the manner in which the monitor is blanked. The settings are: Yes and No.

Suspend Type

Select the Suspend Type.

The settings are: PWRON Suspend, Stop Grant.

Modem Use IRQ

This determines the IRQ in which the MODEM can use.

The settings are: 3, 4, 5, 7, 9, 10, 11, NA.

Suspend Mode

When enabled and after the set time of system inactivity, all devices except the CPU will be shut off.

The settings are: 1/2/4/8/12/20/30/40 Min, 1 Hour, and Disabled.

HDD Power Down

When enabled and after setting time of system inactivity, the hard disk drive will be powered down while all the other devices remain active.

The settings are: 1/2/3/4/5/6/7/8/9/10/11/12/13/14/15 Min and Disabled.

Soft-Off by PWR-BTTN

Pressing the power button for more than 4 seconds forces the system to enter the Soft-Off state. The settings are: Delay 4 Sec, Instant-Off.

Wake Up by PCI card

This will enable the system to wake up to PCI LAN Card.

The settings are: Enabled and Disabled.

Power On by Ring

During Disabled, the system will ignore any incoming call from the modem. During Enabled, the system will boot up if there's an incoming call from the modem.

CPU Thermal-Throttling

Select the CPU THRM-Throttling rate. The settings are: 12.5%, 25.0%, 37.5%, 50.0%, 62.5%, 75.0%, 87.5%.

Resume by Alarm

This function is for setting date and time for your computer to boot up. During Disabled, you cannot use this function. During Enabled, choose the Date and Time Alarm:

Date(of month) Alarm

You can choose which month the system will boot up. Set to 0, to boot every day.

Time(hh:mm:ss) Alarm

You can choose what hour, minute and second the system will boot up.

Note: If you have change the setting, you must let the system boot up until it goes to the operating system, before this function will work.

PM Timer Reload Events

Pm Timer Reload events are I/O events whose occurrence can prevent the system from entering a power saving mode or can awaken the system from such a mode. In effect, the system remains alert for anything which occurs to a device which is configured as *Enabled*, even when the system is in a power down mode.

Primary IDE 0

Primary IDE 1

Secondary IDE 0

Secondary IDE 1

FDD, COM, LPT Port

PCI PIRQ[A-D] #

3-9 PnP/PCI Configuration Setup

This section describes configuring the PCI bus system. PCI, or **Personal Computer Interconnect**, is a system which allows I/O devices to operate at speeds nearing the speed the CPU itself uses when communicating with its own special components. This section covers some very technical items and it is strongly recommended that only experienced users should make any changes to the default settings.

CMOS Setup Utility - Copyright(C) 1984-2000 Award Software
PnP/PCI Configurations

Reset Configuration Data	Disabled	Item Help
Resources Controlled By	Manual	Menu Level > Default is Disabled. Select Enabled to reset Extended System Configuration Data ESCD when you exit setup if you have installed a new add-on and the system reconfiguration has caused such a serious conflict that the os cannot boot
> IRQ Resources	Press Enter	
PCI/VGA Palette Snoop	Disabled	
Move Enter:Select Item +/-/PU/PD:Value F10:Save ESC:Exit F1:General Help F5:Previous Values F6:Optimized Defaults F7:Standard Defaults		

Reset Configuration Data

Normally, you leave this field Disabled. Select Enabled to reset Extended System Configuration Data (ESCD) when you exit Setup if you have installed a new add-on and the system

reconfiguration has caused such a serious conflict that the operating system can not boot. The settings are: Enabled and Disabled.

Resource Controlled By

The Award Plug and Play BIOS has the capacity to automatically configure all of the boot and Plug and Play compatible devices. However, this capability means absolutely nothing unless you are using a Plug and Play operating system such as Windows®95/98. If you set this field to “manual” choose specific resources by going into each of the sub menu that follows this field (a sub menu is preceded by a “>”).

The settings are: Auto(ESCD), Manual.

IRQ Resources

When resources are controlled manually, assign each system interrupt a type, depending on the type of device using the interrupt.

DMA Resources

This sub menu can let you control the DMA resource.

PCI/VGA Palette Snoop

Leave this field at *Disabled*. The settings are Enabled, Disabled.

3-10 PC Health Status

This section shows the Status of you CPU, Fan, Warning for overall system status. This is only available if there is Hardware Monitor onboard.

CMOS Setup Utility - Copyright(C) 1984-2000 Award Software
PC Health Status

Show PC Health in Post	Enabled	Item Help	
Shutdown Temperature	Disabled		
Vcore	1.65V	Menu Level >	
Vcc 1.8V	1.85V		
VCC 3.3V	3.3V		
VCC 5V	4.97V		
+12V	11.90V		
-12V	(-)12.03V		
-5V	(-) 5.10V		
5VSB	4.97V		
Vbat	3.29V		
System Temperature	25°C		
CPU Temperature	51°C		
FAN1 Speed	5843 RPM		
FAN2 Speed	6132 RPM		
FAN3 Speed	5720 RPM		
Move Enter:Select Item +/-/PU/PD:Value F10:Save ESC:Exit F1:General Help F5:Previous Values F6:Optimized Defaults F7:Standard Defaults			

CPU Temperature

During Enabled, this will warn the user when the CPU temperature reaches a certain temperature.

Current System Temp/Current CPU Temperature/Current FAN1, FAN2, FAN3 Speed/

Vcore/VTT/3.3V/+5V/+12V/-12V/ -5V/VBAT(V)/5VSB(V)

This will show the CPU/FAN/System voltage chart and FAN Speed.

Shutdown Temperature

This option is for setting the Shutdown temperature level for the processor. When the processor reaches the temperature you set, this will shutdown the system.

3-11 Miscellaneous Control

This section is for setting CPU Miscellaneous Control.

CMOS Setup Utility - Copyright(C) 1984-2000 Award Software
Miscellaneous Control

Cyrix III Clock Ratio	Default	Item Help
Auto Detect DIMM/PCI Clk	Enabled	
Spread Spectrum	Disabled	
** Current Host Clock is 100 Mhz **		Menu Level >
CPU Host/SDRAM/PCI Clock	100/100/33Mhz	
CPU Clock Ratio	X 3	CyrixIII CPU Ratio Adjust
Move Enter:Select Item +/-/PU/PD:Value F10:Save ESC:Exit F1:General Help F5:Previous Values F6:Optimized Defaults F7:Standard Defaults		

Auto Detect DIMM/PCI Clk

This item allows you to enable/disable auto detect DIMM/PCI Clock.

The settings are: Enabled, Disabled.

Spread Spectrum

This item allows you to set the Spread Spectrum.

CPU/SDRAM/PCI Clock

This item allows you to select the CPU/SDRAM/PCI Clock, refer to [Page 13](#).

By press PageDown/PageUp key you can change the CPU Host/SDRAM/PCI Clock

When jumper setting CPU Host Clock 66MHz you can choose 66/100/33~99/133/49MHz

When jumper setting CPU Host Clock 100MHz you can choose 100/100/33~132/132/44MHz

When jumper setting CPU Host Clock 133MHz you can choose 133/133/33~166/166/41MHz

CPU Clock Ratio

This item allows you to select the CPU ratio.

3-12 Load Standard/Optimized Defaults

Load Standard Defaults

When you press <Enter> on this item, you get confirmation dialog box with a message similar to:

Load Standard Defaults (Y/N)? N

Pressing <Y> loads the BIOS default values for the most stable, minimal-performance system operations.

Load Optimized Defaults

When you press <Enter> on this item, you get a confirmation dialog box with a message similar to:

Load Optimized Defaults (Y/N)? N

Pressing <Y> loads the default values that are factory settings for optimal performance system operations.

3-13 Set Supervisor/User Password

You can set either supervisor or user password, or both of them. The differences are:

Supervisor password: Can enter and change the options of the setup menus.

User password: Can only enter but do not have the right to change the options of the setup menus. When you select this function, the following message will appear at the center of the screen to assist you in creating a password.

ENTER PASSWORD:

Type the password, up to eight characters in length, and press <Enter>. The password typed now will clear any previously entered password from CMOS memory. You will be asked to confirm the password. Type the password again and press <Enter>. You may also press <Esc> to abort the selection and not enter a password.

To disable a password, just press <Enter> when you are prompted to enter the password. A message will confirm that the password will be disabled. Once the password is disabled, the system will boot and you can enter Setup freely.

PASSWORD DISABLED.

When a password has been enabled, you will be prompted to enter it every time you try to enter Setup. This prevents an unauthorized person from changing any part of your system configuration.

Additionally, when a password is enabled, you can also require the BIOS to request a password every time your system is rebooted. This would prevent unauthorized use of your computer.

You determine when the password is required within the BIOS Features Setup Menu and its Security option. If the Security option is set to “System”, the password will be required both at boot and at entry to Setup. If set to “Setup”, prompting only occurs when trying to enter Setup.

Chapter 4

DRIVER & FREE PROGRAM INSTALLATION

Check your package and there is A MAGIC INSTALL CD included. This CD consists of all

DRIVERS you need and some free application programs and utility programs. In addition, this CD also include an auto detect software which can tell you which hardware is installed, and which DRIVERS needed so that your system can function properly. We call this auto detect software MAGIC INSTALL.

MAGIC INSTALL supports WINDOWS 95/98/98SE/NT4.0/2000

Insert CD into your CD-ROM drive and the MAGIC INSTALL Menu should appear as below. If the menu does not appear, double-click MY COMPUTER / double-click CD-ROM drive or click START / click RUN / type X:\SETUP.EXE (assuming X is your CD-ROM drive).

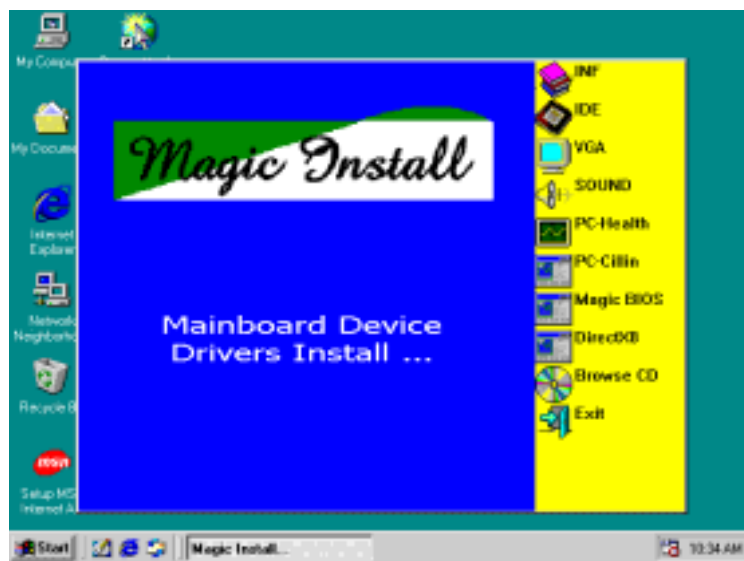

From MAGIC INSTALL MENU you may make 10 selections:

1. INF install INTEL 815 chipset system driver
2. IDE install Intel Ultra ATA Storage driver
3. VGA install on-board VGA driver (**615TCF Only**)
4. SOUND install AC97 sound driver and the program for editing/playback
5. PC-HEALTH installs SMART GUARDIAN software for hardware monitoring device
6. PC-CILLIN install PC-CILLIN 2000 anti-virus program
7. MAGIC BIOS install BIOS Live Update Utility
8. DIRECTX8 install Microsoft DirectX 8.0 driver
9. BROWSE CD to browse the contents of the CD
10. EXIT to exit from MAGIC INSTALL menu

Each selection is illustrated as below:

4-1 INF install INTEL 815 chipset system driver

After you have completed the installation of your operation system (WINDOWS 95/98/ 98SE). You will find an UNKNOWN DEVICE in the device manager (START/SETTING/CONTROL PANEL/SYSTEM/DEVICE MANAGER). You have to install INF driver as

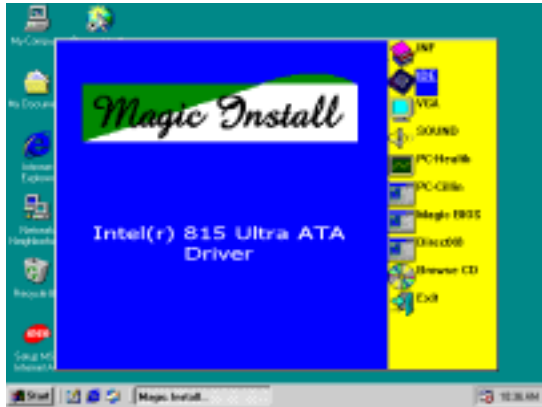

1. Click IDE when MAGIC INSTALL MENU appears

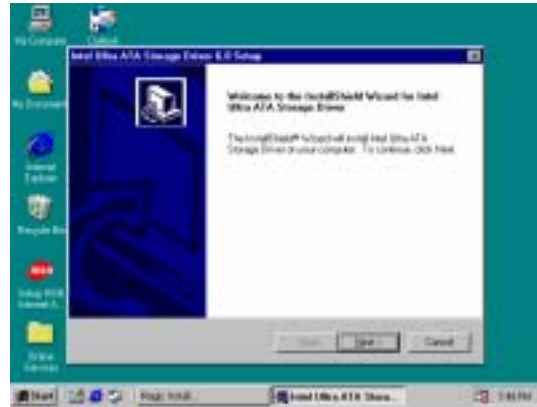

2. Click NEXT when INTEL Ultra ATA Storage Wizard appears

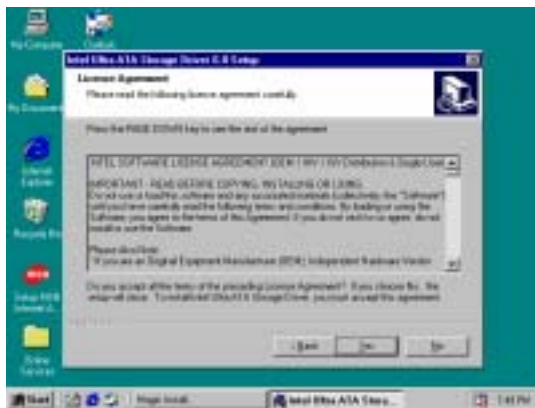

3. This is to announce the Copy Right click NEXT



4. Click NEXT or BROWSE to change the path you want the driver stored

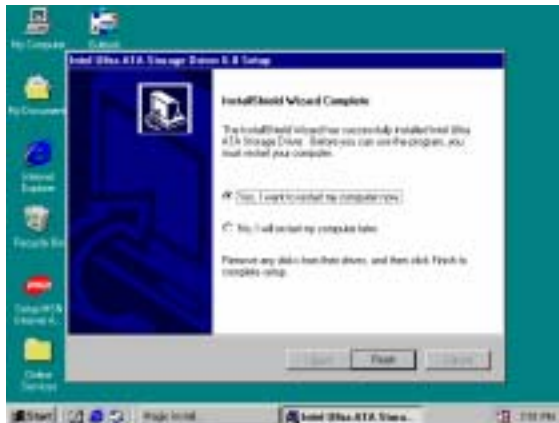

5. Select if you want to re-start your computer and click Finish

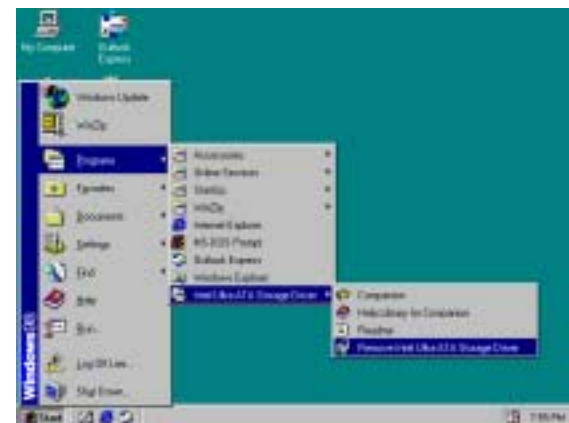

6. You may choose to remove the driver or you may remove it at ADD/REMOVE PROGRAMS

NOTE: MAGIC INSTALL will auto detect file path X:\INTEL815\IDE\SETUP.EXE

This driver supports WINDOWS 95/98/98SE/ME/NT4.0/2000

4-3 VGA install on-board VGA driver (615TCF Only)

A. For WINDOWS 95/98/98SE/ME/NT4.0/2000

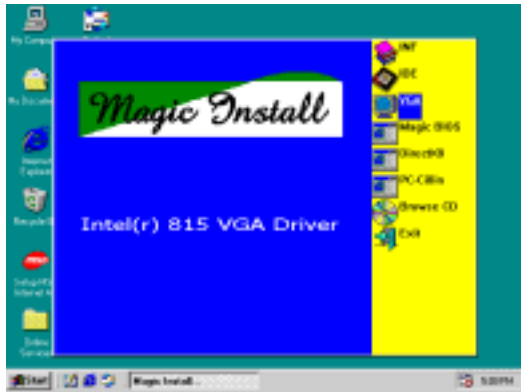

1. Click VGA when MAGIC INSTALL MENU appears
2. Click NEXT when INTEL 81X Family Chipset Graphics Driver Software appears

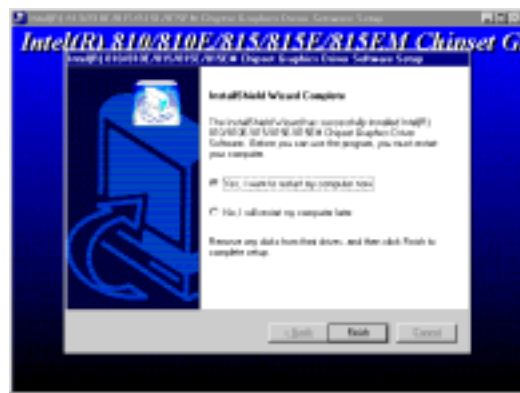
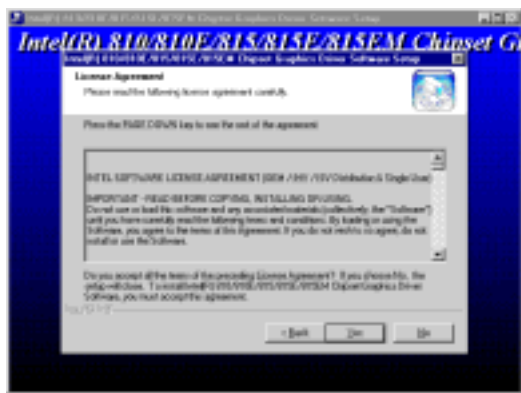

3. Click NEXT, this is to announce Copy Right
4. Select if you want to re-start computer and click Finish

NOTE: The path of the file
 for WIN95 is X:\INTEL815\VGA\WIN95\SETUP.EXE
 for WIN98 and WIN98SE is X:\INTEL815\VGA\WIN9X\SETUP.EXE
 for NT4.0 is X:\INTEL815\VGA\NT40\SETUP.EXE
 for Windows 2000 is X:\INTEL815\VGA\WIN2K\SETUP.EXE

4-4 AC97 sound driver and the program Install for editing/playback

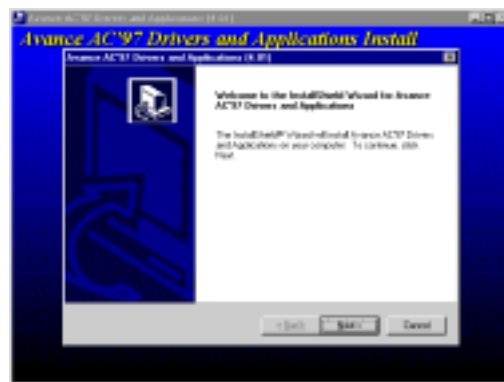

1. Click SOUND when MAGIC INSTALL MENU appears
2. Then auto detect operation system language edition, click OK, start to install DRIVER

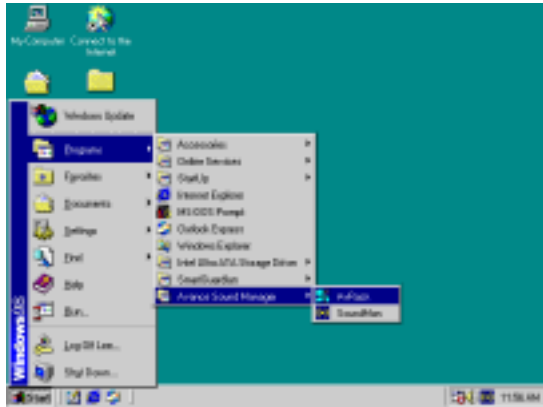

3. When ask Remove old device driver, Click OK 4. Click Finish and Restart Windows

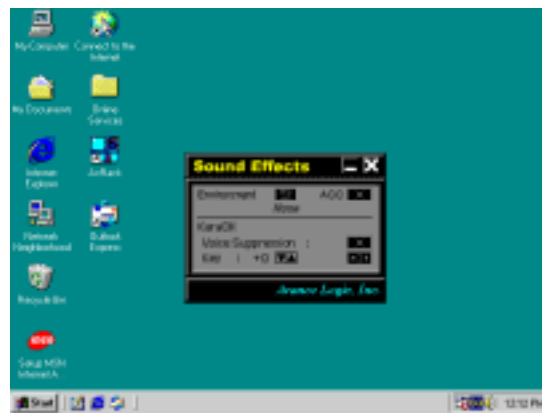

NOTE: MAGIC INSTALL will auto detect file path:
 X:\CODEC\ALC201\SETUP.EXE (for WINDOWS 95/98/98SE/ME/NT4.0/2000)

4-5 PC-HEALTH installs SMART GUARDIAN software for hardware monitoring device



1. Click PC-HEALTH when MAGIC INSTALL MENU appears 2. Click OK when SMART GUARDIAN INSTALL appears



3. This to assign the path of the file, click OK 4. Click OK after the software is installed

**NOTE: MAGIC INSTALL will auto detect file path X:\INTEL815\HEALTH\SETUP.EXE
This driver supports WINDOWS 95/98/98SE/NT4.0/2000**

4-6 PC-CILLIN Install PC-CILLIN 2000 Anti-virus program



1. Click PC-CILLIN when MAGIC INSTALL MENU Appears 2. Click NEXT when PC-CILIN 2000 SETUP APPEARS. Then click YES when the announcement of copywrite appears. Software is starting to detect HD for virus



3. Click NEXT and Enter User Information, Click NEXT or choose BROWSE to change the path For the file to be stored 4. Click NEXT and Choose all Internet Protection



5. Click OK and If You Have Proxy Server, Enter Your Setting.



6. Click NEXT when Start Copy Files, Start to install the software.



7. If you want to make a rescue disc, insert a 1.44 MB disc



8. Setup Complete and click Finish



9. Enter Your name and E-mail address Register PC-cillin 2000 or Click Cancel Register Later



10. After install PC-cillin 2000 complete we recommend select update item to download newest virus code and setting Auto refresh virus code

4-7 MAGIC BIOS Install BIOS Live Update Utility

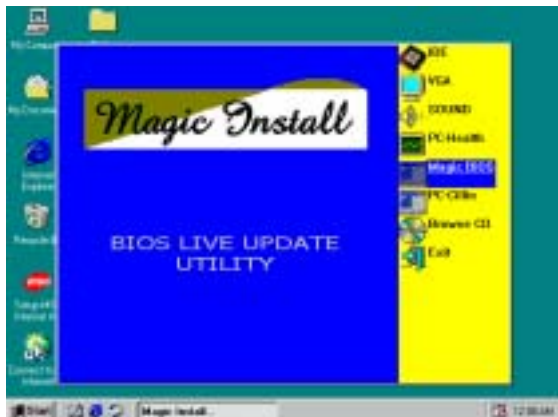

1. Click Magic BIOS when Magic Install MENU appears



2. Click Next to install the Magic BIOS in Destination Folder

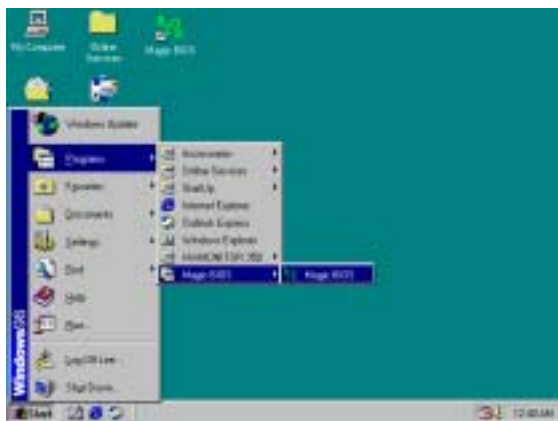

3. After finish Setup you will have a Magic BIOS icon in your screen



4. Double click the Magic BIOS icon you will have this picture, choose from internet you can upgrade BIOS On-line



5. When On-line update BIOS the program will auto-check your BIOS version

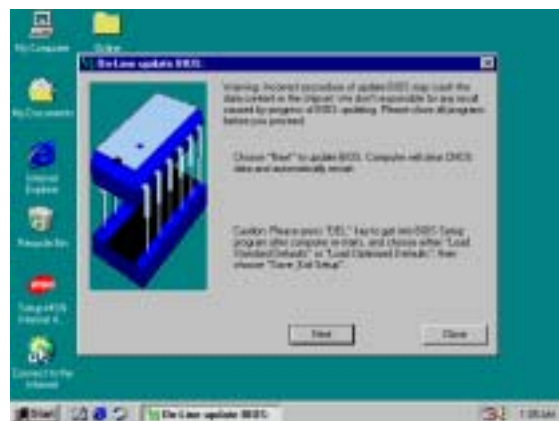

6. Click Next if you need update BIOS, after upgrade BIOS, the system will clear CMOS and automatically restart

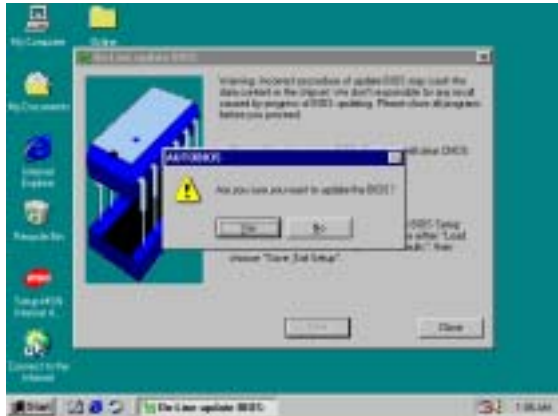

7. Click Yes if you want to update the BIOS otherwise choose No to exit

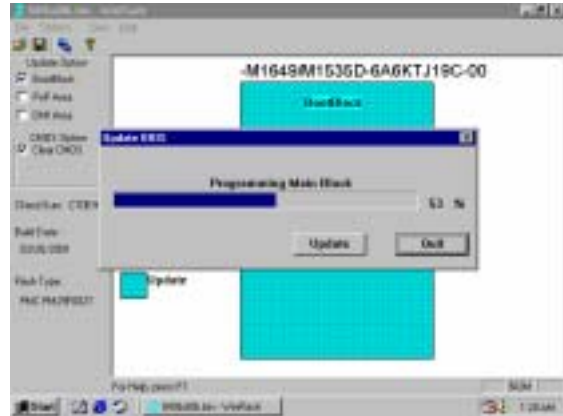

8. When System programming BIOS don't turn off power, after finish update BIOS, the system will clear CMOS and automatically Restart



9. When choose From Local Driver to update BIOS, you must have the correct BIOS file in your Local Driver



10. Choose the correct BIOS file to update BIOS

4-8 Microsoft DirectX 8.0 Driver

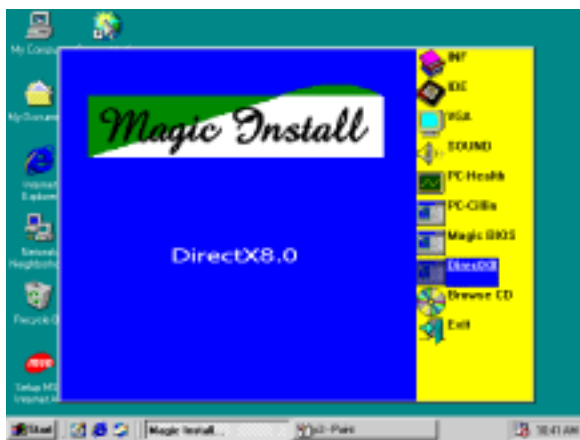

4-9 HOW TO UTILIZE ALSRACK EDITING & PLAYBACK UTILITY

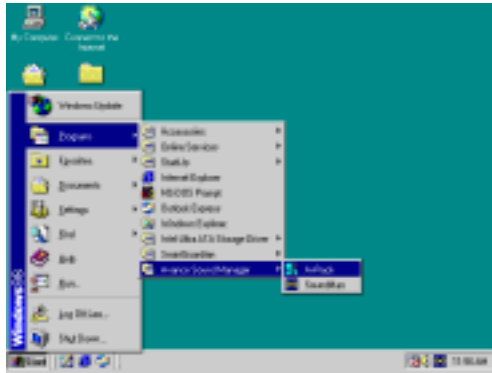

1. Click START/PROGRAMS/AVANCE SOUND MANAGER/AVRACK. Then ALSRACK appears



2. This utility it can play from CD the effect just like HI-FI stereo system, also it can play *.WAV, *.MID, *.MP3, *.MPG format file



3. This is a sound environment simulator offering massive simulation including environment of opera pub stadium

KARAOK playing having high low KEY tuning. Also BASS high low eight tune tuning and TREBLE high low eight tune tuning.

PS: After altering the options, there will be changes on the sound effect, user has to reset all the option in order to have the original sound effects.

4-10 HOW TO UTILIZE PC-HEALTH



1. Click START/PROGRAMS/SMART GUARDIAN ITE SMART GUARDIAN



2. You will see a real time report about FAN SPEED, VOLTAGE and TEMPERATURE System will make a warning if any value is beyond Initial setting value



3. You may re-set temperature and voltage by click OPTION

4-11 HOW TO DISABLE ON-BOARD SOUND

Enter BIOS SETUP choose INTEGRATE PERIPHERALS choose ON-CHIP DEVICE FUNCTION choose AC97 AUDIO

Disable on-board sound function by press PAGE DOWN KEY to Disable

4-12 HOW TO UPDATE BIOS

STEP 1. Prepare a boot disc. (you may make one by click START click RUN type SYS A: click OK)

STEP 2. Copy utility program to your boot disc. You may copy from DRIVER CD X:\FLASH\AWDFLASH.EXE or download from our web site.

STEP 3. Copy latest BIOS for 615TCF/615TCS from our web site to your boot disc.

STEP 4. Insert your boot disc into A:;

start the computer, type "Awdflash A:\615TCxxx.BIN /SN /PY /CC /R"

615TCFxxx.BIN is the file name of latest BIOS it can be 615TCFA3.BIN or 615TCFB2.BIN

SN means don't save existing BIOS data

PY means renew existing BIOS data

CC means clear existing CMOS data

R means restart computer

STEP 5. Push ENTER and the BIOS will be updated, computer will be restarted automatically