



C586VX

Rev. B+
System Board
User's Manual



-C31060613-





FCC Statement on Class B

This equipment has been tested and found to comply with the limits for a Class B digital device, pursuant to Part 15 of the FCC rules. These limits are designed to provide reasonable protection against harmful interference when the equipment is operated in a residential installation. This equipment generates, uses and can radiate radio frequency energy and, if not installed and used in accordance with the instruction manual, may cause harmful interference to radio communications. However, there is no guarantee that interference will not occur in a particular installation. If this equipment does cause harmful interference to radio or television reception, which can be determined by turning the equipment off and on, the user is encouraged to try to correct the interference by one or more of the following measures:

- Reorient or relocate the receiving antenna.
- Increase the separation between the equipment and the receiver.
- Connect the equipment into an outlet on a circuit different from that to which the receiver is connected.
- Consult the dealer or an experienced radio TV technician for help.

Notice:

1. The changes or modifications not expressly approved by the party responsible for compliance could void the user's authority to operate the equipment.
2. Shielded interface cables must be used in order to comply with the emission limits.

The manufacturer makes no warranties with respect to this documentation and disclaims any implied warranties of merchantability, quality, or fitness for any particular purpose. The information in this document is subject to change without notice. The manufacturer reserves the right to make revisions to this publication and to make changes to any and/or all parts of its content, at any time, without obligation to notify any person or entity of such changes. Further, the manufacturer assumes no responsibility for any errors that may appear in this document.



Table of Contents

Chapter 1: Introduction	5
Features and Specifications	6
Package Checklist	8
Chapter 2: Hardware Installation	9
Preparing the Area	9
Handling the System Board	9
Installing the System Board	10
Board Layout	12
System Memory	13
DIMM	13
SIMM	14
Jumper settings for DIMM and SIMM	15
Cache Memory	16
Installing the Cache Module	16
CPU Installation	18
Jumper Settings for CPUs	18
Installing Upgrade CPUs	21
Installing A Fan/Heatsink for Cyrix CPUs	23
Jumper Settings for Password Clear and Display Type Select	25
Built-in Ports	26
Serial Ports	26
PS/2 Mouse Port	27
Parallel Port	27
Floppy Disk Drive Controller	28
IDE Hard Disk Interface	28
Installing Expansion Cards	30
Chapter 3: Software Installation	31
Award BIOS CMOS Setup Utility	31
Standard CMOS Setup	31
BIOS Features Setup	36
Chipset Features Setup	41
Power Management Setup	42
PNP/PCI Configuration Setup	46
Load BIOS Defaults	48
Load Setup Defaults	48
Integrated Peripherals	49



Supervisor Password	52
User Password	52
IDE HDD Auto Detection	53
HDD Low Level Format	55
Save & Exit Setup	56
Exit Without Saving	57
System Error Report	57
IDE Device Drivers	59

Chapter 4: Troubleshooting Checklist	60
---	-----------

Appendix A: Types of Modules	61
Appendix B: Memory and I/O Maps	62
Appendix C: PCI I/O Pin Assignments	64
Appendix D: ISA I/O Pin Assignments	65
Appendix E: Connector Pin Assignments	66
Appendix F: Row Address of the DRAM and SDRAM	73





Chapter 1 Introduction

The C586VX, equipped with a 321-pin Zero Insertion Force (ZIF) CPU socket, is fast Pentium processor-class system board supporting Intel Pentium CPUs running at 75MHz, 90MHz, 100MHz, 120MHz, 133MHz, 150MHz, 166MHz and 200MHz frequencies. The C586VX also supports Cyrix 6x86 P120+/P133+/P150+/P166+ and AMD-K5 PR75 75MHz/PR90 90MHz CPUs.

The C586VX can support 8MB to 128MB of system memory. It is equipped with a DIMM socket using x64 EDO, fast page mode or SDRAM, and 4 SIMM sockets using EDO or fast page mode x32 DRAM. This system board also supports pipeline burst SRAM, and provides easy cache upgrades using 256KB cache module.

The C586VX design is based on the Peripheral Component Interconnect (PCI) local bus and Industry Standard Architecture (ISA) standards. It is equipped with 4 dedicated PCI slots and 3 dedicated 16-bit ISA slots.

The C586VX board has two bus master PCI IDE connectors. Bus mastering reduces CPU use during disk transfer. This system board is also equipped with two NS16C550A-compatible serial ports, an SPP/ECP/EPP parallel port, a floppy disk drive controller, one PS/2 mouse port and one PS/2 or AT keyboard connector.



Features and Specifications

Processor

- Intel Pentium™ 75/90/100/120/133/150/166/200MHz
- Future Pentium™ OverDrive Processor
- Cyrix 6x86 P120+/P133+/P150+/P166+
- AMD-K5 PR75 75MHz/PR90 90MHz

Chipset

- Intel 82430VX PCIsset

Cache Memory

- Supports 256KB or 512KB pipeline burst, direct map write-back cache
- One 160-pin cache module slot
- 256KB onboard: upgradeable with a 256KB cache module for a maximum of 512KB cache

System Memory

- 8MB to 128MB onboard memory
- One 168-pin DIMM socket using x64 EDO, fast page mode, or SDRAM, 60ns or 70ns, 3.3V
- Four 72-pin SIMM sockets using EDO or fast page mode x32 DRAM, 60ns or 70ns, 5V

BIOS

- Award BIOS, Windows 95 Plug and Play compatible
- Flash EPROM for easy BIOS upgrades

Energy Efficient Design

- System power management supported
- CPU stopped clock control
- Hardware supports SMI green mode
- Microsoft/Intel APM 1.1 compliant
- External power management switch supported



PCI IDE Interface

- PIO Mode 3 and Mode 4 Enhanced IDE (data transfer rate up to 16.6MB/sec.)
- DMA Mode 2 Bus Master IDE (data transfer rate up to 22.2MB/sec.)
- Bus mastering reduces CPU utilization during disk transfer
- ATAPI IDE CD-ROM supported

Integrated I/O

- Super I/O controller
- Two NS16C550A-compatible high speed UARTs
- One SPP/ECP/EPP parallel port
- Supports 360KB, 720KB, 1.2MB, 1.44MB, and 2.88MB floppy drives
- IrDA TX/RX header
- Two universal serial bus connectors in future revision

CPU Socket

- 321-pin ZIF socket (Intel Socket 7)
- Supports future low-voltage CPUs

Connectors

- 2 serial ports
- 1 parallel port
- 2 IDE connectors
- 1 floppy connector
- 1 PS/2 mouse port
- 1 PS/2 or AT keyboard connector

Expansion Slots

- 4 dedicated PCI slots
- 3 dedicated 16-bit ISA slots

PCB

- 4 layers, Baby AT form factor
- 25cm (9.84") x 22cm (8.66")



Package Checklist

The C586VX package contains the following items:

- The C586VX system board
- The C586VX user's manual
- One 40-pin IDE hard disk cable
- One 34-pin floppy disk drive cable
- One 25-pin printer port cable for chassis mounting
- One card-edge bracket for mounting the printer port cable
- One card-edge bracket with serial and mouse port cables
- One IDE driver diskette
- Cache module (optional)

If any of these items are missing or damaged, please contact your dealer or sales representative for assistance.





Chapter 2 Hardware Installation

This chapter summarizes the steps to install the C586VX system board into your system unit. It also includes a description of the area in which you must work and directions for memory installation. Before installing the system board, obtain the memory you plan to install. Please refer to the information on pages 13 and 14 for the number and type of memory modules needed for the amount of memory you require.

Preparing the Area

Before unpacking the system board, make sure the location you have selected is relatively free of dust and static electricity. Excessive exposure to dust, static electricity, direct sunlight, excessive humidity, extreme cold, and water can damage the operational capabilities of your system board. Avoid placing the unit on surfaces such as carpeted floors. These areas also attract static electricity which can damage some circuits on your system board.

Make sure the power source has a properly grounded, three-pronged socket. It is essential that the power connection be properly grounded for correct functioning of your system board. For further protection, we recommend that you use a surge suppressor. This will protect the system board from damage that may result from a power surge on the electrical line.

Move items that generate magnetic fields away from your system board since magnetic fields can also damage your system board. Once you have selected the ideal location, unpack the C586VX system board carefully.

Handling the System Board

It is quite easy to inadvertently damage your system board even before installing it in your system unit. Static electrical discharge can damage computer components without causing any signs of physical damage. You must take extra care in handling the system board to ensure against electrostatic build-up.



Static Electricity Precautions

1. To prevent electrostatic build-up, leave the board in its anti-static bag until you are ready to install it.
2. Wear an antistatic wrist strap.
3. Do all preparation work on a static-free surface with the system board components facing up.
4. Hold the system board only by its edges. Be careful not to touch any of the components, contacts or connections, especially gold contacts, on the board.
5. Avoid touching the pins or contacts on all modules and connectors. Hold modules and connectors by their ends.

Warning:

Electrostatic discharge (ESD) can damage your processor, disk drives, add-in boards, and other components. Perform the upgrade instruction procedures described at an ESD workstation only. If such a station is not available, you can provide some ESD protection by wearing an anti-static wrist strap and attaching it to a metal part of the system chassis. If a wrist strap is unavailable, establish and maintain contact with the system chassis throughout any procedures requiring ESD protection.

Installing the System Board

If you are installing the C586VX system board, the following outlines the basic installation steps. Before installing the system board into your system unit, you should prepare the tools you will need.

You will need:

- One medium size, flat-bladed screwdriver
- One medium Phillips screwdriver
- One needle-nosed pliers
- One small nutdriver

1. Unlock your system unit. Turn off the power and disconnect all power cords and cables.



2. Remove the system unit cover. Refer to the manufacturer's instructions if necessary.
3. Detach all connectors from the old system board and remove expansion cards seated in any expansion slots.
4. Loosen the screws holding the original system board and remove the board from the system. Save the screws.
5. Remove the C586VX from its original packing box. Be careful to avoid touching all connectors and pins on the board. Please refer to the handling instructions on pages 9-10 for proper handling techniques.
6. Insert the memory modules into the memory banks on the C586VX. The quantity and location of the memory modules depends on the memory configuration and type of modules you intend to use.
7. Insert the cache module, if any, into the cache module slot on the C586VX. Refer to the Cache Memory section on page 16 for upgrading your cache memory.
8. Install the CPU. Be sure pin 1 of the CPU is aligned with pin 1 of the socket.
9. Set the corresponding jumpers.
10. Install the prepared C586VX system board into the case and replace the screws.
11. Reinstall all cards and connectors and replace the system unit cover. Reconnect all power cords and cables.



Board Layout

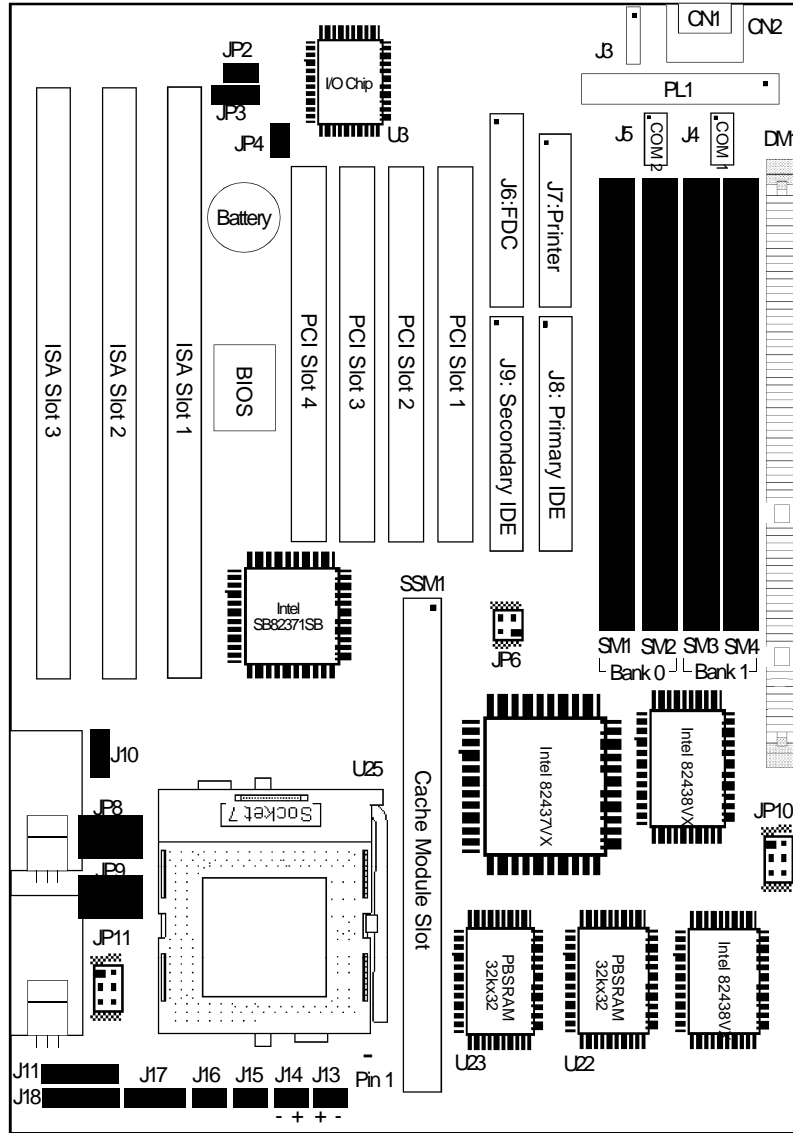

1. "■" square denotes pin 1
2. PBSRAM = Pipeline Burst SRAM

System Memory

The C586VX system board supports two kinds of memory modules: DIMM and SIMM. DIMM, which uses SDRAM, performs better than SIMM, which uses DRAM.

DIMM

The DIMM (Dual In-line Memory Module) socket uses x64 EDO, FPM and SDRAM. The C586VX system board can support 8MB to 16MB memory using 1MBx64 or 2MBx64 168-pin DIMM. Refer to page 12 for the location of the DIMM.

Installing the DIM Module

A DIM module simply snaps into a socket on the system board. Pin 1 of the DIM module must correspond with Pin 1 of the socket.

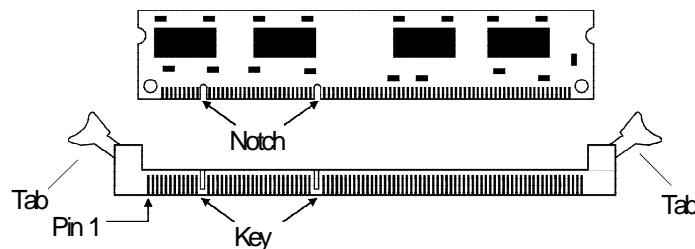

1. Pull the "tabs" which are at the ends of the socket to the side.
2. Position the DIMM above the socket with the "notches" in the module aligned with the "keys" on the socket.
3. Seat the module vertically into the socket. Make sure it is completely seated. The tabs will hold the DIMM in place.

SIMM

The SIMM (Single In-line Memory Module) sockets are divided into two banks on the system board, Bank 0 and Bank 1. Each bank consists of 2 SIMM sockets.

You will need either 2 or 4 pieces of SIM modules, depending on the amount of memory you intend to install. The system board will not work if you install 1 or 3 pieces. Make sure you insert the same type of SIMMs in one bank. You can install SIMMs in either of the banks, Bank 0 or Bank 1, but you must populate a bank first before going to the next bank.

The C586VX system board can support 8MB to 128MB of memory using 1MBx32, 2MBx32, 4MBx32, or 8MBx32 72-pin SIMMs. The table below shows the supported SIM modules and their corresponding memory sizes.

SIMMs	Memory Size
1MBx32	4MB
2MBx32	8MB
4MBx32	16MB
8MBx32	32MB

Examples:

If you are installing 8MB of memory, you must insert two 1MBx32 SIMMs in Bank 0 or Bank 1. Inserting one 2MBx32 module will not work.

If you are installing 24MB of memory, you must insert two 1MBx32 SIMMs in Bank 0 and two 2MBx32 SIMMs in Bank 1. You may also install it vice versa by inserting two 1MBx32 SIMMs in Bank 1 and two 2MBx32 SIMMs in Bank 0.

Installing a SIM Module

A SIM module simply snaps into a socket on the system board. Pin 1 of the SIM module must correspond with Pin 1 of the socket .

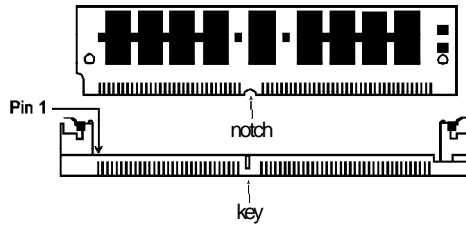
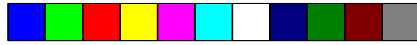

1. Position the SIMM above the socket with the “notch” in the module aligned with the “key” on the socket.
2. Seat the module at a 45° angle into the bank. Make sure it is completely seated. Tilt the module upright until it locks in place in the socket.

Warning:

The DIMM and SIMM can not exist on the C586VX system board at the same time. You must only use either a DIMM or SIMMs on your system board.

Jumper Settings for DIMM and SIMM**Jumper JP10**

DIMM and SIMM Select

Jumper JP10 must match the type of module installed on the C586VX system board. If you change your memory module, make sure this jumper is changed accordingly.

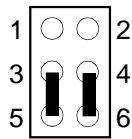

3-5, 4-6 On: DIMM

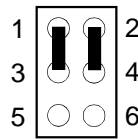

1-3, 2-4 On: SIMM
(Default)



Cache Memory

The C586VX system board can support 256KB or 512KB pipeline burst, direct map write-back cache SRAM. Your system board may come with 256KB or 512KB cache mounted onboard. The 160-pin cache module slot lets you upgrade your cache memory by installing a 256KB cache module.

Note:

You do not need to set any jumpers or modify the Award BIOS Setup utility when you install the cache module.

If your system board comes with 256KB cache at locations U22 and U23, you can upgrade your cache memory to 512KB by installing a 256KB cache module in the cache module slot. Please refer to page 12 for the locations of the cache module slot (SSM1), U22 and U23.

Warning:

We highly recommend that you use the 2BSM32-256 cache module. If you are using the cache module other than the one recommended above, make sure your cache module meets the Intel COAST 2.x specification. Severe damage might occur on the cache module or system board if you insert modules other than those specified above.

Installing the Cache Module

Locate the 160-pin cache module slot on the system board (SSM1). Refer to page 12 for the location of SSM1. Position the cache module above the slot. Make sure pin 1 of the cache module is aligned with pin 1 of the slot. Carefully slide the module into the slot. Press firmly on the top of it to seat it properly.

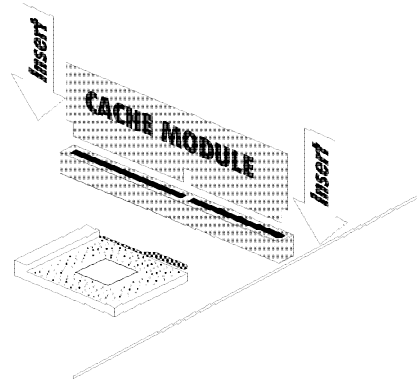

Note:

With the cache module installed in the cache module slot, the components on the solder side of the add-in card in PCI Slot 3 must not protrude more than 5mm. The components of the component side of the add-in card in PCI Slot 2 also must not protrude more than 5mm.



CPU Installation

The C586VX allows for easy installation of CPUs. Make sure all jumpers are set correctly before applying power or you may damage the CPU or system board. Please see the jumper settings on the following pages. Use the needle-nosed pliers to move the jumpers if necessary.

Jumper Settings for CPUs

Intel CPUs

Intel CPUs	CPU CLK	JP4
75MHz	50MHz	Off
90/100/120/150/ 166/200MHz	60/66MHz	On



Intel CPUs	CPU CLK	JP8	
		Pin 1-2	Pin 3-4
75/90/100MHz	1.5x	Off	Off
120/133MHz	2x	On	Off
150/166MHz	2.5x	On	On
200MHz	3x	Off	On

Intel CPUs	CPU CLK	JP6	
		Pin 1-2	Pin 3-4
75MHz	50MHz	On	On
90/120/150MHz	60MHz	On	Off
100/133/166/200MHz	66MHz	Off	On

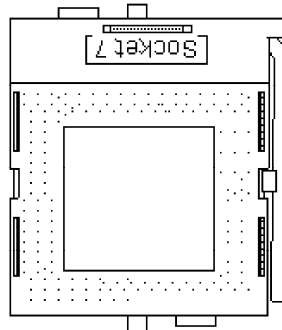
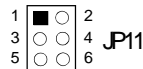
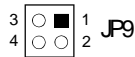
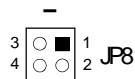
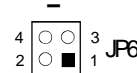

Voltage	JP9	JP11
28V	1-2 On	1-3 On, 2-4 On
3.3V*	1-2 On	3-5 On, 4-6 On
3.52V	3-4 On	3-5 On, 4-6 On

* Default

Warning:

The default setting of JP9 and JP11 is 3.3V. If the voltage CPU is not 3.3V, make sure you set JP9 and JP11 according to the voltage of your CPU, otherwise, your system will hang.

Cyrix 6x86 CPUs

Cyrix 6x86CPUs	CPU CLK	JP4
P120+/P133+	50/55MHz	Off
P150+/P166+	60/66MHz	On



Cyrix 6x86CPUs	CPU CLK	JP6	
		Pin 1-2	Pin 3-4
P120+	50MHz	On	On
P133+	55MHz	Off	Off
P150+	60MHz	On	Off
P166+	66MHz	Off	On

Cyrix 6x86CPUs	CPU CLK	JP8	
		Pin 1-2	Pin 3-4
P120+/P133+/ P150+/P166+	2x	On	Off

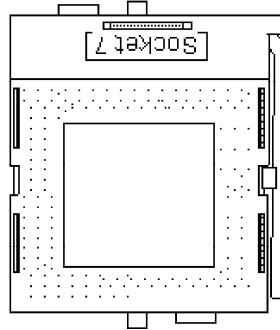
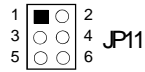
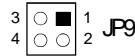
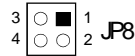
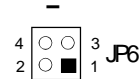

Voltage	JP9	JP11
2.8V	1-2 On	1-3 On, 2-4 On
3.3V*	1-2 On	3-5 On, 4-6 On
3.52V	3-4 On	3-5 On, 4-6 On

* Default

Warning:

The default setting of JP9 and JP11 is 3.3V. If the voltage of CPU is not 3.3V, make sure you set JP9 and JP11 according to the voltage of your CPU, otherwise, your system will hang.



AMD-K5 CPUs

AMD-K5 CPUs	CPU CLK	JP4
PR75 75MHz	50MHz	Off
PR90 90MHz	60MHz	On



AMD-K5 CPUs	CPU CLK	JP8	
		Pin 1-2	Pin 3-4
PR75 75MHz/ PR90 90MHz	1.5x	Off	Off

AMD-K5 CPUs	CPU CLK	JP6	
		Pin 1-2	Pin 3-4
PR75 75MHz	50MHz	On	On
PR90 90MHz	60MHz	On	Off

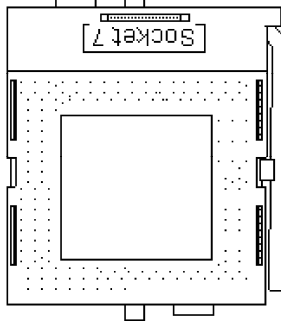
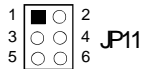
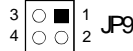
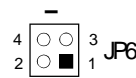
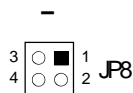

Voltage	JP9	JP11
2.8V	1-2 On	1-3 On, 2-4 On
3.3V*	1-2 On	3-5 On, 4-6 On
3.52V	3-4 On	3-5 On, 4-6 On

* Default

Warning:

The default setting of JP9 and JP11 is 3.3V. If the voltage of CPU is not 3.3V, make sure you set JP9 and JP11 according to the voltage of your CPU, otherwise, your system will hang.



Installing Upgrade CPUs

The C586VX is equipped with a 321-pin Zero Insertion Force (ZIF) socket at location U25 of the system board. Refer to page 12 for the location of the ZIF socket. This socket is designed for easy removal of an old CPU and easy insertion of an upgrade CPU. The socket allows you to carefully place the new CPU into its position. If you need to apply excessive force to insert the CPU, you are not installing the CPU correctly.

Warning:

Open the socket only if you are actually installing a CPU. The warranty on the original CPU will be voided if the S/N seal is broken. Before proceeding with the upgrade, take note of the following. The microprocessor and heatsink may be hot if the system has been running. To avoid the possibility of a burn, power the system off and let the processor and heatsink cool for 10 minutes.

The 321-pin ZIF socket consists of five rows of pin holes on each side. To prevent improper CPU installation, the ZIF socket has a Plug/Keying mechanism. Several holes in the socket are plugged so that the CPU will go in only one way. If you cannot easily insert the CPU, verify that pin 1 of the CPU is aligned with pin 1 of the socket.

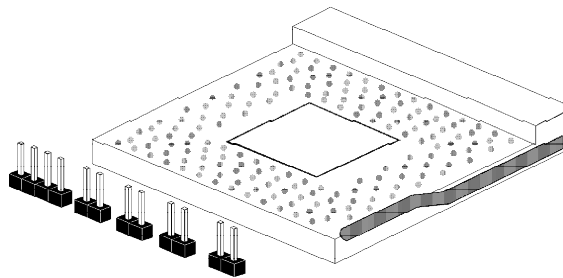

Zero Insetion Force (ZIF) Socket



To install an upgrade CPU, do the following.

1. Make sure the handle on the side of the ZIF socket is up. To raise the handle, push it down, slightly pull it out to the side, then raise it as far as it will go. It may be necessary to initially apply a small amount of sideways force to free the handle from its retaining "tab". Once clear of the "tab", the handle will open relatively easily. The top plate will slide back. Do not use screwdrivers or other tools to open the socket, or you may damage the system or socket.

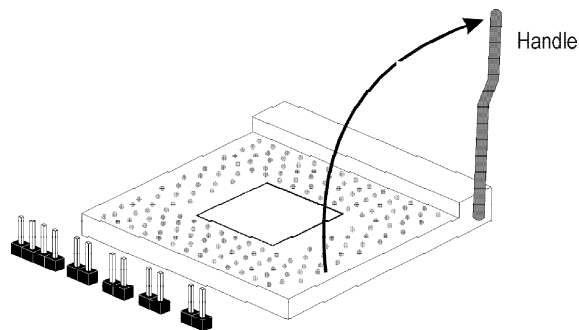

Lifting the Handle

2. Once the lever is completely up, remove the old CPU carefully by lifting it straight out of the socket. You are now ready to insert the new CPU.

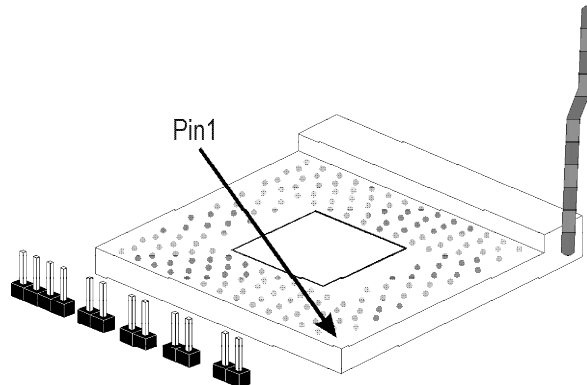



3. Position the CPU above the ZIF socket. Make sure pin 1 of the CPU is aligned with pin 1 of the socket. Lower the chip until the pins are inserted properly in their corresponding holes. Remember that very little force is needed to install the CPU. If the CPU is not easily inserted, verify whether or not pin 1 of the CPU is aligned with pin 1 of the socket. Applying too much pressure can damage the CPU or the socket.

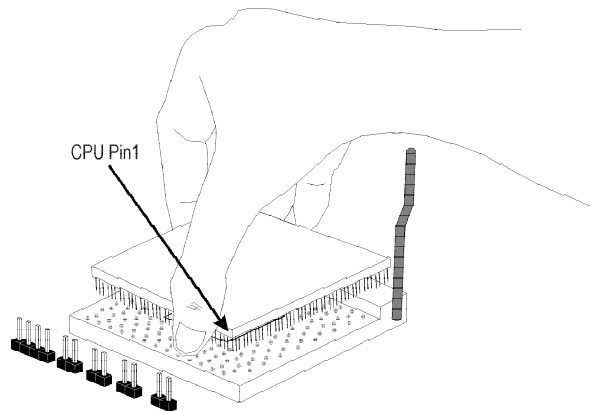

Positioning the CPU Above the ZIF Socket

4. Push the handle down until the handle locks into place. The top plate will slide forward. You will feel some resistance as the pressure starts to secure the CPU in the socket. This is normal and will not damage the CPU. However, if the handle is not completely closed, damage to the CPU and/or system board may result.

Installing A Fan/Heatsink for Cyrix CPUs

If you are using a Cyrix CPU, you must choose a fan/heatsink which is made for Cyrix processors. Position the fan/heatsink on the CPU such that the air from the side of the fan/heatsink will flow across the heat regulators on the system board. See the figure on the next page.

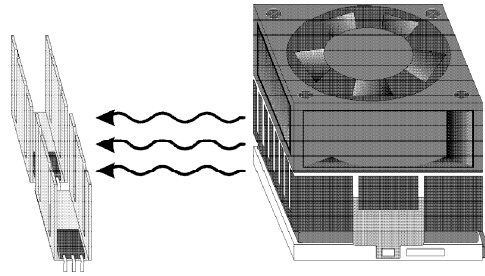
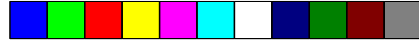

Clearance Requirements

Your CPU comes with a heatsink mounted on top. To maintain proper airflow once the upgrade is installed on the system board, the CPU and heatsink require certain space clearances.

The clearance above the CPU's fan/heatsink must be at least 0.4 inches. The clearance on at least 3 of 4 sides of the processor and heatsink must be at least 0.2 inches. All cables (for floppy drive, hard drive, CD-ROM, etc.) must be routed clear of the CPU and its airspace.

Fan Exhaust

The CPU must be kept cool by using a fan with heatsink. The temperature of the air entering the fan/heatsink cannot exceed 45°C (113°F). The ambient or room temperature must be below 37°C (99°F).

Jumper Settings for Password Clear and Display Type Select

Jumper JP2 Password Clear

If you set a password in the "Password Setting" option and forget your password, power off your system and set jumper JP2 to On to clear the password stored in your CMOS. Now power on your system. After your system has detected the floppy or hard drive, turn it off again and set JP2 to off.



Off: Normal
(Default)



On: Password Clear

Jumper JP3 Display Type Select

Jumper JP3 sets the display adapter to color or mono. This jumper must match the type of display adapter installed. If you change your video adapter, make sure this jumper is changed accordingly.

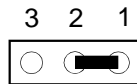

1-2 On: Color
(default)

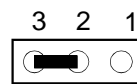

2-3 On: Mono

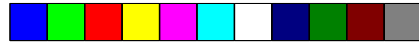

Built-in Ports

The C586VX system board is equipped with two serial ports, one parallel printer port, one FDD connector, two IDE hard disk shrouded headers and one PS/2 mouse connector. Refer to page 12 for the locations of the built-in connectors and pin 1 of those connectors.

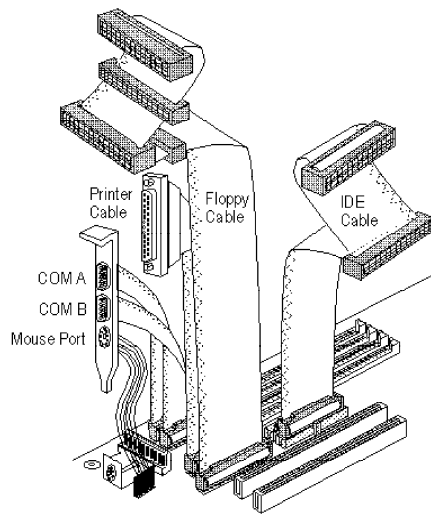

Serial Ports

The built-in serial ports are RS-232C asynchronous communication ports with 16C550A-compatible UARTs that can be used with modems, serial printers, remote display terminals, and other serial devices. They use the following system I/O addresses:

Port Configuration	COM1	COM2	COM3	COM4
Serial Port 1	3F8h*	2F8h	3E8h	2E8h
Serial Port 2	3F8h	2F8h*	3E8h	2E8h

* Default



Connecting the Serial Ports

Two DB-9P serial port cables are provided with the system board. They are mounted on a card-edge bracket along with the PS/2 mouse cable. The upper serial port cable should be used for the COM 1 primary serial port; connect it to connector J4 on the system board. The lower serial port cable should be used for the COM 2 secondary serial port; connect it to connector J5 on the system board. Make sure the colored stripes on the ribbon cables are aligned with pin 1 of connectors J4 and J5. Mount the card-edge bracket to the system chassis.

PS/2 Mouse Port

The PS/2 mouse port is a 6-pin connector on the system board. Attach the 6-pin mouse port cable, which is mounted on the card-edge bracket, to connector J3. Make sure the brown wire on the PS/2 mouse connector is aligned with pin 1 of connector J3.

Parallel Port

The C586VX system board has a standard connector for interfacing your PC to a parallel printer. The parallel port on your system board can be set to any of the following system I/O addresses:

I/O Address: 3BC-3BE Hex
378-37A Hex (default)
278-27A Hex

Connecting the Parallel Printer Port

Attach the DB-25S printer cable, which came with the system board, to connector J7 on the C586VX system board. Make sure the colored stripe on the ribbon aligns with pin 1 of connector J7. Use a small nutdriver to mount the cable into a DB-25 cutout in the system chassis. You may also use the cable to the card-edge bracket which came with the system board. After attaching the cable to the card-edge bracket, mount the bracket to the system chassis.





Floppy Disk Drive Controller

The C586VX system board has a built-in floppy disk controller that supports two standard floppy disk drives. You can install any 360KB, 720KB, 1.2MB, 1.44MB, or 2.88MB floppy disk drives.

Connecting the Floppy Disk Cable

1. Install the 34-pin header connector into the floppy disk connector (J6) on the system board. The colored edge of the ribbon should be aligned with pin 1 of connector J6.
2. Install the other 34-pin header connector(s) into the disk drive(s). Align the colored edge of the daisy chained ribbon cable with pin 1 of the drive edge connector(s). The end-most connector should be attached to the drive you want to designate as Drive A.

IDE Hard Disk Interface

The C586VX system board is equipped with two PCI IDE shrouded headers that will interface four Enhanced IDE (Integrated Drive Electronics) hard disk drives.

Note:

Only Enhanced IDE hard drives or ATAPI CD-ROMs can be connected to the IDE interface.

Connecting the IDE Hard Disk Interface

To prevent improper IDE cable installation, each PCI IDE shrouded header has a keying mechanism. The 40-pin connector on the IDE cable can be placed into the header only if pin 1 of the connector is aligned with pin 1 of the header.

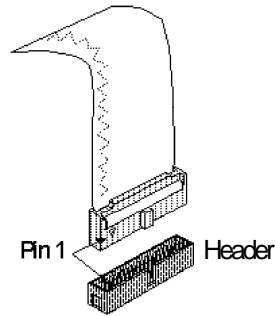

**Note:**

An IDE cable with a standard 40-pin connector (without the keying mechanism) can be installed in the PCI IDE shrouded header. Be extremely careful to match the colored edge of the ribbon with pin 1 of the header.

Connecting the Hard Disk Cable

1. If you are connecting two hard drives, install the 40-pin connector of the IDE cable into the primary IDE shrouded header (connector J8). If you are adding a third or fourth IDE device, install the 40-pin connector of the other IDE cable into the secondary IDE shrouded header (connector J9).
2. Install the other 40-pin header connector(s) into the device with the colored edge of the ribbon cable aligned with pin 1 of the drive edge connector(s).

Note:

Refer to your disk drive user's manual for information about selecting proper drive switch settings.

Adding a Second IDE Hard Drive

When using two IDE drives, one must be set as the master and the other as the slave. Follow the instructions provided by the drive manufacturer for setting the jumpers and/or switches on the drives.



We recommend that the Enhanced IDE hard drives be from the same manufacturer. In a few cases, drives from two different manufacturers will not function properly when used together. The problem lies in the hard drives, not the C586VX system board.

Preparing an IDE Drive for Use

IDE disk drives are already low-level formatted, with any bad-track errors entered, when shipped by the drive manufacturer. Do not attempt to do a low-level format or you may cause serious damage to the drive. To use an IDE drive, you need to enter the drive type (this information is provided by the drive manufacturer) into the system's CMOS setup table. Then run FDISK and FORMAT provided with DOS. You also can use the "IDE Auto Detection" to set your IDE Drive mode, please refer to the relevant information on the section "IDE Auto Detection".

Warning:

Do not run FDISK and FORMAT programs on a drive that has already been formatted or you will lose all programs and data stored on the drive.

Installing Expansion Cards

The C586VX system board is equipped with 4 dedicated PCI slots and 3 dedicated 16-bit ISA slots. All PCI slots are bus masters.

Due to the size of the CPU with its accompanying fan/heatsink component, the length of the add-in cards in PCI slot 4 and ISA slot 1 is limited to 18cm (7.07", measured from the bracket of the card). With the cache module installed in the cache module slot, the components on the solder side of the add-in card in PCI Slot 3 must not protrude more than 5mm. The components of the component side of the add-in card in PCI Slot 2 also must not protrude more than 5mm.

Refer to page 12 for the locations of the expansion slots.

Note:

The BIOS needs to be configured for the PCI add-in cards installed in the PCI slots. Refer to the "PCI Configuration Setup" presented in the "Software Installation" section of the manual.



Chapter 3 Software Installation

After you power up your system, the BIOS message appears on your screen and the memory count begins.

After the memory test, the following message will appear on the screen:

Press DEL to enter setup

If the message disappears before you respond, restart your system or press the “Reset” button on the front of your computer. You may also restart the system by pressing the <Ctrl> <Alt> and keys simultaneously. If you do not press these keys at the correct time and the system does not boot, the following error message will appear:

Press Del to enter Setup

If you have set a password and selected “System” in the Security Option of the BIOS Features Setup menu, you will be prompted for the password every time the system is rebooted or any time you try to enter Setup. Type in the correct password and press <Enter>.

If you selected “Setup” in the Security Option, you will be prompted for the password only when you try to enter Setup. Refer to the “BIOS Features Setup” section for more information.

Award CMOS Setup Utility

Press <Ctrl> <Alt> <Esc> simultaneously or to enter the Setup utility. A screen similar to the one on the next page will appear.



ROM PCI/ISA BIOS (2A59GD49)
CMOS SETUP UTILITY
AWARD SOFTWARE, INC.

STANDARD CMOS SETUP BIOS FEATURES SETUP CHIPSET FEATURES SETUP POWER MANAGEMENT SETUP PNP/PCI CONFIGURATION LOAD BIOS DEFAULTS LOAD SETUP DEFAULTS	INTEGRATED PERIPHERALS SUPERVISOR PASSWORD USER PASSWORD IDE HDD AUTO DETECTION HDD LOW LEVEL FORMAT SAVE & EXIT SETUP EXIT WITHOUT SAVING
ESC :Quit F10 :Sve & Exit Setup	↑↓→← :Select Item (Shift) F2 :Change Color
Time, Date, Hard Disk Type...	

Use the arrow keys to highlight the option you want and press <Enter>. The following describes each of these options.

Standard CMOS Setup

Use the arrow keys to highlight "Standard CMOS Setup" and press <Enter>. A screen similar to the one below will appear.

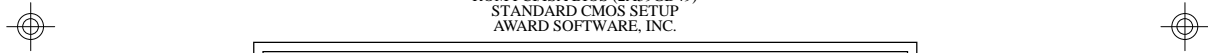

ROM PCI/ISA BIOS (2A59GD49)
STANDARD CMOS SETUP
AWARD SOFTWARE, INC.

Date (mm:dd:yy) : Mon, Apr 15 1996								
Time (hh:mm:ss) : 9 : 5 : 55								
HARD DISKS	TYPE	SIZE	CYLS	HEAD	RECOMP	LANDZ	SECTOR	MODE
Primary Master	:Auto	0	0	0	0	0	0	AUTO
Primary Slave	:Auto	0	0	0	0	0	0	AUTO
Secondary Master	:Auto	0	0	0	0	0	0	AUTO
Secondary Maste	:Auto	0	0	0	0	0	0	AUTO
DriveA	:1.44M,3.5in.							
DriveB	:None							
Video	:EGA/VGA							
Halt on	:All Errors							
						Base Memory : 640K		
						Extended Memory : 31744K		
						Other Memory : 384K		
						Total Memory : 32768K		
ESC	:Quit	↑↓→←		:Select Item		PU/PD/+/- : Modify		
F1	:Help	(Shift)F2		:Change				

Date

Enter the current date in the following format: <Day>, <Date>, <Month>, <Year>. These items can be altered; they are detected and displayed automatically. .





Day	Displays a day from Sunday to Saturday
Month	Displays the month, January through December
Date	Displays the date from 1 to 31
Year	Displays the last two digits of the year

Time

Enter the current time in the following format: <Hour>, <Minute>, <Second>. The time is based on the 24-hour military-time clock. For example, 1 p.m. is 13:00:00.

Hour	Displays hours from 00 to 23
Minute	Displays minutes from 00 to 59
Second	Displays seconds from 00 to 59

Primary Master, Primary Slave, Secondary Master and Secondary Slave

These categories allow you to enter the appropriate specifications for the type of hard disk drive(s) installed in your system. There are 45 predefined types and 4 user definable types for Enhanced IDE BIOS. Type 1 to Type 45 are predefined. Type user is user-definable.

Press <PgUp> or <PgDn> to select a numbered hard disk type or type the number and press <Enter>. The hard disk will not work properly if you enter improper information for this category. You can use Type "User" to define your own drive type manually.

If you select Type "User", you will need to know the information listed below. Enter the information directly from the keyboard and press <Enter>. This information should be included in the documentation from your hard disk vendor or the system manufacturer.

If the controller of the HDD interface is ESDI, you must select "Type 1".

If the controller of the HDD interface is SCSI, you must select "None".

If you select Type "Auto", the BIOS will auto-detect the HDD & CD-ROM drive at the POST stage and show the IDE for the HDD & CD-ROM drive.



Type	Drive type
Cyls	Number of cylinders
Heads	Number of heads
Precomp	Write precomp
Landzone	Landing zone
Sectors	Number of sectors
Mode	Mode type

If a hard disk has not been installed, select None and press <Enter>.

Drive A and Drive B

This category identifies the types of floppy disk drive installed. The following are the options for drives A and B.

None	No floppy drive is installed.
360K, 5.25"	5-1/4 inch PC-type standard drive; 360 kilobyte capacity.
1.2M, 5.25"	5-1/4 inch AT-type standard drive; 1.2 megabyte capacity.
720K, 3.5"	3-1/2 inch double-sided drive; 720 kilobyte capacity.
1.44M, 3.5"	3-1/2 inch double-sided drive; 1.44 megabyte capacity.
2.88M, 3.5"	3-1/2 inch double-sided drive; 2.88 megabyte capacity.

Note:

Choosing an incorrect type number might cause your system to format the floppy disk improperly.

Item	Factory Default
Drive A	1.44M, 3.5"
Drive B	None

Video

This refers to the type of adapter used for the primary system monitor. You should choose the setting that matches your video display card and monitor. The four options are as follows:

EGAVGA	Select this setting for EGA, VGA, SVGA and PGA monitor adapters (Enhanced Graphics Adapter/ Video Graphics Array).
--------	--



CGA40	Power up in 40-column mode (Color Graphics Adapter).
CGA80	Power up in 80-column mode (Color Graphics Adapter).
Mono	Includes high resolution monochrome adapters (Monochrome adapter).

Halt on

This category controls whether the system will halt in case an error is detected during power up.

No Errors	The system boot will not stop for any errors detected.
All Errors	The system boot will stop whenever the BIOS detects a non-fatal error.
All, But Keyboard	The system boot will not stop for a keyboard error; it will stop for all other errors.
All, But Diskette	The system boot will not stop for a disk error; it will stop for all other errors.
All, But Disk/Key	The system boot will not stop for a disk or keyboard error; it will stop for all other errors.

Memory

The lower right corner of the Standard CMOS Setup Screen shows the base memory size, extended memory size and the memory size of your system.

Base Memory	This refers to the amount of base or conventional memory installed on the system board.
Extended Memory	This is the amount of memory located above 1MB in the memory address map of the CPU.
Other Memory	This memory size refers to the memory located in the address space between 640K and 1024K. DOS uses this area to load device drivers to keep base memory free for application programs. The most appropriate uses of this area is for Shadow RAM.

BIOS Features Setup

The BIOS Features Setup allows you to configure your system for basic operation. Some entries are defaults required by the system board, while others, if enabled, will improve the performance of your system or let you set some features according to your preference.

ROM PCI/ISA BIOS (2A59GD49)
BIOS FEATURES SETUP
AWARD SOFTWARE, INC.

Virus Warning	: Disabled	Video BIOS Shadow	: Enabled
CPU Internal Cache	: Enabled	C8000-CBFFF Shadow	: Disabled
External Cache	: Enabled	CC000-CFFFF Shadow	: Disabled
Quick Power On Self Test	: Enabled	D0000-D3FFF Shadow	: Disabled
Boot Sequence	: A, C	D4000-D7FFF Shadow	: Disabled
Swap Floppy Drive	: Disabled	D8000-DBFFF Shadow	: Disabled
Boot Up Floppy Seek	: Enabled	DC000-DFFFF Shadow	: Disabled
Boot Up NumLock Status	: On		
Gate A20 Option	: Fast		
Typematic Rate Setting	: Disabled	ESC :Quit	↑↓←→ :Select Item
Typematic Rate (Char/Sec)	: 6	F1 :Help	PU/PD/+/- :Modify
Typematic Delay (Msec)	: 250	F5 :Old Values (Shift)	F2 :Color
Security Option	: Setup	F6 :Load BIOS Defaults	
PCI/VGA Palette Snoop	: Disabled	F7 :Load Setup Defaults	
OS Select For DRAM>64MB	: Non-OS2		

Virus Warning

This category protects the boot sector and partition table of your hard disk drive. When this item is enabled, the Award BIOS will monitor the boot sector and partition table of the hard disk drive for any attempt at modification. If an attempt is made, the BIOS will halt the system and the following error message will appear.

! WARNING !
Disk boot sector is to be modified
Type "Y" to accept write or "N" to abort write
Award Software, Inc.

Afterwards, if necessary, you will be able to run an anti-virus program to locate and remove the problem before any damage is done.

Many disk diagnostic programs which attempt to access the boot sector table will cause the warning message to appear. If you are running such a program, we recommend that you first disable this category. Also, disable this category if you are installing or running certain operating systems like Windows 95 or the operating system may not install nor work.

Enabled	BIOS issues a warning when any program or virus sends a Disk Format command or attempts to write to the boot sector of the hard disk drive.
Disabled	No warning message will appear when the hard disk drive is accessed.

CPU Internal Cache and External Cache

These categories speed up the memory access. However, it depends on the CPU/chipset design. The default value is enabled. Enable the External Cache for better performance.

Enabled	Enables the internal/external cache.
Disabled	Disables the internal/external cache.

Quick Power On Self Test

This category speeds up Power On Self Test (POST) after you power up the computer. If it is set to Enable, BIOS will shorten or skip some check items during POST.

Enabled	Enabled quick POST.
Disabled	Normal POST.

Boot Sequence

This category determines which drive to search first for the disk operating system (i.e., DOS). Default value is A, C.

A, C	System will first search for a floppy drive and then a hard disk drive.
C, A	System will first search for a hard disk drive and then a floppy disk drive.



Swap Floppy Drive

Enabled	When this option is enabled and the system is booting from the floppy drive, this option causes the system to boot from drive B instead of drive A.
Disabled	When this option is disabled and the system is booting from the floppy drive, the system will boot from drive A.

Boot Up Floppy Seek

During POST, BIOS will determine if the floppy disk drive is 40 or 80 tracks. 360KB type is 40 tracks while 720KB, 1.2M, 1.44M and 2.88MB are all 80 tracks. The default value is Enabled.

Enabled	BIOS will check whether the floppy disk drive installed is 40 or 80 tracks. 360KB floppy disk drives have 40 tracks while 720KB, 1.2MB 1.44MB and 2.88MB floppy drives all have 80 tracks.
Disabled	BIOS will not search for the type of floppy disk drive by track number. There will not be any warning message if the drive installed is 360KB.

Boot up NumLock Status

This allows you to determine the default state of the numeric keypad. The default value is On.

On	The function of the numeric keypad is the number keys.
Off	The function of the numeric keypad is the arrow keys.

Gate A20 Option

This entry allows you to select how the gate A20 is handled. The gate A20 is a device used to address memory above 1 Mbytes. Initially, the gate A20 was handled via a pin on the keyboard. Today, while keyboards still provide this support, it is more common, and much faster, for the system chipset to provide support for gate A20. The default value is Fast.



Normal	Keyboard
Fast	Chipset

Typematic Rate Setting

When disabled, continually holding down a key on your keyboard will cause the BIOS to report that the key is down. When the typematic rate is enabled, the BIOS will not only report that the key is down, but will first wait for a moment, and, if the key is still down, it will begin to report that the key has been depressed repeatedly. For example, you would use such a feature to accelerate cursor movements with the arrow keys.

Enabled	Enable the typematic rate.
Disabled	Disable the typematic rate.

Typematic Rate (Chars/Sec)

When the typematic rate is enabled, this selection allows you to select the rate at which the keys are accelerated.

6	6 characters per second
8	8 characters per second
10	10 characters per second
12	12 characters per second
15	15 characters per second
20	20 characters per second
24	24 characters per second
30	30 characters per second

Typematic Delay (Msec)

When the typematic rate is enabled, this selection allows you to select the delay between when the key was first depressed and when the acceleration begins.



250	250 msec
500	500 msec
750	750 msec
1000	1000 msec

Security Option

This category allows you to limit access to the system and setup, or just to setup. The default value is Setup.

System	The system will not boot and access to setup will be denied if the correct password is not enter at the prompt.
Setup	The system will boot, but access to setup will be denied if the correct password is not entered at the prompt.

PCI/VGA Palette Snoop

It determines whether the MPEG ISAVESA VGA Cards can work with PCI/VGA or not. The default value is Disabled.

Enabled	PCI/VGA working with MPEG ISAVESA VGA Card.
Disabled	PCI/VGA not working with MPEG ISAVESA VGA Card.

OS Select for DRAM > 64MB

This item allows you to access the memory that is over 64MB in OS/2. The options are: Non-OS2 and OS2.

Video BIOS Shadow

Determines whether video BIOS will be copied to RAM. Video Shadow will increase the video speed. The default value is Enabled.

Enabled	Video shadow is enabled.
Disabled	Video shadow is disabled.



C8000-CBFFF Shadow to DC000-DFFFF Shadow

These categories determine whether option ROMs will be copied to RAM

Enabled	Optional shadow is enabled.
Disabled	Optional shadow is disabled.

Chipset Features Setup

The C586VX system board uses the Intel 82430VX chipset. This section allows you to configure the system based on the specific features of the chipset. This chipset manages bus speeds and access to system memory resources, such as DRAM and the external cache. It also coordinates communications between the conventional ISA bus and the PCI bus. These items should not be altered unless necessary. The default settings have been chosen because they provide the best operating conditions for your system. The only time you might consider making any changes would be if you discovered that data was being lost while using your system.

ROM PCI/ISA BIOS (2A59GD49)
CHIPSET FEATURES SETUP
AWARD SOFTWARE, INC.

Auto Configuration	: Enabled		
DRAM Timing	: 60 ns		
DRAM RAS# Precharge Time	: 3		
DRAM R/W Leadoff Timing	: 6		
Fast RAS To CAS Delay	: 3		
DRAM Read Burst (EDO/FP)	: x222/x333		
DRAM Write Burst Timing	: x222		
Fast MA to RAS# Delay CLK	: 1		
Fast EDO Path Select	: Disabled		
Refresh RAS# Assertion	: 4 Clks		
ISA Bus Clock	: PCICLK/4		
System BIOS Cacheable	: Enabled	ESC :Quit	↑↓←→ :Select Item
Video BIOS Cacheable	: Enabled	F1 :Help	PU/PD/+/- :Modify
8 Bit I/O Recovery Time	: 1	F5 :Old Values	(Shift) F2 :Color
16 Bit I/O Recovery Time	: 1	F6 :Load BIOS Defaults	
Memory Hole At 15M-16M	: Disabled	F7 :Load Setup Defaults	
Peer Concurency	: Enabled		

Auto Configuration

Enabled	The system will set the DRAM Timing automatically. The predefined items will become show-only.
Disabled	The system will set the DRAM Timing to manual.



Power Management Setup

The Power Management Setup allows you to configure your system to most effectively save energy.

ROM PCI/ISA BIOS (2A59GD49)
POWER MANAGEMENT SETUP
AWARD SOFTWARE, INC.

Power Management : Disabled	** Power Down & Resume Events **
PM Control by APM : Yes	IRQ3 (COM 2) : On
Video Off Method : V/H SYNC+Blank	IRQ4 (COM 1) : On
	IRQ5 (LPT 2) : On
	IRQ6 (Floppy Disk) : On
Doze Mode : Disabled	IRQ7 (LPT 1) : On
Standby Mode : Disabled	IRQ8 (RTC Alarm) : On
Suspend Mode : Disabled	IRQ9 (IRQ2 Redir) : Off
HDD Power Down : Disabled	IRQ10(Reserved) : On
	IRQ11(Reserved) : On
** Wake Up Events In Doze & Standby **	IRQ12 (PS2 Mouse) : On
IRQ3 (Wake-Up Event) : On	IRQ13 (Coprocessor) : On
IRQ4 (Wake-Up Event) : On	IRQ14 (Hard Disk) : On
IRQ8 (Wake-Up Event) : On	IRQ15 (Reserved) : Off
IRQ12 (Wake-up Event) : On	
	ESC :Quit ↑↓←→ :Select Item
	F1 :Help PU/PD/+/- :Modify
	F5 :Old Values (Shift) F2 :Color
	F6 :Load BIOS Defaults
	F7 :Load Setup Defaults

Power Management

This category allows you to select the type (or degree) of power saving and is directly related to the following modes: Doze Mode, Standby Mode, and Suspend Mode. The default value is Disabled.

Disabled	No power management. Disables all three modes.
Min Power Saving	The predefined timer settings that have the max values. Doze Mode=1hr. Standby Mode=1hr., Suspend Mode=1hr., and HDD Power Down=15min.
Max Power Saving	The predefined timer settings that have the min values. Doze Mode=1min., Standby Mode=1min., Suspend Mode=1min., and HDD Power Down=1min.
User Defined	Allows you to set each mode individually. When not disabled, each ranges from 1min. to 1hr. except for HDD Power Down which ranges from 1min. to 15 min. and disable.

PM Control by APM

If the Max Power Saving is not enabled, this will be preset to No. The default value is Yes.



Yes	<p>System Power Management will wait for the APM calls before it enters a software power management mode.</p> <p>Note: If the APM is installed and there is a task running, the APM will not prompt the BIOS to put the system into any of the power management modes even if the APM timer is out.</p> <p>Normally, the APM is installed in the DOS and Windows systems by loading the device C:\DOS\POWER.EXE file in CONFIG.SYS. In Windows 95, enable Power Management before installing the operating system or the Windows 95 APM may not work.</p>
Nb	<p>The System BIOS will ignore Advanced Power Management (APM) when initiating the power management mode.</p> <p>Note: If the APM is not installed, this option has no effect.</p>

Video Off Method

This determines the manner in which the monitor is blanked. The default value is V/H SYNC + Blank.

V/H SYNC+ Blank	<p>This selection will cause the system to turn off the vertical and horizontal synchronization ports and write blanks to the video buffer.</p> <p>Note: After detecting the V/H SYNC signals, an energy saving monitor will turn off its table.</p>
Blank Screen	<p>This option only writes blanks to the video buffer.</p>
DPMS	<p>This option should be enabled only for VGA cards supporting DPMS. Initial Display Power Management Signaling.</p>

Doze Mode

When enabled and after the set time of the system inactivity, the CPU clock will run at slower speed while all other devices still operate at full speed. The default value is Disabled.



Disabled	This function cannot be executed.
1Min-1Hr	This option defines the idle time that elapses before the system enters the Doze mode.

Standby Mode

When enabled and after the set time of the system inactivity, the fixed disk drive and the video would be shut off while all other devices still operate at full speed. The default value is Disabled.

Disabled	This function cannot be executed.
1Min-1Hr	The Standby mode will be set to one minute. This option defines the idle time that elapses before the system enters Standby mode.

Suspend Mode

When enabled and after the set time of system inactivity, all devices except the CPU will be shut off. The default value is Disabled.

Disabled	This function cannot be executed.
1Min-1Hr	The Suspend mode will be set to one minute. This option defines the idle time that elapses before the system enters the Suspend mode.

HDD Power Mode

When enabled and after the set time of system inactivity, the hard drive will be powered down while all other devices remain active. The default value is Disabled.



Disabled	This function cannot be executed.
1Min-	The HDD Power Down mode will be set to one minute.
15Min	The option defines the continuous HDD idle that elapses before the HDD enters the power saving mode (motor off). Note: When a HDD is in power saving mode, any access to the HDD will wake up the HDD.

Wake Up Event In Doze & Standby (IRQ3, 4, 8 and 12)

The default value is On.

On	The activity of this wake-up event causes the timers to be reset, i.e., the Power Management Unit (PMU) monitors the specified activities as power management events.
Off	The activity of this event will not affect the power management timers.

Power Down & Resume Events (IRQ 3 - 15)

Power Down and Resume events are I/O events whose occurrence can prevent the system from entering a power saving mode or can awaken the system from such a mode. In effect, the system remains alert for anything which occurs to a device which is configured as On, even when the system is in a power down mode.

The following is a list of IRQ's, Interrupt ReQuests, which can be exempted much as the COM ports and LPT ports above can. When an I/O device wants to gain the attention of the operating system, it signals this by causing an IRQ to occur. When the operating system is ready to respond to the request, it interrupts itself and performs the service.

When set on, activity will neither prevent the system from going into a power management mode nor awaken it.

The default value is On.

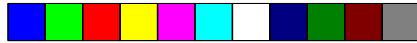

On	The activity of this event causes the power management timers to be reset, i.e., the Power Management Unit (PMU) monitors the specified activities as power management events.
Off	The activity of this event will not affect the power management timers.

PNP/PCI Configuration Setup

This section describes configuring the PCI bus system. PCI, or Personal Computer Interconnect, is a system which allows I/O devices to operate at speeds nearing the speed the CPU itself uses when communicating with its own special components. This section covers some very technical items and it is strongly recommended that only experienced users should make any changes to the default settings.

ROM PCI/ISA BIOS (2A59GD49)
PNP/PCI CONFIGURATION SETUP
AWARD SOFTWARE, INC.

Resources Control By :Auto	PCI IRQ Active By : Level
Reset Configuration Data :Disabled	PCI IDE IRQ Map To : PCI-AUTO
	Primary IDE INT# : A
	Secondary IDE INT# : B
ESC :Quit ↑↓←→ :Select Item F1 :Help PU/PD/+/- :Modify F5 :Old Values (Shift) F2 :Color F6 :Load BIOS Defaults F7 :Load Setup Defaults	

Resources Controlled By

The BIOS has the capacity to automatically configure all of the boot and compatible devices. However, this capability means absolutely nothing unless you are using an operating system such as Windows 95. The default value is Auto.

Auto	The BIOS will control the locations of the resources.
Manual	You can set the locations of the resources. The screen will appear the information of the IRQ and DMA.



Reset Configuration Data

This item allows you to determine whether to reset the configuration data or not.

Enabled	The BIOS will reset the configuration data automatically.
Disabled	The BIOS will not reset the configuration data.

PCI IRQ Activated By

This sets the method by which the PCI bus recognizes that an IRQ service is being requested by a device. Under all circumstances, you should retain the default configuration unless advised otherwise by your system's manufacturer. The default value is Level.

Level	The interrupt will be controlled by the level.
Edge	The interrupt will be controlled by the edge.

PCI IDE IRQ Map To

This allows you to configure your system to the type of IDE disk controller in use. By default, setup assumes that your controller is an ISA device rather than a PCI controller. The more apparent difference is the type of the slot being used.

If you have equipped your system with a PCI controller, changing this allows you to specify which slot has the controller and which PCI interrupt (A, B, C or D) is assumed with the connected hard devices.

This setting refers to the hard disk drive itself, rather than individual partitions. Since each IDE controller supports two separate hard drives, you can select the INT# for each. You will note that the primary has a lower interrupt than the secondary.

Selecting "PCI Auto" allows the system to automatically determine how your IDE disk system is configuration. The default value is PCI-Auto.

PCI-Auto	The BIOS will scan for PCI IDE devices and determine the location of the PCI IDE device.
ISA/PCI-Slot 1-4	You can determine the location of the PCI IDE device in ISA, PCI-SLOT 1, 2 ,3 or 4.

Primary/Secondary IDE INT

A/B/C/D	You can choose INT A, B, C or your D PCI IDE card is using for its interrupt.
---------	---

Load BIOS Defaults

The “Load BIOS Defaults” option loads the troubleshooting default values permanently stored in the ROM chips. These settings are not optimal and turn off all high performance features. You should use these values only if you have hardware problems. Highlight this option on the main menu and press <Enter>. The message below will appear.

Load BIOS Defaults (Y/N)? N

If you want to proceed, press <Y> and the default settings will be loaded.

Load Setup Defaults

The “Load Setup Defaults” option loads optimized settings from the BIOS ROM. Use the Setup default values as standard values for your system

Highlight this option on the main menu and press <Enter>. The message below will appear.

Load Setup Defaults (Y/N)? N

Type <Y> and press <Enter> to load the Setup default values.

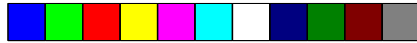

Integrated Peripherals

Use the arrow keys to highlight “Integrated Peripherals” and press <Enter>. A screen similar to the one below will appear.

ROM PCI/ISA BIOS (2A59GD49)
INTEGRATED PERIPHERALS
AWARD SOFTWARE, INC.

IDE HDD Block Mode	: Enabled		
IDE Primary Master PIO	: AUTO		
IDE Primary Slave PIO	: AUTO		
IDE Secondary Master PIO	: AUTO		
IDE Secondary Slave PIO	: AUTO		
On-Chip Primary PCI IDE	: Enabled		
On-Chip Secondary PCI IDE	: Enabled		
PCI Slot IDE 2nd Channel	: Disabled		
Onboard FDD Controller	: Enabled		
Onboard Serial Port 1	: 3F8/IRQ4		
Onboard Serial Port 2	: 2F8/IRQ3		
UART 2 Mode	: Standard		
Onboard Parallel Port	: 378H/IRQ7		
Onboard Parallel Mode	: SPP		
		ESC	:Quit ↑↓←→ :Select Item
		F1	:Help PU/PD/+/- :Modify
		F5	:Old Values (Shift) F2 :Color
		F6	:Load BIOS Defaults
		F7	:Load Setup Defaults

IDE HDD Block Mode

If this option is enabled, the system BIOS will check the hard disk drive for the maximum block size the system can transfer. The block size depends on the type of your hard disk. If the option is disabled, the system BIOS will check the hard disk drive for standard mode. The default value is Enabled.

Enabled	IDE controller uses block mode.
Disabled	IDE controller uses standard Mode.

IDE Primary or Secondary Master/Slave PIO

IDE hard drive controllers can support up to two separate hard drives. These drives have a master/slave relationship which are determined by the cabling configuration used to attach them to the controller. Your system supports two IDE controllers - a primary and a secondary - so you have to ability to install up to four separate hard disks.

PIO means Programmed Input/Output. Rather than have the BIOS issue a series of commands to effect a transfer to or from the disk drive, PIO allows the BIOS to tell the controller what it wants and then let the controller and the CPU perform the complete task by themselves. The simpler and more efficient (and faster).



Your system supports five modes, numbered from 0 (default) to 4, which primarily differ in timing. When Auto is selected, the BIOS will select the best available mode.

Auto	The BIOS will set the system board to fit the hard disk drive timing automatically.
Mode 0-4	You can select the setting to fit your hard disk timing.

On-Chip Primary/Secondary PCI IDE

This setup item allows you to either enable or disable the primary/secondary controller. You might choose to disable the controller if you were to add a higher performance or specialized controller. The default value is Enabled.

Enabled	Primary/Secondary HDD controller used.
Disabled	Primary/Secondary HDD controller not used.

PCI Slot IDE 2nd Channel

This item allows you to designate an IDE controller board inserted into one of the physical PCI slots as your secondary IDE controller. The default value is Disabled.

Enabled	External IDE Controller designated as the secondary controller.
Disabled	No IDE controller occupying a PCI slot.

Onboard FDD Controller

This item allows you to designate a floppy controller board inserted into one of the slots as your floppy controller. The default value is Enabled.

Enabled	FDD Controller used.
Disabled	FDD Controller not used.



Onboard Serial Port 1 or 2

This option allows you to control the assignment of the serial port 1 or 2 connector on the system board. The default value of port 1 is 3F8/IRQ4, and that of port 2 is 2F8/IRQ3.

Disabled	When disabled, you cannot set the assignment of the serial port.
3F8/IRQ4 2F8/IRQ3 3E8/IRQ4 2E8/IRQ3	This option allows you to control the assignment of the serial port 1 or 2 connector on the system board.

UART 2 Mode

This item allows you to use IrDA function. The default value is Standard.

Standard	If you are using the COM 2 serial port
HPSIR	If you are using IrDA of HP that is an HP standard.
ASKIR	If you are using IrDA of SHARP that is a SHARP standard.

Onboard Parallel Port

The default value is 378H/IRQ7.

Disabled	When disabled, you cannot select the address and IRQs of the onboard parallel port.
278H/IRQ5 378H/IRQ7 3BC/IRQ7	This option allows you to select different addresses and IRQs the onboard parallel port.

Parallel Port Mode

The default value is SPP.



SPP	This function is the mode of the device. Set this according to your parallel devices.
EPP/SPP	
ECP	
ECP/EPP	

Supervisor Password

If you want to protect your system and setup from unauthorized entry, set a supervisor's password with the "System" option selected in the BIOS Features Setup.

If you want to protect access to setup only, but not your system, set a supervisor's password with the "Setup" option selected in the BIOS Features Setup. You will not be prompted for a password when you cold boot the system.

Use the arrow keys to highlight the "Supervisor Password" option and press <Enter>. The message below will appear.

Enter Password:

Type in the password. You are limited to eight characters. When done, the message below will appear:

Confirm Password:

You are asked to verify the password. Type in exactly the same password. If you type in a wrong password, you will be prompted to enter the correct password again.

To delete or disable the password function, highlight "Supervisor Password" and press <Enter>, instead of typing in a new password. Press the <Esc> key to return to the main menu.

User Password

If you want another user to have access only to your system but not to setup, set a user's password with the "System" option selected in the BIOS Features Setup.



If you want a user to enter a password when trying to access setup, set a user's password with the "Setup" option selected in the BIOS Features Setup. Using user's password to enter Setup allows a user to access only the "User Password" option that appears on the main screen. Access to all other options is denied.

To set, confirm, verify, disable or delete a user's password, follow the procedures described in the section "Supervisor Password". If you forget your password, refer to the procedure described in the same section.

IDE HDD Auto Detection

This option detects the hard disk parameters for the hard disk drives installed in your system. Highlight this option and press <Enter>. A screen similar to the one below will appear.

ROM PCI/ISA BIOS (2A59GD49)
CMOS SETUP UTILITY
AWARD SOFTWARE, INC.

HARD DISKS	TYPE	SIZE	CYLS	HEAD	RECOMP	LANDZ	SECTOR	MODE
Primary Master:								
Select Primary Master Option (N=Skip): N								
OPTIONS	SIZE	CYLS	HEAD	RECOMP	LANDZ	SECTOR	MODE	
2 (Y)	853	827	32	0	1653	63	LBA	
1	853	1654	16	65535	1653	63	Normal	
3	853	827	32	65536	1653	63	Large	
Note: Some OS (like SCO-UNIX) must be "NORMAL" for installation								
ESC: Skip								

Enter your choice, and press <Enter> to accept the parameters or press <Esc> to abort. The parameters of the hard disk will be displayed in the Standard CMOS Setup.

Hard Drive Mode

The C586VX supports three HDD modes: Normal, LBA and Large. If your hard disk drive does not support LBA mode, the "LBA" option will not be displayed. If your HDD has 1024 or fewer cylinders, the "Large" option will not be displayed.



Normal Mode

The Normal mode is the generic access mode in which neither the BIOS nor the IDE controller will make any transformations during hard-drive access.

The maximum number of cylinders, heads and sectors for Normal mode are 1024, 16 and 63, respectively.

no. Cylinders	(1024)
x no. Heads	(16)
x no. Sectors	(63)
x bytes per sector	(512)

528 megabytes

If you set your HDD to Normal mode, the maximum accessible HDD will be 528 megabytes even though the physical size of the HDD may be greater than that.

LBA (Logical Block Addressing) Mode

The LBA mode is a HDD accessing method to overcome the 528 megabyte limitation. The number of cylinders, heads and sectors shown on the screen may not be the actual number for the HDD.

During the HDD accessing, the IDE controller will transform the logical address described by the sector, head and cylinder number into its own physical address inside the HDD.

The maximum HDD size supported by the LBA mode is 8.4 gigabytes. It is obtained by the following formula.

no. Cylinders	(1024)
x no. Heads	(225)
x no. Sectors	(63)
x bytes per sector	(512)

8.4 gigabytes

Large Mode

Large mode is the extended HDD access mode supported by the C586VX system boards. Some IDE HDDs have more than 1024 cylinders without LBA support (in some cases, you may not want the LBA mode). These system boards provide another alternative to support these kinds of HDDs.

The BIOS tells the operating system that the number of cylinders is half of the actual number and that the number of heads is double the actual number. During disk access, the reverse conversion is done by the INT13h routine.

Example of Large mode:

CYLS.	HEADS	SECTORS	MODE
1120	16	59	NORMAL
560	32	59	LARGE

Maximum HDD size:

no. Cylinders	(1024)
x no. Heads	(32)
x no. Sectors	(63)
x bytes per sector	(512)
<hr/>	
	1 gigabyte

Note:

To support LBA or Large mode, address translation software is included in the Award BIOS HDD Service Routine (INT13h). If you are running an operating system that bypasses the BIOS Int13 Service Routine, LBA and Large Mode may fail.

HDD Low Level Format

This option will format, set the interleave mode and do a media analysis of your hard drives. Highlight this option and press <Enter>. A screen similar to the one on the next page will appear.

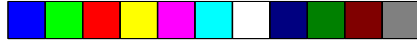

ROM PCI/ISA BIOS (2A59GD49)
CMOS SETUP UTILITY
AWARD SOFTWARE, INC.

Hard Disk Low Level Format Utility							No. CYLS HEAD
SELECT DRIVE							
BAD TRACK LIST							
PERFORMED							
Current select drive is : C							
DRIVE: C CYLINDER: 0 HEAD: 0							
	SIZE	CYLS	HEAD	RECOMP	LANDZ	SECTOR	MODE
Primary Master:	853	1654	16	65536	1653	63	AUTO
Primary Slave:	0	0	0	0	0	0	AUTO
Secondary Master:	0	0	0	0	0	0	AUTO
Secondary Slave:	0	0	0	0	0	0	AUTO
Up/Down-Select item ENTER-Accept ESC-Exit/Abort							
Copyright (C) Award Software, Inc. 1992-94 All Rights Reserved							

Warning:

Do not attempt to do a low-level format on an IDE drive, or you may cause serious damage to the drive. IDE disk drives are already low-level formatted, with any bad-track errors entered, when shipped by the drive manufacturer.

Save & Exit Setup

When all the changes have been made, highlight "Save & Exit Setup" and press <Enter>. The message below will appear:

Save to CMOS and Exit (Y/N)? N

Type "Y" and press <Enter>. The following message will appear:

Reboot System (Y/N)? N

Type "Y" and press <Enter>. The modifications you have made will be written into the CMOS memory, and the system will reboot. You will once again see the initial diagnostics on the screen. If you wish to make additional changes to the setup, press <Ctrl> <Alt> <Esc> simultaneously or after memory testing is done.



Exit Without Saving

When you do not want to save the changes you have made, highlight “Exit Without Saving” and press <Enter>. The message below will appear:

Quit Without Saving (Y/N)? N

Type “Y” and press <Enter>. The system will reboot and you will once again see the initial diagnostics on the screen. If you wish to make any changes to the setup, press <Ctrl> <Alt> <Esc> simultaneously or after memory testing is done.

System Error Report

When the BIOS encounters an error that requires the user to correct something, either a beep code will sound or a message will be displayed in a box in the middle of the screen and the message PRESS F1 TO CONTINUE, CTRL-ALT-ESC or DEL TO ENTER SETUP, will be shown in the information box at the bottom. Enter Setup to correct the error.

POST Beep

There is one beep code in the BIOS. This code indicates that a video error has occurred and the BIOS cannot initialize the video screen to display any additional information. This beep code consists of a single long beep followed by two short beeps. If you get this error, contact your system board vendor.

Error Messages

One or more of the following messages may be displayed if the BIOS detects an error during the POST.

DISK BOOT FAILURE, INSERT SYSTEM DISK AND PRESS ENTER

No boot device was found. Insert a system disk into Drive A and press <Enter>. If the system normally boots from the hard drive, make sure the controller is inserted correctly and all cables are properly attached. Also be sure the disk is formatted as a boot device. Reboot the system.



DISKETTE DRIVES OR TYPES MISMATCH ERROR - RUN SETUP

The type of diskette drive installed in the system is different from the CMOS definition. Run setup to reconfigure the drive type correctly.

DISPLAY SWITCH IS SET INCORRECTLY

The display switch on the system board can be set to either monochrome or color. This error indicates the switch is set to a different setting than indicated in Setup. Determine which setting is correct and either turn off the system and change the jumper or enter Setup and change the Video selection.

DISPLAY TYPE HAS CHANGED SINCE LAST BOOT

Since last powering off the system, the display adapter has been changed. You must configure the system for the new display type.

ERROR ENCOUNTERED INITIALIZING HARD DRIVE

The hard drive cannot be initialized. Be sure the adapter is installed correctly and all cables are correctly and firmly attached. Also, be sure the correct hard drive type is selected in Setup.

ERROR INITIALIZING HARD DISK CONTROLLER

The system cannot initialize the controller. Make sure the card is correctly and firmly installed in the bus. Be sure the correct hard drive type is selected in Setup. Also, check to see if any jumper needs to be set correctly on the hard drive.

FLOPPY DISK CNTRLR ERROR OR NO CNTRLR PRESENT

The system cannot find or initialize the floppy drive controller. Make sure the controller is installed correctly and firmly. If no floppy drive is installed, be sure the Diskette Drive selection in Setup is set to NONE.

KEYBOARD ERROR OR NO KEYBOARD PRESENT

Cannot initialize the keyboard. Make sure the keyboard is attached correctly and no keys are being pressed during the boot.

If you are purposely configuring the system without a keyboard, set the error halt condition in Setup to HALT ON ALL, BUT KEYBOARD. This will cause the BIOS to ignore the missing keyboard and continue the boot.



MEMORY ADDRESS ERROR AT...

Indicates a memory address error at a specific location. You can use this location along with the memory map for your system to find and replace the bad memory chips.

MEMORY SIZE HAS CHANGED SINCE LAST BOOT

Memory has been added or removed since the last boot. Enter Setup and enter the new memory size in the memory fields.

MEMORY VERIFY ERROR AT...

Indicates an error verifying a value already written to memory. Use the location along with your system's memory map to locate the bad chip.

OFFENDING ADDRESS NOT FOUND

This message is used in conjunction with the I/O CHANNEL CHECK and RAM PARITY ERROR messages when the segment that has caused the problem cannot be isolated.

OFFENDING SEGMENT

This message is used in conjunction with the I/O CHANNEL CHECK and RAM PARITY ERROR messages when the segment that has caused the problem has been isolated.

PRESS A KEY TO REBOOT

This will be displayed at the bottom screen when an error occurs that requires a reboot. Press any key and the system will reboot.

SYSTEM HALTED, (CTRL-ALT-DEL) TO REBOOT...

Indicates the present boot attempt has been aborted and the system must be rebooted. Press and hold down the CTRL, ALT and DEL keys simultaneously.

IDE Device Drivers

To install the IDE device drivers supported by the C586VX system boards, please refer to the "Readme" file contained in the provided diskette.



Chapter 4 Troubleshooting Checklist

If you experience difficulty with the C586VX system board, please refer to the checklist below. If you still cannot identify the problem, please contact your dealer.

1. Check the jumper settings to ensure that the jumpers are properly set. If in doubt, refer to the “Hardware Installation” section.
2. Verify that all SIMMs or DIMM are seated securely into the bank sockets.
3. Make sure the SIMMs or DIMM are in the correct locations.
4. Check that all populated memory banks are filled with correctly sized SIMMs.
5. If your board fails to function, place the board on a flat surface and seat all socketed components (gently press each component into the socket).
6. If you made changes to the BIOS settings, re-enter setup and load the BIOS defaults.

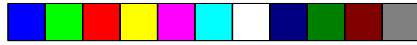

Appendix A Types of Modules

The C586VX system board allows you to populate memory with 1MBx64 or 2MBx64 DIMM, and 1MBx32, 2MBx32, 4MBx32 and 8MBx32 SIMMs. The following modules have been tested with this board. Most untested brands will work but a few may fail to do so.

DIMM

DIMM	Brand	Chip Number
1MBx64	NEC	D4516161G5-7JF (SDRAM)

SIMM

SIMM	Brand	Chip Number
1MBx32	Fujitsu	81C1000A-70
	OKI	M51440A-70
2MBx32	OKI	M511000B-70
	NEC	424400-60
	Micron	40447-60
	TI	TMS4400DJ-70
	Micron	MT4C4007-70 (EDO)
	Micron	MT4C4007-60 (EDO)
4MBx32	NEC	4218165-60 (EDO)
	Hitachi	7400AS-70
	Fujitsu	8117400-70
	Mitsubishi	422A06-70
	Hitachi	5117400AS-70
	NEC	4217400-60
8MBx32	NEC	4217405-70 (EDO)
	NEC	4217405-60 (EDO)



Appendix B Memory and I/O Maps

Memory Address Map

Address	Name	Function
0000000 to 009FFFF	640KB System Board RAM	System Board Memory
00A0000 to 00BFFFF	128KB Video Display Memory	Reserved for Graphics Display Memory
00C0000 to 00E7FFF	160KB I/O Expansion ROM	Reserved for ROM on I/O Adapter Card
00E8000 to 00FFFFFF	96KB ROM on the System Board	System Board BIOS
0100000 to 7FFFFFFF	Maximum Memory 128MB	System Board Memory

I/O Address Map

I/O Address	Function
0000-001F	DMA Controller 1, 8237A-5
0020-003F	Interrupt Controller 1, 8259A, Master
0040-005F	Timer, 8254-2
0060-006F	8742 (Keyboard Controller)
0070-007F	Real-time Clock, NMI (Non-maskable Interrupt) Mask
0080-009F	DMA Page Memory, 74LS612
00A0-00BF	Interrupt Controller 2, 8259A
00C0-00DF	DMA Controller 2, 8237A-5
00E8	Shadow RAM and Cache Control Bit
00F0	Clear Numeric Processor Extension Busy
00F1	Reset Numeric Processor Extension
00F8-00FF	Numeric Processor Extension
01F0-01F8	Fixed Disk
0200-0207	Game I/O
0278-027F	Parallel Printer Port 2
02F8-02FF	Serial Port 2
0300-031F	Prototype Card
0360-036F	Reserved
0378-037F	Parallel Printer Port 1
0380-038F	SDLC, Bisynchronous 2
03A0-03AF	Bisynchronous 1
03B0-03BF	Monochrome Display and Printer Adapter
03C0-03CF	Reserved
03D0-03DF	Color/Graphics Monitor Adapter
03F0-03F7	Diskette Controller
03F8-03FF	Serial Port 1

Note:

The I/O address hex 0000 to 00FF are reserved for the system board I/O. Hex 0100 to 03FF are available on the I/O channels.

Appendix C PCI I/O Pin Assignments

Component Side	B	A	Solder Side
	-12V	- 01 -	TRST#
	TCK	- 02 -	+12V
	Ground	- 03 -	TMS
	TDO	- 04 -	TDI
	+5V	- 05 -	+5V
	+5V	- 06 -	INTA#
	INTB#	- 07 -	INTC#
	INTD#	- 08 -	+5V
	PRSNT1#	- 09 -	Reserved
	Reserved	- 10 -	+5V (I/O)
	PRSNT2#	- 11 -	Reserved
	Ground	- 12 -	Ground
	Ground	- 13 -	Ground
	Reserved	- 14 -	Reserved
	Ground	- 15 -	RST#
	CLK	- 16 -	+5V (I/O)
	Ground	- 17 -	GNT#
	REQ#	- 18 -	Ground
	+5V (I/O)	- 19 -	Reserved
	AD[31]	- 20 -	AD[30]
	AD[29]	- 21 -	N. C.
	Ground	- 22 -	AD[28]
	AD[27]	- 23 -	AD[26]
	AD[25]	- 24 -	Ground
	N. C.	- 25 -	AD[24]
	C/BE[3]#	- 26 -	IDSEL
	AD[23]	- 27 -	N. C.
	Ground	- 28 -	AD[22]
	AD[21]	- 29 -	AD[20]
	AD[19]	- 30 -	Ground
	N. C.	- 31 -	AD[18]
	AD[17]	- 32 -	AD[16]
	C/BE[2]#	- 33 -	N. C.
	Ground	- 34 -	FRAME#
	IRDY#	- 35 -	Ground
	N. C.	- 36 -	TRDY#
	DEVSEL#	- 37 -	Ground
	Ground	- 38 -	STOP#
	LOCK#	- 39 -	N. C.
	PERR#	- 40 -	SDONE
	N. C.	- 41 -	SBO#
	SERR#	- 42 -	Ground
	N. C.	- 43 -	PAR
	C/BE[1]#	- 44 -	AD[15]
	AD[14]	- 45 -	N. C.
	Ground	- 46 -	AD[13]
	AD[12]	- 47 -	AD[11]
	AD[10]	- 48 -	Ground
	Ground	- 49 -	AD[09]
	AD[08]	- 52 -	C/BE[0]#
	AD[07]	- 53 -	N. C.
	N. C.	- 54 -	AD[06]
	AD[05]	- 55 -	AD[04]
	AD[03]	- 56 -	Ground
	Ground	- 57 -	AD[02]
	AD[01]	- 58 -	AD[00]
	+5V (I/O)	- 59 -	+5V (I/O)
	ACK64#	- 60 -	REQ64#
	+5V	- 61 -	+5V
	+5V	- 62 -	+5V



Appendix D ISA I/O Pin Assignments

B		A
Ground	- 01 -	-I/OChck
ResetDrv	- 02 -	SD7
+5V	- 03 -	SD6
IRQ9	- 04 -	SD5
-5V	- 05 -	SD4
DRQ2	- 06 -	SD3
-12V	- 07 -	SD2
O/S	- 08 -	SD1
+12V	- 09 -	SD0
Ground	- 10 -	-I/OChrdy
-SEMEMV	- 11 -	AEN
-SEMEMR	- 12 -	SA19
-IOW	- 13 -	SA18
-IOR	- 14 -	SA17
-Dack3	- 15 -	SA16
-DRQ3	- 16 -	SA15
-Dack1	- 17 -	SA14
DRQ1	- 18 -	SA13
-Refresh	- 19 -	SA12
CLK	- 20 -	SA11
IRQ7	- 21 -	SA10
IRQ6	- 22 -	SA9
IRQ5	- 23 -	SA8
IRQ4	- 24 -	SA7
IRQ3	- 25 -	SA6
-Dack2	- 26 -	SA5
TC	- 27 -	SA4
Bale	- 28 -	SA3
+5V	- 29 -	SA2
OSC	- 30 -	SA1
Ground	- 31 -	SA0

D		C
-MemCS16	- 01 -	SBHE
-I/OCS16	- 02 -	LA23
IRQ10	- 03 -	LA22
IRQ11	- 04 -	LA21
IRQ12	- 05 -	LA20
IRQ13	- 06 -	LA19
IRQ14	- 07 -	LA18
-Dack0	- 08 -	LA17
DRQ0	- 09 -	-Memr
-Dack5	- 10 -	-Memw
DRQ5	- 11 -	SD08
-Dack6	- 12 -	SD09
DRQ6	- 13 -	SD10
-Dack7	- 14 -	SD11
DRQ7	- 15 -	SD12
+5V	- 16 -	SD13
-Master	- 17 -	SD14
Ground	- 18 -	SD15

Appendix E Connector Pin Assignments

Connector J3 PS/2 Mouse Connector

Pin	Function
1	Mouse Data
2	N.C.
3	Ground
4	+5V
5	Mouse Clock
6	N.C.

J4 (COM1) and J5 (COM2) COM 1 and COM 2 Serial Ports

Pin	Function
1	DCD (Data Carrier Detect)
2	RX (Receive Data)
3	TX (Transmit Data)
4	DTR (Data Terminal Ready)
5	Ground (Signal Ground)
6	DSR (Data Set Ready)
7	RTS (Request to Send)
8	CTS (Clear to Send)
9	RI (Ring Indicator)

Connector J6 Floppy Disk Drive Connector

Pin	Function	Pin	Function
1	Ground	12	DR1
2	DENSEL	13	Ground
3	Ground	14	DR0
4	N.C.	15	Ground
5	Ground	16	MTR1
6	Drate0	17	Drate1
7	Ground	18	Dir
8	Index	19	Ground
9	Ground	20	Step
10	MTR0	21	Ground
11	Ground	22	Write Data

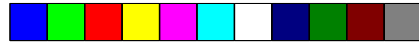

Pin	Function
23	Ground
24	Write Gate
25	Ground
26	Track 0
27	MSEN
28	Wr Protect

Pin	Function
29	Ground
30	Read Data
31	Ground
32	Head Select
33	Ground
34	Disk Change

Connector J7
Parallel Printer Port

Pin	Function
1	-Strobe
2	Data 0
3	Data 1
4	Data 2
5	Data 3
6	Data 4
7	Data 5
8	Data 6
9	Data 7
10	-Ack
11	Busy
12	Paper Empty
13	Select

Pin	Function
14	-Autofd
15	-Error
16	-Init
17	-SlctIn
18	Ground
19	Ground
20	Ground
21	Ground
22	Ground
23	Ground
24	Ground
25	Ground

Connectors J8 and J9
Primary and Secondary IDE Hard Disk Drive Connectors

Pin	Function
1	-Reset
2	Ground
3	D7
4	D8
5	D6
6	D9
7	D5
8	D10
9	D4
10	D11
11	D8
12	D12
13	D2
14	D13
15	D1

Pin	Function
16	D14
17	D0
18	D15
19	Ground
20	N.C.
21	N.C.
22	Ground
23	-IOW
24	Ground
25	-IOR
26	Ground
27	N.C.
28	BALE
29	N.C.
30	Ground



Pin	Function	Pin	Function
31	IRQ	36	SA2
32	IOCS16	37	HCS0
33	SA1	38	HCS1
34	N.C.	39	LED
35	SA0	40	Ground

Connector J10
Fan Connector

Pin	Function
1	Ground
2	+12V
3	Ground

Connector J11
Infrared Connector

Pin	Function
1	IRTX
2	Ground
3	IRRX
4	N.C.
5	+5V

Connector J13
HD LED Connector

Pin	Function
1	Signal
2	+5V

Connector J14
Green LED Connector

Pin	Function
1	+5V
2	Signal

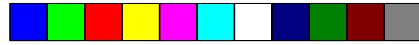

Connector J15
Green Button Connector

Pin	Function
1	Ground
2	Signal

Connector J16
Reset Switch Connector

Pin	Function
1	Ground
2	Reset

Connector J17
Speaker Connector

Pin	Function
1	Signal
2	N.C.
3	Ground
4	+5V

Connector J18
Power LED/Keylock Connector

Pin	Function
1	LED Signal
2	N.C.
3	Ground
4	Keylock Signal
5	Ground

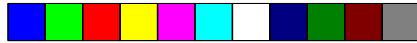

Connector CN1
PS/2 Keyboard Connector

Pin	Function
1	Keyboard Data
2	N.C.
3	Ground
4	+5V
5	Keyboard Clock
6	N.C.

Connector CN2
AT Keyboard Connector

Pin	Function
1	Keyboard Clock
2	Keyboard Data
3	N.C.
4	Ground
5	+5V

Connector PL1
Power Connector

Pin	Function
1	Power Good
2	+5V
3	+12V
4	-12V
5	Ground
6	Ground
7	Ground
8	Ground
9	-5V
10	+5V
11	+5V
12	+5V



Connector SSM1
Cache Module Slot

Pin	Function	Pin	Function
1	Ground	47	D48
2	TIO0	48	Ground
3	TIO2	49	D46
4	TIO6	50	D44
5	TIO4	51	D42
6	RSVD	52	+3V
7	+3V	53	D40
8	TWE#	54	D38
9	CADS#/CAA3	55	D36
10	Ground	56	Ground
11	HBE4#	57	D34
12	HBE6#	58	D32
13	HBE0#	59	D30
14	HBE2#	60	+3V
15	+3V	61	D28
16	CCS#/CAB4	62	D26
17	GVE#	63	D24
18	BWE#	64	Ground
19	Ground	65	D22
20	A3	66	D20
21	A7	67	D18
22	A5	68	+3V
23	A11	69	D16
24	A16	70	D14
25	+3V	71	D12
26	A18	72	Ground
27	Ground	73	D10
28	A12	74	D8
29	A13	75	D6
30	ADSP#	76	+3V
31	ECS1#/(CS#)	77	D4
32	ECS2#	78	D2
33	PD1	79	D0
34	PD3	80	Ground
35	Ground	81	Ground
36	CLK1	82	TIO1
37	Ground	83	TIO7
38	D62	84	TIO5
39	+3V	85	TIO3
40	D60	86	RSVD
41	D58	87	+5V
42	D56	88	RSVD
43	Ground	89	CADV#/CAA4
44	D54	90	Ground
45	D52	91	COE#
46	D50	92	HBE5#



Pin	Function	Pin	Function
93	HBE7#	127	D49
94	HBE1#	128	Ground
95	+5V	129	D47
96	HBE3#	130	D45
97	CAB3	131	D43
98	CALE	132	+5V
99	Ground	133	D41
100	RSVD	134	D39
101	A4	135	D37
102	A6	136	Ground
103	A8	137	D35
104	A10	138	D33
105	+5V	139	D31
106	A17	140	+5V
107	Ground	141	D29
108	A9	142	D27
109	A14	143	D25
110	A15	144	Ground
111	RSVD	145	D23
112	PD0	146	D21
113	PD2	147	D19
114	PD4	148	+5V
115	Ground	149	D17
116	CLK0	150	D15
117	Ground	151	D13
118	F63	152	Ground
119	+5V	153	D11
120	D61	154	D9
121	D59	155	D7
122	D57	156	+5V
123	Ground	157	D5
124	D55	158	D3
125	D53	159	D1
126	D51	160	Ground

Appendix F Row Address Strobe of the DRAM and SDRAM

After you power up your system, the BIOS message appears on your screen and the memory count begins.

After the memory test, the screen will appear as below:

Award Software, Inc.
System Configurations

CPU Type	:6x86-P166+	Base Memory	:640K
Co-Processor	:Installed	Extended Memory	:15360K
CPU Clock	:133MHz	Cache Memory	:256K
Diskette Drive A	:1.44M, 3.5in.	Display Type	:EGAVGA
Diskette Drive B	:None	Serial Port (s)	:3F8 2F8
Pri. Master Disk	:None	Parallel Port (s)	:378
Pri. Slave Disk	:None	EDO DRAM at Row (s)	: 0, 1
Sec. Master Disk	:None	SDRAM at Row (s)	:None
Sec. Slave Disk	:None	PB SRAM Presence	:Yes

EDO DRAM at Row (s)

"Row (s)" refers to the Row Address Strobe of the DRAM or SDRAM. The Row Address Strobe differs according to the location and type of DRAM or SDRAM installed on the system board. The table below shows the Row Address Strobe values with their corresponding type of SIM/DIM modules and Bank locations.

"Rows"	Number/Location of SIM or DIM modules	Types of SIM/DIM module (Single/Double Density)
0	2 SIMM / Bank 0	Single density EDO DRAM
0, 1	2 SIMM / Bank 0	Double density EDO DRAM
0, 2	4 SIMM / Bank 0, 1	Single density EDO DRAM
0, 1, 2, 3	4 SIMM / Bank 0, 1	Double density EDO DRAM
2	1 DIMM / DM1	Single density SDRAM
2, 3	1 DIMM / DM1	Double density SDRAM