FCC & DOC Compliance

Federal Communications Commission Statement

This device complies with FCC Rules Part 155. Operation is subject to the following two conditions:

- ◆ This device may not cause harmful interference
- ◆ This device must accept any interference received, including interference that may cause undesired operation.

This equipment has been tested and found to comply with the limits for a Class B digital device, pursuant to Part 15 of the FCC Rules. These limits are designed to provide reasonable protection against harmful interference in a residential installation. This equipment generates, uses and can radiate radio frequency energy. If this equipment is not installed and used in accordance with the manufacturer's instructions, it may cause harmful interference to radio communications. However, there is no guarantee that interference will not occur in a particular installation. If this equipment does cause harmful interference to radio or television reception, which can be determined by turning the equipment off and on, the user is encouraged to try to correct the interference by one or more of the following measures:

- ◆ Reorient or relocate the receiving antenna.
- ◆ Increase the separation between the equipment and receiver.
- ◆ Connect the equipment to an outlet on a circuit different from that to which the receiver is connected.
- ◆ Consult the dealer or an experienced radio/TV technician for help.

The use of shielded cables for connection of the monitor to the graphics card is required to assure compliance with FCC regulations. Changes or modifications to this unit not expressly approved by the party responsible for compliance could void the user's authority to operate this equipment.

Canadian Department of Communications Statement

This digital apparatus does not exceed the Class B limits for audio noise emissions from digital apparatuses set out in the Radio Interference Regulations of the Canadian Department of Communications.

The information in this document is subject to change without notice and does not represent a commitment on the part of the vendor.

No warranty or representation, either expressed or implied, is made with respect to the quality, accuracy or fitness for any particular purpose of this document. The manufacturer reserves the right to make changes to the content of this document and/or the products associated with it at any time without obligation to notify any person or organization of such changes.

In no event will the manufacturer be liable for direct, indirect, special, incidental or consequential damages arising out of the use or inability to use this product or documentation, even if advised of the possibility of such damages.

This document contains materials protected by copyright. All rights are reserved. No part of this manual may be reproduced or transmitted in any form, by any means or for any purpose without expressed written consent of it's authors.

Product names appearing in this document are mentioned for identification purposes only. All trademarks, product names or brand names appearing in this document are registered property of their respective owners.

Printed in Taiwan

March 1998
100% POST-CONSUMER
RECYCLED PAPER 

Table of Contents

PART I English Edition

Chapter 1 Introduction	1
1-1 Product Specifications	1
1-2 Package Contents	3
1-3 Mainboard Layout	4
1-4 Jumper and Connector Reference Page Chart	4
Chapter 2 Hardware Setup.....	5
2-1 Introduction to Jumpers	5
2-2 Installing a PGA type CPU in a ZIF Socket	6
2-3 Setting Your CPU's Parameters(SeePU Technology)	7
2-4 Connector and Jumper Settings	10
2-5 Main Memory Configuration	16
Chapter 3 Award BIOS Setup Program	19
3-1 Standard CMOS Setup	20
3-2 BIOS Features Setup	23
3-3 SeePU & Chipset Setup	26
3-4 Power Management Setup	29
3-5 PnP/PCI Configuration	34
3-6 Load Setup Defaults	36
3-7 Integrated Peripherals.....	37
3-8 Supervisor Password & User Password Setting	38
3-9 IDE HDD Auto Detection	40
3-10 Save and Exit Setup	40
3-11 Exit Without Saving	40
Chapter 4 Brief Software Driver Guide	41
- Bus Master/PIO IDE Driver Installation	
- USB Driver Installation	
- Removing the Exclamation and/or Question Marks From the Windows 95 Device Manager Menu	
- Updating Your System BIOS	
- Installing and Using a Desktop Management Interface (DMI) Utility	
Feature Explanations	
SeePU Technology	7
Software Power-Off Control	10/32
Power-On By Modem	10
Poly-fuse Over Current Protection	11
Over-ride Power Button Connector	12

Blinking LED in Suspend	12
APTC Technology	14
Management Extension Hardware for SMART Technology	14
Power Failure Recovery	15
Flash BIOS Protection	27
Hardware Reset Protect	28
Power On by Alarm	32

PART II Deutsche Anleitung (German Edition)

Kapitel 1	45
1-1 Technische Daten	45
1-2 Produktkomponenten	47
1-3 Einstellung der CPU Parameters (<i>SeePU</i> Technology)	48
1-4 Anschlüsse und Jumper-Einstellungen	51
1-5 Hauptspeicher-Konfiguration	56
1-6 Anschluß und Jumper Referenz	58
1-7 Treiber Installation	59
-Busmaster / PIO IDE-Treiber Installation	
- USB-Treiber Installation	
- Entfernung der Frage- und Ausrufezeichen im Geräte-Manager von Windows 95	
- Update des System-BIOS	
- Installation und Anwendung des Desktop Management Interface (DMI) Utility	
 Appendix I On Board I/O Addresses & IRQ Maps	 75
Appendix II Quick Connector and Jumper Reference	77
Appendix III FAN78 SMART Technology Upgrade Kit	79
Reader's Feedback	81

PART I English Edition

Chapter 1

Introduction

1-1 Product Specifications

□ CPU

- Supports up to 200MHz Pentium® processors and up to 233MHz Pentium® processors with **MMX™** technology
- Supports Cyrix/IBM 6x86™ (processor rev. 2.7 or later)/6x86L™ PR150+ ~ PR200+ and **6x86MX™** PR166+~PR233+ processors
- Supports AMD-K5™ PR75 ~ PR166 processors, up to 266 MHz **K6™** processors and AMD K6 3D processors
- Supports 50/60/66 MHz system clock speeds
- 321-pin ZIF Socket 7
- High efficiency Switching Power module
- Innovative **SeePU** Technology (Jumperless CPU installation via BIOS)
- Optional CPU overheat protection via **APTC** (Active Process Temperature Control) technology
- Optional **SMART** (System Monitoring & Alerting) technology with **LDCM™** utility



Supports 68/75/83MHz system clock for over-clocking possibility



APTC function is available on this mainboard if an 8-pin temperature sensing IC is located at the center of the CPU ZIF socket 7

□ Main Memory

- Four 5V 72-Pin SIMM sockets support 4/8/16/32MB, 32/36-bit, 70-ns or faster memory modules
- Two 3.3V unbuffered 168-pin DIMM sockets support 8/16/32/64/128MB, 64/72-bit DRAM memory modules
- Support Synchronous(12ns or faster)/EDO/FPM (70ns or faster) DRAM modules
- Maximum 256MB memory size

□ Cache Memory

- Standard 512KB (64k*64x1) Pipelined Burst SRAM on board

□ I/O Slots

- Four 16-bit ISA slots
- Four 32-bit PCI slots (all are Master Mode, PCI 2.1 compliant)

❑ **BIOS**

- Award System BIOS
- 1Mb Flash ROM
- Supports PnP, APM, DMI & multi-device (such as floppy, IDE/SCSI, CD-ROM, etc.) booting features
- Built-in Trend *ChipAway* **Virus** for a 100% virus-free system boot-up

❑ **Chipset**

- Intel 82430TX two chip PCIsset

❑ **On Board Ultra I/O Functions**

- ITE8679 I/O chip
- One floppy disk drive connector supports up to 2.88MB, 3 Mode, and has 1Mbps transfer rate
- Two 16550A compliant serial ports
- One Standard/ECP/EPP parallel port
- Supports IrDA IR function, up to 115.2kbps

❑ **Two Ultra DMA-33 PCI IDE Ports**

- Supports up to PIO Mode 4, Multi-word DMA Mode 2 & Ultra DMA-33 timings
- Complete Bus Master Drivers for well-known multi-tasking operating systems

❑ **Dual Channel USB Port**



Now under compatibility testing with different peripherals

❑ **PCB Dimension**

- Baby AT form factor
- 220mm x 280mm, 4-layer PCB
- Five mounting holes

❑ **Green PC**

- Meets EPA Green PC standard: power consumption under 30W on Doze, Standby or Suspend modes

❑ **Advanced Management Capability**

- Supports Software power off control, Over-ride power button, Power-on by modem, Power-on by alarm, Power failure recovery, Blinking LED in suspend, etc.
- Flash BIOS protect, Reset switch protect via BIOS
- Poly-fuse over-current protection for USB and keyboard

1-2 Package Contents

This product comes with the following components:

- ❑ One mainboard
- ❑ One 40-pin IDE connector ribbon cable (Figure 1-1)
- ❑ One 34-pin floppy disk drive ribbon cable (Figure 1-2a) or (Figure 1-2b)
- ❑ One 9-pin serial port and 25-pin parallel port ribbon cable with bracket (Figure 1-3)
- ❑ One 25-pin serial port ribbon cable with bracket (Figure 1-4a), or same combination with optional PS/2 mouse connector (Figure 1-4b)
- ❑ One user's manual
- ❑ Optional FAN78 *SMART* technology upgrade kit (see Appendix III for details)
- ❑ One CD-ROM that includes
 - Award Flash EPROM Utility, Award DMI Utility
 - Intel Bus Master IDE drivers for Win95, WinNT, and OS/2
 - Exclamation Mark Remover Utility
 - Shepherd System Health Monitoring Software Utility
 - Trend PC-cillin Anti-virus v3.0(OEM version) Utility in eight different languages



Figure 1-1 IDE cable



Figure 1-2a Standard Floppy cable



Figure 1-2b Optional 5.25 in. floppy cable

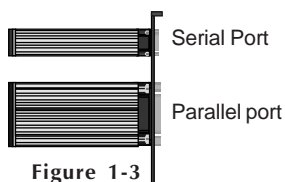

Figure 1-3

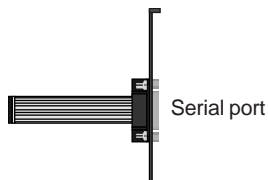

Figure 1-4a

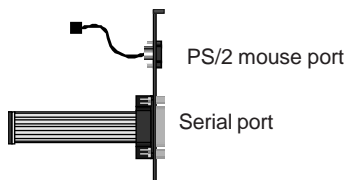
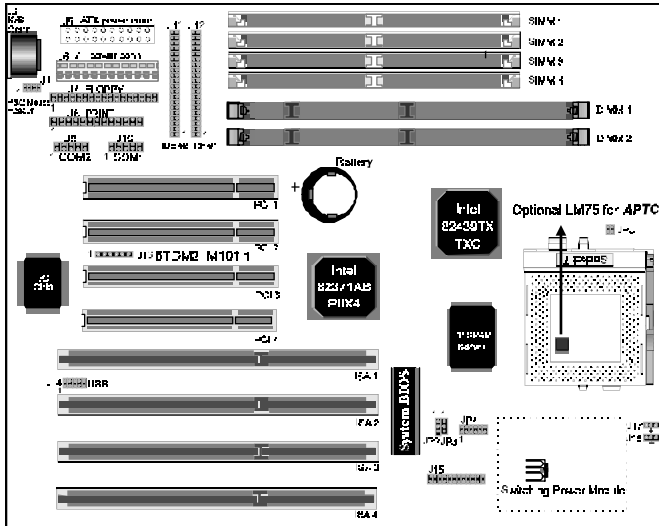

Figure 1-4b (Optional)

1-3 Mainboard Layout



1-4 Jumper and Connector Reference Page Chart

Jumper & Connector No.	Function	Ref. page
J5	ATX power supply connector	10
J6	AT power supply connector	11
J13	Infrared connector	14
J14	Dual channel USB connector	15
J15	Green switch connector	13
	Green LED connector	13
	System reset switch connector	13
	Turbo LED connector	13
	Keyboard lock & power indicator LED connector	12
	Speaker connector	13
	IDE activity LED connector	13
	Over-ride power button connector	12
J16	System cooling fan connector	14
J17	CPU cooling fan connector	14
JP2	Clear CMOS data jumper	15
JP3	Power failure recovery jumper	15
JP4	FAN78 connector	65
JP5	Open (reserved for factory)	--

Hardware Setup

If your mainboard has already been installed in your computer you may still need to refer to this chapter if you plan to upgrade your system's hardware.

⚠ Be sure to disconnect the power cable from the power source before performing any work on your mainboard, i. e. installing a CPU, memory module, changing a jumper setting, adding or removing expansion cards etc. Not doing so may result in electrical shock or severe damage to your mainboard and peripherals!

2-1 Introduction to Jumpers

Jumpers are used to select between various operating modes. A jumper consists of a row of gold colored pins that protrude from the surface of the mainboard. It is important not to confuse jumpers with connectors or headers.

⚠ Putting jumper caps on anything that is not a jumper may result in damaging your mainboard. Please refer to Section 1-3, Mainboard Layout, for the location of jumpers on your mainboard.

As indicated in Figure 2-1 below, a cap is used to cover the pins of a jumper, resulting in shorting those pins that it covers. If the cap is removed from the top of the pins, the jumper is left "open." The number 1 shown both in the diagram below and in all multiple pin jumper and header diagrams in this manual indicates the pin designated with the number 1. The numbering of the remaining pins follows in sequence.

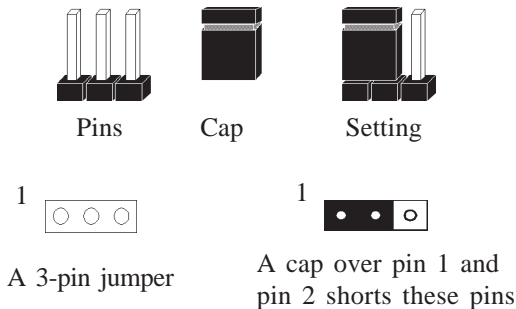

Figure 2-1

2-2 Installing a PGA type CPU in a ZIF Socket

The Intel Socket 7, designed for the Pentium processor, has been incorporated as a standard mainboard specification and is compatible with AMD and Cyrix CPUs. To insert your CPU into Socket 7 please do the following:

1. Locate a small dot marked on the top surface of the CPU close to one of its corners. The same corner will also be cut off, leaving a noticeable notch in the CPU's corner. These markings indicate Pin 1 of the CPU. See Figure 2-2.

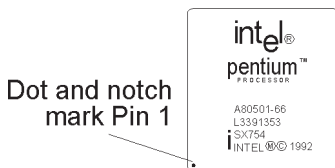

Figure 2-2 The markings on top of a CPU

2. Pull up the lever of Socket 7 so that it is perpendicular with the surface of the mainboard. Gently insert the CPU with Pin 1 at the same corner of Socket 7 that contains the end of the lever. Allow the the weight of the CPU to push itself into place. Do not apply extra pressure as doing so may result in damaging your CPU. Snap the lever back into place. See Figure 2-3.

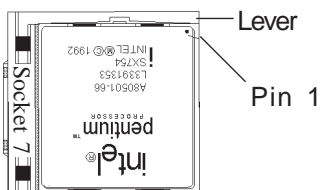

Figure 2-3 Inserting a CPU into Socket 7



Installing a heat sink and cooling fan on top of your CPU is necessary for proper heat dissipation. Failing to install these items may result in overheating and possible burn-out of your CPU.

2-3 Setting Your CPU's Parameters(SeePU Technology)

SeePU is a new user friendly technology that enables the user to setup a mainboard's CPU parameters through an easy to use BIOS setup procedure. It is no longer necessary to make many jumper settings as on conventional mainboards.

- After installing all your hardware into your PC system, turn on your system's power. Enter the CMOS Setup Utility by pressing the Delete key when your BIOS identification screen appears.
- Move the cursor to SeePU & CHIPSET SETUP menu (Figure 2-4) and press Enter. Commands for operating the cursor in BIOS are found at the bottom of the BIOS screen.
- There are two ways to set the CPU's parameters in the SeePU menu.
 - Leave User's Favorite function disabled (default) and choose the correct CPU speed from the speeds available. See Figure 2-5. If you use this method, SeePU will set a default voltage of 3.3v for single voltage CPUs and 2.8/3.3v for dual voltage CPUs.
 - Enable the User's Favorite function and choose the correct Core Voltage, CPU Bus Frequency, and Frequency Ratio (also known as external clock multiplier factor). See Figure 2-6. If you are not sure what your CPU's specifications are you can reference Figure 2-7 below for this information.
- Press Esc to return to the CMOS Setup Utility, press F10 to Save and Exit Setup and choose 'Y' to confirm. The system will automatically reboot and during startup you will see the correct CPU type indicated in the configuration screen.

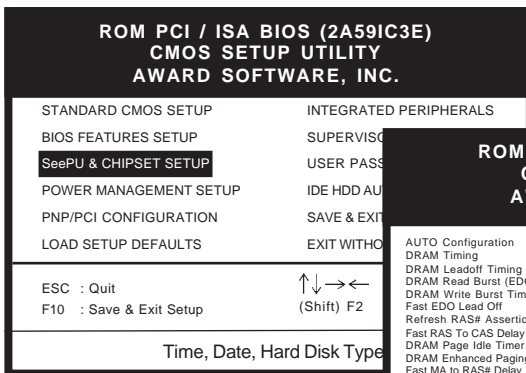

Figure 2-4

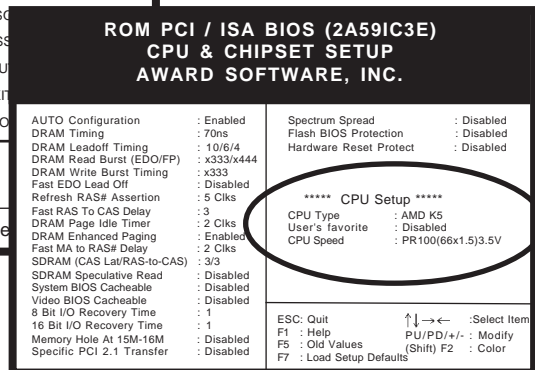

Figure 2-5

The on board switching power module can automatically distinguish between these two types of processors. A protection circuit is employed such that if you enter a single voltage value for a dual voltage CPU (or vice versa), the incorrect voltage setting will not be made. Instead, the system will revert to a default setting of 3.3v for single voltage CPUs and 2.8v/3.3v for dual voltage CPUs.

See below chart for details:

CPU-type		CPU Power Voltage		System freq./Freq. ratio		
		I/O Vcc	Core Vcc	MHz	Speed rate	
Intel/ AMD	P54C-90, K5-PR90	3.5		60	x1.5	
	P54C-120, K5-PR120 @90MHz				x2	
	P54C-150, K5-PR150 @105MHz				x2.5	
	P54C-100, K5-PR100				66	x1.5
	P54C-133, K5-PR133 @100MHz					x2
	P54C-166, K5-PR166 @116.7MHz					x2.5
Intel	P54C-200	3.3	2.8		x3	
	Pentium w/MMX 166MHz				x2.5	
	Pentium w/MMX 200MHz				x3	
	Pentium w/MMX 233MHz				x3.5	
Cyrix	6x86-PR150 ⁺ @120MHz	3.5		60	x2	
	6x86-PR166 ⁺ @133MHz				x2	
	6x86L-PR166 ⁺ @133MHz	3.3	2.8	66	x2	
	6x86L-PR200 ⁺ @150MHz				x2	
	6x86MX-PR166 ⁺ @150MHz	3.3	2.9	60	x2.5	
	6x86MX-PR166 ⁺ @133MHz				x2	
	6x86MX-PR200 ⁺ @166MHz				x2.5	
	6x86MX-PR200 ⁺ @150MHz				x2	
AMD	K6/166	3.3	2.9	66	x2.5	
	K6/200				x3	
	K6/233				x3.5	

Figure 2-7 CPU Parameter Chart

2-4 Connector and Jumper Settings

Connectors are used to link the system board with other parts of the system, including the power supply, the keyboard, and the various controllers on the front panel of the system case.



The power supply connector is the last connection to be made while installing a mainboard. Before connecting the power supply, please make sure it is not connected to the power source.

Power Supply Connectors

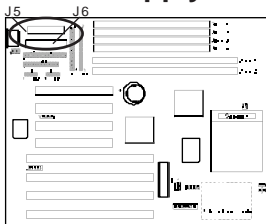

This mainboard supports two kinds of power connectors and requires a power supply of at least 200 watts.

ATX Power Supply Connector (J5)

The ATX power supply provides a single 20-pin connector interface which incorporates standard +/-5V, +/-12V, optional 3.3V and soft-power signal.

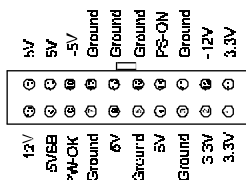

The Soft-power signal, a 5V trickle supply of at least 10mA, is continuously supplied when AC power is available. When the system is in the Soft-Off mode, this trickle supply maintains the system in it's minimum power state.

Software Power-Off Control

This mainboard can be powered down using the Windows 95 Software Power-Off function. To power down your computer, click the START button on the Windows 95 task bar. Select "Shut Down The Computer" and the system turns off. The message "It is now safe to turn off your computer" will not be shown when using this function.

Power-On By Modem

While in Soft-off state, if an external modem ring-up signal occurs, the system wakes up and can be remotely accessed. Please see Power Management (Section 3-4) for setting information.

AT Power Supply Connector (J6)

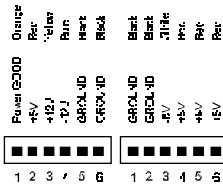

Most power supplies have two sets of six-wire leads. Making sure the black wires of each lead are in the center, plug both leads into the AT power supply connector. The power supply requirement is as follows:

Output voltage	Regulation tolerance
+5 Vdc	± 5%
-5 Vdc	± 10%
+12 Vdc	± 5%
-12 Vdc	± 10%

AT Style Keyboard Connector (J2)

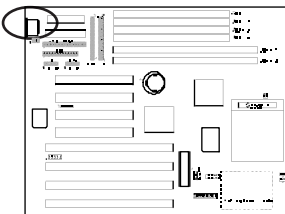

Pin	Definition
1	Keyboard Clock
2	Keyboard Data
3	(None)
4	Ground
5	+5V DC

Keyboard Connector / Pin Definitions

Poly-fuse Over Current Protection

The poly-fuse protects the system from dangerous voltages the system might be exposed to via the keyboard or USB connectors. In case of such exposure, the poly-fuse will immediately be disconnected from the circuit, just like a normal fuse. After being disconnected for a certain period of time, the poly-fuse will return to its normal state, after which the keyboard or USB can function properly. Unlike conventional fuses the poly-fuse will not have to be replaced, relieving the user wasted time and inconvenience.

PS/2 Style Mouse Connector (J4)

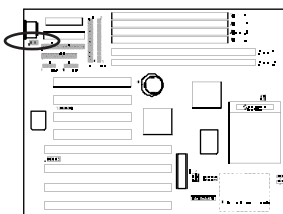

You can attach an optional a PS/2 mouse adapter (a 6-pin midi-DIN connector) with bracket directly to this connector. If a PS/2 mouse is used, it must be Enabled in BIOS's Integrated Peripherals menu. See Section 3-7. BIOS will automatically detect and assign IRQ12 to the PS/2 mouse.

Front Panel Connector Set (J15) A through G

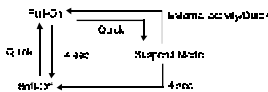
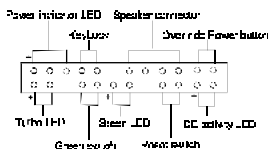
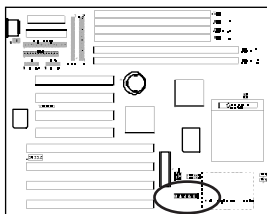

Over-ride Power Button Operation

A. Over-ride Power Button Connector

The power button on the ATX chassis can be used as a normal power switch as well as a button to activate Advanced Power Management Suspend mode. This mode is used for saving electricity when the computer is not in use for long periods of time. The Soft-OFF by PWR-BTTN function in BIOS's Power Management Setup must be set to "Delay 4 Sec." to activate this function. See Section 3-4 for details. When the Soft-off by PWR-BTTN function is enabled, pushing the power button rapidly will switch the system between Full-On and Suspend mode. Pushing the button rapidly again or any occurrence of external activity such as pressing a key on the keyboard will bring the system back to Full-On. Pushing the button while in Full-On for more than 4 seconds will switch the system to Soft-off and pushing the button again rapidly will turn the system back to Full-on. See Over-ride Power Button Operation diagram.

B. Keyboard Lock & Power Indicator LED Connector

Plugging this connector into the lock on the front panel of the system case allows the lock to enable or disable the keyboard. The power indicator LED shows the system's power status and will flash when the system is in Green mode (Suspend). It is important to pay attention to the correct cable and pin orientation (i.e., not to reverse the order of these two connectors.)

	Pin	Definition
Power indicator LED	1	+5V DC
	2	No Connect
	3	Ground
Keyboard Lock	4	Keylock
	5	Ground

Blinking LED in Suspend

While in Suspend mode, the LED light on the front panel of your computer will flash. Suspend mode is entered by pressing the Override Power Button, pushing the Green button on your ATX case (both discussed in Section 2-4) or by setting Suspend in the Power Management menu (discussed in Section 3-4).

C. Green Switch/Green LED Connector

Some ATX cases provide a Green switch which is used to put the system in Suspend mode. In suspend mode, the power supply to the system is reduced to a trickle, the CPU clock is stopped, and the CPU core is in its minimum power state. The system is woken up whenever the keyboard or mouse is touched or the Green button is pressed again. The system resumes in different ways as defined by "Power Management Setup" screen in BIOS.

D. Speaker Connector

Pin	Definition
1	Speaker Signal
2	GND
3	GND
4	+5V DC

E. System Reset Switch Connector

This connector should be connected to the reset switch on the front panel of the system case. The reset switch allows you to restart the system without turning the power off.

Pin	Definition
1	System
2	GND

F. IDE Activity LED Connector

The IDE activity LED lights up whenever the system reads/writes to the IDE devices.

G. Turbo LED Connector

This mainboard does not have turbo/de-turbo speed mode. Even though this function does not exist, the turbo LED will light when the LED is connected and the turbo button is pressed.

Change CPU Speed with the Keyboard

Use the following commands to change the CPU speed between turbo/de-turbo.

Set to low speed [CTRL][ALT][-]
 Set to high speed (turbo) [CTRL][ALT][+]

System/CPU Cooling Fan Connector (J16/J17)

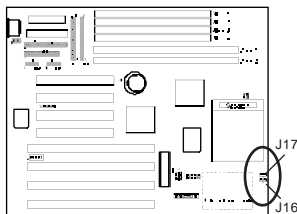

These added connectors allow the fans to draw their power from the mainboard instead of the disk drive connector. Some systems have all the disk drive power connectors in use.



APTC Technology

APTC (Active Processor Temperature Control) Technology

Upon overheating, the system can reduce the CPU's speed to prevent burn-out. When CPU temperature is over a default setting of 75+/-10°C (programmable via BIOS), the system will give a warning signal and the CPU's speed will decrease to an arbitrary speed. The thermal warning message can be enabled/disabled via the CPU Warning Temperature function in BIOS's Power Management Setup menu.

Management Extension Hardware for SMART Technology (Upgrade Kit)

Management extension hardware provides low-cost instrumentation capabilities. The hardware implementation is a single-chip ASIC located in the CPU cooling fan. Its features include an integrated temperature sensor, fan speed sensors, and power supply voltage monitoring to detect levels above or below acceptable values. Please contact your mainboard dealer to obtain the FAN78-**SMART** technology upgrade kit. More details about this kit can be found in Appendix III of this manual.

Infrared Connector (J13)

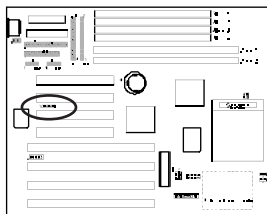

If you set COM2 Mode in BIOS's Integrated Peripherals menu to ASK IR or IrDA, the COM2 port will support IR functions.

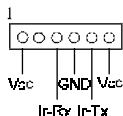

Power Failure Recovery Jumper (JP3)

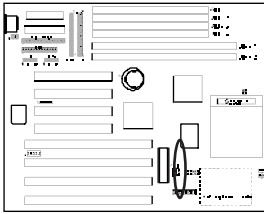

- 1 ● No recovery 1 ○ Recovery

Computers using an ATX power supply usually do not turn back on after the power source to the computer unexpectedly fails (i.e. electricity outage). Setting the cap at location 2~3 will allow the computer to always turn back on after a power failure. This is especially important for computers that must be on 24 hours per day.

Clear CMOS Data Jumper (JP2)

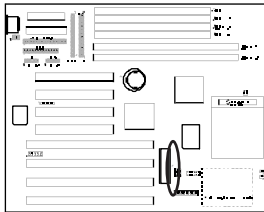

- 1 ● Default 1 ○ Clear CMOS Data

To clear the contents of the CMOS, please follow the steps below.

1. Disconnect the system power supply from the power source.
2. Set the jumper cap at location 2~3 for 5 seconds, then set back to the default position.
3. Connect the system's power and then start the system.
4. Enter BIOS, load the setup default settings in the CMOS Setup Utility Menu and then set the system configuration in the Standard CMOS Setup menu.

Dual Channel USB(Universal Serial Bus) Connector (J14)

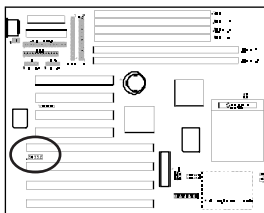

USB is an open industry standard, providing a simple and inexpensive way to connect up to 125 devices to a single computer port. Keyboards, mice, tablets, digitizers, scanners, bar-code readers, modems, printers and many more can all be used at the same time.

USB is a dynamically reconfigurable serial bus with an elementary data rate of 12Mbps, based on off the shelf, low cost micro-controller technology. It's modular layered software protocol supports sophisticated devices and application programs.

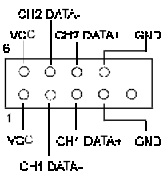

This board contains a USB Host controller and includes a root hub with two USB ports (meets USB Rev 1.0 spec.). Two USB peripherals or hub devices are able to be connected.



Compatibility with different USB peripherals is still being tested.

2-5 Main Memory Configuration

The DRAM memory system on board consists of 3 banks, and the memory range is **8 ~ 256 MBytes**. You must install 2 SIMM modules (same size, same speed, either single or double sided) in each bank at a time. It does not matter which bank you install first.

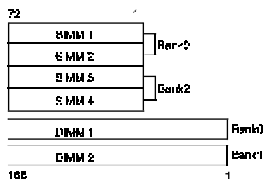

SIMM	72-pin 5V SIMM	Qty.
Bank0 (SIMM1,SIMM2)	4/8/16/32/64 FPM or EDO SIMM (DIMM sockets must be empty)	x2
Bank2 (SIMM3,SIMM4)	4/8/16/32/64 FPM or EDO SIMM (DIMM sockets must be empty)	x2
DIMM	168-pin 3.3V unbuffered DIMM	Qty.
Bank0 (DIMM1)	8/16/32/64/128 MB EDO or SDRAM (SIMM sockets must be empty)	x 1
Bank1 (DIMM2)	8/16/32/64/128 MB EDO or SDRAM (SIMM sockets must be empty)	x 1

DRAM Specifications

Types Supported

FP(Fast Page), EDO(Extended Data Output) and Synchronous DRAM

Speed requirement

FP/EDO: 70-ns (or faster) for 50 or 60MHz system frequency and 60-ns for 66MHz system frequency.

SDRAM: 10/12ns

Module types & sizes

4/8/16/32/64 MBytes, single/double-sided, 5v SIMM
8/16/32/64 MBytes, single/double-sided, 3.3v DIMM

Parity

Both parity and non-parity modules may be used however the parity function is not supported by this mainboard.

- ⚠ Most SDRAM will be 3.3V only (i.e. SDRAM I/O pins will not be 5V tolerant). **It is not recommended to mix 3.3V EDO/SDRAM DIMM with 5V EDO/FPM SIMM.**
- ⚠ Because 64/128MB DIMM is not popular yet, the compatibility of 64/128MB DIMM can not be 100% guaranteed.
- ✖ **This mainboard is limited to supporting 3.3V unbuffered type DIMM.**

This board has two DIMM (Dual-in-line Memory Module) sockets to support SDRAM type DRAM and has the better optimized read timings (7-1-1-1). The DIMM sockets will quickly replace SIMM as the next module standard for the PC industry and will become the memory subsystems standardized 64-bit data interface. Recently, JEDEC committee passed the unbuffered DIMM pinout specification as a standard for higher speed transfer. The unbuffered DIMM allows for SDRAM, EDO and FPM DRAM compatibility as well as pinouts for x64, x72 with parity, x72 with ECC and x80 ECC. The unbuffered DIMM is distinguished by the keyed notch lying to the right of the centerline of the DRAM key position as shown in the figure below.

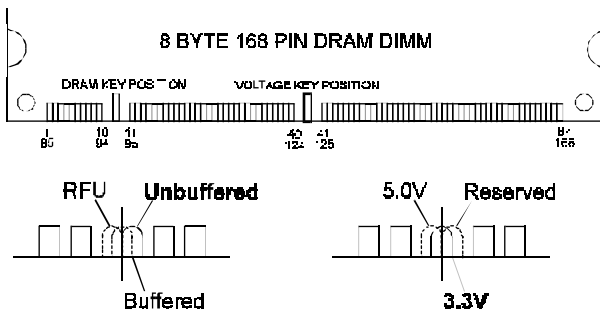



Memo

3-1 Standard CMOS Setup

The Standard CMOS Setup allows users to configure system components such as hard disk drive, floppy disk drive and video display as well as date, time and boot-up error signaling. This configuration menu should be changed when installing a mainboard for the first time, changing hardware in your system such as the HDD, FDD, video display, or when the CMOS data has been lost or contaminated. Choose the Standard CMOS Setup option from the CMOS Setup Utility menu (Figure 3-1) to display the following screen. When a field is highlighted, on-line help information is displayed on the left bottom edge of the screen.

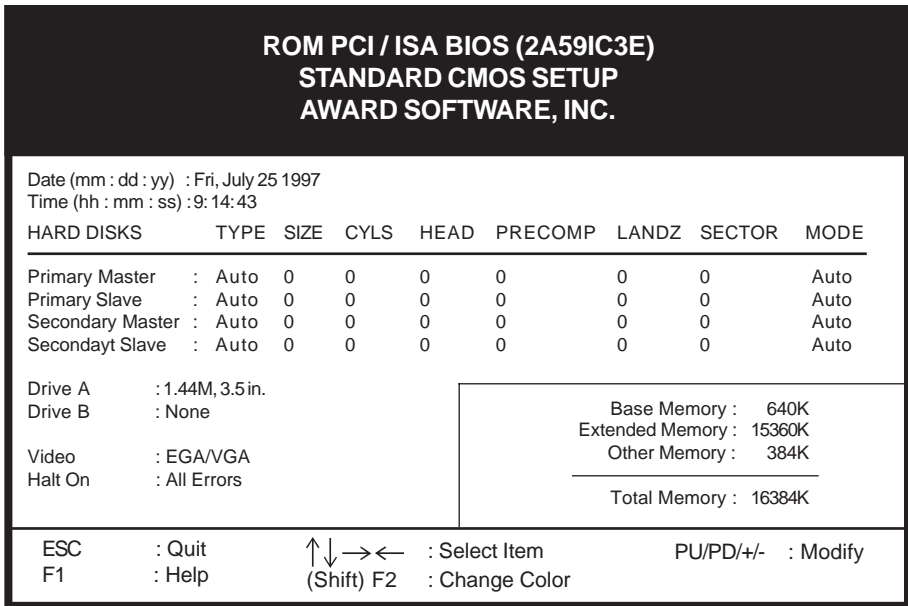

Figure 3-2 Standard CMOS Setup Screen

Date/Time

Set the date and time. Do not skip this function as all of your timed events such as power management, saving files, etc. are based on this timer.

Hard Disk Setup (Primary/Secondary; Master/Slave)

This category identifies up to four IDE hard disk drives that have been installed in the computer. This section does not show information on other IDE devices such as CD-ROM drives or other hard drive types such as SCSI drives.

Type (Auto/User/None): Use the fields under the Type column to determine the method you will use to configure the IDE devices. If you choose Auto, BIOS will automatically detect and make optimal settings for most IDE hard drives.



The mainboard manufacturer recommends that you choose Auto for all drives.

Choose User to define your own drive type manually. You must enter values indicated in the table below into each drive parameter field. This information should be included in the documentation from your hard disk vendor or system manufacturer:

TYPE	Setting method
CYLS	Number of cylinders
HEAD	Number of heads
PRECOMP	Write precompensation cylinder
LANDZ	Landing zone
SECTOR	Number of sectors
MODE	Mode type

Table 3-1 Hard Disk Drive Parameters

Cyls/Head/Sector: The number of Cylinders, Heads, and Sectors can usually be found written on the top of the hard disk. If you have a relatively new hard drive, entering this information alone is usually sufficient for normal hard disk operation. The hard disk will not work properly if you enter improper information for these categories.

Precomp: Older hard drives (i.e., MFM or RLL drives) have the same number of sectors per track at the innermost tracks as at the outermost tracks. Thus, the data density at the innermost tracks is higher and the bits are lying closer together. Even though the physical size of a sector gets progressively smaller as the track diameter diminishes, each sector must still hold 512 bytes. Write precompensation circuitry compensates for the difference in sector size by boosting the write current for inner track sectors.

Landz: This defines the address of the landing zone and is only used for older hard drives which do not have an auto-parking feature.

Mode: If the Type value is not None for any device, you must set the Mode value for that device. There are four different Mode values: Auto, Normal, Large, and LBA.

Auto - BIOS detects and enters the IDE drive type during bootup.

Normal - for IDE drives that meet the old IDE specification which support a maximum capacity of 528MB (1024 cylinders, 16 heads, and 63 sectors).

Large - for IDE drives that do not support LBA and have more than 1024 cylinders. Try this setting if your hard disk does not operate properly with

the LBA setting. Large mode is not supported by all operating systems, i.e., only certain versions of DOS support large mode.

LBA - (Large/Logical Block Addressing) With LBA, the IDE controller transforms the data address described by sector, head, and cylinder number into a physical block address, significantly improving data transfer rates. This mode is for drives with greater than 1024 cylinders and between 528MB and 8.4GB in size. This protocol is the current common standard.

Choose None for Type if there are no IDE HDD devices in your system.

-  You can use the IDE HDD Auto Detection function to auto detect your hard drive parameters. Using this function will automatically insert the parameters discussed under Hard Disk Setup and will indicate User for the Field value. Please see Section 3-9 for more information.

Floppy Disk Drives

Choose the memory capacity and disk size that corresponds with that of your floppy disk drive(s).

Video

Select the type of video adapter present in your system. You can ignore this setting if you are using a VGA monitor since VGA BIOS automatically configures this setting.

Halt

When the system is powered on, BIOS performs a series of diagnostic tests called POST (Power On Self Test). This function stops the computer if BIOS detects a hardware error. You can tell BIOS to halt on all errors, no errors, or not to halt on specific errors.

3-2 BIOS Features Setup

By choosing the BIOS Features Setup option from the CMOS Setup Utility menu (Figure 3-1), the screen below is displayed. This sample screen contains the manufacturer's default values for the mainboard.

ROM PCI / ISA BIOS (2A59IC3E)	
BIOS FEATURES SETUP	
AWARD SOFTWARE, INC.	
Virus Warning	: Disabled
CPU Internal Cache	: Enabled
External Cache	: Enabled
Quick Power On Self Test	: Enabled
Boot Sequence	: A,C,SCSI
Swap Floppy Drive	: Disabled
Boot Up Floppy Seek	: Enabled
Boot Up NumLock Status	: On
Boot Up System Speed	: High
Typematic Rate Setting	: Disabled
Typematic Rate (Chars/Sec)	: 6
Typematic Delay (Msec)	: 250
Security Option	: Setup
PCI/VGA Palette Snoop	: Disabled
OS Select(For DRAM>64MB):	Non-OS2
Video BIOS Shadow	: Enabled
C8000 - CBFFF Shadow	: Disabled
CC000 - CFFFF Shadow	: Disabled
D0000 - D3FFF Shadow	: Disabled
D4000 - D7FFF Shadow	: Disabled
D8000 - DBFFF Shadow	: Disabled
DC000 - DFFFF Shadow	: Disabled
ESC : Quit	↑↓→← : Select Item
F1 : Help	PU/PD/+/- : Modify
F5 : Old Values	(Shift) F2 : Color
F7 : Load Setup Defaults	

Figure 3-3 BIOS Feature Setup Screen

A. VIRUS PROTECTION

Virus Warning

When Enabled, BIOS activates a warning message to the user when any program (i.e., a virus) attempts to access the boot sector or hard disk partition table. The user is able to intervene by running an anti-virus program. This function only protects the boot sector and not the entire hard drive.

B. CACHE CONTROL

CPU Internal Cache/External Cache

Cache memory is much faster than conventional DRAM system memory. These fields allow you to enable or disable the CPUs Level 1 built-in cache and Level 2 external cache. Both settings are left enabled to significantly increase the performance of your computer.

C. BOOT UP FEATURES

After turning on the system, BIOS will perform a series of device initializations and diagnostic tests discussed below.

Quick Power On Self Test (POST)

Enable this function to reduce the amount of time required to run the POST (Power On Self Test). BIOS saves time by skipping some items during POST. It is recommended that you disable this setting. Discovering a problem during bootup is better than losing data during your work.

Boot Sequence

This option sets the sequence of drives BIOS attempts to boot from after POST completes. BIOS will search these drives for an operating system.

Swap Floppy Drive

Enabling this function will swap the floppy drive assignment so that drive A will function as drive B, and drive B will function as drive A. Note that the boot sequence assignment mentioned directly above does not include booting from floppy drive B. This function is useful if floppy drives B and A are of a different format and you want to boot from floppy drive B.

Boot up Floppy Seek

During POST, BIOS will determine if the installed floppy disk drive has 40 or 80 tracks. A 360K drive has 40 tracks and 720K, 1.2M and 1.44M drives have 80 tracks. All modern floppy disk drives have 80 tracks.

Boot Up NumLock Status

This function defines the keyboard's numberpad as number keys or arrow keys.

Boot Up System Speed

This function determines the CPU speed while in non-protected mode under DOS. Set to High for regular CPU speed and low for decreased CPU speed. This function is used for applications such as games that require decreased CPU speed.

D. KEYBOARD INTERFACE

Typematic Rate Setting

When enabled, you can set the following two typematic control items. When disabled, keystrokes are determined arbitrarily by the keyboard controller in your system.

Typematic Rate (Chars/Sec)

The typematic rate sets the rate at which characters on the screen repeat when a key is pressed and held down.

Typematic Delay (Msec)

The typematic delay sets how long after you press a key that a character begins repeating.

E. Security Option

The Supervisor and/or User Password functions shown in Figure 3-1 must be set to take advantage of this function. See Section 3-8 for password setting information. When the Security Option is set to System, a password must be entered to boot the system or enter the BIOS setup program. When the Security Option is set to Setup, a password is required to enter the BIOS setup program.

F. PCI/VGA Palette Snoop

Some non-standard VGA cards or MPEG video cards may not show colors properly (i.e., black on white while booting). Setting this function to Enabled can correct this problem.

G. OS Select (For DRAM > 64MB)

If your system's DRAM is larger than 64MB and you are running OS/2, select OS/2 as the item value. Otherwise, set the item value to Non-OS/2 for all other operating systems.

H. Shadow Memory

Software such as system BIOS, video BIOS, SCSI BIOS, etc that resides in ROM (Read Only Memory) chips is called firmware. Shadowing of firmware occurs when BIOS is copied to RAM address C0000h through DFFFFh. Video BIOS loads into the C0000-C7FFF memory area when video shadowing is enabled. If an expansion peripheral in your system contains ROM-based firmware, you need to know the address range the ROM occupies to shadow it into the correct area of RAM.

Shadowing improves the firmware's performance because the firmware can be read by the CPU through the 16- or 32-bit DRAM bus as opposed to the 8-bit XT bus. However, shadowing also results in reducing the amount of high memory (640 KB to 1 MB) for loading device drivers. Shadowing is used mostly for ROM chips on ISA cards and not for PCI cards. Shadowing and playing games at the same time may result in system instability as some games access the RAM memory area being shadowed.

3-3 SeePU & Chipset Setup

By choosing the *SeePU* & Chipset Setup option from the CMOS Setup Utility menu (Figure 3-1), the screen below is displayed. This sample screen contains the manufacturer's default values for the mainboard.

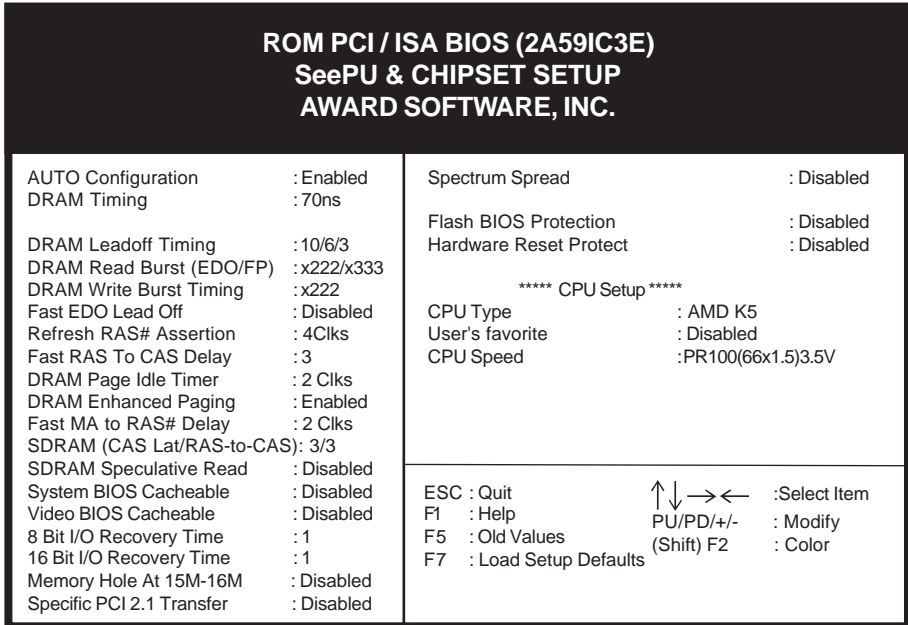

Figure 3-4 Chipset Features Setup Screen



With the exception of the CPU Setup, all of the above settings have been determined by the mainboard manufacturer and should not be changed unless you are absolutely sure of what you are doing. Explanation of the DRAM timing and chipset features setup is lengthy, highly technical and beyond the scope of this manual. Below are abbreviated descriptions of the functions in this setup menu. You can look on the world wide web for helpful chipset and RAM configuration information including AWARD's web site at <http://www.award.com>.

A. Auto Configuration

When Auto Configuration is enabled, BIOS autodetects the DRAM module type (i.e. EDO, FP) and determines the relevant DRAM settings. Note that these DRAM settings become background print (unchangeable) once the Auto Configuration

is enabled. If Auto Configuration is enabled, you must set the DRAM timing function to 60ns or 70ns, depending on the type of DRAM you install.

B. System BIOS/Video BIOS Cacheable

Selecting Enabled allows caching system BIOS at F0000h-FFFFFh and caching the video BIOS at C0000h to C7FFFh, resulting in better system performance. However if any program writes to this memory area, a system error may occur.

C. 8-bit I/O Recovery Time & 16-bit I/O Recovery Time

Back-to-back CPU or PCI master originated 8-bit and 16-bit cycles have an arbitrary delay of at least 3.5 system clock cycles. This category is used to add additional recovery delay between the 8 and 16-bit cycles. This delay takes place because the PCI bus is much faster than the ISA bus. The options are 1 to 8 and N/A.

D. Memory Hole at 15M-16M

Enabling this feature will reserve the 15MB to 16MB memory address space for ISA expansion cards. However, enabling this function will result in not allowing the system to have access to memory above 16MB. Please note that some expansion cards require this setting to be enabled. The default setting is Disabled.

E. Specific PCI 2.1 Transfer

Enabling this function will turn on the following Specific PCI 2.1 Transfer Protocols: PCI Passive Release, PCI Delay Transaction, Host_to_PCI Bridge Retry, and Extended CPU to PIIX4 PHLDA#. The default setting for this function is Disabled.

F. Spectrum Spread

When Enabled this function will cause lower EMI by spreading the system frequency spectrum. For normal operation, Disable this function.

G. Flash BIOS Protection

The mainboard manufacturer developed BIOS protection technology that protects the System BIOS kernel data from accidental corruption by unauthorized users or computer viruses. When enabled the BIOS data cannot be changed when attempting to update BIOS with the the FLASH utility. When disabled, the BIOS data can be updated by using the FLASH utility.



To Pass the Windows 95 SCT testing, this item should be disabled.



Please note that when disabling this setting, the system BIOS is vulnerable by intrusion of computer viruses. It is recommended to disable this setting only temporarily while updating your system's BIOS.

H. Hardware Reset Protect

When enabled, your PC's hardware reset button will not function. This function is especially useful to prevent accidental resets for file servers, routers, etc., which should be available 24 hrs/day. When disabled, your PC's hardware reset button will function normally.

I. CPU Setup

The mainboard manufacturer developed *SeePU* technology that allows you to easily set **the CPU's core voltage, clock multiplier factor** and **CPU Bus frequency** in the BIOS setup. Refer to Section 2-3 for details.

3-4 Power Management Setup

This section provides information on the Green PC power management functions. By choosing the Power Management Setup option from the CMOS Setup Utility menu (Figure 3-1), the screen below is displayed. This sample screen contains the manufacturer's default values for the mainboard.

ROM PCI / ISA BIOS (2A59IC3E) POWER MANAGEMENT SETUP AWARD SOFTWARE, INC.			
Power Management	: Disabled	**** Temperature Monitor	****
PM Control by APM	: Yes	CPU Warning Temperature	: Disabled
Video Off Method	: Blank Screen	Current CPU Temperature	: 34°C/93°F
Video Off After	: Standby		
MODEM Use IRQ	: 3		
Doze Mode	: Disabled		
Standby Mode	: Disabled		
Suspend Mode	: Disabled		
HDD Power Down	: Disabled		
Throttle Duty Cycle	: 62.5%		
VGA Active Monitor	: Enabled		
Soft-Off by PWR-BTTN	: Delay 4 Sec.		
Power On By Modem	: Disabled		
Power On By Alarm	: Disabled		
IRQ8 Break Suspend	: Disabled	ESC : Quit	↑↓→← : Select Item
CPUFAN Off In Suspend	: Enabled	F1 : Help	PU/PD/+/- : Modify
		F5 : Old Values	(Shift) F2 : Color
		F7 : Load Setup Defaults	

Figure 3-5 Power Management Setup Screen



With the exception of the CPU Setup, all of the above settings have been determined by the mainboard manufacturer and should not be changed unless you are absolutely sure of what you are doing. Explanation of the DRAM timing and chipset features setup is lengthy, highly technical and beyond the scope of this manual. Below are abbreviated descriptions of the functions in this setup menu. You can look on the world wide web for helpful chipset and RAM configuration information including AWARD's web site at <http://www.award.com>.

A. Power Management

Power management allows the computer to save electricity when it is not in use by entering increasingly deep power saving modes as shown by the diagram below. The computer runs in Normal operation mode until the Doze timer expires, at which point the computer enters Doze mode. If no external activity occurs, the computer will go into Standby and Suspend modes when their respective timers

expire. If external activity occurs, the computer will wake up from Power Management and return to Normal mode. To activate the function, set Power Management to Maximum Saving, User Define, or Minimum Saving described below. For a description of the power saving modes (Doze, Standby, and Suspend) see their descriptions below.

Max. Saving - All timers are set at the minimum value of one minute to maximize power saving.

Min. Saving - All timers are set at the maximum value of one hour for minimal power saving.

User Define - User can configure the timer to a desired time according to the values available.

Note that enabling the Power Management function will result in enabling the HDD Power Down function (Max Saving = 15 min, Min Saving = 1 min). The HDD Power Down function is not part of the Power Management scheme as indicated in Figure 4-6. Refer to the Standby Mode, Suspend Mode, and HDD Power Down descriptions below for more information on hard drive power management.

B. PM Control by APM

This function allows software other than BIOS to control Power Management features. Enable this function in BIOS and make sure APM (Advanced Power Management) is present. For example, run the Power utility program located in the DOS directory, C:\DOS\POWER.EXE to use Power Management features under DOS. For Windows 3.1x and Windows 95, you need to install Windows with the APM feature.

C. Video Off Method

This function serves as both a screen saver and power saver for monitors. See the next function, Video Off After, for setting the video timer.

Blank - BIOS will only blank the monitor's screen. The electricity saved in this mode is negligible and this function is only used as a screen saver to prevent screen damage while the screen is on but not in use.

V/H SYNC+Blank - The system turns off the vertical and horizontal synchronization ports, writes blanks to the VGA buffer and the monitor's electron gun turns off. This function requires a monitor with Green features in order to take advantage of the power saving function. If you enable this function and do not have a Green monitor, the result will be the same as if you had selected Blank. This function serves as both a screen saver and an electricity saver. **DPMS Supported** - Select this option if your video card supports the

Display Power Management Signaling (DPMS) standard (i.e., you have a monitor that supports Green features). Use software supplied by your video subsystem to set video power management options.

D. Video Off After

This setting determines when the monitor enters power saving mode. As the function name indicates, the monitor enters the power saving mode after the chosen event expires. The Power Management function must be enabled to use this function.

E. Modem Use IRQ

If your computer has a modem, use this function to tell BIOS which IRQ is being occupied by the modem card. When the system is in Green mode, the modem requires an IRQ assignment to wake up the system and perform tasks. This assignment is compliant with the APM 1.2 specification and is to be used in coordination with APM 1.2 compliant operating systems.

F. Doze Mode

The Power Management function must not be set to disabled to enable this function. If no interrupts have occurred and the Doze timer expires, system will enter Doze mode. In Doze mode, the CPU clock runs at a lower speed while all other devices operate normally.

-  Power saving modes achieved in lower power saving states will either be maintained or enter higher power saving modes when switching to higher power saving states. For example, the CPU clock will not switch back to normal in Standby mode. It will maintain a decreased rate in Standby Mode and turn off in Suspend Mode.

G. Standby Mode

The Power Management function must not be set to disabled to enable this function. If the system runs in Doze mode and the Standby timer expires, the system will enter Standby mode. In Standby mode, the hard disk drive and the monitor shut off while all other devices still operate at full speed. Note that the Video Off and HDD Power Down functions in Figure 4-5 provide the same power saving options found in Standby mode. The priority for determining which function controls power saving for the monitor and hard drive is determined by which timer expires first.

H. Suspend Mode

The Power Management function must not be set to disabled to enable this function. If the system runs in Standby mode and the Suspend timer expires, all devices regulated by power management will shut off and the CPU speed will be 0 MHz.

I. HDD Power Down

The Power Management function must not be set to disabled to enable this function. When the HDD idle time has elapsed, BIOS sends a command to the hard disk to turn off the motor. Set a time between 1 and 15 to indicate time required to wait before the hard drive enters a power saving mode. Some old hard drives may not support this function.

J. Throttle Duty Cycle

When the system enters Doze mode, the CPU clock runs only part of the time. You may select the percent of time that the clock runs.

K. VGA Active Monitor

When Enabled, any video activity restarts the global timer for Standby mode.

L. Soft-Off by PWR-BTTN

When set to Delay 4 Sec., this function allows the power button to put the system in Suspend, a power saving mode. See Section 2-4 for operation instructions of the over-ride power button operation which puts the system in Suspend mode. When set to Instant-Off the Soft-Off by PWR-BTTN function is disabled and the computer turns completely off when the power button is pressed.

M. Power On by Modem

When enabled, a modem that receives a call will wake up the system from soft off and green mode. You should connect the modem to the COM port and turn on the resume event in green mode.

N. Power On By Alarm

When enabled, this setting allows the system to turn back on at a designated time of the month. User must designate date of month and time of day. This function is only available when using an ATX power supply and the Software Power-Off function to turn off the computer. See the Software Power-Off feature in Section 2-4 of this manual for instructions.

O. IRQ8 Break Suspend

Enabling this setting turns the monitoring of IRQ8 (the Real Time Clock) On so it does not awaken the system from Suspend mode.

P. CPU Fan Off in Suspend

When Enabled, the CPU fan turns off during Suspend mode. This does not damage the CPU because the CPU frequency is 0MHz in Suspend mode.

Q. Temperature Monitor (if LM75 is present)

CPU Warning Temperature

When the CPU's temperature gets too hot, a warning signal will be sounded and CPU's frequency will automatically be reduced until the temperature reaches a normal level, after which the frequency will return to its original value. The temperature at which this protection mechanism starts can be adjusted by this item. Your computer's internal speaker must be connected to the Speaker Connector of the Front Panel Connector to enable this function.

Current CPU Temperature

The current CPU temperature can be monitored and showed with this item.

3-5 PNP/PCI Configuration

This section provides IRQ and DMA setting information. By choosing the PnP/PCI Configuration option from the CMOS Setup Utility menu (Figure 3-1), the screen below is displayed. This sample screen contains the manufacturer's default values for the mainboard.

ROM PCI / ISA BIOS (2A59IC3E) PNP/PCI CONFIGURATION AWARD SOFTWARE, INC.			
PNP OS Installed	: No	PCI IDE IRQ Map To	: ISA
Resources Controlled By	: Manual	FDD IRQ Can Be Free	: No
Reset Configuration Data	: Disabled	Assign IRQ For USB	: Enabled
IRQ-3 assigned to	: Legacy ISA	Assign IRQ For VGA	: Disabled
IRQ-4 assigned to	: Legacy ISA	Used MEM base addr	: N/A
IRQ-5 assigned to	: PCI/ISA PnP		
IRQ-7 assigned to	: PCI/ISA PnP		
IRQ-9 assigned to	: PCI/ISA PnP		
IRQ-10 assigned to	: PCI/ISA PnP		
IRQ-11 assigned to	: PCI/ISA PnP		
IRQ-12 assigned to	: PCI/ISA PnP		
IRQ-14 assigned to	: Legacy ISA		
IRQ-15 assigned to	: Legacy ISA		
DMA-0 assigned to	: PCI/ISA PnP	ESC : Quit	↑ ↓ → ← : Select Item
DMA-1 assigned to	: PCI/ISA PnP	F1 : Help	PU/PD/+/- : Modify
DMA-3 assigned to	: PCI/ISA PnP	F5 : Old Values	(Shift) F2 : Color
DMA-5 assigned to	: PCI/ISA PnP	F7 : Load Setup Defaults	
DMA-6 assigned to	: PCI/ISA PnP		
DMA-7 assigned to	: PCI/ISA PnP		

Figure 3-6 PCI & ONBOARD I/O Setup Screen

A. PNP OS installed

If you want to install a PNP compatible OS (such as Windows 95) set to **Yes**.

B. Resources Controlled By

When set to Manual the system BIOS will not refer to the ESCD for IRQ & DMA information. Instead, it will refer to the items in the setup menu for assigning IRQ & DMA. When set to Auto the system BIOS will refer to the ESCD for all legacy information.



ESCD(Extended System Configuration Data) provides a detailed format of the configuration data structures stored in flash memory. Each data structure defines the resources used by a device or a card in the system. This includes legacy and PCI/ISA PnP devices. Each data structure defines the resources.

C. Reset Configuration Data

When enabled the system BIOS will clear/reset the ESCD during POST. After clearing the ESCD, the BIOS will then change this item's value to Disabled. Otherwise, the ESCD data will become useless.

D. IRQ#/DMA# assign to

When resources are controlled manually, you can assign each system interrupt & DMA channel for "Legacy ISA" or "PCI/ISA PnP" card used.

While using **Legacy ISA Card**(non-PnP ISA card), please set it's necessary corresponding resources (INT#, DMA#) from "PCI/ISA PnP" to "Legacy ISA."

- ☞ All ISA non-PnP devices are legacy devices that select resources (I/O Addr., INT# or DMA#) by using hardware jumpers.
- ☞ IRQ-3/4/7/12/14/15 have been set as default for on board devices (COM2, COM1, Printer port, PS/2 mouse, IDE1 and IDE2).

E. PCI IDE IRQ Map to

This function allows user to select PC AT (ISA) interrupts or PCI IDE IRQ mapping.

ISA: BIOS does not designate any IRQ signal to the PCI slot. This is the default setting.

PCI-SLOT 1-4: User can designate which PCI slot (1-4) the IDE card is inserted into. This setting is suitable for use with older PCI IDE cards that BIOS is not able to recognize.

PCI-AUTO: BIOS automatically detects which PCI slot the PCI IDE card is inserted into.

F. FDD IRQ Can Be Free

This function allows user to choose if the FDD IRQ is able to be freed up. The default setting is NO and this does not allow the IRQ to be free.

G. Assign IRQ For VGA

This function allows BIOS to make an IRQ available to VGA cards. Most current VGA card models do not require this function to be enabled. The default setting is disabled to optimize Windows 95 IRQ resources for other IRQ usage.

H. Assign IRQ For USB

If USB is employed this function must be Enabled. Otherwise, disable this function to optimize Windows 95 IRQ resources for other IRQ usage.

I. Used MEM base addr

This function devotes a space of memory (8K, 16K, 32K, 64K) for any peripheral that has a high memory requirement. This is also used to designate memory space for legacy ISA cards. The settings C800~DC00 are used to designate point at which the memory will start being used. The default setting is N/A (disabled.)

J. Used MEM Length

8K~64K: Determines the amount of memory to be used by ISA cards mentioned in the Used MEM base addr function above.

3-6 Load Setup Defaults

Load Setup Defaults loads the default system values directly from the CMOS Setup Utility menu (Figure 3-1). If the stored record created by the setup program becomes corrupted and therefore unusable, these defaults will be loaded automatically when you turn on the computer.

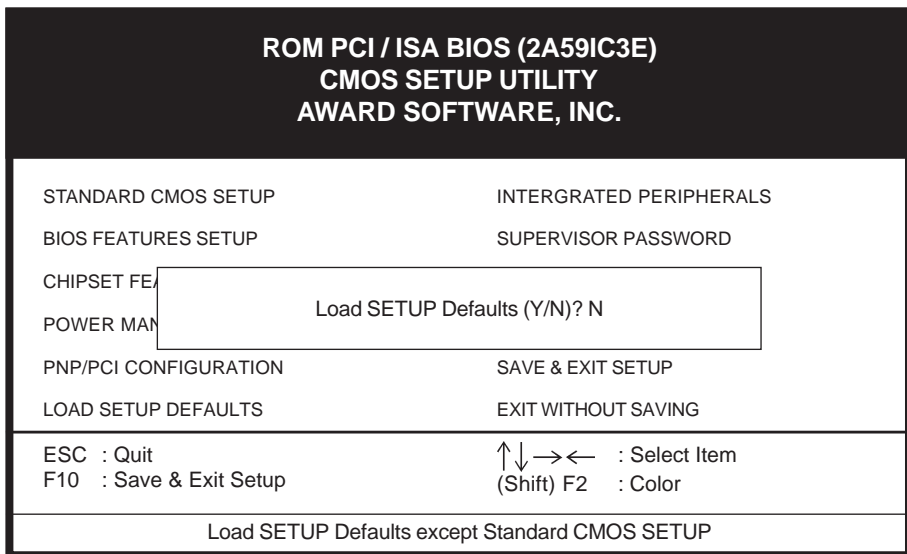

Figure 3-7 Load Setup Defaults Screen

3-7 Integrated Peripherals

This section provides information on setting peripheral devices. By choosing the Integrated Peripherals option from the CMOS Setup Utility menu (Figure 4-1), the screen below is displayed. This sample screen contains the manufacturer's default values for the mainboard.

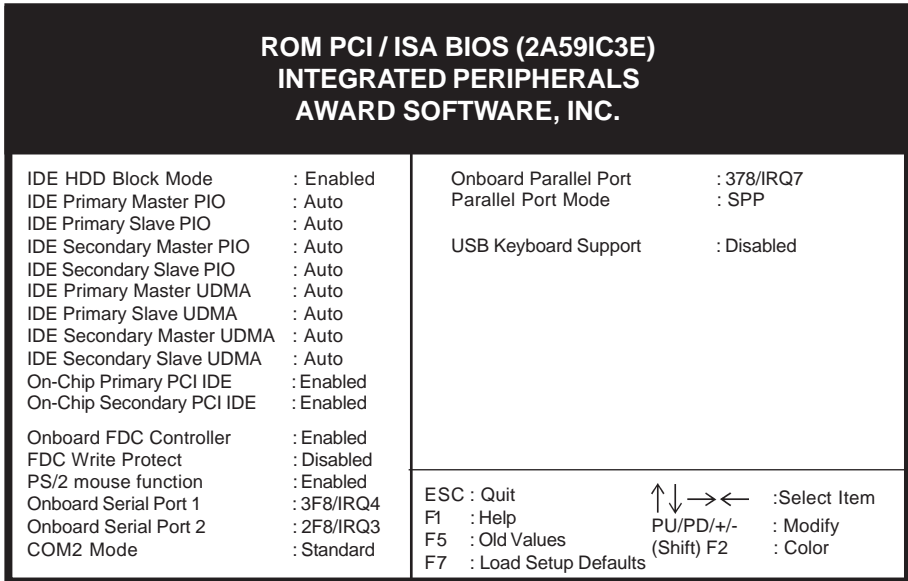

Figure 3-8 Integrated Peripherals Setup Screen

A. On Board IDE Control

IDE HDD Block Mode

Specifies the maximum number of sectors that can be transferred at a time.

On-chip Primary/Secondary PCI IDE

You can set this to disable the On-chip IDE controller if you are going to add a higher performance IDE board.

IDE Primary/Secondary Master/Slave PIO

The four IDE PIO (programmed Input/Output) fields let you set a PIO mode (0-4) for each IDE device that the internal PCI IDE interface supports. Modes 0 through 4 provide successively increased performance. In Auto mode, the system automatically determines the best mode for each device.

B. COM2 Mode

When this function is Enabled, then the COM port will be redirected to support IR function.

C. USB Keyboard Support

If your current operating system doesn't support USB drivers (i.e., DOS) this function must be enabled for USB keyboard operation in these operating systems.

- ☒ When using a USB keyboard this function is automatically Enabled during bootup regardless of its setting in BIOS.

3-8 Supervisor Password & User Password Setting

There are four different variables that control password settings. The first two are located under the Security Option function in BIOS Features Setup Menu (Figure 3-3). When the Security Option function is set to Setup, a password is required to enter BIOS and change BIOS settings. When the Security Option function is set to System, a password is required to enter both BIOS and the the computer's operating system (for example Windows 95) found on the boot drive. This is shown in Figures 3-9 and 3-10.

The third and fourth variables are user password and supervisor password selected in BIOS (Figure 3-1). The main purpose of separating user and supervisor is to allow only the supervisor to have control over the settings in BIOS. The user, on the other hand, is only allowed to access the computer's operating system and change the user password in BIOS (See Figure 3-10 below). Note that when there is no supervisor password set, the user password controls access to all BIOS settings (See Figure 3-9 below).

A. Set Either Supervisor Password or User Password

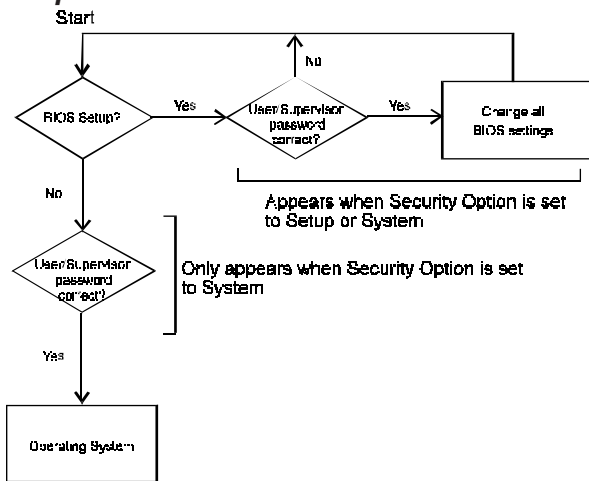

Figure 3-9 Set Either Supervisor or User Password

B. Set Both Supervisor Password and User Password

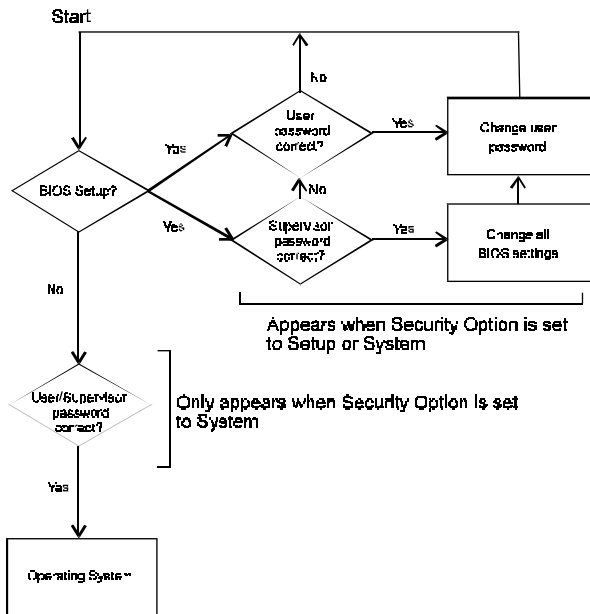

Figure 3-10 Set Both Supervisor and User Password

3-9 IDE HDD Auto Detection

This utility can automatically detect IDE hard disk type and parameters. The detection process take about 5 seconds for each physical drive. After the utility detects the disk drive, type Y and press [Enter] to automatically load the parameters in the Hard Disk section of the Standard CMOS Setup menu. Otherwise, leave the option set at N and press [Enter] or the [Esc] key to skip the detected drive. After detecting your hard drive(s), return to the Standard CMOS menu to check your settings.

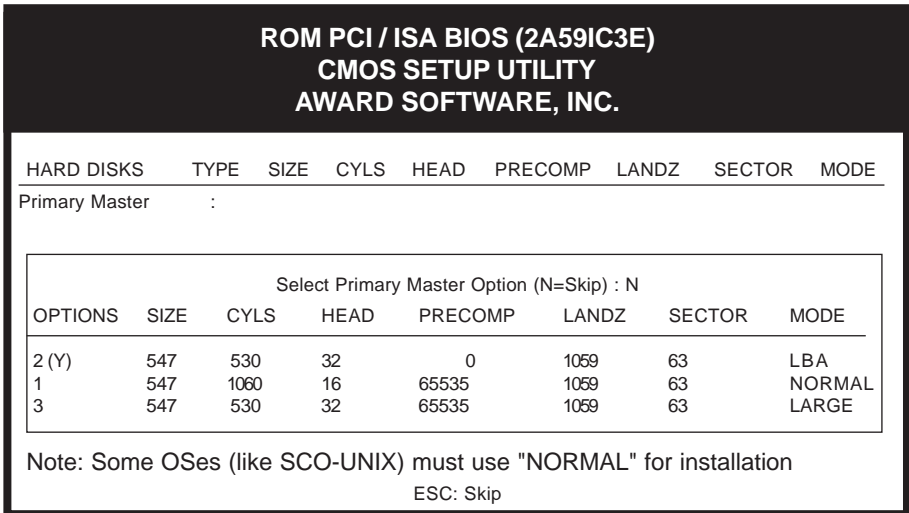

Figure 3-11 IDE HDD Auto Detection Screen

3-10 Save and Exit Setup

If you select this and type Y (for yes) followed by the [Enter] key, the values entered in the setup utilities will be recorded in the CMOS memory of the BIOS chip.

3-11 Exit Without Saving

Selecting this option and pressing Y followed by the [Enter] key lets you exit the Setup program without recording any new values or changing old ones.

Brief Software Driver Guide

The Mainboard Software Guide is found on the CD-ROM that is enclosed with your mainboard and is a PDF file which must be viewed with Adobe's freeware called Acrobat® Reader. The Acrobat Reader software is also included on the same CD-ROM. See the Readme.txt file in the CD-ROM's root directory for installation instructions of the Acrobat Reader. The Mainboard software guide discusses the following items:

The following items are discussed in the PDF files:

- Bus Master/PIO IDE Driver Installation
- USB Driver Installation
- Removing the Exclamation and/or Question Marks From the Windows 95 Device Manager Menu
- Updating Your System BIOS
- Installing and Using a Desktop Management Interface (DMI) Utility



Memo

Appendix I

On Board I/O Addresses & IRQ Maps

System Resource	IRQ	I/O Address
1. Timer	IRQ0	040, 043
2. Keyboard	IRQ1	060, 064
3. Programmable INT	IRQ2	0020, 0021, 00A0, 00A1
4. COM2(B)	IRQ3	2F8, 2FF
5. COM1(A)	IRQ4	3F8, 3FF
6. Floppy	IRQ6	3F0, 3F7
7. LPT1	IRQ7	378, 37F
8. Real Time Clock	IRQ8	070, 071
9. PS/2 Mouse	IRQ12	060, 064
10.Math coprocessor	IRQ13	0F0, 0FF
11.IDE 1	IRQ14	1F0, 1F7
12.IDE 2	IRQ15	170, 177

🚫 IRQ 5, 9, 10 and 11 are available for interface cards.



Memo

Appendix II

Quick Connector and Jumper Reference

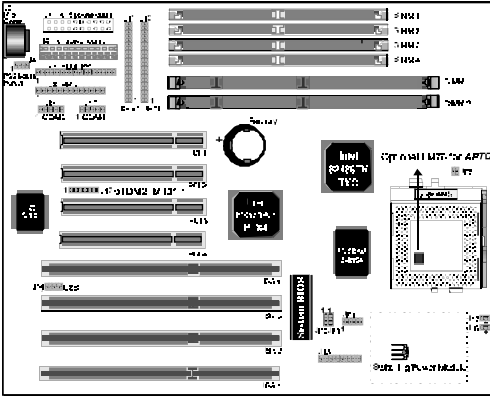

J13: Infrared connector



J14: Dual channel USB port connector



J15: Front panel connector set

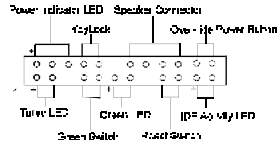

J16: System cooling fan connector



J17: CPU cooling fan connector



JP2: Clear CMOS data jumper

- 1~2 short : Normal (default)
- 2~3 short : Clear CMOS data

JP3: Power failure recovery jumper

- 1~2 short : No recovery
- 2~3 short : Recovery

JP4: FAN78 connector

JP5: Open (Reserved for factory)

Set the CPU type via BIOS :

CPU-type		CPU Power Voltage		System freq./Freq. ratio	
		I/O Vcc	Core Vcc	MHz	Speed rate
Intel/ AMD	P54C-90, K5-PR90	3.5		60	x1.5
	P54C-120, K5-PR120 @90MHz				x2
	P54C-150, K5-PR150 @105MHz				x2.5
	P54C-100, K5-PR100				x1.5
	P54C-133, K5-PR133 @100MHz				x2
	P54C-166, K5-PR166 @116.7MHz			66	x2.5
Intel	P54C-200	3.3	2.8	66	x3
	Pentium w/MMX 166MHz				x2.5
	Pentium w/MMX 200MHz				x3
	Pentium w/MMX 233MHz			66	x3.5
Cyrix	6x86-PR150 @120MHz	3.5		60	x2
	6x86-PR166 @133MHz				x2
	6x86L-PR166 @133MHz				x2
	6x86L-PR200 @150MHz				x2
	6x86MX-PR166 @150MHz	3.3	2.8	66	x2.5
	6x86MX-PR166 @133MHz				x2
	6x86MX-PR200 @166MHz				x2.5
	6x86MX-PR200 @150MHz				x2
AMD	K6/166	3.3	2.9	66	x2.5
	K6/200				x3
	K6/233				x3.5



Memo

Appendix III

FAN78-SMART Technology Upgrade Kit



FAN78



System Monitor Software for Win95

The FAN78 upgrade kit provides a PC self-diagnostic capability called the *SMART* (System Monitoring and Alerting) technology.

Features

- Detects four on-board voltages (CPU Core Voltage, 3.3V, 5V, 12V)
- Two fan speed sensing
- One precise CPU temperature sensor and one chassis temperature sensor
- Four types of speaker-driver signal output
- Supports system monitor software and drivers for **LDCM™** utility V3.1
- EISCA v1.0 compliant

FAN78 Connector

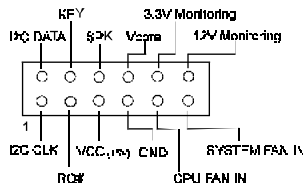



Memo