



# 586TB

Rev. A+  
System Board  
User's Manual





## Table of Contents

<b>Chapter 1: Introduction .....</b>	<b>5</b>
Features and Specifications .....	6
Package Checklist .....	8
<b>Chapter 2: Hardware Installation .....</b>	<b>9</b>
Preparing the Area .....	9
Handling the System Board .....	9
Installing the System Board .....	10
Board Layout .....	12
System Memory .....	14
DIMM .....	14
SIMM .....	15
Cache Memory .....	18
Processor Installation .....	18
Jumper Settings for Intel® Processors .....	20
Jumper Settings for AMD-K5/K6 Processors .....	21
Installing Upgrade CPUs .....	22
Installing A Fan/Heatsink .....	24
Jumper settings for Modem Ring-on .....	25
Factory Testing Jumpers .....	26
Ports and Connectors .....	27
Serial Ports .....	27
Parallel Port .....	27
Floppy Disk Drive Controller .....	28
IDE Hard Disk Interface .....	29
Universal Serial Bus Connectors .....	31
IrDA Connector .....	32
Installing Expansion Cards .....	33
<b>Chapter 3: Software Installation .....</b>	<b>34</b>
Award BIOS CMOS Setup Utility .....	34
Standard CMOS Setup .....	35
BIOS Features Setup .....	39
Chipset Features Setup .....	43
Power Management Setup .....	43
PNP/PCI Configuration Setup .....	47
Load Fail-Safe Settings .....	49
Load Optimal Settings .....	50

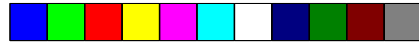

Integrated Peripherals .....	50
Supervisor Password .....	54
User Password .....	54
IDE HDD Auto Detection .....	55
HDD Low Level Format .....	57
Save & Exit Setup .....	58
Exit Without Saving .....	58
System Error Report .....	59
Driver Installation .....	61
<b>Chapter 4: Troubleshooting Checklist .....</b>	<b>64</b>
<b>Appendix A: Types of Modules .....</b>	<b>67</b>
<b>Appendix B: Memory and I/O Maps .....</b>	<b>69</b>
<b>Appendix C: Connector Pin Assignments .....</b>	<b>71</b>



**Caution:**

- Danger of explosion if battery incorrectly replaced.
- Replace only with the same or equivalent type recommended by the manufacturer.
- Dispose of used batteries according to the battery manufacturer's instructions.





## Chapter 1 Introduction

---

The 586ITB, equipped with a 321-pin Zero Insertion Force (ZIF) CPU socket, is a Pentium® processor-class system board supporting Intel Pentium® processors running at 90MHz, 100MHz, 120MHz, 133MHz, 150MHz, 166MHz and 200MHz frequencies. The 586ITB also supports Intel Pentium® processors with MMX™ technology - 166/200/233MHz, future Intel Pentium® OverDrive® processors, AMD® K5™ PR90/PR100/PR120/PR133/PR150/PR166, and AMD® K6™ PR2-166/PR2-200/PR2-233.

The 586ITB system board can support 8MB to 256MB of system memory. It is equipped with two DIMM sockets using x64 EDO, fast page mode or SDRAM, and 4 SIMM sockets using EDO or fast page mode x32 DRAM. This system board also supports 512KB pipeline burst SRAM.

The 586ITB design is based on the Peripheral Component Interconnect (PCI) local bus and Industry Standard Architecture (ISA) standards. It is equipped with 3 dedicated PCI slots, 2 dedicated 16-bit ISA slots and 1 shared PCI/ISA slot.

The 586ITB is equipped with two NS16C550A-compatible serial connectors, an SPP/ECP/EPP parallel connector, a shrouded floppy disk header, and two shrouded PCI IDE headers with bus mastering capabilities that highly reduce CPU use during disk transfer. This system board is also equipped with one PS/2 mouse connector, one PS/2 or AT keyboard port, two USB ports and one IrDA connector for wireless connectivity between your computer and peripheral devices.

The 586ITB system board is a Baby AT form factor board designed to fit into an ATX form factor case. Using an ATX power supply, you can either shut down your computer by pressing the Power button located on the front bezel of your computer or by executing the Shut Down command under the Windows® 95 operating system if you have power management in the BIOS setup correctly enabled.



With ATX power supply being used, the 586ITB system board can support ACPI Specification, Modem Wake-Up, PC 97 Compliance, and Dual Function Power Button to enhance its performance. ACPI (Advanced Configuration Power Interface) has energy saving features which enable operating systems to reliably manage and coordinate power planes, PnP (Plug-and-Play) peripherals, and cooling fans. ACPI is the specification of Microsoft®'s PC 97 "OnNow" design allowing continual "power on" with reduced energy consumption. The Modem Wake-Up feature allows the "sleeping" PC to power on to respond to incoming calls.

PC 97 Compliance defines the adherence to Plug-and-Play compatibility, hardware power management, and 32-bit device drivers for Windows® 95 & Windows® NT specifications. PC 97 makes PCs easier to use through maximum cooperation between the operating system and hardware. Dual Function Power Button allows two distinct OFF modes. In Sleep mode, a PC powers down but not off. In Soft-Off, a PC shuts down but requires a reboot to "awaken" it.





## Features and Specifications

### Processor

- Intel Pentium® processors with MMX™ technology - 166/200/233MHz
- Intel Pentium® 90/100/120/133/150/166/200MHz
- Future Pentium® OverDrive® processors
- AMD® K5™ PR90/PR100/PR120/PR133/PR150/PR166
- AMD® K6™ PR2-166/PR2-200/PR2-233

### Chipset

- Intel® 82430TX PCIsset

### Cache Memory

- 512KB pipeline burst, direct map write-back cache installed on the system board

### System Memory

- 8MB to 256MB memory
- Two 168-pin DIMM sockets using x64 EDO (60/70ns), fast page mode (60/70ns), or SDRAM (10/12/13ns), 3.3V
- Four 72-pin SIMM sockets using EDO or fast page mode x32 DRAM, 60/70ns, 5V

### BIOS

- Award BIOS, Windows® 95 Plug and Play compatible
- Flash EPROM for easy BIOS upgrades

### Energy Efficient Design

- Supports ACPI specification and OS Directed Power Management (ATX power supply only)
- System power management supported
- CPU stopped clock control
- Hardware supports SMI green mode
- Microsoft®/Intel® APM 1.2 compliant
- Soft Power supported - ACPI v1.0a specification (using ATX power supply only)

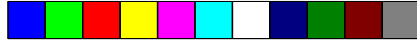

### **PCI IDE Interface**

- Ultra DMA/33 supported (Synchronous DMA mode - data transfer rate up to 33MB/sec.)
- DMA Mode 2 Bus Master IDE (data transfer rate up to 22.2MB/sec.)
- PIO Mode 3 and Mode 4 Enhanced IDE (data transfer rate up to 16.6MB/sec.)
- Bus mastering reduces CPU utilization during disk transfer
- ATAPI CD-ROM supported

### **Integrated I/O**

- Ultra I/O controller
- Two NS16C550A-compatible high speed UARTs
- One SPP/ECP/EPP parallel port
- Supports 360KB, 720KB, 1.2MB, 1.44MB, and 2.88MB floppy drives

### **CPU Socket**

- 321-pin ZIF socket (Intel® Socket 7)
- Equipped with a switching voltage regulator which can support 10A current to the CPU core

### **Connectors**

- 2 connectors for external USB (Universal Serial Bus) ports
- 1 connector for IrDA interface
- 2 serial connectors
- 1 parallel port
- 2 IDE connectors
- 1 floppy connector
- 1 PS/2 mouse connector
- 1 PS/2 or AT keyboard port
- 1 20-pin ATX power supply connector
- 1 12-pin standard AT power supply connector

### **Expansion Slots**

- 3 dedicated PCI slots
- 2 dedicated 16-bit ISA slots
- 1 shared PCI/ISA slot

### **PCB**

- 4 layers, Baby AT form factor
- 25cm (9.84") x 22cm (8.66")



## Package Checklist

The 586ITB package contains the following items:

- The 586ITB system board
- The 586ITB user's manual
- Serial, mouse and printer port cables
  - Option 1:
    - One card-edge bracket with a 9-pin and 25-pin serial port cables
    - One card-edge bracket with a 25-pin printer port cable and a PS/2 mouse port cable
  - Option 2:
    - One card-edge bracket with two 9-pin serial port cables and a PS/2 mouse port cable
    - One 25-pin printer port cable for chassis mounting
- One 40-pin IDE hard disk cable
- One 34-pin floppy disk drive cable
- One IDE driver diskette
- Five spare jumpers
- One card-edge bracket with two USB ports (optional)

If any of these items are missing or damaged, please contact your dealer or sales representative for assistance.





## Chapter 2 Hardware Installation

---

This chapter summarizes the steps to install the 586ITB system board into your system unit. It also includes a description of the area in which you must work and directions for memory installation. Before installing the system board, obtain the memory you plan to install. Refer to the System Memory section for the number and type of memory modules needed for the amount of memory you require.

### Preparing the Area

Before unpacking the system board, make sure the location you have selected is relatively free of dust and static electricity. Excessive exposure to dust, static electricity, direct sunlight, excessive humidity, extreme cold, and water can damage the operational capabilities of your system board. Avoid placing the unit on surfaces such as carpeted floors. These areas also attract static electricity which can damage some circuits on your system board.

Make sure the power source has a properly grounded, three-pronged socket. It is essential that the power connection be properly grounded for correct functioning of your system board. For further protection, we recommend that you use a surge suppressor. This will protect the system board from damage that may result from a power surge on the electrical line.

Move items that generate magnetic fields away from your system board since magnetic fields can also damage your system board. Once you have selected the ideal location, unpack the 586ITB system board carefully.

### Handling the System Board

It is quite easy to inadvertently damage your system board even before installing it in your system unit. Static electrical discharge can damage computer components without causing any signs of physical damage. You must take extra care in handling the system board to ensure against electrostatic build-up.



## Static Electricity Precautions

1. To prevent electrostatic build-up, leave the board in its anti-static bag until you are ready to install it.
2. Wear an antistatic wrist strap.
3. Do all preparation work on a static-free surface with the system board components facing up.
4. Hold the system board by its edges only. Be careful not to touch any of the components, contacts or connections, especially gold contacts, on the board.
5. Avoid touching the pins or contacts on all modules and connectors. Hold modules and connectors by their ends.

### **Warning:**

*Electrostatic discharge (ESD) can damage your processor, disk drives, add-in boards, and other components. Perform the upgrade instruction procedures described at an ESD station only. If such a station is not available, you can provide some ESD protection by wearing an anti-static wrist strap and attaching it to a metal part of the system chassis. If a wrist strap is unavailable, establish and maintain contact with the system chassis throughout any procedures requiring ESD protection.*

## Installing the System Board

If you are installing the 586ITB system board, the following outlines the basic installation steps. Before installing the system board into your system unit, you should prepare the tools you will need.

You will need:

- One medium size, flat-bladed screwdriver
- One medium Phillips screwdriver
- One needle-nosed pliers
- One small nutdriver

1. Unlock your system unit. Turn off the power and disconnect all power cords and cables.



2. Remove the system unit cover. Refer to the manufacturer's instructions if necessary.
3. Detach all connectors from the old system board and remove expansion cards seated in any expansion slots.
4. Loosen the screws holding the original system board and remove the board from the system. Save the screws.
5. Remove the 586ITB from its original packing box. Be careful to avoid touching all connectors and pins on the board. Please refer to the handling instructions on pages 9-10 for proper handling techniques.
6. Insert the memory modules into the memory banks on the 586ITB. The quantity and location of the memory modules depends on the memory configuration and type of modules you intend to use.
7. Install the CPU. Be sure pin 1 of the CPU is aligned with pin 1 of the socket.
8. Set the corresponding jumpers.
9. Install the prepared 586ITB system board into the case and replace the screws.
10. Reinstall all cards and connectors and replace the system unit cover. Reconnect all power cords and cables.

Use only the ATX (CN8) or AT (JP27) power connector, not both. If you are using an ATX power supply, install the 20-pin ATX power cable connector into location CN8 on the system board. The 20-pin connector can be inserted into CN8 only if pin 1 of the connector is aligned with pin 1 of CN8.

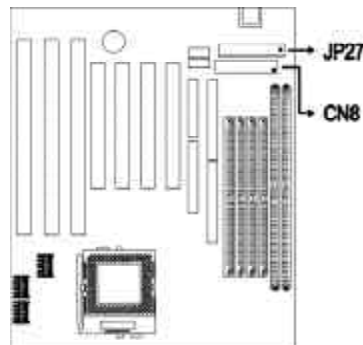



# Board Layout

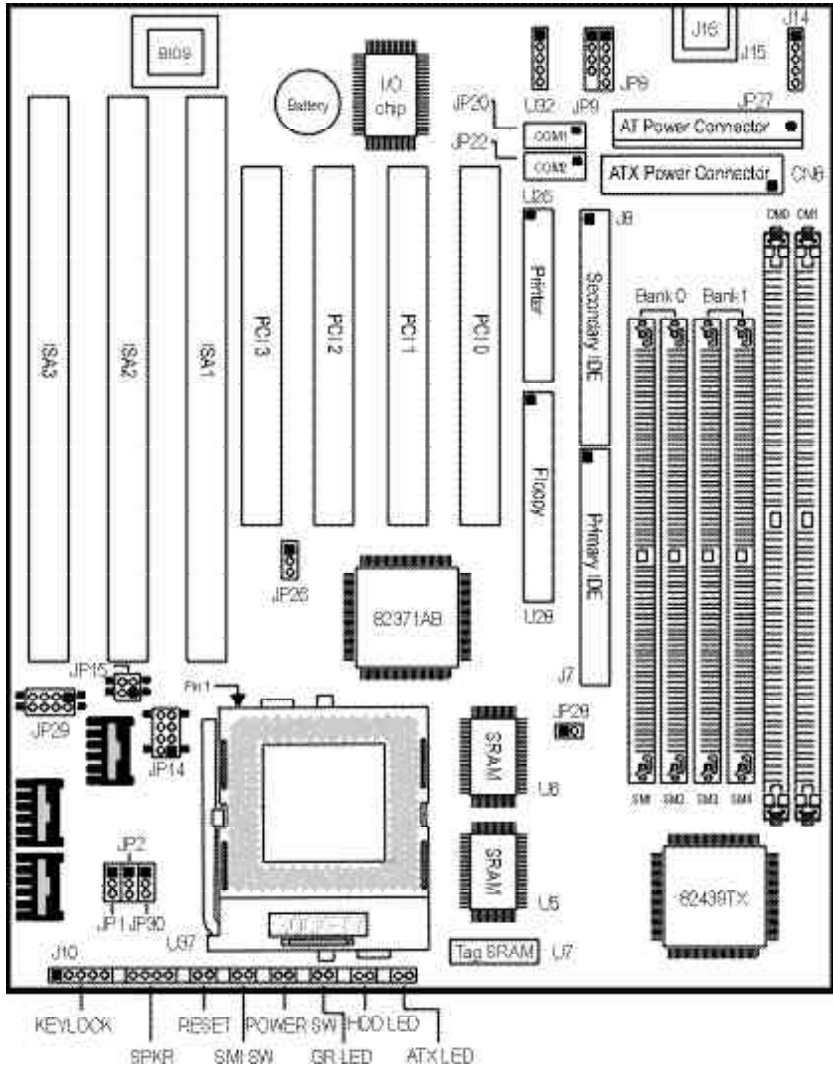

■ square denotes pin 1



<b>Jumpers</b>	<b>Refer to</b>
JP1, JP2, JP15, JP28 and JP29 Intel and AMD processors	pages 18-21
JP21 - Modem Ring-on select	pages 25-26
JP14 and JP30 Factory Testing Jumpers	page 26

<b>Sockets</b>	<b>Refer to</b>
DM0 and DM1 - DIMM sockets	pages 14-15
SM1 to SM4 - SIMM sockets	pages 15-17
U1 - ZIF socket	pages 22-24

<b>Expansion slots</b>	<b>Refer to</b>
PCI Slots 0, 1, 2, 3 - 32-bit PCI slots	page 33
ISA Slots 1, 2, 3, 4 - 16-bit ISA slots	page 33

<b>Connectors - refer to pages 71-73</b>	
JP8 - USB 1 connector	J7 - Primary IDE HDD connector
JP9 - USB 2 connector	J8 - Secondary IDE HDD connector
JP20 - COM 1 serial port	J14 - PS/2 mouse port
JP22 - COM 2 serial port	J15 - AT keyboard port
JP27 - AT power connector	J16 - PS/2 keyboard port
CN8 - ATX power connector	J10 - Keylock connector
U26 - Parallel printer port	Speaker connector
U28 - Floppy disk drive connector	Reset switch connector
U32 - IrDA connector	SMI switch connector
	Power switch connector
	Green LED connector
	HDD LED connector
	ATX LED connector

## System Memory

The 586ITB system board supports two kinds of memory modules: DIMM and SIMM. DIMM, which uses SDRAM, performs better than SIMM, which uses DRAM. Refer to page 12 for the locations of the DIM and SIM sockets.

### Important:

*DIM and SIM modules cannot exist on the 586ITB system board at the same time. Use either SIMM or DIMM only, and not both.*

### DIMM

The two 168-pin DIMM (Dual In-line Memory Module) sockets use x64 EDO, FPM and SDRAM. The 586ITB system board can support 8MB to 32MB memory using 1MBx64, 2MBx64 or 4MBx64 DIMM. The table below shows the supported DIM modules and their corresponding memory sizes.

DIMMs	Memory Size
1MBx64	8MB
2MBx64	16MB
4MBx64	32MB

The table below summarizes the DIMM sockets and modules needed for the corresponding memory sizes.

Memory Size	DIM 0	DIM 1	Memory Size	DIM 0	DIM 1
8MB	1MBx64	none	32MB	none	4MBx64
8MB	none	1MBx64	32MB	2MBx64	2MBx64
16MB	2MBx64	none	40MB	1MBx64	4MBx64
16MB	none	2MBx64	40MB	4MBx64	1MBx64
16MB	1MBx64	1MBx64	48MB	2MBx64	4MBx64
24MB	1MBx64	2MBx64	48MB	4MBx64	2MBx64
24MB	2MBx64	1MBx64	64MB	4MBx64	4MBx64
32MB	4MBx64	none			



## Installing the DIM Module

A DIM module simply snaps into a socket on the system board. Pin 1 of the DIM module must correspond with pin 1 of the socket.

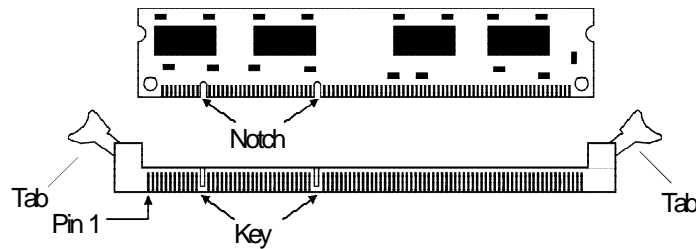

1. Pull the “tabs” which are at the ends of the socket to the side.
2. Position the DIMM above the socket with the “notches” in the module aligned with the “keys” on the socket.
3. Seat the module vertically into the socket. Make sure it is completely seated. The tabs will hold the DIMM in place.



## SIMM



The SIMM (Single In-line Memory Module) sockets are divided into two banks on the system board, Bank 0 and Bank 1. Each bank consists of 2 SIMM sockets.

You will need either 2 or 4 pieces of SIM modules, depending on the amount of memory you intend to install. The system board will not work if you install 1 or 3 pieces. Make sure you insert the same type of SIMMs in one bank. You can install SIMMs in either of the banks, Bank 0 or Bank 1, but you must populate one bank first before going to the next bank.

The 586ITB system board can support 8MB to 256MB of memory using 1MBx32, 2MBx32, 4MBx32, 8MBx32, or 16MBx32 72-pin SIMMs. The table on the next page shows the supported SIM modules and their corresponding memory sizes.





<b>SIMMs</b>	<b>Memory Size</b>
1MBx32	4MB
2MBx32	8MB
4MBx32	16MB
8MBx32	32MB
16MBx32	64MB

The table below summarizes the bank locations and modules needed for the corresponding memory sizes.

<b>Memory Size</b>	<b>Bank0</b>		<b>Bank1</b>	
	<b>SIMM1</b>	<b>SIMM2</b>	<b>SIMM3</b>	<b>SIMM4</b>
8MB	1MBx32	1MBx32	—	—
8MB	—	—	1MBx32	1MBx32
16MB	2MBx32	2MBx32	—	—
16MB	—	—	2MBx32	2MBx32
16MB	1MBx32	1MBx32	1MBx32	1MBx32
24MB	1MBx32	1MBx32	2MBx32	2MBx32
24MB	2MBx32	2MBx32	1MBx32	1MBx32
32MB	4MBx32	4MBx32	—	—
32MB	—	—	4MBx32	4MBx32
32MB	2MBx32	2MBx32	2MBx32	2MBx32
40MB	1MBx32	1MBx32	4MBx32	4MBx32
40MB	4MBx32	4MBx32	1MBx32	1MBx32
48MB	2MBx32	2MBx32	4MBx32	4MBx32
48MB	4MBx32	4MBx32	2MBx32	2MBx32
64MB	8MBx32	8MBx32	—	—
64MB	—	—	8MBx32	8MBx32
64MB	4MBx32	4MBx32	4MBx32	4MBx32
72MB	1MBx32	1MBx32	8MBx32	8MBx32
72MB	8MBx32	8MBx32	1MBx32	1MBx32
80MB	2MBx32	2MBx32	8MBx32	8MBx32
80MB	8MBx32	8MBx32	2MBx32	2MBx32





Memory Size	Bank0		Bank1	
	SIMM1	SIMM2	SIMM3	SIMM4
96MB	4MBx32	4MBx32	8MBx32	8MBx32
96MB	8MBx32	8MBx32	4MBx32	4MBx32
128MB	16MBx32	16MBx32	—	—
128MB	—	—	16MBx32	16MBx32
128MB	8MBx32	8MBx32	8MBx32	8MBx32
136MB	1MBx32	1MBx32	16MBx32	16MBx32
136MB	16MBx32	16MBx32	1MBx32	1MBx32
144MB	2MBx32	2MBx32	16MBx32	16MBx32
144MB	16MBx32	16MBx32	2MBx32	2MBx32
160MB	4MBx32	4MBx32	16MBx32	16MBx32
160MB	16MBx32	16MBx32	4MBx32	4MBx32
192MB	8MBx32	8MBx32	16MBx32	16MBx32
192MB	16MBx32	16MBx32	8MBx32	8MBx32
256MB	16MBx32	16MBx32	16MBx32	16MBx32



## Installing a SIM Module



A SIM module simply snaps into a socket on the system board. Pin 1 of the SIM module must correspond with Pin 1 of the socket.

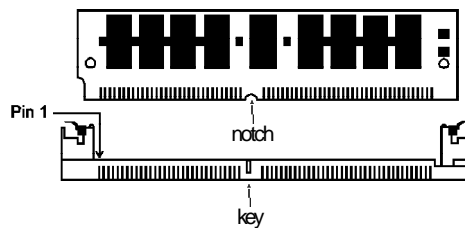

1. Position the SIMM above the socket with the “notch” in the module aligned with the “key” on the socket.
2. Seat the module at a 45° angle into the bank. Make sure it is completely seated. Tilt the module upright until it locks in place in the socket.





## Cache Memory

The 586ITB system board can support 512KB pipeline burst, direct map write-back cache SRAM. Your system board comes with a 512KB cache, which is the maximum cache memory supported by the system board, mounted at locations U5 and U6. One SRAM is mounted on location U7 for tag SRAM to store the cacheable addresses.

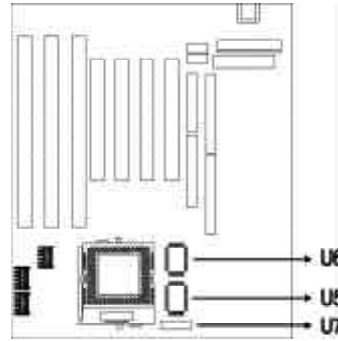

## Processor Installation

The 586ITB allows for easy installation of processors. Make sure all jumpers are set correctly before applying power or you may damage the processor or system board. Use a needle-nosed plier to move the jumpers if necessary.

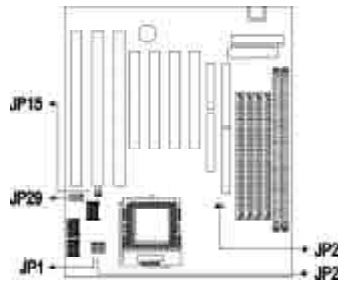

Jumper JP28 is used to set the external system bus clock of your processor. Refer to the following pages for the external system bus clock that corresponds to your processor and set this jumper accordingly. The clock generator will determine the external bus clock that must be sent to the processor through this setting.

Jumper JP1 and JP2 are used to set the frequency ratio of your processor. Refer to the following pages for the frequency ratio that corresponds to your processor and set these jumpers accordingly.

After setting these jumpers, an Intel processor will multiply the external bus clock by the frequency ratio to become the internal clock speed. Internal clock speed is the commonly used speed of Intel processors in the market and is the actual operating clock of the processor (external bus clock x frequency ratio = internal clock speed).



AMD processors use the PR-rating system which is the overall processor performance rating.

Jumpers JP15 and JP29 are used to set the voltage of your processor. Make sure these jumpers are set correctly, otherwise your system will hang.

The table below shows the External System Bus Clock of the CPUs supported by the system board and their corresponding PCI Clock and ISA Bus Clock.

External System Bus Clock	PCI Clk	ISA Bus Clk
60MHz	30MHz	7.5MHz
66MHz	33MHz	8.25MHz



## Jumper Settings for Intel<sup>®</sup> Processors

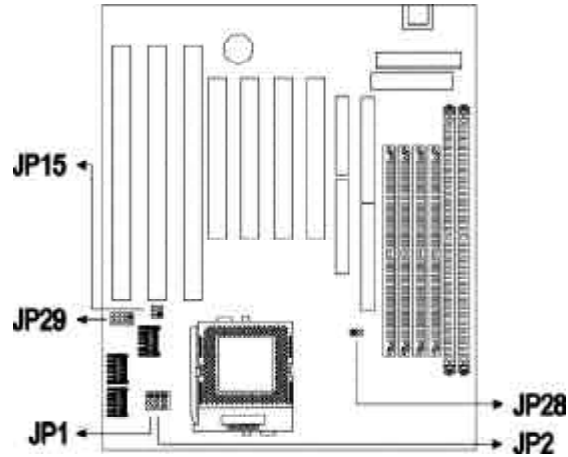

Intel <sup>®</sup> Processors	Ext. System Bus Clk	JP28
90/120/150MHz	60MHz	1-2 On
100/133/166/200MHz MMX-166/200/233MHz	66MHz*	1-2 Off



\* Default

Intel <sup>®</sup> Processors	Freq. Ratio	JP1	JP2
90/100MHz/MMX-233MHz	1.5x*	1-2 On	1-2 On
120/133MHz	2x	2-3 On	1-2 On
150/166MHz/MMX-166MHz	2.5x	2-3 On	2-3 On
200MHz/MMX-200MHz	3x	1-2 On	2-3 On

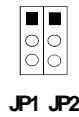

\* Default

CPU Voltages	JP29				JP15	
	Pins 7-8	Pins 5-6	Pins 3-4	Pins 1-2	Pins 3-4	Pins 1-2
2.8V	On	Off	Off	Off	On	Off
2.9V	On	Off	Off	On	On	Off
3.2V	On	On	Off	Off	On	Off
3.3V	On	On	Off	On	On	Off
3.5V*	On	On	On	On	On	Off

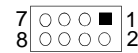

JP29



JP15

\* Default

## Jumper Settings for AMD-K5/K6 Processors

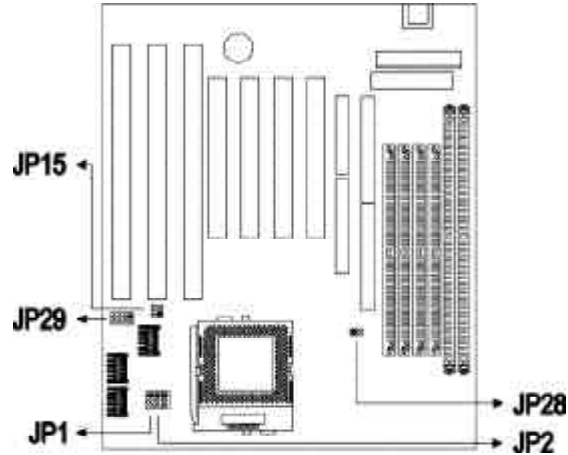

PR-Rating	Ext. System Bus Clk	JP28
K5:PR90/PR120/PR150	60MHz	1-2 On
K5:PR100/PR133/PR166	66MHz	1-2 Off
K6:PR2-166/PR2-200/ PR2-233	66MHz	1-2 Off



PR-Rating	Freq. Ratio	JP1	JP2
K5:PR90/PR100/ PR120/PR133	1.5x	1-2 On	1-2 On
K5:PR150/PR166	2x	2-3 On	1-2 On
K6:PR2-166	2.5x	2-3 On	2-3 On
K6:PR2-200	3x	1-2 On	2-3 On
K6:PR2-233	3.5x	1-2 On	1-2 On

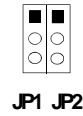

CPU Voltages	JP29				JP15	
	Pins 7-8	Pins 5-6	Pins 3-4	Pins 1-2	Pins 3-4	Pins 1-2
28V	On	Off	Off	Off	On	Off
29V	On	Off	Off	On	On	Off
3.2V	On	On	Off	Off	On	Off
3.3V	On	On	Off	On	On	Off
3.5V*	On	On	On	On	On	Off

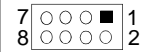

JP29



JP15

\* Default

## Installing Upgrade CPUs

The 586ITB is equipped with a 321-pin Zero Insertion Force (ZIF) socket at location U37 of the system board. This socket is designed for easy removal of an old CPU and easy insertion of an upgrade CPU. The ZIF socket allows you to carefully place the new CPU into its position. If you need to apply excessive force to insert the CPU, you are not installing the CPU correctly.

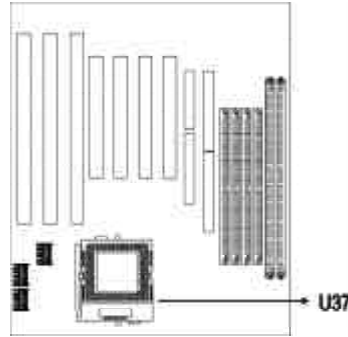

### **Warning:**

*Open the socket only if you are actually installing a CPU. The warranty on the original CPU will be voided if the S/N seal is broken. Before proceeding with the upgrade, take note of the following. The microprocessor and heatsink may be hot if the system has been running. To avoid the possibility of a burn, power the system off and let the processor and heatsink cool for 20 minutes.*

The 321-pin ZIF socket consists of five rows of pin holes on each side. To prevent improper CPU installation, the ZIF socket has a Plug/Keying mechanism. Several holes in the socket are plugged so that the CPU will go in only one way. If you cannot easily insert the CPU, verify that pin 1 of the CPU is aligned with pin 1 of the socket.

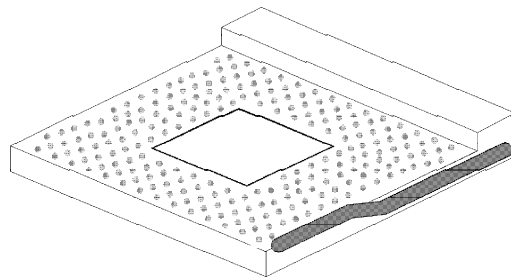

**Zero Insertion Force (ZIF) Socket**

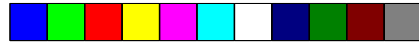

To install an upgrade CPU, do the following:

1. Make sure the handle on the side of the ZIF socket is up. To raise the handle, push it down, slightly pull it out to the side, then raise it as far as it will go. It may be necessary to initially apply a small amount of sideways force to free the handle from its retaining “tab”. Once clear of the “tab”, the handle will open relatively easily. The top plate will slide back. Do not use screwdrivers or other tools to open the socket, or you may damage the system or socket.

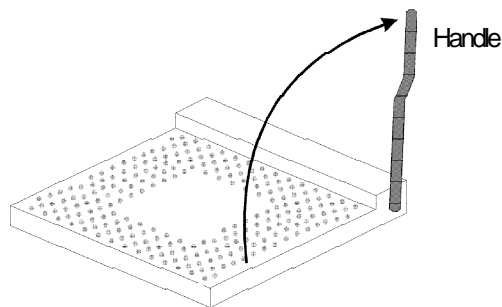

#### Lifting the Handle

2. Once the lever is completely up, remove the old CPU carefully by lifting it straight out of the socket. You are now ready to insert the new CPU.

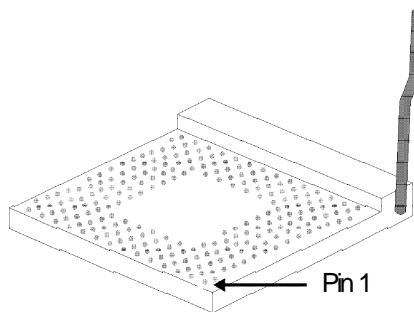



3. Position the CPU above the ZIF socket. Make sure pin 1 of the CPU is aligned with pin 1 of the socket. Lower the chip until the pins are inserted properly in their corresponding holes. Remember that very little force is needed to install the CPU. If the CPU is not easily inserted, verify whether or not pin 1 of the CPU is aligned with pin 1 of the socket. Applying too much pressure can damage the CPU or the socket.

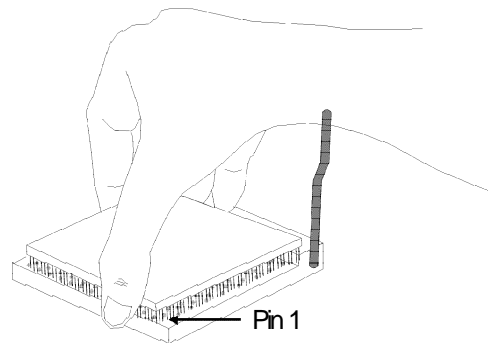

#### **Positioning the CPU Above the ZIF Socket**

4. Push the handle down until the handle locks into place. The top plate will slide forward. You will feel some resistance as pressure starts to secure the CPU in the socket. This is normal and will not damage the CPU. However, if the handle is not completely closed, damage to the CPU and/or system board may result.

#### **Installing A Fan/Heatsink**

You must choose a fan/heatsink suitable for the processor installed on your system board. Position the fan/heatsink on the CPU such that the air from the side of the fan/heatsink will flow across the heat regulators on the system board. See the figure below.

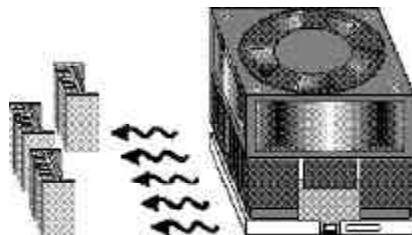



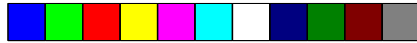

### Clearance Requirements

Your CPU comes with a heatsink mounted on top. To maintain proper airflow once the upgrade is installed on the system board, the CPU and heatsink require certain space clearances. The clearance above the CPU's fan/heatsink must be at least 0.4 inches. The clearance on at least 3 of 4 sides of the processor and heatsink must be at least 0.2 inches. All cables (for floppy drive, hard drive, CD-ROM, etc.) must be routed clear of the CPU and its airspace.

### Fan Exhaust

The CPU must be kept cool by using a fan with heatsink. The temperature of the air entering the fan/heatsink cannot exceed 45°C (113°F). The ambient or room temperature must be below 37°C (99°F).

## Jumper Settings for Modem Ring-on

### Jumper JP26 Modem Ring-on Select

The 586ITB board is equipped with an autodetection of receiving modem ring when your system is in power-off situation. Set jumper JP26 pins 1, 2 to on when connecting COM1 port (CN1), set pins 2, 3 to on when connecting COM2 port (CN3), or set to off to ignore auto detection.

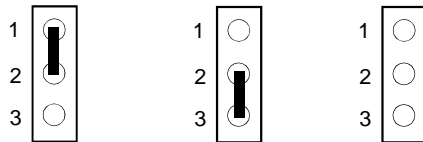
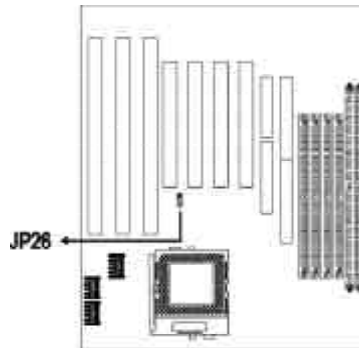

1-2 On: COM1    2-3 On: COM2    Off: Disabled (default)

With a modem being installed, you can remotely transmit or access data without physically going to your system. To “wake up” your system, follow the steps below.

1. If your ATX power supply has an On/Off switch, set this to On so that even when you have shut down your system, it will always remain in “standby” mode. Note that when you need to use this function, you have to shut down your system by the icons under Windows 95.
2. Enable Power Management. This will allow your system to enter Suspend mode after you have finished accessing data. Refer to the Power Management Setup section for more information.
3. Set Jumper JP26 accordingly. This will depend on the COM port where your modem is connected.

**Important:**

*Before connecting your cable to COM1 or COM2 (depending on your setting), you must turn on the power of modem first to avoid your ATX power supply being interfered.*

## Factory Testing Jumpers

The jumpers below are for factory testing only and should always be set to their default configuration. Reconfiguring these jumpers will cause problems with your system board.

**JP14:** 5-6 On, 7-8 On

**JP30:** All Off

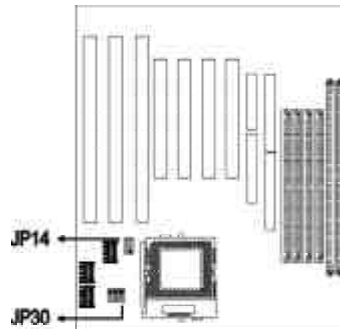



## Ports and Connectors

The 586ITB system board is equipped with two serial connectors (JP20 & JP22), one parallel printer connectors (U26), one shrouded floppy disk header (U28), two shrouded IDE hard disk headers (J7 & J8), two connectors for external USB ports (JP8 & JP9), and one IrDA connector (U32).

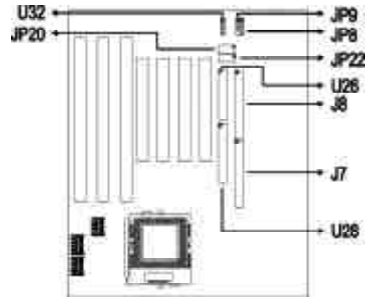

### Serial Connectors

The 586ITB is equipped with two serial connectors at locations JP20 (COM 1) and JP22 (COM 2) of the system board. These serial connectors are RS-232C asynchronous communication connectors with 16C550A-compatible UARTs that can be used with modems, serial printers, remote display terminals, and other serial devices.

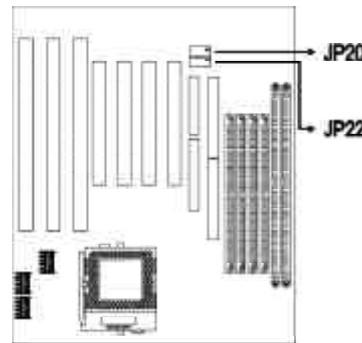

### Parallel Connector

The 586ITB system board has a standard printer connector (U26) for interfacing your PC to a parallel printer. It supports SPP, ECP and EPP modes. You can set the connector's mode in the Integrated Peripherals setup of the Award BIOS (Refer to Chapter 3).

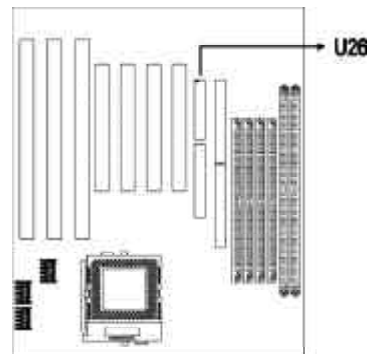



Setting	Function
SPP (Standard Parallel Port)	Allows normal speed operation but in one direction only.
ECP (Extended Capabilities Port)	Allows parallel port to operate in bidirectional mode and at a speed higher than the maximum data transfer rate.
EPP (Enhanced Parallel Port)	Allows bidirectional parallel port operation at maximum speed.

The parallel connector on your system board can be set to any of the following system I/O addresses:

I/O Address	3BC-3BE Hex
	378-37A Hex (default)
	278-27A Hex

## Floppy Disk Drive Controller

The 586ITB system board is equipped with a shrouded floppy disk header that supports two standard floppy disk drives. You can install any 360KB, 720KB, 1.2MB, 1.44MB, or 2.88MB floppy disk drives. To prevent improper floppy cable installation, the shrouded floppy disk header has a keying mechanism. The 34-pin connector on the floppy cable can be placed into the header only if pin 1 of the connector is aligned with pin 1 of the header.

### Connecting the Floppy Disk Cable

1. Install the 34-pin header connector into the shrouded floppy disk header (U28) on the system board. The colored edge of the ribbon should be aligned with pin 1 of connector U28.

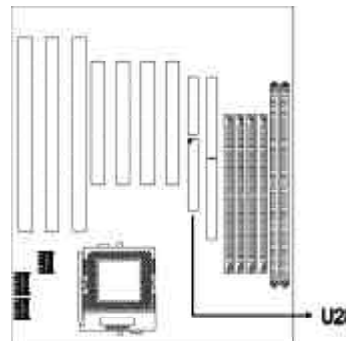



2. Install the other 34-pin header connector(s) into the disk drive(s). Align the colored edge of the daisy chained ribbon cable with pin 1 of the drive edge connector(s). The end-most connector should be attached to the drive you want to designate as Drive A.

## IDE Hard Disk Interface

The 586ITB system board is equipped with two shrouded PCI IDE headers that will interface four Enhanced IDE (Integrated Drive Electronics) hard disk drives.

### Note:

*Only Enhanced IDE hard drives or ATAPI CD-ROMs can be connected to the IDE interface.*

### Connecting the IDE Hard Disk Interface

To prevent improper IDE cable installation, each shrouded PCI IDE header has a keying mechanism. The 40-pin connector on the IDE cable can be placed into the header only if pin 1 of the connector is aligned with pin 1 of the header.

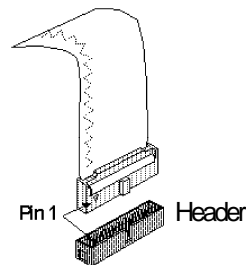

### Note:

*An IDE cable with a standard 40-pin connector (without the keying mechanism) can be installed in the shrouded PCI IDE header. Be extremely careful to match the colored edge of the ribbon with pin 1 of the header.*



## Connecting the Hard Disk Cable

1. If you are connecting two hard drives, install the 40-pin connector of the IDE cable into the primary shrouded IDE header (connector J7). If you are adding a third or fourth IDE device, install the 40-pin connector of the other IDE cable into the secondary shrouded IDE header (connector J8).

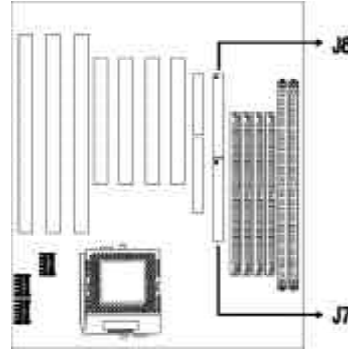

2. Install the other 40-pin header connector(s) into the device with the colored edge of the ribbon cable aligned with pin 1 of the drive edge connector(s).

### Note:

*Refer to your disk drive user's manual for information about selecting proper drive switch settings.*

## Adding a Second IDE Hard Drive

When using two IDE drives, one must be set as the master and the other as the slave. Follow the instructions provided by the drive manufacturer for setting the jumpers and/or switches on the drives.

We recommend that you use Enhanced IDE hard drives from the same manufacturer. In a few cases, drives from two different manufacturers will not function properly when used together. The problem lies in the hard drives, not the 586ITB system board.

## Preparing an IDE Drive for Use

IDE disk drives are already low-level formatted, with any bad-track errors entered, when shipped by the drive manufacturer. Do not attempt to do a low-level format or you may cause serious damage to the drive.



To use an IDE drive, you need to enter the drive type (this information is provided by the drive manufacturer) into the system's CMOS setup table. Then run FDISK and FORMAT provided with DOS. You may also use the IDE HDD Auto Detection function which will allow the BIOS to auto detect your hard drive type. Refer to the IDE HDD Auto Detection section for details.

**Warning:**

*Do not run FDISK and FORMAT programs on a drive that has already been formatted or you will lose all programs and data stored on the drive.*

**Using 586ITB with CD-ROM Drives**

If you encountered problems while using an ATAPI CD-ROM drive that is set in Master mode, please set the CD-ROM drive to Slave mode. Some ATAPI CD-ROMs may not be recognized and cannot be used if incorrectly set in Master mode.

**Universal Serial Bus Connectors**

The 586ITB system board is equipped with two connectors, at locations JP8 (USB 1) and JP9 (USB 2) on the system board, for external USB ports. USB allows data exchange between your computer and a wide range of simultaneously accessible peripherals. Make sure "USB Controller" in the Integrated Peripherals setup of the Award BIOS is Enabled.

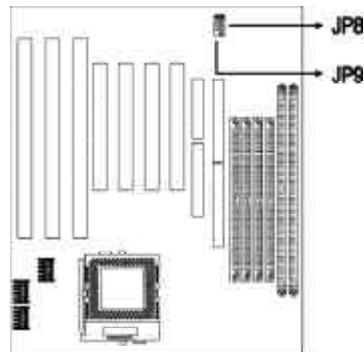

**Connecting the USB Ports**

As an option, one card-edge bracket mounted with two USB port cables may be provided with the system board. The ends of the cables are attached to a connector. Mount the card-edge bracket to the system chassis.

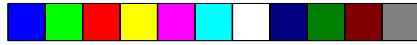

Connect the cable to JP8 and JP9 on the system board. The USB port cables can be inserted only if pin 1 of the cable (red wire) is aligned with pin 1 of JP8 and JP9. Pin 5 of JP9 has been removed and the hole in the USB cable connector, which corresponds to pin 5, has been plugged to prevent incorrectly inserting the connector. Make sure “USB Controller” in the Integrated Peripherals setup of the Award BIOS is Enabled.

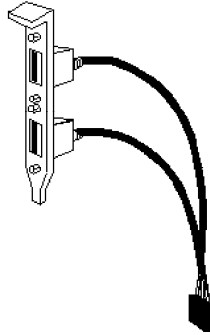

**USB port cables (optional)**

### **IrDA Connector**

The 586ITB system board is equipped with an IrDA connector for wireless connectivity between your computer and peripheral devices. Connect your IrDA cable to connector U32 on the 586ITB system board. Make sure “Onboard IR Controller” in the Integrated Peripherals setup of the Award BIOS is Enabled. Carefully read this section in Chapter 3 of this manual for instructions prior to using your IrDA device.

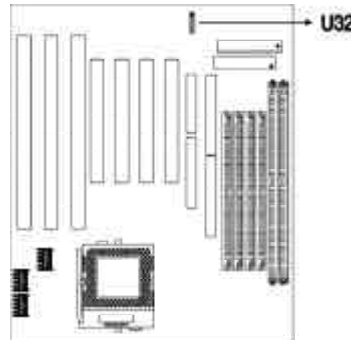



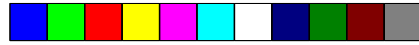

## Installing Expansion Cards

The 586ITB system board is equipped with 3 dedicated PCI slots, 2 dedicated 16-bit ISA slots and 1 shared PCI/ISA slot. All PCI and ISA slots are bus masters.

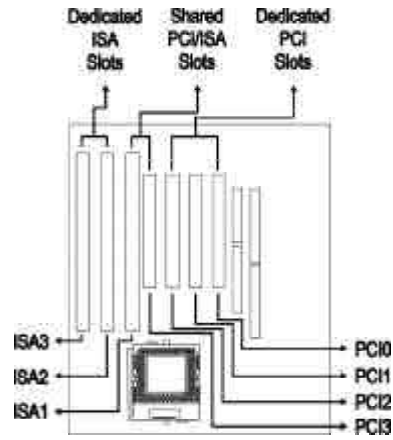



## Chapter 3 Software Installation

---

After you power up your system, the BIOS message appears on your screen and the memory count begins.

After the memory test, the following message will appear on the screen:

*Press DEL to enter setup*

If the message disappears before you respond, restart your system or press the “Reset” button located on the front panel of your computer. You may also restart the system by pressing the <Ctrl> <Alt> and <Del> keys simultaneously.

If you have set a password and selected “System” in the Security Option of the BIOS Features Setup menu, you will be prompted for the password every time the system is rebooted or any time you try to enter Setup. Type in the correct password and press <Enter>.

If you selected “Setup” in the Security Option, you will be prompted for the password only when you try to enter Setup. Refer to the “BIOS Features Setup” section for more information.

### Award CMOS Setup Utility

While booting up, press <Ctrl> <Alt> <Esc> simultaneously or <Del> to enter the Setup utility. A screen similar to the one on the next page will appear.



ROM PCI/ISA BIOS  
CMOS SETUP UTILITY  
AWARD SOFTWARE, INC.

STANDARD CMOS SETUP BIOS FEATURES SETUP CHIPSET FEATURES SETUP POWER MANAGEMENT SETUP PNP/PCI CONFIGURATION LOAD FAIL-SAFE SETTINGS LOAD OPTIMAL SETTINGS	INTEGRATED PERIPHERALS SUPERVISOR PASSWORD USER PASSWORD IDE HDD AUTO DETECTION HDD LOW LEVEL FORMAT SAVE & EXIT SETUP EXIT WITHOUT SAVING
Esc : Quit F10 : Save & Exit Setup	↑↓→← : Select Item (Shift) F2 : Change Color

Use the arrow keys to highlight the option you want and press <Enter>. The following describes each of these options.

**Note:**

*The settings on the BIOS setup screens on the following pages are for reference only. Some of the settings will vary according to your system's configuration and should not be referred to as the standard default setting.*

### Standard CMOS Setup

Use the arrow keys to highlight "Standard CMOS Setup" and press <Enter>. A screen similar to the one below will appear.

ROM PCI/ISA BIOS  
STANDARD CMOS SETUP  
AWARD SOFTWARE, INC.

Date (mm:dd:yy) : Mon, Jul 29 1996								
Time (hh:mm:ss) : 13: 27: 50								
HARD DISKS	TYPE	SIZE	CYLS	HEAD	PRECOMP	LANDZ	SECTOR	MODE
Primary Master	: Auto	0	0	0	0	0	0	0 Auto
Primary Slave	: Auto	0	0	0	0	0	0	0 Auto
Secondary Master	: Auto	0	0	0	0	0	0	0 Auto
Secondary Slave	: Auto	0	0	0	0	0	0	0 Auto
Drive A : 1.44M, 3.5 in.								
Drive B : None								
Video : EGA/VGA								
Halt on : All Errors								
Base Memory : 640K								
Extended Memory : 64512K								
Other Memory : 384K								
Total Memory : 65536K								
Esc : Quit		↑↓→← : Select Item		PU/PD/+/- : Modify				
F10 : Save & Exit Setup		(Shift)F2 : Change						



## Date

The date format is <day>, <month>, <date>, <year>.

Day	Displays a day, from Sunday to Saturday
Month	Displays the month, from January to December
Date	Displays the date, from 1 to 31
Year	Displays the year, from 1900 to 2099

## Time

The time format is <hour>, <minute>, <second>. The time is based on the 24-hour military-time clock. For example, 1 p.m. is 13:00:00.

Hour	Displays hours from 00 to 23
Minute	Displays minutes from 00 to 59
Second	Displays seconds from 00 to 59

## Primary Master, Primary Slave, Secondary Master and Secondary Slave

These categories allow you to enter the appropriate specifications for the type of hard disk drive(s) installed in your system. There are 45 predefined types and 4 user definable types for IDE hard drives. Type 1 to Type 45 are predefined. Type "User" is user-definable.

Press <PgUp> or <PgDn> to select a numbered hard disk type or type the number and press <Enter>. The hard disk will not work properly if you enter improper information for this category. You can use "User" type to define your own drive type manually.

If you select "User" type, you will need to know the information listed below. Enter the information and press <Enter>. This information should be included in the documentation from your hard disk vendor or the system manufacturer.



If the controller of the HDD interface is ESDI, you must select “Type 1”.

If the controller of the HDD interface is SCSI, you must select “None”.

If you select Type “Auto”, the BIOS will auto-detect the HDD & CD-ROM drive at the POST stage and show the IDE for the HDD & CD-ROM drive.

Type	Drive type
Cyls	Number of cylinders
Heads	Number of heads
Precomp	Write precomp
Landzone	Landing zone
Sectors	Number of sectors
Mode	Mode type

If a hard disk has not been installed, select “None” and press <Enter>.

### Drive A and Drive B

These categories identify the types of floppy disk drives installed. The following are the options for drives A and B.

None	No floppy drive is installed
360K, 5.25 in.	5-1/4 inch PC-type standard drive; 360 kilobyte capacity
1.2M, 5.25 in.	5-1/4 inch AT-type high-density drive; 1.2 megabyte capacity
720K, 3.5 in.	3-1/2 inch double-sided drive; 720 kilobyte capacity
1.44M, 3.5 in.	3-1/2 inch double-sided drive; 1.44 megabyte capacity
2.88M, 3.5 in.	3-1/2 inch double-sided drive; 2.88 megabyte capacity

**Note:**

*Choosing an incorrect type might cause your system to format the floppy disk improperly, and you will not be able to access your data.*



## Video

This category selects the type of video adapter used for the primary system monitor. Although secondary monitors are supported, you do not have to select the type in Setup. The default setting is EGA/VGA (BIOS default, Setup default).

EGAVGA	Enhanced Graphics Adapter/Video Graphics Array. For EGA, VGA, SVGA and PGA monitor adapters.
CGA 40	Color Graphics Adapter. Power up in 40-column mode.
CGA 80	Color Graphics Adapter. Power up in 80-column mode.
Mono	Monochrome adapter. Includes high resolution monochrome adapters.

## Halt On

This category determines whether the system will stop if an error is detected during power up. The default setting is All Errors (BIOS default, Setup default).

No Errors	The system boot will not stop for any errors detected.
All Errors	The system boot will stop whenever the BIOS detects a non-fatal error.
All, But Keyboard	The system boot will not stop for a keyboard error; it will stop for all other errors.
All, But Diskette	The system boot will not stop for a disk error; it will stop for all other errors.
All, But Disk/Key	The system boot will not stop for a disk or keyboard error; it will stop for all other errors.

## Memory

The base memory size, extended memory size and the other memory size cannot be altered; your computer automatically detects and displays them.

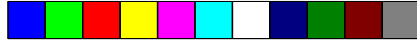

Base Memory	This refers to the amount of base or conventional memory installed on the system board.
Extended Memory	This is the amount of memory located above 1MB in the memory address map of the CPU.
Other Memory	This memory size refers to the memory located in the address space between 640K and 1024K. DOS uses this area to load device drivers to keep base memory free for application programs. The most appropriate use of this area is for Shadow RAM.

## BIOS Features Setup

The BIOS Features Setup allows you to configure your system for basic operation. Some entries are defaults required by the system board, while others, if enabled, will improve the performance of your system or let you set some features according to your preference.

ROM PCI/ISA BIOS  
BIOS FEATURES SETUP  
AWARD SOFTWARE, INC.

Virus Warning	: Disabled	Video BIOS Shadow	: Enabled
CPU Internal Cache	: Enabled	C8000-CBFFF Shadow	: Disabled
External Cache	: Enabled	CC000-CFFFF Shadow	: Disabled
Quick Power On Self Test	: Disabled	D0000-D3FFF Shadow	: Disabled
Boot Sequence	: A, C, SCSI	D4000-D7FFF Shadow	: Disabled
Swap Floppy Drive	: Disabled	D8000-DBFFF Shadow	: Disabled
Boot Up Floppy Seek	: Enabled	DC000-DFFFF Shadow	: Disabled
Boot Up NumLock Status	: On		
Typeomatic Rate Setting	: Disabled		
Typeomatic Rate (Chars/Sec)	: 6		
Typeomatic Delay (Msec)	: 250		
Security Option	: Setup		
PCI/VGA Palette Snoop	: Disabled		
OS Select For DRAM > 64MB	: Non-OS2		
		ESC : Quit	↑↓←→ : Select Item
		F1 : Help	PU/PD/+/- : Modify
		F5 : Old Values (Shift)	F2 : Color
		F6 : Load Fail-Safe Settings	
		F7 : Load Optimal Settings	

## Virus Warning

This category protects the boot sector and partition table of your hard disk drive. When this item is enabled, the Award BIOS will monitor the boot sector and partition table of the hard disk drive. If an attempt is made to write to the boot sector or partition table of the hard disk drive, the BIOS will halt the system and the following error message will appear.

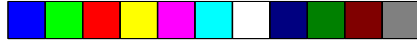

**! WARNING !**  
 Disk boot sector is to be modified  
 Type "Y" to accept write or "N" to abort write  
 Award Software, Inc.

After seeing this message, if necessary, you will be able to run an anti-virus program to locate and remove the problem before any damage is done.

Many disk diagnostic programs which attempt to access the boot sector table will cause the warning message to appear. If you are running such a program, we recommend that you first disable this category. Also, disable this category if you are installing or running certain operating systems like Windows 95 or the operating system may not install nor work.

Enabled	BIOS issues a warning when any program or virus sends a Disk Format command or attempts to write to the boot sector of the hard disk drive.
Disabled	No warning message will appear when the boot sector of the hard disk drive is accessed.

### CPU Internal Cache and External Cache

These categories speed up memory access. The default value is enabled. Enable the External Cache for better performance.

Enabled	Enables the internal/external cache.
Disabled	Disables the internal/external cache.

### Quick Power On Self Test

This category speeds up Power On Self Test (POST) after you power on your system. If it is set to Enabled, the BIOS will shorten or skip some check items during POST.

Enabled	Enables quick POST.
Disabled	Normal POST.





## Boot Sequence

This category determines which drive to search first for the disk operating system (i.e. DOS). The default is A, C, SCSI.

The options are: A, C, SCSI; C, A, SCSI; C, CDROM, A; CDROM, C, A; D, A, SCSI; E, A, SCSI; F, A, SCSI; SCSI, A, C; SCSI, C, A; or C only.

## Swap Floppy Drive

Enabled	When this option is enabled and the system is booting from the floppy drive, the system will boot from drive B instead of drive A.
Disabled	When this option is disabled and the system is booting from the floppy drive, the system will boot from drive A.

## Boot Up Floppy Seek

During POST, the BIOS will determine if the floppy disk drive installed is 40 or 80 tracks. 360K type is 40 tracks while 720K, 1.2M, 1.44M and 2.88M are all 80 tracks.

Enabled	The BIOS will check whether the floppy disk drive installed is 40 or 80 tracks. Note that the BIOS cannot distinguish between 720K, 1.2M, 1.44M or 2.88M drive types as they are all 80 tracks.
Disabled	The BIOS will not search for the type of floppy disk drive by track number. Note that there will not be any warning message if the drive installed is 360KB.

## Boot Up NumLock Status

This allows you to determine the default state of the numeric keypad. By default, the system boots up with NumLock on.

On	The function of the numeric keypad is the number keys.
Off	The function of the numeric keypad is the arrow keys.

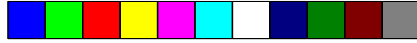

### Security Option

This category allows you to limit access to your system and Setup or just to Setup.

System	The system will not boot and access to Setup will be denied if the correct password is not entered at the prompt.
Setup	The system will boot, but access to Setup will be denied if the correct password is not entered at the prompt.

### PCI/VGA Palette Snoop

This is used to select whether to allow MPEG ISA/VESA VGA cards to work with PCI/VGA or not.

Enabled	PCI/VGA working with MPEG ISA/VESA VGA cards.
Disabled	PCI/VGA not working with MPEG ISA/VESA VGA cards.

### OS Select for DRAM > 64MB

This item allows you to access the memory that is over 64MB in OS/2. The options are: Non-OS2 and OS2.

### Video BIOS Shadow

Determines whether video BIOS will be copied to RAM. Video Shadow will increase the video speed. Note that some graphics boards require that this option be disabled.

Enabled	Video shadow is enabled.
Disabled	Video shadow is disabled.

### C8000-CBFFF Shadow to DC000-DFFFF Shadow

These categories determine whether option ROMs will be copied to RAM.



Enabled	Optional shadow is enabled.
Disabled	Optional shadow is disabled.

## Chipset Features Setup

This section gives you instructions on how to configure the system based on the specific features of the chipset. This chipset manages bus speeds and access to system memory resources. It also coordinates communications between the conventional ISA bus and the PCI bus. These items should not be altered unless necessary. Depending on your add-in boards, you may not or should not enable some of those features. The default settings have been chosen because they provide the best operating conditions for your system. The only time you might consider making any changes would be if you discovered some incompatibility or that data was being lost while using your system.

ROM PCI/ISA BIOS  
CHIPSET FEATURES SETUP  
AWARD SOFTWARE, INC.

Auto Configuration	: Enabled	
DRAM Timing	: Normal	
DRAM Leadoff Timing	: 11/7/4	
DRAM Read Burst (EDO/FP)	: x444/x444	
DRAM Write Burst Timing	: x444	
Fast EDO Lead Off	: Disabled	
Refresh RAS# Assertion	: 5 Clks	
Fast RAS To CAS Delay	: 3	
DRAM Page Idle Timer	: 4 Clks	
DRAM Enhanced Paging	: Enabled	
Fast MA to RAS# Delay	: 2 Clks	
SDRAM (CAS Lat/RAS-to-CAS)	: 3/3	
System BIOS Cacheable	: Disabled	
Video BIOS Cacheable	: Disabled	
8 Bit I/O Recovery Time	: 4	
16 Bit I/O Recovery Time	: 2	
Memory Hole At 15M-16M	: Disabled	
Extended CPU-PIIX4 PHLDA#	: Disabled	
Host-to-PCI Bridge Retry	: Disabled	
PCI Concurrency	: Enabled	
Mem. Drive Str. (MA/RAS)	: 16mA/16mA	
		ESC : Quit      ↑ ↓ → ← : Select Item
		F1 : Help      PU/PD/+/- : Modify
		F5 : Old Values (Shift) F2 : Color
		F6 : Load Fail-Safe Settings
		F7 : Load Optimal Settings

## Power Management Setup

Power Management Setup allows you to configure your system to most effectively save energy. If you like to use the soft power down feature of Windows 95, you must enable the Power Management below. Select Min. Power, Max. Power or User Defined. Either one can be used as long as it is NOT disabled.



ROM PCI/ISA BIOS  
POWER MANAGEMENT SETUP  
AWARD SOFTWARE, INC.

Power Management : Disabled	** Reload Global Timer Events **
PM Control by APM : Yes	IRQ [3-7, 9-15], NMI : Enabled
Video Off Method : V/H SYNC+Blank	Primary IDE 0 : Disabled
Video Off After : Standby	Primary IDE 1 : Disabled
Doze Mode : Disabled	Secondary IDE 0 : Disabled
Standby Mode : Disabled	Secondary IDE 1 : Disabled
Suspend Mode : Disabled	Floppy Disk : Disabled
HDD Power Down : Disabled	Serial Port : Enabled
Throttle Duty Cycle : 62.5%	Parallel Port : Disabled
VGA Active Monitor : Enabled	
Soft-Off by PWR-BTTN : Hold 4 Sec.	
Resume by Ring : Enabled	
Resume by Alarm : Disabled	
** Break Event From Suspend **	ESC : Quit      ↑ ↓ → ← : Select Item
IRQ 8 Clock Event : Disabled	F1 : Help      PU/PD +/- : Modify
	F5 : Old Values (Shift) F2 : Color
	F6 : Load Fail-Safe Settings
	F7 : Load Optimal Settings

### Power Management

This category allows you to select the type (or degree) of power saving by changing the length of idle time that elapses before each of the following modes are activated: Doze Mode, Standby Mode, and Suspend Mode.

Disable (default)	No power management. Disables the Doze, Standby and Suspend modes.
Min. Power Saving	Minimum power management. Doze Mode = 1 hr., Standby Mode = 1 hr., and Suspend Mode = 1 hr.
Max. Power Saving	Maximum power management. Doze Mode = 1 min., Standby Mode = 1 min., and Suspend Mode = 1 min.
User Defined	Allows you to set each mode individually. When enabled, each option ranges from 1 min. to 1 hr.

### PM Control by APM

Yes	An Advanced Power Management device will be activated to enhance the Max. Power Saving mode and stop the CPU's internal clock. Use this option in Windows 95. (default)
Nb	The system BIOS will ignore APM when initiating the Power Management mode.



### Video Off Method

This determines the manner in which the monitor is blanked.

V/H SYNC + Blank	This selection will cause the system to turn off the vertical and horizontal synchronization ports and write blanks to the video buffer.
Blank Screen	This option only writes blanks to the video buffer.
DPMS	Initializes display power management signaling. Use this option if your video board supports it.

### Video Off After

NA	The system BIOS will never turn off the screen.
Suspend	The screen is off when the system is in the Suspend mode.
Standby	The screen is off when the system is in the Standby mode.
Doze	The screen is off when the system is in the Doze mode.

### Doze Mode, Standby Mode, Suspend Mode and HDD Power Down

These Green PC power saving categories are user configurable only when the Power Management category is set to User Defined.

Doze Mode	When enabled and after the set time of system inactivity, the CPU clock will run at a slower speed (1/2 of full speed) while all other devices still operate at full speed.
Standby Mode	When enabled and after the set time of system inactivity, the CPU clock will run at a speed slower than the speed during Doze mode (1/3 of full speed) while all other devices still operate at full speed.



Suspend Mode	When enabled and after the set time of system inactivity, the CPU and onboard peripherals will be shut off.
HDD Power Down	This is used to define the continuous HDD idle time that elapses before the HDD enters the power saving mode (motor off). When enabled and after the set time of system inactivity, the hard disk drive will be powered down while all other devices remain active.

### Throttle Duty Cycle

This category allows you to select the rate of reduction with your external system bus clock to save power.

Options	12.5%, 25.0%, 37.5%, 50.0%, 62.5%, 75.0%, and 87.5%.
Default	62.5%.

### VGA Active Monitor

This category allows you to enable or disable the VGA activities that cause the system to wake up from power saving mode.

Enabled	VGA activities will cause the system to wake up from power saving mode.
Disabled	VGA activities will not cause the system to wake up from power saving mode.

### Soft-Off by PWR-BTTN (for ATX power supply only)

This category allows you to select the power-off time with pressing power button.

Hold 4 Sec.	This option allows you to power off your system by pressing power button for 4 sec. at least. If you press power button once with this option, your system will not be powered off and will be in suspend mode.
Instant-Off	This option allows you to press power button once and power off your system instantly.



### **Resume by Ring (for ATX power supply only)**

Set "Resume by Ring" to COM 1 or COM 2. This will depend on the COM port where your modem is connected. Refer to pages 25 and 26 for detailed information.

### **Resume by Alarm (for ATX power supply only)**

This category allows you to set the day and time of resumption for your computer automatically.

Enabled	Enables to set the alarm time. When setting Enabled, you can set the day and time with the next two showing items of the Resume by Alarm. Set the IRQ 8 Clock Event under Break Event From Suspend to Enabled when selecting this option.
Disabled	Disables to set the alarm time. (default)

### **Break Event From Suspend and Reload Global Timer Events**

These are I/O events whose occurrence can prevent the system from entering a power saving mode or can awaken the system from such a mode. In effect, the system remains alert for anything which occurs to a device which is configured as enabled, even when the system is in a power saving mode.

When an I/O device wants to gain the attention of the operating system, it signals this by causing an IRQ to occur. When the operating system is ready to respond to the request, it interrupts itself and performs the service.

### **PNP/PCI Configuration**

This section describes configuring the PCI bus system. It covers some very technical items, and it is strongly recommended that only experienced users make any changes to the default settings.



ROM PCI/ISA BIOS  
PNP/PCI CONFIGURATION  
AWARD SOFTWARE, INC.

PNP OS Installed : No	PCI IDE IRQ Map To : PCI-Auto
Resources Controlled By : Auto	Primary IDE INT# : A
Reset Configuration Data : Disabled	Secondary IDE INT# : B
	Assign IRQ for VGA : Enabled
ESC : Quit      ↑ ↓ → ← : Select Item F1 : Help      PU/PD +/- : Modify F5 : Old Values (Shift) F2 : Color F6 : Load Fail-Safe Settings F7 : Load Optimal Settings	

### PNP OS Installed

This category is used to disable or enable your Plug and Play with your operating system.

Yes	Select this option when you need Windows 95 to detect Plug and Play devices automatically.
Nb	Select this option when you need Plug and Play devices to be detected by BIOS for some compatible resources. We recommend that you select this option to choose the PnP devices by BIOS. (default)

### Resources Controlled By

The Award Plug and Play BIOS has the capacity to automatically configure all of the boot and Plug and Play compatible devices.

Auto	The system will automatically detect the settings for you. The categories that follow will not be shown on the PNP/PCI Configuration screen.
Manual	This allows you to set the IRQ/DMA (you have assigned your add-in card) to Legacy ISA or PCI/ISA PnP. For non-PnP ISA cards, select Legacy ISA. For PnP ISA or PCI cards, select PCI/ISA PnP.



### Reset Configuration Data

Enabled	The BIOS will reset the configuration data once automatically.
Disabled	The BIOS will not reset the configuration data.

### PCI IDE IRQ Map To

This category is used to configure your system to the type of IDE disk controller in use.

ISA	Designates which ISA slot is installed with an IDE controller card; that is, if you are using an IDE controller card.
PCI-Auto	The system will scan and determine the PCI slot that is installed with an IDE controller card.

### Primary IDE INT# and Secondary IDE INT#

The Primary and Secondary IDE INT# categories are used to select the PCI interrupt (A, B, C, or D) that is associated with the connected hard drives.

### Assign IRQ for VGA

If Enabled, the system will automatically set an IRQ for the VGA card installed. Your VGA card will need an IRQ address only when using the video capture function of the card. If you are not using this function and a new device requires an IRQ address, you can set this function to Disabled. The IRQ address (previously occupied by the VGA card) will be available for your new device.

### Load Fail-Safe Settings

The "Load Fail-Safe Settings" option loads the troubleshooting default values permanently stored in the ROM chips. These settings are not optimal and turn off all high performance features. You should use these values only if you have hardware problems. Highlight this option on the main menu and press <Enter>. The message below will appear.



### Load Fail-Safe Settings (Y/N)? N

If you want to proceed, type <Y> and press <Enter>. The default settings will be loaded.

### Load Optimal Settings

The "Load Optimal Settings" option loads optimized settings from the BIOS ROM. Use the Setup default values as standard values for your system.

Highlight this option on the main menu and press <Enter>. The message below will appear.

### Load Optimal Settings (Y/N)? N

Type <Y> and press <Enter> to load the Setup default values.

### Integrated Peripherals

ROM PCI/ISA BIOS  
INTEGRATED PERIPHERALS  
AWARD SOFTWARE, INC.

IDE HDD Block Mode : Enabled	KBC input clock : 8MHz
IDE Primary Master PIO : Auto	Onboard FDC Controller: Enabled
IDE Primary Slave PIO : Auto	Onboard Serial Port 1 : 3F8/IRQ4
IDE Secondary Master PIO : Auto	Onboard Serial Port 2 : 2F8/IRQ3
IDE Secondary Slave PIO : Auto	Onboard IR Controller : Disabled
IDE Primary Master UDMA : Auto	
IDE Primary Slave UDMA : Auto	
IDE Secondary Master UDMA : Auto	
IDE Secondary Slave UDMA : Auto	
On-chip Primary PCI IDE : Enabled	Onboard Parallel Port : 378/IRQ7
On-chip Secondary PCI IDE : Enabled	Parallel Port Mode : SPP
USB Keyboard Support : Disabled	
ESC : Quit      ↑ ↓ → ← : Select Item F1 : Help      PU/PD/+/=: Modify F5 : Old Values (Shift) F2 : Color F6 : Load Fail-Safe Settings F7 : Load Optimal Settings	

### IDE HDD Block Mode

Enabled	The IDE HDD uses the block mode. The system BIOS will check the hard disk drive for the maximum block size the system can transfer. The block size will depend on the type of hard disk drive installed.
Disabled	The IDE HDD uses the standard mode.



### **IDE Primary Master/Slave PIO and IDE Secondary Master/Slave PIO**

Your system supports five modes, 0 (default) to 4, which primarily differ in timing. When Auto is selected, the BIOS will select the best available mode after checking your hard drive or CD-ROM.

Auto	The BIOS will automatically set the system according to your hard disk drive's timing.
0-4	You can select a mode that matches your hard disk drive's timing. Caution: Do not use the wrong setting or you will have drive or CD-ROM errors.

### **IDE Primary Master/Slave UDMA and IDE Secondary Master/Slave UDMA**

These categories allow you to set the Ultra DMA in use. When Auto is selected, the BIOS will select the best available option after checking your hard drive or CD-ROM.

Auto	The BIOS will automatically detect the settings for you.
Disabled	The BIOS will not detect these categories.

### **On-Chip Primary PCI IDE and On-Chip Secondary PCI IDE**

These categories allow you to enable or disable the primary and secondary IDE controller. The default is Enabled. Select Disabled if you want to add a different hard drive controller.

### **USB Keyboard Support**

This category allows you to enable or disable the USB Keyboard Support. The default is Disabled. Select Enabled if you are in MS-DOS and your keyboard is not working.

### **KBC input clock**

This category allows you to select the input clock of your keyboard.

Options	6MHz, 8MHz, 12MHz and 16MHz
Default	8MHz

### Onboard FDC Controller

Enabled	Enables the onboard floppy disk controller.
Disabled	Disables the onboard floppy disk controller.

### Onboard Serial Port 1 and Onboard Serial Port 2

Auto	The system will automatically select an I/O address for the onboard serial port 1 and serial port 2.
3F8/IRQ4, 2F8/IRQ3 3E8/IRQ4, 2E8/IRQ3	Allows you to manually select an I/O address for the onboard serial port 1 and serial port 2.
Disabled	Disables the onboard serial port 1 and/or serial port 2.

### Onboard IR Controller

The 586ITB system board supports IrDA function for wireless connectivity between your computer and peripheral devices. You may not use IrDA (U32) and the COM 2 serial port (JP22) at the same time. If you are using the COM 2 serial port, make sure “Onboard IR Controller” is Disabled.

To use the IrDA function, follow the steps below.

1. Connect your IrDA cable to connector U32 on the 586ITB system board.
2. Set “Onboard IR Controller” to Enabled.
3. If Enabled, the following options will appear right after “Onboard IR Controller”.

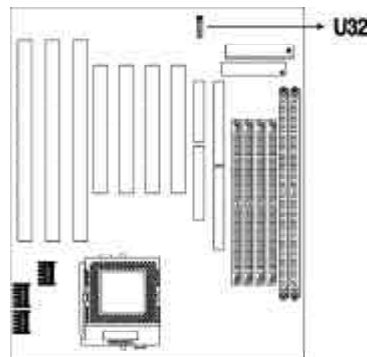

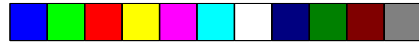

### IR Address Select

This is used to select an I/O address for the IrDA peripheral/device installed. The options are: 3F8H, 2F8H, 3E8H and 2E8H. Default setting: 2E8H.

### IR Mode

Set "IR Mode" to the type of IrDA standard supported by your IrDA peripheral/device. The options are: IrDA (HP mode) and ASKIR (Sharp mode). Default setting: IrDA.

### IR Transmission Delay

If this option is Enabled, transmission of data will be slower. This is recommended when you encounter transmission problem with your device. The options are: Enabled and Disabled.

### IR IRQ Select

Selects an IRQ for the IrDA peripheral/device installed. The options are: IRQ3, IRQ4, IRQ10 and IRQ11. The default setting is IRQ10.

## Onboard Parallel Port

378/IRQ7 3BC/IRQ7 278/IRQ5	Selects the I/O address and IRQ for the onboard parallel port.
Disabled	Disables the onboard parallel port.

## Parallel Port Mode

Parallel Port Mode will appear only if you selected an I/O address and IRQ in the Onboard Parallel Port option (shown above). This option applies to a standard specification and will depend on the speed of your device.

SPP EPP ECP ECP+EPP	Selects the parallel port mode according to the type of printer device connected to your onboard parallel port.
------------------------------	---



If you selected EPP, “EPP Mode Select” will appear. This option applies to standard specification. The options are EPP1.9 and EPP1.7. Default setting: EPP1.7.

If you selected ECP, “ECP Mode Use DMA” will appear. This is used to select a DMA channel for the parallel port. The options are 1 and 3. Default setting: 3.

If you selected ECP+EPP, “ECP Mode Use DMA” and “EPP Mode Select” will both appear on the screen.

### **Supervisor Password**

If you want to protect your system and setup from unauthorized entry, set a supervisor’s password with the “System” option selected in the BIOS Features Setup.

If you want to protect access to setup only, but not your system, set a supervisor’s password with the “Setup” option selected in the BIOS Features Setup. You will not be prompted for a password when you cold boot the system.

Use the arrow keys to highlight the “Supervisor Password” option and press <Enter>. The message below will appear.

*Enter Password:*

Type in the password. You are limited to eight characters. When done, the message below will appear:

*Confirm Password:*

You are being asked to verify the password. Type in exactly the same password. If you type in a wrong password, you will be prompted to enter the correct password again.

To delete or disable the password function, highlight “Supervisor Password” and press <Enter>, instead of typing in a new password. Press the <Esc> key to return to the main menu.

## User Password

If you want another user to have access only to your system but not to setup, set a user's password with the "System" option selected in the BIOS Features Setup.

If you want a user to enter a password when trying to access setup, set a user's password with the "Setup" option selected in the BIOS Features Setup. Using a user's password to enter Setup allows a user to access only the "User Password" option that appears on the main screen. Access to all other options is denied.

To set, confirm, verify, disable or delete a user's password, follow the procedures described in the section "Supervisor Password". If you forget your password, refer to the procedure described in the same section.

## IDE HDD Auto Detection

This option detects the hard disk parameters for the hard disk drives installed in your system. Highlight this option and press <Enter>. A screen similar to below will appear.

ROM PCI/ISA BIOS  
CMOS SETUP UTILITY  
AWARD SOFTWARE, INC.

HARD DISKS	TYPE	SIZE	CYLS	HEAD	RECOMP	LANDZ	SECTOR	MODE
Primary Master:								
Select Primary Master Option (N=Skip): N								
OPTIONS	SIZE	CYLS	HEAD	RECOMP	LANDZ	SECTOR	MODE	
2 (Y)	853	827	32	0	1653	63	LBA	
1	853	1654	16	65535	1653	63	Normal	
3	853	827	32	65536	1653	63	Large	

Note: Some OS (like SCO-UNIX) must be "NORMAL" for installation

ESC: Skip

Enter your choice, and press <Enter> to accept the parameters or press <Esc> to abort. The parameters of the hard disk will be displayed in the Standard CMOS Setup.



## Hard Drive Mode

The system board supports three HDD modes: Normal, LBA and Large. If your hard disk drive does not support LBA mode, the “LBA” option will not be displayed. If your HDD has 1024 or fewer cylinders, the “Large” option will not be displayed. If your hard drive is larger than 2.1GB, be sure that your operating system supports it or you may need to create separate partitions.

### Normal Mode

Normal mode is the generic access mode in which neither the BIOS nor the IDE controller will make any transformations during hard-drive access.

The maximum number of cylinders, heads and sectors for Normal mode are 1024, 16 and 63, respectively.

	no. Cylinders	(1024)
x	no. Heads	( 16)
x	no. Sectors	( 63)
x	bytes per sector	( 512)

---

528 megabytes

If you set your HDD to Normal mode, the maximum accessible HDD will be 528 megabytes even though the physical size of the HDD may be greater than that.

### LBA (Logical Block Addressing) Mode

LBA mode is a HDD accessing method to overcome the 528 megabyte limitation. The number of cylinders, heads and sectors shown on the screen may not be the actual number for the HDD.

During HDD accessing, the IDE controller will transform the logical address described by the sector, head and cylinder number into its own physical address inside the HDD.

The maximum HDD size supported by the LBA mode is 8.4 gigabytes. It is obtained by the following formula.



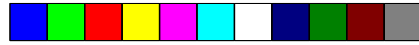

	no. Cylinders	(1024)
x	no. Heads	( 255)
x	no. Sectors	( 63)
x	bytes per sector	( 512)

---

8.4 gigabytes

### Large Mode

Large mode is the extended HDD access mode supported by the system board. Some IDE HDDs have more than 1024 cylinders without LBA support (in some cases, you may not want the LBA mode). This system board provides another alternative to support these kinds of HDDs.

The BIOS tells the operating system that the number of cylinders is half the actual number and that the number of heads is double the actual number. During disk access, the reverse conversion is done by the INT13h routine.

Maximum HDD size:

	no. Cylinders	(1024)
x	no. Heads	( 32)
x	no. Sectors	( 63)
x	bytes per sector	( 512)

---

1 gigabyte

**Note:**

*To support LBA or Large mode, address translation software is included in the Award BIOS HDD Service Routine (INT13h). If you are running an operating system that bypasses the BIOS INT13 Service Routine, LBA and Large Mode may fail.*

### HDD Low Level Format

The HDD Low Level Format utility is designed as a tool to save you time formatting your hard disk. It automatically looks for the necessary information of the drive you selected. This utility also searches for bad tracks and lists them for your reference. Highlight this option and press <Enter>. A screen similar to the one below will appear.



ROM PCI/ISA BIOS  
CMOS SETUP UTILITY  
AWARD SOFTWARE, INC.

Hard Disk Low Level Format Utility							No. CYLS HEAD
SELECT DRIVE							
BAD TRACK LIST							
PERFORMED							
Current select drive is : C							
DRIVE: C CYLINDER: 0 HEAD: 0							
SIZE	CYLS	HEAD	RECOMP	LANDZ	SECTOR	MODE	
Primary Master:	853	1654	16	65536	1653	63 AUTO	
Primary Slave:	0	0	0	0	0	0 AUTO	
Secondary Master:	0	0	0	0	0	0 AUTO	
Secondary Slave:	0	0	0	0	0	0 AUTO	
Up/Down-Select item      ENTER-Accept      ESC-Exit/Abort							
Copyright (C) Award Software, Inc. 1992-94 All Rights Reserved							

**Warning:**

*Do not use this HDD Low Level Format feature for IDE hard drives. They already have been low-level formatted at the factory. Do a high-level format only for these drives. Refer to the manual that comes with your operating system.*

**Save & Exit Setup**

When all the changes have been made, highlight "Save & Exit Setup" and press <Enter>. The message below will appear:

*Save to CMOS and Exit (Y/N)? N*

Type "Y" and press <Enter>. The modifications you have made will be written into the CMOS memory, and the system will reboot. You will once again see the initial diagnostics on the screen. If you wish to make additional changes to the setup, press <Ctrl> <Alt> <Esc> simultaneously or <Del> after memory testing is done.

**Exit Without Saving**

When you do not want to save the changes you have made, highlight "Exit Without Saving" and press <Enter>. The message below will appear:

*Quit Without Saving (Y/N)? N*



Type "Y" and press <Enter>. The system will reboot and you will once again see the initial diagnostics on the screen. If you wish to make any changes to the setup, press <Ctrl> <Alt> <Esc> simultaneously or <Del> after memory testing is done.

## System Error Report

When the BIOS encounters an error that requires the user to correct something, either a beep code will sound or a message will be displayed in a box in the middle of the screen and the message, PRESS F1 TO CONTINUE, CTRL-ALT-ESC or DEL TO ENTER SETUP, will be shown in the information box at the bottom. Enter Setup to correct the error.

### POST Beep

There are two kinds of beep codes in the BIOS. One code indicates that a video error has occurred and the BIOS cannot initialize the video screen to display any additional information. This beep code consists of a single long beep followed by three short beeps. The other code indicates that a DRAM error has occurred. This beep code consists of a single long beep.

### Error Messages

One or more of the following messages may be displayed if the BIOS detects an error during the POST. This list indicates the error messages for all Awards BIOSes:

#### **CMOS BATTERY HAS FAILED**

The CMOS battery is no longer functional. It should be replaced.

#### **Caution:**

Danger of explosion if battery incorrectly replaced. Replace only with the same or equivalent type recommended by the manufacturer. Dispose of used batteries according to the battery manufacturer's instructions.



### **CMOS CHECKSUM ERROR**

Checksum of CMOS is incorrect. This can indicate that CMOS has become corrupt. This error may have been caused by a weak battery. Check the battery and replace if necessary.

### **DISPLAY SWITCH IS SET INCORRECTLY**

The display switch on the motherboard can be set to either monochrome or color. This indicates the switch is set to a different setting than indicated in Setup. Determine which setting is correct, either turn off the system and change the jumper or enter Setup and change the VIDEO selection.

### **FLOPPY DISK(S) fail (80)**

Unable to reset floppy subsystem.

### **FLOPPY DISK(S) fail (40)**

Floppy type mismatch.

### **Hard Disk(s) fail (80)**

HDD reset failed.

### **Hard Disk(s) fail (40)**

HDD controller diagnostics failed.

### **Hard Disk(s) fail (20)**

HDD initialization error.

### **Hard Disk(s) fail (10)**

Unable to recalibrate fixed disk.

### **Hard Disk(s) fail (08)**

Sector Verify failed.

### **Keyboard is locked out - Unlock the key**

The BIOS detects that the keyboard is locked. Keyboard controller is pulled low.



### **Keyboard error or no keyboard present**

Cannot initialize the keyboard. Make sure the keyboard is attached correctly and no keys are being pressed during the boot.

### **Manufacturing POST loop**

System will repeat POST procedure infinitely while the keyboard controller is pull low. This is also used for the M/B burn in test at the factory.

### **BIOS ROM checksum error - System halted**

The checksum of ROM address F0000H-FFFFFFH is bad.

### **Memory test fail**

The BIOS reports memory test fail if the memory has error(s).

## **Driver Installation**

To install the IDE drivers supported by the 586ITB system board, please refer to the "Readme" file contained in the provided diskette for detail information.

All steps or procedures to install software drivers are subject to change without notice as the softwares are occasionally updated. Please refer to the readme files for the latest information.

### **Windows<sup>®</sup> 95 OS Installation**

If this is the first time for you to install Windows<sup>®</sup> 95 to your PC system with one of the the following versions: Win95, Win95+, Win95 OSR1 (Windows 95 OEM Service Release 1), Win95 OSR2 (Windows 95 OEM Service Release 2.0) and Win95 OSR2.1 (Windows 95 OEM Service Release 2.0 plus USB Supplement), please follow steps shown below to install.

1. Copy the Cab files of Win95 within Win95 CD to Win95 under Drive C first.
2. Go into Win95 under Drive C. (C:\windows>)
3. Type "Setup" and press "Enter" to start installing Win95.

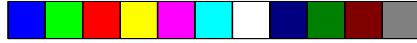
**Note:**

If you do not copy files of Win95 to Drive C first, CD-ROM will not be found while it installs to printer and the installation will be stopped. This is because the versions of Win95, Win95+, Win95 OSR1, Win95 OSR2 and Win95 OSR2.1 do not include some new hardware drivers within TX chipset.

**Solve Warning Messages with Windows 95 IDE**

If the version of Windows 95 under your IDE is one of the Win95 OSR2 or Win95 OSR2.1, there may be some warning messages appearing while you boot up your system. This problem occurs for Win95 has not recognized the TX chipset on the 586ITB board. To change files for Win95 by knowing TX chipset, you may need to change some files in Win95. Please follow setps shown below.

Version	Files
OSR2	1. MSHDC.INF 2. MACHINE.INF
OSR2.1	1. MSHDC.INF 2. MACHINE.INF 3. USB.INF

1. Insert the IDE driver into Drive A.
2. Enter Win95 MS-DOS prompt window.
3. Type "CD windows" and press "Enter". (C:\windows>)
4. Type "CD INF" and press "Enter". (C:\windows\INF>)
5. Change "MSHDC.INF", "MACHINE.INF" and "USB.INF" to "MSHDC.000", "MACHINE.000" and "USB.000".

```
Ex C:\windows\INF>copy MSHDC.INF MSHDC.000
C:\windows\INF>copy MACHINE.INF MACHINE.000
C:\windows\INF>copy USB.INF USB.000 (only Win95 OSR2.1)
```

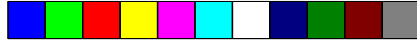

6. Go back to your prompt to A: and type "CD OSR2" or "CD OSR2.1" and press "Enter". Then copy "MSHDC.INF", "MACHINE.INF" and "USB.INF" within the diskette to Drive C.

```
Ex: A:\OSR2>copy MSHDC.INF C:  
A:\OSR2>copy MACHINE.INF C:  
A:\OSR2.1>copy USB.INF C: (only Win95 OSR2.1)
```

7. After finishing copy, click "Control Panel" under Setting of Start.
8. Choose "Device Manager" on the top of "System Properties" screen.
9. Choose "View devices by connection" and click on "Plug & Play BIOS".
10. Click on "PCI BUS" and choose "Remove" on the bottom of the screen, then click "OK".
11. Windows 95 will display messages when various hardware components in the system are recognized. When prompted to install a driver, select the "Windows Default driver" or appropriate device drivers from disk.
12. Select "Yes" to restart the system. (Steps 11 and 12 may occur several times.)



## Chapter 4 Troubleshooting Checklist

---

This chapter of the manual is designed to help you with problems that you may encounter with your personal computer. To efficiently troubleshoot your system, treat each problem individually. This is to ensure an accurate diagnosis of the problem in case a problem has multiple causes.

When you encounter problems while using your system first check that:

1. The power switch of each peripheral device is turned on.
2. All cables and power cords are tightly connected.
3. The electrical outlet to which your peripheral devices are connected is working. Test the outlet by plugging in a lamp or other electrical device.
4. The monitor is turned on.
5. The display's brightness and contrast controls are adjusted properly.
6. All add-in boards in the expansion slots are seated securely.
7. Any add-in board you have installed is designed for your system and is set up correctly.

### Monitor/Display

If the display screen remains dark after the system is turned on:

1. Make sure that the monitor's power switch is on.
2. Check that one end of the monitor's power cord is properly attached to the monitor and the other end is plugged into a working AC outlet. If necessary, try another outlet.
3. Check that the video input cable is properly attached to the monitor and the system's display adapter.
4. Adjust the brightness of the display by turning the monitor's brightness control knob.





### **Hard Drive**

Hard disk failure.

1. Make sure the correct drive type for the hard disk drive has been entered in the BIOS.
2. If the system is configured with two hard drives, make sure the bootable (first) hard drive is configured as Master and the second hard drive is configured as Slave.

Excessively long formatting period.

1. If your hard drive takes an excessively long period of time to format, it is likely a cable connection problem.

### **Parallel Port**

The parallel printer doesn't respond when you try to print.

1. Make sure that your printer is turned on and that the printer is on-line.
2. Make sure your software is configured for the right type of printer attached.
3. Verify that the onboard LPT port's I/O address and IRQ settings are configured correctly.
4. Verify that the attached device works by attaching it to a parallel port that is working and configured correctly. If it works, the printer can be assumed to be in good condition. If the printer remains inoperative, replace the printer cable and try again.

### **Serial Port**

The serial device (modem, printer) doesn't output anything or is outputting garbled characters.

1. Make sure that the serial device's power is turned on and that the device is on-line.
2. Verify that the device is plugged into the correct serial port on the rear of the computer.



3. Verify that the attached serial device works by attaching it to a serial port that is working and configured correctly. If the serial device does not work, either the cable or the serial device has a problem. If the serial device works, the problem may be due to the onboard I/O or the address setting.
4. Make sure the COM port settings and I/O address are configured correctly.

### **Keyboard**

Nothing happens when a key on the keyboard was pressed.

1. Make sure the keyboard is properly connected.
2. Make sure there are no objects resting on the keyboard and that no keys are pressed during the booting process.

### **System Board**

1. Make sure the add-in card is seated securely in the expansion slot. If the add-in card is loose, power off the system, re-install the card and power up the system.
2. Check the jumper settings to ensure that the jumpers are properly set.
3. Verify that all SIMMs are seated securely into the SIMM sockets.
4. Make sure the SIMMs are in the correct locations.
5. If the board fails to function, place the board on a flat surface and seat all socketed components. Gently press each component into the socket.
6. If you made changes to the BIOS settings, re-enter setup and load the BIOS defaults.



## Appendix A Types of Modules

The following modules have been tested with this board. Most untested brands will work but a few may fail to do so.

<b>DIMM</b>	<b>Brand</b>	<b>Chip Number</b>
1MBx64	Fujitsu	D4516161G5-7JF
1MBx64	NEC	D4516161G5-7JF
2MBx64	SEC	KM416S1120AT-G12
2MBx64	NEC	D4516821G5-A12-7F
2MBx64	Mitsubishi	M5M4V16S30CTP
4MBx64	SEC	KM44S4020AT-G12
4MBx64	SEC	KM44S4020AT-G10
4MBx64	NEC	D4516821G5-A12-7F

<b>SMM</b>	<b>Brand</b>	<b>Chip Number</b>
1MBx32/x36	Fujitsu	81C1000A-70
1MBx32	OKI	M51440A-70
2MBx32/x36	OKI	M511000B-70
2MBx32	NEC	424400-60
2MBx32	Micron	40447-60
2MBx32/x36	TI	TMS4400DJ-70
2MBx32	Micron	MT4C4007-70 (EDO)
2MBx32	Micron	MT4C4007-60 (EDO)
2MBx32	NEC	4218165-60 (EDO)
4MBx32/x36	Hitachi	7400AS-70
4MBx32/x36	Fujitsu	8117400-70



<b>SIMM</b>	<b>Brand</b>	<b>Chip Number</b>
4MBx32/x36	Mitsubishi	422A06-70
4MBx32/x36	Hitachi	5117400AS-70
4MBx32	NEC	4217400-60
4MBx32	NEC	4217405-70 (EDO)
8MBx32	NEC	4217405-60 (EDO)
16MBx32	LGS	71C16100AJ6





## Appendix B Memory and I/O Maps

---

### Memory Address Map

Address	Name	Function
0000000 to 009FFFF	640KB System Board RAM	System Board Memory
00A0000 to 00BFFFF	128KB Video Display Memory	Reserved for Graphics Display Memory
00C0000 to 00E7FFF	160KB I/O Expansion ROM	Reserved for ROM on I/O Adapter Card
00E8000 to 00FFFFFF	96KB ROM on the System Board	System Board BIOS
0100000 to 7FFFFFFF	Maximum Memory 128MB	System Board Memory



## I/O Address Map

I/O Address	Function
0000-001F	DMA Controller 1, 8237A-5
0020-003F	Interrupt Controller 1, 8259A, Master
0040-005F	Timer, 8254-2
0060-006F	8742 (Keyboard Controller)
0070-007F	Real-time Clock, NMI (Non-maskable Interrupt) Mask
0080-009F	DMA Page Memory, 74LS612
00A0-00BF	Interrupt Controller 2, 8259A
00C0-00DF	DMA Controller 2, 8237A-5
00E8	Shadow RAM and Cache Control Bit
00F0	Clear Numeric Processor Extension Busy
00F1	Reset Numeric Processor Extension
00F8-00FF	Numeric Processor Extension
01F0-01F8	Fixed Disk
0200-0207	Game I/O
0278-027F	Parallel Printer Port 2
02F8-02FF	Serial Port 2
0300-031F	Prototype Card
0360-036F	Reserved
0378-037F	Parallel Printer Port 1
0380-038F	SDLC, Bisynchronous 2
03A0-03AF	Bisynchronous 1
03B0-03BF	Monochrome Display and Printer Adapter
03C0-03CF	Reserved
03D0-03DF	Color/Graphics Monitor Adapter
03F0-03F7	Diskette Controller
03F8-03FF	Serial Port 1

**Note:**

The I/O address hex 0000 to 00FF are reserved for the system board I/O. Hex 0100 to 03FF are available on the I/O channels.



## Appendix C Connectors

### Connectors

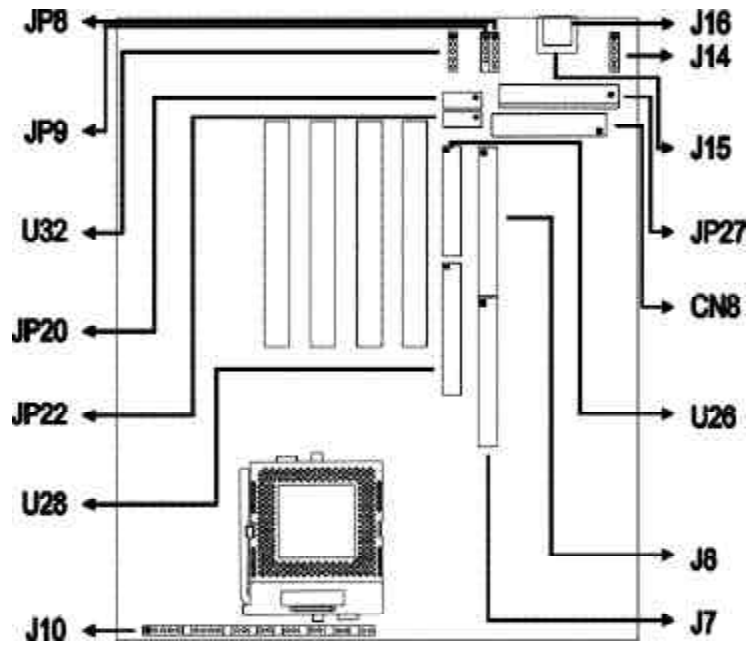

JP8	USB 1 connector
JP9	USB 2 connector
JP20	COM 1 serial port
JP22	COM 2 serial port
JP27	AT power connector
CN8	ATX power connector
U26	Parallel printer port
U28	Floppy disk drive connector
U32	IrDA connector
J7	Primary IDE hard disk drive connector
J8	Secondary IDE hard disk drive connector

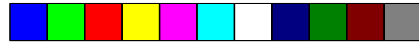

J14	PS/2 mouse port
J15	AT keyboard port
J16	PS/2 keyboard port
J10	keyboard lock connector
	Speaker connector
	Reset switch connector
	SMI switch connector
	Power switch connector
	Green LED connector
	HDD LED connector
	ATX LED connector







## Pin Assignments

### JP8 - USB 1 connector

Pin	Function
1	+5V
2	-Data
3	+Data
4	Ground
5	Ground

### JP9 - USB 2 connector

Pin	Function
1	+5V
2	-Data
3	+Data
4	Ground
5	Key

### J14 - PS/2 mouse port

Pin	Function
1	Mouse Data
2	N. C.
3	Ground
4	+5V
5	Mouse Clock

### U32 - IrDA connector

Pin	Function
1	IrTX
2	Ground
3	IrRXL
4	N.C.
5	+5V

### CN8 - ATX power connector

Pin	Function	Pin	Function
1	N. C.	11	N. C.
2	N. C.	12	-12V
3	Ground	13	Ground
4	+5V	14	PS-ON
5	Ground	15	Ground
6	+5V	16	Ground
7	Ground	17	Ground
8	PW-OK	18	-5V
9	5VSB	19	+5V
10	+12V	20	+5V