

486SH

VL-Bus System Board

USER'S MANUAL

Revision 3.1

!!! WARNING !!!

Be careful while installing VESA Local Bus cards on to your system board. Keep the following tips in mind to properly install and remove a VESA Local Bus card.

1. Always install/remove the card vertically straight down/up. **Never at an angle!** Inserting the card at an angle may damage the pins in both the AT and VESA Local Bus slots.
2. To install the board vertically, hold the card in the middle. Make sure that the card is even with both slots. Then gently fit the card into the slots with equal pressure at both ends.

Manufacturer warranty does not cover damage caused to the system board by improper installation or removal of VESA Local Bus cards.

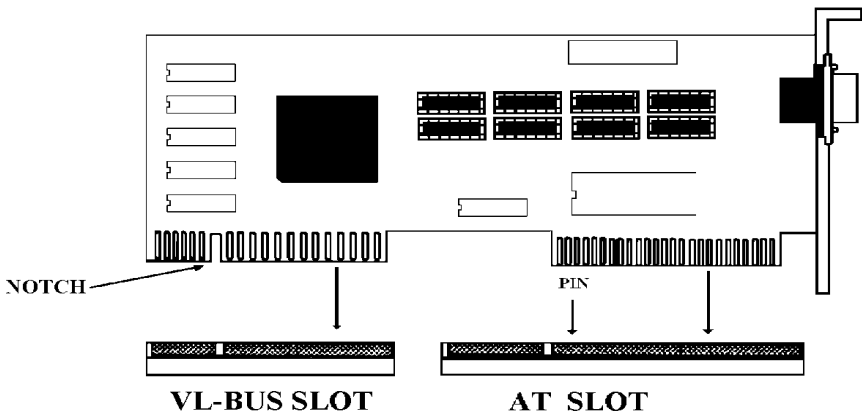

486SH BIOS V3.2 QUICK REFERENCE

I. STANDARD CMOS SETUP

Date:	Current date
Time:	Current time
Hard Disk Master C: Type:	Hard disk parameters
Hard Disk Slave D: Type:	Hard disk parameters
Floppy Drive A:	Type of floppy drive installed
Floppy Drive B:	Type of floppy drive installed

II. ADVANCED CMOS SETUP

Primary Display:	VGA/EGA
Parity Error Check:	Enabled
System Boot Up NumLock:	On
System Boot-Up Sequence:	C:, A:
Password Checking Option:	Setup
Video ROM Shadow C000, 32K:	Enabled
Adapter ROM Shadow C800, 32K:	Disabled
Adapter ROM Shadow D000, 32K:	Disabled
Adapter ROM Shadow D800, 32K:	Disabled
Adapter ROM Shadow E000, 32K:	Disabled
Adapter ROM Shadow E800, 32K:	Disabled
Internal Cache Memory:	Enabled
External Cache Memory:	Enabled
Video ROM Cache C000, 32K:	Enabled
System ROM Cache F000, 64K:	Disabled
Non-Cacheable Area Size # 1:	Disabled
IDE Block Mode:	Disabled
Primary Master IDE LBA Mode:	Disabled
Primary Slave IDE LBA Mode:	Disabled
Secondary IDE Device Preset:	None

III. ADVANCED CHIPSET SETUP

System Auto Configuration: Disabled

EXTERNAL CPU	25 MHz	33 MHz	40 MHz	50 MHz
ISA Bus Clock	7.15 MHz or CLK/3	7.15 MHz or CLK/4	7.15 MHz or CLK/5	7.15 MHz or CLK/6
System DRAM Timing	Fastest	Fast	Medium	Slow
DRAM Write Pulse Time	1T	1T	2T	2T

DRAM Write Wait State	0 W/S	1 W/S	1 W/S	1 W/S
Cache Burst Read Cycle	1T	2T	2T	2T
Cache Write Cycle	2T	3T	3T	3T

PREFACE

Thank you for purchasing the 486SH system board. This document gives an aid to the configuration and installation of this system board.

The information in this document is subject to change without notice.

This document contains information protected by copyright. All rights are reserved. No part of this document may be used or reproduced in any forms or by any means, or stored in a database or retrieval system, without prior written permission.

TRADEMARKS

Intel is a registered trademark of Intel Corporation.

IBM is a registered trademark of International Business Machines Corporation.

Microsoft is a registered trademark of Microsoft Corporation.

VESA is a registered trademark of Video Electronics Standard Association.

All other trademarks used in this manual are the property of their respective owners.

TABLE OF CONTENTS

	Page No.
486SH QUICK REFERENCE.....	
I. STANDARD CMOS SETUP.....	
II. ADVANCED CMOS SETUP.....	
III. ADVANCED CHIPSET SETUP.....	
CHAPTER 1: INTRODUCTION.....	
CHAPTER 2: JUMPERS & CONNECTORS.....	
SYSTEM BOARD JUMPERS.....	
<i>CPU Type Jumpers.....</i>	
<i>CPU External Clock Jumpers.....</i>	
<i>Cache Size Selection Jumpers.....</i>	
<i>Clear CMOS Data Jumper.....</i>	
<i>Display Type Jumper.....</i>	
SYSTEM BOARD CONNECTORS.....	
<i>Power Supply Connectors.....</i>	
<i>Keyboard Connector.....</i>	
<i>Power LED and Keyboard Lock Connector.....</i>	
<i>Speaker Connector.....</i>	
<i>Reset Connector.....</i>	
<i>Turbo Switch Connector.....</i>	
<i>Turbo LED Connector.....</i>	
CHAPTER 3: HARDWARE INSTALLATION.....	
CPU INSTALLATION.....	
INSTALLING DRAM SIMMs.....	
INSTALLING A VL-BUS CARD.....	
EQUIPMENT REQUIRED.....	
CHAPTER 4: BIOS SETUP.....	
ENTERING SETUP.....	
SETUP WINDOW.....	
<i>Standard CMOS Setup.....</i>	
<i>Advanced CMOS Setup.....</i>	
<i>Advanced Chipset Setup.....</i>	
<i>Power Management Setup.....</i>	
UTILITY WINDOW.....	
SECURITY SETUP WINDOW.....	
DEFAULT SETUP WINDOW.....	

APPENDIX A: KEYBOARD HOT KEYS.....

APPENDIX B: AMI BIOS HARD DISK TYPE.....

APPENDIX C: MEMORY MAPPING.....

APPENDIX D: AT I/O ADDRESS MAP.....

APPENDIX E: INTERRUPT ASSIGNMENTS.....

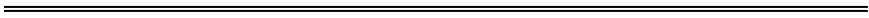

CHAPTER 1: INTRODUCTION

The 486SH system board adds to our 486 product line high integration and cost effective solution without compromising performance and quality. With top speed at 50 MHz and integrated 512K/256K/128K Write-Back cache, the 486SH dramatically boosts system throughput for even the most demanding applications. The 486SH offers features and functionality exceeding any other system board in its class, including:

PROCESSOR	237-pin ZIF SOCKET 3 for : 3.3-Volt 486DX4 5.0-Volt 486DX2, 486DX, 486SX, 487SX, P24T
BUS SLOTS	Three Bus Master VL-Bus slots Six 16-bit ISA slots One 8-bit ISA slot
CACHE MEMORY	512KB, 256KB, or 128KB Write Back cache.
SYSTEM MEMORY	Four 72-pin SIMM sockets support up to 128MB. Support 512Kx36, 1Mx36, 2Mx36, 4Mx36, 8Mx36, 16Mx36 modules. 70ns or faster DRAM speeds.
CHIPSET	SIS 85C471 Sophisticated System Power Management. Supports Level 1 Write-Back CPU.
BIOS	AMI BIOS.
BOARD SIZE	2/3 Baby AT 4 layers PCB

CHAPTER 2: JUMPERS & CONNECTORS



When working with the 486SH, it is extremely important that you avoid static electricity. Always ground yourself by wearing a wrist or ankle strap.

Figures 1 on the next page shows the component layout of the 486SH system board with locations of the system board jumpers and connectors. Note that most jumpers and connectors on the system board are labeled with proper names with pin 1 marked as "1". To avoid damaging the board and to have proper operation caution should be taken when connecting these components.

SYSTEM BOARD JUMPERS

Jumpers are used to select between various operating modes. A jumper switch consists of two, three, or four gold pins projecting from the system board. Placing the plastic jumper cap over two pins connects those pins and makes a particular selection. Using the cap to cover two pins in this way is referred to as shorting those pins. If the cap is not placed on any pins at all, this is referred to as leaving the pins open.

Note: When you open a jumper, leave the plastic jumper cap attached to one of the pins so you don't lose it.



OPEN

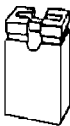

SHORTED

2-pin jumper

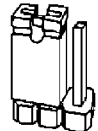
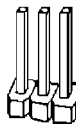

PINS 1-2
SHORTED

3-pin jumper

FIGURE 1: 486SH Component Layout

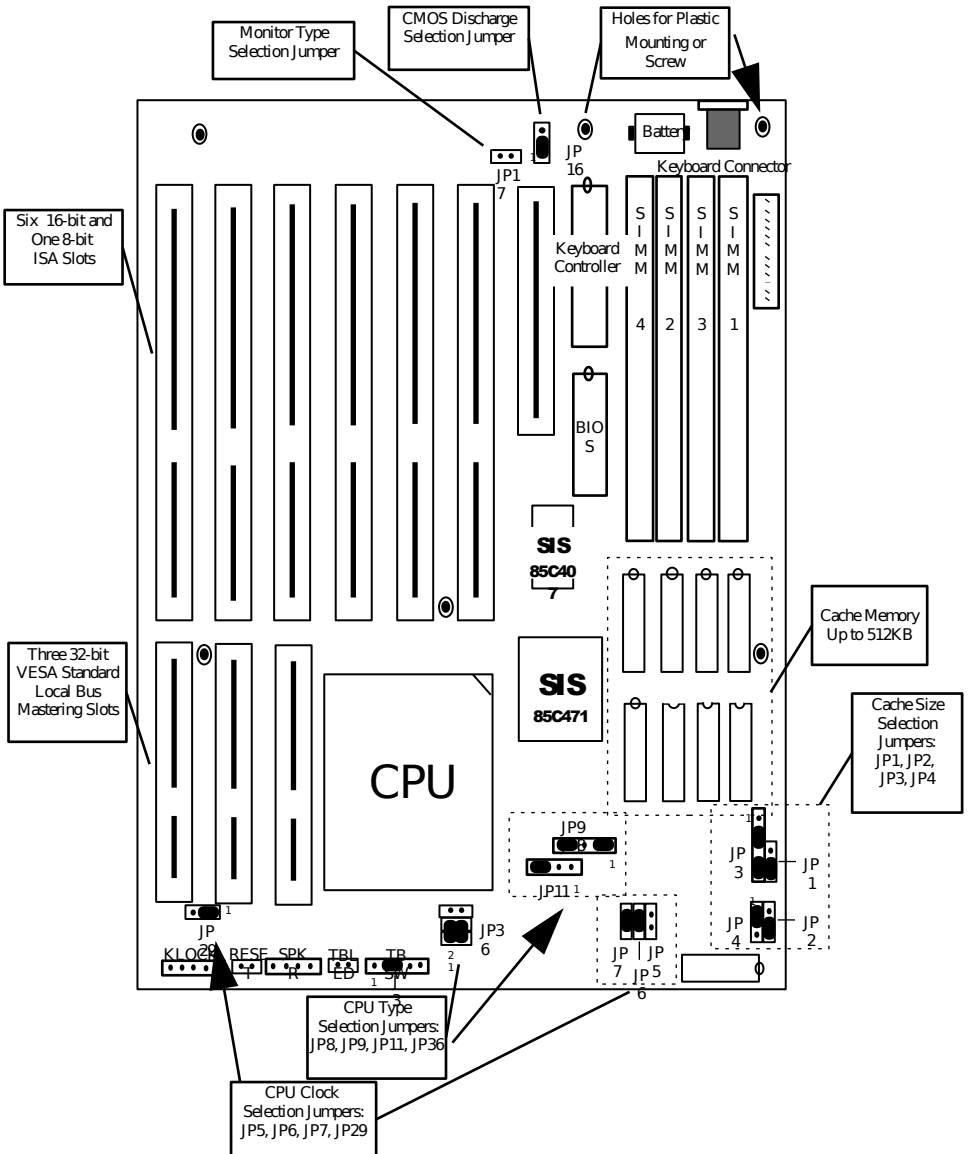

The above figure is set base on the jumper setup of 486-33MHz/256KB Cache size. Other Configuration please refer to the following pages for correct setting.

CPU Type Jumpers

CPU Type	JP8	JP9	JP1 1	JP36	JP30
486DX2, 486DX	1-2	ON	3-4	1-3, 2-4	OFF
AMD 486DX2, 486DX4 3.3V	1-2	ON	3-4	3-5, 4-6	OFF
486SX	2-3	OFF	OFF	1-3, 2-4	OFF
487SX, ODP486SX, P24T	1-2	ON	2-3	1-3, 2-4	OFF
AMD 486DX4 3.3V	1-2	ON	3-4	3-5, 4-6	ON

Care should be taken when installing the CPU into the Pin Grid Array (PGA) socket on the system board. Make certain that pin 1 of the CPU chip is correctly aligned with pin 1 of CPU socket. ZIF socket and CPU are shown in hardware installation section

CPU External Clock Jumpers

If you are installing an i486DX or i486SX, the internal CPU clock speed is the same as the external CPU clock speed. This is different for i486DX2 CPU where the external speed is one-half of the internal speed. For example, a 486DX2-66 has an external clock speed of 33mhz.

External Clock Speed	JP5	JP6	JP7	JP29
25 MHz	ON	ON	OFF	1-2
33 MHz	OFF	ON	ON	1-2
40 MHz	ON	OFF	OFF	2-3
50 MHz	OFF	OFF	ON	2-3

Cache Size Selection Jumpers

The system board supports 128KB/ 256KB/ 512KB of cache memory. Following table shows jumper details.

Cache Size	JP1	JP2	JP3	JP4	JP33
128KB	1-2	1-2	1-2, 3-4	1-2	2-3
256KB	2-3	2-3	2-3, 4-5	1-2	2-3
***256KB	1-2	2-3	1-2,3-4	1-2	1-2
512KB	1-2	2-3	1-2, 3-4	2-3	2-3

Cache Size and SRAM Locations

Cache Size	Tag RAM U11	Data Bank 0 U1,U2,U3,U4	Data Bank 1 U5,U6,U7,U8
128KB	32Kx8	32Kx8	None
256KB	32Kx8	32Kx8	32Kx8
***256KB	32Kx8	64Kx8	None
512KB	32Kx8	128Kx8	None

Clear CMOS Data Jumper

The CMOS jumper JP16 is used to clear the system configuration data currently stored in the CMOS RAM. All system setup information (hard disk type, date/time, etc.), stored in the CMOS, will be destroyed. This function would be useful if you were to forget the user password for the system.

Function	JP16
Normal CMOS Operation	1-2 (Default)
Clear CMOS Data	2-3

Follow these steps to clear CMOS data:

1. Turn power OFF.
2. Open the system cover and gain access to jumper JP16.
3. Change jumper JP16 to 2-3 position for few seconds then move the jumper block back to 1-2 position again.
4. Replace and secure the system cover.
5. Turn power ON, CMOS data should be cleared.

Display Type Jumper

Display Type	JP17
Video display is VGA, EGA, or Monochrome.	OFF (Default)
Video display is CGA.	ON

SYSTEM BOARD CONNECTORS

Power Supply Connectors

The two Power Supply connectors are 6-pin AT standard power connectors. Most power supplies have two six-wire connectors, two of the wires on each connector are black. Align the two six-wire connectors so that the two black wires on each connector are in the middle as shown below.

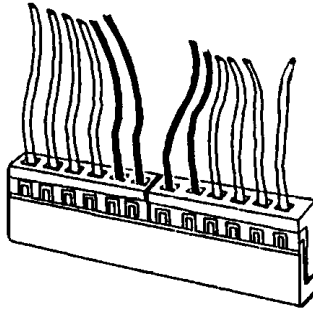

Pin	CN2A	CN2B
1	Power Good	Ground
2	+5 VDC	Ground
3	+12 VDC	-5 VDC
4	-12 VDC	+5 VDC
5	Ground	+5 VDC
6	Ground	+5 VDC

Keyboard Connector

The keyboard connector is a 5-pin, circular-type DIN socket. It is used to connect the system board keyboard interface to any standard AT-compatible keyboard (84 or 101 -key type keyboards). The pin assignments are listed below:

Pin	Description
1	Keyboard Clock Signal
2	Keyboard Data Signal
3	Not Used
4	Ground

5	+5V Fused VDC
---	---------------

Power LED and Keyboard Lock Connector

The Power LED and Keyboard Lock connector (KEYLOCK) is 5-pin keyed BERG strip. It is used to connect +5 VDC power to the power indicator LED at the front panel and connect security keyboard lock to the keyboard controller. So provides limited security against casual intruders. The pin assignments are indicated below:

Pin	Description
1	LED Power
2	Key (No Connection)
3	Ground
4	Keyboard Lock
5	Ground

Speaker Connector

The Speaker connector (SPEAKER) is a 4-pin keyed BERG strip. It is used to connect an external 2-inch, 8-ohm speaker to the system board to provide sound capability. The pin assignments are defined below:

Pin	Description
1	Speaker Data Out
2	Key (No Connection)
3	Ground
4	+5 VDC

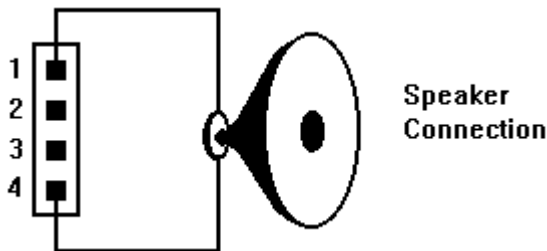

Reset Connector

The system RESET connector (RESET) is a 2-pin BERG strip. It is used to connect the push button reset switch located on the front panel to the system board. System reset can be done by shorting pin 1 to pin 2 with the same effect as turning the power off and then on again.

Pin	Description
1	Reset Input
2	Ground

Turbo Switch Connector

The Turbo switch (TB SW) is a 3-pin BERG strip. It is used to connect the front panel 2-position push switch to the system board speed switching circuitry. In Turbo speed, the cache memory is enabled and full speed of 32-bit memory transfer is utilized. In non-turbo speed, the cache memory is disabled. In both speeds, the ISA expansion bus timing compatibility is still preserved.

J3	Description
2-3	Turbo Speed
1-2	Disable Turbo Speed

Turbo LED Connector

The Turbo LED connector, marked as "TB LED", is a 2-pin BERG strip. It is used to connect a CPU operating frequency indicator LED from the front panel to the system board. The pin assignments are indicated below:

Pin	Description
1	LED Cathode
2	LED Anode

CHAPTER 3: HARDWARE INSTALLATION

CPU INSTALLATION

Care should be taken when installing the CPU into the Pin Grid Array (PGA) socket on the system board. Make certain that pin 1 of the CPU chip is correctly aligned with pin 1 of CPU socket. ZIF socket and CPU are shown below.

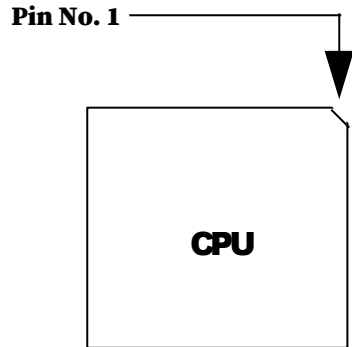
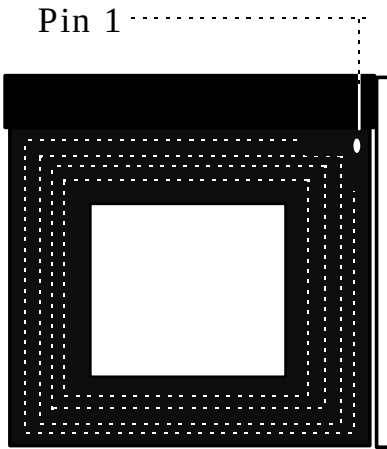

INSTALLING DRAM SIMMs



When working with DRAM SIMMs, it is extremely important that you avoid static electricity. Always ground yourself by wearing a wrist or ankle strap.

1. The SIMM module should face to the right with pin 72 next to the power supply connectors.
2. Insert the SIMM at a 45 degree angle, tilted towards ISA slots.
3. Gently push the SIMM to an upright position until it "snaps" into place.
4. Repeat above steps until the entire bank is filled.

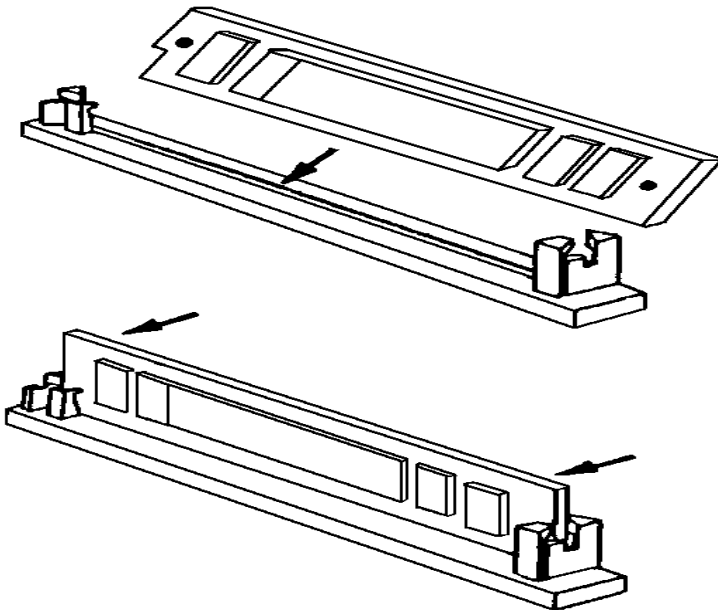

The on-board DRAM memory subsystem has four module mounting sockets which are divided into "banks" of one socket each. They support 512Kx36, 1Mx36, 2Mx36, 4Mx36, 8Mx36, and 16Mx36 DRAM SIMMs.

These banks are labeled SIM1, SIM2, SIM3, and SIM4. DRAM speed must be 70ns or 60ns. You can configure the memory of the 486SH in a variety of ways. The chart below shows the possible combinations.

Total Memory	SIMM1	SIMM2	SIMM3	SIMM4
2MB	512Kx36			
4MB	512Kx36	512Kx36		
6MB	512Kx36	1Mx36		
8MB	512Kx36	512Kx36	1Mx36	
12MB	512Kx36	512Kx36	1Mx36	1Mx36
18 MB	512Kx36	4Mx36		
20 MB	512Kx36	512Kx36	4Mx36	
24 MB	512Kx36	512Kx36	1Mx36	4Mx36
36 MB	512Kx36	512Kx36	4Mx36	4Mx36
4 MB	1Mx36			
8 MB	1Mx36	1Mx36		
12 MB	1Mx36	1Mx36	1Mx36	
16 MB	1Mx36	1Mx36	1Mx36	1Mx36
20 MB	1Mx36	4Mx36		
24 MB	1Mx36	1Mx36	4Mx36	
36 MB	1Mx36	4Mx36	4Mx36	
40 MB	1Mx36	1Mx36	4Mx36	4Mx36
8 MB	2Mx36			
16 MB	2Mx36	2Mx36		
24 MB	2Mx36	2Mx36	2Mx36	
32 MB	2Mx36	2Mx36	2Mx36	2Mx36
16 MB	4Mx36			
32 MB	4Mx36	4Mx36		
48 MB	4Mx36	4Mx36	4Mx36	
64 MB	4Mx36	4Mx36	4Mx36	4Mx36
68 MB	1Mx36	16Mx36		
72 MB	1Mx36	1Mx36	16Mx36	
80 MB	4Mx36	16Mx36		
96 MB	4Mx36	4Mx36	16Mx36	
64 MB	16Mx36			
128 MB	16Mx36	16Mx36		
36 MB	1Mx36	8Mx36		
68 MB	1Mx36	8Mx36	8Mx36	
40 MB	1Mx36	1Mx36	8Mx36	
72 MB	1Mx36	1Mx36	8Mx36	8Mx36
48 MB	4Mx36	8Mx36		
80 MB	4Mx36	8Mx36	8Mx36	
64 MB	4Mx36	4Mx36	8Mx36	
96 MB	4Mx36	4Mx36	8Mx36	8Mx36
32 MB	8Mx36			
64 MB	8Mx36	8Mx36		
96 MB	8Mx36	8Mx36	8Mx36	
128 MB	8Mx36	8Mx36	8Mx36	8Mx36

INSTALLING A VL-BUS CARD

Carefully follow these steps to install a VL-Bus card:

1. Turn off your computer and unplug the power cord.
2. Turn off the power to all peripheral devices, such as your printer.
3. Disconnect the cables from the back of the system in order to give more room to work. Note how all cables are connected prior to disconnection.
4. Remove the computer's cover.
5. Choose an unused VL-Bus slot.
6. Setting the VL-Bus card according to its user's manual.
7. Holding the card at the center of the top edge, gently push straight down with equal pressure at both ends.
8. Replace the screw to hold the card into place.
9. Replace and secure the system cover.
10. Reconnect all the wires and cables.

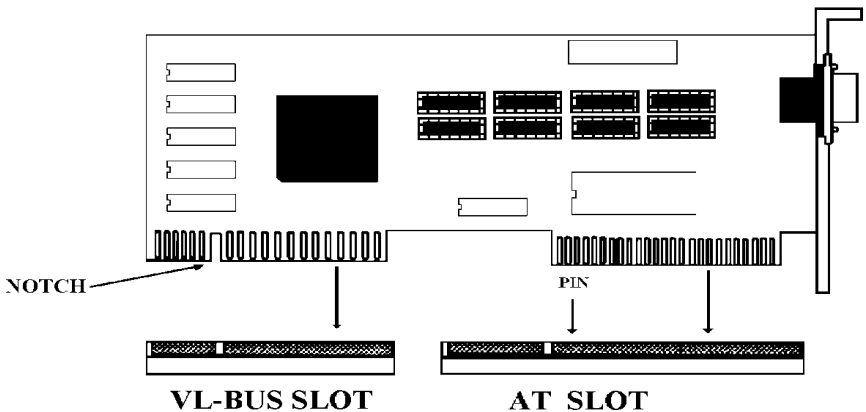

EQUIPMENT REQUIRED

The dimension of the 486SH system board is designed to fit perfectly in a PC/XT (or PC/AT) standard case. To build a complete high performance system based on the 486SH system board, the following equipment are needed:

- A chassis with dimension similar to PC/XT/AT standard chassis.
- A standard AT 220W power supply which is capable to provide a continuous power within a +4.85 VDC to +5.25 VDC range. A power line filter may be needed for areas with noisy transmission.
- A 2-inch, 8-Ohm speaker to provide sound capability.
- A 2-position switch with a 2-pin connector for speed function.
- A push button switch with 2-pin connector for reset function.
- One floppy drive (360K or 1.2M or 1.44M) with cable.
- Hard disk drive with cable
- A set of flat cables for floppy drive and hard disk drive.
- An AT-compatible keyboard (84 or 101 Keyboard) with cable.
- A video display monitor.

Following additional equipment will be useful to enhance the system:

- A bus or serial mouse.
- A tape pack up drive.
- A CD-ROM Drive.

CHAPTER 4: BIOS SETUP

You need to setup a system once every time:

- You start a new and unconfigured system.
- You receive a start-up error message indicating the configuration information stored in the non-volatile CMOS RAM has somehow become corrupted.
- You add, remove or change peripherals from your system.

The first time you power up the system, the configuration information stored in the battery-backed CMOS RAM may not be correct. The BIOS detects this condition and prompts user to go through the SETUP section. This chapter explains how to use the BIOS SETUP program and make the appropriate entries.



Some of the parameters are already factory preset and do not need to be changed. Please read the instructions carefully and only change the settings if necessary.

ENTERING SETUP

1. Reset the system by turning it OFF then ON or pushing the "RESET" button on the system front panel.
2. Hit the **** key momentarily as soon as the following message appears:

"Hit , if you want to run SETUP"

3. After you press the **** key, the following BIOS Setup windows appear:

SETUP WINDOW

Types of Setup	Description
Standard Setup	Set time date, hard disk type, types of floppy drives, display type, and if Keyboard is installed.
Advanced CMOS Setup	Set Typematic Rate, Above 1 MB Memory Test, Memory Test Tick Sound, System Boot Up Sequence, and many others.
Advanced Chipset Setup	Set chipset-specific options and features.
Power Management Setup	Control power conservation options.

Setup : Standard, Advanced CMOS, Advanced Chipset, and Power Management.

Utilities : Detect Master C:, Detect Slave D:, and Color Set.

Security : Password and Anti-Virus.

Default : Original, Optimal, and Fail-Safe settings.

Standard CMOS Setup

Use the standard CMOS Setup screen to check or modify general configuration information such as the date, time, floppy type, hard disk type, video type, etc.

- **Date** (Month/Date/Year): You manually set the electronic calendar only if the values are incorrect.
- **Time** (Hour/Minute/Second): The time here is 24-hour time. You would enter 5:30 P.M. as 17:30:00.
- **Hard Disk Master C:, Slave D: Type**: The BIOS provides 46 pre-defined types of popular hard disk drives. Relevant specifications include the number of cylinders and heads, write pre-compensation time, read/write head landing zone, number of sectors per track. A hard disk will not work properly if your enter incorrect drive parameters.

If your particular drive is not one of the 46 pre-defined types, simply scroll down to select type 47 and enter the appropriate values for **cylinders**, **heads**, **WPcom**, **LZone**, and **sectors**. **Size** is automatically determined by the other entries. You can also let the BIOS to determine the drive type by selecting "**AUTO DETECT HARD DISK**" from the Main Menu.

Parameter	Description
Type	The number for a drive with certain identification parameters.
Cylinders	The number of cylinders in the disk drive.
Heads	The number of heads.
Write Precompensation	The size of a sector gets progressively smaller as the track diameter diminishes. Yet each sector must still hold 512 bytes. Write precompensation circuitry on the hard disk compensates for the physical difference in sector size by boosting the write current for sectors on inner tracks. This parameter is the track number where write precompensation begins.
Landing Zone	This number is the cylinder location where the heads will normally park when the system is shut down.
Sectors	The number of sectors per track. MFM drives have 17 sectors per track. RLL drives have 26 sectors per track. ESDI drives have 34 sectors per track. SCSI and IDE drive may have even more sectors per track.
Capacity	The formatted capacity of the drive is (Number Of heads) x (Number of cylinders) x (Number of sectors per track) x (512 bytes per sector)

- **Floppy Drive A: Type** (360KB, 720KB, 1.2MB, 1.44MB, 2.88MB, or Not Installed): Specify the type of the first floppy drive installed on the system. "Not Installed" could be used as an option for diskless workstations.
- **Floppy Drive B: Type**: Specify the type of the second floppy drive installed on the system.

Advanced CMOS Setup

"ADVANCED CMOS SETUP" lists some system features that allows you to fine tune your system setup.

- **Primary Display Monitor** (Absent, VGA/EGA, CGA 40x25, CGA 80x25, Monochrome): The "Absent" option could be used for network file servers.
- **System Boot Up NumLock**: When the computer boots, it selects the numeric values rather than the cursor control functions on the numeric keypad of IBM compatible keyboards. Most extended compatible keyboards have separate cursor control keys. It is therefore unnecessary to use the numeric keypad for this. The default setting is "On".
- **System Boot-Up Sequence**: If "A:, C:" (default), the BIOS will look for bootable operating system files from floppy drive A: first before looking for them in drive C:. You can reverse this sequence by selecting "C:, A:".
- **Password Checking Option**: Choose "Setup" or "Always". default setting is "Setup". The password feature can be used to prevent unauthorized system boot-up or unauthorized use of BIOS SETUP.

"Always" Each time the system is turned on, the pass word prompt appears.

"Setup" If there is a password set, the Password prompt only appears if you attempt to enter the BIOS Setup program. If there is no set password, the Password Checking Option is disabled. You create a password by using "PASSWORD" option in the SECURITY WINDOW.
- **Video ROM Shadow C000, 32K**: Shadowing helps to speed up BIOS access by copying BIOS code to fast 32-bit RAM area and executes it from there. The default setting is "Enabled".
- **Adapter ROM Shadow**: Default setting is "Disabled". If you have other expansion cards with ROMs on them such as SCSI controller, you will need to know which addresses the ROMs use.
- **Internal Cache Memory**: Select "Enabled" to enable the cache memory inside the CPU chip.

- **External Cache Memory:** Select "Enabled" to enable external on-board cache memory.
- **Non-Cacheable Area #1:** Only select "Base" if there is non-system memory located on certain adapters.
- **IDE Block Mode:** Some latest IDE hard disks support multiple sector (Block Mode) transfer for faster performance. Users select "Enabled" to take advantage of this feature. If your system hard disk supports Block Mode, BIOS message "Block Mode Enabled" will appear during boot-up.
- **Primary Master & Slave IDE LBA Mode:** Select "One" for IDE hard disk that supports LBA mode for larger than 512KB capacity.
- **Secondary Master & Slave IDE LBA Drives Preset:** Select "One" for IDE hard disk that supports LBA mode for larger than 512KB capacity.

Advanced Chipset Setup

- **System Auto Configuration:** If "Enabled", BIOS will automatically detect system speed and set below system parameters properly.

EXTERNAL CLOCK	CPU	25 MHz	33 MHz	40 MHz	50 MHz
Bus frequency		7.15 MHz or CLK/3	7.15 MHz or CLK/4	7.15 MHz or CLK/5	7.15 MHz or CLK/6
System Timing	DRAM	Fastest	Fast	Medium	Slow
DRAM Write Pulse Time		1T	1T	2T	2T
DRAM Write State	Wait	0 W/S	1 W/S	1 W/S	1 W/S
Cache Burst Cycle	Read	1T	2T	2T	2T
Cache Write Cycle		2T	3T	3T	3T

Power Management Setup

The Power Management Setup provides a programming way to slow down/stop CPU clock speed and put other system devices such as Video Monitor into power saving mode.

- **Green PC Mode:** If "Disabled", all the power management events and timers setup will be ignored.
- **Display Type Support:** Only select "Green PC" for monitor that supports Power Management Mode. Otherwise, select "Standard".
- **IDE Power Down Timeout:** Select hours, minutes, and seconds.
- **Green PC Mode Time - Out:** "Disable".
- **SYSTEM MONITOR EVENTS:** This is the system events or activities monitoring.

Video ROM Access

Video RAM Access

Local Bus Device Access

Local Bus Master Access

DMA Request

- **SYSTEM IRQ MONITOR EVENTS:** This is the system interrupt request (IRQ) events or activities monitoring. If the power management is enabled, the system will go into power saving mode after all the events have been idle for a pre-defined time shown on the system power down timer. Any detected event will wake up the system immediately and the timer is reset to zero. Each of these events can be controlled (enabled or disabled) individually.

IRQ 1, KB Activities	Monitoring the Keyboard pressing activities
IRQ3, COM2/4 Activities	Monitoring the Serial port activities
IRQ4, COM1/3 Activities	Monitoring the Serial port activities
IRQ5, LPT2 Activities	Monitoring the Parallel port activities
IRQ6, Floppy Activities	Monitoring the Floppy port activities
IRQ7, LPT1/3 Activities	Monitoring the Parallel port activities
IRQ8, RTC Activities	Monitoring the Real-Time-Clock port activities
IRQ9 Activities	Monitoring adapter activities.
IRQ10 Activities	Monitoring adapter activities.
IRQ11 Activities	Monitoring adapter activities.
IRQ12 Activities	Monitoring adapter activities.
IRQ14, HDD Activities	Monitoring the IDE hard disk activities
IRQ15 Activities	Monitoring adapter activities.

UTILITY WINDOW

Detect Master C

This utility detects parameters for IDE drive hardware configured as first drive (master) in dual drive system or the only drive in system. It is not guaranteed that this utility will work with all IDE hard disk. There is no need to use this utility if you already have hard disk type information.

Detect Slave D

This utility detects parameters for IDE drive hardware configured as second drive (slave) in dual drive system. It is not guaranteed that this utility will work with all IDE hard disk. There is no need to use this utility if you already have hard disk type information.

Color Set

This utility allows to select color sets for AMIBIOS setup screens.

SECURITY SETUP WINDOW

Password

Allows to set password user will be asked to enter before entering into AMIBIOS setup

Anti-Virus

When virus protection is enabled system will warn every time any program tries to write boot sector.

DEFAULT SETUP WINDOW

The Default Setup windows has following options. Every option in BIOS Setup contains two default values: a Fail-Safe default and the Optimal default value.

Original Defaults

Restores old values of setup if user decides to abandon changes.

Optimal Defaults

The Optimal default values provide optimum performance settings for all devices and system features.

Fail-Safe Defaults

The Fail-Safe default settings consist of the safest set of parameters. Use them if the system is behaving erratically. They should always work but do not provide optimal system performance characteristics.

APPENDIX A: KEYBOARD HOT KEYS

SYSTEM SPEED

System speed can also be changed through keyboard. There are two available speeds as shown below:

Turbo speed: Cache memory and 32-bit DRAM transfer mode are ON. Set by pressing <+> key once while holding <Ctrl>, <Alt>, and <Shift> keys.

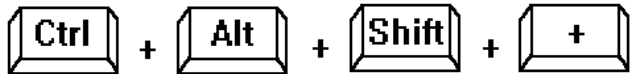

Slow speed: Cache memory and 32-bit DRAM transfer mode are OFF. Set by pressing <-> key once while holding <Ctrl>, <Alt>, and <Shift> keys.

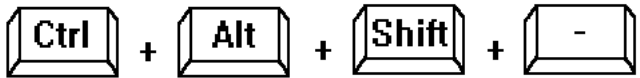

APPENDIX B: AMI BIOS HARD DISK TYPE

Type	Cylinder	Heads	Write Precomp	Landing Zone	Sectors	Size
1	306	4	128	305	17	10MB
2	615	4	300	615	17	20MB
3	615	6	300	615	17	31MB
4	940	8	512	940	17	62MB
5	940	6	512	940	17	47MB
6	615	4	65535	615	17	20MB
7	462	8	256	511	17	31MB
8	733	5	65535	733	17	30MB
9	900	15	65535	901	17	112MB
10	820	3	65535	820	17	20MB
11	855	5	65535	855	17	35MB
12	855	7	65535	855	17	50MB
13	306	8	128	319	17	20MB
14	733	7	65535	733	17	43MB
16	612	4	0	663	17	20MB
17	977	5	300	977	17	41MB
18	977	7	65535	977	17	57MB
19	1024	7	512	1023	17	60MB
20	733	5	300	732	17	30MB
21	733	7	300	732	17	43MB
22	733	5	300	733	17	30MB
23	306	4	0	336	17	10MB
24	925	7	0	925	17	54MB
25	925	9	65535	925	17	69MB
26	754	7	754	754	17	44MB
27	754	11	65535	754	17	69MB
28	699	7	256	699	17	41MB
29	823	10	65535	823	17	68MB
30	918	7	918	918	17	53MB
31	1024	11	65535	1024	17	94MB
32	1024	15	65535	1024	17	128MB
33	1024	5	1024	1024	17	43MB
34	612	2	128	612	17	10MB
35	1024	9	65535	1024	17	77MB
36	1024	8	512	1024	17	68MB
37	615	8	128	615	17	41MB
38	987	3	987	987	17	25MB
39	987	7	987	987	17	57MB
40	820	6	820	820	17	41MB
41	977	5	977	977	17	41MB
42	981	5	981	981	17	41MB
43	830	7	512	830	17	48MB
44	830	10	65535	830	17	69MB
45	917	15	65535	918	17	114MB
46	1224	15	65535	1223	17	152MB

APPENDIX C: MEMORY MAPPING

Address (hex)	Function	Comments
00000000-0007FFFF	512K System RAM	Cached
00080000-0009FFFF	128K System RAM	Cached
000A0000-000BFFFF	128K Video RAM	Not Cached
000C0000-000C7FFF	32K Video BIOS	Cached
000C8000-000CFFFF	32K I/O ROM	Not Cached
000D0000-000DFFFF	64K I/O ROM	Not Cached
000E0000-000EFFFF	64K Extended BIOS	Not Cached
000F0000-000FFFFF	64K On-Board BIOS ROM	Cached
00100000-00BFFFFF	System Memory (RAM)	Cached
00C00000-00FFFFFF	System Memory (RAM)	Not cached if memory mapped I/O board is used in this range
01000000-BFFFFFFF	System Memory (RAM)	Cached
C0000000-C1FFFFFF	System Memory (RAM)	Cached
C2000000-FFFDFFFF	System Memory	Cached
FFFE0000-FFFFFFF	128K On-Board BIOS ROM	Not cached

APPENDIX D: AT I/O ADDRESS MAP

I/O ADDRES S (HEX)	I/O DEVICE
000 - 01F	DMA Controller 1, 8237A-5
020 - 03F	Interrupt Controller 1, 8259A
040 - 05F	System Timer, 8254-2
060 - 06F	8742 Keyboard Controller
070 - 07F	Real-Time Clock/CMOS and NMI Mask
080 - 09F	DMA Page Register, 74LS612
0A0 - 0BF	Interrupt Controller 2, 8259A
0C0 - 0DF	DMA Controller 2, 8237A-5
0F0 - 0FF	CPU's Internal Math Coprocessor
1F0 - 1F8	Fixed Disk Drive Adapter
200 - 207	Game I/O
20C - 20D	Reserved
21F	Reserved
278 - 27F	Parallel Printer Port 2
2B0 - 2DF	Alternate Enhanced Graphic Adapter
2E1	GPIB Adapter 0
2E2 - 2E3	Data Acquisition Adapter 0
2F8 - 2FF	Serial Port 2 (RS-232-C)
300 - 31F	Prototype Card
360 - 363	PC Network (Low Address)
364 - 367	Reserved
368 - 36B	PC Network (High Address)
36C - 36F	Reserved
378 - 37F	Parallel Printer Port 1
380 - 38F	SDLC, Bisynchronous 2
390 - 393	Cluster
3A0 - 3AF	Bisynchronous 1
3B0 - 3BF	Monochrome Display and Printer Adapter
3C0 - 3CF	Enhanced Graphics Adapter
3D0 - 3DF	Color/Graphics Monitor Adapter
3F0 - 3F7	Diskette Drive Controller
3F8 - 3FF	Serial Port 1 (RS-232-C)
6E2 - 6E3	Data Acquisition Adapter 1
790 - 793	Cluster Adapter 1

AE2 - AE3	Data Acquisition Adapter 2
B90 - B93	Cluster Adapter 2
EE2 - EE3	Data Acquisition Adapter 3
1390 - 1393	Cluster Adapter 3
22E1	GPIB Adapter 1
2390 - 2393	Cluster Adapter 4
42E1	GPIB Adapter 2
62E1	GPIB Adapter 3
82E1	GPIB Adapter 4

APPENDIX E: INTERRUPT ASSIGNMENTS

LEVEL	TYPICAL INTERRUPT SOURCE
NMI	Parity, AT Channel Check
IRQ0	Interval Timer 1, Counter 0 Out
IRQ1	Keyboard Controller
IRQ2	Cascade Interrupts from IRQ8 to IRQ15
IRQ3	Serial Port 2
IRQ4	Serial Port 1
IRQ5	Parallel Port 2
IRQ6	Diskette Controller
IRQ7	Parallel Port 1
IRQ8	Real Time Clock
IRQ9	Expansion Bus Pin
IRQ10	Expansion Bus Pin
IRQ11	Expansion Bus Pin
IRQ12	Expansion Bus Pin
IRQ13	Coprocessor Error
IRQ14	Fixed Disk Drive Controller
IRQ15	Expansion Bus Pin