

PW65 Series

Rev. B+
System Board
User's Manual

Copyright

This publication contains information that is protected by copyright. No part of it may be reproduced in any form or by any means or used to make any transformation/adaptation without the prior written permission from the copyright holders.

This publication is provided for informational purposes only. The manufacturer makes no representations or warranties with respect to the contents or use of this manual and specifically disclaims any express or implied warranties of merchantability or fitness for any particular purpose. The user will assume the entire risk of the use or the results of the use of this document. Further, the manufacturer reserves the right to revise this publication and make changes to its contents at any time, without obligation to notify any person or entity of such revisions or changes.

© 1999. All Rights Reserved.

Trademarks

Microsoft® MS-DOS®, Windows™, Windows® 95 and Windows® 98 are registered trademarks of Microsoft Corporation. Intel®, Pentium® II, Pentium® III and Celeron™ are registered trademarks of Intel Corporation. Award is a registered trademark of Award Software, Inc. Other trademarks and registered trademarks of products appearing in this manual are the properties of their respective holders.

Caution:

Danger of explosion if battery incorrectly replaced.

Replace only with the same or equivalent type recommended by the manufacturer.

Dispose of used batteries according to the battery manufacturer's instructions.

FCC and DOC Statement on Class B

This equipment has been tested and found to comply with the limits for a Class B digital device, pursuant to Part 15 of the FCC rules. These limits are designed to provide reasonable protection against harmful interference when the equipment is operated in a residential installation. This equipment generates, uses and can radiate radio frequency energy and, if not installed and used in accordance with the instruction manual, may cause harmful interference to radio communications. However, there is no guarantee that interference will not occur in a particular installation. If this equipment does cause harmful interference to radio or television reception, which can be determined by turning the equipment off and on, the user is encouraged to try to correct the interference by one or more of the following measures:

- Reorient or relocate the receiving antenna.
- Increase the separation between the equipment and the receiver.
- Connect the equipment into an outlet on a circuit different from that to which the receiver is connected.
- Consult the dealer or an experienced radio TV technician for help.

Notice:

1. The changes or modifications not expressly approved by the party responsible for compliance could void the user's authority to operate the equipment.
2. Shielded interface cables must be used in order to comply with the emission limits.

Table of Contents

Chapter 1 - Introduction

1.1 Features and Specifications.....	6
1.2 Package Checklist.....	13

Chapter 2 - Hardware Installation

2.1 System Board Layout	14
2.2 System Memory.....	16
2.3 Processor Installation.....	18
2.4 Jumper Settings for Clearing CMOS Data.....	20
2.5 Jumper Settings for Wake-On-Keyboard/Mouse.....	22
2.6 Jumper Settings for the Audio Codec.....	23
2.7 Jumper Settings for the System's Beep Message.....	24
2.8 Jumper Settings for the CPU's Front Side Bus.....	25
2.9 Jumper Settings for the Boot Block Lock/Unlock.....	26
2.10 Connecting the Ribbon Cables and Wires of the Ports and Connectors.....	27

Chapter 3 - Award BIOS Setup Utility

3.1 The Basic Input/Output System.....	43
3.1.1 Standard CMOS Features.....	43
3.1.2 Advanced BIOS Features.....	47
3.1.3 Advanced Chipset Features	51
3.1.4 Integrated Peripherals.....	54
3.1.5 Power Management Setup.....	60
3.1.6 PnP/PCI Configurations.....	64
3.1.7 System Health Monitor.....	66
3.1.8 CPU Frequency Control.....	67
3.1.9 Load Fail-Safe Defaults.....	68
3.1.10 Load Optimized Defaults.....	68
3.1.11 Set Supervisor Password.....	69
3.1.12 Set User Password.....	69
3.1.13 Save & Exit Setup.....	70
3.1.14 Exit Without Saving.....	70

Chapter 4 - Supported Softwares

4.1 Desktop Management Interface.....	71
4.2 Hardware Doctor Utility.....	74
4.3 INF Update for Windows® 95/98.....	74
4.4 Installing the Graphics Driver.....	75
4.5 Installing the Sound Driver.....	76
4.6 Drivers and Utilities Installation Notes.....	76

Appendix A - Using the Suspend to RAM Function

A.1 Using the Suspend to RAM Function.....	77
--	----

Appendix B - System Error Messages

B.1 POST Beep.....	81
B.2 Error Messages.....	81

Appendix C - Troubleshooting

C.1 Troubleshooting Checklist.....	83
------------------------------------	----

Chapter I - Introduction

I.I Features and Specifications

I.I.I Features

Chipset

- Intel® 810-E (PW65-E)
Intel® 810 DC-100 (PW65-D)
Intel® 810 (PW65-S)
Intel® 810-L (PW65-L)

Processor

The system board is equipped with a 242-pin Slot 1 processor slot for installing an Intel Pentium® II/III processor that is packaged in an SEC (Single Edge Contact) cartridge or an Intel Celeron™ processor. It is also equipped with a switching voltage regulator that automatically detects 1.30V to 3.5V.

- 450/100MHz, 500/100MHz, 550/100MHz or 600/100MHz Pentium® III processor
- 533/133MHz or 600/133MHz Pentium® III processor (PW65-E)
- 233/66MHz, 266/66MHz, 300/66MHz, 333/66MHz, 350/100MHz, 400/100MHz or 450/100MHz Pentium® II processor
- 266/300/300A/333/366/400/433MHz Celeron™ processor (SEPP for Slot 1)

System Memory

- 16MB to 256MB/512MB memory using unbuffered DIMMs with 64Mbit/128Mbit technology. (You must use 32MBx64 SDRAM DIMM to support 512MB memory)
- Two 168-pin DIMM sockets
- Uses x64 PC-100 SDRAM DIMM, 3.3V

DIMMs	Memory Size
2MBx64	16MB
4MBx64	32MB
8MBx64	64MB
16MBx64	128MB
32MBx64	256MB

Expansion Slots

The system board is equipped with 5 dedicated PCI slots and 1 AMR slot. AMR (Audio/Modem Riser) is an interface designed for installing an audio riser card, modem riser card or audio/modem riser card that is compliant to the AMR specification.

Onboard Graphics Features

- Graphics memory
 - Shares 1MB of the system memory. This is fixed regardless of the size of the system memory.
 - Uses the Dynamic Display Memory (DDM) technology. This freely changes in size because graphics memory is allocated from the system memory according to current needs.
 - 4MB onboard display cache (PW65-E and PW65-D only)
- Graphics controller
 - 100MHz (PW65-D) or 133MHz (PW65-E) super AGP performance using 4MB display cache memory
 - 3D hyper pipelined architecture
 - 2D hardware and motion video acceleration
 - 9-bit precision hardware motion compensation assistance for software MPEG2 decode
 - Software DVD at 30fps
- 2D graphics features
 - Resolution: up to 1600x1200 in 8-bit color at 85Hz refresh
 - 64-bit blitter with enhancements
 - 64x64x3 color transparent cursor
 - Arithmetic stretch blitter
- 3D graphics features
 - 600K-700K tri/sec sustained
 - 55Mpixels/sec
 - Flat and Gouraud shading
 - MIP mapping with bi-linear and anisotropic filtering
 - 16-bit color/Z-buffering
 - Discrete/strips/fans
 - Anisotropic filtering
 - Texture compositing, color keying and chroma keying
- Software drivers
 - Windows® 95/98
 - Windows NT® 4.0

Onboard Audio Features

- Supports Microsoft® DirectSound
- 32-voice wavetable synthesis
- AC'97 supported with full duplex, independent sample rate converter for audio recording and playback
- Downloadable sound (DLS) level-1

Compatibility

- Microsoft PC '98 compliant
- VESA Display Power Management Signaling (DPMS)
- VESA DDC2B for Plug and Play monitors
- PCI 2.2, AMR 1.0 and AC '97 compliant

ATX Double Deck Ports

- Two USB ports
- One NS16C550A-compatible DB-9 serial port
- One DB-15 VGA port
- One SPP/ECP/EPP DB-25 parallel port
- One mini-DIN-6 PS/2 mouse port
- One mini-DIN-6 PS/2 keyboard port
- One game/MIDI port
- Three audio jacks: line-out, line-in and mic-in

Connectors

- One 9-pin connector for external serial port
- One connector for IrDA interface
- Two IDE connectors
- One floppy drive interface supports up to two 2.88MB floppy drives
- One 20-pin ATX power supply connector
- One 3-pin Wake-On-LAN connector
- CPU, chassis and second chassis fan connectors
- One opened chassis alarm connector
- Three CD audio-in connectors (2 Sony and 1 Mitsumi)

PCI Bus Master IDE Controller

- Two PCI IDE interfaces support up to four IDE devices
- Supports Ultra ATA/33 (PW65-L) or ATA/66 (PW65-E, PW65-D or PW65-S) hard drives
- PIO Mode 4 Enhanced IDE (data transfer rate up to 14MB/sec.)
- Bus mastering reduces CPU utilization during disk transfer
- Supports ATAPI CD-ROM, LS-120 and ZIP

IrDA Interface

The system board is equipped with an IrDA connector for wireless connectivity between your computer and peripheral devices. It supports peripheral devices that meet the IrDA or ASKIR standard.

USB Ports

The system board is equipped with two USB ports. USB allows data exchange between your computer and a wide range of simultaneously accessible external Plug and Play peripherals.

BIOS

- Award BIOS, Windows® 95/98 Plug and Play compatible
- Supports SCSI sequential boot-up
- Flash EPROM for easy BIOS upgrades (4Mbit)
- Includes NCR 810 SCSI BIOS
- Supports DMI 2.0 function

Desktop Management Interface (DMI)

The system board comes with a DMI 2.0 built into the BIOS. The DMI utility in the BIOS automatically records various information about your system configuration and stores these information in the DMI pool, which is a part of the system board's Plug and Play BIOS. DMI, along with the appropriately networked software, is designed to make inventory, maintenance and troubleshooting of computer systems easier. Refer to chapter 4 for instructions on using the DMI utility.

1.1.2 System Health Monitor Functions

The system board is capable of monitoring the following “system health” conditions.

- Monitors processor/system/other devices temperature and over-heat alarm
- Monitors 5VSB/VBAT/1.5V/3.3V/+5V/±12V/processor voltages and failure alarm
- Monitors the fan speed of the processor fan, chassis fan and second chassis fan; controls the fan speed of the processor and chassis fans; and failure alarm
- Automatic fan on/off control
- Read back capability that displays temperature, voltage and fan speed
- Opened chassis alarm

Refer to the System Health Monitor section in chapter 3 and the Hardware Doctor Utility section in chapter 4 for more information.

1.1.3 Intelligence

Automatic CPU/Chassis Fan Off

The CPU and chassis fans will automatically turn off once the system enters the Suspend mode.

Dual Function Power Button

Depending on the setting in the “Soft-Off By PWR-BTTN” field of the Power Management Setup, this switch will allow the system to enter the Soft-Off or Suspend mode.

External Modem Ring-on

The Modem Ring-on feature allows the system that is in the Suspend mode or Soft Power Off mode to wake-up/power-on to respond to incoming calls.



Note:

This feature supports external modem only.

RTC Timer to Power-on the System

The RTC installed on the system board allows your system to automatically power-on on the set date and time.

Wake-On-LAN Ready

The Wake-On-LAN function allows the network to remotely wake up a Soft Power Down (Soft-Off) PC. Your LAN card must support the remote wakeup function.



Important:

If you are using the (1) Suspend to RAM, (2) Wake-On-Keyboard/Mouse and (3) Wake-On-LAN functions all at the same time, the 5VSB power source of your power supply must support a minimum of $\geq 1A$. A $\geq 720mA$ 5VSB power source is sufficient if you are using only one or two of these functions.

Wake-On-Keyboard/Wake-On-Mouse

This function allows you to use the keyboard or PS/2 mouse to power-on the system. Refer to “Jumper Settings for Wake-On-Keyboard/Wake-On-Mouse” in chapter 2 and “Keyboard/Mouse Power On” in the Integrated Peripherals section in chapter 3 for more information.



Important:

- The power button will not function once a keyboard password has been set in the “KB Power On Password” field of the Integrated Peripherals submenu. You must type the correct password to power-on the system. If you forgot the password, power-off the system and remove the battery. Wait for a few seconds and install it back before powering-on the system.*
- If you are using the (1) Suspend to RAM, (2) Wake-On-Keyboard/Mouse and (3) Wake-On-LAN functions all at the same time, the 5VSB power source of your power supply must support a minimum of $\geq 1A$. A $\geq 720mA$ 5VSB power source is sufficient if you are using only one or two of these functions.*

AC Power Failure Recovery

When power returns after an AC power failure, you may choose to either power-on the system manually, let the system power-on automatically or return to the state where you left off before power failure occurs. Refer to “PWR Lost Resume State” in the Integrated Peripherals section in chapter 3 for more information.

Year 2000 Compliant

- Supports hardware Y2K function.
- Supports hardware Random Number Generator (RNG) to enable a new security and manageability infrastructure for PC.

ACPI

The system board is designed to meet the ACPI (Advanced Configuration and Power Interface) specification. ACPI has energy saving features that enables PCs to implement Power Management and Plug-and-Play with operating systems that support OS Direct Power Management. Currently, only Windows® 98 supports the ACPI function. ACPI when enabled in the Power Management Setup will allow you to use the **Suspend to RAM** function.

With the Suspend to RAM function enabled, you can power-off the system at once by pressing the power button or selecting “Standby” when you shut down Windows® 98 without having to go through the sometimes tiresome process of closing files, applications and operating system. This is because the system is capable of storing all programs and data files during the entire operating session into RAM (Random Access Memory) when it powers-off. The operating session will resume exactly where you left off the next time you power-on the system. **Refer to “Using the Suspend to RAM Function” in appendix A for more information.**



Important:

If you are using the (1) Suspend to RAM, (2) Wake-On-Keyboard/Mouse and (3) Wake-On-LAN functions all at the same time, the 5VSB power source of your power supply must support a minimum of $\geq 1A$. A $\geq 720mA$ 5VSB power source is sufficient if you are using only one or two of these functions.

Virus Protection

Most viruses today destroy data stored in hard drives. The system board is designed to protect the boot sector and partition table of your hard disk drive.

I.2 Package Checklist

The system board package contains the following items:

- The system board
- A user's manual
- One card-edge bracket with a serial port
- One IDE cable for ATA/66 IDE drives (PW65-E, PW65-D or PW65-S)
- One IDE cable for ATA/33 IDE drives (PW65-L)
- One 34-pin floppy disk drive cable
- One "Main Board Utility" CD
- One "Video Audio Kit" CD (optional)

If any of these items are missing or damaged, please contact your dealer or sales representative for assistance.

Chapter 2 - Hardware Installation

2.1 System Board Layout

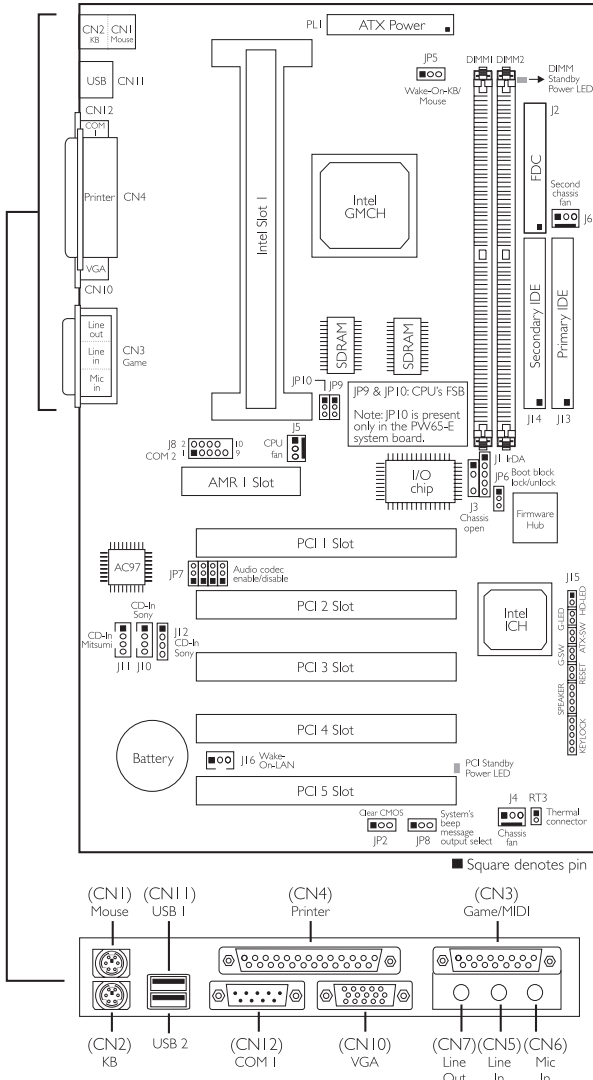

PW65-E or PW65-D

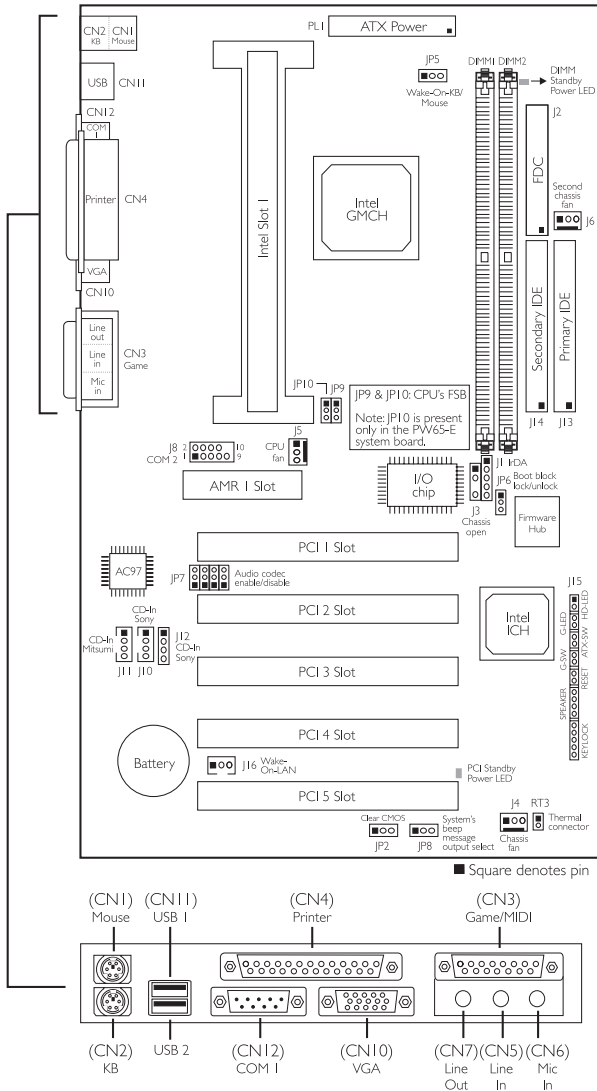

PW65-S or PW65-L



Note:

The illustrations on the following pages are based on the PW65-S or PW65-L system board, which are boards without SDRAMs.

**Warning:**

Electrostatic discharge (ESD) can damage your system board, processor, disk drives, add-in boards, and other components. Perform the upgrade instruction procedures described at an ESD workstation only. If such a station is not available, you can provide some ESD protection by wearing an antistatic wrist strap and attaching it to a metal part of the system chassis. If a wrist strap is unavailable, establish and maintain contact with the system chassis throughout any procedures requiring ESD protection.

2.2 System Memory

The system board is equipped with two 168-pin DIMM (Dual In-line Memory Module) sockets that support unbuffered PC-100 SDRAM DIMM. PC SDRAM (Synchronous Dynamic Random Access Memory) is a fast memory interface technology that uses the clock on the chip to synchronize with the CPU clock so that the timing of the memory chips and the timing of the CPU are synchronized. This saves time during transmission of data, subsequently increasing system performance.

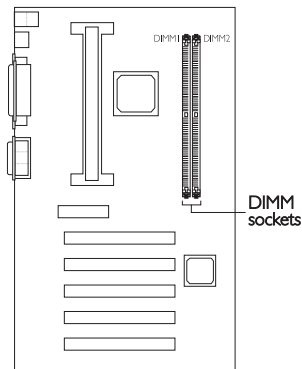

The onboard VGA shares 1MB of the system memory. This is fixed regardless of the size of the system memory.

Aside from the 1MB shared memory, it also uses the Dynamic Display Memory (DDM) technology. DDM freely changes in size because graphics memory is allocated from the system memory according to current needs.

Refer to chapter 1 for the type of memory supported by the system board.

Display Cache (PW65-E and PW65-D only)

The PW65-E and PW65-D system boards are each mounted with 2 SDRAMs that serve as 4MB display cache. The presence of the display cache will provide better system performance.

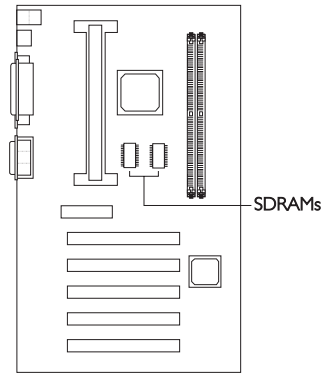

2.2.1 Installing the DIM Module

A DIM module simply snaps into a DIMM socket on the system board. Pin 1 of the DIM module must correspond with Pin 1 of the socket.

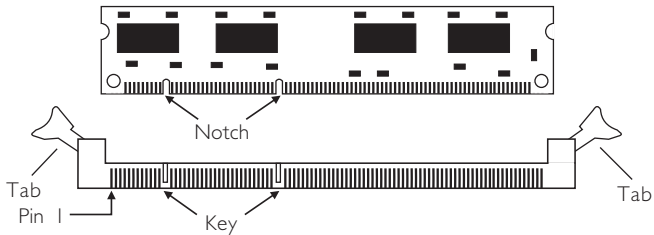

1. Pull the "tabs" which are at the ends of the socket to the side.
2. Position the DIMM above the socket with the "notches" in the module aligned with the "keys" on the socket.
3. Seat the module vertically into the socket. Make sure it is completely seated. The tabs will hold the DIMM in place.

2.3 Processor Installation

The system board is equipped with a 242-pin processor slot (Slot 1). The ends of the slot are installed with the Universal Retention Mechanism (URM). URM is used to hold an Intel® SECC, SECC2 or SEPP processor onto the slot.



Warning:

The processor must be kept cool by using a fan with heatsink. Leave certain space clearances to maintain proper airflow once the processor and heatsink are installed. All cables (for floppy drive, hard drive, CD-ROM, etc.) must be routed clear of the processor and its airspace. Otherwise, the processor will overheat subsequently damaging the processor and the system board.

2.3.1 Installing the Processor

1. Position the URM located at each end of Slot 1 into its upright position.

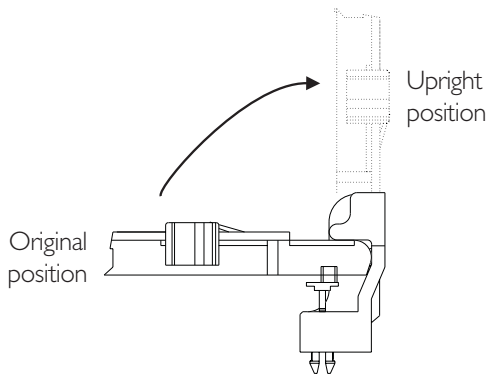

2. SECC processor:

Position the SECC processor above Slot 1 with the “notch” in the processor aligned with the “key” on the slot. Push the processor down firmly, with even pressure on both sides of the top, until it is completely seated. Push the latches located on the top sides of the processor outward until they click into place in the URM.

SECC2 or SEPP processor:

Position the SECC2 or SEPP processor above Slot 1 with the “notch” in the processor aligned with the “key” on the slot. Push the processor down firmly, with even pressure on both sides of the top, until it is completely seated. The sides of the processor’s heatsink will click and lock through the slit of the URM’s tab. Make sure the slide is in the LOCK position.

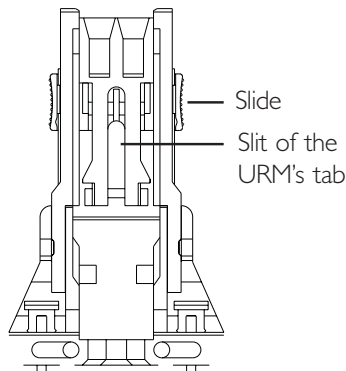

2.3.2 Removing the Processor

SECC processor:

Push the latches on the top sides of the processor toward the center until they click into place. Lift one end of the processor until it is freed from Slot 1. Lift the other end of the processor until it is freed from Slot 1. Lift the entire processor until it is free from the URM.

SECC2 or SEPP processor:

Push the slide of the URM downward until it clicks into its OPEN position. Lift one end of the processor until it is freed from Slot 1. Lift the other end of the processor until it is freed from Slot 1. Lift the entire processor until it is free from the URM.

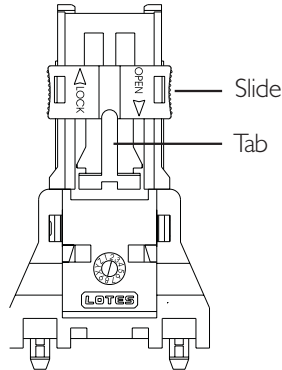

2.4 Jumper Settings for Clearing CMOS Data

Jumper JP2

Clear CMOS Data

If you encounter the following,

- CMOS data becomes corrupted.*
- You forgot the supervisor or user password.*
- You are unable to boot-up the computer system because the processor's clock/ratio was incorrectly set in the BIOS.*

you can reconfigure the system with the default values stored in the ROM BIOS.

To load the default values stored in the ROM BIOS, please follow the steps below.

- Power-off the system.

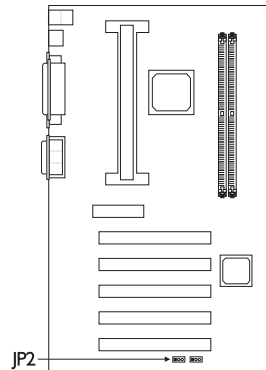

- Set JP2 pins 2 and 3 to On. Wait for a few seconds and set JP2 back to its default setting, pins 1 and 2 On.
- Now power-on the system.

If your reason for clearing the CMOS data is due to incorrect setting of the processor's clock/ratio in the BIOS, please proceed to step 4.

- After powering-on the system, press to enter the BIOS setup utility.
- Select the CPU Frequency Control submenu and press <Enter>.
- Set the "CPU Clock/Spread Spectrum" or "CPU Ratio" field to its default setting or an appropriate bus clock or frequency ratio. Refer to the CPU Frequency Control section in chapter 3 for more information.
- Press <Esc> to return to the main menu of the BIOS setup utility. Select "Save & Exit Setup" and press <Enter>.
- Type <Y> and press <Enter>.

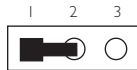

1-2 On: Normal
(default)

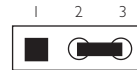

2-3 On:
Clear CMOS Data

2.5 Jumper Settings for Wake-On-Keyboard/ Wake-On-Mouse

Jumper JP5

Wake-On-Keyboard/Wake-On-Mouse

The system board supports the Wake-On-Keyboard/Wake-On-Mouse function. This function allows you to use the keyboard or PS/2 mouse to power-on the system. By default, JP5 is disabled. To use this function, set JP5 to 2-3 On. “Keyboard/Mouse Power On” in the Integrated Peripherals submenu of the BIOS must be set accordingly. Refer to chapter 3 for details.

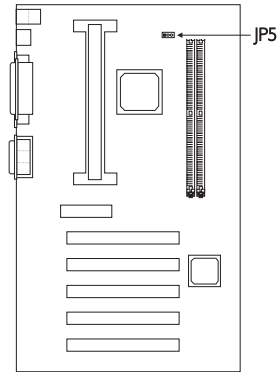

Warning:

1. If JP5 was enabled with a password set in the “KB Power On Password” field, and now you wish to disable the keyboard password function, make sure to set the “Keyboard/Mouse Power On” field to Disabled prior to setting JP5 to disabled. You will not be able to boot up the system if you fail to do so.
2. The power button will not function once a keyboard password has been set in the “KB Power On Password” field of the Integrated Peripherals submenu. You must type the correct password to power-on the system.
3. If you are using the (1) Suspend to RAM, (2) Wake-On-Keyboard/Mouse and (3) Wake-On-LAN functions all at the same time, the 5VSB power source of your power supply must support a minimum of $\geq 1\text{A}$. A $\geq 720\text{mA}$ 5VSB power source is sufficient if you are using only one or two of these functions.

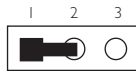

1-2 On: Disable
(default)

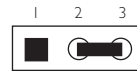

2-3 On: Enable

2.6 Jumper Settings for the Audio Codec

Jumper JP7

Enable/Disable Audio Codec

This jumper is used to enable or disable the audio codec (AC'97) on the system board. By default, the onboard audio codec is enabled. If you are using the AMR card's audio codec, set pins 2 and 3 to On. Please refer to the table below on how the jumper and the BIOS should be configured in different situations or system configurations.

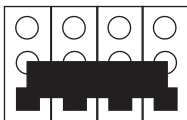
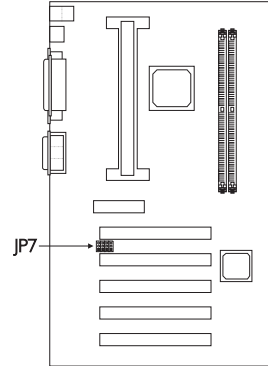

1-2 On: Enable
(default)

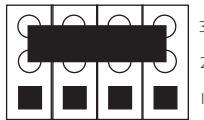

2-3 On: Disable

Nomenclature

"BIOS - AC97 Audio" : Refers to the "AC97 Audio" field in the Integrated Peripherals submenu.

"BIOS - AC97 Modem" : Refers to the "AC97 Modem" field in the Integrated Peripherals submenu.

- | | | | | | |
|----|---------------------------------|---|---|---|--|
| 1. | Onboard audio (primary) | + | No card in AMR or PCI/ISA slot | = | JP7: enable
BIOS - AC97 Audio: enable |
| 2. | Primary audio riser in AMR slot | = | JP7: disable
BIOS - AC97 Audio: enable | | |
| 3. | Onboard audio (primary) | + | Secondary audio riser in AMR slot | = | JP7: enable
BIOS - AC97 Audio: enable |
| 4. | Onboard audio (primary) | + | Secondary modem riser in AMR slot | = | JP7: enable
BIOS - AC97 Audio: enable
BIOS - AC97 Modem: enable |
| 5. | Onboard audio (primary) | + | PCI modem card in PCI slot | = | JP7: enable
BIOS - AC97 Audio: enable
BIOS - AC97 Modem: disable |

- | | | | | | |
|-----|----------------------------------|---|--|---|--|
| 6. | PCI sound card
in PCI slot | = | JP7: no effect; ignore
BIOS - AC97 Audio: disable | | |
| 7. | PCI sound card
in PCI slot | + | Primary modem
riser in AMR slot | = | JP7: disable
BIOS - AC97 Audio: disable
BIOS - AC97 Modem: enable |
| 8. | PCI sound card
in PCI slot | + | Secondary modem
riser in AMR slot | = | JP7: enable
BIOS - AC97 Audio: disable
BIOS - AC97 Modem: enable |
| 9. | PCI sound card
in PCI slot | + | PCI modem card
in PCI slot | = | JP7: no effect; ignore
BIOS - AC97 Audio: disable
BIOS - AC97 Modem: disable |
| 10. | Audio Modem riser
in AMR slot | = | JP7: disable
BIOS - AC97 Audio: enable
BIOS - AC97 Modem: enable | | |

2.7 Jumper Settings for the System's Beep Message

Jumper JP8

System's Beep Message Output Select

This jumper is used to select the speaker from which the system's beep message will sound. If you want the system's beep message to come from the external speaker that is connected to the line-out jack, set this jumper pins 1 and 2 to On. If you want the system's beep message to come from the PC's speaker, set this jumper pins 2 and 3 to On.

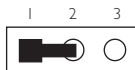
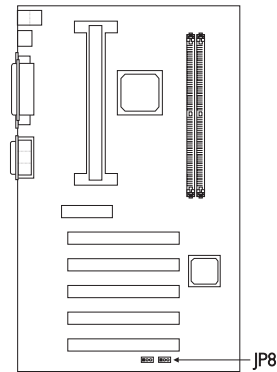

1-2 On:
External speaker

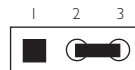

2-3 On:
PC's speaker
(default)

2.8 Jumper Settings for the CPU's Front Side Bus

PW65-D, PW65-S or PW65-L - JP9

If you are using the PW65-D, PW65-S or PW65-L system board, please use jumper JP9 to set the CPU's front side bus.

The default setting of jumper JP9 is Auto (2-3 On) - the system will automatically run according to the FSB of the processor. If you wish to overclock a 66MHz FSB processor to 100MHz, set all pins to Off. If you want a 100MHz FSB processor to run at 66MHz, set pins 1 and 2 to On.

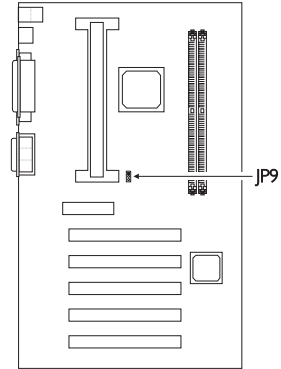

PW65-E - JP9 and JP10

If you are using the PW65-E system board, which is the board that supports 133MHz FSB, please use jumpers JP9 and JP10 to set the CPU's front side bus. JP10 is present only in the PW65-E system board.

The default setting of jumpers JP9 and JP10 is Auto - the system will automatically run according to the FSB of the processor:

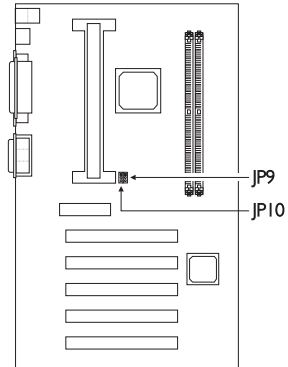

	JP9	JP10
Auto*	2-3 On	2-3 On
66MHz	1-2 On	1-2 On
100MHz	All Off	1-2 On
133MHz	All Off	All Off

*** denotes default setting



Note:
Use PC-100 SDRAM DIMMs only.

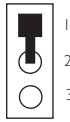

1-2 On

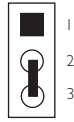

2-3 On



All Off

**Warning:**

Overclocking a 66MHz FSB processor to 100MHz or 133MHz will provide better system performance. However, not all 66MHz FSB processors are capable of running at 100MHz or 133MHz bus speed. Therefore, if you are unable to boot your system when set at 100MHz or 133MHz, make sure to set the jumper(s) back to its default setting.

2.9 Jumper Settings for the Boot Block Lock/Unlock

Jumper JP6

Boot Block Lock/Unlock

This jumper is for factory use only. Please leave it in its default setting.

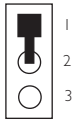

1-2 On:
Unlock boot block
(default)



2-3 On:
Lock Boot Block

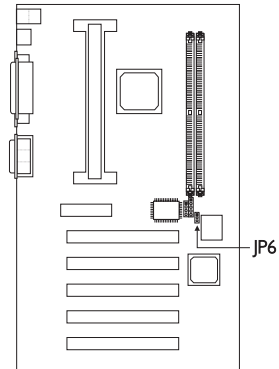

2.10 Connecting the Ribbon Cables and Wires of the Ports and Connectors

2.10.1 Serial Ports

The built-in serial ports are RS-232C asynchronous communication ports with 16C550A-compatible UARTs that can be used with modems, serial printers, remote display terminals, and other serial devices. You can set the serial ports' I/O address in the Integrated Peripherals submenu of the BIOS.

Connecting the Serial Ports

The system board is equipped with an onboard serial port at location CN12 for COM 1 primary serial port. It is also equipped with a 9-pin connector at location J8 for COM 2 secondary serial port.

One card-edge bracket mounted with a serial port cable is provided with the system board. If you want to use the secondary serial port, connect the serial port cable to connector J8. Make sure the colored stripe on the ribbon cable is aligned with pin 1 of connector J8. Mount the card-edge bracket to the system chassis.

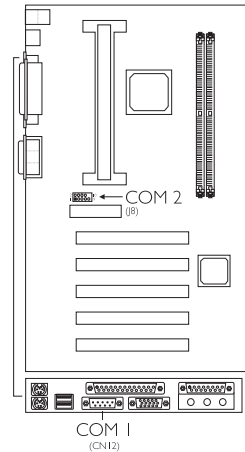

2.10.2 PS/2 Mouse and PS/2 Keyboard Ports

The PS/2 mouse port uses IRQ12. If a mouse is not connected to this port, the system will reserve IRQ12 for other expansion cards.



Warning:

Make sure to turn off your computer prior to connecting or disconnecting a mouse or keyboard. Failure to do so may damage the system board.

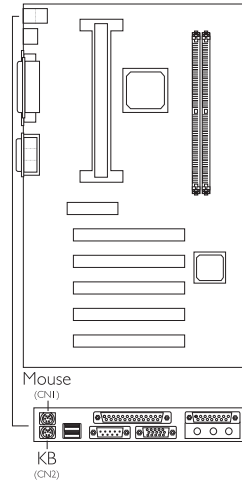

2.10.3 Parallel Port

The system board has a standard printer port for interfacing your PC to a parallel printer. It supports SPP, ECP and EPP modes. You can set the port's mode in the Integrated Peripherals submenu of the BIOS.

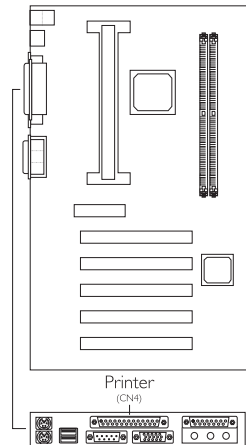

Setting	Function
SPP (Standard Parallel Port)	Allows normal speed operation but in one direction only.
ECP (Extended Capabilities Port)	Allows parallel port to operate in bidirectional mode and at a speed faster than the SPP's data transfer rate.
EPP (Enhanced Parallel Port)	Allows bidirectional parallel port operation at maximum speed.

2.10.4 Floppy Disk Drive Connector

The system board is equipped with a shrouded floppy disk drive connector that supports two standard floppy disk drives. To prevent improper floppy installation, the shrouded floppy disk header has a keying mechanism. The 34-pin connector on the floppy cable can be placed into the header only if pin 1 of the connector is aligned with pin 1 of the header. You may enable or disable this function in the Integrated Peripherals submenu of the BIOS.

Connecting the Floppy Disk Drive Cable

1. Install the 34-pin header connector into the shrouded floppy disk header (J2) on the system board. The colored edge of the ribbon should be aligned with pin 1 of J2.
2. Install the other 34-pin header connector(s) into the disk drive(s). Align the colored edge of the daisy chained ribbon cable with pin 1 of the drive edge connector(s). The end-most connector should be attached to the drive you want to designate as Drive A.

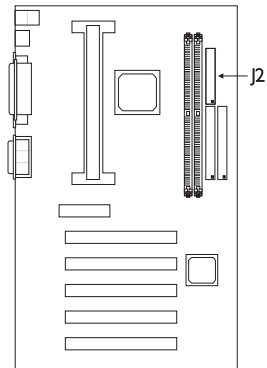

2.10.5 IDE Disk Drive Connector

The system board is equipped with two shrouded PCI IDE headers that will interface four Enhanced IDE (Integrated Drive Electronics) disk drives. To prevent improper IDE cable installation, each shrouded PCI IDE header has a keying mechanism. The 40-pin connector on the IDE cable can be placed into the header only if pin 1 of the connector is aligned with pin 1 of the header:

Connecting the IDE Disk Drive Cable

1. If you are connecting two IDE disk drives, install the 40-pin connector of the IDE cable into the primary shrouded IDE header (connector J13). If you are adding a third or fourth IDE device, install the 40-pin connector of the other IDE cable into the secondary shrouded IDE header (connector J14).
2. Install the other 40-pin header connector(s) into the device with the colored edge of the ribbon cable aligned with pin 1 of the drive edge connector(s).

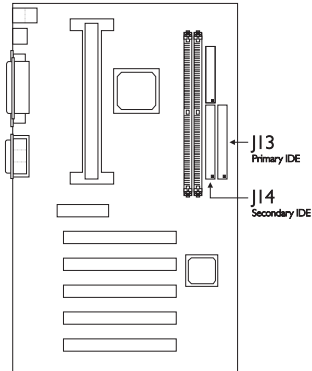

Note:

Refer to your disk drive user's manual for information about selecting proper drive switch settings.

Adding a Second IDE Disk Drive

When using two IDE drives, one must be set as the master and the other as the slave. Follow the instructions provided by the drive manufacturer for setting the jumpers and/or switches on the drives.

The system board supports Enhanced IDE or ATA-2, ATA/33 or ATA/66 hard drives. We recommend that you use hard drives from the same manufacturer. In a few cases, drives from two different manufacturers will not function properly when used together. The problem lies in the hard drives, not the system board.



Important:

If you encountered problems while using an ATAPI CD-ROM drive that is set in Master mode, please set the CD-ROM drive to Slave mode. Some ATAPI CD-ROMs may not be recognized and cannot be used if incorrectly set in Master mode.

2.10.6 Thermal Connector

If you wish to monitor the thermal condition of a device, connect one end of the thermal cable to the RT3 connector on the system board and the other end to the device.

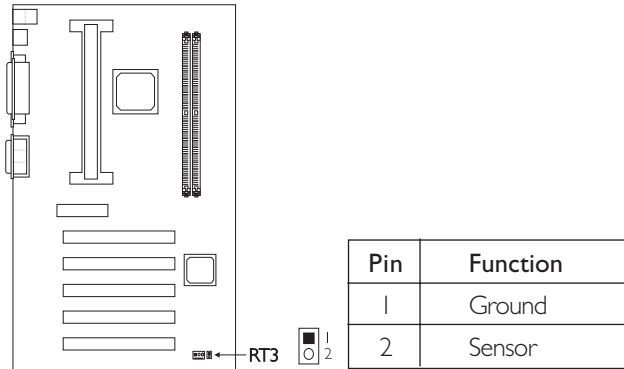

2.10.7 Universal Serial Bus Ports

The system board is equipped with two USB ports. USB allows data exchange between your computer and a wide range of simultaneously accessible external Plug and Play peripherals. You must have the proper drivers installed in your operating system to use the USB ports. Refer to your operating system's manual or documentation.

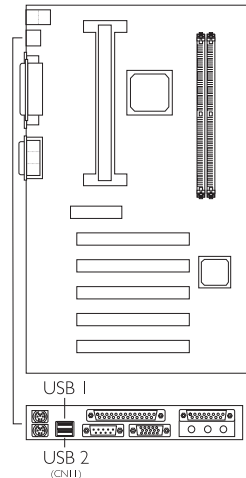

2.10.8 IrDA Connector

The system board is equipped with an IrDA connector for wireless connectivity between your computer and peripheral devices. The IRDA (Infrared Data Association) specification supports data transfers of 115K baud at a distance of 1 meter.

Connect your IrDA cable to connector J1 on the system board. Set "UART2 Mode Select" in the Integrated Peripherals submenu of the BIOS to the type of IrDA standard supported by your device. You must have the proper drivers installed in your operating system to use this connector. Refer to your operating system's manual or documentation.

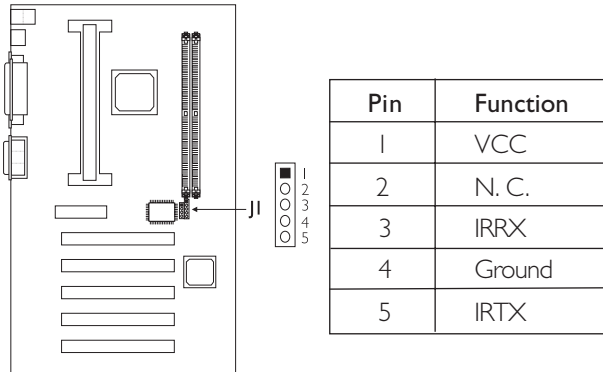

Note:

The sequence of the pin functions on some IrDA cable may be reversed from the pin function defined on the system board. Make sure to connect the cable to the IrDA connector according to their pin functions.

2.10.9 CPU Fan Connector

The processor must be kept cool by using a fan with heatsink. Connect the CPU fan to the 3-pin fan connector at location J5 on the system board. The system is capable of monitoring and controlling the speed of the CPU fan. The CPU fan, together with the chassis fan, will automatically turn off once the system enters the Suspend mode.

Pin	Function
1	Ground
2	On/Off
3	Sense

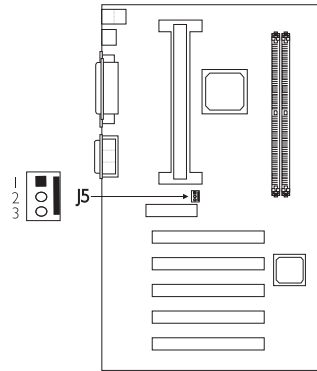

2.10.10 Chassis Fan Connector

If you are installing a chassis fan in the system unit, connect the fan's connector to location J4 on the system board. The fan will provide adequate airflow throughout the chassis to prevent overheating the processor. The system is capable of monitoring and controlling the speed of the chassis fan. The chassis fan, together with the CPU fan, will automatically turn off once the system enters the Suspend mode.

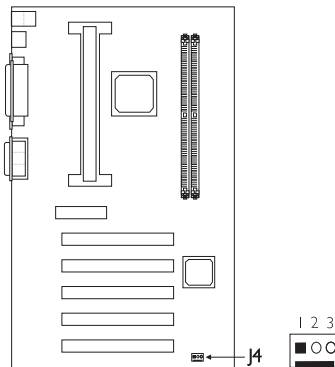

Pin	Function
1	Ground
2	On/Off
3	Sense

2.10.11 Second Chassis Fan Connector

If you are installing a second chassis fan in the system unit, connect the fan's connector to location J6 on the system board. The system is capable of monitoring the speed of the second chassis fan but does not control its fan speed.

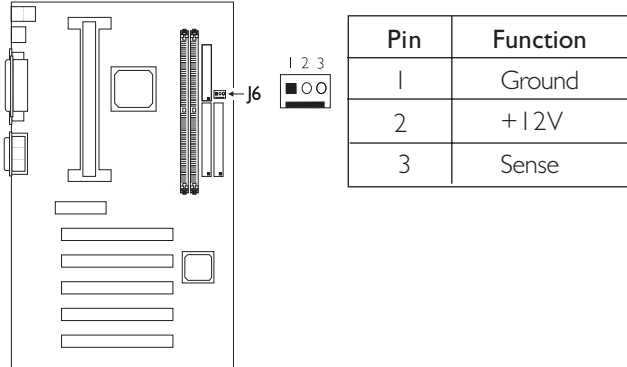

2.10.12 VGA Port

The system board can only be used with an analog video monitor. Connect the monitor's 15-pin D-shell cable connector to the VGA port at location CN10 of the system board. If your monitor supports analog video but does not have a 15-pin D-shell connector; see your monitor dealer for the adapter or optional cable. After you plug the monitor cable into the VGA port, gently tighten the cable screws to hold the connector in place. Some monitors have a switch that chooses between analog and TTL (or digital) operation. If your monitor has such a switch, set it for analog.

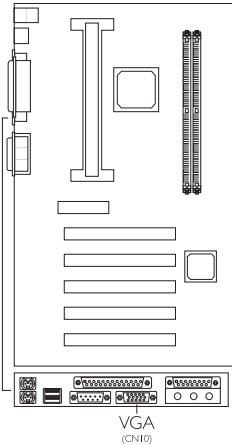

2.10.13 Game/MIDI Port

The Game/MIDI port is identical to that of a standard PC game adapter or game I/O port. Connect an analog joystick to the 15-pin D-sub connector. This port works well with any application that is compatible with the standard PC joystick.

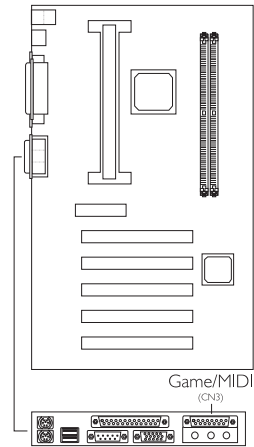

2.10.14 Audio Jacks

The system board is equipped with 3 audio jacks. A jack is a one-hole connecting interface for inserting a plug.

Line-out Jack

This jack is used to connect external speakers for audio output from the system board.

Line-in Jack

This jack can be connected to the line-out jack of any external audio devices such as Hi-fi set, CD player, AM/FM radio tuner, synthesizer, etc. Connect a stereo cable from the line-out jack of your external device to this line-in jack.

Mic-in Jack

Connect a microphone to the mic-in jack.

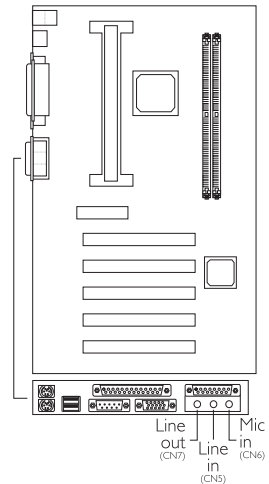

2.10.15 CD Audio-in Connector

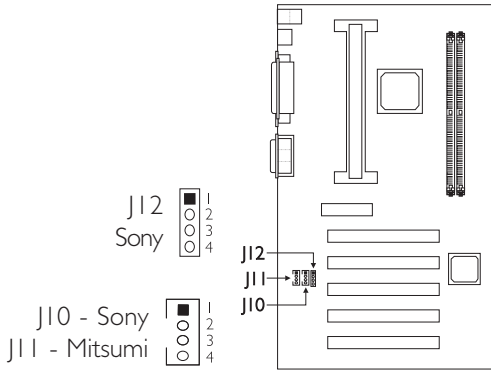

The system board is equipped with 3 CD audio-in connectors. Depending on the type of CD audio cable included in your CD-ROM package, connect one end of the cable to the CD audio-in connector on the system board and the other end to the audio line-out connector on your CD-ROM drive.

Connect the CD audio cable to J10 (Sony CD-ROM) or J11 (Mitsumi CD-ROM) if the audio cable included in your CD-ROM package looks somewhat similar to the one on the right.



Connect the CD audio cable to J12 (Sony CD-ROM) if the audio cable included in your CD-ROM package looks somewhat similar to the one on the right.



The pin assignment of the CD audio-in connectors are shown on the next page.

Pin	J12 - Sony	J10 - Sony	J11 - Mitsumi
1	CD-L	CD-L	CD-R
2	CD-G	CD-G	CD-G
3	CD-G	CD-G	CD-L
4	CD-R	CD-R	CD-G

2.10.16 Wake-On-LAN Connector

The system board supports the Wake-On-LAN function. This function will allow the network to remotely power-on a Soft Power Down (Soft-Off) PC. However, if your system is in the Suspend mode, you can power-on the system only through an IRQ or DMA interrupt.

To use the Wake-On-LAN function, you must enable the “Resume on LAN” field in the Power Management Setup of the BIOS. Your LAN card package should include a cable. Connect one end of the cable to the wakeup header on the card and the other end to location J16 on the system board. The network will detect Magic Packet and assert a wakeup signal to power-up the system. Refer to the add-in card’s manual for details. Note: Your LAN card must support the remote wake up function.

Pin	Function
1	WOL
2	Ground
3	+5VSB (720mA)

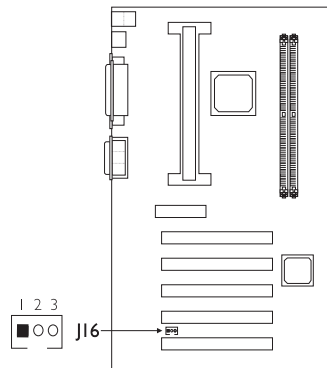

Important:

If you are using the (1) Suspend to RAM, (2) Wake-On-Keyboard/Mouse and (3) Wake-On-LAN functions all at the same time, the 5VSB power source of your power supply must support a minimum of $\geq 1A$. A $\geq 720mA$ 5VSB power source is sufficient if you are using only one or two of these functions.

2.10.17 Chassis Open Connector

The “chassis open” function, when enabled, will alert you that the system chassis is open. To use this function, please follow the steps below.

1. Connect the “chassis sensor” cable that is attached on your system chassis to location J3 on the system board.
2. Install the “Hardware Doctor” utility contained in the provided CD. By default, this function is disabled. When enabled, a warning message will appear when the chassis is open. The utility may also be configured so that a beeping alarm will sound when the chassis is open. Refer to the Hardware Doctor Utility section in chapter 4 for instructions on installing the utility.

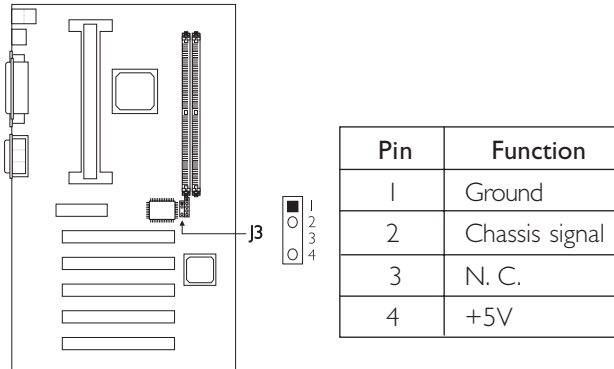

2.10.18 Power Connector

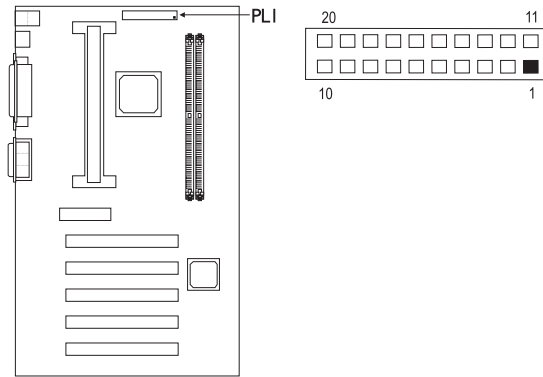

The pin assignment of the ATX power connector is shown below.

Pin	Function	Pin	Function
1	3.3V/14A	11	3.3V/14A
2	3.3V/14A	12	-12V
3	Ground	13	Ground
4	+5V	14	PS-ON
5	Ground	15	Ground
6	+5V	16	Ground
7	Ground	17	Ground
8	PW-OK	18	-5V
9	5VSB	19	+5V
10	+12V	20	+5V



Important:

Your power supply must meet the ATX specification - supporting 3.3V/14A (minimum), otherwise your system will not boot properly.

2.10.19 DIMM/PCI Standby Power LED

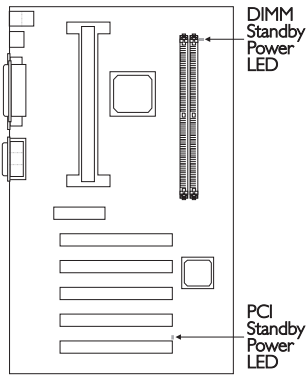

DIMM Standby Power LED

This LED will light when the system is in the power-on or Suspend mode. It will not light when the system is in the Soft-Off state.

PCI Standby Power LED

This LED will light when the system is in the power-on, Soft-Off or Suspend mode.



Important:

Lighted LEDs serve as a reminder that you must power-off the system then turn off the power supply's switch or unplug the power cord prior to installing any DIM modules or add-on cards.

2.10.20 J15 (LEDs and Switches)

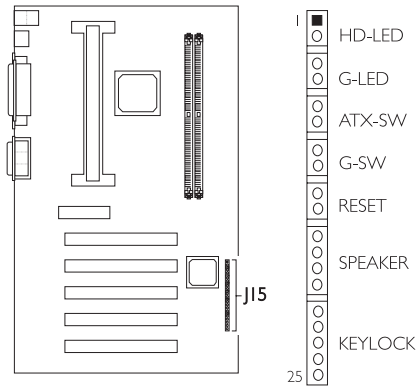

HD-LED: Primary/Secondary IDE LED

This LED will light when the hard drive is being accessed.

G-LED: Green LED

This LED will not light when the system's power is on or when the system is in the S3 (STR - Suspend To RAM) state. It will blink every second when the system is in the S1 (POS - Power On Suspend) state.

ATX-SW: ATX Power Switch

Depending on the setting in the BIOS setup, this switch is a "dual function power button" that will allow your system to enter the Soft-Off or Suspend mode. Refer to "Soft-Off By PWR-BTTN" in the Power Management Setup (chapter 3).

G-SW: Green Switch

This switch will allow your system to enter the Suspend mode.

RESET: Reset Switch

This switch allows you to reboot without having to power off the system thus prolonging the life of the power supply or system.

SPEAKER: Speaker Connector

This connects to the speaker installed in the system chassis.

KEYLOCK: Power/Standby LED and Keylock Connector

Use pins 21 to 23 to connect to the Power/Standby LED. When the system's power is on, this LED will light. When the system is in the S1 (POS - Power On Suspend) state, it will blink every second. When the system is in the S3 (STR - Suspend To RAM) state, it will blink every 4 seconds.

Use pins 24 to 25 to connect to the keyboard lock (located on the front panel of the system chassis) for locking the keyboard.

	Pin	Pin Assignment
HD-LED (Primary/Secondary IDE LED)	1	HDD LED Power
	2	HDD
	3	N. C.
G-LED (Green LED)	4	Green LED Power
	5	Green
	6	N. C.
ATX-SW (ATX power switch)	7	PWRBT
	8	Ground
	9	N. C.
G-SW (Green switch)	10	SMI
	11	Ground
	12	N. C.
RESET (Reset switch)	13	H/W Reset
	14	Ground
	15	N. C.
SPEAKER (Speaker connector)	16	Speaker Data
	17	N. C.
	18	Ground
	19	Speaker Power
	20	N. C.
KEYLOCK (Power/Standby LED and Keylock connector)	21	LED Power (+)
	22	N.C.
	23	LED Power (-) or Standby Signal
	24	Keylock
	25	Ground
		Use pins 21-23 for the Power/Standby LED.

Chapter 3 - Award BIOS Setup Utility

3.1 The Basic Input/Output System

The Basic Input/Output System (BIOS) is a program that takes care of the basic level of communication between the processor and peripherals. In addition, the BIOS also contains codes for various advanced features found in this system board. This chapter explains the Setup Utility for the Award BIOS.

After you power up the system, the BIOS message appears on the screen and the memory count begins. After the memory test, the following message will appear on the screen:

Press DEL to enter setup

If the message disappears before you respond, restart the system or press the "Reset" button. You may also restart the system by pressing the <Ctrl> <Alt> and keys simultaneously.

When you press , the main menu screen will appear:

CMOS Setup Utility - Copyright (C) 1984-1999 Award Software

Standard CMOS Features	CPU Frequency Control
Advanced BIOS Features	Load Fail-Safe Defaults
Advanced Chipset Features	Load Optimized Defaults
Integrated Peripherals	Set Supervisor Password
Power Management Setup	Set User Password
PnP/PCI Configurations	Save & Exit Setup
System Health Monitor	Exit Without Saving
Esc : Quit	↑↓→← : Select Item
F10 : Save & Exit Setup	
Time, Date, Hard Disk Type...	

3.1.1 Standard CMOS Features

Use the arrow keys to highlight "Standard CMOS Features" and press <Enter>. A screen similar to the one on the next page will appear:

CMOS Setup Utility - Copyright (C) 1984-1999 Award Software
Standard CMOS Features

		Item Help
Date (mm:dd:yy)	Sat, Jan 2 1999	Menu Level Change the day, month, year and century
Time (hh:mm:ss)	4 : 35 : 5	
IDE Primary Master	Press Enter None	
IDE Primary Slave	Press Enter None	
IDE Secondary Master	Press Enter None	
IDE Secondary Slave	Press Enter None	
Drive A	1.44M, 3.5 in.	
Drive B	None	
Video	EGA/VGA	
Halt On	All Errors	
Base Memory	640K	
Extended Memory	129024K	
Total Memory	130048K	
↑↓→← Move Enter:Select +/-/PU/PD:Value F10:Save ESC:Exit F1:General Help F5:Previous Values F6:Fail-Safe Defaults F7:Optimized Defaults		

The settings on the screen are for reference only. Your version may not be identical to this one.

Date

The date format is <day>, <month>, <date>, <year>. Day displays a day, from Sunday to Saturday. Month displays the month, from January to December. Date displays the date, from 1 to 31. Year displays the year, from 1994 to 2079.

Time

The time format is <hour>, <minute>, <second>. The time is based on the 24-hour military-time clock. For example, 1 p.m. is 13:00:00. Hour displays hours from 00 to 23. Minute displays minutes from 00 to 59. Second displays seconds from 00 to 59.

IDE Primary Master, IDE Primary Slave, IDE Secondary Master and IDE Secondary Slave

Move the cursor to the "IDE Primary Master", "IDE Primary Slave", "IDE Secondary Master" or "IDE Secondary Slave" field, then press <Enter>.

IDE HDD Auto Detection

Detects the parameters of the drive. The parameters will automatically be shown on the screen.

IDE Primary/Secondary Master/Slave

If you wish to define your own drive type manually, select "Manual". The drive type information should be included in the documentation from your hard disk vendor. If you select "Auto", the BIOS will auto-detect the HDD & CD-ROM drive at the POST stage and show the IDE for the HDD & CD-ROM drive. If a hard disk has not been installed, select "None".

Capacity

Displays the approximate capacity of the disk drive. Usually the size is slightly greater than the size of a formatted disk given by a disk checking program.

Access Mode

For hard drives larger than 528MB, you would typically select the LBA type. Certain operating systems require that you select Normal or Large. Please check your operating system's manual or Help desk on which one to select.

Drive A and Drive B

These categories identify the types of floppy disk drives installed.

<i>None</i>	No floppy drive is installed
<i>360K, 5.25 in.</i>	5-1/4 in. standard drive; 360KB capacity
<i>1.2M, 5.25 in.</i>	5-1/4 in. AT-type high-density drive; 1.2MB capacity
<i>720K, 3.5 in.</i>	3-1/2 in. double-sided drive; 720KB capacity
<i>1.44M, 3.5 in.</i>	3-1/2 in. double-sided drive; 1.44MB capacity
<i>2.88M, 3.5 in.</i>	3-1/2 in. double-sided drive; 2.88MB capacity

Video

This category selects the type of video adapter used for the primary system monitor. Although secondary monitors are supported, you do not have to select the type. The default setting is EGA/VGA.

<i>EGA/VGA</i>	Enhanced Graphics Adapter/Video Graphics Array. For EGA, VGA, SVGA and PGA monitor adapters.
<i>CGA 40</i>	Color Graphics Adapter. Power up in 40-column mode.
<i>CGA 80</i>	Color Graphics Adapter. Power up in 80-column mode.
<i>Mono</i>	Monochrome adapter. Includes high resolution monochrome adapters.

Halt On

This category determines whether the system will stop if an error is detected during power up. The default setting is All Errors.

No Errors The system boot will not stop for any errors detected.

All Errors The system boot will stop whenever the BIOS detects a non-fatal error.

All, But Keyboard The system boot will not stop for a keyboard error; it will stop for all other errors.

All, But Diskette The system boot will not stop for a disk error; it will stop for all other errors.

All, But Disk/Key The system boot will not stop for a disk or keyboard error; it will stop for all other errors.

Base Memory

Displays the amount of base (or conventional) memory installed in the system. The value of the base memory is typically 512K for systems with 512K memory installed on the motherboard or 640K for systems with 640K or more memory installed on the motherboard.

Extended Memory

Displays the amount of extended memory detected during boot-up.

Total Memory

Displays the total memory available in the system.

3.1.2 Advanced BIOS Features

The Advanced BIOS Features allows you to configure your system for basic operation. Some entries are defaults required by the system board, while others, if enabled, will improve the performance of your system or let you set some features according to your preference.

CMOS Setup Utility - Copyright (C) 1984-1999 Award Software
Advanced BIOS Features

		Item Help
Virus Warning	Disabled	
CPU L1 Cache	Enabled	
CPU L2 Cache	Enabled	
CPU L2 Cache ECC Checking	Enabled	
Processor Serial Number	Disabled	
Quick Power On Self Test	Enabled	
First Boot Device	Floppy	
Second Boot Device	HDD-0	
Third Boot Device	LS/ZIP	
Boot Other Device	Enabled	
Swap Floppy Drive	Disabled	
Boot Up Floppy Seek	Disabled	
Boot Up NumLock Status	Off	
Typeomatic Rate Setting	Disabled	
Typeomatic Rate (Chars/Sec)	6	
Typeomatic Delay (Msec)	250	
Security Option	Setup	
OS Select For DRAM > 64MB	Non-OS2	
HDD S.M.A.R.T. Capability	Disabled	
		Menu Level
		Allows you to choose the VIRUS warning feature for IDE Hard Disk boot sector protection. If this function is enabled and someone attempt to write data into this area, BIOS will show a warning message on screen and alarm beep
↑↓→← Move Enter:Select +/-/PU/PD:Value F10:Save ESC:Exit F1:General Help F5:Previous Values F6:Fail-Safe Defaults F7:Optimized Defaults		

The settings on the screen are for reference only. Your version may not be identical to this one.

Virus Warning

This category protects the boot sector and partition table of your hard disk drive. When this item is enabled, the Award BIOS will monitor the boot sector and partition table of the hard disk drive. If an attempt is made to write to the boot sector or partition table of the hard disk drive, the BIOS will halt the system and an error message will appear.

After seeing the error message, if necessary, you will be able to run an anti-virus program to locate and remove the problem before any damage is done.

Many disk diagnostic programs which attempt to access the boot sector table will cause the warning message to appear. If you are running such a program, we recommend that you first disable this category. Also, disable this category if you are installing or running certain operating systems like Windows® 95/98 or the operating system may not install nor work.

CPU L1 Cache and CPU L2 Cache

These categories speed up the memory access. The default value is enabled. Enable the external cache for better performance.

CPU L2 Cache ECC Checking

Intel Pentium® II/III and Celeron™ processors come with built-in Level 2 cache. By default, ECC is enabled to check the Level 2 cache. If you are not using this function, set this field to Disabled.

Processor Serial Number

This field will appear only when you are using a Pentium® III processor. Each Pentium® III processor comes with an individual "processor serial number" which by default is activated. Therefore, when connected to the Internet, Pentium® III processor transmits the serial number online making it possible to track your online activity. The field provides you the option of disabling this function.

Quick Power On Self Test

This category speeds up Power On Self Test (POST) after you power on the system. When Enabled, the BIOS will shorten or skip some check items during POST.

First Boot Device, Second Boot Device, Third Boot Device and Boot Other Device

Select the drive to boot first, second and third in the "First Boot Device" "Second Boot Device" and "Third Boot Device" fields respectively. The BIOS will boot the operating system according to the sequence of the drive selected. The options are: Floppy, LS/ZIP, HDD-0, SCSI, CDROM, HDD-1, HDD-2, HDD-3, LAN and Disable. Set "Boot Other Device" to Enabled if you wish to boot from another device.

Swap Floppy Drive

When this option is enabled and the system is booting from the floppy drive, the system will boot from drive B instead of drive A. When this option is disabled and the system is booting from the floppy drive, the system will boot from drive A. You must have two floppy drives to use this function.

Boot Up Floppy Seek

When enabled, the BIOS will check whether the floppy disk drive installed is 40 or 80 tracks. Note that the BIOS cannot distinguish between 720K, 1.2M, 1.44M and 2.88M drive types as they are all 80 tracks. When disabled, the BIOS will not search for the type of floppy disk drive by track number. Note that there will not be any warning message if the drive installed is 360KB.

Boot Up NumLock Status

This allows you to determine the default state of the numeric keypad. By default, the system boots up with NumLock on wherein the function of the numeric keypad is the number keys. When set to Off, the function of the numeric keypad is the arrow keys.

Typematic Rate Setting

When disabled, continually holding down a key on your keyboard will cause the BIOS to report that the key is down. When the typematic rate is enabled, the BIOS will not only report that the key is down, but will first wait for a moment, and, if the key is still down, it will begin to report that the key has been depressed repeatedly. For example, you would use such a feature to accelerate cursor movements with the arrow keys.

Typematic Rate (Chars/Sec)

This selection allows you to select the rate at which the keys are accelerated.

Typematic Delay (Msec)

This selection allows you to select the delay between when the key was first depressed and when the acceleration begins.

Security Option

This field determines when the system will prompt for the password - everytime the system boots or only when you enter the BIOS setup. Set the password in the Set Supervisor/User Password submenu.

- System* The system will not boot and access to Setup will be denied unless the correct password is entered at the prompt.
- Setup* The system will boot, but access to Setup will be denied unless the correct password is entered at the prompt.

OS Select for DRAM > 64MB

This item allows you to access the memory that is over 64MB in OS/2. The options are: Non-OS2 and OS2.

HDD S.M.A.R.T. Capability

The system board supports SMART (Self-Monitoring, Analysis and Reporting Technology) hard drives. SMART is a reliability prediction technology for ATA/IDE and SCSI drives. The drive will provide sufficient notice to the system or user to backup data prior to the drive's failure. The default is Disabled. If you are using hard drives that support S.M.A.R.T., set this field to Enabled. SMART is supported in ATA/33 or later hard drives.

3.1.3 Advanced Chipset Features

CMOS Setup Utility - Copyright (C) 1984-1999 Award Software
Advanced Chipset Features

SDRAM CAS Latency Time	3	Item Help	
SDRAM Cycle Time Tras/Trc	6/8	Menu Level	
SDRAM RAS-to-CAS Delay	3		
SDRAM RAS Precharge Time	3		
System BIOS Cacheable	Enabled		
Video BIOS Cacheable	Enabled		
Memory Hole At 15M-16M	Disabled		
Delayed Transaction	Enabled		
On-Chip Video Window Size	64MB		
* Onboard Display Cache Setting *			
CAS# Latency	3		
Paging Mode Control	Close		
RAS-to-CAS Override	by CAS# LT		
RAS# Timing	Slow		
RAS# Precharge Timing	Slow		
↑↓→← Move Enter:Select +/-/PU/PD:Value F10:Save ESC:Exit F1:General Help F5:Previous Values F6:Fail-Safe Defaults F7:Optimized Defaults			

The settings on the screen are for reference only. Your version may not be identical to this one.

This section gives you functions to configure the system based on the specific features of the chipset. The chipset manages bus speeds and access to system memory resources. **These items should not be altered unless necessary.** The default settings have been chosen because they provide the best operating conditions for your system. The only time you might consider making any changes would be if you discovered some incompatibility or that data was being lost while using your system.

SDRAM CAS Latency Time

The default setting is 3 which is 3 clock cycles for the CAS latency.

SDRAM Cycle Time Tras/Trc

This field selects the number of SCLKs for an access cycle. The default is 6/8.

SDRAM RAS-to-CAS Delay

This field allows you to insert a timing delay between the CAS and RAS strobe signals, used when DRAM is written to, read from, or refreshed. This field applies only when synchronous DRAM is installed in the system.

SDRAM RAS Precharge Time

If there is insufficient number of cycles for the RAS to accumulate its charge before DRAM refresh, the refresh may be incomplete and the DRAM may fail to retain data.

System BIOS Cacheable

When this option is enabled, accesses to the system BIOS ROM addressed at F0000H-FFFFFH are cached, provided that the cache controller is enabled. The larger the range of the Cache RAM, the higher the efficiency of the system.

Video BIOS Cacheable

As with caching the system BIOS, enabling the Video BIOS cache will allow access to video BIOS addressed at C0000H to C7FFFH to be cached, if the cache controller is also enabled. The larger the range of the Cache RAM, the faster the video performance.

Memory Hole At 15M-16M

In order to improve system performance, certain space in memory can be reserved for PCI-to-ISA cards. This memory must be mapped into the memory space below 16MB. When enabled, the CPU assumes the 15-16MB memory range is allocated to the hidden PCI/ISA address range instead of the actual system DRAM. When disabled, the CPU assumes the 15-16MB address range actually contains DRAM memory. If more than 16MB of system memory is installed, this option must be disabled to provide contiguous system memory.

Delayed Transaction

When enabled, this function frees up the PCI bus for other PCI masters during the PCI-to-ISA transactions. This allows PCI and ISA buses to be used more efficiently and prevents degradation of performance on the PCI bus when ISA accesses are made.

On-Chip Video Window Size

This field selects the on-chip video window size. The options are 32MB, 64MB and Disabled.

Onboard Display Cache Setting

The fields in this section are selectable only when you are using the PW65-E or PW65-D system board.

CAS# Latency

This field is used to select the local memory clock periods. The options are 2 and 3.

Paging Mode Control

This field is used to select the paging mode control. The options are Open and Close.

RAS-to-CAS Override

This field is used to select the display cache clock periods control. The options are "by CAS# LT" and "Override(2)".

RAS# Timing

This field controls RAS# active to Protegra, and refresh to RAS# active delay (in local memory clocks). The options are Slow and Fast.

RAS# Precharge Timing

This field controls RAS# precharge (in local memory clocks). The options are Slow and Fast.

3.1.4 Integrated Peripherals

CMOS Setup Utility - Copyright (C) 1984-1999 Award Software
Integrated Peripherals

On-Chip Primary PCI IDE	Enabled	↑	Item Help
On-Chip Secondary PCI IDE	Enabled		Menu Level
IDE Primary Master PIO	Auto	↓	
IDE Primary Slave PIO	Auto		
IDE Secondary Master PIO	Auto		
IDE Secondary Slave PIO	Auto		
IDE Primary Master UDMA	Auto		
IDE Primary Slave UDMA	Auto		
IDE Secondary Master UDMA	Auto		
IDE Secondary Slave UDMA	Auto		
USB Controller	Enabled		
USB Keyboard Support	Disabled		
Init Display First	PCI Slot		
AC97 Audio	Enabled		
AC97 Modem	Disabled		
IDE HDD Block Mode	Enabled		
Keyboard/Mouse Power On	Disabled		
X KB Power On Password	Enter		
X KB Power On Hot Key	Ctrl-F1		
Onboard FDC Controller	Enabled		
Onboard Serial Port 1	3F8/IRQ4		
Onboard Serial Port 2	2F8/IRQ3		
UART2 Mode Select	Normal		
X RxD, TxD Active	Hi,Lo		
X IR Transmission Delay	Enabled		
Onboard Parallel Port	378/IRQ7		
Parallel Port Mode	ECP+EPP		
EPP Mode Select	EPP1.7		
ECP Mode Use DMA	3		
PWR Lost Resume State	Keep Off		
Game Port Address	201		
Midi Port Address	Disabled		
X Midi Port IRQ	5		

ve ESC:Exit F1:General Help
s F7:Optimized Defaults

The screen above list all the fields available in the Integrated Peripherals submenu, for ease of reference in this manual. In the actual CMOS setup, you have to use the scroll bar to view the fields. The settings on the screen are for reference only. Your version may not be identical to this one.

On-Chip Primary PCI IDE and On-Chip Secondary PCI IDE

These categories allow you to enable or disable the primary and secondary IDE controller. The default is Enabled. Select Disabled if you want to add a different hard drive controller.

IDE Primary Master/Slave PIO and IDE Secondary Master/Slave PIO

PIO means Programmed Input/Output. Rather than have the BIOS issue a series of commands to effect a transfer to or from the disk drive, PIO allows the BIOS to tell the controller what it wants and then let the controller and the CPU perform the complete task by themselves. Your system supports five modes, 0 (default) to 4, which primarily differ in timing. When Auto is selected, the BIOS will select the best available mode after checking your drive.

- Auto* The BIOS will automatically set the system according to your hard disk drive's timing.
- 0-4* You can select a mode that matches your hard disk drive's timing. Caution: Do not use the wrong setting or you will have drive errors.

IDE Primary Master/Slave UDMA and IDE Secondary Master/Slave UDMA

These categories allow you to set the Ultra DMA in use. When Auto is selected, the BIOS will select the best available option after checking your hard drive or CD-ROM.

- Auto* The BIOS will automatically detect the settings for you.
- Disabled* The BIOS will not detect these categories.

USB Controller

We recommend that you leave this field in its default setting - Enabled.

USB Keyboard Support

By default, USB Keyboard Support is Disabled. However, if you are using a USB keyboard under DOS, make sure to enable this function.

Init Display First

This field is used to select whether to initialize the onboard VGA or PCI first when the system boots.

- Onboard* When the system boots, it will first initialize the onboard VGA.
- PCI Slot* When the system boots, it will first initialize PCI.

AC97 Audio

- Enabled* Select this option when using the onboard audio codec, primary or secondary audio riser card, or audio/modem riser card.
- Disabled* Select this option when using a PCI sound card.

AC97 Modem

Enabled Select this option when using a primary or secondary modem riser card, or audio/modem riser card.

Disabled Select this option when using a PCI modem card.

IDE HDD Block Mode

Enabled The IDE HDD uses the block mode. The system BIOS will check the hard disk drive for the maximum block size the system can transfer. The block size will depend on the type of hard disk drive.

Disabled The IDE HDD uses the standard mode.

Keyboard/Mouse Power On

This field allows you to use the keyboard or PS/2 mouse to power-on the system. To use this function, make sure JP5 is set to 2-3 On - the Wake-On-Keyboard/Mouse function enabled. Refer to "Jumper Settings for Wake-On-Keyboard/Wake-On-Mouse" in chapter 2 for more information.

Disabled Default setting.



Warning:

If JP5 was previously enabled with a password set in the "KB Power On Password" field, and now you wish to disable the keyboard password function, make sure to set this field to disabled prior to setting JP5 to disabled (1-2 On). You will not be able to boot up the system if you fail to do so.

Password When this option is selected, move the cursor to the "KB Power On Password" field and press <Enter>. Enter your password. You can enter up to 5 characters. Type in exactly the same password to confirm, then press <Enter>.



Important:

The power button will not function once a keyboard password has been set in the "KB Power On Password" field. You must type the correct password to power-on the system. If you forgot the password, power-off the

system and remove the battery. Wait for a few seconds and install it back before powering-on the system.

- Hot Key* When this option is selected, move the cursor to the “KB Power On Hot Key” field to select a function key you would like to use to power-on the system. The options are from Ctrl-F1 to Ctrl-F12.
- Mouse Left* When this option is selected, double-click the left button of the mouse to power-on the system.
- Mouse Right* When this option is selected, double-click the right button of the mouse to power-on the system.
- Any Key* Press any key to power-on the system.
- Keyboard 98* When this option is selected, press the “wake up” key of the Windows® 98 compatible keyboard to power-on the system.

Onboard FDC Controller

- Enabled* Enables the onboard floppy disk controller.
- Disabled* Disables the onboard floppy disk controller.

Onboard Serial Port 1 and Onboard Serial Port 2

- Auto* The system will automatically select an I/O address for the onboard serial port 1 and serial port 2.
- 3F8/IRQ4, 2F8/IRQ3, 3E8/IRQ4, 2E8/IRQ3* Allows you to manually select an I/O address for the onboard serial port 1 and serial port 2.
- Disabled* Disables the onboard serial port 1 and/or serial port 2.

UART2 Mode Select

The system board supports IrDA function for wireless connectivity between your computer and peripheral devices. You may not use IrDA (J1) and the COM 2 serial port (J8) at the same time. If you are using the COM 2 serial port, make sure this field is set to Normal.

To use the IrDA function, follow the steps below.

1. Connect your IrDA cable to connector J1 on the system board.

2. Set the "UART2 Mode Select" field to the type of IrDA standard supported by your IrDA peripheral/device (IrDA or ASKIR). For better transmission of data, your IrDA peripheral device must be within a 30° angle and within a distance of 1 meter.
3. Set the "RxD, TxD Active" and "IR Transmission Delay" fields appropriately.

RxD, TxD Active

The options are Hi, Lo; Lo, Hi; Lo, Lo; and Hi, Hi.

IR Transmission Delay

If this option is Enabled, transmission of data will be slower. This is recommended when you encounter transmission problem with your device. The options are: Enabled and Disabled.

Onboard Parallel Port

378H/IRQ7, 3BCH/IRQ7, 278H/IRQ5 Selects the I/O address and IRQ for the onboard parallel port.
Disabled Disables the onboard parallel port.

Parallel Port Mode

The options are SPP, EPP, ECP and ECP+EPP. These apply to a standard specification and will depend on the type and speed of your device. Refer to your peripheral's manual for the best option.

If you selected EPP, the "EPP Mode Select" field is selectable. If you selected ECP, the "ECP Mode Use DMA" field is selectable. If you selected ECP+EPP, both "EPP Mode Select" and "ECP Mode Use DMA" are selectable.

EPP Mode Select

The options are EPP1.9 and EPP1.7. Default setting: EPP1.7.

ECP Mode Use DMA

This is used to select a DMA channel for the parallel port. The options are 1 and 3. Default setting: 3.

PWR Lost Resume State

- Keep Off* When power returns after an AC power failure, the system's power is off. You must press the Power button to power-on the system.
- Turn On* When power returns after an AC power failure, the system will automatically power-on.
- Last State* When power returns after an AC power failure, the system will return to the state where you left off before power failure occurs. If the system's power is off when AC power failure occurs, it will remain off when power returns. If the system's power is on when AC power failure occurs, the system will power-on when power returns.

Game Port Address

This field is used to select the game port's address. The options are 201, 209 and Disabled.

Midi Port Address

This field is used to select the midi port's address. The options are 300, 330 and Disabled. If you have selected the midi port's address, you may select its IRQ in the "Midi Port IRQ" field.

Midi Port IRQ

This field is used to select the midi port's IRQ. The options are 5 and 7.

3.1.5 Power Management Setup

The Power Management Setup allows you to configure your system to most effectively save energy.

CMOS Setup Utility - Copyright (C) 1984-1999 Award Software
Power Management Setup

ACPI Function	Enabled	Item Help
ACPI Suspend Type	S1(POS)	Menu Level
Power Management	User Define	
Video Off Method	DPMS	
Video Off In Suspend	Yes	
Suspend Mode	Disabled	
HDD Power Down	Disabled	
Soft-Off By PWR-BTTN	Instant-Off	
Resume on PCI Event	Disabled	
Resume on Ring	Disabled	
Resume on LAN	Disabled	
Resume on Alarm	Disabled	
X Date(of Month) Alarm	0	
X Time (hh:mm:ss) Alarm	0 : 0 : 0	
↑↓→← Move Enter:Select +/-/PU/PD:Value F10:Save ESC:Exit F1:General Help F5:Previous Values F6:Fail-Safe Defaults F7:Optimized Defaults		

The settings on the screen are for reference only. Your version may not be identical to this one.

ACPI Function

This function should be enabled only in operating systems that support ACPI. Currently, only Windows® 98 supports this function. When enabled, the system will ignore the settings in the “Suspend Mode” and “HDD Power Down” fields. If you want to use the **Suspend to RAM** function, make sure this field is enabled then select “S3(STR)” in the field below.

ACPI Suspend Type

This field is used to select the type of Suspend mode.

- S1(POS) Enables the Power On Suspend function.
- S3(STR) Enables the **Suspend to RAM** function. Refer to “Using the Suspend to RAM Function” in appendix A for more information.

Power Management

This category allows you to select the type (or degree) of power saving by changing the length of idle time that elapses before the Suspend mode and HDD Power Down fields are activated.

- Min. Power Saving* Minimum power management. Suspend Mode and HDD Power Down = 1 hr.
- Max. Power Saving* Maximum power management. Suspend Mode and HDD Power Down = 1 min.
- User Define* Allows you to set each mode individually. When enabled, each option ranges from 1 min. to 1 hr.

Video Off Method

This determines the manner in which the monitor is blanked.

- VIIH SYNC + Blank* This selection will cause the system to turn off the vertical and horizontal synchronization ports and write blanks to the video buffer.
- Blank Screen* This option only writes blanks to the video buffer.
- DPMS* Initializes display power management signaling. Use this option if your video board supports it.

Video Off In Suspend

This field is used to activate the video off feature when the system enters the Suspend mode. The options are Yes and No.

Suspend Mode

This is user configurable only when the Power Management category is set to User Define. When enabled and after the set time of system inactivity, the CPU and onboard peripherals will be shut off.

HDD Power Down

This is user configurable only when the Power Management category is set to User Define. When enabled and after the set time of system inactivity, the hard disk drive will be powered down while all other devices remain active.

Soft-Off by PWR-BTTN

This category allows you to select the method of powering off your system.

Hold 4 Sec. Regardless of whether the Power Management field is enabled or disabled, if the power button is pushed and released in less than 4 sec, the system enters the Suspend mode. The purpose of this function is to prevent the system from powering off in case you accidentally “hit” or pushed the power button. Push and release again in less than 4 sec to restore. Pushing the power button for more than 4 seconds will power off the system.

Instant-Off Pressing and then releasing the power button at once will immediately power off your system.

Resume on PCI Event

Enabled Access to a PCI card such as a modem or LAN card will cause the system to wake up. The PCI card must support the wake up function.

Disabled The system will not wake up despite access to the PCI card.

Resume On Ring

With an external modem installed, the modem ring-on function will allow your system to power-on to respond to incoming calls. By default, the “Resume on Ring” field is Disabled. To use this function, please follow the steps below.

1. Make sure the computer system is powered off.
2. Connect the external modem to the COM 1 or COM 2 serial port.
3. Switch on the power of the external modem.
4. Power-on the computer system. After the memory test, press to enter the BIOS setup utility.
5. Select Power Management Setup and press <Enter>.
6. Set the “Resume on Ring” field to Enabled.
7. Press <Esc> to return to the main menu of the BIOS setup utility. Select “Save & Exit Setup” then press <Enter>.
8. Type <Y> and press <Enter>.

Resume On LAN

With a LAN card installed, the Wake-On-LAN function allows the network to remotely wake up a Soft Power Down (Soft-Off) PC. However, if your system is in the Suspend mode, you can wake up the system only through an IRQ or DMA interrupt. Make sure your LAN card supports the remote wake up function. To use this function, set this field to Enabled. Refer to “Wake-On-LAN Connector” in chapter 2 for more information.

Resume On Alarm

Enabled When Enabled, you can set the date and time you would like the Soft Power Down (Soft-Off) PC to power-on in the “Date (of Month) Alarm” and “Time (hh:mm:ss) Alarm” fields. However, if the system is being accessed by incoming calls or the network (Resume On Ring/LAN) prior to the date and time set in these fields, the system will give priority to the incoming calls or network.

Disabled Disables the automatic power-on function. (default)

Date (of Month) Alarm

0 The system will power-on everyday according to the time set in the “Time (hh:mm:ss) Alarm” field.

1-31 Select a date you would like the system to power-on. The system will power-on on the set date, and time set in the “Time (hh:mm:ss) Alarm” field.

Time (hh:mm:ss) Alarm

This is used to set the time you would like the system to power-on. If you want the system to power-on everyday as set in the “Date (of Month) Alarm” field, the time set in this field must be later than the time of the RTC set in the Standard CMOS Features submenu.

3.1.6 PnP/PCI Configurations

This section describes configuring the PCI bus system. It covers some very technical items and it is strongly recommended that only experienced users should make any changes to the default settings.

CMOS Setup Utility - Copyright (C) 1984-1999 Award Software
PnP/PCI Configurations

Reset Configuration Data	Disabled	Item Help
Resources Controlled By	Auto(ESCD)	Menu Level
X IRQ Resources	Press Enter	Default is Disabled. Select Enabled to reset Extended System Configuration Data (ESCD) when you exit Setup if you have installed a new add-on and the system reconfiguration has caused such a serious conflict that the OS cannot boot.
X Memory Resources	Press Enter	
PCI/VGA Palette Snoop	Disabled	
* PCI IRQ Assignment *		
Onboard VGA/Slot 1,5	Auto	
Onboard AC97/Slot 2	Auto	
Slot 3	Auto	
Onboard USB/Slot 4	Auto	
↑↓→← Move Enter:Select +/-/PU/PD:Value F10:Save ESC:Exit F1:General Help F5:Previous Values F6:Fail-Safe Defaults F7:Optimized Defaults		

The settings on the screen are for reference only. Your version may not be identical to this one.

Reset Configuration Data

Enabled The BIOS will reset the Extended System Configuration Data (ESCD) once automatically. It will then recreate a new set of configuration data.

Disabled The BIOS will not reset the configuration data.

Resources Controlled By

The Award Plug and Play BIOS has the capability to automatically configure all of the boot and Plug and Play compatible devices.

Auto The system will automatically detect the settings for you.

Manual Choose the specific IRQ and memory resources in the "IRQ Resources" and "Memory Resources" fields.

IRQ Resources

This field is used to set each system interrupt to either Legacy ISA or PCI.

- PCI* For devices compliant with the PCI bus architecture.
- Legacy ISA* For devices compliant with the original PC AT bus specification.

Memory Resources

This field is used to select the reserved memory base and reserved memory length of any peripherals that require high memory.

Reserved Memory Base

The options are N/A, C800, CC00, D000, D400, D800 and DC00.

Reserved Memory Length

The options are 8K, 16K, 32K and 64K.

PCI/VGA Palette Snoop

This field determines whether the MPEG ISA/VESA VGA cards can work with PCI/VGA or not. The default value is Disabled.

- Enabled* MPEG ISA/VESA VGA cards work with PCI/VGA.
- Disabled* MPEG ISA/VESA VGA cards does not work with PCI/VGA.

PCI IRQ Assignment

By default, an IRQ is automatically assigned to the "Onboard VGA/Slot 1,5", "Onboard AC97/Slot 2", "Slot 3" and "Onboard USB/Slot 4" fields. You may also manually assign an IRQ to these fields. The options are: IRQ3, IRQ4, IRQ5, IRQ7, IRQ9, IRQ10, IRQ11, IRQ12, IRQ14 and IRQ15.

3.1.7 System Health Monitor

CMOS Setup Utility - Copyright (C) 1984-1999 Award Software
System Health Monitor

Current System Temp.	27C/80F	Item Help
Current CPU Temperature	37C/98F	Menu Level
Current Chassis FAN Speed	0 RPM	
Current CPU FAN Speed	0 RPM	
Current Second FAN Speed	0 RPM	
CPU (V) :	2.06 V	
+1.5 V :	1.53 V	
+3.3 V :	3.31 V	
+5 V :	5.05 V	
+12 V :	12.03 V	
-12 V :	-11.37 V	
VBAT (V) :	3.21 V	
5VSB (V) :	5.40 V	
↑↓→← Move Enter:Select +/-/PU/PD:Value F10:Save ESC:Exit F1:General Help F5:Previous Values F6:Fail-Safe Defaults F7:Optimized Defaults		

The settings on the screen are for reference only. Your version may not be identical to this one.

Current System Temperature, Current CPU Temperature, Current Chassis Fan Speed, Current CPU Fan Speed and Current Second Fan Speed

These fields show the internal temperature of the system, current temperature of the processor, and the current fan speed of the chassis, CPU and second chassis fans in RPM (Revolutions Per Minute).

CPU (V)

This field shows the voltage of the processor.

+1.5V, +3.3V, +5V, +12V, -12V, VBAT (V) and 5VSB (V)

These fields show the output voltage of the power supply.

If you want a warning message to pop-up or a warning alarm to sound when an abnormal condition occurs, you must install the Hardware Doctor utility. This utility is included in the CD that came with the system board. Refer to the Hardware Doctor Utility section in chapter 4 for more information.

3.1.8 CPU Frequency Control

CMOS Setup Utility - Copyright (C) 1984-1999 Award Software
CPU Frequency Control

CPU Clock/Spread Spectrum CPU Ratio	Default X 3	Item Help
		Menu Level
↑↓→← Move Enter:Select +/-/PU/PD:Value F10:Save ESC:Exit F1:General Help F5:Previous Values F6:Fail-Safe Defaults F7:Optimized Defaults		

The settings on the screen are for reference only. Your version may not be identical to this one.

CPU Clock/Spread Spectrum

This field provides several options for selecting the external system bus clock of the processor. Regardless of the type of processor used, the default setting is "Default". Under this setting, the system will run according to the processor's clock frequency.

CPU Ratio

This field is used to select the frequency ratio of the processor. However, the frequency ratio of some processors has been fixed by the manufacturer. If you are using such kind of a processor, the setting in this field will have no effect.

If, in the "CPU Clock/Spread Spectrum" or "CPU Ratio" field, you selected an option other than the default setting and is unable to boot up the system, there are 2 methods of booting up the system and going back to its default setting.

Method 1:

Clear the CMOS data by setting JP2 to 2-3 On. All fields in the BIOS Setup will automatically be set to their default settings.

Method 2:

Press the <Insert> key and power button simultaneously, then release the power button first. Keep-on pressing the <Insert> key until the power-on screen appears. This will allow the system to boot according to the FSB of the processor. Now press the key to enter the Award BIOS setup utility. Select "CPU Frequency Control" and set the "CPU Clock/Spread Spectrum" or "CPU Ratio" field to its default setting or an appropriate bus clock or frequency ratio.



Note:

- Use a PS/2 or AT (requires a DIN to mini DIN adapter) keyboard for method 2.
- When using a 66MHz FSB processor, the system memory clock is 3/2 of the CPU's external bus clock and the PCI clock is 1/2 of the CPU's external bus clock.
- When using a 100MHz FSB processor, the system memory clock is the same as the CPU's external bus clock and the PCI clock is 1/3 of the CPU's external bus clock.
- When using a 133MHz FSB processor, the system memory clock is 3/4 of the CPU's external bus clock and the PCI clock is 1/4 of the CPU's external bus clock.

3.1.9 Load Fail-Safe Defaults

The "Load Fail-Safe Defaults" option loads the troubleshooting default values permanently stored in the ROM chips. These settings are not optimal and turn off all high performance features. You should use these values only if you have hardware problems. Highlight this option in the main menu and press <Enter>. The message below will appear:

Load Fail-Safe Defaults (Y/N)? N

If you want to proceed, type <Y> and press <Enter>. The default settings will be loaded.

3.1.10 Load Optimized Defaults

The "Load Optimized Defaults" option loads optimized settings from the BIOS ROM. Use the default values as standard values for your system. Highlight this option in the main menu and press <Enter>. The message below will appear:

Load Optimized Defaults (Y/N)? N

Type <Y> and press <Enter> to load the Setup default values.

3.1.11 Set Supervisor Password

If you want to protect your system and setup from unauthorized entry, set a supervisor's password with the "System" option selected in the Advanced BIOS Features. If you want to protect access to setup only, but not your system, set a supervisor's password with the "Setup" option selected in the Advanced BIOS Features. You will not be prompted for a password when you cold boot the system.

Use the arrow keys to highlight "Set Supervisor Password" and press <Enter>. The message below will appear:

Enter Password:

Type in the password. You are limited to eight characters. When done, the message below will appear:

Confirm Password:

You are asked to verify the password. Type in exactly the same password. If you type in a wrong password, you will be prompted to enter the correct password again. To delete or disable the password function, highlight "Set Supervisor Password" and press <Enter>, instead of typing in a new password. Press the <Esc> key to return to the main menu.

3.1.12 Set User Password

If you want another user to have access only to your system but not to setup, set a user's password with the "System" option selected in the Advanced BIOS Features. If you want a user to enter a password when trying to access setup, set a user's password with the "Setup" option selected in the Advanced BIOS Features.

Using user's password to enter Setup allows a user to access only "Set User Password" that appears in the main menu screen. Access to all other options is denied. To set, confirm, verify, disable or delete a user's password, follow the procedures described in the section "Set Supervisor Password".

3.1.13 Save & Exit Setup

When all the changes have been made, highlight “Save & Exit Setup” and press <Enter>. The message below will appear:

Save to CMOS and Exit (Y/N)? N

Type “Y” and press <Enter>. The modifications you have made will be written into the CMOS memory, and the system will reboot. You will once again see the initial diagnostics on the screen. If you wish to make additional changes to the setup, press <Ctrl> <Alt> <Esc> simultaneously or after memory testing is done.

3.1.14 Exit Without Saving

When you do not want to save the changes you have made, highlight “Exit Without Saving” and press <Enter>. The message below will appear:

Quit Without Saving (Y/N)? N

Type “Y” and press <Enter>. The system will reboot and you will once again see the initial diagnostics on the screen. If you wish to make any changes to the setup, press <Ctrl> <Alt> <Esc> simultaneously or after memory testing is done.

Chapter 4 - Supported Softwares

4.1 Desktop Management Interface (DMI)

The system board comes with a DMI built into the BIOS. DMI, along with the appropriately networked software, is designed to make inventory, maintenance and troubleshooting of computer systems easier. With DMI, a network administrator or MIS engineer can remotely access some information about a particular computer system without physically going to it. Quite often a service call may be unnecessary as the problem can be solved remotely.

The DMI utility in the BIOS automatically records various information about your system configuration. Information about the type and speed of CPU, type and amount of memory for each memory slot, BIOS revision level, types of add-in PCI boards and components, certain revision numbers of hardware installed, etc. are automatically detected and stored in the DMI pool, which is a part of the system board's Plug and Play BIOS. Additional information, such as ISA based peripherals, which may not be automatically detected, can be manually recorded in the DMI pool by using the Add DMI menu. The DMI pool data is then verified or updated whenever the system hardware or setup is altered.

4.1.1 Running the DMI Utility

To run the DMI utility, type: DMICFG.EXE. You can download this utility from <ftp.dfusa.com> - /utilities/DMI directory.

The DMI utility must run in real mode with at least 180K of base memory. Memory managers like HIMEM.SYS (required by Windows) must not be installed. You may do this by using one of the 3 methods listed below.

1. Boot up from a system diskette without the AUTOEXEC.BAT and CONFIG.SYS files,
2. "REM" HIMEM.SYS in the CONFIG.SYS, or
3. Press <F5> during bootup to bypass your AUTOEXEC.BAT and CONFIG.SYS files.

4.1.2 Using the DMI Utility

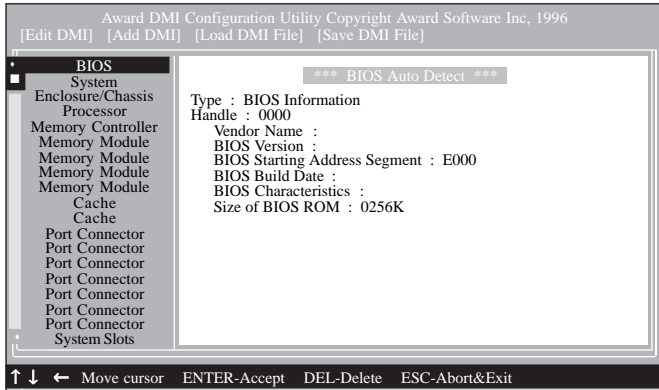

The four menus located on top of the DMI Configuration Utility screen are Edit DMI, Add DMI, Load DMI File and Save DMI File. Use the ← or → (left or right) arrow keys to select a menu from the Menu bar.

On the left side of the screen is a list of the system configuration items. Use the ↑ or ↓ (up or down) arrow keys to select an item.

The commands at the bottom of the screen will allow you to navigate through the various setup menus.

Edit DMI

1. Use the ← or → arrow keys to select the Edit DMI menu.
2. Highlight the item on the left screen that you would like to edit by using the ↑ or ↓ arrow keys, then press <Enter>.
3. The cursor will move to the screen you select allowing you to edit information. The screen will also display the auto-detected information.
4. Press <F10> to update the edited information into the flash ROM.

Add DMI

1. Use the ← or → arrow keys to select the Add DMI menu.
2. Highlight the item on the left screen that you would like to add by using the ↑ or ↓ arrow keys, then press <Enter>.
3. The cursor will move to the screen you select allowing you to enter information about the added item.
4. Press <F10> to save information into the flash ROM.

To view information about the added items, go to the Edit DMI menu.

Load DMI File

1. Use the ← or → arrow keys to select the Load DMI File menu.
2. The following message will appear:

Press [Enter] to select DMI file for load

Press <Enter>.

3. The DMI files will appear on the screen. Select the file you would like to load and press <Enter>.
4. The following message will appear:

Do you want to execute? (Y/N)

Type <Y>. All previous DMI structures will be destroyed and the new file will be saved into the flash ROM.

Save DMI File

1. Use the ← or → arrow keys to select the Save DMI File menu.
2. The following message will appear:

Press [Enter] to select DMI file for save

Press <Enter>.

3. Enter the directory and filename under which you would like the DMI file saved.

4.2 Hardware Doctor Utility

The system board comes with the Hardware Doctor utility contained in the provided CD. This utility is capable of monitoring the system's "health" conditions and allows you to manually set a range (Highest and Lowest Limit) to the items being monitored. If the settings/values are over or under the set range, a warning message will pop-up. The utility can also be configured so that a beeping alarm will sound whenever an error occurs. We recommend that you use the "Default Setting" which is the ideal setting that would keep the system in good working condition.



Note:

Use this utility only in Windows® 95 or Windows® 98 operating system.

To install the utility, insert the CD (included in the system board package) into a CD-ROM drive. The autorun screen (Main Board Utility CD) will appear. Click the Hardware Doctor button to install the utility.

4.3 INF Update for Windows® 95/98

The CD included in the system board package contains the INF Update utility. If you are using Windows® 95 (Windows® 95, Windows® 95+, Windows® 95 OSR1: Windows® 95 OEM Service Release 1, Windows® 95 OSR2: Windows® 95 OEM Service Release 2.0 or Windows® 95 OSR2.1: Windows® 95 OEM Service Release 2.0 plus USB Supplement) or Windows® 98, you need to install the utility. The utility is used for updating Windows® 95/98's INF files so that the Intel 810 series chipsets can be recognized and configured properly in the system.

4.3.1 Installing INF Update

1. Insert the CD into a CD-ROM drive. The autorun screen (Main Board Utility CD) will appear.
2. Click "INF Update".
3. The "Welcome" screen will appear. Click "Next".
4. The "Software License Agreement" screen will appear. Click "Yes".

5. The “Readme Information” screen will appear. You can view the content of the utility’s readme in this screen. Click “Next”.
6. The “Choose Destination Location” screen will appear showing where the utility will be located. Click “Next”.
7. The “Actions” screen will appear. Click “Next” to install the utility.
8. Restart the system.
9. Follow the prompts on the screen to continue with the installation.

**Note:**

If you are using Windows® 95B and you want to use the USB device, you must first install the USBSUPP program before installing the INF Update. Please contact Microsoft for this program.

4.4 Installing the Graphics Driver

1. Insert the CD into a CD-ROM drive. The autorun screen (Main Board Utility CD) will appear.
2. Click “Graphics Driver”.
3. The “Welcome” screen will appear. Click “Next”.
4. The “Software License Agreement” screen will appear. Click “Yes”.
5. Choose the destination you would like the driver located then click “Next” to start installing the driver.
6. Click “Finish”.
7. The system will restart.

4.4.1 Windows 2000 VGA Driver Installation Notes

The Windows 2000 VGA driver auto-installation function is not supported. To install the driver, please follow Windows VGA installation procedures. If you need the “I81XNT5.INF” file, please locate the file in “VgaDrv\Win2KCD\Win2000\” that is contained in the CD included in the system board package.

4.5 Installing the Sound Driver

1. Insert the CD into a CD-ROM drive. The autorun screen (Main Board Utility CD) will appear.
2. Click "Sound Driver".
3. The "Welcome" screen will appear. Click "Next" to install the driver.
4. The system will restart.
5. Follow the prompts to continue with the installation.

4.6 Drivers and Utilities Installation Notes

1. "Autorun" ONLY supports the Windows® 95, Windows® 98 and Windows NT® 4.0 operating systems. If after inserting the CD, "Autorun" did not automatically start (which is, the Main Board Utility CD screen did not appear), please go directly to the root directory of the CD and double-click "Autorun".
2. Please go to DFI's web site at "<http://www.dfi.com/support/download1.asp>" for the latest version of the drivers or software applications.
3. All steps or procedures to install software drivers are subject to change without notice as the softwares are occasionally updated. Please refer to the readme files, if available, for the latest information.

Appendix A - Using the Suspend to RAM Function

A.1 Using the Suspend to RAM Function

1. Select "Power Management Setup" in the main menu screen and press <Enter>.
2. In the "ACPI Function" field, select "Enabled".
3. In the "ACPI Suspend Type" field, select "S3(STR)".

CMOS Setup Utility - Copyright (C) 1984-1999 Award Software
Power Management Setup

		Item Help
ACPI Function	Enabled	
ACPI Suspend Type	S3(STR)	
Power Management	User Define	Menu Level
Video Off Method	DPMS	
Video Off In Suspend	Yes	
Suspend Mode	Disabled	
HDD Power Down	Disabled	
Soft-Off By PWR-BTTN	Instant-Off	
Resume on PCI Event	Disabled	
Resume on Ring	Disabled	
Resume on LAN	Disabled	
Resume on Alarm	Disabled	
X Date(of Month) Alarm	0	
X Time (hh:mm:ss) Alarm	0 : 0 : 0	

↑↓←→ Move Enter:Select +/-/PU/PD:Value F10:Save ESC:Exit F1:General Help
F5:Previous Values F6:Fail-Safe Defaults F7:Optimized Defaults

4. Press <Esc> to return to the main menu.
5. Select "Save & Exit Setup" and press <Enter>. Type <Y> and press <Enter>.
6. Install Windows® 98 by typing the following parameter. This is to ensure that the ACPI function is supported.

[drive]:>setup /p j

If you have previously installed Windows® 98, you need to upgrade the system in order to support ACPI. Please contact Microsoft for upgrade information.

Using the Suspend to RAM Function

7. Boot Windows® 98. In the Windows® 98 desktop, click the Start button. Move the cursor to Settings, then click Control Panel.

To check whether ACPI was properly installed, double-click the System icon. In the System Properties dialog box, click the “Device Manager” tab. In “View devices by type”, click “System devices”.



8. Double-click the System icon. In the System Properties dialog box, click the Performance tab.



Using the Suspend to RAM Function

- Click File System. In the “Typical role of this computer” field, select “Mobile or docking system”. Click Apply, then click OK. Restart the computer.

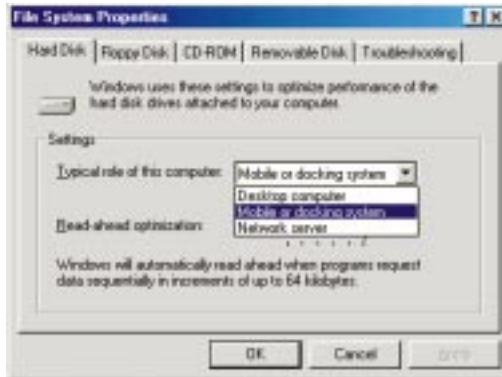

- Repeat step 7 to open the Control Panel dialog box. Double-click the Power Management icon.
- Click the Advanced tab. In the “When I press the power button on my computer” field, select “Standby”.



12. After completing the steps above and you want to power-off the computer, you do not need to go through the process of closing files, applications and operating system. You can power-off the computer at once by pressing the power button or selecting "Standby" when you shut down Windows® 98.

To power-on the computer, just press the power button. The operating session where you left off when you power-off the computer will resume in not more than 8 seconds. However, the power button will not function if a keyboard password has been set in the "KB Power On Password" field of the Integrated Peripherals submenu. You must type the password to power-on the computer.

If you have changed the color or resolution (in the Display Properties dialog box), do not apply the settings without restarting. You must restart the computer.

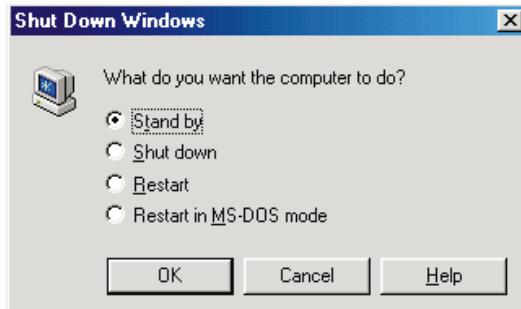

Appendix B - System Error Message

When the BIOS encounters an error that requires the user to correct something, either a beep code will sound or a message will be displayed in a box in the middle of the screen and the message, PRESS F1 TO CONTINUE, CTRL-ALT-ESC or DEL TO ENTER SETUP, will be shown in the information box at the bottom. Enter Setup to correct the error.

B.1 POST Beep

There are two kinds of beep codes in the BIOS. One code indicates that a video error has occurred and the BIOS cannot initialize the video screen to display any additional information. This beep code consists of a single long beep followed by three short beeps. The other code indicates that a DRAM error has occurred. This beep code consists of a single long beep.

B.2 Error Messages

One or more of the following messages may be displayed if the BIOS detects an error during the POST. This list indicates the error messages for all Awards BIOSes:

CMOS BATTERY HAS FAILED

The CMOS battery is no longer functional. It should be replaced.



Caution:

Danger of explosion if battery incorrectly replaced. Replace only with the same or equivalent type recommended by the manufacturer. Dispose of used batteries according to the battery manufacturer's instructions.

CMOS CHECKSUM ERROR

Checksum of CMOS is incorrect. This can indicate that CMOS has become corrupt. This error may have been caused by a weak battery. Check the battery and replace if necessary.

DISPLAY SWITCH IS SET INCORRECTLY

The display switch on the motherboard can be set to either monochrome or color. This indicates the switch is set to a different

setting than indicated in Setup. Determine which setting is correct, either turn off the system and change the jumper or enter Setup and change the VIDEO selection.

FLOPPY DISK(S) fail (80)

Unable to reset floppy subsystem.

FLOPPY DISK(S) fail (40)

Floppy type mismatch.

Hard Disk(s) fail (80)

HDD reset failed.

Hard Disk(s) fail (40)

HDD controller diagnostics failed.

Hard Disk(s) fail (20)

HDD initialization error.

Hard Disk(s) fail (10)

Unable to recalibrate fixed disk.

Hard Disk(s) fail (08)

Sector Verify failed.

Keyboard is locked out - Unlock the key

The BIOS detects that the keyboard is locked. Keyboard controller is pulled low.

Keyboard error or no keyboard present

Cannot initialize the keyboard. Make sure the keyboard is attached correctly and no keys are being pressed during the boot.

Manufacturing POST loop

System will repeat POST procedure infinitely while the keyboard controller is pull low. This is also used for the M/B burn in test at the factory.

BIOS ROM checksum error - System halted

The checksum of ROM address F0000H-FFFFFFH is bad.

Memory test fail

The BIOS reports memory test fail if the memory has error(s).

Appendix C - Troubleshooting

C.1 Troubleshooting Checklist

This chapter of the manual is designed to help you with problems that you may encounter with your personal computer. To efficiently troubleshoot your system, treat each problem individually. This is to ensure an accurate diagnosis of the problem in case a problem has multiple causes.

Some of the most common things to check when you encounter problems while using your system are listed below.

1. The power switch of each peripheral device is turned on.
2. All cables and power cords are tightly connected.
3. The electrical outlet to which your peripheral devices are connected is working. Test the outlet by plugging in a lamp or other electrical device.
4. The monitor is turned on.
5. The display's brightness and contrast controls are adjusted properly.
6. All add-in boards in the expansion slots are seated securely.
7. Any add-in board you have installed is designed for your system and is set up correctly.

Monitor/Display

If the display screen remains dark after the system is turned on:

1. Make sure that the monitor's power switch is on.
2. Check that one end of the monitor's power cord is properly attached to the monitor and the other end is plugged into a working AC outlet. If necessary, try another outlet.
3. Check that the video input cable is properly attached to the monitor and the system's display adapter.
4. Adjust the brightness of the display by turning the monitor's brightness control knob.

The picture seems to be constantly moving.

1. The monitor has lost its vertical sync. Adjust the monitor's vertical sync.
2. Move away any objects, such as another monitor or fan, that may be creating a magnetic field around the display.
3. Make sure your video card's output frequencies are supported by this monitor.

The screen seems to be constantly wavering.

1. If the monitor is close to another monitor, the adjacent monitor may need to be turned off. Fluorescent lights adjacent to the monitor may also cause screen wavering.

Power Supply

When the computer is turned on, nothing happens.

1. Check that one end of the AC power cord is plugged into a live outlet and the other end properly plugged into the back of the system.
2. Make sure that the voltage selection switch on the back panel is set for the correct type of voltage you are using.
3. The power cord may have a "short" or "open". Inspect the cord and install a new one if necessary.

Floppy Drive

The computer cannot access the floppy drive.

1. The floppy diskette may not be formatted. Format the diskette and try again.
2. The diskette may be write-protected. Use a diskette that is not write-protected.
3. You may be writing to the wrong drive. Check the path statement to make sure you are writing to the targeted drive.
4. There is not enough space left on the diskette. Use another diskette with adequate storage space.

Hard Drive

Hard disk failure.

1. Make sure the correct drive type for the hard disk drive has been entered in the BIOS.
2. If the system is configured with two hard drives, make sure the bootable (first) hard drive is configured as Master and the second hard drive is configured as Slave. The master hard drive must have an active/bootable partition.

Excessively long formatting period.

1. If your hard drive takes an excessively long period of time to format, it is likely a cable connection problem. However, if your hard drive has a large capacity, it will take a longer time to format.

Parallel Port

The parallel printer doesn't respond when you try to print.

1. Make sure that your printer is turned on and that the printer is on-line.
2. Make sure your software is configured for the right type of printer attached.
3. Verify that the onboard LPT port's I/O address and IRQ settings are configured correctly.
4. Verify that the attached device works by attaching it to a parallel port that is working and configured correctly. If it works, the printer can be assumed to be in good condition. If the printer remains inoperative, replace the printer cable and try again.

Serial Port

The serial device (modem, printer) doesn't output anything or is outputting garbled characters.

1. Make sure that the serial device's power is turned on and that the device is on-line.
2. Verify that the device is plugged into the correct serial port on the rear of the computer.
3. Verify that the attached serial device works by attaching it to a serial port that is working and configured correctly. If the serial device does not work, either the cable or the serial device has a problem. If the serial device works, the problem may be due to the onboard I/O or the address setting.
4. Make sure the COM settings and I/O address are configured correctly.

Keyboard

Nothing happens when a key on the keyboard was pressed.

1. Make sure the keyboard is properly connected.
2. Make sure there are no objects resting on the keyboard and that no keys are pressed during the booting process.

System Board

1. Make sure the add-in card is seated securely in the expansion slot. If the add-in card is loose, power off the system, re-install the card and power up the system.
2. Check the jumper settings to ensure that the jumpers are properly set.
3. Verify that all memory modules are seated securely into the memory sockets.
4. Make sure the memory modules are in the correct locations.
5. If the board fails to function, place the board on a flat surface and seat all socketed components. Gently press each component into the socket.
6. If you made changes to the BIOS settings, re-enter setup and load the BIOS defaults.