

SUPER[®] 

SUPER[®] PDSL A
SUPER[®] PDSL E

USER'S MANUAL

Revision 1.1

The information in this User's Manual has been carefully reviewed and is believed to be accurate. The vendor assumes no responsibility for any inaccuracies that may be contained in this document, makes no commitment to update or to keep current the information in this manual, or to notify any person or organization of the updates.

Please Note: For the most up-to-date version of this manual, please see our web site at www.supermicro.com.

SUPERMICRO COMPUTER reserves the right to make changes to the product described in this manual at any time and without notice. This product, including software, if any, and documentation may not, in whole or in part, be copied, photocopied, reproduced, translated or reduced to any medium or machine without prior written consent.

IN NO EVENT WILL SUPERMICRO COMPUTER BE LIABLE FOR DIRECT, INDIRECT, SPECIAL, INCIDENTAL, OR CONSEQUENTIAL DAMAGES ARISING FROM THE USE OR INABILITY TO USE THIS PRODUCT OR DOCUMENTATION, EVEN IF ADVISED OF THE POSSIBILITY OF SUCH DAMAGES. IN PARTICULAR, THE VENDOR SHALL NOT HAVE LIABILITY FOR ANY HARDWARE, SOFTWARE, OR DATA STORED OR USED WITH THE PRODUCT, INCLUDING THE COSTS OF REPAIRING, REPLACING, INTEGRATING, INSTALLING OR RECOVERING SUCH HARDWARE, SOFTWARE, OR DATA.

Any disputes arising between manufacturer and customer shall be governed by the laws of Santa Clara County in the State of California, USA. The State of California, County of Santa Clara shall be the exclusive venue for the resolution of any such disputes. Supermicro's total liability for all claims will not exceed the price paid for the hardware product.

*** California Best Management Practices Regulations for Perchlorate Materials**

This Perchlorate warning applies only to products containing CR (Manganese Dioxide) Lithium Coin cells. "Perchlorate Material-special handling may apply. See www.dtsc.ca.gov/hazardous-waste/perchlorate".

Manual Revision: Rev. 1.1
Release Date: May 18, 2007

Unless you request and receive written permission from SUPER MICRO COMPUTER, you may not copy any part of this document.

Information in this document is subject to change without notice. Other products and companies referred to herein are trademarks or registered trademarks of their respective companies or mark holders.

Copyright © 2007 by SUPER MICRO COMPUTER INC.
All rights reserved.

Printed in the United States of America

Preface

About This Manual

This manual is written for system integrators, PC technicians and knowledgeable PC users. It provides information for the installation and use of the SUPER[®] PDSLA/PDSLE motherboard. The PDSLA/PDSLE supports single Intel Pentium[®] D/Pentium[®] 4/Celeron Processor in the 775-Land Grid Array Package at a system bus speed of 1066/800/533 MHz. The Intel Pentium[®] D/Pentium[®] 4/Celeron Processor in the 775-Land Grid Array Package is housed in a Flip-Chip Land Grid Array (FC-LGA4) package that interfaces with the motherboard via an LGA775 socket. The package consists of a processor core mounted on a substrate land-carrier. An integrated heat spreader (IHS) is attached to the package substrate and core and serves as the contacting surface for processor component thermal solutions, such as a heatsink. Please refer to the motherboard specifications pages on our web site (http://www.supermicro.com/Product_page/product-m.htm) for updates on supported processors. This product is intended to be professionally installed.

Manual Organization

Chapter 1 includes a checklist of what should be included in your mainboard box, describes the features, specifications and performance of the PDSLA/PDSLE mainboard and provides detailed information about the chipset.

Chapter 2 begins with instructions on handling static-sensitive devices. Read this chapter when installing the processor and DDR 2 memory modules and when mounting the mainboard in the chassis. Also refer to this chapter to connect the floppy and hard disk drives, the IDE interfaces, the parallel and serial ports, the mouse and keyboard and the twisted wires for the power supply, the reset button, the keylock/power LED and the speaker.

If you encounter any problems, see **Chapter 3**, which describes troubleshooting procedures for the video, the memory and the setup configuration stored in CMOS. For quick reference, a general FAQ (Frequently Asked Questions) section is provided. Instructions are also included for contacting technical support. In addition, you can visit our web site at www.supermicro.com/techsupport.htm for more detailed information.

Chapter 4 includes an introduction to BIOS and provides detailed information on running the CMOS Setup utility.

Appendix A provides BIOS POST Messages.

Appendix B lists BIOS POST Codes.

Table of Contents

Preface

About This Manual	iii
Manual Organization	iii

Chapter 1: Introduction

1-1 Overview	1-1
Checklist	1-1
Contacting Supermicro	1-2
SUPER [®] PDSLA/PDSLE Image	1-3
SUPER [®] PDSLA/PDSLE Layout	1-4
SUPER [®] PDSLA/PDSLE Quick Reference	1-5
The Intel 945G/P Chipset: System Block Diagram.....	1-6
Motherboard Features	1-7
1-2 Chipset Overview	1-9
1-3 PC Health Monitoring	1-10
1-4 Power Configuration Settings	1-11
1-5 Power Supply	1-12
1-6 Super I/O	1-13

Chapter 2: Installation

2-1 Static-Sensitive Devices	2-1
2-2 Processor and Heatsink Installation	2-2
2-3 Mounting the Motherboard in the Chassis	2-5
2-4 Installing DDR 2 Memory	2-6
2-5 I/O Port/Front Control Panel Connector Locations	2-7
2-6 Connecting Cables	2-8
Power Supply Connectors	2-8
Power On Connector	2-9
Reset Connector	2-9
Overheat/Fan Fail LED	2-10
NIC1 LED Connector	2-10
HDD LED.....	2-11
Power_LED Connector.....	2-11
Serial Ports	2-12
CD Header/Aux Audio Header	2-12

FP Audio	2-13
Ethernet Port	2-13
Fan Headers.....	2-14
Chassis Intrusion.....	2-14
ATX PS/2 Keyboard/Mouse Ports	2-15
Universal Serial Bus (USB).....	2-15
Wake-On-Ring	2-16
Wake-On-LAN	2-16
VGA Connector	2-17
AC'97 Output.....	2-17
2-7 Jumper Settings	2-18
Explanation of Jumpers	2-18
CMOS Clear	2-18
USB Wake-Up	2-19
Watch Dog Enable/Disable	2-20
Gigabit LAN Enable.....	2-20
SMBus to PCI/PCI-Express Slots	2-21
Speaker Connector	2-21
CPU Front Side Bus Speed	2-22
2-8 Onboard LED Indicators	2-23
GLAN LEDs	2-23
Power LED.....	2-23
2-9 Parallel Port, Floppy/Hard Drive and Audio Connections	2-24
Parallel Port Connector	2-24
Floppy Connector	2-25
IDE Connector	2-25
2-10 Installing the Operating System and Software Programs	2-26
 Chapter 3: Troubleshooting	
3-1 Troubleshooting Procedures	3-1
Before Power On.....	3-1
No Power.....	3-1
No Video	3-1
Memory Errors.....	3-2
Losing the System's Setup Configuration	3-2
3-2 Technical Support Procedures	3-2
3-3 Frequently Asked Questions	3-3
3-4 Returning Merchandise for Service	3-5

Chapter 4: BIOS

4-1	Introduction	4-1
4-2	Running Setup	4-2
4-3	Main BIOS Setup	4-2
	Main BIOS Setup Menu	4-3
4-4	Advanced BIOS Setup.....	4-5
	4-4.1 Advanced BIOS Features	4-5
	4-4.2 Advanced Chipset Control	4-6
	4-4.3 I/O Device Configuration.....	4-8
	4-4.4 PnP Configuration	4-10
	4-4.5 Hardware Monitors.....	4-11
	4-4.6 Processor & Clock Options.....	4-11
4-5	Security	4-12
4-6	Boot	4-13
4-7	Exit	4-15

Appendices:

Appendix A: BIOS POST Messages	A-1
Appendix B: BIOS POST Codes.....	B-1

Chapter 1

Introduction

1-1 Overview

Checklist

Congratulations on purchasing your computer motherboard from an acknowledged leader in the industry. Supermicro boards are designed with the utmost attention to detail to provide you with the highest standards in quality and performance.

Please check that the following items have all been included with your motherboard. If anything listed here is damaged or missing, contact your retailer.

All Included in the retail box only

One (1) Supermicro Mainboard

Two (2) SATA cables

One (1) IDE cable

One (1) floppy drive ribbon cable

One (1) I/O shield

One (1) Supermicro CD containing drivers and utilities

One (1) User's/BIOS Manual

Contacting Supermicro

Headquarters

Address: SuperMicro Computer, Inc.
980 Rock Ave.
San Jose, CA 95131 U.S.A.

Tel: +1 (408) 503-8000

Fax: +1 (408) 503-8008

Email: marketing@supermicro.com (General Information)
support@supermicro.com (Technical Support)

Web Site: www.supermicro.com

Europe

Address: SuperMicro Computer B.V.
Het Sterrenbeeld 28, 5215 ML
's-Hertogenbosch, The Netherlands

Tel: +31 (0) 73-6400390

Fax: +31 (0) 73-6416525

Email: sales@supermicro.nl (General Information)
support@supermicro.nl (Technical Support)
rma@supermicro.nl (Customer Support)

Asia-Pacific

Address: SuperMicro, Taiwan
4F, No. 232-1 Liancheng Road
Chung-Ho 235, Taipei Hsien, Taiwan, R.O.C.

Tel: +886-(2) 8226-3990

Fax: +886-(2) 8226-3991

Web Site: www.supermicro.com.tw

Technical Support:

Email: support@supermicro.com.tw

Tel: 886-2-8228-1366, ext.132 or 139

Figure 1-1. SUPER[®]PDSL/PSLE Image

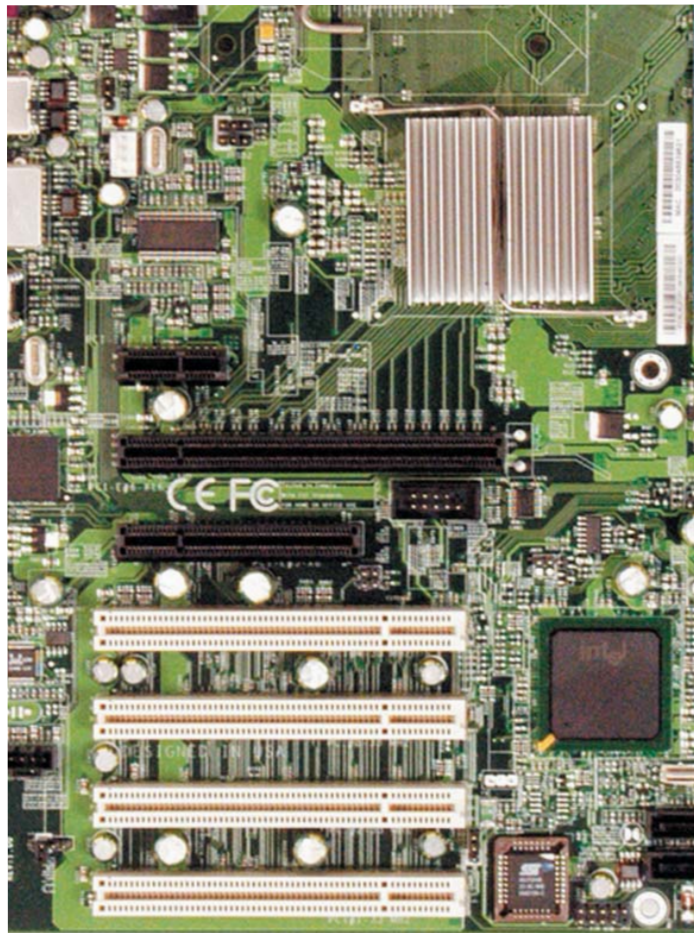

An Important Note to the User

- All images and layouts shown in this manual are based upon the latest PCB Revision available at the time of publishing of this manual. The motherboard you've received may or may not look exactly the same as the ones shown in this manual.

Figure 1-3. Motherboard Layout
(not drawn to scale)

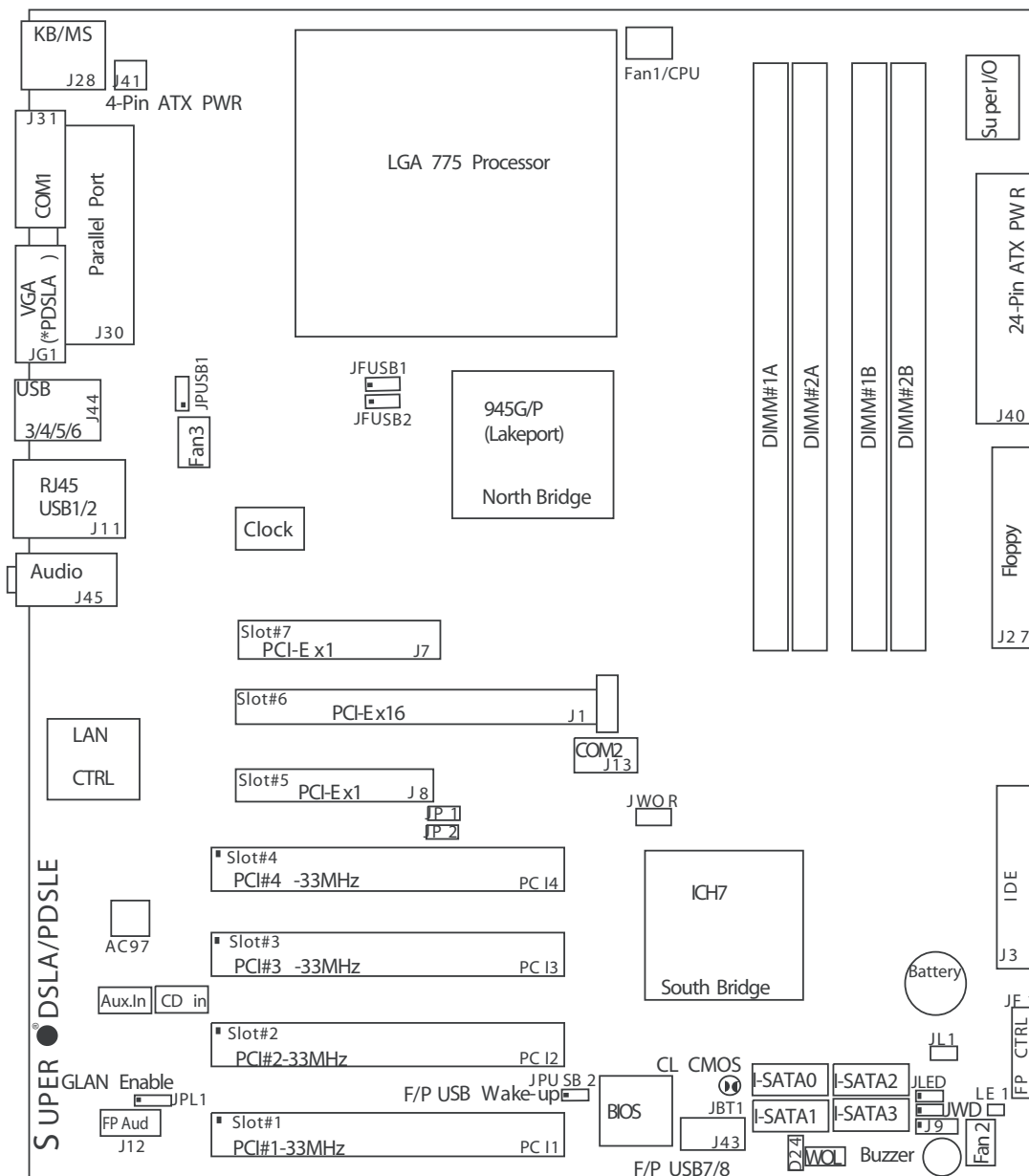

Important Notes to the User

- All images and layouts shown in this manual were based upon the latest PCB Revision available at the time of publishing of the manual. The motherboard you've received may or may not look exactly the same as the ones shown in this manual.
- See Chapter 2 for detailed information on jumpers, I/O ports and JF1 front panel connections.
- "■" indicates the location of "Pin 1".
- The only difference between the PDSLA and PDSLE is that the PDSLA has Internal VGA.

PDSLA/PDSLE Quick Reference

Jumpers	Description	Default Setting
J9	Buzzer/Speaker Enable	Pins 3-4 (Enabled)
JBT1	CMOS Clear	(*See Chapter 2)
JFSB1/JFSB2	CPU Frequency	Pins 1-2/Pins 1-2 (Auto)
JP1/JP2	PCI/PCI-E SMB	Open/Open (Disabled)
JPL1	Giga-bit LAN Enable	Pins 1-2 (Enabled)
JPUSB1	B/P USB Wake Up	Pins 2-3 (Disabled)
JPUSB2	F/P USB Wake Up	Pins 2-3 (Disabled)
JWD	Watch Dog	Pins 1-2 (Reset)

Connectors	Description
ATX PWR (J40)	ATX 24-Pin Power Connector
4-Pin ATX PWR (J41)	12V 4-pin Power Connector (*required)
Audio (J45)	Audio Port
AUX-In (AUX1)	Auxiliary (Audio) Input Header
CD-In (CD1)	Audio CD Input Header
Chassis Intrusion(JL1)	Chassis Intrusion Header
COM1 (J31), COM2 (J13)	COM Port/Serial Port 1 & Port 2 Connectors
DIMM#1A,#2A,#1B,#2B	Memory (DIMM) Slots (1 through 4)
Fans 1-3	Fan1: CPU Fan, Fan2/3: Chassis Fan Headers
Floppy (J27)	Floppy Disk Connector
FP Audio (J12)	Front Panel Audio Connector (*See Chapter 2)
FP Control Panel (JF1)	Front Control Panel Header
LAN Port (J11)	Ethernet RJ45 (Gigabit LAN) Connector
IDE (J3)	IDE Connector
I-SATA #0-3 (J2,J4,J5,J6)	Intel SATA (#0-3) Headers
KB/Mouse (J28)	PS/2 Keyboard/Mouse
LE1	Standby Warning LED Indicator
PWR LED (JLED)	Power LED Indicator
Printer (J30)	Parallel Printer Port
Slot 1-Slot 4	PCI 33 MHz (PCI #1-#4)
Slot 5	PCI-Express x1 (using x 8 slot)
Slot 6	PCI-Express x16
Slot 7	PCI-Express x1
Speaker (J9)	Speaker Header
USB 1/2 (J11)	(Back Panel) Universal Serial Ports 1-2
USB 3/4/5/6 (J44)	(Back Panel) Universal Serial Ports 3-6
USB 7/8 (J43)	(Front Panel) USB ports 7/8
VGA (JG1)	Video/Graphic Connector (*For PDSLA only)
WOL (WOL)	Wake-On-LAN Header
WOR(JWOR)	Wake-On-Ring Header

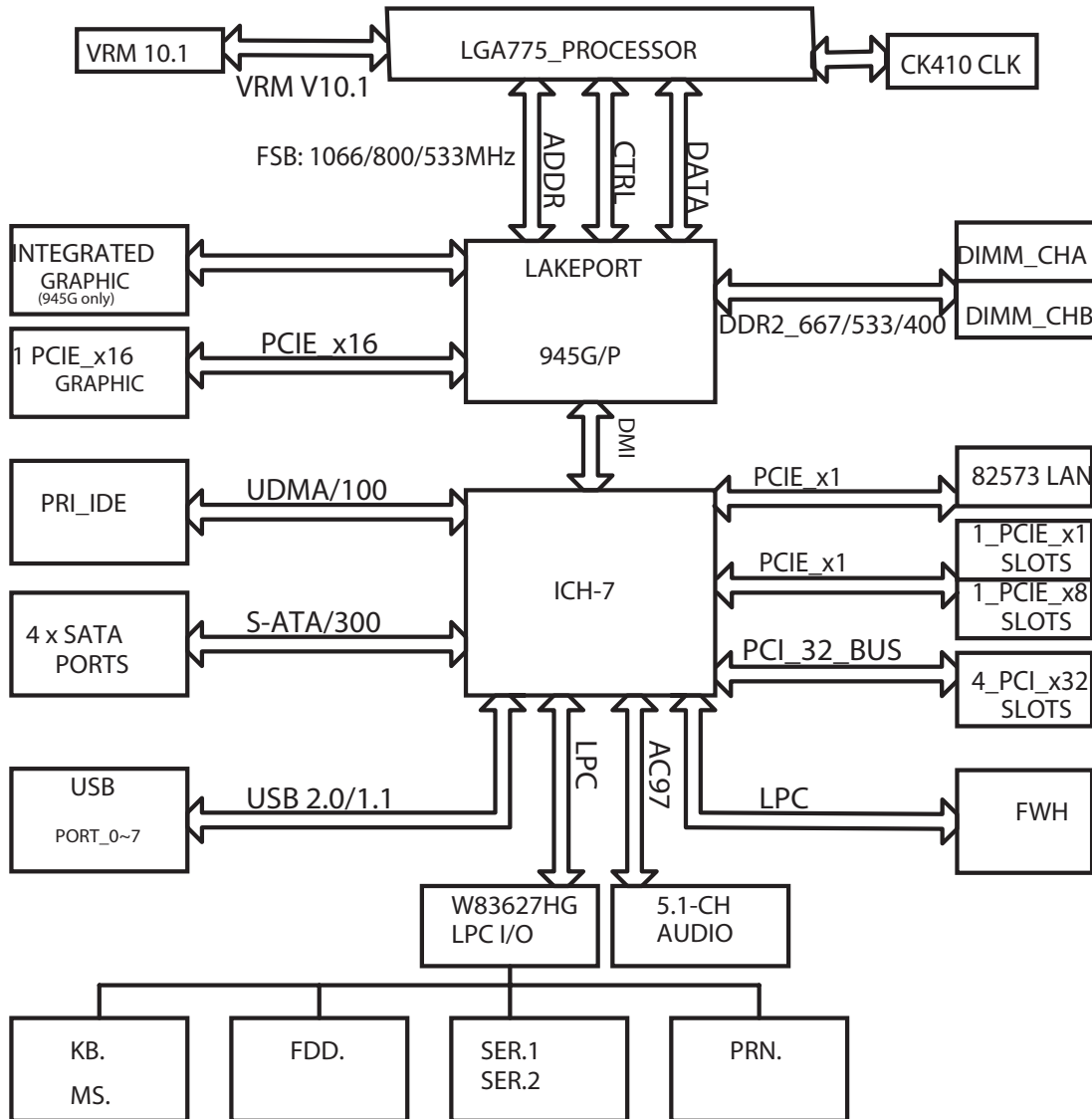

**Figure 1-3. 945G/P Lakeport Chipset:
System Block Diagram**

Note: This is a general block diagram and may not exactly represent the features on your motherboard. See the following pages for the actual specifications of each motherboard.

Motherboard Features

CPU ♦ *Latest CPU technology!*

- Single Intel Pentium® D/Pentium® 4/Celeron Dual Core in the 775-Land Grid Array Package at a system bus speed of 1066/800/533 MHz.
- Supports Intel Hyper-Threading Technology.

Memory ♦ *Latest memory technology!*

- Supports unbuffered, non-ECC single or dual channel DDR2 with the bandwidth up to 5.3GB/s (DDR2 667) for single channel mode and 10.7 GB/s (DDR2 667) in dual-channel Interleaved mode. **Note: See Section 2-4 for details.**

Chipset ♦ *Latest Intel chipset technology!*

- Intel Lakeport 945G/P chipset

Expansion Slots

- One (1) PCI-Express x16 (intended for graphics)
- One (1) PCI-Express x8 (PCI-Express x1 Signal)
- One (1) PCI-Express x1
- Four (4) 32-bit PCI 33MHz (5V)

BIOS

- 4 Mb Firmware Hub AwardBIOS® Flash BIOS
- APM 1.2, DMI 2.3, PCI 2.2, ACPI 1.0, Plug and Play (PnP)

PC Health Monitoring

- Onboard voltage monitors for Chipset Core +1.5V, CPU core, +3.3V, +3.3V standby, +5V, +5V Standby, Vbat (battery voltage) and ±12V
- Fan status monitor with firmware 4 pin fan speed control
- Fan Fail Alert LED and Beep
- SuperDoctor III, Watch Dog, NMI
- Environmental temperature monitoring via BIOS
- Power-up mode control for recovery from AC power loss
- System overheat LED and control
- System resource alert via Supero Doctor III
- Auto-switching voltage regulator for the CPU core

ACPI Features

- Microsoft OnNow
- Slow blinking LED for suspend state indicator
- BIOS support for USB keyboard
- Main switch override mechanism
- Internal/external modem ring-on

Onboard I/O

- 1 ATA/100 EIDE Channels for a total of two IDE devices backward compatible
- Built in ICH7 SATA Controller, 4 connectors for 4 devices (300MB/S)
- 1 floppy port interface (up to 2.88 MB)
- 2 Fast UART 16550 compatible serial ports
- Intel 82573V Gigabit Ethernet Controller
- 1 EPP (Enhanced Parallel Port) and ECP (Extended Capabilities Port) supported parallel port
- PS/2 mouse and PS/2 keyboard ports
- Up to 8 USB (Universal Serial Bus) 2.0 ports for a speed of up to 480Mbps
 - ◆ *Latest USB 2.0 technology!*
- AC'97 audio high quality 6-channel sound
- Integrated gfx core graphics on board (*PDSLA Only)

Other

- Wake-on-LAN
- Wake-on-Ring (WOR)
- System Bus Clock Frequency Selection (Overclocking) Support (*Note)
- Suspend-to-RAM
- Onboard +5V Standby Power Warning LED ("LE1")
- Pb Free

CD Utilities

- BIOS flash upgrade utility
- Drivers and software for Intel 945G/P chipset utilities

Dimensions

- ATX form factor, 11.5" x 9.5" (292 x 242 mm)



Note: Please be aware of the following conditions when "overclocking" is used:

Setting a high CPU FSB Speed (overclocking), DRAM Frequency or selecting a high CPU V-Core voltage, memory voltage, chip-set voltage, ICH chipset voltage, and FSB termination voltage may result in system instability. If this occurs, revert to the default setting. In addition, extra fans may be needed for proper system cooling. The PDSLA/PDSLE offers the option of "overclocking"; however, Supermicro is not responsible for any damage caused by use of overclocking.

1-2 Chipset Overview

Intel's Lakeport (945G/P) chipset consists of two primary components: the Graphics Memory Controller Hub (GMCH)/Memory Controller Hub (MCH) and the I/O Controller Hub (ICH7). Optimized for the Celeron, Pentium 4, Pentium D processors in an LGA775 Package, the Lakeport (945G/P) provides the performance and feature-set required for high-end UP dual core processor desktop solutions.

Graphics Memory Controller Hub (GMCH)/Memory Controller Hub (GMCH)

The GMCH/MCH supports high-performance integrated graphics and manage the data flow of the following five interfaces: the CPU interface, DDR2 interface, PCI Express Graphic Interface, the DMI (Direct Media Interface) and integrated graphics with display interfaces (*GMCH only) . The GMCH/MCH supports a FSB frequency of 533/800/1066 MHz using a scalable CPU. It supports up to two channels of non-ECC DDR2 400/533/667 SDRAM. The integrated Graphics Controller provides 3D, 2D and display capabilities. The GMCH/MCH also supports advanced desktop power management.

Intel ICH7 System Features

The ICH7 provides extensive I/O support to a high-end 945G/P system. Functions and capabilities include:

- *PCI Express Base Specification, Rev. 1.0a-compliant
- *PCI 2.3 with support for 33 MHz PCI operations
- *ACPI Power Management Logic Support
- *Integrated Serial ATA host controller with independent DMA operation on four ports, (with support of SATA I and SATA II HDD)
- *Integrated IDE controller supports Ultra ATA 100/66/33
- *USB host interface with support for eight USB ports
- *Enhanced DMA Controller, interrupt controller, and timer functions
- *System Management Bus (SMBus) 2.0 with additional support for I²C devices
- *Low Pin Count (LPC) Interface
- *Firmware Hub (FWH) Interface
- *Audio Codec '97 Rev. 2.3 which provides a link for Audio (up to 6 channels)

1-3 PC Health Monitoring

This section describes the PC health monitoring features of the PDSLA/PDSLE. The motherboard has an onboard System Hardware Monitor chip that supports PC health monitoring.

Onboard Voltage Monitors for the CPU Core, Chipset Core +1.5V, +3.3V, +3.3V standby, +5V, +5V Standby, Vbat and ±12V

The onboard voltage monitor will scan these voltages continuously. Once a voltage becomes unstable, it will give a warning or send an error message to the screen. Users can adjust the voltage thresholds to define the sensitivity of the voltage monitor by using SD III.

Fan Status Monitor with Software

The PC health monitor can check the RPM status of the cooling fans via Supero Doctor III.

Fan Fail Alert

When a fan fails during the normal operation, the Fan Fail LED will start to blink and the buzzer will be activated to indicate a fan failure.

CPU Overheat LED and Control

This feature is available when the user enables the CPU overheat warning function in the BIOS. This allows the user to define an overheat temperature. When this temperature reaches the pre-defined threshold, the CPU thermal trip feature will be activated and it will send a signal to the Speaker LED and, at the same time, the CPU speed will be decreased.

1-4 Power Configuration Settings

This section describes features of your motherboard that deal with power and power settings.

Slow Blinking LED for Suspend-State Indicator

When the CPU goes into a suspend state, the chassis power LED will start blinking to indicate that the CPU is in suspend mode. When the user presses any key, the CPU will wake-up and the LED will automatically stop blinking and remain on.

BIOS Support for USB Keyboard

If the USB keyboard is the only keyboard in the system, it keyboard will function like a normal keyboard during system boot-up.

Main Switch Override Mechanism

When an ATX power supply is used, the power button can function as a system suspend button. When the user presses the power button, the system will enter a SoftOff state. The monitor will be suspended and the hard drive will spin down. Pressing the power button again will cause the whole system to wake-up. During the SoftOff state, the ATX power supply provides power to keep the required circuitry in the system alive. In case the system malfunctions and you want to turn off the power, just press and hold the power button for 4 seconds. The power will turn off and no power will be provided to the motherboard.

Wake-On-Ring (WOR) Header

Wake-up events can be triggered by a device such as the external modem ringing when the system is in the SoftOff state. Note that external modem ring-on can only be used with an ATX 2.01 (or above) compliant power supply.

1-5 Power Supply

As with all computer products, a stable power source is necessary for proper and reliable operation. It is even more important for processors that have high CPU clock rates of 1 GHz and faster.

The SUPER[®]PDSLA/PDSLE accommodates 12V ATX power supplies. Although most power supplies generally meet the specifications required by the CPU, some are inadequate. A 2-Amp of current supply on a 5V Standby rail is strongly recommended.

It is strongly recommended that you use a high quality power supply that meets 12V ATX power supply Specification 1.1 or above. It is also required that the 12V 4-pin power connection (J41) be used for high-load configurations. In areas where noisy power transmission is present, you may choose to install a line filter to shield the computer from noise. It is recommended that you also install a power surge protector to help avoid problems caused by power surges.

1-6 Super I/O

The disk drive adapter functions of the Super I/O chip include a floppy disk drive controller that is compatible with industry standard 82077/765, a data separator, write pre-compensation circuitry, decode logic, data rate selection, a clock generator, drive interface control logic and interrupt and DMA logic. The wide range of functions integrated onto the Super I/O greatly reduces the number of components required for interfacing with floppy disk drives. The Super I/O supports two 360 K, 720 K, 1.2 M, 1.44 M or 2.88 M disk drives and data transfer rates of 250 Kb/s, 500 Kb/s or 1 Mb/s.

It also provides two high-speed, 16550 compatible serial communication ports (UARTs), one of which supports serial infrared communication. Each UART includes a 16-byte send/receive FIFO, a programmable baud rate generator, complete modem control capability and a processor interrupt system. Both UARTs provide legacy speed with baud rate of up to 115.2 Kbps as well as an advanced speed with baud rates of 250 K, 500 K, or 1 Mb/s, which support higher speed modems.

The Super I/O provides functions that comply with ACPI (Advanced Configuration and Power Interface), which includes support of legacy and ACPI power management through a SMI or SCI function pin. It also features auto power management to reduce power consumption.

The IRQs, DMAs and I/O space resources of the Super I/O can be flexibly adjusted to meet ISA PnP requirements, which support ACPI and APM (Advanced Power Management).

Notes

Chapter 2

Installation

2-1 Static-Sensitive Devices

Electric Static Discharge (ESD) can damage electronic components. To prevent damage to your system board, it is important to handle it very carefully. The following measures are generally sufficient to protect your equipment from ESD.

Precautions

- Use a grounded wrist strap designed to prevent static discharge.
- Touch a grounded metal object before removing the board from the antistatic bag.
- Handle the board by its edges only; do not touch its components, peripheral chips, memory modules or gold contacts.
- When handling chips or modules, avoid touching their pins.
- Put the motherboard and peripherals back into their antistatic bags when not in use.
- For grounding purposes, make sure your computer chassis provides excellent conductivity between the power supply, the case, the mounting fasteners and the motherboard.
- Use only the correct type of CMOS onboard battery as specified by the Manufacturer. Do not install the CMOS onboard battery upside down to avoid a possible explosion.

Unpacking

The motherboard is shipped in antistatic packaging to avoid static damage. When unpacking the board, make sure the person handling it is static protected.

Installation Procedures

Follow the procedures as listed below for full installation of the motherboard into a chassis:

1. Install the processor and the heatsink to the motherboard.
2. Install the motherboard in the chassis.
3. Install the memory and add-on cards.
4. Finally, connect the cables and install the drivers.

2-2 Processor and Heatsink Installation



When handling the processor package, avoid placing direct pressure on the label area of the fan.

(*Note: The CPU heatsink is included in Intel's CPU retail package.)

Installation of the LGA775 Processor

IMPORTANT: Always connect the power cord last and always remove it before adding, removing or changing any hardware components. Make sure that you install the processor into the CPU socket before you install the CPU heatsink.

1. Press the socket lever to release the load plate, which covers the CPU socket, from its locking position.

Socket Lever

Load Plate

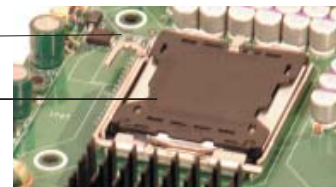

2. Gently lift the socket lever to open the load plate.

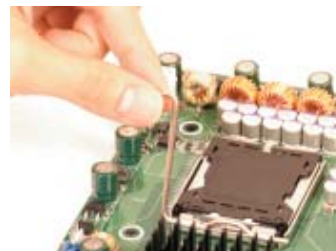

Load Plate

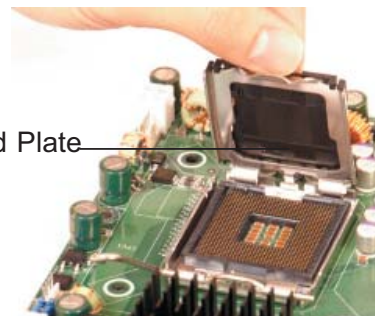

3. Locate Pin 1 on the CPU socket. (*Note: Pin 1 is the corner marked with a triangle). Please note that the North Key and the South Key are located vertically in the CPU housing.

4. Position the motherboard in such a way that Pin 1 of the CPU socket is located at the left bottom of the CPU housing.

5. Use your thumb and your index finger to hold the CPU at the North Center Edge and the South Center Edge of the CPU.

6. Align Pin 1 of the CPU with Pin 1 of the socket. Once aligned, carefully lower the CPU straight down to the socket. (**Do not drop the CPU on the socket. Do not move the CPU horizontally or vertically. Do not rub the CPU against the surface or against any pins of the socket to avoid damage to the CPU or the socket.)

7. With the CPU inside the socket, inspect the four corners of the CPU to make sure that the CPU is properly installed.

8. Use your thumb to gently push the lever down and lock it in the hook.

9. If the CPU is properly installed into the socket, the plastic cap will be automatically released from the load plate when the lever is pushed into the hook. Remove the plastic cap from the motherboard.

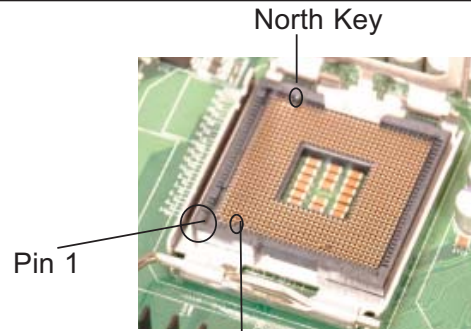

South Center Edge



CPU in the CPU socket

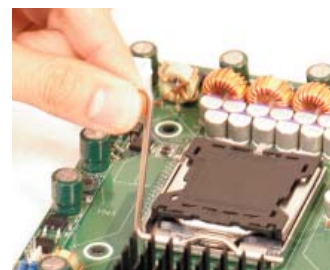

Plastic cap is released from the load plate if CPU properly installed.



Installation of the Heatsink

1. Locate the CPU Fan on the motherboard. (Refer to the layout on Page 1-4 for the CPU Fan location.)
2. Position the heatsink in such a way that the heatsink fan wires are closest to the CPU fan and are not interfered with other components
3. Inspect the CPU Fan wires to make sure that the wires are routed through the bottom of the heatsink.
4. Remove the thin layer of the protective film from the copper core of the heatsink.

(*Warning: CPU overheat may occur if the protective film is not removed from the heatsink.)

5. Apply the proper amount of thermal grease on the CPU. (*Note: if your heatsink came with a thermal pad, please ignore this step.)

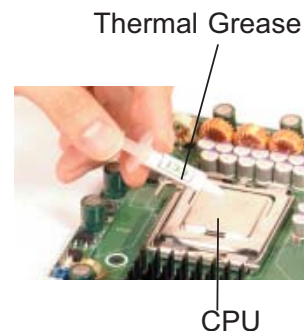

6. If necessary, rearrange the wires to make sure that the wires are not pinched between the heatsink and the CPU. Also make sure to keep clearance between the fan wires and the fins of the heatsink.

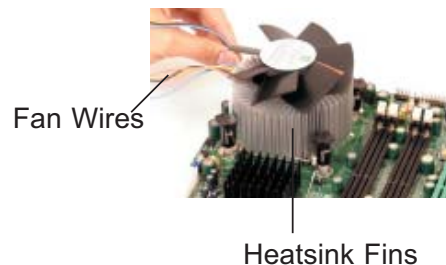

7. Align the four heatsink fasteners with the mounting holes on the motherboard. Gently push the fasteners into the mounting holes until you hear a "click".



8. Repeat Step 6 to insert all four heatsink fasteners into the mounting holes.
9. Once all four fasteners are securely inserted into the mounting holes and the heatsink is properly installed on the motherboard, connect the heatsink fan wires to the CPU Fan connector.

Heatsink Removal

1. Unplug the power cord from the power supply.
2. Disconnect the heatsink fan wires from the CPU fan header.
3. Use your finger tips to gently press on the fastener cap and rotate counterclockwise to make a 1/4 (90°) turn.
4. Repeat Step 3 to loosen all fasteners from the mounting holes.
5. With all fasteners loosened, remove the heatsink from the CPU.



2-3 Mounting the Motherboard in the Chassis

All motherboards have standard mounting holes to fit different types of chassis. Make sure that the locations of all the mounting holes for both the motherboard and the chassis match. Although a chassis may have both plastic and metal mounting fasteners, metal ones are highly recommended because they ground the motherboard to the chassis. Make sure the metal standoffs click in or are screwed in tightly. Then use a screwdriver to secure the motherboard onto the motherboard tray. Since some components are located very close to the mounting holes, please take precautionary measures needed to prevent the components from being damaged when you install the motherboard into the chassis. (*Note: some components are very close to the mounting holes, please take all precautionary measures to prevent damage done the these components when mounting the motherboard to the chassis.)

2-4 Installing DDR2 Memory

CAUTION

Exercise extreme care when installing or removing memory modules to prevent any possible damage.

Memory Module Installation (See Figure 2-2)

1. Insert each DDR2 memory module vertically into its slot. Pay attention to the notch along the bottom of the module to prevent inserting the module incorrectly. (See support information below.)
2. Gently press down on the memory module until it snaps into place.

Support

The PDSLA/PDSLE supports Single/Dual channel, unbuffered, non-ECC, DDR2 667/533/400 SDRAM. Populating DIMM#1A, DIMM#1B, and/or DIMM#2A, DIMM#2B with memory modules of the same size/same type will result in the dual channel, two-way interleaved memory which is faster than the single channel, non-interleaved memory.

***Note:** Due to memory allocation to system devices, memory remaining available for operational use will be reduced when 4 GB of RAM is used. The reduction in memory availability is disproportional. (Refer to the Memory Availability Table below for details.)

Possible System Memory Allocation & Availability		
System Device	Size	Physical Memory Remaining (-Available) (4 GB Total System Memory)
Firmware Hub flash memory (System BIOS)	1 MB	3.99
Local APIC	4 KB	3.99
Area Reserved for the chipset	2 MB	3.99
I/O APIC (4 Kbytes)	4 KB	3.99
PCI Enumeration Area 1	256 MB	3.76
PCI Express (256 MB)	256 MB	3.51
PCI Enumeration Area 2 (if needed) -Aligned on 256-MB boundary-	512 MB	3.01
VGA Memory	16 MB	2.85
TSEG	1 MB	2.84
Memory available to System & OS applications		2.84

Figure 2-2. Side and Top Views of DDR2 Module Installation into Slot

To Install:

Insert module vertically and press down until it snaps into place. Pay attention to the notch.

To Remove:

Use your thumbs gently to push each release tab outward to release the DIMM from the slot.

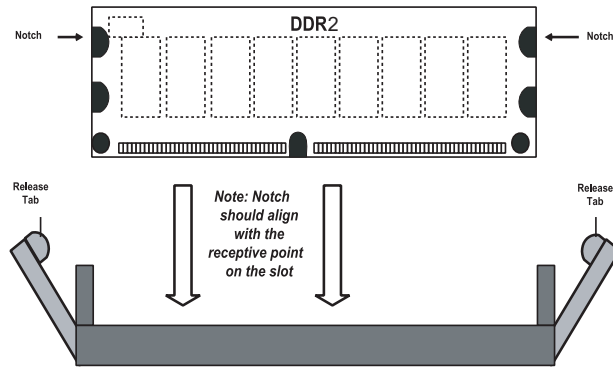

2-5 I/O Port/Control Panel Connector Locations

The I/O ports are color coded in conformance with the PC99 specification to make setting up your system easier. See Figure 2-3 below for the colors and locations of the various IO ports.

Figure 2-3. I/O Port Locations and Definitions

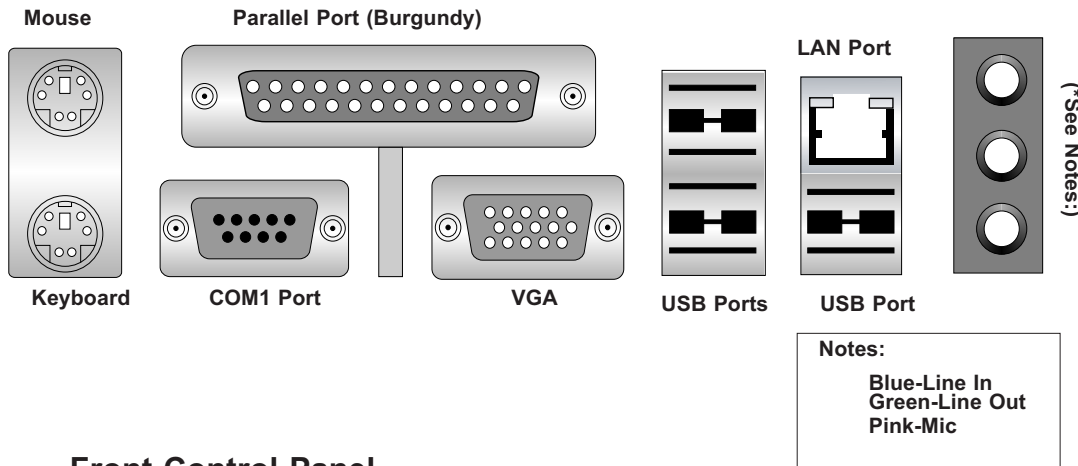

Front Control Panel

JF1 contains header pins for various front control panel connectors. See Figure 2-4 for the pin definitions of the various connectors including the speaker. Refer to Section 2-6 for details.

Figure 2-4. Front Control Panel Connectors (JF1)

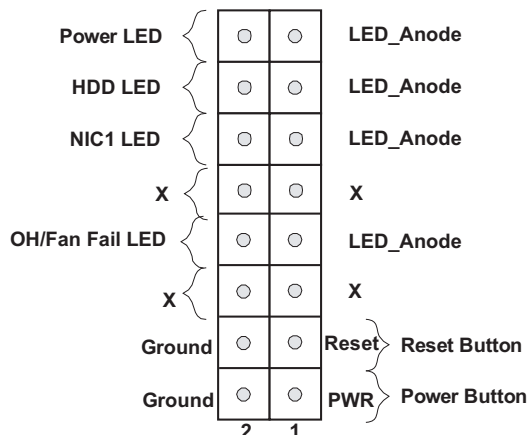

2-6 Connecting Cables

Power Supply Connectors

The primary power supply connector(J40) on the PDSLA/PDSLE meets the SSI (Superset ATX) 24-pin specification. Refer to the table on the right for the pin definitions of the ATX 24-pin power connector. You must also connect the 4-pin (J41) processor power connector to your power supply. Refer to the table below right for the J41 (12V) connector.

**ATX Power Supply 24-pin Connector
Pin Definitions (J20)**

Pin Number	Definition	Pin Number	Definition
13	+3.3V	1	+3.3V
14	-12V	2	+3.3V
15	COM	3	COM
16	PS_ON#	4	+5V
17	COM	5	COM
18	COM	6	+5V
19	COM	7	COM
20	Res(NC)	8	PWR_OK
21	+5V	9	5VSB
22	+5V	10	+12V
23	+5V	11	+12V
24	COM	12	+3.3V

Required Connection

+12V 4-pin Connector (J41)

Pins #	Definition
1 & 2	Ground
3 & 4	+12 V

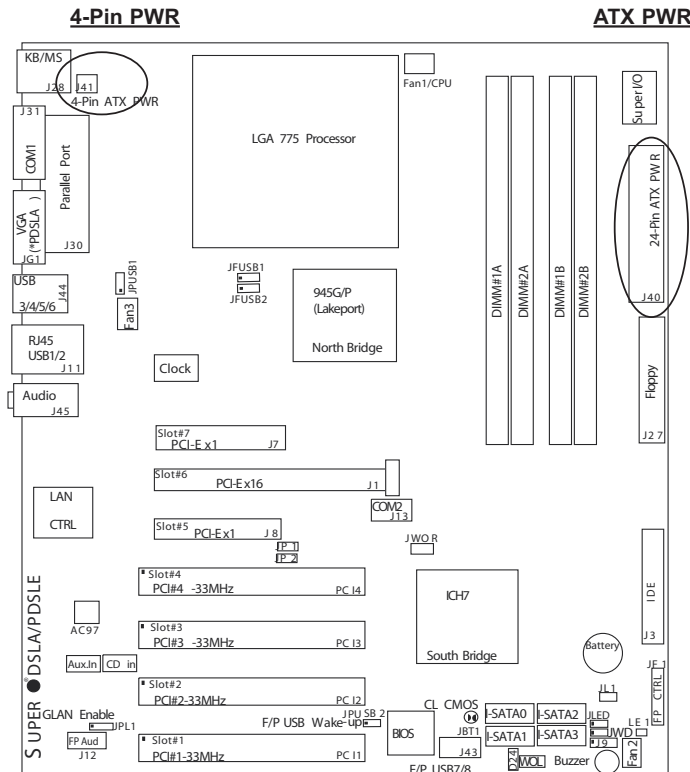

PW_ON Connector

The PW_ON connector is located on pins 1 and 2 of JF1. Connect it to the chassis power button, which you may also configure to put the system into suspend mode (see the Power Button Mode setting in BIOS). To turn off the power when the suspend mode is enabled, press the power button for at least 4 seconds. See the table on the right for pin definitions.

**PW_ON
Pin Definitions
(JF1)**

Pin #	Definition
1	Signal
2	GND

Reset Connector

The reset connector is located on pins 3 and 4 of JF1. This connector attaches to the reset switch on the computer chassis. See the table on the right for pin definitions.

**Reset Pin
Definitions
(JF1)**

Pin Number	Definition
3	Reset
4	Ground

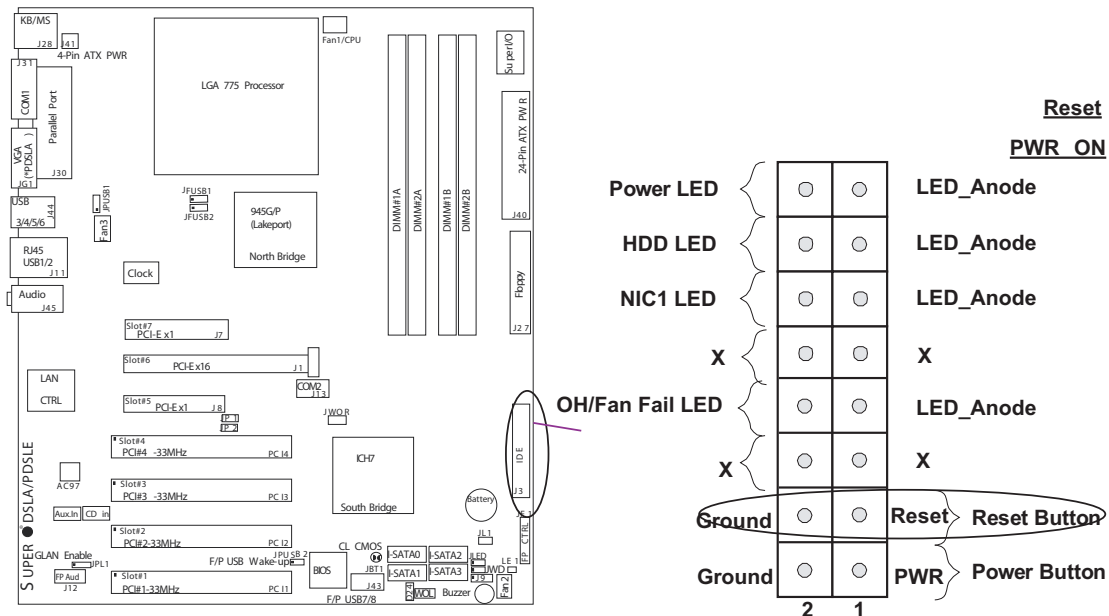

Overheat/FanFail LED

Connect an LED to the OH/Fan Fail connection on pins 7 and 8 of JF1 to provide advanced warning of chassis overheating or system fan failure. Refer to the table on the right for pin definitions.

**Overheat (OH)/
Fan_Fail LED Pin
Definitions
(JF1)**

Pin #	Definition
7	LED_Anode
8	OH/Fan Fail LED Sig.

**OH/Fan Fail LED
(JF1)**

State	Message
Off	Normal
Stay On	Overheat
Blink	Fan Fail

NIC1 LED Indicators

The NIC (Network Interface Controller) LED connections for the GLAN port is located on pins 11 and 12 of JF1. Attach the NIC LED cables to display network activity. Refer to the tables on the right for pin definitions.

**NIC1 LED Pin
Definitions
(JF1)**

Pin#	Definition
11	LED_Anode
12	NIC1 LED Sig.

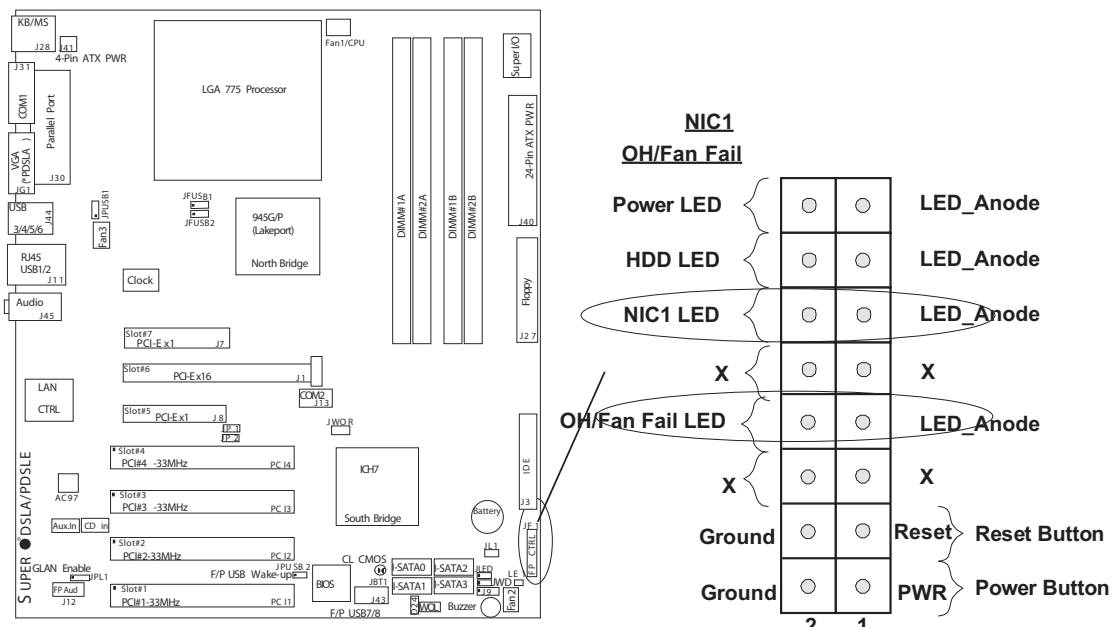

HDD LED

The HDD LED connection is located on pins 13 and 14 of JF1. Attach the hard drive LED cable here to display disk activity (for any hard drives on the system, including SCSI, Serial ATA and IDE). See the table on the right for pin definitions.

HDD LED Pin Definitions (JF1)

Pin Number	Definition
13	LED_Anode
14	HD Active

Power_LED Connector

The Power LED connector is located on pins 15 and 16 of JF1. This connection is used to provide LED indication of power being supplied to the system. See the table on the right for pin definitions.

PWR_LED Pin Definitions (JF1)

Pin Number	Definition
15	LED_Anode
16	PWR LED Sig.

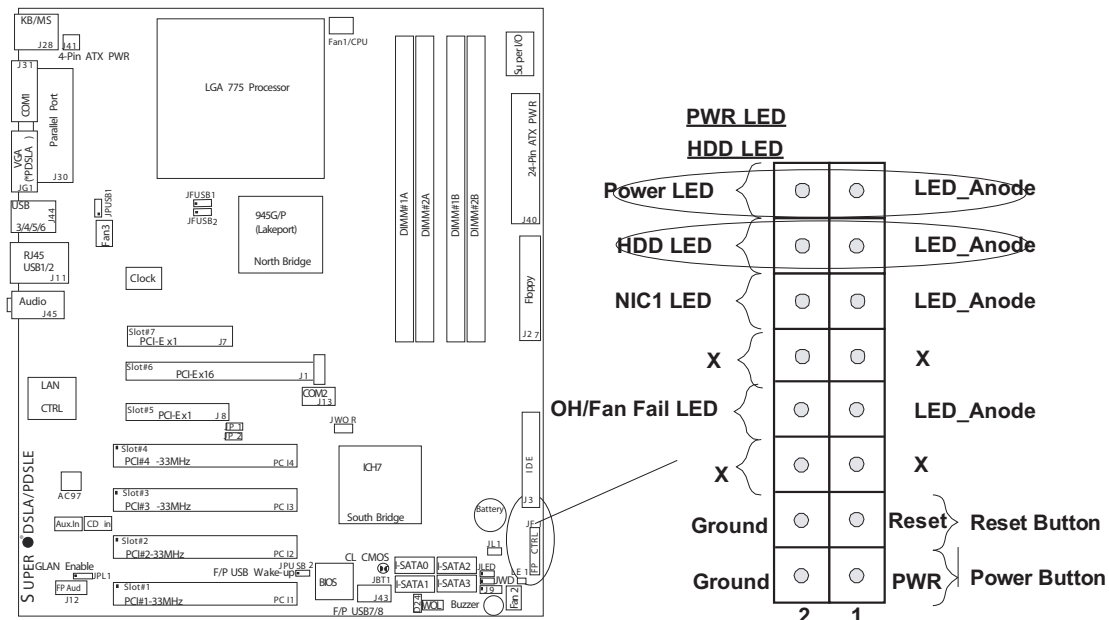

Serial Ports

Two serial ports are included on the motherboard. COM1(J31) is a port located beside the mouse/keyboard ports and COM2(J13) is a header located on the motherboard near PCI-E slot #6. See the table on the right for pin definitions.

*NC indicates no connection.

Serial Port Pin Definitions (COM1)

Pin Number	Definition	Pin Number	Definition
1	CD	6	DSR
2	RD	7	RTS
3	TD	8	CTS
4	DTR	9	RI
5	Ground		

Serial Port Pin Definitions (COM2)

Pin Number	Definition	Pin Number	Definition
1	CD	6	DSR
2	RD	7	RTS
3	TD	8	CTS
4	DTR	9	RI
5	Ground	10	NC

CD Header/Auxiliary Audio Header

There is a 4-pin CD header (CD1) and an Auxiliary header (Aux.1) on the motherboard. These headers allow you to use the onboard sound for audio CD playback. Connect the audio cable from your CD drive to the header that fits your cable's connector. Only one CD header can be used at any one time. See the tables at right for pin definitions.

Audio CD Header Pin Definitions (CD In)

Pin #	Definition
1	Left Stereo Signal
2	Ground
3	Ground
4	Right Stereo Signal

Auxiliary Header Pin Definitions (Aux.)

Pin #	Definition
1	Right Stereo Signal
2	Ground
3	Ground
4	Left Stereo Signal

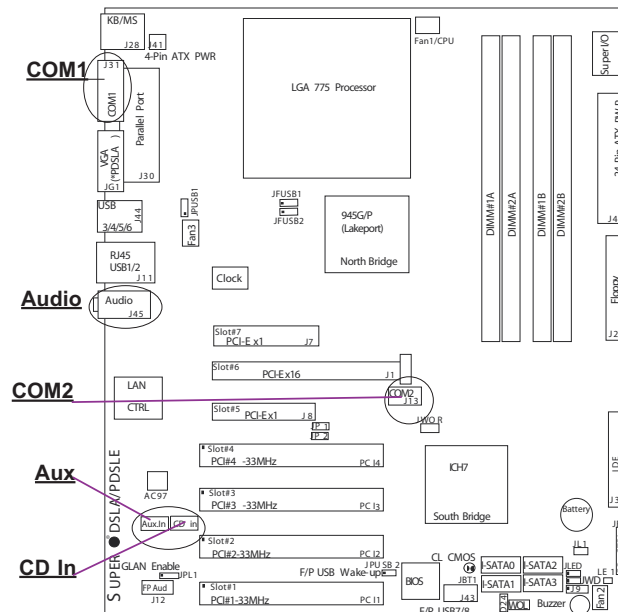

FP Audio

When front panel headphones are plugged in, the back panel audio output is disabled. This is done through the FP Audio header (J12). If the front panel interface card is not connected to the front panel audio header, jumpers should be installed on the header (J12) pin pairs: 1-2, 5-6, and 9-10. If these jumpers are not installed, the back panel line out connector will be disabled and microphone input Pin 1 will be left floating, which can lead to excessive back panel microphone noise and cross talk. See the table below for pin definitions.

AC'97 FP Audio Header Signal Names		
Pin#	Signal	Description
1	MIC	FP microphone input signal
2	AUD_GND	Ground used by analog audio circuits
3	MIC_BIAS	Microphone power
4	AUD_VCC	Analog audio VCC+5V
5	FP_OUT_R	Right channel audio signal to front panel (headphone drive capable)
6	FP_RETURN_R	Right channel audio signal return from front panel (when headphones unplugged)
7	NC	NC (*NC=no connection)
8	Key	No pin
9	FP_OUT_L	Left channel audio signal to front panel (headphone drive capable)
10	FP_RETURN_L	Left channel audio signal return from front panel (when headphones unplugged)

Ethernet Port (RJ45 Connector)



One Ethernet port (Gigabit LAN) is located beside the Audio port on the IO backplane.

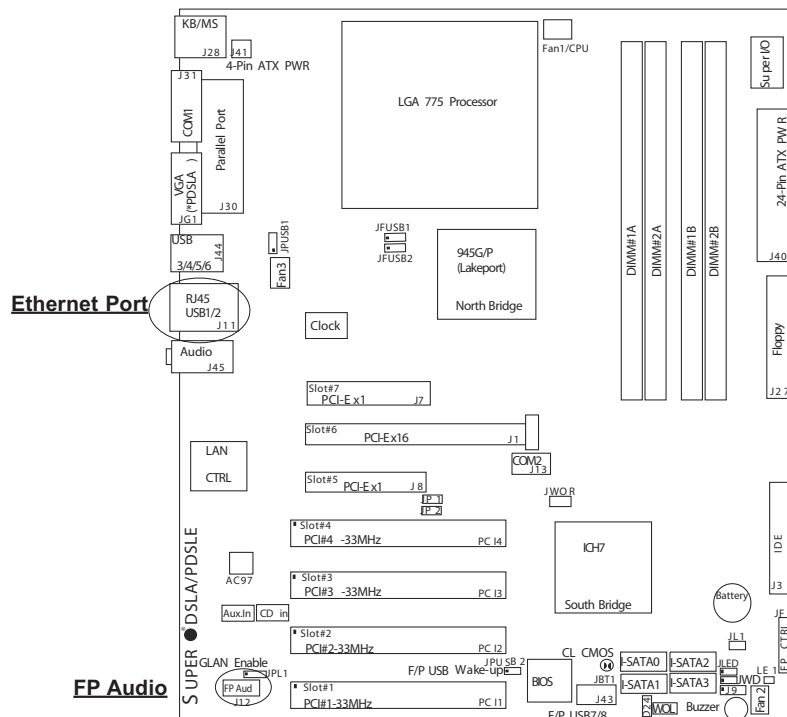

Fan Headers

There are three fan headers (Fan 1, Fan 2 and Fan3) on the PDSLA/PDSLE. (See the table on the right for pin definitions.) These are 4-pin fan headers; however, the traditional 3-wire fans are also supported. (Pins #1-#3 of the fan headers are backward compatible with the traditional 3-pin fans.) When a 3-wire fan is used, it will be set to run at the full speed by default. When a 4-wire fan is used, the CPU and chassis fan speeds will be automatically controlled by the control circuit inside the fan based upon the CPU temperature.

**Fan Header Pin Definitions
(CPU, Chassis and Overheat)**

Pin#	Definition
1	Ground (black)
2	+12V (red)
3	Tachometer
4	PWM_Control

Caution: These fan headers use DC power.

Chassis Intrusion

The Chassis Intrusion header is located at JL1. See the board layout in Chapter 1 for the location of JL1 and the table on the right for pin definitions.

**Chassis Intrusion
Pin Definitions (JL1)**

Pin Number	Definition
1	Intrusion Input
2	Ground

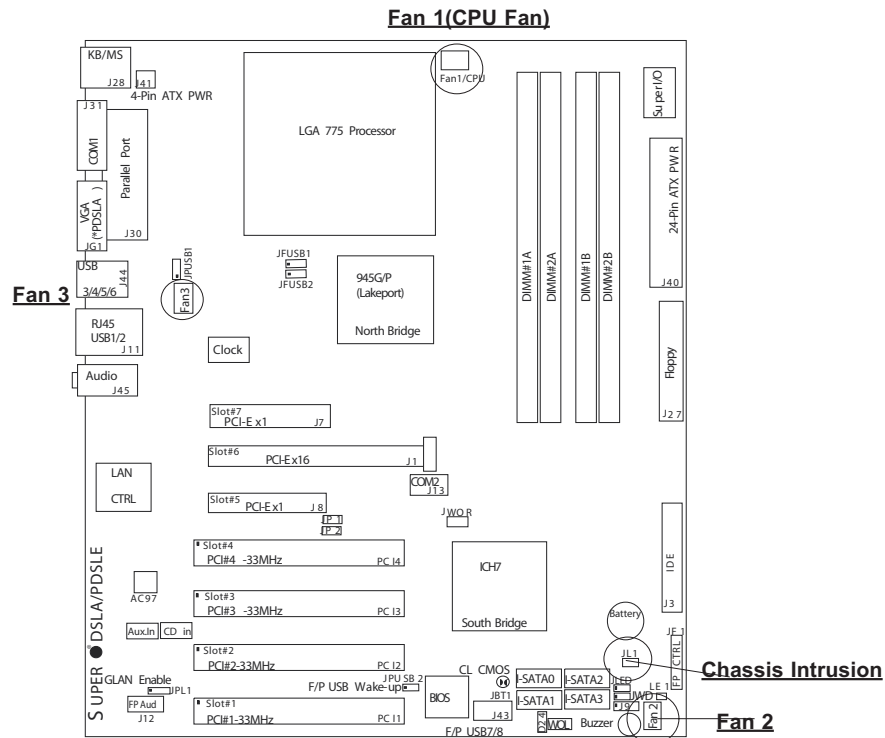

ATX PS/2 Keyboard and PS/2 Mouse Ports

The ATX PS/2 keyboard and the PS/2 mouse are located at J28. See the table on the right for pin definitions. (The mouse port is above the keyboard port. See the table on the right for pin definitions.)

PS/2 Keyboard and Mouse Port Pin Definitions (J28)

Pin Number	Definition
1	Data
2	NC
3	Ground
4	VCC
5	Clock
6	NC

Universal Serial Bus (USB)

There are six Universal Serial Bus ports located at (J44, J11) on the I/O Backpanel and additional two USB ports located at (J43) on the motherboard. These ports, labeled USB7 to USB8, can be used to provide front side chassis access (cables not included). See the tables on the right for pin definitions.

USB Pin Definition

J44 & J11

Pin#	Definition
1	+5V
2	P0-
3	P0+
4	Ground

J43

Pin Number	Definition	Pin Number	Definition
1	+5V	2	+5V
3	PO-	4	PO-
5	PO+	6	PO+
7	Ground	8	Ground
		10	Ground

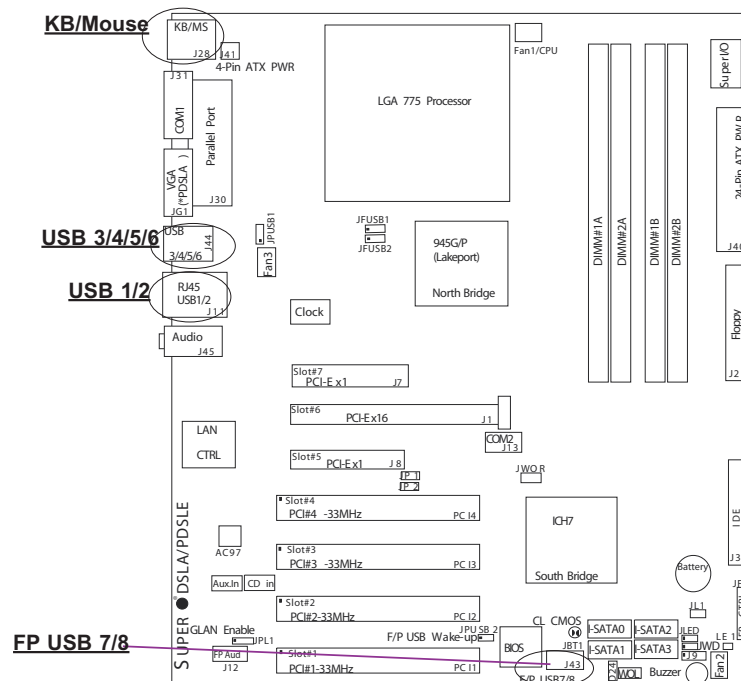

Wake-On-Ring

The Wake-On-Ring header is located at JWOR. This function allows your computer to be awakened by an incoming call the modem when in suspend state. See the table on the right for pin definitions. You must also have a WOR card and cable to use WOR.

Wake-On-Ring Pin Definitions

Pin Number	Definition
1	Ground
2	Wake-up

Wake-On-LAN

The Wake-On-LAN header is designated WOL on the motherboard. See the table on the right for pin definitions. You must enable the LAN Wake-Up setting in BIOS to use this function. (You must also have a LAN card with a Wake-On-LAN connector and cable to use this feature.)

Wake-On-LAN Pin Definitions (WOL)

Pin Number	Definition
1	+5V Standby
2	Ground
3	Wake-up

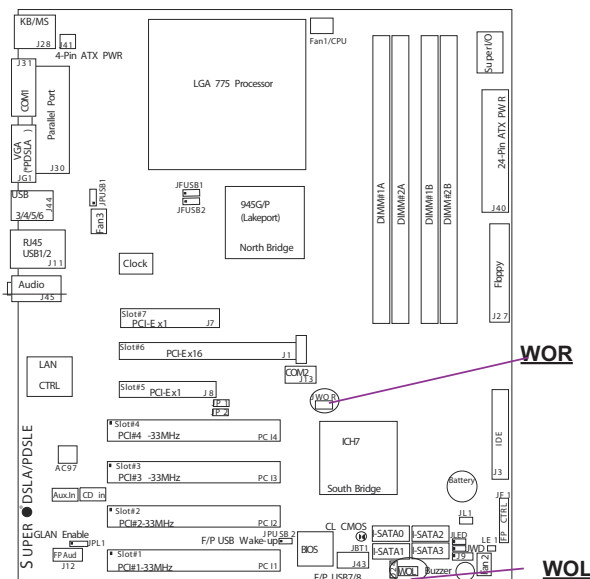

VGA Connector (*For PDSLA only)

A VGA connector (JG1) is located next to the COM1 on the IO backplane. Refer to the board layout below for the location.

AC'97 Output

AC'97 provides high quality onboard audio. The PDSLA/PDSLE features 6-channel sound for front L&R, rear L&R, center and subwoofer speakers. This feature is activated with the Advanced software (on the CD-ROM included with your motherboard). Sound is then output through the Line In, Line Out and MIC jacks (see at right). Activate AC 97 with the "AC 97 Audio" setting in the Advanced Chipset Features section of BIOS.

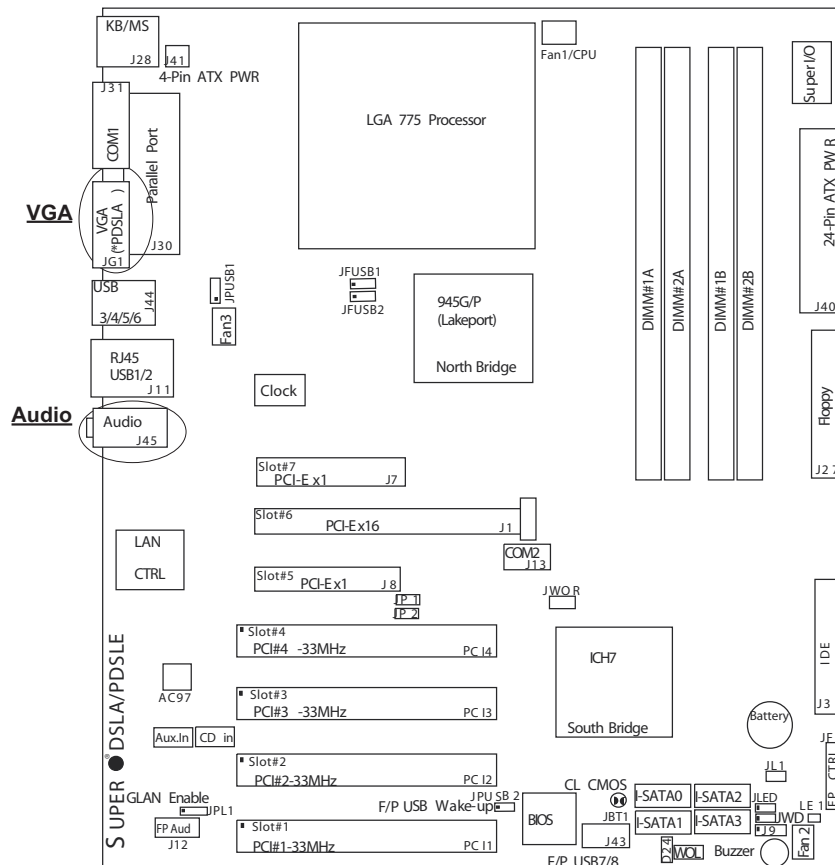
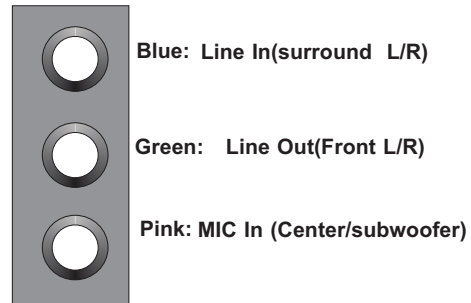

2-7 Jumper Settings

Explanation of Jumpers

To modify the operation of the motherboard, jumpers can be used to choose between optional settings. Jumpers create shorts between two pins to change the function of the connector. Pin 1 is identified with a square solder pad on the printed circuit board. See the motherboard layout pages for jumper locations.

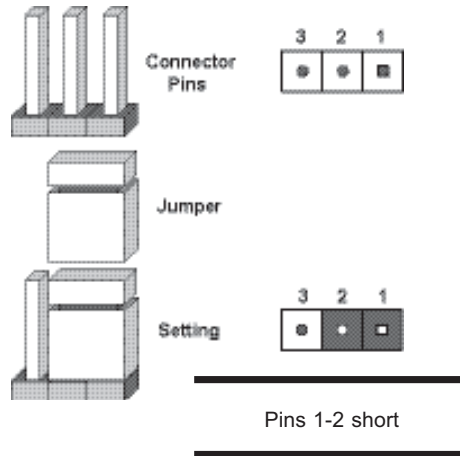

Note: On a two-pin jumper, "Closed" means the jumper is on both pins and "Open" means the jumper is either on only one pin or completely removed.

CMOS Clear

JBT1 is not actually a jumper but consists of two contact pads. To clear the contents of CMOS, short these pads together by touching them both with a metal conductor such as the head of a small screwdriver. JBT1 is located near the SATA header on the PDSLA/PDSLE. **Note:** for ATX power supplies, you must completely shut down the system and remove the AC power cord before clearing CMOS.



Clear CMOS

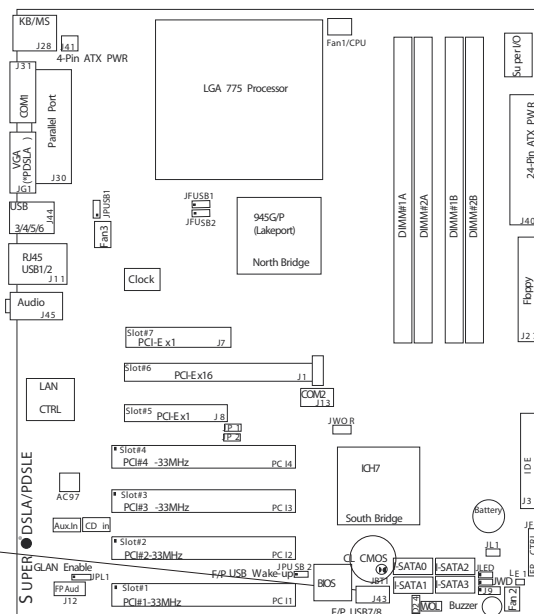

USB Wake-Up

Use JPUSB jumpers to enable the function of "System Wake-Up via USB devices", which allows you to "wake-up" the system by pressing a key on the USB keyboard or by clicking the USB mouse of your system. The JPUSB jumpers are used together with the USB Wake-Up function in the BIOS. Enable both the jumpers and the BIOS setting to allow the system to "wake-up via USB Devices". See the table on the right for jumper settings and jumper connections. (*Note: JPUSB1 is for Back Panel USB ports:1/2/3/4/5/6, and JPUSB2 is for Front Panel USB ports:7/8.)

USB Wake-Up Jumper Settings (JPUSB1/JPUSB2)

Jumper Position	Definition
1-2	Enabled
2-3	*Disabled

(*Default)

(*Note: The default jumper setting for the USB ports is "Disabled". However, when the "USB Wake-Up" function is enabled in the BIOS and the desired USB ports are enabled via the JPUSB jumper, please be sure to remove all USB devices from the USB ports whose USB jumpers are set to "Disabled" before the system goes into the standby mode.)

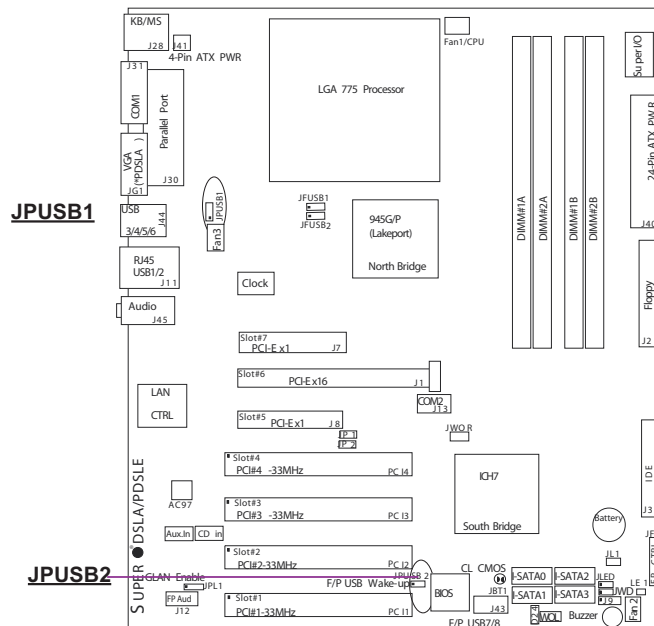

Watch Dog Enable/Disable

JP5 enables the Watch Dog function. Watch Dog is a system monitor that can reboot the system when a software application hangs. Pins 1-2 will cause WD to reset the system if an application hangs. Pins 2-3 will generate a non-maskable interrupt signal for the application that hangs. See the table on the right for jumper settings.

Watch Dog Jumper Settings

Jumper Position	Definition
Pins 1-2	WD to Reset
Pins 2-3	WD to NMI
Open	Disabled

Gigabit LAN Enable

A header for GLAN Enable is located at JPL1. Close Pins 1 & 2 of JPL1 to enable the function of LAN. See the table on the right for pin definitions.

GLAN Enable/Disable Jumper Settings

Jumper Position	Definition
Pins 1-2	Enabled
Pins 2-3	Disabled

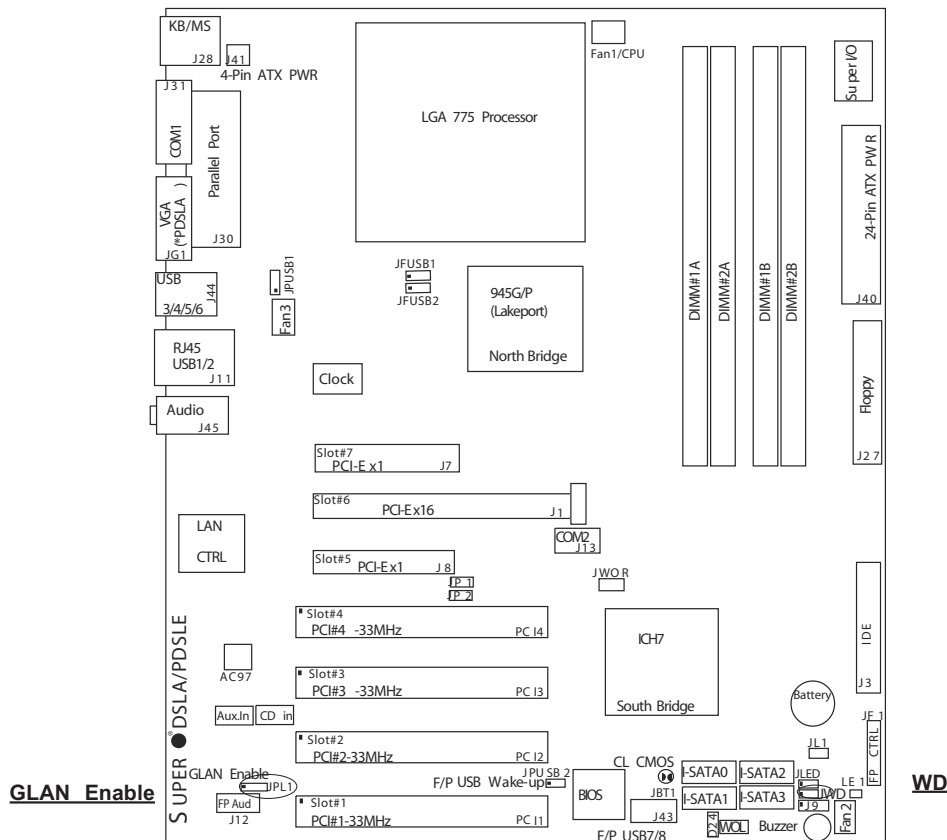

SMBus to PCI/PCI-Exp. Slots

Jumpers JP1, JP2 allow you to connect PCI/PCI-E slots to the System Management Bus. The default setting is "Open" to disable the connection. See the table on the right for jumper settings.

SMBus to PCI/PCI-Exp

Jumper Position	Definition
closed	Enabled
*Open	Disabled

(*Default)

Speaker Connector

The speaker connector is located at J9. Close pins 3 & 4 to use as a internal buzzer. Use a 4-pin cable to connect to an external speaker. See the table on the right for pin definitions.

Speaker Connector

Close: Pins 3 & 4	Internal Buzzer
connect w/a 4-pin header	External Speaker

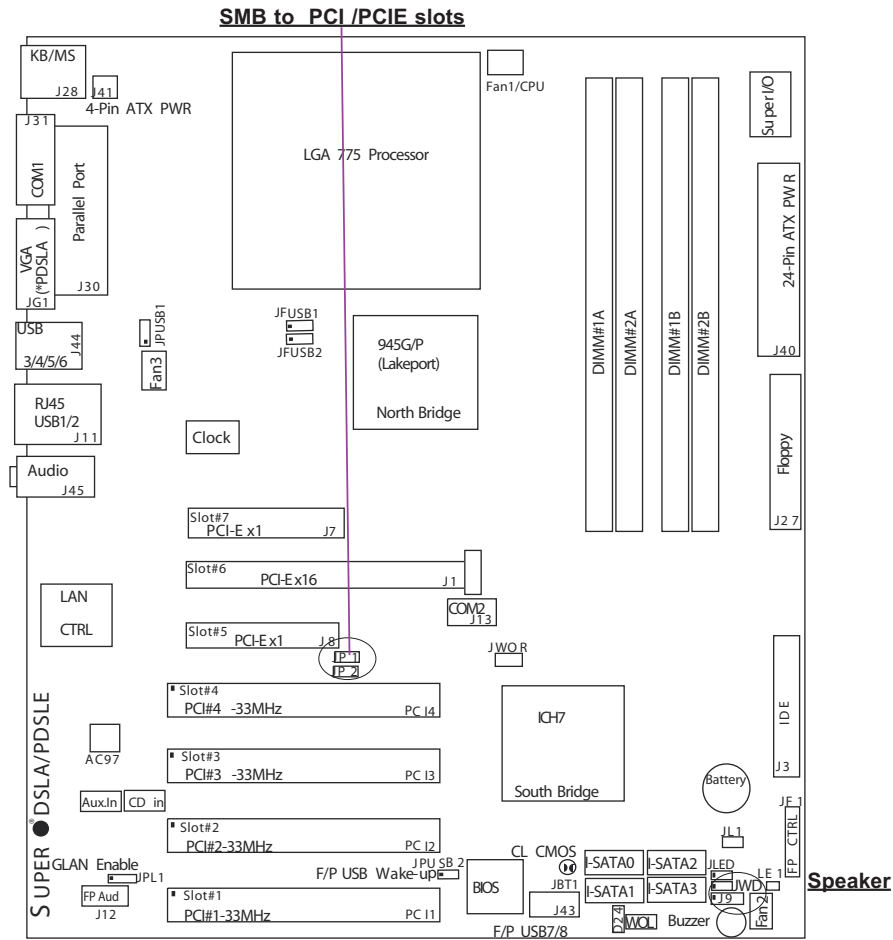

CPU Front Side Bus Speed

JFSB1 and JFSB2 allow you to set the Front Side Bus Frequency. See the table on the right for pin definitions. (*Default is Auto.)

Front Side Bus Speeds: JFSB1, JFSB2		
JFSB1	JFSB2	Frequency
1-2	1-2	*Auto
2-3	2-3	266 MHz
2-3	Open	200 MHz
Open	Open	166 MHz
Open	2-3	133 MHz

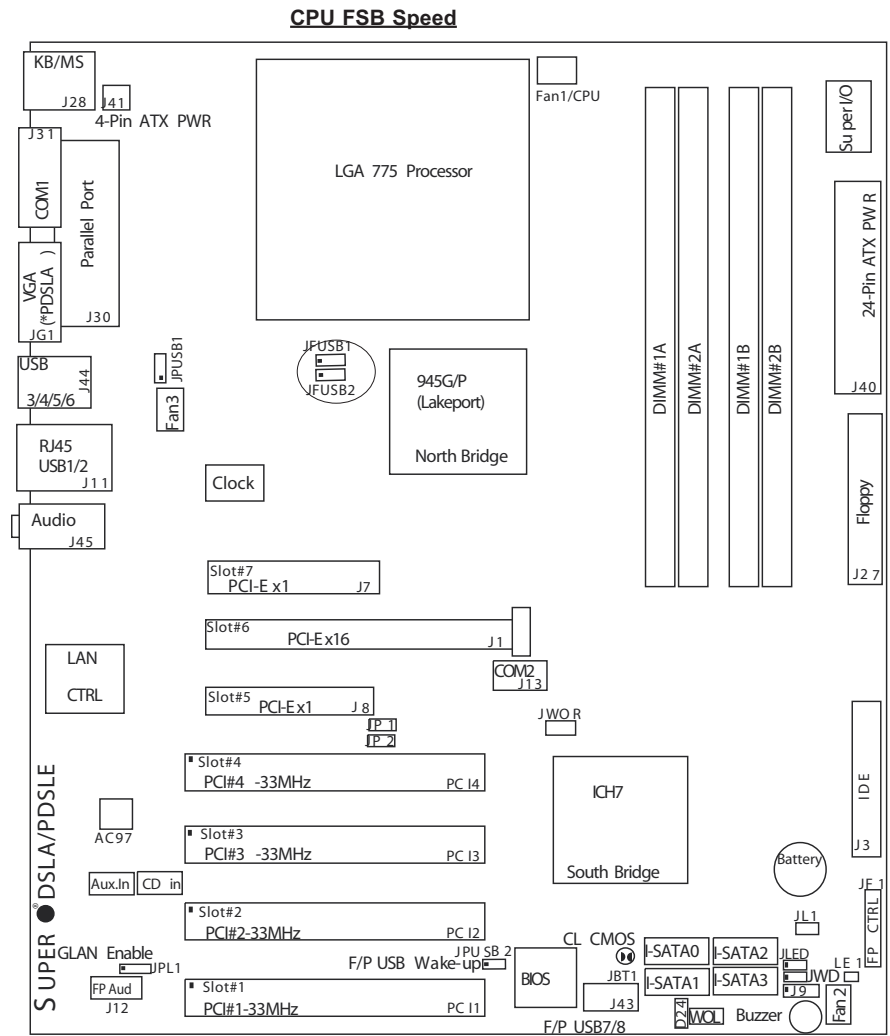

2-8 Onboard Indicators

GLAN LEDs

The Gigabit Ethernet LAN ports (located beside the Video port) has two LEDs. The yellow LED indicates activity while the other LED may be green, amber or off to indicate the speed of the connection. See the table at right for the functions associated with the second LED.

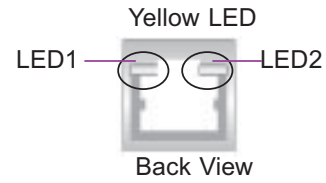

1 Gb LAN Left LED Indicator (Speed LED)

LED Color	Definition
Off	10 MHz
Green	100 MHz
Amber	1 GHz

1 Gb LAN Right LED Indicator (Activity LED)

LED Color	Definition
Amber	Blinking 10/100MHz/ 1GHz

Power LED

The Power LED header is located at JLED. This header provides LED indication of power being supplied to the system. See the table on the right for pin definitions.

JLED Pin Definitions

Pin Number	Definition
1	Anode
2	Key
3	Cathode

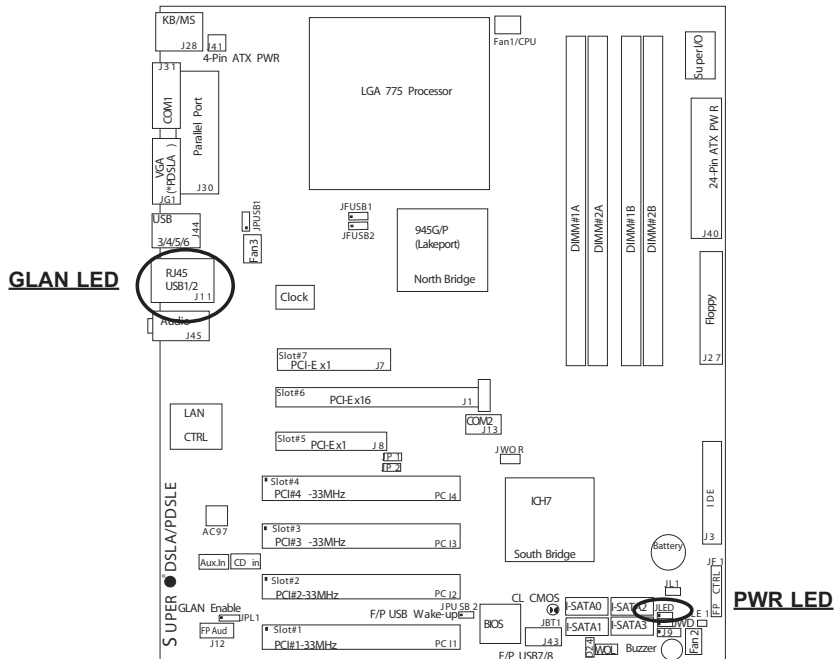

2-9 Parallel Port, Floppy Drive, and Hard Drive

Connections

Use the following information to connect the floppy and hard disk drive cables.

- The floppy disk drive cable has seven twisted wires.
- A red mark on a wire typically designates the location of pin 1.
- A single floppy disk drive ribbon cable has 34 wires and two connectors to provide for two floppy disk drives. The connector with twisted wires always connects to drive A, and the connector that does not have twisted wires always connects to drive B.
- The 80-wire ATA100/66 IDE hard disk drive cable that came with your system has two connectors to support two drives. This special cable should be used to take advantage of the speed this new technology offers. The blue connector connects to the onboard IDE connector interface and the other connector(s) to your hard drive(s). Consult the documentation that came with your disk drive for details on actual jumper locations and settings for the hard disk drive.

Parallel Port Connector

The parallel port is located at J30. Refer to Figure 2-3 for location. See the table on the right for pin definitions.

Parallel (Printer) Port Pin Definitions (J30)

Pin Number	Function	Pin Number	Function
1	Strobe-	2	Auto Feed-
3	Data Bit 0	4	Error-
5	Data Bit 1	6	Init-
7	Data Bit 2	8	SLCT IN-
9	Data Bit 3	10	GND
11	Data Bit 4	12	GND
13	Data Bit 5	14	GND
15	Data Bit 6	16	GND
17	Data Bit 7	18	GND
19	ACK	20	GND
21	BUSY	22	GND
23	PE	24	GND
25	SLCT	26	NC

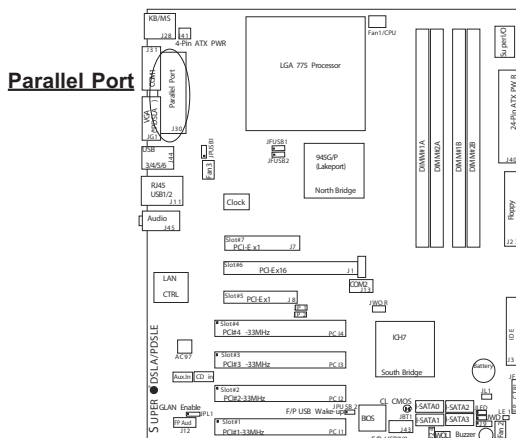

Floppy Connector

The floppy connector is located at J27. Refer to Figure 2-3 for location. See the table on the right for pin definitions.

Floppy Connector Pin Definitions

Pin Number	Function	Pin Number	Function
1	GND	2	FDHDIN
3	GND	4	Reserved
5	Key	6	FDEDIN
7	GND	8	Index-
9	GND	10	Motor Enable
11	GND	12	Drive Select B-
13	GND	14	Drive Select A-
15	GND	16	Motor Enable
17	GND	18	DIR-
19	GND	20	STEP-
21	GND	22	Write Data-
23	GND	24	Write Gate-
25	GND	26	Track 00-
27	GND	28	Write Protect-
29	GND	30	Read Data-
31	x	32	Side 1 Select-
33	x	34	Diskette

IDE Connector

There are no jumpers to configure the onboard IDE interfaces Pins 3, 5 of JF1. Refer to Figure 2-3 for location. See the table on the left for pin definitions. **Note:** You must use the ATA100/66 cable included with your system to benefit from the ATA100/66 technology.

IDE Connector Pin Definitions (J3)

Pin Number	Function	Pin Number	Function
1	Reset IDE	2	GND
3	Host Data 7	4	Host Data 8
5	Host Data 6	6	Host Data 9
7	Host Data 5	8	Host Data 10
9	Host Data 4	10	Host Data 11
11	Host Data 3	12	Host Data 12
13	Host Data 2	14	Host Data 13
15	Host Data 1	16	Host Data 14
17	Host Data 0	18	Host Data 15
19	GND	20	Key
21	DRQ3	22	GND
23	I/O Write-	24	GND
25	I/O Read-	26	GND
27	IOCHRDY	28	BALE
29	DACK3-	30	GND
31	IRQ14	32	IOCS16-
33	Addr 1	34	GND
35	Addr 0	36	Addr 2
37	Chip Select 0	38	Chip Select 1-
39	Activity	40	GND

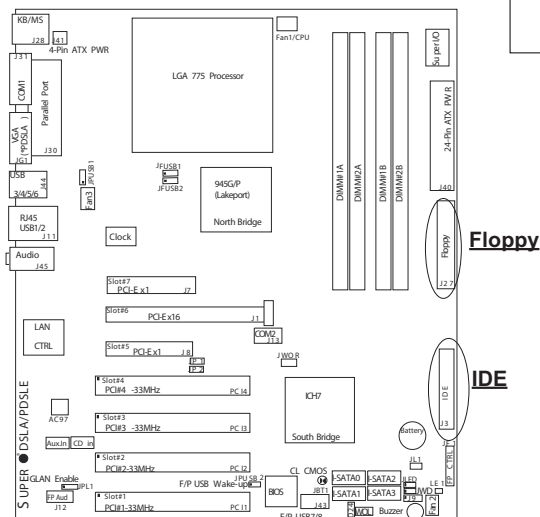

2-10 Installing the Operating System and Software Programs

After all the hardware has been installed, you must first install the operating system, and then, other software drivers. The necessary drivers are all included on the Supermicro CDs that came packaged with your motherboard.



Drivers/Tool Installation Display Screen

***Note:** Click the icons showing a hand writing on the paper to view the readme files for each item. Click the computer icons to the right of these items to install each item (from top to the bottom) one at a time. **After installing each item, you must re-boot the system before moving on to the next item on the list.** The bottom icon with a CD on it allows you to view the entire contents of the CD.

Introduction to Serial ATA (SATA)

Serial ATA(SATA) is a physical storage interface. It uses a single cable with a minimum of four wires to create a point-to-point connection between devices. It is a serial link which supports SATA Transfer rates from 150MBps. The second generation SATA can support up to 300 MBps theoretically. Because the serial cables used in SATA are thinner than the traditional cables used in Parallel ATA(PATA), SATA systems have better airflow and can be installed in smaller chassis than Parallel ATA. In addition, the cables used in PATA can only extend to 40cm long, while Serial ATA cables can extend up to one meter. Overall, Serial ATA provides better functionality than Parallel ATA.

Introduction to the Intel ICH7 I/O Controller Hub

Located in the South Bridge of the Intel Lakeport (945G/P) chipset, the ICH7 I/O Controller Hub provides the I/O subsystem with access to the rest of the system. It supports 1-channel Ultra ATA/100 Bus Master IDE controller (PATA) and four Serial ATA (SATA) Second Generation Host Controllers, which support up to four Serial ATA ports and four hard drives. The ICH7 I/O Controller Hub supports the following Parallel ATA (PATA) and Serial (SATA) device configurations:

SATA Operate Modes

You can select from the following modes: Auto, Combined, Enhanced, and SATA Only Mode. The number of devices supported by these modes are listed below:

- *SATA Only: The maximum of 4 devices are supported (4 SATA)
- *Auto Mode: The maximum of 6 devices supported (4 SATA + 2 IDE)
- *Enhanced Mode: The maximum of 6 devices supported (4 SATA + 2 IDE)
- *Combined Mode: The maximum of 4 devices supported (2 SATA + 2 IDE)

Supero Doctor III

The Supero Doctor III program is a Web based management tool that supports remote management capability. It includes Remote and Local Management tools. The local management is called SD III Client. The Supero Doctor III program included on the CDROM that came with your motherboard allows you to monitor the environment and operations of your system. Supero Doctor III displays crucial system information such as CPU temperature, system voltages and fan status. See the Figure below for a display of the Supero Doctor III interface.

***Note 1:** The default user name and password are ADMIN.

***Note 2:** In the Windows OS environment, the Supero Doctor III settings take precedence over the BIOS settings. When first installed, Supero Doctor III adopts the temperature threshold settings previously set in the BIOS. Any subsequent changes to these thresholds must be made within Supero Doctor, since the SD III settings override the BIOS settings. For the Windows OS to adopt the BIOS temperature threshold settings, please change the SDIII settings to be the same as those set in the BIOS.

Supero Doctor III Interface Display Screen-I (Health Information)



Supero Doctor III Interface Display Screen-II (Remote Control)



Graceful power control

Supero Doctor III allows a user to inform the OS to reboot or shut down within a specified time (the default is 30 seconds). Before the system reboots or shuts down, it's allowed to cancel the action.

Requirements

- Keep Supero SD3Service Daemon running at all times on this system.
- Provide TCP/IP connectivity.

Power control

***Note:** SD III Software Revision 1.0 can be downloaded from our Website at: ftp://ftp.supermicro.com/utility/Supero_Doctor_III/. You can also download SDIII User's Guide at: <http://www.supermicro.com/PRODUCT/Manuals/SDIII/UserGuide.pdf>. For Linux, we will still recommend Supero Doctor II.

Notes

Chapter 3

Troubleshooting

3-1 Troubleshooting Procedures

Use the following procedures to troubleshoot your system. If you have followed all of the procedures below and still need assistance, refer to the 'Technical Support Procedures' and/or 'Returning Merchandise for Service' section(s) in this chapter. Always disconnect the AC power cord before adding, changing or installing any hardware components.

Before Power On

1. Check that the Standby Power LED is not lit (LE1 on motherboard).
2. Make sure that there are no short circuits between the motherboard and chassis.
3. Disconnect all ribbon/wire cables from the motherboard, including those for the keyboard and mouse.
4. Remove all add-on cards.
5. Install a CPU and heatsink (making sure it is fully seated) and connect the chassis speaker and the power LED to the motherboard. Check all jumper settings as well.
6. Use the correct type of onboard CMOS battery as specified by the Manufacturer. Do not install the CMOS battery upside down to avoid possible explosion.
7. Make sure the 4-pin 12v power connector at J41 is connected to your power supply.

No Power

1. Make sure that there are no short circuits between the motherboard and the chassis.
2. Verify that all jumpers are set to their default positions.
3. Check that the 115V/230V switch on the power supply is properly set.
4. Turn the power switch on and off to test the system.
5. The battery on your motherboard may be old. Check to verify that it still supplies ~3VDC. If it does not, replace it with a new one.

No Video

1. If the power is on but you have no video, remove all the add-on cards and cables.
2. Use the speaker to determine if any beep codes exist. Refer to Appendix A for details on beep codes.

NOTE

If you are a system integrator, VAR or OEM, a POST diagnostics card is recommended. For I/O port 80h codes, refer to App. B.

Memory Errors

1. Make sure that the DIMM modules are properly and fully installed.
2. You should be using unbuffered DDRII memory (see next page). Also, it is recommended that you use the same memory speed for all DIMMs in the system. See Section 2-4 for memory limitations.
3. Check for bad DIMM modules or slots by swapping modules between slots and noting the results.
4. Check the power supply voltage 115V/230V switch.

Losing the System's Setup Configuration

1. Make sure that you are using a high quality power supply. A poor quality power supply may cause the system to lose the CMOS setup information. Refer to Section 1-6 for details on recommended power supplies.
2. The battery on your motherboard may be old. Check to verify that it still supplies ~3VDC. If it does not, replace it with a new one.
3. If the above steps do not fix the Setup Configuration problem, contact your vendor for repairs.

3-2 Technical Support Procedures

Before contacting Technical Support, please take the following steps. Also, note that as a motherboard manufacturer, Supermicro does not sell directly to end-users, so it is best to first check with your distributor or reseller for troubleshooting services. They should know of any possible problem(s) with the specific system configuration that was sold to you.

1. Please go through the 'Troubleshooting Procedures' and 'Frequently Asked Question' (FAQ) sections in this chapter or see the FAQs on our web site (<http://www.supermicro.com/support/faqs/>) before contacting Technical Support.
2. BIOS upgrades can be downloaded from our web site at (<http://www.supermicro.com/support/bios/>).

Note: Not all BIOS can be flashed; it depends on the modifications to the boot block code.

3. If you still cannot resolve the problem, include the following information when contacting Super Micro for technical support:

- Motherboard model and PCB revision number
- BIOS release date/version (this can be seen on the initial display when your system first boots up)
- System configuration

An example of a Technical Support form is on our web site at

<http://www.supermicro.com/support/contact.cfm>.

4. Distributors: For immediate assistance, please have your account number ready when placing a call to our technical support department. We can be reached by e-mail at support@supermicro.com, by phone at:(408) 503-8000, option 2, or by fax at (408)503-8019.

3-3 Frequently Asked Questions

Question: What type of memory does my motherboard support?

Answer: The PDSLA/PDSLE supports **unbuffered**, non-ECC, DDRII-400/533/667 MHz memory modules. See Section 2-4 for details on installing memory.

Question: How do I update my BIOS?

Answer: It is recommended that you **not** upgrade your BIOS if you are not experiencing problems with your system. Updated BIOS files are located on our web site at <http://www.supermicro.com/techsupport/BIOS/bios.htm>. Please check our BIOS warning message and the information on how to update your BIOS on our web site. Also, check the current BIOS revision and make sure it is newer than your current BIOS before downloading. Select your mainboard model and download the BIOS file to your computer. Unzip the BIOS update file and you will find the readme.txt (flash instructions), the awdfash.exe (BIOS flash utility) and the BIOS image (xxxx.bin) files. Copy these files onto a bootable floppy and reboot your system. Then, follow the readme.txt to flash the BIOS.

Question: What's on the CD that came with my motherboard?

Answer: The supplied compact disc has quite a few drivers and programs that will greatly enhance your system. We recommend that you review the CD and install the applications you need. Applications on the CD include chipset drivers for Windows and security and audio drivers.

Question: Why can't I turn off the power using the momentary power on/off switch?

Answer: The instant power off function is controlled in BIOS by the Power Button Mode setting. When the On/Off feature is enabled, the motherboard will have

instant off capabilities as long as the BIOS has control of the system. When the Standby or Suspend feature is enabled or when the BIOS is not in control such as during memory count (the first screen that appears when the system is turned on), the momentary on/off switch must be held for more than four seconds to shut down the system. This feature is required to implement the ACPI features on the motherboard.

Question: How do I utilize the six-channel sound?

Answer: The six-channel sound available on the PDSLA/PDSLE can be enabled with the audio driver software that was included in your motherboard package. When activated, sound will be routed through the jacks under the Game Port as follows: Line Out = front L&R speakers, Line In = rear L&R speakers, MIC = center and subwoofer speakers. You must also enable the "AC97 Audio" setting in the Advanced Chipset section of the BIOS setup.

Question: I installed my microphone correctly but I can't record any sound. What should I do?

Answer: Go to <Start>, <Programs>, <Accessories>, <Entertainment> and then <Volume Control>. Under the Properties tab, scroll down the list of devices in the menu and check the box beside "Microphone".

Question: How do I connect the ATA100/66 cable to my IDE device(s)?

Answer: The 80-wire/40-pin high-density ATA100/66 IDE cable that came with your system has two connectors to support two drives. This special cable must be used to take advantage of the speed the ATA100/66 technology offers. **Connect the blue connector to the onboard IDE header and the other connector(s) to your hard drive(s).** Consult the documentation that came with your disk drive for details on actual jumper locations and settings.

Question: After I have installed 4 pieces of 1GB Memory, why does the BIOS only detect about 3.145 GB of memory during POST?

Answer: Because the chipset does not support memory remapping, and PCI-e memory requires a great deal of memory, so there is a memory hole located around the 4GB memory address.

Question: I have already enabled the USB Wake-Up mode in the BIOS, my system still cannot enter "Standby Mode"? Why?

Answer: In order for this function to work properly, please make sure that the USB Wake-Up Jumpers (JPUSB1/JPUSB2) are also enabled on the motherboard.

3-4 Returning Merchandise for Service

A receipt or copy of your invoice marked with the date of purchase is required before any warranty service will be rendered. You can obtain service by calling your vendor for a Returned Merchandise Authorization (RMA) number. When returning to the manufacturer, the RMA number should be prominently displayed on the outside of the shipping carton, and mailed prepaid or hand-carried. Shipping and handling charges will be applied for all orders that must be mailed when service is complete.

This warranty only covers normal consumer use and does not cover damages incurred in shipping or from failure due to the alteration, misuse, abuse or improper maintenance of products.

During the warranty period, contact your distributor first for any product problems.

Note

Chapter 4

BIOS

4-1 Introduction

This chapter describes the AwardBIOS for the PDSLA/PDSLE. The Award ROM BIOS is stored in a Flash chip and can be easily upgraded using a floppy disk-based program.

Note: Due to periodic changes to the BIOS, some settings may have been added or deleted and might not yet be recorded in this manual. Refer to the Manual Download area of our web site for any changes to BIOS not reflected in this manual.

System BIOS

The BIOS is the Basic Input Output System used in all IBM® PC, XT™, AT®, and PS/2® compatible computers. The AwardBIOS Flash chip stores the system parameters, such as amount of memory, type of disk drives and video displays, etc. CMOS requires very little power. When the computer is turned off, a back-up battery provides power to the BIOS Flash chip, enabling it to retain the system parameters. Each time the computer is powered-on, the computer is then configured with the values stored in the BIOS ROM by the system BIOS, which gains control when the computer is powered on.

How To Change the Configuration Data

The CMOS information that determines the system parameters may be changed by entering the BIOS Setup utility. This Setup utility can be accessed by pressing at the appropriate time during system boot.

Starting the Setup Utility

Normally, the only visible POST (Power On Self Test) routine is the memory test. As the memory is being tested, press the <Delete> key to enter the main menu of the BIOS Setup utility. From the main menu, you can access the other setup screens, such as the Chipset and Power menus. Section 4-3 gives detailed descriptions of each parameter setting in the Setup utility.

4-2 Running Setup

**Optimal default settings are in bold text unless otherwise noted.*

The BIOS setup options described in this section are selected by choosing the appropriate text from the Main BIOS Setup screen. All displayed text is described in this section, although the screen display is often all you need to understand how to set options (see the note on the next page).

When you first power on the computer, the AwardBIOS™ is immediately activated.

While the BIOS is in control, the Setup program can be activated in one of two ways:

1. By pressing immediately after turning the system on, or
2. When the following message appears briefly at the bottom of the screen during the POST (Power On Self-Test), press the key to activate the Main Setup Menu.

Press DEL to enter SETUP

4-3 Main BIOS Setup

All Main Setup options are described in this section. The Main BIOS Setup screen is displayed below.

Use the <Up> <Down> arrow keys or the <Tab> key to move among the different settings in the above menu.

Press the <Esc> key to exit the CMOS Setup Menu and use the <Left> <Right> arrow keys to enter the other categories of BIOS settings. The next section is described in detail to illustrate how to navigate through the menus.

Main BIOS Setup Menu

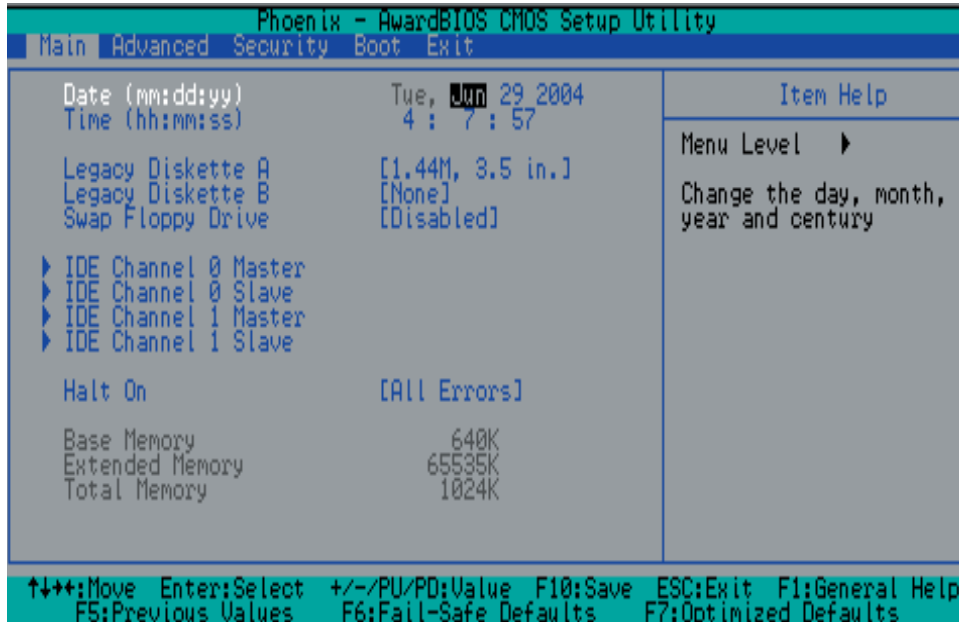

Date/Time

Set the system date and time. Key in the correct information in the mm, dd and yy fields. Press the Enter key to save the data.

Legacy Diskette A

This setting allows the user to set the type of floppy disk drive installed as diskette A. The options are None, 360Kb 5.25 in, 1.2MB 5.25 in, 720Kb 3.5 in, **1.44MB**, 3.5 in and 2.88MB 3.5 in.

Legacy Diskette B

This setting allows the user to set the type of floppy disk drive installed as diskette B. The options are **None**, 360Kb 5.25 in, 1.2MB 5.25 in, 720Kb 3.5 in, 1.44MB, 3.5 in and 2.88MB 3.5 in.

Swap Floppy Drive

If the system has two floppy drives, enable this feature to assign physical drive B to logical drive A or physical drive A to logic drive B. The options are Enabled and **Disabled**.

► IDE Channel 0 Master/Slave, IDE Channel 1 Master/Slave, IDE Channel 2 Master/Slave, IDE Channel 3 Master/Slave

These settings allow the user to set the parameters of the IDE Channel 0 Master/Slave and IDE Channel 1 Master/Slave slots. Hit <Enter> to activate the following sub-menu screen for detailed options of these items. Set the correct configurations accordingly. The items included in the submenu are listed below:

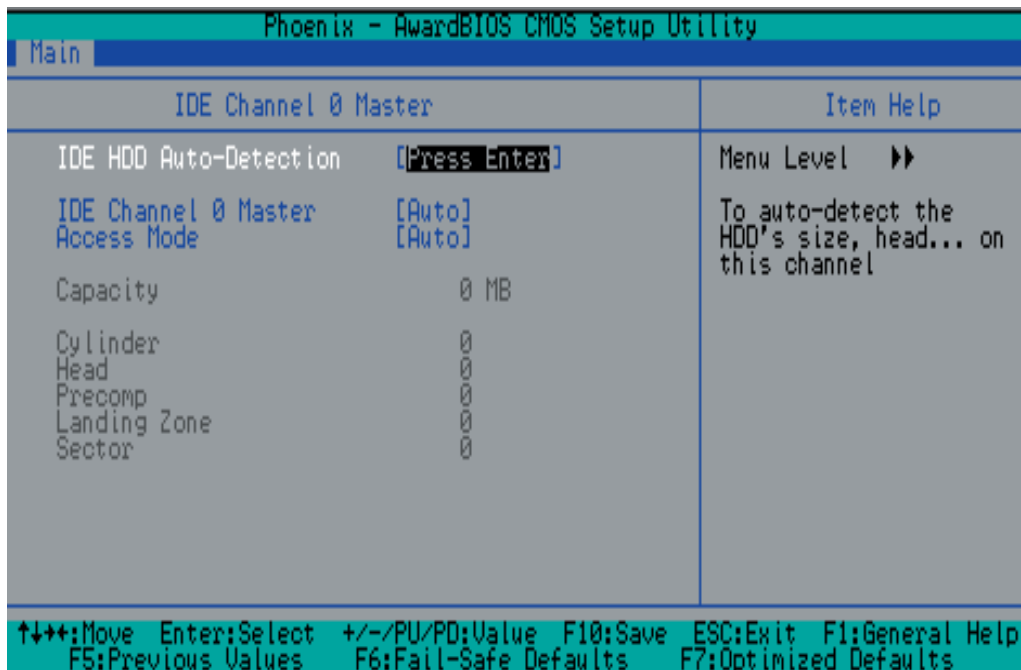

IDE HDD Auto-Detection

This option allows the BIOS to automatically display the configuration settings for the IDE devices. Press "Enter" to see the setting displayed by the BIOS.

IDE Channel 0 Master

Press the <Enter> key to activate the IDE HDD Auto-Detection function, which will allow BIOS to automatically detect the status of the IDE HDD installed in the system, such as the size, the number of cylinders, the configurations of items such as Head, Precomp, Landing Zone and Sector.

Access Mode

This item determines the location through which the AwardBIOS accesses the IDE Primary Master Device. The settings are CHS, LBA, Large, and **Auto**.

Extended IDE Drive (*For IDE Channels 2/3 only)

Select "Auto" to allow the AwardBIOS to auto detect and display the status of Serial ATA drives. The options are **Auto** and None.

Halt On

This item sets the condition that activates the function of Halt On The options are **All Error**, No Error, All But Keyboard, All, But Diskette, and All, But Disk/Key.

Base Memory/Extended Memory/Total Memory

These are displays that inform you how much of each type of memory is recognized as being present in the system.

4-4 Advanced BIOS Setup

Choose Advanced BIOS Setup from the Award BIOS main menu with the Left/Right arrow keys. You should see the following display. Select one of the items in the left frame of the screen to go to the sub screen for that item. Advanced BIOS Setup options are displayed by highlighting the option using the arrow keys. All Advanced BIOS Setup options are described in this section. (*Caution--Be cautious when changing the Advanced BIOS Settings. If an incorrect field value is entered, the system may become unstable.)

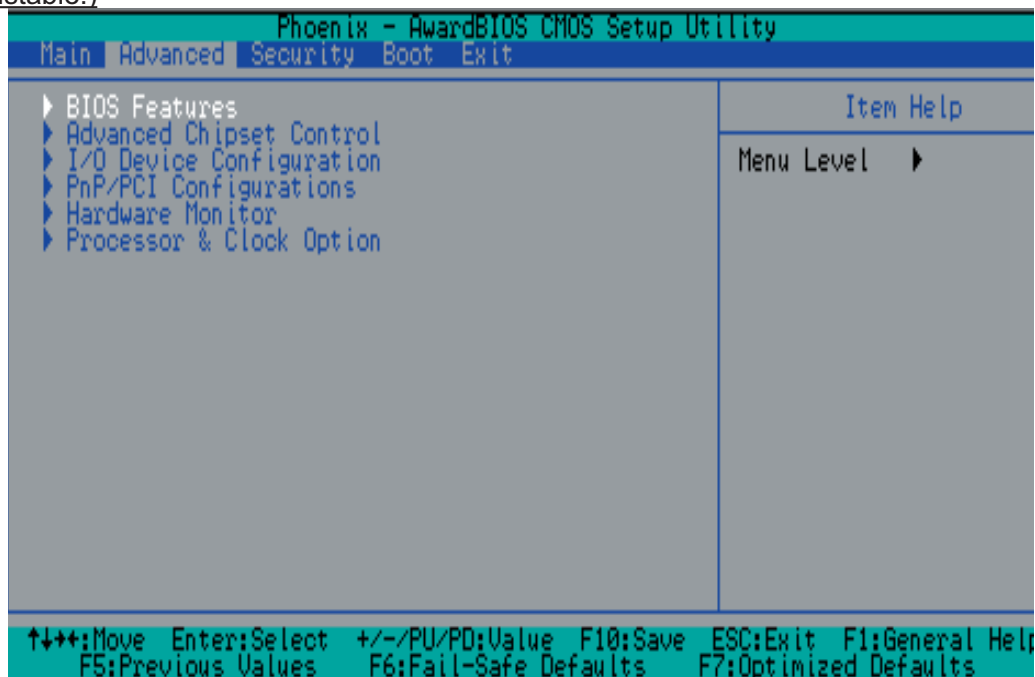

4-4.1 Advanced BIOS Features

When the item of Advanced BIOS Features is highlighted, press the <Enter> key to activate the screen below:

Quick Boot

If enabled, this feature allows the system to skip certain tests while booting. This will decrease the time needed to boot the system. The settings are **Enabled** and **Disabled**.

Quiet Boot

This feature allows the user to activate the function of Quiet Boot. **Enabled** and **Disabled**.

ACPI Function

Select Enabled to activate the function of BIOS Support for the Advanced Configuration and Power Interface features. The settings are **Enabled** or Disabled.

ACPI Suspend Type

If enabled, the option allows the user to determine the ACPI Suspend type. The options are **S1(POS)**, S3(STR), S1&S3.

APIC Mode

This setting allows you to **Enable** or Disable APIC. APIC is used to assign interrupt signals to a specific processor on multiprocessor system and provides IRQs beyond the conventional 16 under Windows 2000 or XP. It has no effect on single processor systems.

MPS Version Control

This setting allows you to state the MPS version for your operating system. The options are 1.1 and **1.4**.

Watch Dog Timer Select

This feature allows the user to configure the Watch Dog timer settings. The options are **Disabled**, 10 Sec, 20 Sec, 30 Sec, 40 Sec, 1 Min, 2 Min and 4 Min.

4-4.2 Advanced Chipset Control

CPU THRM-Throttling

This setting allows the CPU to slow down and operate at the level specified by this setting when the CPU reaches a temperature setting pre-defined by the user. The options are **75%**, 50% and 25%.

PEG/On-Chip VGA Control

This setting allows you to enable or disable the PEG/On-Chip VGA Controller. The options are **Auto**, PEG Port, and Onchip VGA.

Boot Display

This feature configures the settings of the boot display device. The options are CTR, TV, EFP and **Auto**.

On-Chip Serial ATA

Select Disabled to disable the SATA Controller. Select **Auto** to allow the BIOS to make arrangements automatically. Select Combined Mode to use the PATA and SATA Combined Mode. The maximum of 2 IDE drives in each channel is allowed. Select **Enhanced** Mode to enable both SATA and PATA. This mode will support up to 6 IDE drives. Select **SATA Only** to allow SATA to operate in the Legacy Mode .

USB Controller

This setting allows you to enable or disable the USB Controller. The options are **Enabled**, and Disabled.

USB 2.0 Controller

This setting allows you to enable or disable the USB 2.0 (EHCI) Controller. The options are **Enabled**, and Disabled.

USB Legacy Support

This setting allows you to enable or disable the functions of USB, Keyboard/Mouse under POST and DOS. The options are **Disabled**, and Enabled.

USB KB Wake-Up From S3 (S4)

If enabled, the USB Keyboard will be awakened from the S3 (S4) state. The options are **Disabled**, and Enabled.

4-4.3 I/O Device Configuration

Onboard FDC

This setting allows the user to enable the onboard FDC controller. The options are **Enabled** and Disabled.

Onboard Serial Port1/Onboard Serial Port2

This setting allows the user to set the address and the corresponding IRQ for the Serial Port1 and Serial Port 2. The options are Disabled, 3F8/IRQ4, 2F8/IRQ3, 3E8/IRQ4, 2E8/IRQ3, and Auto. The default setting for Serial Port1 is **3F8/IRQ4** and the default for Port 2 is **2F8/IRQ3**.

UART Mode Select

This setting allows the user to select the UART mode for the BIOS. The options are IrDA, ASKIR and **Normal**.

RxD, TxD Active

This allows the user to configure the RxD, TxD Active settings. The options are Hi, Hi, **Hi, Lo**, Lo, Hi, and Lo, Lo.

IR Transmission Delay

If Enabled, the transmission of IR (infrared) signals will be delayed. The options are **Enabled** and Disabled.

UR2 Duplex Mode

This setting allows the user to configure the UR2 Duplex Mode. The options are Full and **Half**.

Use IR Pins

This item sets the usage of the IR pins. The options are RxD2, TxD2 and **IR-Rx2Tx2**.

Onboard Parallel Port

This setting allows the user to set the address and the corresponding IRQ for the onboard parallel port. The options are Disabled, **378/IRQ7**, 278/IRQ5 and 3BC/IRQ7.

Parallel Port Mode

This setting allows the user to configure the onboard Parallel port mode settings. The options are **SPP**, EPP, ECP, ECP+EPP and Normal.

EPP Mode Select

This setting allows the user to select the EPP port type. The options are EPP 1.9 and **EPP 1.7**.

ECP Mode Use DMA

This setting allows the user to select the DMA channel for the ECP mode (port) to use. The options are 1 and **3**.

PWRON After PWR-Fail

This setting allows the user to specify how the system will respond when power is reapplied after the system has gone down due to a power failure. The options are **Off**, On and Former-Sts.

Power On Function

This setting allows the user to decide which method to use to power on the system. The options are Password, Hot Key, Mouse Left, Mouse Right, Any Key, Keyboard 98, and **Button Only**.

KB Power On Password

This setting allows the user to enter the Password when the system is powered on via keyboard.

Hot Key Power On

This setting allows the user to decide which hot-keys to use in order to power on the system. The options are **Ctrl-F1**, Ctrl-F2, Ctrl-F3, Ctrl-F4, Ctrl-F5, Ctrl-F6, Ctrl-F7, and Ctrl-F8.

4-4.4 PnP/PCI Configuration

Choose PCI/PnP Configurations from the Award BIOS main menu with the Left/Right arrow keys. The following items will be displayed:

Onboard LAN

This setting allows you to enable or disable the Onboard LAN Controller. The options are **Enabled**, and **Disabled**.

Initial Display First

This feature sets the device that will initiate the monitor display when the system is first turned on. The options are **PCI Slot** and **Onboard**.

Reset Configuration Data

Enabling this setting resets the extended system configuration data when you exit setup. Do this when you have installed a new add-on and the system reconfiguration has caused such a serious conflict that the OS cannot reboot the system. The options are **Enabled** and **Disabled**.

Resources Controlled By

This setting allows the BIOS to automatically configure all boot and Plug and Play compatible devices. If you choose **Auto**, you cannot select the IRQ, DMA and memory base address fields because BIOS automatically assigns them. The options are **Auto (ESCD)** and **Manual**.

Maximum Payload Size

This setting allows the BIOS to set the maximum TLP Payload size for the PCI Express devices in the system. The options are: 128 (bytes), 256 (bytes), 512 (bytes), 1024 (bytes), 2048 (bytes), and **4096 (bytes)**.

► PCI Express Root Port Function

Intel 182573 LAN/PCI Express Port 2/PCI Express Port 3

Select **Enabled** to enable the PCI Express Root Port for the PCI Express port specified. The options are: **Disabled**, **Enabled**, and **Auto**.

PCI-E Compliance Mode

This features allows the BIOS to set the version of PCI-E Compliance Mode for the system. The options are: **v.1.0a** and **v.1.0**

4-4.5 Hardware Monitors

This section allows the BIOS to display the status of hardware components monitored by the AwardBIOS.

CPU Warning Temperature

This allows you to set the CPU warning temperature threshold. If the CPU temperature reaches this threshold, an alarm will be activated and a warning message will be displayed on the screen. The options are Disabled, 60°C/140°F, 65°C/149°F, 70°C/158°F, **75°C/167°F**, 80°C/176°F and 85°C/185°F. (See the note below.)

Highlight this and hit <Enter> to see monitor data for the following items:

CPU Temperature: This item displays CPU1 Temperature.

In addition to temperature monitoring, the status of the following items will also be displayed:

Fan Speed Control (Fan 1- Fan 3)

If the Fan Speed Control feature is set to Disabled or when the CPU or the system temperature reaches the pre-defined threshold, the fans will run at full speed.

Voltage Monitoring

The following Voltage items will also be monitored and displayed:

V_CORE (CPU)/V_CORE (Chipset)/+3.3V/+5V/+12V/-12V/+3VSB(V)/+5VSB(V)/VBAT (V)

4-4.6 Processor & Clock Options

Thermal Management

This setting determines the method used by BIOS to control the thermal management of the system. The options are Thermal Monitor 1 (On die throttling) and **Thermal Monitor 2 (Ratio & VID transition)**.

Hyper-Threading

Set this option to Enabled to activate the hyper-threading function of the CPUs. Enabling the hyper-threading function makes each CPU appear as two to any programs that support it (you must have OS support also). The settings are Disabled and **Enabled**.

***Note:** In the Windows OS environment, the Supero Doctor III settings take precedence over the BIOS settings. When first installed, Supero Doctor III adopts the temperature threshold settings previously set in the BIOS. Any subsequent changes to these thresholds must be made within Supero Doctor, since the SD III settings override the BIOS settings. For the Windows OS to adopt the BIOS temperature threshold settings, please change the SDIII settings to be the same as those set in the BIOS.

CPU Clock Ration

Use this option to set the clock ratio of the processor. The minimum setting is 12 and the maximum is 13. Key in the desired number in the text box provided.

Auto Detect PCI CLK

Select Enabled to allow the system automatically detect the setting of the PCI clock. The options are Enabled and **Disabled**.

Spread Spectrum

Spread Spectrum is a technique used to stabilize a system by reducing the level of ElectroMagnetic Interference. The options are Enabled and **Disabled**.

CPU Clock

Use this option to set the clock of the processor. The minimum setting is 266 and the maximum is 299. Key in the desired number in the text box provided.

4-5 Security

Choose Security from the Award BIOS main menu with the Left/Right arrow keys. You should see the following display:

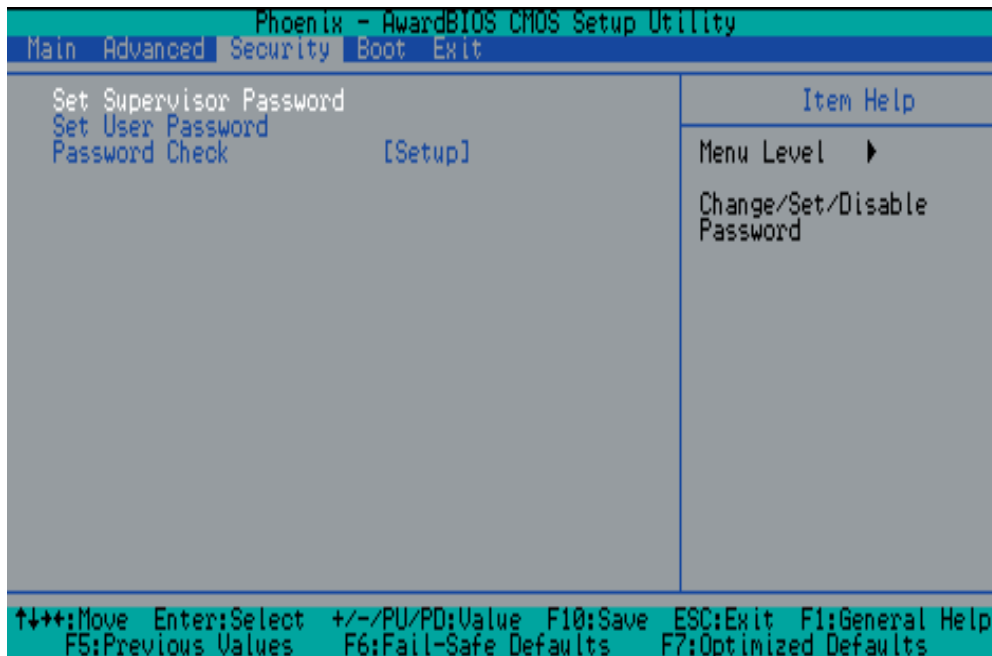

Set Supervisor Password

When the item Set Supervisor Password is highlighted on the above screen, press the <Enter> key. When prompted, type the Supervisor Password in the dialogue box to set or to change the Supervisor Password.

Set User Password

When the item Set User Password is highlighted on the above screen, press the <Enter> key. When prompted, type the User Password in the dialogue box to set or to change the User Password.

Password Check

This setting allows the user to determine if the password is required every time when the system boots up or if the password is required only when you enter the CMOS setup. The options are System and **Setup**.

4-6 Boot

Choose Boot from the Award BIOS main menu with the Left/Right arrow keys. You should see the following display:

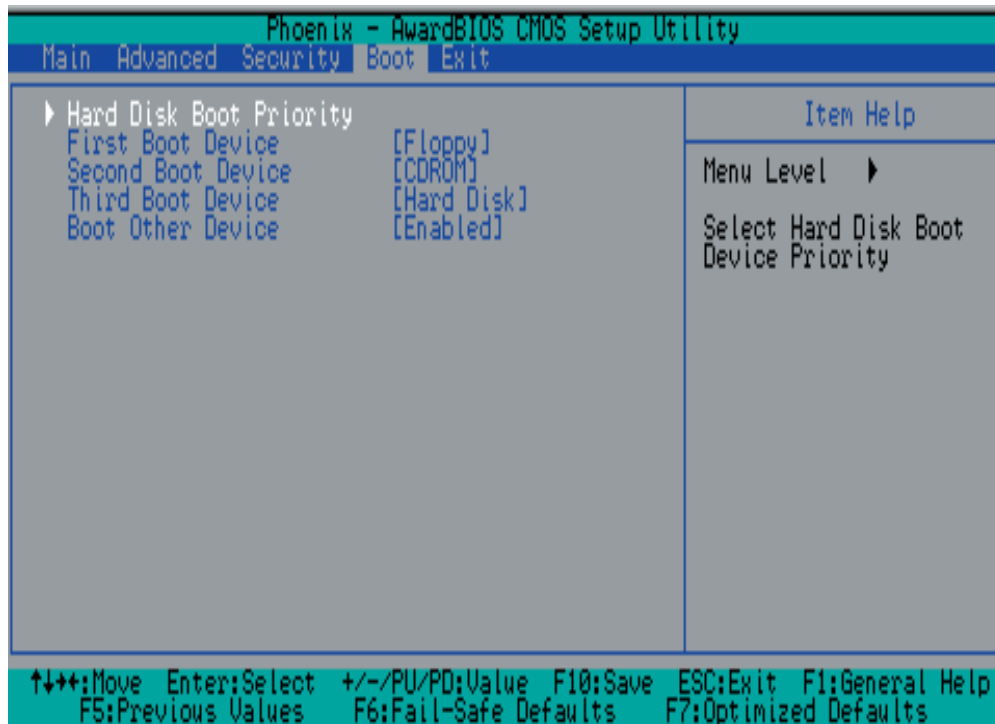

The Award BIOS attempts to load the operating system from devices specified by the users in a user-specified sequence.

Hard Disk Boot Priority

This item allows the user to select the Boot Priority of Hard Disk Devices.

First Boot Device

This item allows the user to set the first boot-up device. The options are **Floppy**, LS120, HDD, CDROM, ZIP100, USB-FDD, USB-ZIP, USB-CDROM, USB-HDD, LAN and Disabled.

Second Boot Device

This item allows the user to set the second boot-up device. The options are Floppy, LS120, HDD, **CDROM**, ZIP100, USB-FDD, USB-ZIP, USB-CDROM, USB-HDD, LAN and Disabled.

Third Boot Device

This item allows the user to set the third boot-up device. The options are Floppy, LS120, **HDD**, SCSI, CDROM, ZIP100, USB-FDD, USB-ZIP, USB-CDROM, USB-HDD, LAN and Disabled.

Boot Other Device

If enabled, this option allows the BIOS to load the OS from another device rather than the ones that have been specified as the first, second and third boot up devices. The settings are **Enabled** and Disabled.

4-7 Exit

Choose Exit from the Award BIOS main menu with the Left/Right arrow keys. You should see the following display:

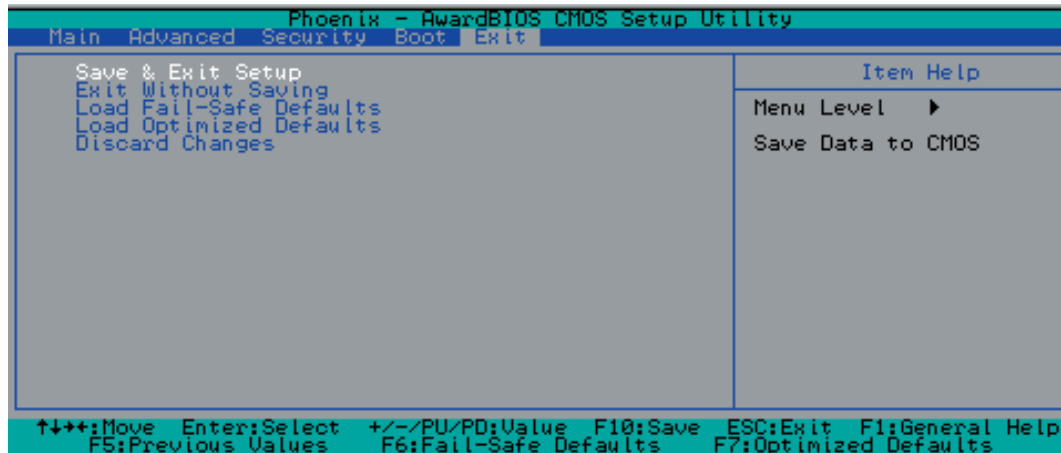

Save & Exit Setup

When the item Save & Exit Setup is highlighted, press <Enter> to save the changes you've made in the BIOS program (CMOS) and exit. Your system should, then, continue with the boot-up procedure.

Exit without Saving

When the item Exit without Saving is highlighted, press <Enter> to exit the Setup routine without saving any changes you may have made. Your system should then continue with the boot-up procedure.

Load Fail-Safe Defaults

Highlight this item and hit <Enter> to load the default settings for all items in the BIOS Setup. These are the safest settings to use.

Load Optimized Defaults

Highlight this item and hit <Enter> to load the optimized settings for all items in the BIOS Setup. These settings provide you with optimal system performance.

Discard Changes

When the item Discard Changes is highlighted, press <Enter> to discard any changes you made to the BIOS settings and to stay in BIOS Setup. Your system should then continue with the boot-up procedure.

Notes

Appendix A BIOS POST Messages

During the Power-On Self-Test (POST), the BIOS will check for problems. If a problem is found, the BIOS will activate an alarm or display a message. The following is a list of such BIOS messages.

Beeps

1 long beep

1 long beep+2 short beeps

Error Messages

Memory Modules Errors

VGA Errors

Notes

Appendix B

Award BIOS POST Codes

This section lists the POST (Power On Self Testing) Codes for the Award BIOS.

POST (hex)	Description
CFh	Test CMOS R/W functionality.
C0h	Early chipset initialization: - Disable shadow RAM - Disable L2 cache (socket 7 or below) - Program basic chipset registers
C1h	Detect memory - Auto detection of DRAM size, type and ECC. - Auto detection of L2 cache (socket 7 or below)
C3h	Expand compressed BIOS code to DRAM.
C5h	Call chipset hook to copy BIOS back to E000 & F000 shadow RAM.
0h1	Expand the Xgroup codes located in physical address 1000:0
02h	Reserved
03h	Initial Superio_Early_Init switch
04h	Reserved
05h	1. Blank out screen. 2. Clear CMOS error flag.
06h	Reserved
07h	1. Clear 8042 interface. 2. Initialize 8042 self-test.
08h	1. Test special keyboard controller for Winbond 977 series Super I/O chips. 2. Enable keyboard interface.
09h	Reserved
0Ah	1. Disable PS/2 mouse interface (optional). 2. Auto detect ports for keyboard and mouse followed by a port and interface swap (optional). 3. Reset keyboard for Winbond 977 series Super I/O chips.
0Bh	Reserved
0Ch	Reserved
0Dh	Reserved
0Eh	Test F000h segment shadow to see whether it is R/W-able or not. If test fails, keep beeping the speaker.
0Fh	Reserved
10h	Auto detect flash type to load appropriate flash R/W codes into the run time area in F000 for ESCD & DMI support.

POST (hex)	Description
11h	Reserved
12h	Use walking 1's algorithm to check out interface in CMOS circuitry. Also set real-time clock power status, and then check for override.
13h	Reserved
14h	Program cipset defaults into chipset. Chipset default values are MODBINable by OEM customers.
15h	Reserved
16h	Initial Early_Init_Onboard_Generator switch.
17h	Reserved
18h	Detect CPU information including brand, SMI type (Cyrix or Intel) and CPU level (586 or 686).
19h	Reserved
1Ah	Reserved
1Bh	Initial interrupts vector table, If no special specified, all H/W interrupts are directed to SPURIOUS_INT_HDLR & S/W interrupts to SPURIOUS_soft_HDLR.
1Ch	Reserved
1Dh	Initial EARLY_PM_INIT switch.
1Eh	Reserved
1Fh	Load keyboard matrix (notebook platform).
20h	Reserved
21h	HPM initialization (notebook platform)
22h	Reserved
23h	<ol style="list-style-type: none"> 1. Check validity of RTC value, e.g. a value of 5Ah is an invalid value for RTC minute 2. Load CMOS settings into BIOS stack. If CMOS checksum fails, use default value instead. 3. Prepare BIOS resource map for PCI and PnP use. If ESCD is valid, take into consideration of the ESCD's legacy information. 4. Onboard clock generator initialization. Disable respective clock resource to empty PCI and DIMM slots. 5. Early PCI initialization: <ul style="list-style-type: none"> - Enumerate PCI bus number. - Assign memory and I/O resource. - Search for a valid VGA device and VGA BIOS and put it into C000:0.
24h	Reserved
25h	Reserved
26h	Reserved
27h	Initialize INT 09 buffer.
28h	Reserved
29h	<ol style="list-style-type: none"> 1. Program CPU internal MTRR (P6 & PII) for 0-64K memory address. 2. Initialize the APIC for Pentium class CPU. 3. Program early chipset according to CMOS setup. Example: onboard IDE controller. 4. Measure CPU speed. 5. Invoke video BIOS.

POST (hex)	Description
2Ah	Reserved
2Bh	Reserved
2Ch	Reserved
2Dh	1. Initialize multi-language. 2. Put information on screen display, including Award title, CPU type, CPU speed, etc.
2Eh	Reserved
2Fh	Reserved
30h	Reserved
31h	Reserved
32h	Reserved
33h	Reset keyboard except Winbond 977 series Super I/O chips.
34h	Reserved
35h	Reserved
36h	Reserved
37h	Reserved
38h	Reserved
39h	Reserved
3Ah	Reserved
3Bh	Reserved
3Ch	Test 8254
3Dh	Reserved
3Eh	Test 8259 interrupt mask bits for channel 1.
3Fh	Reserved
40h	Test 8259 interrupt mask bits for channel 2.
41h	Reserved
42h	Reserved
43h	Test 8259 functionality.
44h	Reserved
45h	Reserved
46h	Reserved
47h	Initialize EISA slot.
48h	Reserved
49h	1. Calculate total memory by testing the last double word of each 64K page. 2. Program writes allocation for AMD K5 CPU.
4Ah	Reserved
4Bh	Reserved

POST (hex)	Description
4Ch	Reserved
4Dh	Reserved
4Eh	<ol style="list-style-type: none"> 1. Program MTRR of M1 CPU. 2. Initialize L2 cache for P6 class CPU & program CPU with proper cacheable range. 3. Initialize the APIC for P6 class CPU. 4. On MP platform, adjust the cacheable range to smaller one in case the cacheable ranges between each CPU are not identical.
4Fh	Reserved
50h	Initialize USB.
51h	Reserved
52h	Test all memory (clear all extended memory to 0).
53h	Reserved
54h	Reserved
55h	Display number of processors (multi-processor platform).
56h	Reserved
57h	<ol style="list-style-type: none"> 1. Display PnP logo. 2. Early ISA PnP initialization. <ul style="list-style-type: none"> - Assign CSN to every ISA PnP device.
58h	Reserved
59h	Initialize the combined Trend Anti-Virus code.
5Ah	Reserved
5Bh	Show message for entering AWDFLASH.EXE from FDD (optional feature)
5Ch	Reserved
5Dh	<ol style="list-style-type: none"> 1. Initialize Init_Onboard_Super_IO switch. 2. Initialize Init_Onboard_AUDIO switch.
5Eh	Reserved
5Fh	Reserved
60h	Ok to enter setup utility; i.e. not until this POST stage can users enter the CMOS utility.
61h	Reserved
62h	Reserved
63h	Reserved
64h	Reserved
65h	Initialize PS/2 mouse.
66h	Reserved
67h	Prepare memory size information for function call: INT 15h ax=E820h
68h	Reserved
69h	Turn on L2 cache.
70h	Reserved

POST (hex)	Description
71h	Reserved
72h	Reserved
73h	(Optional feature) Enter AWDFLASH.EXE if: - AWDFLASH is found in floppy drive. - ALT+F2 is pressed
74h	Reserved
75h	Detect and install all IDE devices: HDD, LS120, ZIP, CD-ROM, etc.
76h	Reserved
77h	Detect serial ports and parallel ports.
78h	Reserved
79h	Reserved
7Ah	Detect and install co-processor.
7Bh	Reserved
7Ch	Reserved
7Dh	Reserved
7Eh	Reserved
7Fh	1. Switch back to text mode if full screen logo is supported. - If errors occur, report errors and wait for keys. - If no errors occur or F1 key is pressed to continue: Clear EPA or customization logo.
80h	Reserved
81h	Reserved
82h	1. Call chipset power management hook. 2. Recover the text font used by EPA logo (not for full screen logo).
83h	Save all data in stack back to CMOS.
84h	Initialize ISA PnP boot devices.
85h	1. USB final initialization. 2. NET PC: Build SYSID structure. 3. Switch screen back to text mode. 4. Set up ACPI table at top of memory. 5. Invoke ISA adapter ROMS. 6. Assign IRQs to PCI devices. 7. Initialize APM. 8. Clear noise of IRQs.
86h	Reserved
87h	Reserved
88h	Reserved
89h	Reserved
90h	Reserved
91h	Reserved
92h	Reserved

POST (hex)	Description
93h	Read HDD boot sector information for Trend Anti-Virus.
94h	<ol style="list-style-type: none"> 1. Enable L2 cache. 2. Program boot up speed. 3. Chipset final initialization. 4. Power management final initialization. 5. Clear screen and display memory table. 6. Program K6 write allocation. 7. Program P6 class write combining.
95h	<ol style="list-style-type: none"> 1. Program daylight saving 2. Update keyboard LED and typematic rate.
96h	<ol style="list-style-type: none"> 1. Build MP table. 2. Build and update ESCD. 3. Set CMOS century to 20h or 19h. 4. Load CMOS time into DOS timer tick. 5. Build MSIRQ routing table.
Ffh	Boot attempt (INT 19h).