



Your Reliable Partner

# **GD8 Series**

**(GD8, GD8-V, GD8-M, GD8-MV)**

---

*Intel Pentium 4 System Board  
Socket 775*

*User's Manual*

---

---

## **Copyright and Warranty Notice**

The information in this document is subject to change without notice and does not represent a commitment on part of the vendor, who assumes no liability or responsibility for any errors that may appear in this manual.

No warranty or representation, either expressed or implied, is made with respect to the quality, accuracy or fitness for any particular part of this document. In no event shall the manufacturer be liable for direct, indirect, special, incidental or consequential damages arising from any defect or error in this manual or product.

Product names appearing in this manual are for identification purpose only and trademarks and product names or brand names appearing in this document are the property of their respective owners.

This document contains materials protected under International Copyright Laws. All rights reserved. No part of this manual may be reproduced, transmitted or transcribed without the expressed written permission of the manufacturer and authors of this manual.

If you do not properly set the motherboard settings, causing the motherboard to malfunction or fail, we cannot guarantee any responsibility.

---

---

# Table of Contents

---

<b>Chapter 1. Introduction .....</b>	<b>1-1</b>
1-1. Features & Specifications .....	1-1
1-2. Layout Diagram .....	1-3
<b>Chapter 2. Hardware Setup.....</b>	<b>2-1</b>
2-1. Install The Motherboard.....	2-1
2-2. Install CPU, Heatsink and Fan Assembly .....	2-2
2-3. Install System Memory .....	2-4
2-4. Connectors, Headers and Switches .....	2-6
(1). ATX Power Input Connectors .....	2-6
(2). FAN Power Connectors.....	2-7
(3). CMOS Memory Clearing Header.....	2-8
(4). Wake-up Header.....	2-9
(5). Front Panel Audio Connection Header.....	2-10
(6). Front Panel Switches & Indicators Headers .....	2-11
(7). Additional USB Port Headers .....	2-12
(8). Internal Audio Connectors .....	2-13
(9). Floppy and IDE Disk Drive Connectors .....	2-14
(10). Serial ATA Connectors .....	2-15
(11). Status Indicators.....	2-15
(12). PCI Express x16 Slot .....	2-16
(13). PCI Express x1 Slots.....	2-16
(14). Back Panel Connectors .....	2-17
<b>Chapter 3. BIOS Setup .....</b>	<b>3-1</b>
3-1. SoftMenu Setup .....	3-2
3-2. Standard CMOS Features.....	3-4
3-3. Advanced BIOS Features.....	3-7
3-4. Advanced Chipset Features.....	3-10
3-5. Integrated Peripherals .....	3-12
3-6. Power Management Setup.....	3-16
3-7. PnP/PCI Configurations .....	3-19
3-8. PC Health Status .....	3-21
3-9. Load Fail-Safe Defaults .....	3-22
3-10. Load Optimized Defaults .....	3-22
3-11. Set Password .....	3-22
3-12. Save & Exit Setup.....	3-22

---

---

3-13. Exit Without Saving.....	3-22
<i>Appendix A. Install Intel Chipset Software Utility.....</i>	<i>A-1</i>
<i>Appendix B. Install Driver for ITE IDE Controller (GD8, GD8-M).....</i>	<i>B-1</i>
<i>Appendix C. Install Audio Driver.....</i>	<i>C-1</i>
<i>Appendix D. Install VGA Driver (GD8-M, GD8-MV).....</i>	<i>D-1</i>
<i>Appendix E. Install LAN Driver.....</i>	<i>E-1</i>
<i>Appendix F. Install USB 2.0 Driver.....</i>	<i>F-1</i>
<i>Appendix G. FlashMenu (BIOS Update Utility).....</i>	<i>G-1</i>
<i>Appendix H. ABIT EQ (The Hardware Doctor Utility).....</i>	<i>H-1</i>
<i>Appendix I. Troubleshooting (Need Assistance?).....</i>	<i>I-1</i>
<i>Appendix J. How to Get Technical Support.....</i>	<i>J-1</i>

## Chapter 1. Introduction

---

### 1-1. Features & Specifications

---

#### 1. LGA775 CPU Socket

- Designed for Intel® 90nm Pentium 4/Celeron D LGA775 processors with 800/533MHz FSB
- Supports Intel® Hyper-Threading Technology

#### 2. Express Chipset

- Intel® 915P / Intel® ICH6 Express Chipset (*For models GD8/GD8-V only*)
- Intel® 915G / Intel® ICH6 Express Chipset (*For models GD8-M/GD8-MV only*)

#### 3. Graphics

- Integrated Intel Graphics Media Accelerator 900 supports DirectX 9 (*For models GD8-M/GD8-MV only*)

#### 4. Memory

- Four 184-pin DIMM slots (Un-buffered Non-ECC DIMM)
- Supports Dual channel DDR 400/333 (Max. 4GB)

#### 5. ABIT Engineered

- ABIT SoftMenu™ Technology
- ABIT CPU ThermalGuard™ Technology
- ABIT EQ™
- ABIT Audio EQ™
- ABIT Flash Menu™

#### 6. SATA 150

- Supports 4 ports SATA 150

#### 7. ATA 133

- Onboard Ultra ATA133 PCI controller (*For models GD8/GD8-M only*)

#### 8. Audio

- Onboard 5.1-channel Audio CODEC
- Audio jack auto sensing

#### 9. Gigabit LAN

- Onboard Gigabit LAN controller supports 10/100/1000M Ethernet

#### 10. Internal I/O Connectors

- 1x PCI Express x16 slot
- 3x PCI Express x1 slots
- 2x PCI slots
- 1x Floppy port supports up to 2.88MB

- 4x SATA 150 connectors
- 1x Ultra ATA 100/66/33 connector
- 2x Ultra ATA133/100/66/33 connectors (*For models GD8/GD8-M only*)
- 2x USB 2.0 headers
- 1x FP-Audio header
- 1x CD-IN header

### **11. Back Panel I/O**

- 1x PS/2 Keyboard, 1x PS/2 mouse
- 1x Serial port, 1x Parallel port
- 1x VGA port (*For models GD8-M/GD8-MV only*)
- 1x AUDIO1 connector (Rear-Left / Rear-Right, Center/Subwoofer)
- 1x AUDIO2 connector (Mic-In, Line-In, Front-Left/Front-Right)
- 2x USB 2.0 connectors
- 2x USB 2.0 connectors, 1x RJ-45 Gigabit LAN connector

### **12. Miscellaneous**

- ATX form factor (305mm x 245mm)

\* Specifications and information contained herein are subject to change without notice.

# 1-2. Layout Diagram

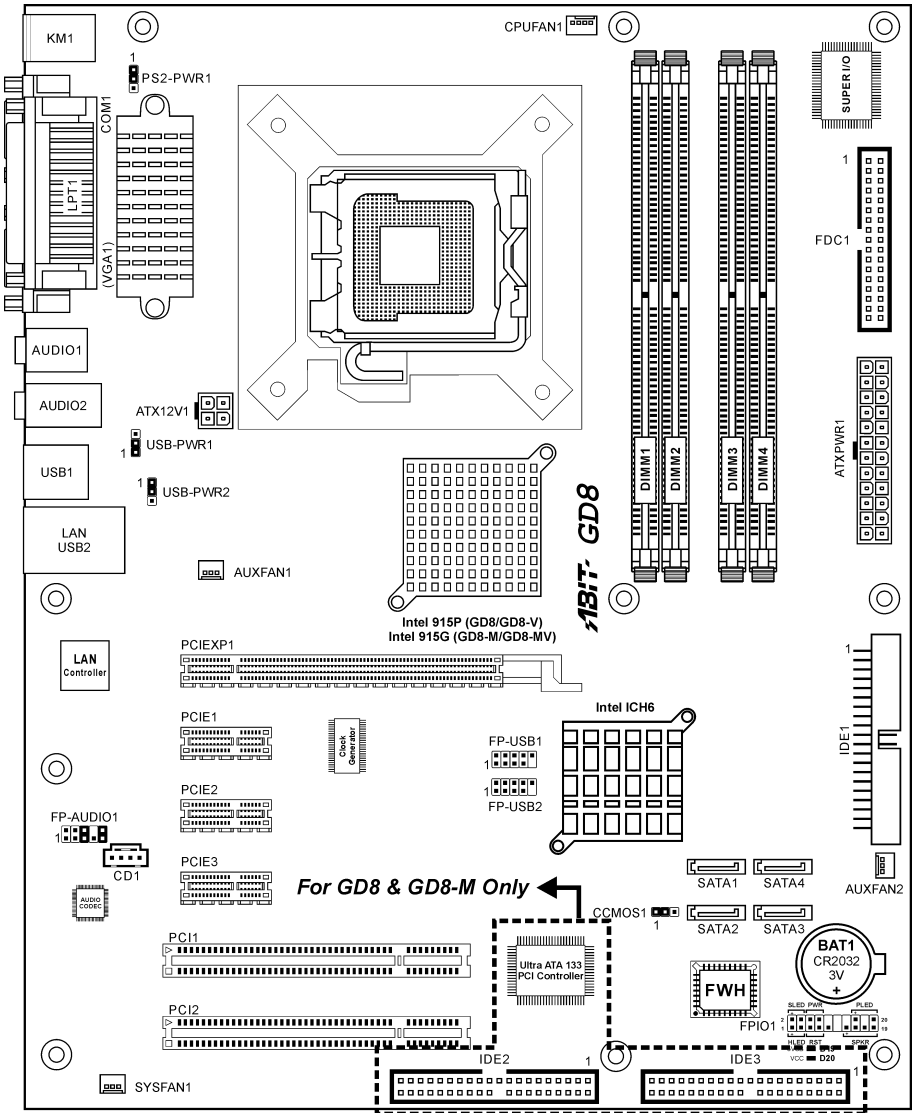





## Chapter 2. Hardware Setup

**Before the Installation:** Turn off the power supply switch (fully turn off the +5V standby power), or disconnect the power cord before installing or unplugging any connectors or add-on cards. Failing to do so may cause the motherboard components or add-on cards to malfunction or damaged.

### 2-1. Install The Motherboard

Most computer chassis have a base with many mounting holes to allow motherboard to be securely attached on and at the same time, prevented from short circuits. There are two ways to attach the motherboard to the chassis base:

1. use with studs
2. or use with spacers

In principle, the best way to attach the board is to use with studs. Only if you are unable to do this should you attach the board with spacers. Line up the holes on the board with the mounting holes on the chassis. If the holes line up and there are screw holes, you can attach the board with studs. If the holes line up and there are only slots, you can only attach with spacers. Take the tip of the spacers and insert them into the slots. After doing this to all the slots, you can slide the board into position aligned with slots. After the board has been positioned, check to make sure everything is OK before putting the chassis back on.

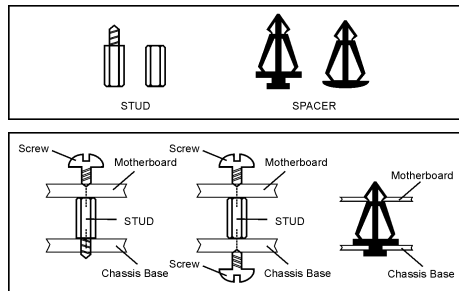

**ATTENTION:** To prevent shorting the PCB circuit, please REMOVE the metal studs or spacers if they are already fastened on the chassis base and are without mounting-holes on the motherboard to align with.

## 2-2. Install CPU, Heatsink and Fan Assembly

*In order to protect the contact pins, please pay attention to these notices:*

1. A maximum 20 cycles of CPU installation is recommended.
2. Never touch the contact pins with fingers or any object.
3. Always put on the cap when the CPU is not in use.

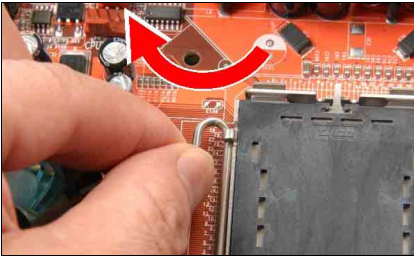

1. Place the board so as to let the lever hook of the socket is on your left side. Use your left thumb and forefinger to hold the lever hook, pull it away from the retention tab.



2. Rotate the lever to fully open position.

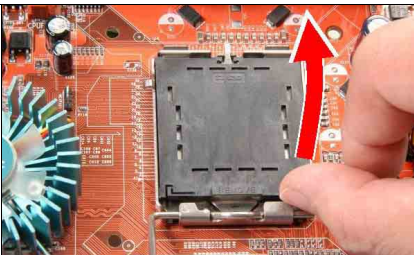

3. Use your right thumb on the bottom-right side of the load plate and lift it up to fully open position.

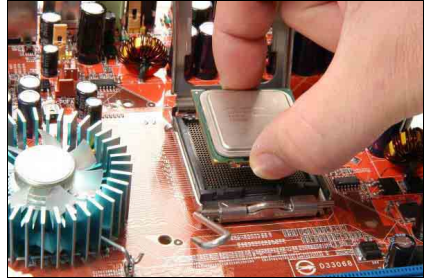

4. Use your right thumb and forefinger to grasp the CPU package. Be sure to grasp on the edge of the substrate, and face the Pin-1 indicator toward the bottom-left side. Aim at the socket and place the CPU package vertical down into the socket.

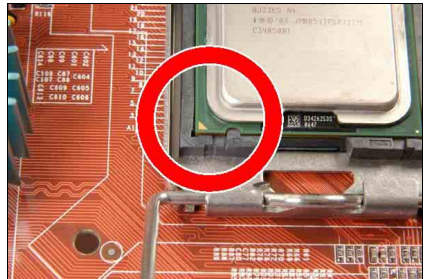

5. Visually inspect if the CPU is seated well into the socket. The alignment key must be located in the notch of package.

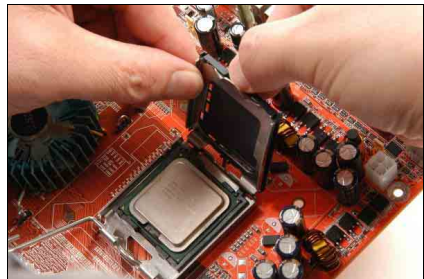

6. Use your left hand to hold the load plate, and use your right thumb to peel the cap off.

*The cap plays an important role in protecting contact pins. In order to prevent bent pin, PUT ON the cap after operation or testing.*



7. Lower the plate onto the CPU package. Engage the load lever while gently pressing down the load plate.



8. Secure the lever with the hook under retention tab.



9. Place the heatsink and fan assembly onto the socket. Align the four fasteners toward the four mounting holes on the motherboard.

*For detailed information on how to install your heatsink and fan assembly, please refer to the instruction manual came packed with the heatsink and fan assembly you bought.*



10. Press each of the four fasteners down into the mounting holes.

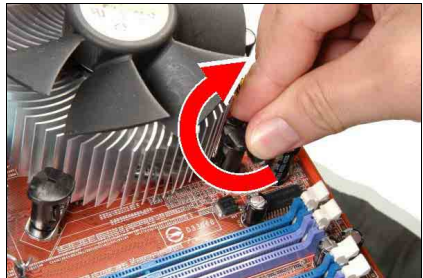

11. Rotate the fastener clock-wise to lock the heatsink and fan assembly into position.

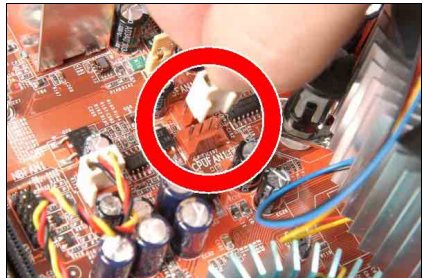

12. Attach the four-pin power plug from the heatsink and fan assembly to the CPU FAN connector.

### 2-3. Install System Memory

The Intel 915P(915G) Express Chipset MCH memory interface is designed with Flex Memory Technology supporting single-channel or dual-channel DDR memory configurations.

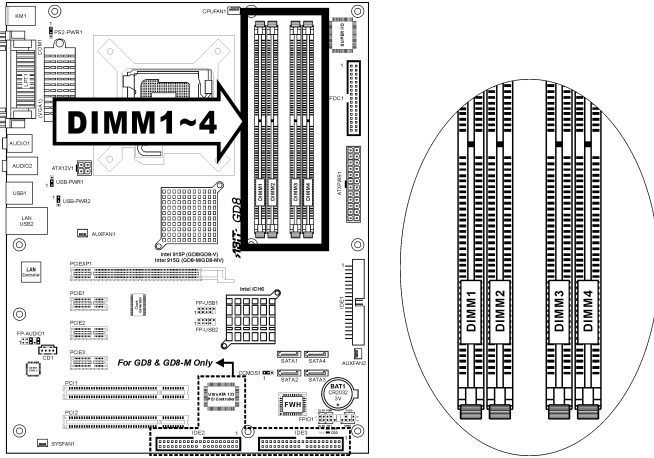

- To reach the optimum performance in dual-channel configurations, install identical DDR DIMM pairs for each channel.
- Install DIMMs with the same CAS latency. To reach the optimum compatibility, obtain memory modules from the same vendor.
- Due to chipset resource allocation, the system may detect less than 4GB of system memory in the installation of four 1GB DDR memory modules.
- Due to chipset limitation, 128MB DIMM modules or double-sided x16 memory chips are not supported.

There are several methods of different DDR configurations depending on how the DIMMs are populated on each system memory channel:

- **[Single Channel]:** only one channel is populated.

Method	Channel A		Channel B	
	DIMM1	DIMM2	DIMM3	DIMM4
1	512MB	-	-	-
2	-	512MB	-	-
3	-	-	512MB	-
4	-	-	-	512MB
5	512MB	512MB	-	-
6	-	-	512MB	512MB

- **[Dual Channel Asymmetric]:** both channels are populated, but each channel has a different amount of total memory. (Channel A  $\neq$  Channel B)

Method	Channel A		Channel B	
	DIMM1	DIMM2	DIMM3	DIMM4
1	512MB	-	256MB	-
2	-	256MB	-	512MB
3	512MB	-	-	256MB
4	-	256MB	512MB	-
5	256MB	256MB	256MB	-
6	256MB	256MB	-	256MB
7	256MB	-	256MB	256MB
8	-	256MB	256MB	256MB
9	256MB	256MB	512MB	512MB
10	256MB	256MB	256MB	512MB

- **[Dual Channel Symmetric]:** both channels are populated where each channel has the same amount of total memory. (Channel A = Channel B)

Method	Channel A		Channel B	
	DIMM1	DIMM2	DIMM3	DIMM4
1	512MB	-	512MB	-
2	-	512MB	-	512MB
3	512MB	-	-	512MB
4	-	512MB	512MB	-
5	256MB	256MB	512MB	-
6	256MB	256MB	-	512MB
7	512MB	-	256MB	256MB
8	-	512MB	256MB	256MB
9	512MB	256MB	512MB	256MB
10	256MB	512MB	256MB	512MB

Power off the computer and unplug the AC power cord before installing or removing memory modules.

1. Locate the DIMM slot on the board.
2. Hold two edges of the DIMM module carefully, keep away of touching its connectors.
3. Align the notch key on the module with the rib on the slot.
4. Firmly press the module into the slots until the ejector tabs on both sides of the slot automatically snaps into the mounting notch. Do not force the DIMM module in with extra force as the DIMM module only fit in one direction.
5. To remove the DIMM modules, push the two ejector tabs on the slot outward simultaneously, and then pull out the DIMM module.

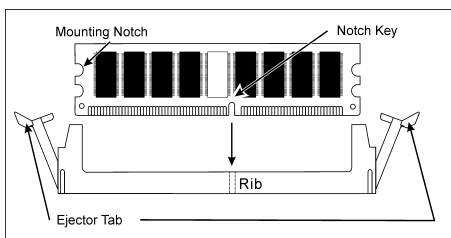

**ATTENTION:** Static electricity can damage the electronic components of the computer or optional boards. Before starting these procedures, ensure that you are discharged of static electricity by touching a grounded metal object briefly.

## 2-4. Connectors, Headers and Switches

Here we will show you all of the connectors, headers and switches, and how to connect them. Please read the entire section for necessary information before attempting to finish all the hardware installation inside the computer chassis. A complete enlarged layout diagram is shown in Chapter 1 for all the position of connectors and headers on the board that you may refer to.

**WARNING:** Always power off the computer and unplug the AC power cord before adding or removing any peripheral or component. Failing to do so may cause severe damage to your motherboard and/or peripherals. Plug in the AC power cord only after you have carefully checked everything.

### (1). ATX Power Input Connectors

This motherboard provides two power connectors to connect power supplier.

**NOTE:** This 24-pin power connector “ATXPWR1” is compliant to the former 20-pin type. Pay attention to the orientation when doing so (Pin-11, 12, 23, and 24 should be left un-connected).

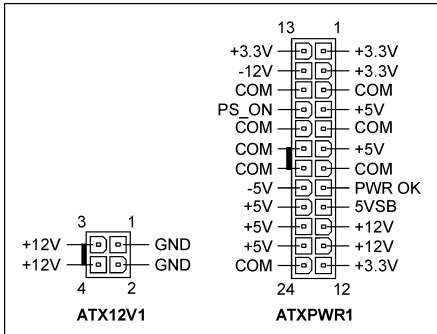
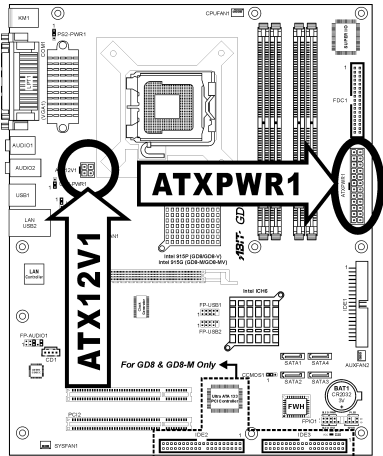

**(2). FAN Power Connectors**

These connectors each provide power to the cooling fans installed in your system.

- **CPUFAN1:** CPU Fan Power Connector
- **SYSFAN1:** System Fan Power Connector
- **AUXFAN1, AUXFAN2:** Auxiliary Fan Power Connector

**WARNING:** These fan connectors are not jumpers. **DO NOT** place jumper caps on these connectors.

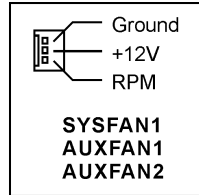
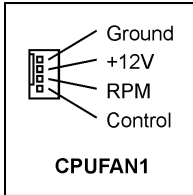
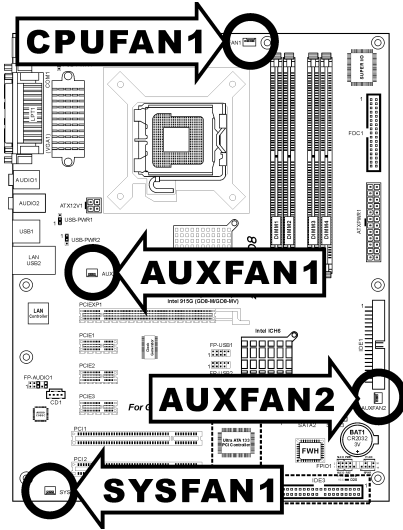

**(3). CMOS Memory Clearing Header**

This header uses a jumper cap to clear the CMOS memory.

- **Pin 1-2 shorted (default):** Normal operation.
- **Pin 2-3 shorted:** Clear CMOS memory.

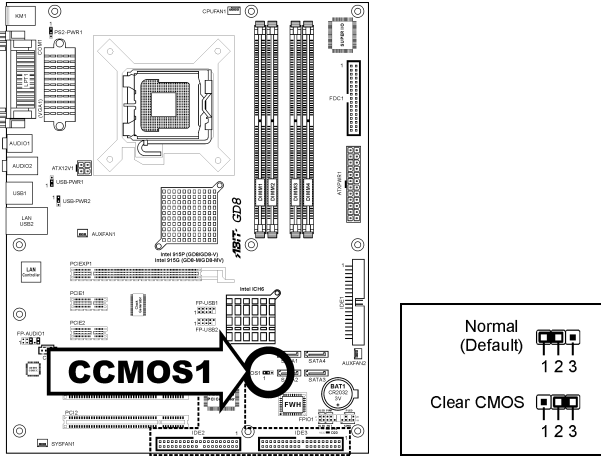

**WARNING:** Turn the power off first (including the +5V standby power) before clearing the CMOS memory. Failing to do so may cause your system to work abnormally or malfunction.



**(4). Wake-up Header**

These headers use a jumper cap to enable/disable the wake-up function.

- **PS2-PWR1:**  
Pin 1-2 shorted (default): Disable wake-up function support at Keyboard/Mouse port.  
Pin 2-3 shorted: Enable wake-up function support at Keyboard/Mouse port
- **USB-PWR1:**  
Pin 1-2 shorted (default): Disable wake-up function support at USB1 port.  
Pin 2-3 shorted: Enable wake-up function support at USB1 port.
- **USB-PWR2:**  
Pin 1-2 shorted (default): Disable wake-up function support at USB2 port.  
Pin 2-3 shorted: Enable wake-up function support at USB2 port

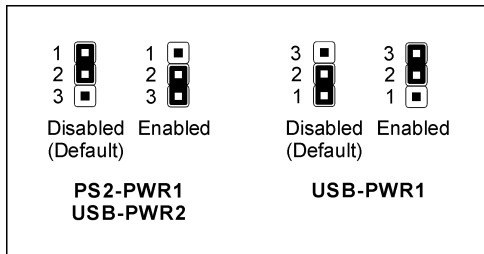
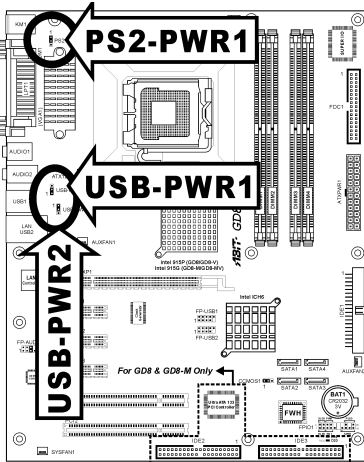

**(5). Front Panel Audio Connection Header**

This header provides the connection to audio connector at front panel.

- To use the audio connector at front panel, remove all the jumpers on this header, and then connect to front panel by the extension cable provided with the chassis.
- To use the audio connector at rear panel, disconnect the extension cable, attach the jumpers back at pin 5-6, and pin 9-10 (default setting).

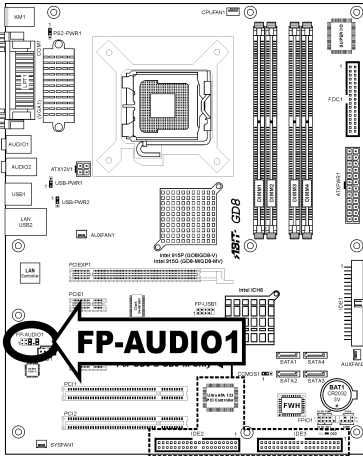

Pin	Pin Assignment		
	Pin	Pin Assignment	
1	Audio Mic.	2	Ground
3	Audio Mic. Bias	4	VCC
5	Speaker Out Right Channel	6	Speaker Out Right Channel Return
7	X	8	NC
9	Speaker Out Left Channel	10	Speaker Out Left Channel Return

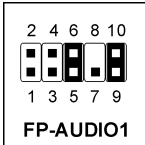

**(6). Front Panel Switches & Indicators Headers**

This header is used for connecting switches and LED indicators on the chassis front panel.

Watch the power LED pin position and orientation. The mark “+” align to the pin in the figure below stands for positive polarity for the LED connection. Please pay attention to connect these headers. A wrong orientation will only cause the LED not lighting, but a wrong connection of the switches could cause system malfunction.

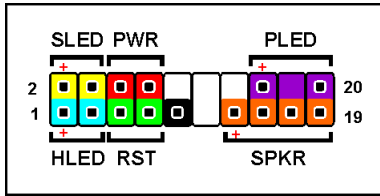
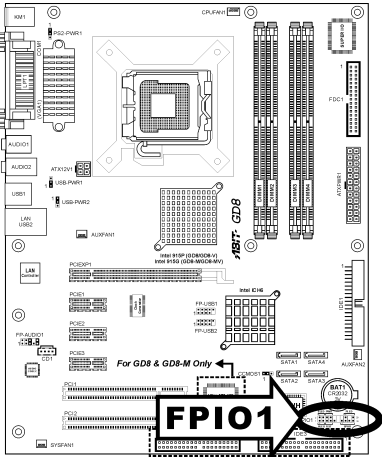

- **HLED (Pin 1, 3):**  
Connects to the HDD LED cable of chassis front panel.
- **RST (Pin 5, 7):**  
Connects to the Reset Switch cable of chassis front panel.
- **SPKR (Pin 13, 15, 17, 19):**  
Connects to the System Speaker cable of chassis.
- **SLED (Pin 2, 4):**  
Connects to the Suspend LED cable (if there is one) of chassis front panel.
- **PWR (Pin 6, 8):**  
Connects to the Power Switch cable of chassis front panel.
- **PLED (Pin 16, 18, 20):**  
Connects to the Power LED cable of chassis front panel.

**(7). Additional USB Port Headers**

These headers each provide 2 additional USB 2.0 ports connection through an USB cable designed for USB 2.0 specifications.

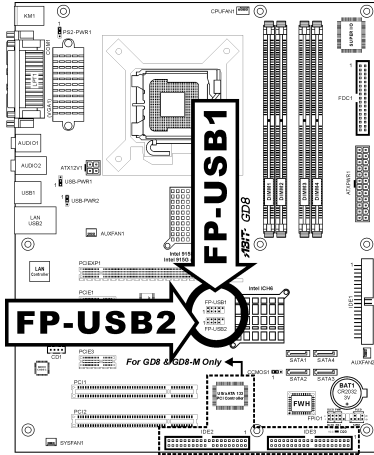

<p>FP-USB1 FP-USB2</p>	Pin	Pin Assignment	Pin	Pin Assignment
	1	VCC	2	VCC
	3	Data0 -	4	Data1 -
	5	Data0 +	6	Data1 +
	7	Ground	8	Ground
	9	NC	10	NC

**(8). Internal Audio Connectors**

This connector connects to the audio output of internal CD-ROM drive or add-on card.

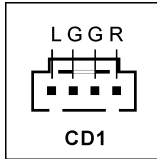
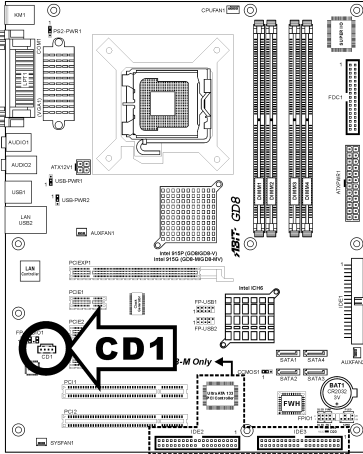

**(9). Floppy and IDE Disk Drive Connectors**

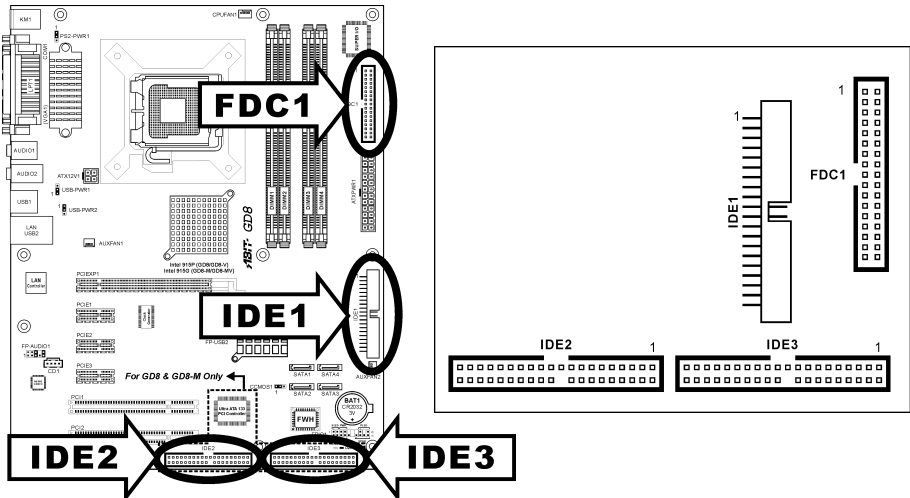

The FDC1 connector connects up to two floppy drives with a 34-wire, 2-connector floppy cable. Connect the single end at the longer length of ribbon cable to the FDC1 on the board, the two connectors on the other end to the floppy disk drives connector. Generally you need only one floppy disk drive in your system.

**NOTE:** The red line on the ribbon cable must be aligned with pin-1 on both the FDC1 port and the floppy connector.

Port [IDE1] connects up to two Ultra ATA/100 IDE drives. For models “GD8” and “GD8-M”, two additional Ultra ATA 133/100/66/33 IDE ports are supported via [IDE2] and [IDE3] connectors.

Connect the single end (blue connector) at the longer length of ribbon cable to the IDE port of this board, the other two ends (gray and black connector) at the shorter length of the ribbon cable to the connectors of your hard drives.

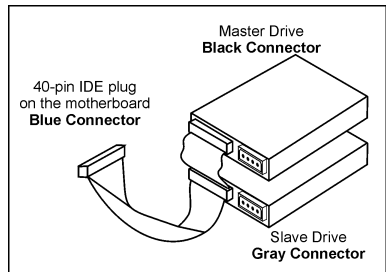

**NOTE:** Make sure to configure the “Master” and “Slave” relation before connecting two drives by one single ribbon cable. The red line on the ribbon cable must be aligned with pin-1 on both the IDE port and the hard-drive connector.

**(10). Serial ATA Connectors**

These connectors are provided to attach one Serial ATA device at each channel via Serial ATA cable.

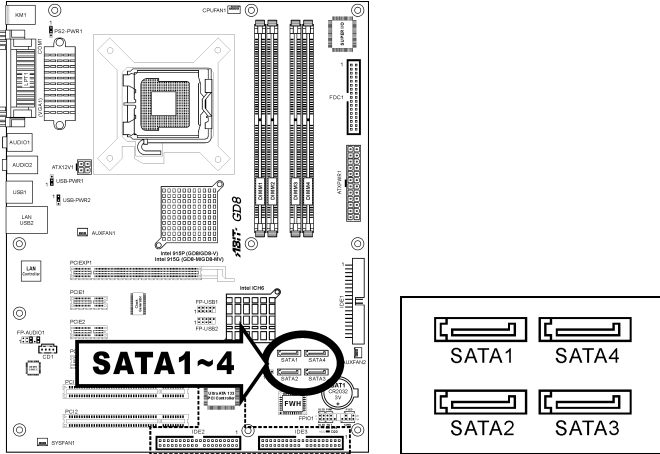

For more information on how to configure the function mode for SATA, please refer to the item “On-Chip Serial ATA” in the BIOS menu of “OnChip IDE Device”.

**(11). Status Indicators**

- **D19 (5VSB):** This LED lights up when the power supply is connected with power source.
- **D20 (VCC):** This LED lights up when the system power is on.

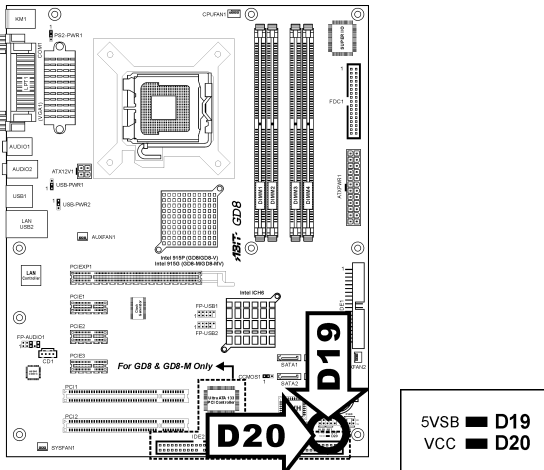

**(12). PCI Express x16 Slot**

This slot is used to attach the next generation of graphics architecture.

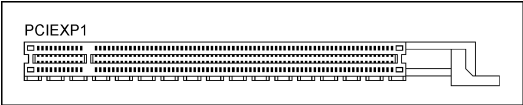
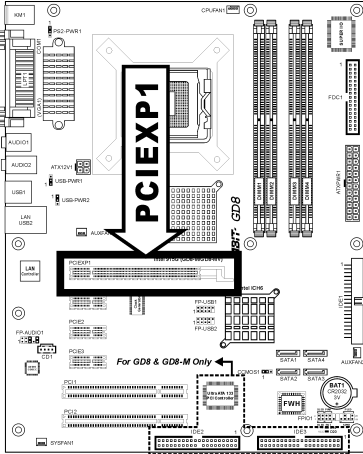

**(13). PCI Express x1 Slots**

These slots are used to attach the next generation of I/O architecture.

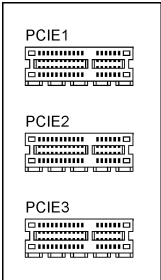
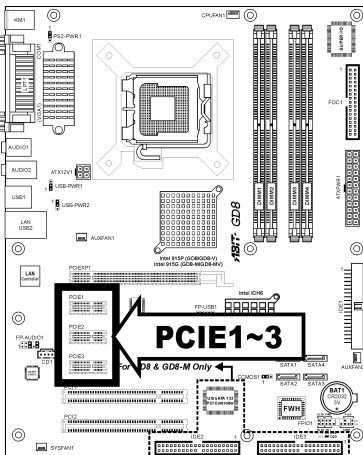

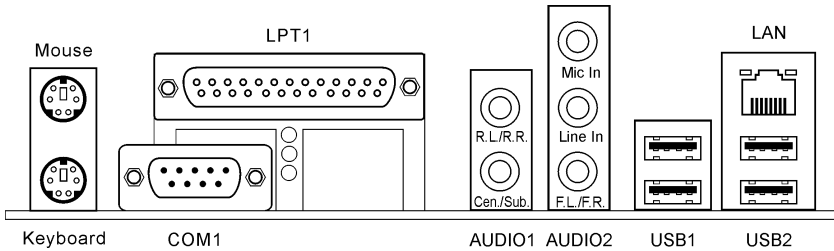
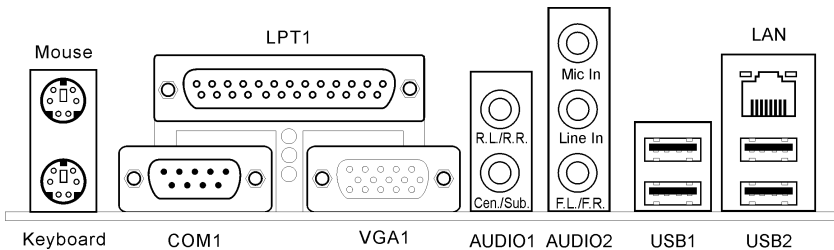

**(14). Back Panel Connectors****GD8/GD8-V:****GD8-M/GD8-MV:**

- **Mouse:** Connects to PS/2 mouse.
- **Keyboard:** Connects to PS/2 keyboard.
- **LPT1:** Connects to printer or other devices that support this communication protocol.
- **COM1:** Connects to external modem, mouse or other devices that support this communication protocol.
- **VGA1:** Connects to monitor input. *(For models GD8-M/GD8-MV only)*
- **AUDIO1:**
  - R.L./R.R. (Rear Left / Rear Right):** Connects to the rear left and rear right channel in the 5.1 channel audio system.
  - Cen./Sub. (Center / Subwoofer):** Connects to the center and subwoofer channel in the 5.1 channel audio system.
- **AUDIO2:**
  - Mic In:** Connects to the plug from external microphone.
  - Line In:** Connects to the line out from external audio sources.
  - F.L./F.R. (Front Left / Front Right):** Connects to the front left and front right channel in the 5.1-channel or regular 2-channel audio system.
- **LAN:** Connects to Local Area Network.
- **USB1/USB2:** Connects to USB devices such as scanner, digital speakers, monitor, mouse, keyboard, hub, digital camera, joystick etc.



## Chapter 3. BIOS Setup

This motherboard provides a programmable EEPROM that you can update the BIOS utility. The BIOS (Basic Input/Output System) is a program that deals with the basic level of communication between processor and peripherals. Use the BIOS Setup program only when installing motherboard, reconfiguring system, or prompted to “Run Setup”. This chapter explains the Setup Utility of BIOS utility.

After powering up the system, the BIOS message appears on the screen, the memory count begins, and then the following message appears on the screen:

**PRESS DEL TO ENTER SETUP**

If this message disappears before you respond, restart the system by pressing <Ctrl> + <Alt> + <Del> keys, or by pressing the Reset button on computer chassis. Only when it failed by these two methods can you restart the system by powering it off and then back on.

After pressing <Del> key, the main menu screen appears.

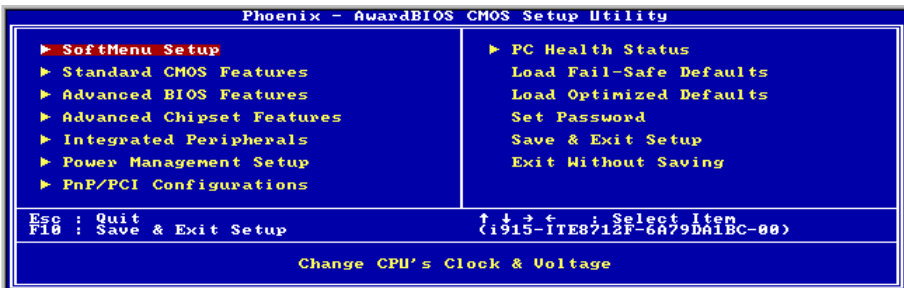

**NOTE:** In order to increase system stability and performance, our engineering staffs are constantly improving the BIOS menu. *The BIOS setup screens and descriptions illustrated in this manual are for your reference only, and may not completely match with what you see on your screen.*

## 3-1. SoftMenu Setup

The SoftMenu utility is ABIT's exclusive and ultimate solution in programming the CPU operating speed. All the parameters regarding CPU FSB speed, multiplier factor, the AGP & PCI clock, and even the CPU core voltage are all available at your fingertips.

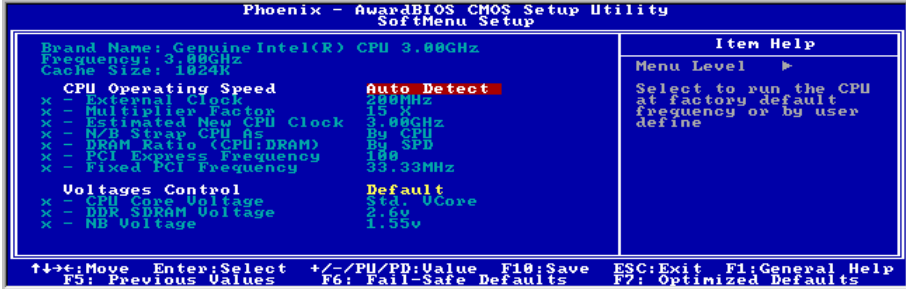

### Brand Name:

This item displays the CPU model name.

### Frequency:

This item displays the processor speed.

### Cache Size:

This item displays the L2 cache size of your CPU.

### CPU Operating Speed:

This item displays the CPU operating speed according to the type and speed of your CPU. You can also select the [User Define] option to enter the manual option.

### User Define:

**WARNING:** The wrong settings of the multiplier and external clock in certain circumstances may cause CPU damage. Setting the working frequency higher than the PCI chipset or processor specs, may cause abnormal memory module functioning, system hangs, hard disk drive data lose, abnormal functioning of the VGA card, or abnormal functioning with other add-on cards. Using non-specification settings for your CPU is not the intention of this explanation. These should be used for engineering testing, not for normal applications.

There will be no guaranty for the settings beyond specification, any damage of any component on this motherboard or peripherals result therein is not our responsibility.

### \* External Clock:

This item selects the external clock frequency.

---

**\* Multiplier Factor:**

This item displays the multiplier factors for your CPU.

**\* Estimated new CPU Clock:**

This item displays the frequency sum up from the previous item [External Clock] and [Multiplier Factor].

**\* N/B Strap CPU As:**

This item sets the external hardware reset strap assigned to MCH (Memory Controller Hub). The options are: [PSB533], [PSB800], and [By CPU]. The default setting is **By CPU**.

To set this option manually:

- Select [PSB533] for CPU of 133MHz FSB frequency.
- Select [PSB800] for CPU of 200MHz FSB frequency.

**\* DRAM Ratio (CPU:DRAM):**

This item determines the frequency ratio between CPU and DRAM.

**\* PCI Express Frequency:**

This item determines the frequency for PCI Express.

**\* Fixed PCI Frequency:**

This item determines the PCI bus frequency. This option allows you to keep your PCI clock at some fixed frequency to improve system stability.

---

**Voltage Control:**

This item selects the voltage supplied to your system.

To adjust the following items manually, select the “Manual” option.

**\* CPU Core Voltage:**

This item selects the CPU core voltage.

**ATTENTION:** A wrong voltage setting may cause the system unstable or even damage the CPU. Please leave it to default settings unless you are fully aware of its consequences.

**\* DDR SDRAM Voltage:**

This item selects the voltage supplied to memory slots.

**\* NB Voltage:**

This item selects the voltage supplied to North Bridge.

## 3-2. Standard CMOS Features

This section contains the basic configuration parameters of the BIOS. These parameters include date, hour, VGA card, FDD, and HDD settings.



### Date (mm:dd:yy):

This item sets the date you specify (usually the current date) in the format of [Month], [Date], and [Year].

### Time (hh:mm:ss):

This item sets the time you specify (usually the current time) in the format of [Hour], [Minute], and [Second].

### ☛ IDE Channel 1 Master/Slave, IDE Channel 2 Master/Slave, IDE Channel 3 Master/Slave, IDE Channel 4 Master/Slave:

Click <Enter> key to enter its submenu:

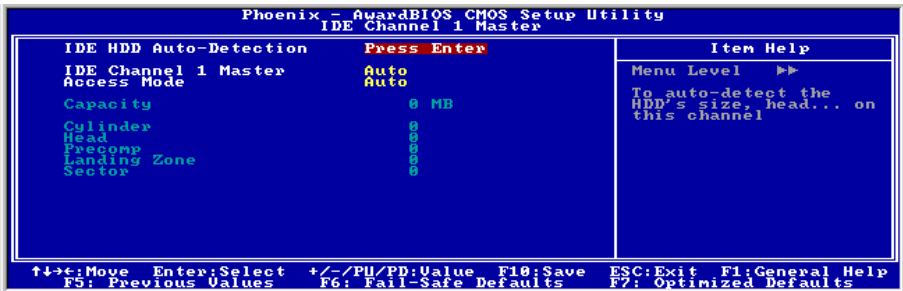

**NOTE:** The items “IDE Channel 3 Master/Slave” and “IDE Channel 4 Master/Slave” appear only when the item “On-Chip Serial ATA” in the “OnChip IDE Device” menu is set to [Enhanced Mode], or set to [Auto Mode] when SATA ports are connected with devices.

---

**IDE HDD Auto-Detection:**

This item allows you to detect the parameters of IDE drives by pressing <Enter> key. The parameters will be shown on the screen automatically.

---

**IDE Channel 1 Master/Slave, IDE Channel 2 Master/Slave, Extended IDE Drive:**

When set to [Auto], the BIOS will automatically check what kind of IDE drive you are using. If you want to define your own drive by yourself, set it to [Manual] and make sure you fully understand the meaning of the parameters. Please refer to the instruction manual provided by the device's manufacturer to get the setting right.

---

**Access Mode:**

This item selects the mode to access your IDE devices. Leave this item to its default [Auto] setting to detect the access mode of your HDD automatically.

---

**Capacity:**

This item displays the approximate capacity of the disk drive. Usually the size is slightly greater than the size of a formatted disk given by a disk-checking program.

---

**Cylinder:**

This item configures the numbers of cylinders.

---

**Head:**

This item configures the numbers of read/write heads.

---

**Precomp:**

This item displays the number of cylinders at which to change the write timing.

---

**Landing Zone:**

This item displays the number of cylinders specified as the landing zone for the read/write heads.

---

**Sector:**

This item configures the numbers of sectors per track.

---

**↩ Back to Standard CMOS Features Setup Menu:**

---

**Drive A & Drive B:**

This item sets the type of floppy drives (usually only Drive A) installed.

---

**Floppy 3 Mode Support:**

This item allows you to use "3 Mode Floppy Drive" in Japanese computer system by selecting drive A, B, or both. Leave this item to its default [Disabled] setting if you are not using this Japanese standard floppy drive.

**Halt On:**

This item determines whether the system stops if an error is detected during system boot-up.

**[All Errors]:** The system-boot will stop whenever the BIOS detect a non-fatal error.

**[No Errors]:** The system-boot will not stop for any error detected.

**[All, But Keyboard]:** The system-boot will stop for all errors except a keyboard error.

**[All, But Diskette]:** The system-boot will stop for all errors except a diskette error.

**[All, But Disk/Key]:** The system-boot will stop for all errors except a diskette or keyboard error.

---

**Base Memory:**

This item displays the amount of base memory installed in the system. The value of the base memory is typically 640K for system with 640K or more memory size installed on the motherboard.

---

**Extended Memory:**

This item displays the amount of extended memory detected during system boot-up.

---

**Total Memory:**

This item displays the total memory available in the system.

---



### 3-3. Advanced BIOS Features



#### CPU L3 Cache:

This item is used to enable the L3 cache (default setting), and appears only for certain CPU (Intel Pentium 4 processor with HT Technology Extreme Edition) that possesses L3 cache.

#### Hyper-Threading Technology

This item is used to enable the functionality of the processor with Hyper-Threading Technology and will appear only when using such processor.

The Hyper-Threading Technology helps your PC work more efficiently by maximizing processor resources and enabling a single processor to run two separate threads of software simultaneously, bringing forth greater performance and system responsiveness when running multiple applications at once.

#### Quick Power On Self Test:

When set to [Enabled], this item speeds up the Power On Self Test (POST) after powering on the system. The BIOS shorten or skip some check during the POST.

#### CPU Feature:

Click <Enter> key to enter its submenu:



---

**Delay Prior to Thermal:**

This item selects the delay time before thermal activation.

---

**Thermal Management**

This item selects the type of thermal monitoring.

---

**Limit CPUID MaxVal**

When set to [Enabled], this item limits the CPUID maximum value to 3, which is usually required for older OS like Windows NT4.0.

Leave this item to its default [Disabled] settings for OS like Windows XP.

---

**↶ Back to Advanced BIOS Features Setup Menu:**

---

**Hard Disk Boot Priority:**

This item selects the hard disks booting priority. By pressing <Enter> key, you can enter its submenu where the hard disks detected can be selected for the booting sequence to boot up system.

This item functions only when there is the option of [Hard Disk] in any one of the First/Second/Third Boot Device items.

---

**First Boot Device / Second Boot Device / Third Boot Device / Boot Other Device:**

Select the drive to boot first, second and third in the [First Boot Device], [Second Boot Device], and [Third Boot Device] items respectively. The BIOS will boot the operating system according to the sequence of the drive selected. Set [Boot Other Device] to [Enabled] if you wish to boot from another device other than these three items.

---

**Boot Up Floppy Seek:**

When set to [Enabled], the BIOS will check whether the floppy disk drive is installed or not.

---

**Boot Up NumLock Status:**

This item determines the default state of the numeric keypad at system booting up.

**[On]:** The numeric keypad functions as number keys.

**[Off]:** The numeric keypad functions as arrow keys.

---

**Security Option:**

This item determines when the system will prompt for password - every time the system boots or only when enters the BIOS setup.

**[Setup]:** The password is required only when accessing the BIOS Setup.

**[System]:** The password is required each time the computer boots up.

**NOTE:** Don't forget your password. If you forget the password, you will have to open the computer case and clear all information in the CMOS before you can start up the system. But by doing this, you will have to reset all previously set options.

---

---

---

**MPS Version Ctrl For OS:**

This item specifies which version of MPS (Multi-Processor Specification) this motherboard will use. Leave this item to its default setting.

---

**Report No FDD For OS:**

When set to [Yes], this item allows you to run some older operating system without floppy disk drive. Leave this item to its default setting.

---

**Delay IDE Initial (Secs):**

This item allows the BIOS to support some old or special IDE devices by prolonging this delay time. A larger value will give more delay time to the device for which to initialize and to prepare for activation.

---

**Intel OnScreen Branding:**

This item determines whether to display the “Intel Inside” logo or not at system boots up.

---

**Disable Unused PCI Clock:**

This option disables the clock of PCI slot that is not in use.

**[Yes]:** The system automatically detect the unused DIMM and PCI slots, and stop sending clock signal to these unused PCI slots.

**[No]:** The system always send clock signal to all PCI slots.

**NOTE:** Set this option to [No] setting if there are adapters that cannot be automatically detected by the system and will cause malfunction.

### 3-4. Advanced Chipset Features



#### DRAM Timing Selectable:

This item sets the optimal timings for the following four items, depending on the memory module you are using. The default setting “By SPD” configures these four items by reading the contents in the SPD (Serial Presence Detect) device. The EEPROM on the memory module stores critical parameter information about the module, such as memory type, size, speed, voltage interface, and module banks.

##### \* CAS Latency Time:

This item controls the latency between the DRAM read command and the time that the data becomes actually available.

##### \* DRAM RAS# to CAS# Delay

This item controls the latency between the DRAM active command and the read/write command.

##### \* DRAM RAS# Precharge:

This item controls the idle clocks after issuing a precharge command to the DRAM.

##### \* Precharge Delay (tRAS)

This item controls the number of DRAM clocks used for the DRAM parameters.

#### Memory Hole At 15M-16M:

When set to [Enabled], the memory address space at 15M-16M will be reserved for ISA expansion cards that specifically requires this setting. This makes the memory from 15MB and up unavailable to the system. Leave this item to its default setting.

### ⚡ PCI Express Root Port Func:

Click <Enter> key to enter its submenu:



#### PCI Express Slot 1 ~ PCI Express Slot 3:

This option enables or disables the PCI Express port function.

#### PCI-E Compliancy Mode:

This item selects the mode for PCI Express add-on card.

### ⚡ Back to Advanced Chipset Features Setup Menu:

#### Init Display First:

This item selects whether to initiates from “PCI Express Slot” or “PCI Slot” first when system boots up.

#### PEG/Onchip VGA Control:

This item selects which one to initiates from “Onchip VGA” or “PEG Port” when system boots up.

Leave this item to its default [Auto] settings.

#### PEG Force X1:

When set to [Enabled], this item forces the PEG port down to x1 mode.

#### OnChip Video Memory Size:

This option specifies the amount of system memory that can be used by the AGP device. The aperture is a portion of the PCI memory address range dedicated for graphics memory address space.

## 3-5. Integrated Peripherals

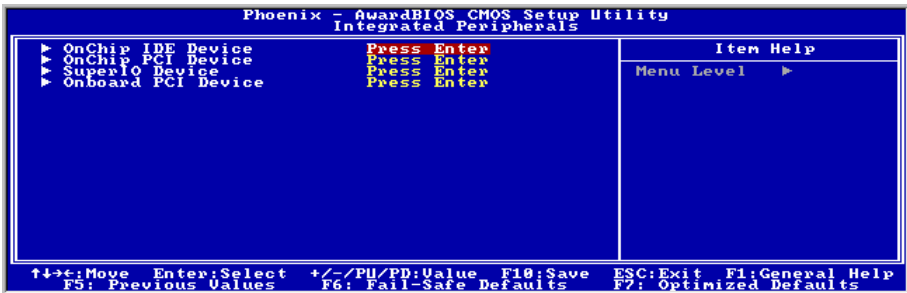

### ☛ OnChip IDE Device:

Click <Enter> key to enter its submenu:



### IDE Bus Master:

This option enables or disables the IDE bus mastering capability under the DOS environment.

### OnChip IDE-1 Controller:

This item selects whether to enable or disable the IDE-1 controller.

### OnChip Serial ATA:

This item determines the function for on-chip Serial ATA.

**[Disabled]:** Disable the Serial ATA controller.

**[Auto]:** Allows the Serial ATA controller to be arranged by BIOS automatically.

**[Combined Mode]:** Parallel ATA and Serial ATA are combined together. Supports up to 4 IDE drives.

**[Enhanced Mode]:** Enable both Parallel ATA and Serial ATA. Supports up to 6 IDE drives.

**[SATA Only]:** The SATA is operating in legacy mode.

**NOTE:** This option is configurable only when the item [SATA Mode] is set to [IDE].

Mode	IDE Channel 1 Master	IDE Channel 1 Slave	IDE Channel 2 Master	IDE Channel 2 Slave	IDE Channel 3 Master	IDE Channel 3 Slave	IDE Channel 4 Master	IDE Channel 4 Slave
Enhanced	IDE1 Master	IDE1 Slave	None	None	SATA1	SATA3	SATA2	SATA4
Combined	IDE1 Master	IDE1 Slave	SATA2	SATA4	None	None	None	None
SATA Only	SATA1	SATA3	SATA2	SATA4	None	None	None	None

**NOTE:** The option [Enhanced Mode] does not support the Windows 98/ME operation system.

#### \* Parallel ATA Mode:

This item determines the function mode for “IDE1”connector.

**[IDE-1]:** “IDE1” connector served as [Primary Master] and [Primary Slave] channel. “SATA2” and “SATA4”connector served as [Secondary Master] and [Secondary Slave] channel. The remaining “SATA1” and “SATA3” connectors are disabled.

**[IDE-2]:** “IDE1” connector served as [Secondary Master] and [Secondary Slave] channel. “SATA1” and “SATA3” connector served as [Primary Master] and [Primary Slave] channel. The remaining “SATA2” and “SATA4” connectors are disabled.

Refer to the following table for the relationships between IDE and SATA ports.

PATA IDE Mode	IDE Channel 1 Master	IDE Channel 1 Slave	IDE Channel 2 Master	IDE Channel 2 Slave	IDE Channel 3 Master	IDE Channel 3 Slave	IDE Channel 4 Master	IDE Channel 4 Slave
Primary	IDE1 Master	IDE1 Slave	SATA2	SATA4	None	None	None	None
Secondary	SATA1	SATA3	IDE1 Master	IDE1 Slave	None	None	None	None

**NOTE:** This option is configurable only when the item [OnChip Serial ATA] is set to [Combined Mode].

#### \* Serial ATA Mode:

This item displays the variety modes for Serial ATA mode.

### ☛ OnChip PCI Device:

Click <Enter> key to enter its submenu:

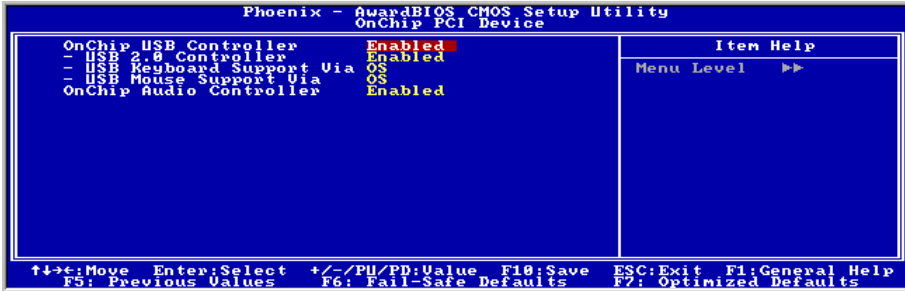

### OnChip USB Controller:

This option enables or disables the USB controller.

#### \* USB 2.0 Controller:

This option enables or disables the USB 2.0 controller.

#### \* USB Keyboard Support Via:

This item allows you to select [BIOS] for using USB keyboard in DOS environment, or [OS] in OS environment.

#### \* USB Mouse Support Via:

This item allows you to select [BIOS] for using USB mouse in DOS environment, or [OS] in OS environment.

### OnChip Audio Controller:

This option enables or disables the audio controller.

### ☛ SuperIO Device:

Click <Enter> key to enter its submenu:





---

**Onboard FDD Controller:**

This option enables or disables the onboard FDC controller.

---

**Onboard Serial Port :**

This item determines which I/O addresses the onboard Serial Port controller will access.

**[Auto]:** The system automatically select an I/O address for the onboard Serial Port.

**[3F8/IRQ4, 2F8/IRQ3, 3E8/IRQ4, 2E8/IRQ3]:** Allows you to manually select an I/O address for the onboard Serial Port.

**[Disabled]:** Disables the onboard Serial Port.

---

**Onboard Parallel Port:**

This item specifies the I/O address used by the parallel port.

**[Disabled]:** This option prevents the parallel port from accessing any system resources. When the value of this option is set to [Disabled], the printer port becomes unavailable.

**[378/IRQ7]:** This option allows the parallel port to use [378/IRQ7] as its I/O port address. The majority of parallel ports on computer systems use IRQ7 and I/O Port 378H as the standard setting.

**[278/IRQ5]:** This option allows the parallel port to use [278/IRQ5] as its I/O port address.

**[3BC/IRQ7]:** This option allows the parallel port to use [3BC/IRQ7] as its I/O port address.

**\* Parallel Port Mode:**

This item specifies the parallel port mode.

**[Normal]:** Allows the standard parallel port mode to be used.

**[SPP]:** (Standard Parallel Port) Allows bi-directional parallel port operation at normal speed.

**[EPP]:** (Enhanced Parallel Port) Allows bi-directional parallel port operation at maximum speed.

**[ECP]:** (Extended Capabilities Port) Allows bi-directional parallel port operation at a speed faster than the normal mode's data transfer rate.

**[ECP+EPP]:** Allows parallel port operation at ECP and EPP mode.

**\* ECP Mode Use DMA:**

This item selects the DMA channel of the parallel port.

## ☛ Onboard PCI Device:

Click <Enter> key to enter its submenu:

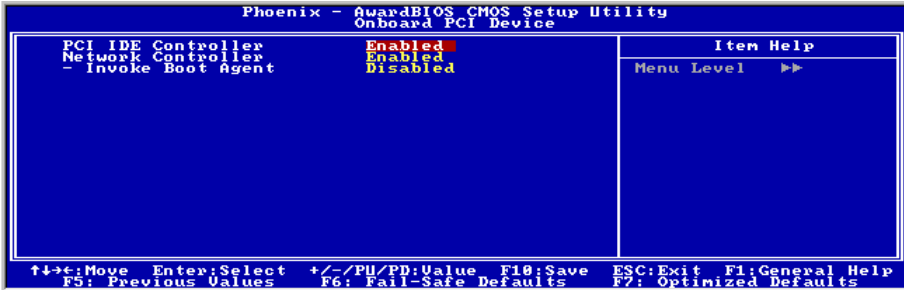

### PCI IDE Controller:

This option enables or disables the IDE controller.

### Network Controller :

This option enables or disables the LAN controller.

### \* Invoke Boot Agent:

This item allows you to use the boot ROM (instead of a disk drive) to boot-up the system and access the local area network directly.

## 3-6. Power Management Setup

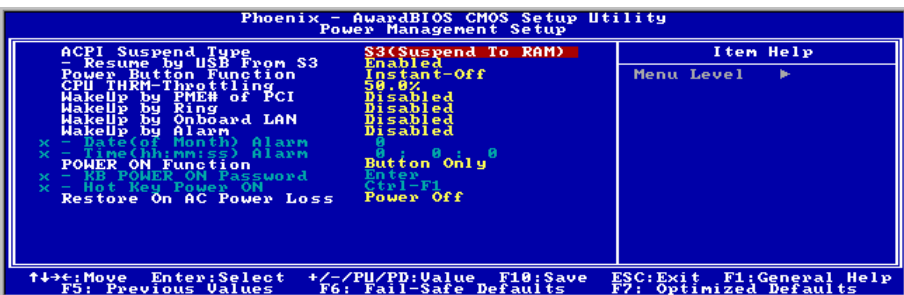

### ACPI Suspend Type:

This item selects the type of Suspend mode.

[S1(PowerOn-Suspend)]: Enables the Power On Suspend function.

[S3(Suspend-To-RAM)]: Enables the Suspend to RAM function.

---

**\* Resume by USB From S3:**

When set to [Enabled], this item allows you to use a USB device to wake up a system that is in the S3 (STR - Suspend To RAM) state. This item can be configured only if the item "ACPI Suspend Type" is set to [S3(STR)].

---

**Power Button Function:**

This item selects the method of powering off your system:

**[Delay 4 Sec.]:** Pushing the power button for more than 4 seconds will power off the system. This will prevent the system from powering off in case you accidentally hit or pushed the power button.

**[Instant-Off]:** Pressing and then releasing the power button at once will immediately power off the system.

---

**CPU THRM-Throttling**

This item controls the CPU speed by cutting down its regular power to a percentage during the STR (Suspend To RAM) state.

---

**WakeUp by PME# of PCI:**

Two options are available: Disabled or Enabled. The default setting is *Disabled*. When set to *Enabled*, any event affecting from PCI card (PME) will awaken a system that has powered down.

---

**WakeUp by Ring:**

Two options are available: Disabled or Enabled. The default setting is *Disabled*. When set to *Enabled*, any event affecting from Modem Ring will awaken a system that has powered down.

---

**WakeUp by Onboard LAN:**

When set to [Enabled], you can remotely wake up a PC in Soft-Off condition via a LAN card that support the wake up function.

---

**WakeUp by Alarm:**

When set to [Enabled], you can set the date and time you would like the Soft-Off PC to power-on in the "Date (of Month) Alarm" and "Time (hh:mm:ss) Alarm" items. However, if the system is being accessed by incoming calls or the network (Resume On Ring/LAN) prior to the date and time set in these items, the system will give priority to the incoming calls or network instead.

**\* Date (of Month) Alarm**

**[0]:** This option power-on the system everyday according to the time set in the "Time (hh:mm:ss) Alarm" item.

**[1-31]:** This option selects a date you would like the system to power-on. The system will power-on on the date set, and the time set in the "Time (hh:mm:ss) Alarm" item.

**\* Time (hh:mm:ss) Alarm**

This item sets the time you would like the system to power-on.

---

---

**POWER ON Function:**

This item selects the way you want your system to power on.

**[Password]:** Use a password to power on the system, select this option then press <Enter>. Enter your password. You can enter up to 5 characters. Type in exactly the same password to confirm, and then press <Enter>.

**[Hot KEY]:** Use any of the function keys between <F1> to <F12> to power on the system.

**[Mouse Move]:** Move the mouse to power on the system.

**[Mouse Click]:** Double click any mouse button to power on the system.

**[Any KEY]:** Use any keyboard keys to power on the system.

**[Button Only]:** Use only the power button to power on the system.

**[Keyboard 98]:** Use the power-on button on the “Keyboard 98” compatible keyboard to power on the system.

**NOTE:** To enable this “Power On” function, the wake-up header of [PS2-PWR1], [USB-PWR1], [USB-PWR2] must be set to [Enabled] position. Please refer to the configuration of “Wake-up Header” [PS2-PWR1], [USB-PWR1], and [USB-PWR2] in section 2-4, chapter 2.

**NOTE:** The mouse wake up function can only be used with the PS/2 mouse, not with the COM port or USB type. Some PS/2 mice cannot wake up the system because of compatible problems. If the specs of your keyboard are too old, it may fail to power on.

**\* KB Power ON Password:**

This item sets the password required in order to power on your computer.

**NOTE:** Do not forget your password, or you will have to clear the CMOS and reset all parameters in order to utilize this function again.

**\* Hot Key Power ON:**

This item powers on the system by pressing <Ctrl> key plus one of each function key (<F1> ~ <F12>) simultaneously.

---

**Restore On AC Power Loss:**

This item selects the system action after an AC power failure.

**[Power Off]:** When power returns after an AC power failure, the system’s power remains off. You must press the Power button to power-on the system.

**[Power On]:** When power returns after an AC power failure, the system’s power will be powered on automatically.

**[Last State]:** When power returns after an AC power failure, the system will return to the state where you left off before power failure occurs. If the system’s power is off when AC power failure occurs, it will remain off when power returns. If the system’s power is on when AC power failure occurs, the system will power-on when power returns.

### 3-7. PnP/PCI Configurations



#### Resources Controlled By:

This item configures all of the boot and Plug-and-Play compatible devices.

[Auto]: The system will automatically detect the settings.

[Manual]: Choose the specific IRQ resources in the “IRQ Resources” menu.

#### \* IRQ Resources:

Click <Enter> key to enter its submenu:

This item sets each system interrupt to either [PCI Device] or [Reserved].



#### PCI/VGA Palette Snoop:

This item determines whether the MPEG ISA/VESA VGA cards can work with PCI/VGA or not.

[Enabled]: MPEG ISA/VESA VGA cards work with PCI/VGA.

[Disabled]: MPEG ISA/VESA VGA cards do not work with PCI/VGA.

#### Allocate IRQ To Video:

This item assigns an IRQ for the VGA card installed.

[Enabled]: Automatically assign an IRQ for the VGA card installed.

[Disabled]: The IRQ that was previously occupied by the VGA card will be available for new device.

---

**Allocate IRQ To USB:**

This item assigns an IRQ for the USB device connected.

**[Enabled]:** Automatically assign an IRQ for the USB device connected.

**[Disabled]:** The IRQ that was previously occupied by the USB device connected will be available for new device.

---

**PCI Latency Timer(CLK):**

This item controls how long each PCI device can hold the bus before another takes over. When set to higher values, every PCI device can conduct transactions for a longer time and thus improve the effective PCI bandwidth. For better PCI performance, you should set the item to higher values.

---

**PIRQ\_0 Use IRQ No. ~ PIRQ\_7 Use IRQ No.:**

This item specifies the IRQ number manually or automatically for the devices installed on PCI slots.

---

**Maximum Payload Size:**

This item sets the maximum TLP payload size for the PCI Express devices.

### 3-8. PC Health Status



#### FAN Fail Alarm Selectable:

This item selects the fan that will be monitored for malfunction.

#### CPU FanEQ Control:

This item allows you to control the CPU fan speed down to a specific percentage.

##### \* CPU FanEQ Max Control/ CPU FanEQ Min Control:

When set to a specific percentage, the CPU fan speed will run at the percentage you set in this item if the temperature limit set in the item “High Temp” is not exceeded.

The CPU fan speed will run at 100% regardless of what the percentage you set in this item if the temperature limit set in the item “High Temp” is exceeded.

##### \* CPU FanEQ High Temp/ CPU FanEQ Low Temp:

This item sets the temperature limit that would activate the function of “CPU FanEQ Control” option.

#### SYS FanEQ Control:

This item allows you to control the SYS fan speed down to a specific percentage.

##### \* SYS FanEQ Max Control/ SYS FanEQ Min Control:

When set to a specific percentage, the SYS fan speed will run at the percentage you set in this item if the temperature limit set in the item “High Temp” is not exceeded.

The SYS fan speed will run at 100% regardless of what the percentage you set in this item if the temperature limit set in the item “High Temp” is exceeded.

##### \* SYS FanEQ High Temp/ SYS FanEQ Low Temp:

This item sets the temperature limit that would activate the function of “SYS FanEQ Control” option.

---

**CPU Shutdown Temperature:**

This item sets the temperature that would shutdown the system automatically in order to prevent system overheats.

---

**CPU Warning Temperature:**

This item selects the CPU's warning temperature limit. Once the system has detected that the CPU's temperature exceeded the limit, warning beeps will sound.

**NOTE:** The onboard hardware monitor function is capable of detecting these system health conditions. If you want a warning message to pop-up or a warning alarm to sound when an abnormal condition occurs, you must install the "Hardware Doctor" utility. This utility is included in the "Driver & Utility CD" that came packed with this motherboard.

---

**All Voltages, Fans Speed and Thermal Monitoring:**

These unchangeable items list the current status of the CPU and environment temperatures, fan speeds, and system power voltage.

**NOTE:** The hardware monitoring features for temperatures, fans and voltages will occupy the I/O address from 294H to 297H. If you have a network adapter, sound card or other add-on cards that might use those I/O addresses, please adjust your add-on card I/O address to avoid using these addresses.

---

## 3-9. Load Fail-Safe Defaults

---

This option loads the BIOS default values for the most stable, minimal-performance system operations.

---

## 3-10. Load Optimized Defaults

---

This option loads the BIOS default values that are factory settings for optimal-performance system operations.

---

## 3-11. Set Password

---

This option protects the BIOS configuration or restricts access to the computer itself.

---

## 3-12. Save & Exit Setup

---

This option saves your selections and exits the BIOS setup menu.

---

## 3-13. Exit Without Saving

---

This option exits the BIOS setup menu without saving any change.



## Appendix A. Install Intel Chipset Software Utility

**NOTE:** Please install this Intel Chipset driver first after having installed the Windows operating system.

The installation procedures and screen shots in this section are based on Windows XP operating system. For those of other OS, please follow its on-screen instruction.

Insert the Driver & Utility CD into CD-ROM drive, it should execute the installation program automatically. If not, double-click the execution file at the main directory of this CD to enter the installation menu.

After entering the installation menu, move your cursor to [Drivers] tab. Click [Intel Chipset Software Utility]. The following screen appears.

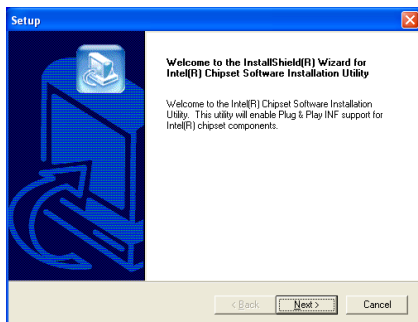

1. Click [Next].

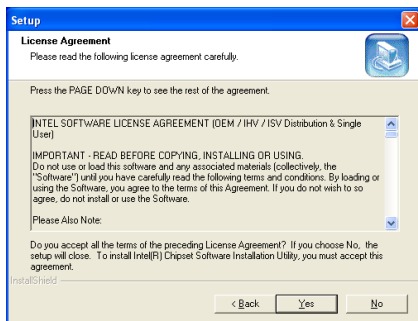

2. Click [Yes].

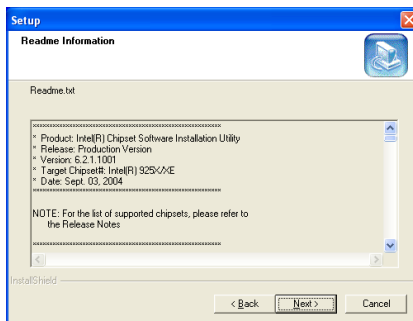

3. Click [Next].

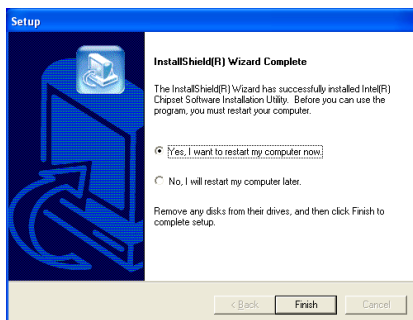

4. Choose [Yes, I want to restart my computer now.], and click [Finish] to complete setup.



## Appendix B. Install Driver for ITE IDE Controller (GD8, GD8-M)

The installation procedures and screen shots in this section are based on Windows XP operating system. For those of other OS, please follow its on-screen instruction.

Insert the Driver & Utility CD into CD-ROM drive, it should execute the installation program automatically. If not, double-click the execution file at the main directory of this CD to enter the installation menu.

After entering the installation menu, move your cursor to [Drivers] tab. Click [ITE IDE Controller]. The following screen appears.

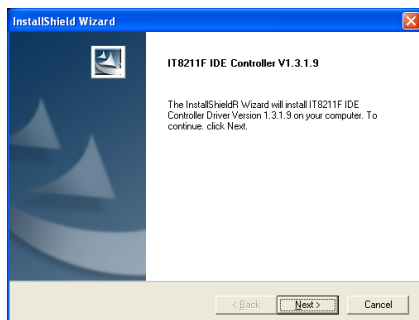

1. Click [Next].

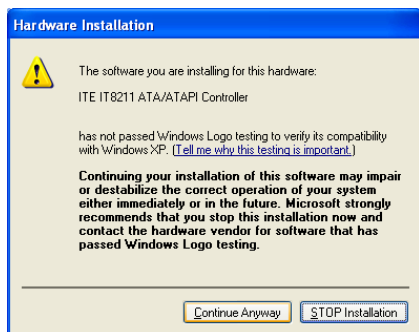

2. Click [Continue Anyway].

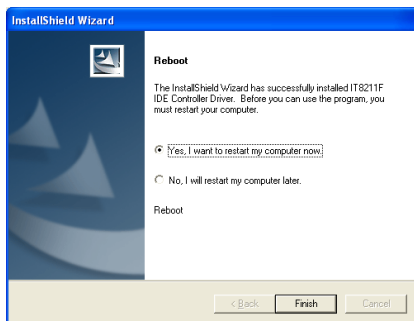

3. Choose [Yes, I want to restart my computer now.], and click [Finish] to complete setup.



## Appendix C. Install Audio Driver

The installation procedures and screen shots in this section are based on Windows XP operating system. For those of other OS, please follow its on-screen instruction.

Insert the Driver & Utility CD into CD-ROM drive, it should execute the installation program automatically. If not, double-click the execution file at the main directory of this CD to enter the installation menu.

After entering the installation menu, move your cursor to [Drivers] tab. Click [Audio Driver]. The following screen appears.

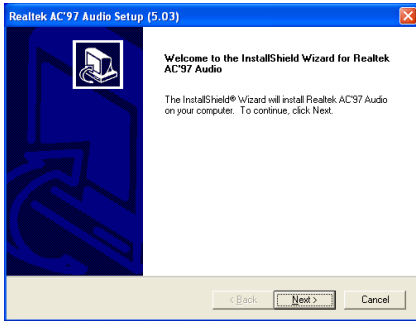

1. Click [Next].

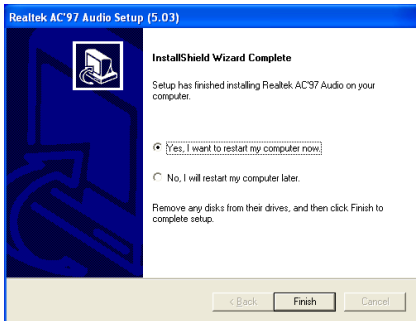

2. Choose [Yes, I want to restart my computer now.], and click [Finish] to complete setup.

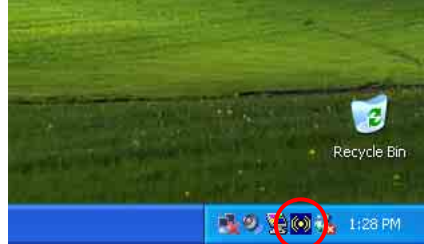

3. After the system restarted, a shortcut icon appears at the right corner of Windows task bar.

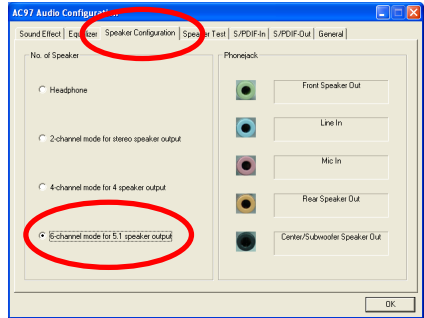

4. In this Speaker Configuration tab, select [6 channels mode for 5.1 speakers output] to enable 6-channel audio system.



## Appendix D. Install VGA Driver (GD8-M, GD8-MV)

The installation procedures and screen shots in this section are based on Windows XP operating system. For those of other OS, please follow its on-screen instruction.

Insert the Driver & Utility CD into CD-ROM drive, it should execute the installation program automatically. If not, double-click the execution file at the main directory of this CD to enter the installation menu.

After entering the installation menu, move your cursor to [Drivers] tab. Click [VGA Driver]. The following screen appears.

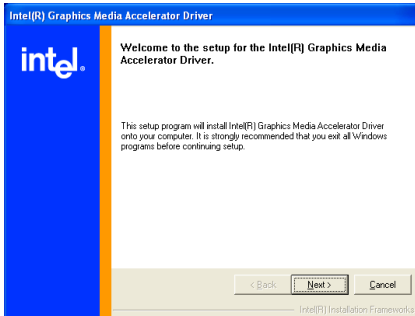

1. Click [Next].

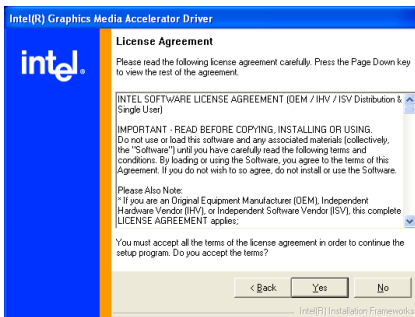

2. Click [Yes].



3. Choose [Yes, I want to restart my computer now.], and click [Finish] to complete setup..





## Appendix E. Install LAN Driver

The installation procedures and screen shots in this section are based on Windows XP operating system. For those of other OS, please follow its on-screen instruction.

Insert the Driver & Utility CD into CD-ROM drive, it should execute the installation program automatically. If not, double-click the execution file at the main directory of this CD to enter the installation menu.

After entering the installation menu, move your cursor to [Drivers] tab. Click [LAN Driver]. The following screen appears.

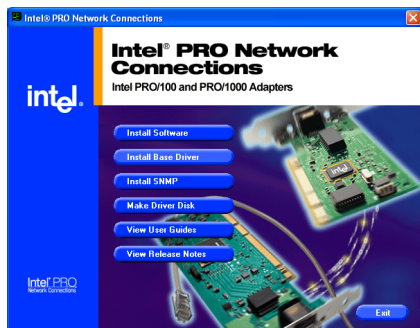

1. Click [Install Base Driver].

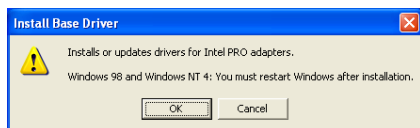

2. Click [OK] to complete setup. Click [Exit] to exit the installation program and restart your system.



## **Appendix F. Install USB 2.0 Driver**

---

**NOTE:** The “USB 2.0 Driver” packed in the “Driver & Utility CD” is currently available for Windows 9x and ME only. To install this driver for Windows XP or Windows 2000, you have to download their latest service pack first from Microsoft’s web site.



## Appendix G. FlashMenu (BIOS Update Utility)

ABIT FlashMenu is the most stable Windows-based BIOS flash available. No more worries from crashing. With one click of BIOS updating, ABIT users can flash their BIOS more easily and in less time.

The installation procedures and screen shots in this section are based on Windows XP operating system. For those of other OS, please follow its on-screen instruction.

Insert the Driver & Utility CD into CD-ROM drive, it should execute the installation program automatically. If not, double-click the execution file at the main directory of this CD to enter the installation menu.

After entering the installation menu, move your cursor to [ABIT Utility] tab. Click [FlashMenu]. The following screen appears.

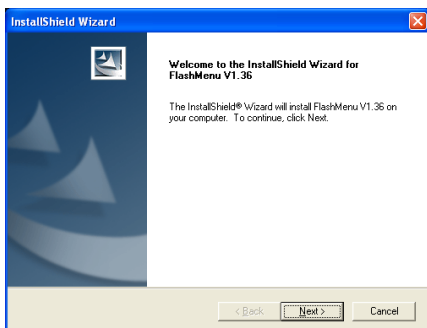

1. Click [Next].

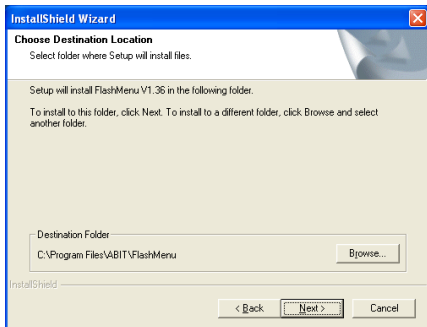

2. Click [Next]

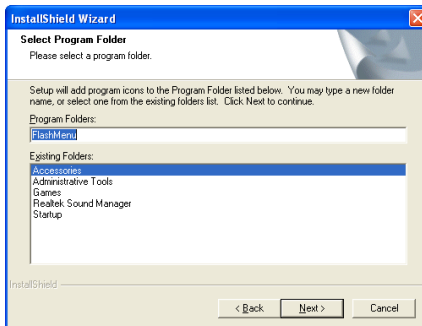

3. Click [Next]

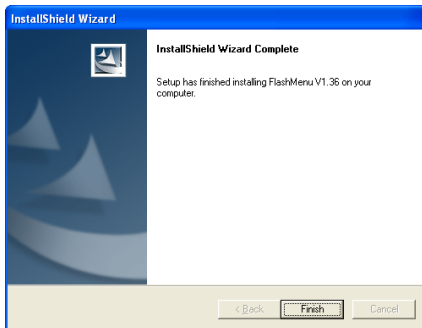

4. Click [Finish] to complete setup.

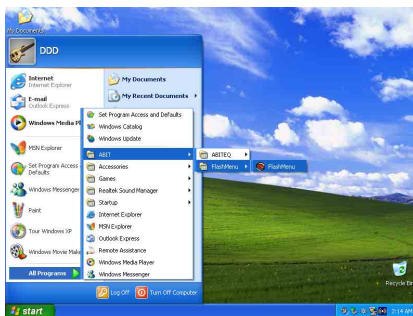

5. Execute the FlashMenu by entering the Windows Menu [Start] → [Programs] → [ABIT] → [FlashMenu].

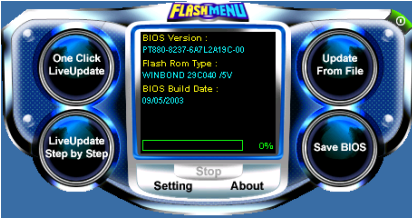

6. This FlashMenu screen appears. You can easily update the BIOS from clicking [Update From File], [One Click LiveUpdate], or [LiveUpdate Step by Step] button.

## Appendix H. ABIT EQ (The Hardware Doctor Utility)

ABIT EQ is a self-diagnostic system for PC based on motherboards designed and manufactured by ABIT Computer Corporation. It will protect PC Hardware by monitoring critical items of Power Supply Voltage, CPU & System Fans Speed, and CPU & System Temperature.

The installation procedures and screen shots in this section are based on Windows XP operating system. For those of other OS, please follow its on-screen instruction.

Insert the Driver & Utility CD into CD-ROM drive, it should execute the installation program automatically. If not, double-click the execution file at the main directory of this CD to enter the installation menu.

After entering the installation menu, move your cursor to [ABIT Utility] tab. Click [ABITEQ]. The following screen appears.

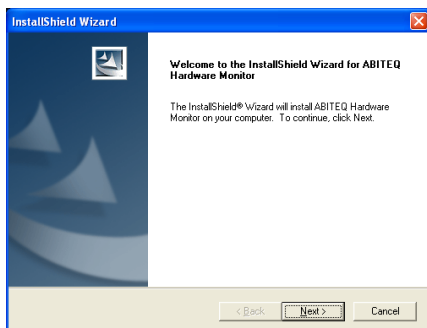

1. Click [Next].

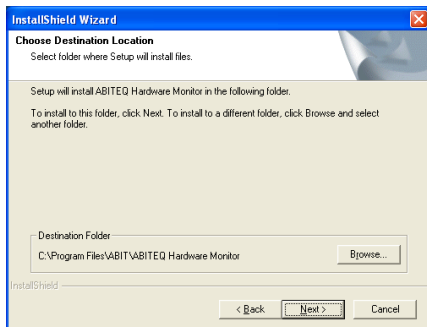

2. Click [Next].

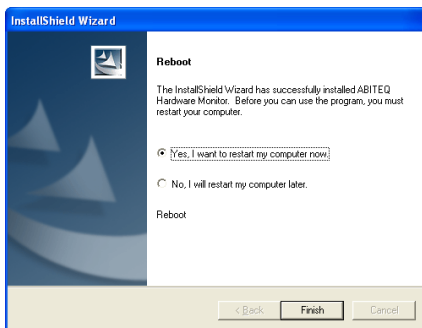

3. Choose [Yes, I want to restart my computer now.], and click [Finish] to complete setup.

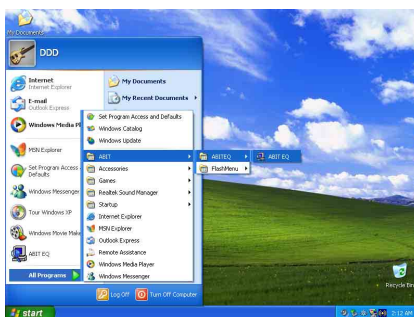

4. Execute the ABIT EQ by entering the Windows Menu [Start] → [Programs] → [ABIT] → [ABIT EQ].





---

## Appendix I. Troubleshooting (Need Assistance?)

---

### Q & A:

**Q: Do I need to clear the CMOS before I use a new motherboard to assemble my new computer system?**

A: Yes, we highly recommend that you clear the CMOS before installing a new motherboard. Please move the CMOS jumper from its default 1-2 position to 2-3 for a few seconds, and then back. When you boot up your system for the first time, follow the instructions in the user's manual to load the optimized defaults.

**Q: If my systems hang when I update the BIOS or set the wrong CPU parameters, what should I do?**

A: Whenever you update the BIOS or if the system hangs due to wrong CPU parameters setting, always clear CMOS jumper before booting up again.

**Q: Why the system fails to boot up again right after a mechanical power-off?**

A: Please keep a 30-second interval between each mechanical power On/Off.

**Q: Why the system failed to boot up and nothing was displayed on the screen after I did some over-clocking or non-standard settings inside the BIOS? Is the motherboard dead? Do I need to return it to where I bought from or go through an RMA process?**

A: It should not cause hardware or permanent damage to motherboard when BIOS settings were changed from default to over-clocking or non-standard status.

We suggest the following three troubleshooting methods to discharge CMOS data, recover the hardware default status, and then make the motherboard working again. No need to bother returning the motherboard to where you bought from or go through an RMA process.

**Step 1.** Switch off the power supply unit and then switch it on again after one minute. If there is no power switch on the power supply unit, disconnect its power cord for one minute and then connect it back.

Press and hold the <Insert> key on the keyboard, press the power-on button to boot up system. If it works, loose the <Insert> key and hit <Del> key to enter the BIOS setup page to do the correct settings.

If the situation remains the same, repeat the procedures in Step 1 for three times, or try Step 2.

**Step 2.** Switch off the power supply unit or disconnect the power cord. Open the chassis cover. Locate the CCMOS jumper near the button battery. Change the jumper position from default 1-2 to 2-3 for one minute to discharge the CMOS data, and then put it back to default 1-2 position.

Close the chassis and switch on the power supply unit or plug in the power cord. Press the power-on button to boot up system. If it works, hit <Del> key to enter the BIOS setup page to do the correct settings.

If the situation remains the same, try Step 3.

**Step 3.** The same procedure as Step 2, but in the meantime of discharging the CMOS data, pull out ATX power connectors from motherboard and remove the button battery during CMOS discharging.

**Q: How can I get a quick response to my request for technical support?**

A: Be sure to follow the guidelines as stated in the “Technical Support Form” section of this manual.

If you have a problem during operation, in order to help our technical support personnel quickly determine the problem with your motherboard and give you the answers you need, before filling in the technical support form, eliminate any peripheral that is not related to the problem, and indicate it on the form. Fax this form to your dealer or to the company where you bought the hardware in order to benefit from our technical support. (You can refer to the examples given below)

**Example 1:**

With a system including: motherboard (with CPU, DRAM, COAST...) HDD, CD-ROM, FDD, VGA CARD, MPEG CARD, SCSI CARD, SOUND CARD, etc. After the system is assembled, if you cannot boot up, check the key components of the system using the procedure described below. First remove all interface cards except the VGA card and try to reboot.

**If you still cannot boot up:** Try installing another brand/model VGA card and see if the system will start. If it still does not start, note the VGA card model, motherboard model, Bios identification number, CPU on the technical support form (refer to main instructions), and describe the problem in the problem description space provided.

**If you can boot up:** Insert the interface cards you have removed back into the system, one by one and try to start the system each time you insert a card, until the system will not start. Keep the VGA card and the interface card that caused the problem inserted on the motherboard, remove any other cards or peripheral, and start again. If you still cannot start, note the information related to both cards in the add-on Card space provided, and don't forget to indicate the motherboard model, version, BIOS identification number, CPU (refer to main instructions), and give a description of the problem.

**Example 2:**

With a system including the motherboard (with CPU, DRAM, COAST...) HDD, CD-ROM, FDD, VGA CARD, LAN CARD, MPEG CARD, SCSI CARD, SOUND CARD, after assembly and after having installed the Sound Card Driver, when you restart the system, when it runs the Sound Card Driver, it resets automatically. This problem may be due to the Sound Card Driver. During the Starting DOS... procedure, press SHIFT (BY-PASS) key, to skip CONFIG.SYS and AUTOEXEC.BAT; edit CONFIG.SYS with a text editor, and in function the line that loads the Sound Card Driver, add a remark REM, in order to disable the Sound Card Driver. See the example below.

```
CONFIG.SYS:
DEVICE=C:\DOS\HIMEM.SYS
DEVICE=C:\DOS\EMM386.EXE HIGHSCAN
DOS=HIGH, UMB
FILES=40
BUFFERS=36
REM DEVICEHIGH=C:\PLUGPLAY\DWCFMG.SYS
LASTDRIVE=Z
```

Restart the system. If the system starts and does not reset, you can be sure that the problem is due to the Sound Card Driver. Write down the Sound Card model, motherboard model, BIOS identification number on the technical support file (refer to main instructions), and describe the problem in the space provided.

We will show you how to fill the “Technical Support Form”.

**Main instructions:**

To fill in this “**Technical Support Form**”, refer to the step-by-step instructions given below:

- 1\* **MODEL:** Note the model number given in your user’s manual.  
Example: GD8, GD8-V, GD8-M, GD8-MV
- 2\* **Motherboard model number (REV):** Note the motherboard model number labeled on the motherboard as “REV:\*.\*\*”.  
Example: REV: 1.00

- 3\* **BIOS ID and Part Number:** See the on screen message.

- 4. **DRIVER REV:** Note the driver version number indicated on the DEVICE DRIVER disk (if any) as “Release \*.\*”. For example:

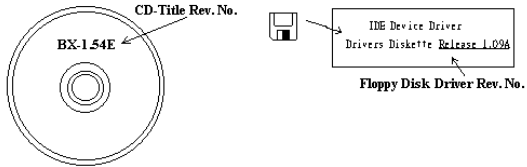

- 5\* **OS/APPLICATION:** Indicate the operating system and applications you are running on the system.  
Example: MS-DOS® 6.22, Windows® 98 SE, Windows® 2000, etc....

- 6\* **CPU:** Indicate the brand and the speed (MHz) of your CPU.  
Example:(A) In the “Brand” space, write “Intel”; in the “Specifications” space, write “Pentium® 4 1.9GHz”.

- 7. **HDD:** Indicate the brand and specifications of your HDD(s); specify if the HDD is using IDE1 or IDE2. If you know the disk capacity, indicate it and check (“✓”) “”; in case you give no indication, we will consider that your HDD is “IDE1” Master.  
Example: In the “HDD” space, check the box; in the Brand space, write “Seagate”; in the Specifications space, write “ST31621A (1.6GB)”.

- 8. **CD-ROM Drive:** Indicate the brand and specifications of your CD-ROM drive. Specify if it uses IDE1 or IDE2 , and check (“✓”) “”; in case you give no indication, we will consider that your CD-ROM is “IDE2” Master.  
Example: In the “CD-ROM drive” space, check the box, in the Brand space, write “Mitsumi”, in the Specifications space, write “FX-400D”.

- 9. **System Memory (DDR SDRAM):** Indicate the brand and specifications (DDR DIMM) of your system memory. Such as Density, Description, Module Components, Module Part Number, CAS Latency, and Speed (MHz).  
For example: In the Brand space, write “**Micron**”; in the Specifications space, write: **Density:** 128MB, **Description:** SS 16 Megx72 2.5V ECC Gold, **Module Components:** (9) 16 Megx 8, **Module Part Number:** MT9VDDT1672AG, **CAS Latency:** 2, **Speed (MHz):** 200 MHz.

Please give us the detailed information of your DDR SDRAM module; it will help us to simulate the problems you met.

- 10. **ADD-ON CARD:** Indicate which add-on cards you are *absolutely sure* are related to the problem. If you cannot identify the problem’s origin, indicate all the add-on cards inserted into your system.

**NOTE:** Items between the “\*” are absolutely necessary.

 **Technical Support Form**

 **Company Name:**

 **Phone Number:**

 **Contact Person:**

 **Fax Number:**

 **E-mail Address:**

Model	*	BIOS ID #	*
Motherboard Model No.		DRIVER REV	
OS/Application	*		
Hardware Name	Brand	Specifications	
CPU	*		
HDD	<input type="checkbox"/> IDE1 <input type="checkbox"/> IDE2		
CD-ROM-Drive	<input type="checkbox"/> IDE1 <input type="checkbox"/> IDE2		
System Memory			
ADD-ON CARD			

Problem Description:

---

---

---

---

---

---

---

---

---

---

---

---



---

## Appendix J. How to Get Technical Support

---

(From our website) <http://www.abit.com.tw>

(In North America) <http://www.abit-usa.com>

(In Europe) <http://www.abit.nl>

Thank you for choosing ABIT products. ABIT sells all our products through distributors, resellers and system integrators; we have no direct sales to end-users. Before sending email for tech support please check with your resellers or integrators if you need any services, they are the ones who sold you your system and they should know best as to what can be done, how they serve you is a good reference for future purchases.

We appreciate every customer and would like to provide the best service to you. Providing fast service to our customers is our top priority. However we receive many phone calls and a huge amount of email from all over the world. At the present time it is impossible for us to respond to every single inquiry. Therefore it is quite possible that if you send an email to us that you may not receive a response.

We have done many compatibility tests and reliability tests to make sure our products have the best quality and compatibility. In case you need service or technical support, please understand the constraint we have and **always check with the reseller who sold the product to you first.**

To expedite service, we recommend that you follow the procedures outlined below before contacting us. With your help, we can meet our commitment to provide the best service to the **greatest number of ABIT customers:**

1. **Check the Manual.** It sounds simple but we have taken a lot of care in making a well-written and thorough manual. It is full of information that doesn't only pertain to motherboards. The CD-ROM included with your board will have the manual as well as drivers. If you don't have either one, go to our Program Download Area of the Website or FTP server.
2. **Download latest BIOS, software or drivers.** Please go to our Program Download area on our Website to check to see if you have the latest BIOS. They are developed over periods of time to fix bugs or incompatibilities. **Also please make sure you have the latest drivers from your peripheral cards makers!**
3. **Check the ABIT Technical Terms Guide and FAQ on our Website.** We are trying to expand and make the FAQs more helpful and information rich. Let us know if you have any suggestions. For hot topics, check out our HOT FAQ!

4. **Internet Newsgroups.** They are a great source of information and many people there can offer help. ABIT's Internet News group, [alt.comp.periphs.mainboard.abit](mailto:alt.comp.periphs.mainboard.abit), is an ideal forum for the public to exchange information and discuss experiences they have had with ABIT products. Many times you will see that your question has already been asked before. This is a public Internet news group and it is reserved for free discussions. Here is a list of some of the more popular ones:

[alt.comp.periphs.mainboard.abit](mailto:alt.comp.periphs.mainboard.abit)  
[comp.sys.ibm.pc.hardware.chips](mailto:comp.sys.ibm.pc.hardware.chips)  
[alt.comp.hardware.overclocking](mailto:alt.comp.hardware.overclocking)  
[alt.comp.hardware.homebuilt](mailto:alt.comp.hardware.homebuilt)  
[alt.comp.hardware.pc-homebuilt](mailto:alt.comp.hardware.pc-homebuilt)

5. **Ask your reseller.** Your ABIT authorized distributor should be able to provide the fastest solution to your technical problem. We sell our products through distributors who sell to resellers and stores. Your reseller should be very familiar with your system configuration and should be able to solve your problem much more efficiently than we could. After all, your reseller regards you as an important customer who may purchase more products and who can urge your friends to buy from him or her as well. They integrated and sold the system to you. They should know best what your system configuration is and your problem. They should have reasonable return or refund policies. How they serve you is also a good reference for your next purchase.
6. **Contacting ABIT.** If you feel that you need to contact ABIT directly you can send email to the ABIT technical support department. First, please contact the support team for the branch office closest to you. They will be more familiar with local conditions and problems and will have better insight as to which resellers offer what products and services. Due to the huge number of emails coming in every day and other reasons, such as the time required for problem reproduction, we will not be able to reply to every email. Please understand that we are selling through distribution channels and don't have the resources to serve every end-user. However, we will try to do our best to help every customer. Please also remember that for many of our technical support team English is a second language, you will have a better chance of getting a helpful answer if your question can be understood in the first place. Be sure to use very, simple, concise language that clearly states the problem, avoid rambling or flowery language and always list your system components. Here is the contact information for our branch offices:
7. **RMA Service.** If your system has been working but it just stopped, but you have not installed any new software or hardware recently, it is likely that you have a defective component. Please contact the reseller from whom you bought the product. You should be able to get RMA service there.

---

**North America and South America**     **ABIT Computer (U.S.A.) Corporation**  
45531 Northport Loop West, Fremont CA, 94538,  
U.S.A.  
Tel: 1-510-623-0500  
Fax: 1-510-623-1092  
Sales: [sales@abit-usa.com](mailto:sales@abit-usa.com)  
Latin America Sales: [ventas@abit-usa.com](mailto:ventas@abit-usa.com)  
Marketing: [marketing@abit-usa.com](mailto:marketing@abit-usa.com)  
Web Site: <http://www.abit-usa.com>

**RMA Center**     46808 Lakeview Blvd. Fremont, CA 94538, U.S.A.

---

**UK and Ireland**     **ABIT Computer (U.K.) Corporation Ltd.**  
Unit 3, 24-26 Boulton Road, Stevenage, Herts SG1  
4QX, UK  
Tel: 44-1438-228888  
Fax: 44-1438-226333  
E-mail: [sales@abitcomputer.co.uk](mailto:sales@abitcomputer.co.uk)

---

**Germany and Benelux (Belgium, Netherlands, Luxembourg), France, Italy, Spain, Portugal, Greece, Denmark, Norway, Sweden, Finland, and Switzerland**     **AMOR Computer B.V. (ABIT's European Office)**  
Jan van Riebeeckweg 15, 5928LG, Venlo,  
The Netherlands  
Tel: 31-77-3204428  
Fax: 31-77-3204420  
Sales: [sales@abit.nl](mailto:sales@abit.nl)  
Web Site: <http://www.abit.nl>

---

**Austria, Czech, Romania, Bulgaria, Slovakia, Croatia, Bosnia, Serbia, and Macedonia**     **Asguard Computer Ges.m.b.H**  
Schmalbachstrasse 5, A-2201 Gerasdorf / Wien,  
Austria  
Tel: 43-1-7346709  
Fax: 43-1-7346713  
E-mail: [asguard@asguard.at](mailto:asguard@asguard.at)

---

**Shanghai**     **ABIT Computer (Shanghai) Co. Ltd.**  
Tel: 86-21-6235-1829  
Fax: 86-21-6235-1832  
Web Site: <http://www.abit.com.cn>

---

**Russia and CIS**     **ABIT Computer (Russia) Co. Ltd.**  
Sales: [sales@abit.ru](mailto:sales@abit.ru)  
Info: [info@abit.ru](mailto:info@abit.ru)  
Web Site: <http://www.abit.ru>

---

---

**Poland**     **ABIT Computer (Poland) Co. Ltd.**  
Przedstawicielstwo w Polsce ul. Wita Stwosza 28,  
50-149 Wrocław  
Tel: 48 71 780 78 65 / 66  
Fax: 48 71 372 30 87

---

**Japan**     Web Site: <http://www.abit4u.jp>

---

**Taiwan Head Office**     **ABIT Computer Corporation**  
*(Serving all other territories  
not listed above.  
Taiwan is 8+ GMT time,  
and may have different holiday  
calendar from yours.)*  
No. 323, Yang Guang St., Neihu, Taipei, 114,  
Taiwan  
Tel: 886-2-8751-8888  
Fax: 886-2-8751-3382  
Sales: [sales@abit.com.tw](mailto:sales@abit.com.tw)  
Marketing: [market@abit.com.tw](mailto:market@abit.com.tw)  
Web Site: <http://www.abit.com.tw>

---

8. **Reporting Compatibility Problems to ABIT.** Because of tremendous number of email messages we receive every day, we are forced to give greater weight to certain types of messages than to others. For this reason, any compatibility problem that is reported to us, giving detailed system configuration information and error symptoms will receive the highest priority. For the other questions, we regret that we may not be able to reply directly. But your questions may be posted to the Internet news group in order that a larger number of users can have the benefit of the information. Please check the news group from time to time.

**Thank You**

**ABIT Computer Corporation**

**<http://www.abit.com.tw>**