

miroVIDEO PCTV miroVIDEO PCTV pro USER'S GUIDE

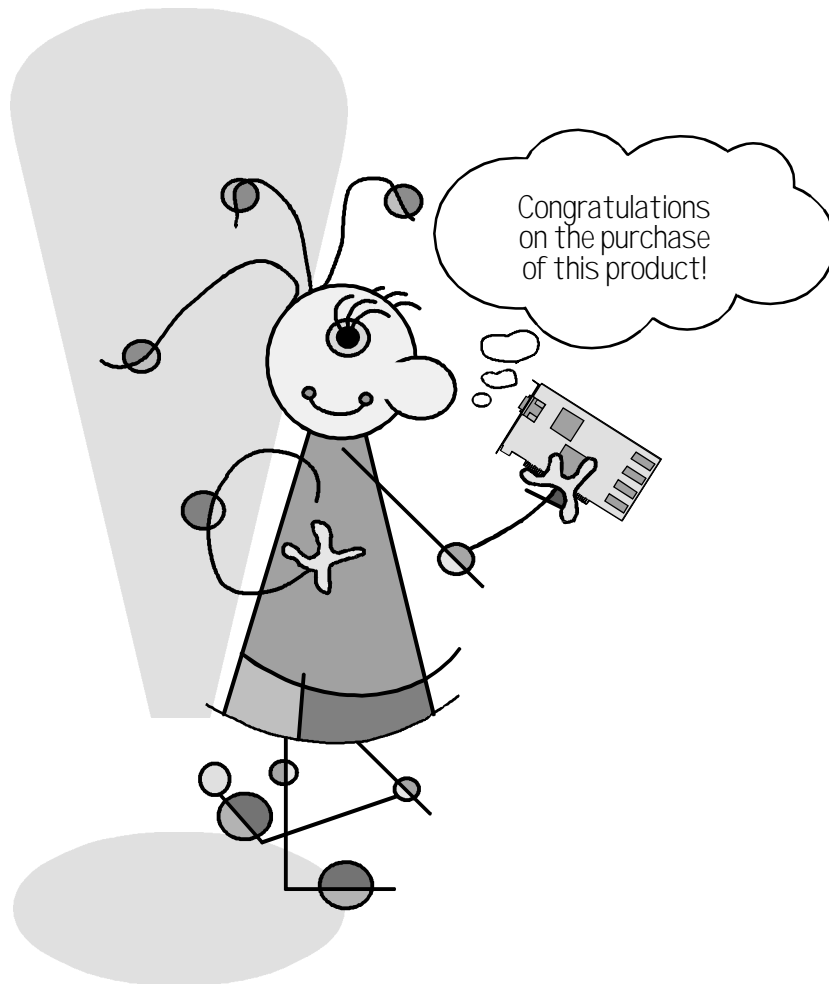

miroVIDEO PCTV/miroVIDEO PCTV pro

User's Guide

Version 1.0/GB October 1997

760036

© Pinnacle Systems GmbH 1997

All rights reserved.

No part of this manual may be reproduced or transferred to other media without explicit written permission from Pinnacle Systems GmbH, Braunschweig, Germany.

Brooktree® is a registered trademark of Brooktree Corp.

IBM AT® is a registered trademark of International Business Machines Corp.

MGA™ is a trademark of Matrox Graphics Inc.

miroVIDEO™ is a trademark of Pinnacle Systems GmbH.

OS/2™ is a trademark of International Business Machines Corp.

Pentium™ is a trademark of Intel Corp.

TRIO64V+™ and ViRGEV™ are trademarks of S3 Incorporated.

VGA™ is a trademark of International Business Machines Corp.

Video for Windows™ is a trademark of Microsoft Corp.

Windows® is a registered trademark of Microsoft Corp.

Windows NT™ is a trademark of Microsoft Corp.

InstallShield® is a registered trademark of InstallShield Corporation.

InstallScript™, DemoShield™, and the Stirling logo™ are trademarks of InstallShield Corporation.

All other brand or product names are trademarks or registered trademarks of their respective holders.

This manual is printed on chlorine-free paper using environmentally safe ink.

Pinnacle Systems GmbH has written this manual to the best of its knowledge, but does not guarantee that the programs/systems will fulfill the desires of the user.

No warranty is made as to the specifications of features.

Pinnacle Systems GmbH retains the right to make alterations to the content of the manual without the obligation to inform third parties.

All tenders, sales, supply and manufacturing contracts from Pinnacle Systems GmbH, including consultancy, installation and other contractual performance are subject exclusively to the General Sales and Delivery Terms of Pinnacle Systems GmbH.

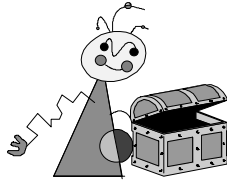

Contents

OVERVIEW	1
GENERAL	1
What is miroVIDEO PCTV?	1
What is miroVIDEO PCTV pro	1
FEATURES	1
BEFORE YOU BEGIN	3
SYSTEM REQUIREMENTS	3
Hardware	3
Software	3
Video devices	4
Audio devices	4
Antenna/cable	5
PACKAGE CONTENTS	5
HARDWARE INSTALLATION	7
PREPARING THE INSTALLATION	7
CONNECTING miroVIDEO PCTV PRO	7
INSERTING miroVIDEO PCTV (PRO)	8
AFTER THE INSTALLATION	9
SOFTWARE INSTALLATION	10
WINDOWS 95	10
miroVIDEO PCTV (pro) has just been installed...	10
Updating the driver...	13
WINDOWS NT	13
miroVIDEO PCTV (pro) has just been installed...	13
Updating the Driver...	14
CONNECTING DEVICES	15
CONNECTING THE VIDEO/AUDIO DEVICES	15
CONNECTING THE ANTENNA CABLE	15
CONNECTING THE SOUND BOARD/POWERED SPEAKERS	16
PCTV APPLICATIONS	17
miroTELEVISION	17
Pop-up menu	18
miroAV-CONTROL	22
System menu	23
miroTELETEXT (WINDOWS 95 ONLY)	24
Menus	25
miroTELETEXT icon bar	27
miroRADIO (ONLY WINDOWS 95)	28
Station	28
Sound	28
Record	28
Playback	29
Favourites	29
Configuring the miroRADIO application	29
Editing station list	30
Closing the dialog	31
Configuring the recording parameters	31
CAPTURING VIDEO WITH VidCON32	32
RECORDING SINGLE FRAMES WITH VidCON32	35
TIPS & TRICKS	36

HARDWARE REQUIREMENTS	36
INSTALLING miroVIDEO PCTV (PRO)	37
SETTINGS IN VIDCON32	38
Video Source settings	38
Video Format settings	39
Settings in the Capture Video Sequence window	42
Three examples for capturing video clips	43
<u>TECHNICAL DATA</u>	<u>44</u>
miroVIDEO PCTV	44
miroVIDEO PCTV pro upgrade	44
<u>APPENDIX</u>	<u>I</u>
IDENTIFYING THE WINDOWS 95 VERSION	I
INTERNAL CONNECTORS	II
SUPPORTED GRAPHICS BOARDS	IV
GLOSSARY	V
FOR YOUR OWN SAFETY	X
<u>INDEX</u>	<u>I</u>

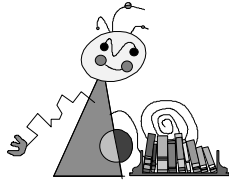

About the User's guide

This User's guide explains how to install and use the miroVIDEO Pinnacle Systems hardware and software.

Subheadings

In the margins are subheadings to help you quickly find your way through this manual.



Important text passages are marked with the “notepad” and this format.

Numbers mark step by step instructions:

1. Start Windows.

Bullets mark instructions for optional steps the order of which is not important.

- Connect the miro board to the microphone.

All keyboard commands appear in this font:

install <↵>

<↵> represents the enter key.

Menus, commands, options or buttons which the user can select are written in *italics*.

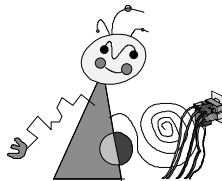

For your own safety

In the interest of your own safety and the flawless functioning of your new product and computer system please note the following:

- ♦ Computer components are sensitive to static charge. Divert any electrostatic charge from your person before touching the components with your hands or any tools.
- ♦ Before opening the computer make sure that the power plug is disconnected from the main socket.



For changes that have occurred after the manual has been printed, refer to the README file/s on the CD-ROM supplied with your system!

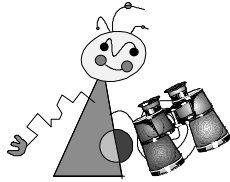

GENERAL

What is miroVIDEO PCTV?

miroVIDEO PCTV is a TV tuner/capture board which can be used with any PCI computer (PCI bus as of revision 2.1)*. miroVIDEO PCTV brings all functions which are usually provided by your television set to your PC. In addition, you can digitize (record), edit, and play back single frames or video clips.

What is miroVIDEO PCTV pro

miroVIDEO PCTV pro consists of a miroVIDEO PCTV base board and an add-on board which offers further functions, such as stereo TV, MTS (Multichannel Television Sound), and an FM stereo radio.

miroVIDEO PCTV pro upgrade



If you already own a miroVIDEO PCTV board, you can upgrade this board with the miroVIDEO PCTV pro.

The miroVIDEO PCTV pro upgrade is not available in all countries. Please ask your retailer!

FEATURES

miroVIDEO PCTV

The **PCI busmastering**** technology and a suitable graphics board enable a digital TV overlay. That means that the TV image is transferred via the PCI bus, superimposed onto the image generated by the graphics board, and displayed in a scaleable window.

The **miroVIDEO PCTV** base board is equipped with **Composite** and **S-Video inputs** to which connect a VCR, a camcorder, a video camera, or a satellite receiver.

miroVIDEO PCTV is also equipped with a **TV tuner** which is compatible with cable TV and allows you to receive any TV channel using a common TV antenna or cable TV.

The miroVIDEO PCTV package contents include the following software:

- ♦ **miroTELEVISION** is an application you can use to select the channels and the inputs.

* If you are in doubt, please refer to the documentation of your motherboard.

** For a TV overlay, the PC and the graphics board have to meet certain requirements (see the "System requirements" section). You will find a list of successfully tested graphics boards in the Appendix.

- ♦ With the **miroTELETEXT** application (only available in Europe) you can make use of the teletext function offered by many TV stations and save and print teletext pages.
- ♦ **VidCon32** lets you record single-frames or video clips directly to hard disk (uncompressed and compressed, in the AVI format and with a size of 768 x 576 pixels).
- ♦ **Kai's Power Goo**, image editing application.
- ♦ **InterCast Viewer**, an application you can use to view HTML teletext pages (modern type of teletext). The InterCast Technology allows the broadcasting of text and images in HTML format along with a conventional TV broadcast signal. HTML is the page layout (Hypertext Markup Language) which is commonly used in the Internet. At the time, only a few channels broadcast intercast pages.
- ♦ **Windows 95** and **Windows NT** drivers.

miroVIDEO PCTV pro also offers:

- ♦ a stereo and MTS audio decoder,
- ♦ **miroRADIO**, the tuner application for the FM radio module,
- ♦ a video editing application on a separate CD.



Windows NT:

Under Windows 95, **miroVIDEO PCTV pro** offers the full functionality. At the date of release, only the **miroVIDEO PCTV** functions are supported under Windows NT, (only TV without stereo, only single-frame capturing). Under Windows NT **miroVIDEO PCTV (pro)** does not support **miroTELETEXT**, **InterCast Viewer**, **Kais Power Goo**, **VidCon32**.

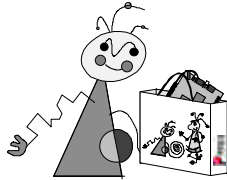

Before you begin

SYSTEM REQUIREMENTS

To install miroVIDEO PCTV (pro), your computer system has to meet the following requirements:

Hardware

- ♦ *Computer:*
Pentium computer (recommended: Pentium 90 MHz) with an empty master PCI slot (PCI-system 2.1 or higher) and CD-ROM drive.
- ♦ *Memory:*
At least 8 Mbytes memory (recommended: 16 Mbytes) * .
- ♦ *Graphics board:*
A graphics board with at least 8 bits color depth (256 colors).

DirectDraw support:

Before you begin to work with the miro applications, a graphics board with a complete DirectDraw must be installed.**

The miro installation program checks to see if DirectDraw has been installed. If this is not the case, it will install DirectDraw automatically.



- ♦ *Sound board:*
If you want to record sound, modify audio clips, or control the volume using the miro software, your computer has to be equipped with a Windows-compatible sound board (standard or miro sound board) having a free audio input.
- ♦ *Monitor:*
Standard VGA monitor. To receive all the benefits from the graphics board, you need a monitor which is especially suited for your graphics board.

Software

- ♦ Windows 95 or Windows NT 4.0.
- ♦ If you want to use the InterCast Viewer, the Internet Explorer has to be installed on your computer. The Internet Explorer is contained on the supplied CD-ROM and can be installed using the install program.

* If you want to use the miroMEDIA PCTV board primarily for capturing or for video conferencing, your computer should be equipped with at least 16 Mbytes of memory.

** The following graphics boards support DirectDraw:
miroCRYSTAL VRX, miroMEDIA View, miroMEDIA 3D, miroVIDEO 22SD, graphics boards with a TrioV64+ or S3 ViRGE/ViRGE VX chip.

Video devices

- ◆ *S-Video input and composite video input:*

The miroVIDEO PCTV connects to any video source (VCR, video camera, laserdisk) generating a composite video or S-Video signal in PAL, NTSC, or SECAM quality, e.g. VCR, camcorder, video camera or satellite receiver, independently of the video system you use (e. g. VHS, S-VHS, Hi8, Video 8).

Audio devices

- ◆ *Internal/external audio output:*

The *internal audio output* (see board layout below, ST 7) connects to the internal audio input of a sound board. The *external audio output* connects to the Line In input of the sound board or to powered speakers.

- ◆ *Internal audio input:*

You can connect the internal audio input to the audio output of a CD player. The software allows you to loop the internal audio output through to the external audio output (see also the “miroTELEVISION” chapter in the online manual).

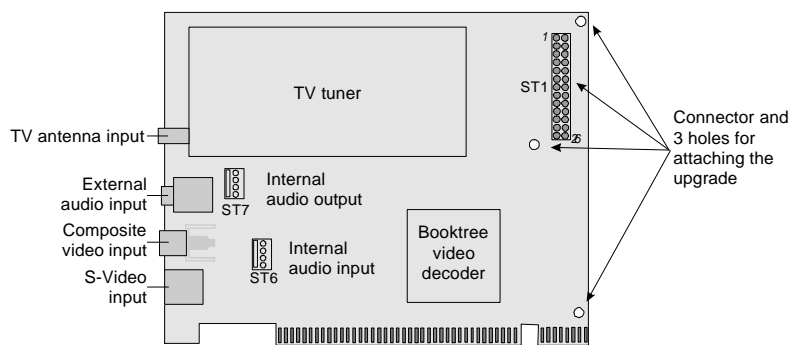

miroVIDEO PCTV board layout

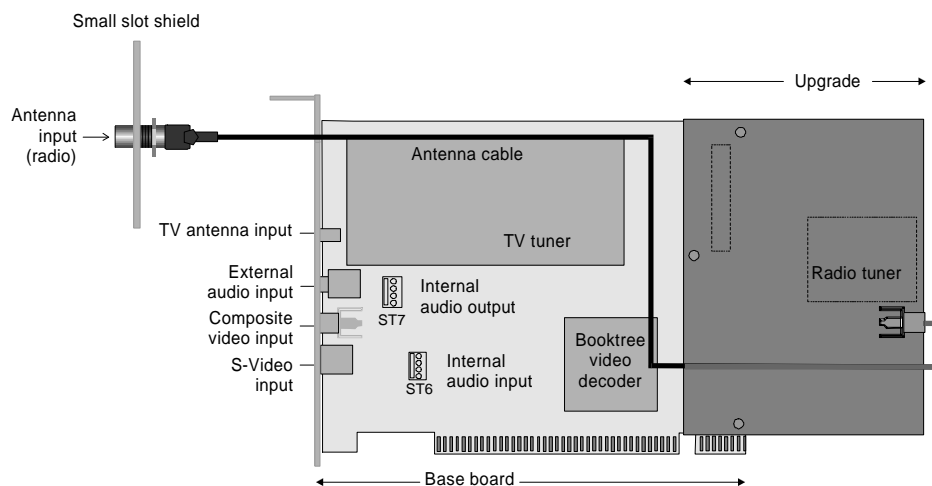

miroVIDEO PCTV pro board layout

Antenna/cable

- ◆ Connect the *TV antenna input* of the base board to a video antenna (coaxial connector) or a cable connector.
- ◆ *If you installed the miroVIDEO PCTV pro:* connect the *radio antenna input* of the upgrade to the radio antenna (coaxial connector) or a cable connector.
- ◆ To connect video devices to the miroVIDEO PCTV base board, you need suitable cables (RCA or S-Video cables).

PACKAGE CONTENTS

Before beginning the installation of your multimedia board, please check to make sure your package is complete*:

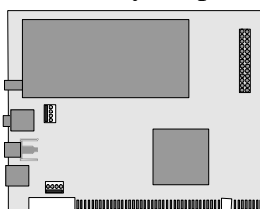

miroVIDEO PCTV**

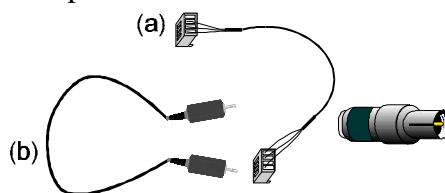

Internal audio cable (a) or external audio cable (b)***

Adapter for the TV antenna connector (may be plugged in already)



CD-ROM containing drivers, applications, online documentation



CD-ROM with additional applications****



This Quick Installation Guide

* Depending on the delivery scope, the actual package contents may be different from the package contents listed in the manual.

** For model and serial number of your miro board, refer to the label on the board.

*** Depending on the delivery scope, an internal or external audio cable is included in the package contents.

**** Depending on the delivery scope, either one or two CDs will be supplied.

**miroVIDEO
PCTV pro**

The miroVIDEO PCTV pro package contents contain the following components in addition to the ones mentioned above* :

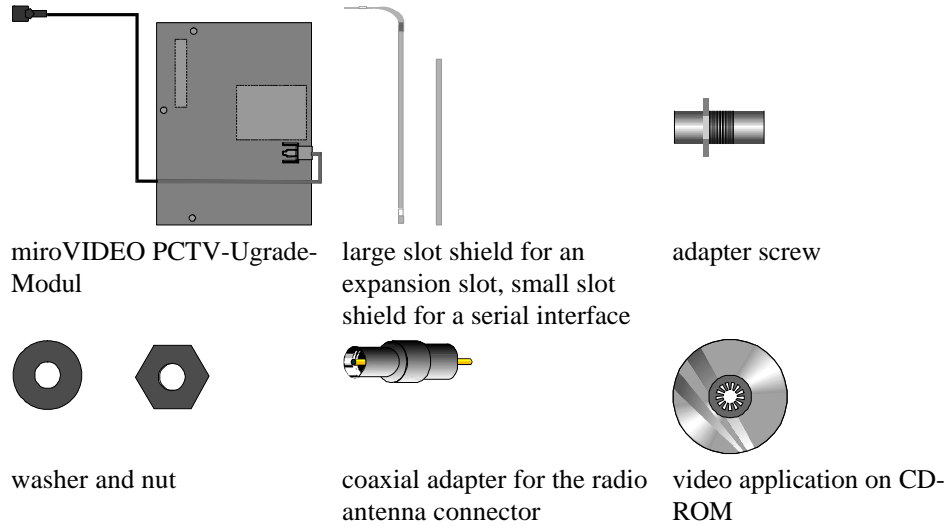

miroVIDEO PCTV-Ugrade-Modul

large slot shield for an expansion slot, small slot shield for a serial interface

adapter screw



washer and nut



coaxial adapter for the radio antenna connector

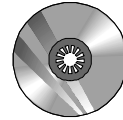

video application on CD-ROM

If any parts are missing, please contact your dealer or retailer. You will find the complete software and documentation on CD-ROM. Diskettes are not included in the package contents.



Multimedia boards are sensitive to static charge. To avoid damage that may occur by static charge, leave the board in its antistatic packaging until installation. Keep the packaging for possible future transportation.

* Depending on the delivery scope, the actual package contents may be different from the package contents listed in the manual.

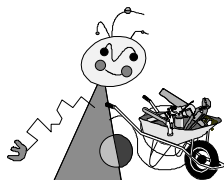

Hardware installation

PREPARING THE INSTALLATION



The only tool you need for the installation is a screwdriver. Proceed as follows:

1. Discharge yourself of static charge by touching the power unit casing.
2. Turn off your computer and all peripheral devices. Disconnect the computer from the power supply and all necessary components.
3. Loosen the computer's cover screws and remove the cover.
4. Select a free PCI (**busmaster**^{*}) slot. Remove the slot's cover at the back of the computer and keep the screw .

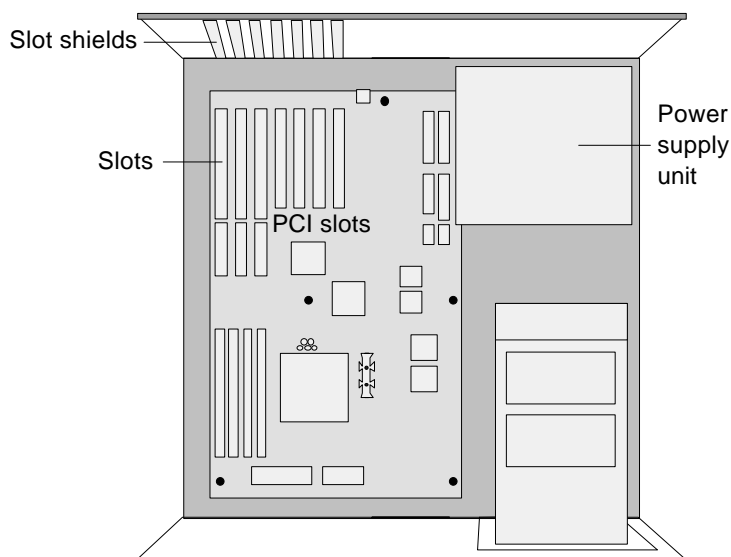

CONNECTING miroVIDEO PCTV PRO

Only for PCTV pro:

Use one of the plates included in the package contents which provide a hole for the antenna cable. Depending on whether an opening of a free expansion slot or of a serial interface is available at the back of your computer, use the large or the small metal plate through which you can lead the antenna cable.

1. Remove a slot shield or the shield of a serial interface from the back of your computer.
2. Connect the coaxial adapter to one of the supplied metal brackets using the nut and washer provided.

^{*} If you are in doubt, refer to the manual of your motherboard.

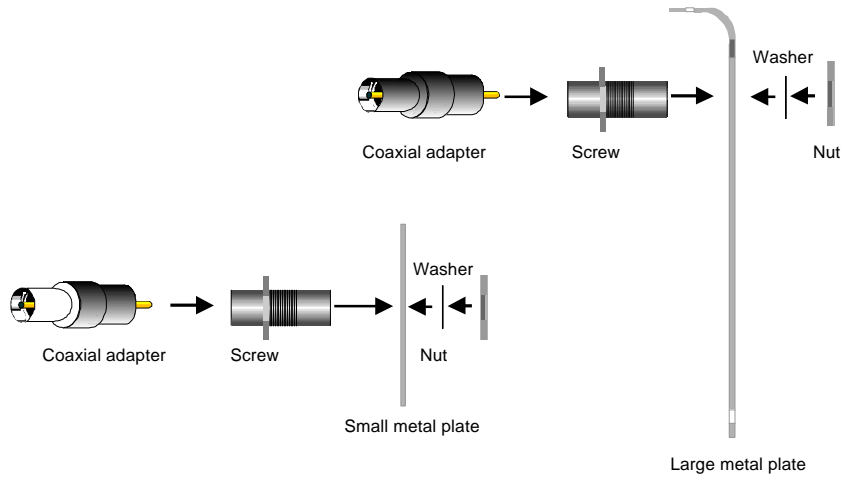

Connecting the radio antenna cable

3. Fit the large or the small metal plate with the appropriate screws to a free slot at the back of your computer.
4. Attach the antenna cable from the upgrade module to the adapter screw.
5. Carefully attach the supplied coaxial adapter to the adapter screw.

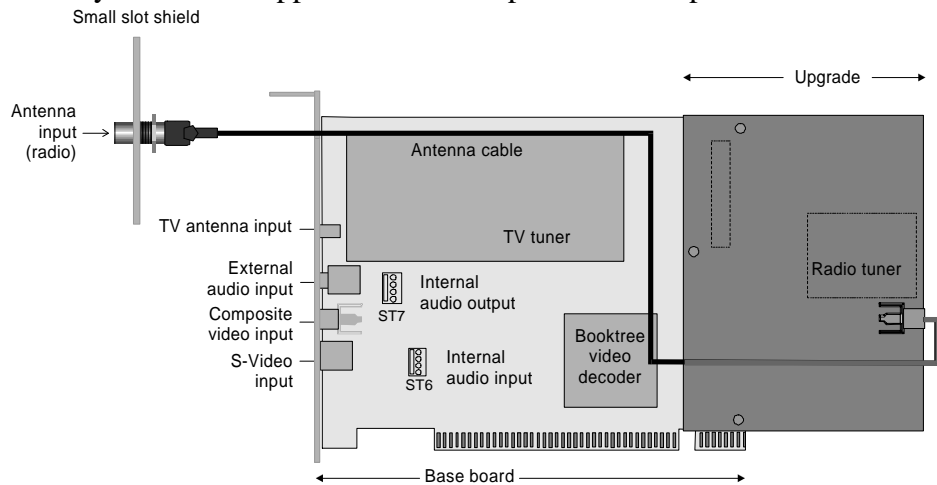

Connecting the adapter screw to the slot shield

INSERTING miroVIDEO PCTV (PRO)

Connecting the sound board (internally)

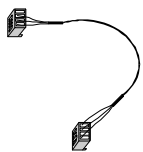

1. If necessary, connect the *internal* connectors of miroVIDEO PCTV to the corresponding devices.
2. Carefully insert the board into the PCI slot by holding the board at the top and gently pushing both ends into the slot at the same time. Press onto the upper edge of the board to make sure it is firmly seated in the slot.

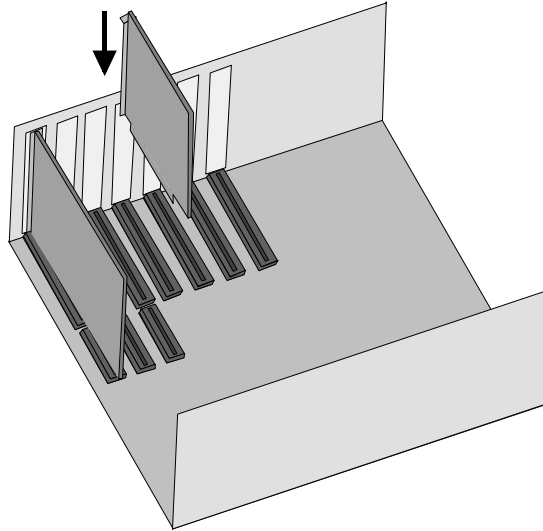

2. Don't force the board into the slot! You run the risk of bending the contacts. If the board does not fit easily, pull it back out, and try again.

AFTER THE INSTALLATION

3. Fasten the board's bracket at the back of the computer using the screws you saved from the shield.
4. Put the cover back on the computer and reconnect the peripheral devices.



For more information on how to connect the external devices, please refer to the “Connecting external devices” chapter.

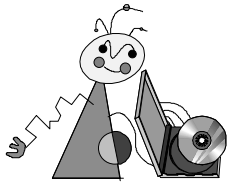

Software installation

This section explains you how to install the miroVIDEO PCTV (pro) software. During the installation, the miroVIDEO PCTV program group will be created and the Windows 95 or Windows NT drivers and the tools will be copied into this group.

WINDOWS 95

Software update/ radio module

The course of the installation depends on whether you just installed the board or if you want to update an already existing driver.

If you only wish to update your current driver or just install the radio module, please read the “Updating the driver” section on page 13.

We recommend you to determine the Windows 95* version you use before installing the software. For further information on identifying the Windows version, please refer to the Appendix on page I.

miroVIDEO PCTV (pro) has just been installed...

Once you have installed the miroVIDEO PCTV (pro) board in your computer, the board will be detected as a new hardware component.

Windows 95 (Release August 95)

After Windows 95 has started, the *New hardware found* dialog box will appear.

1. Click on the *Driver from disk provided by hardware manufacturer* option.
2. Insert the CD-ROM from the miroVIDEO PCTV (pro) package contents.
3. Click *Browse...*
4. Switch to your CD-ROM drive to the **\DRIVERS** directory. When the **MIROPCTV.INF** file appears, click *OK*.

OEM Service Release 2

The *Assistant for Device Driver Updates* appears:

1. Click on *Next*.
2. Insert the CD-ROM from the miroVIDEO PCTV package contents.
3. Click on *Other Locations...* . Click on *Browse*.
4. Switch to your CD-ROM drive to the **\DRIVERS** directory. Click *OK*.

Both versions

In the *Select device* window or *Assistant for Device Driver Updates* window (OSR 2) the miroVIDEO PCTV (pro) board has already been selected.

* You can check which Windows 95 version you use by entering the DOS command **ver**. The OSR 2 (OEM-Service-Release 2) version the version number Windows 95. [Version 4.00.1111]; the August Windows 95 Release has the version number Windows 95. [Version 4.00.950].

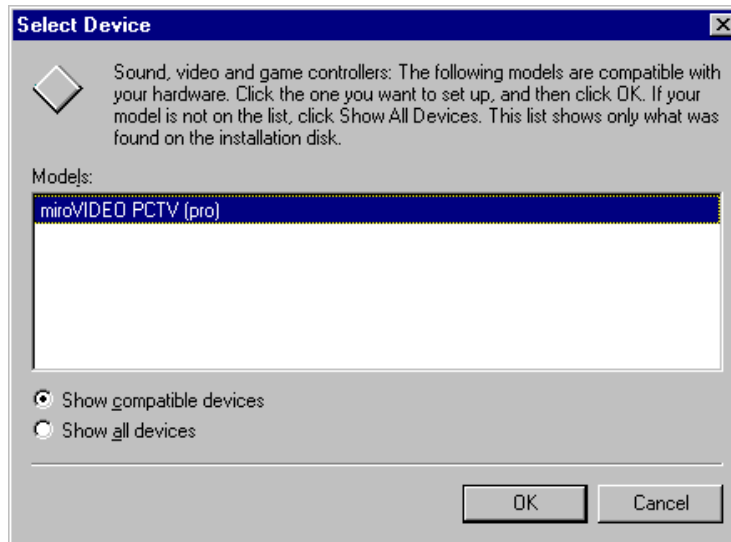

Windows 95 (Release August 95)



OEM Service Release 2

5. Click *OK* or *Finish*.

The drivers are now being installed.

OEM Service Release 2

When you are being requested to insert a new data carrier, click on *Browse* to select the path **\DRIVERS**.

- Click *OK* again.

The remaining files are now being copied.

Both versions

6. When being requested to restart Windows 95, answer *Yes*.

7. After starting the computer select the *Start* menu in the Taskbar and the *Run...* command. Depending on your CD-ROM drive enter:

d:\miro_win<+> where **d:** is the drive of your CD-ROM drive. Click *OK*.

The miroSETUP-Manager starts up.

8. Select the language you want to use for the installation. Click *OK*.

9. In the *miroSETUP-Manager Module Selection*, select the diskette icon (*Drivers and Programs*).

10. Enable the *Programs for miroVIDEO PCTV (pro) for Windows 95* and click *Install....*

The installation program is launched automatically.

11. Select the language you want to use for the installation. Proceed by clicking *Next*.

12. In the *Select components* window the tools have been selected. Click on *Next* to copy the tools.



In the *Select components* dialog box, please leave DirectX 5.0 selected. Operating the PCTV board requires this DirectX version. It is also vital that you install the online documentation because it contains important information on connecting and operating the miroVIDEO PCTV (pro) board.

If you have two video capture boards installed in your computer, you can select the standard video capture board (the one you want to use for capturing). This board is then the standard board used by your video capture applications.

13. If two video capture boards are installed in your computer: select your standard video capture board.

Now the *Select TV Country* dialog box appears.

14. Select the country where you are staying and click OK.

15. Read the information which now appears and click on *Next*.

16. If you selected *Intel Indeo video interactive* under item 12, the Intel installation program will now be launched which will install the software compressor. Please follow the instructions of the program.

17. When the DirectX 5.0 installation will be started, please follow the instructions of the program.

After the DirectX installation has been completed, you can install the Internet Explorer and the Intercast Viewer.



To use the Intercast Viewer, the Internet Explorer 3.x or higher has to be installed. Please note that the Internet Explorer can alter the looks of your Windows user interface.

The Explorer (approx. 55 MBytes) and the Intercast Viewer (approx. 16 Mbytes) occupy more than 70 Mbytes on your hard disk. The installation takes some time.

18. Maximize the *miroSETUP-Manager* which has been iconized in the task bar.

19. Please select the *Internet Explorer 4.0* and click *OK*. Follow the instructions of the installation program. Restart your computer when you are requested to do so.

20. After having restarted the computer, start the *miroSETUP-Manager* again as described under item 7. Follow instructions 8 and 10.

21. Select the *Intercast Viewer*. Click *OK* and follow the instructions of the installation program. Restart your computer when you are requested to do so.

Now the installation is complete. The tools are dropped in the miroVIDEO PCTV program group. Here you will find an option for deinstalling the tools.

Updating the driver...

If you want to update the miroVIDEO PCTV (pro) driver, you must first remove old drivers and entries from the Registry file. Please proceed as follows:

1. If you have not done so already, start Windows 95.
2. From the *miroVIDEO PCTV/miroMEDIA PCTV* program group, select the deinstallation program for the tools. Deinstall the tools.
3. From the *Start* menu, select *Settings* and the *Control Panel*.
4. Select *Add/Remove software*.
5. In the *Install/Deinstall* tab select the *miroMEDIA PCTV/miroVIDEO PCTV* and click *Add/Remove*.



If the *miroVIDEO PCTV* entry does not exist, please start the deinstall program from the supplied miro CD-ROM (Version 2.00):
Select the *Start* menu in the Taskbar and the *Run...* command. Depending on your CD-ROM drive, enter:
d:\drivers\uninpctv.exe where **d:** is the drive of your CD-ROM drive. Click *OK*.

5. Restart your computer.
6. Install the drivers and the remaining software for your Windows 95 version described of page 12 item 11.

WINDOWS NT



If you want to use the miroVIDEO PCTV (pro) under Windows NT, you need a graphics board which supports DirectDraw*.
To be able to install the software, you must have the administrator's rights under Windows NT.

miroVIDEO PCTV (pro) has just been installed...

To install the miro drivers for Windows NT, proceed as follows:

1. Start Windows NT.
2. Insert the CD-ROM from the miroVIDEO PCTV (pro) package contents. The miroSETUP-Manager will start automatically.

* DirectDraw is only supported as of Windows NT version 4.0.



If the *miroSETUP-Manager* does **not** start automatically or if you want to start it at a later date, select the *Start* menu and the *Run...* command. Enter **d:\miro_win.exe** where **d:** is the drive of your CD-ROM drive. Click *OK* to start the *miroSETUP-Manager*.

3. Select the language you want to use for the installation, confirm by clicking *OK*. You are then in the *miroSETUP-Manager Module Selection*.
4. Select *Drivers and Programs*.
You are then in the *miroSETUP-Manager Drivers and Programs* window.
5. Enable the menu item *Drivers for miroVIDEO PCTV (Windows NT)* and click *Install...*

The *miro* installation program is started automatically.

6. Install the drivers and the remaining software for your Windows 95 version following the instructions described of page 12 item 11.

Updating the Driver...

If you want to update the *miroVIDEO PCTV (pro)* driver, you must first remove old drivers and entries from the Registry file. Please proceed as follows:

1. If you have not done so already, start Windows NT.
2. From the *miroVIDEO PCTV* program group select the *deinstall program (miroTELEVISION & Driver)*. *Deinstall tools and drivers*.
3. Install the new software as described under “*miroVIDEO PCTV (pro)* has just been installed...” on page 13.

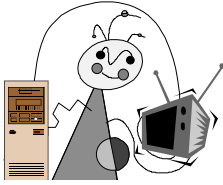

Connecting devices

This illustrations show you the PCTV (pro) connectors:

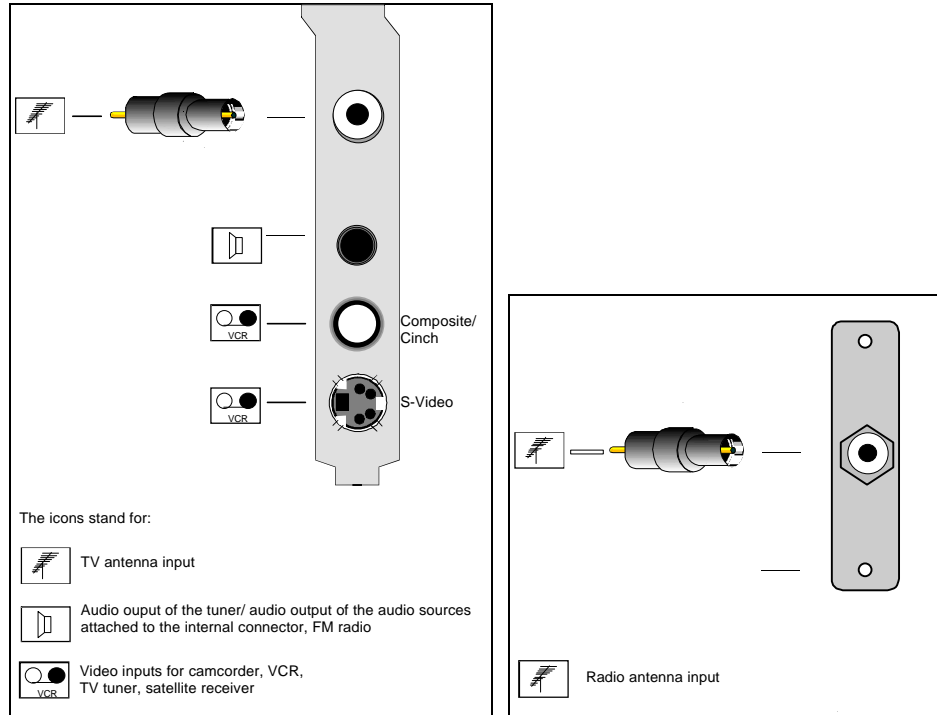

miroVIDEO PCTV: Connectors

miroVIDEO PCTV pro: Connector

CONNECTING THE VIDEO/AUDIO DEVICES

Connecting video camera/ VCR

Most video cameras and VCRs are equipped with RCA outputs. More advanced video cameras and VCRs also have S-Video inputs. To connect the video inputs to the corresponding miroMEDIA PCTV (pro) inputs, you need a suitable shielded cable (RCA or S-Video cable).



If your video source has an S-Video output, use this instead of the composite video output because it provides a better video quality.

- Connect the video output of a video camera or a VCR to the composite input of the miroMEDIA PCTV (pro).

CONNECTING THE ANTENNA CABLE

- TV**
- If the adapter for the antenna connector (video) has not been attached already, plug it onto the miniature RCA jack on the bracket.
 - Connect the antenna cable to the now fitted adapter or connect the antenna cable to the antenna input of the PCTV board.



Important:

The quality of your antenna cable influences the reception considerably

- Radio**
- *miroMEDIA PCTV pro only:*
Connect the radio antenna to the coaxial adapter or interconnect you cable radio jack to the radio antenna input on your PCTV base board.

CONNECTING THE SOUND BOARD/POWERED SPEAKERS

**Connecting the
sound board
(externally)**

- If you want to use the external audio output, connect it to the Line-In input of your sound board using the external audio cable or to the powered speakers.

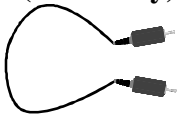

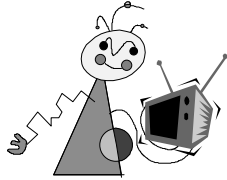

PCTV applications

miroTELEVISION



Please note:

Under **Windows NT** not all functions of the miroTELEVISION application are supported. These are among others the automatical detection of mono, stereo and MTS reception, the detection of the channel name and the audio options from the *Settings* dialog (see below). Options which cannot be selected are grey.

Prerequisites

To be able to use the miroVIDEO PCTV (pro) board for watching television and videos, the following requirements have to be met:

♦ **Installation:**

To use miroTELEVISION, you have to have installed this application from the CD-ROM included the miroVIDEO PCTV (pro) package contents.

♦ **For TV:**

The miroVIDEO PCTV antenna input has to be connected to an antenna or a cable TV connection. To ensure a tight fit of the antenna cable, use the antenna adapter from the miroVIDEO PCTV package contents. In the *Select TV Country* application from the miroVIDEO PCTV program group, select the country appropriate to where you are using the television. In doing so, the frequency range used for broadcasting in your country is selected. (Of course, it is not possible to receive stations from other countries using this program.)

♦ **For Video:**

A VCR has to be connected to the miroVIDEO PCTV video input . If the VCR supplies an S-Video signal, you can connect it directly to the S-Video input, if your VCR supplies a composite signal, use the adapter for composite video sources.

To watch television using the miroVIDEO PCTV board, proceed as follows:

- First, start the miroTELEVISION application from the miroVIDEO PCTV program group.

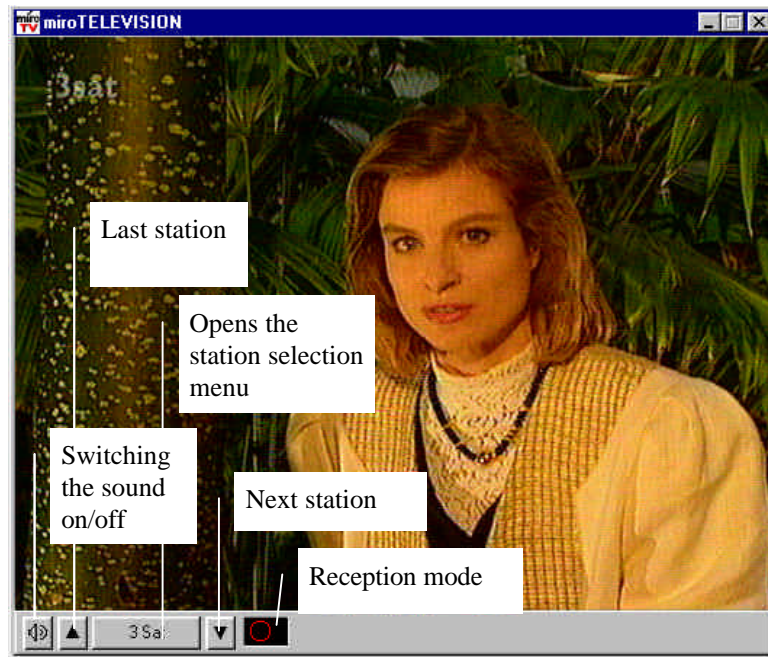

This window lets you

- ♦ select the channel or switch to VCR operation,
- ♦ select the aspect ratio of the TV window,
- ♦ capture the current TV image (only single-frames).
- ♦ *only miroVIDEO PCTV pro:*
detect the reception mode (MTS, stereo, mono)

If you click the button displaying the current channel, a channel list pops up. This list lets you select TV channels, switch from TV operation via the cable tuner or to external video sources, e.g. a VCR. If you have connected a VCR with a composite output to the *miroVIDEO PCTV* video input, select *Composite*. If you have connected an S-Video VCR to the video input select *S-VHS*.

Pop-up menu

When using the right mouse key to click on the *miroTELEVISION* window, a pop-up menu appears which allows you to make further settings.



TV Station...

To search for the TV channels and to make the corresponding settings, first start the *Station settings* dialog.

- From the pop-up menu, select the *TV Station* option.

The *Station settings* dialog window appears:



Searching for all stations

To search for all stations that can be received, click *All Stations*.

Then, the channel names of all received stations are entered in the sender list.

The channel name is detected automatically if the channel provides teletext information. If the channel cannot be identified, *Station* will be entered.

Search for next station

To search for the station with the next higher frequency, click *Next Station*.

Abort Search

To abort the running search process, click on *Abort Search*.

Quick Search

If this option is enabled, only the channels within the country-specific frequency range are searched. If all channels have not been found, you can search in more detail by disabling this option. However, this is not recommended, if a VCR which is connected to the antenna input is also not detected.

No duplicate stations

If a channel is found several times, the one transmitting the strongest signal is selected.

Station

To overwrite the channel names in the station list with the station names,

- click on a channel name in the station list.
- Overwrite the channel name.
- Click *Accept*.

Adding an entry to the station list

To add an entry,

- click on the station which is located at the position in the station list where you want to insert the new station,
- overwrite the station name and fine-tune the channel.
- Click *Add*.

Deleting stations

To remove the stations from the station list,

- click on the station name in the station list.
- Click *Delete*.

Changing the station order

To drag a station to another position in the list,

- position the cursor on a station name in the list.
- Keep the left mouse button pressed, drag the channel to the desired position, and release the mouse button.

Channel

Under *Channel* you can select channels (frequency ranges). There is not necessarily a station broadcast on every channel. Use the arrow keys to select the next or the previous channel. The slider under *Fine Tuning* lets you fine-tune the frequency. If you want to change the channel in the channel list, select the corresponding entry in the list, change the channel and click *Accept*.

Settings...

- From the pop-up menu, select the *Settings* option.

The *Settings* dialog window appears:

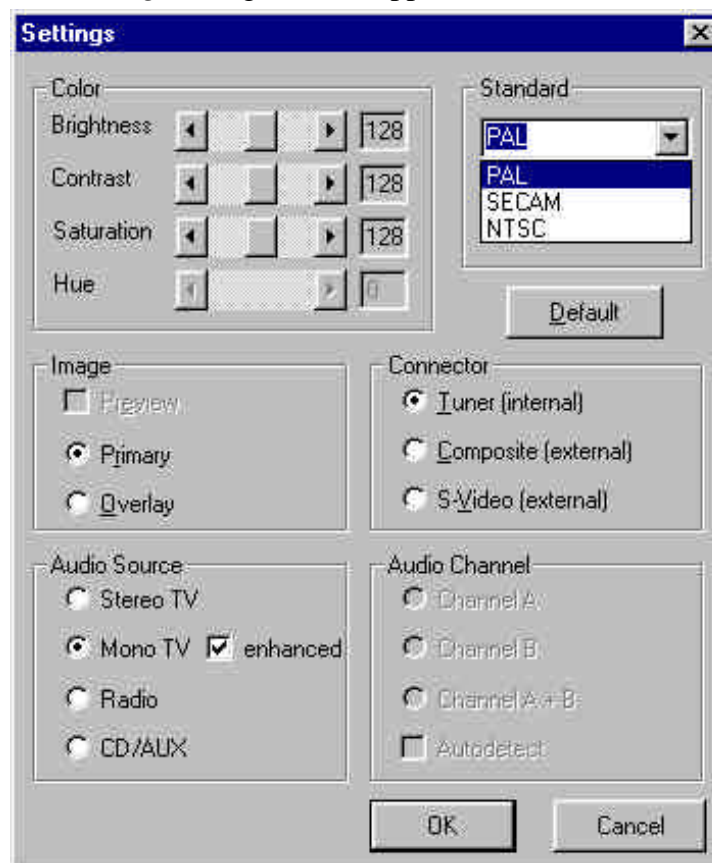

- Under *Color* you can adjust the *Saturation*, the *Brightness*, and the *Contrast* of the TV image. You can only change the *Hue* for NTSC.
- The options available under *Standard* depend on the connected video source. For the TV function, select the video standard used in your country, for composite and S-VHS video sources select the video

standard provided by the connected video source (PAL, NTSC, or SECAM).

Default sets the image settings to mean values.

- Select the overlay type you prefer under *Image*.
- Under *Connector*, select the video source for which you want to make the settings. Select *Tuner* for TV, *Composite* for a Composite VCR and *S-Video* for an S-VHS VCR.

Audio Source

Select the sound input you want to use.



For the TV mono operation:

To improve the mono quality, you can enable the *enhanced* option. If the mono reception is distorted (noise), you should disable the *enhanced* option.



If you installed the miroVIDEO PCTV base board, you can only select the mono function because the tuner of the base board only provides a mono reception.

- Select *Stereo TV*, if you want to use the stereo reception.

If the selected channel transmits stereo signals, the tool bar displays the stereo reception mode:



- Select *Radio* if you want to listen to the radio (first you have to select a channel with the miro radio application).
- Select *CD/AUX*, if you want to hear the audio device connected to the internal audio input.

Audio Channel (miroVIDEO PCTV pro only)

If a channel broadcasts MTS, you can select whether you want to hear the original, the dub language, or both.

- Select *Channel A* if you want to hear the dubbed version.

The tool bar then shows the reception mode MTS/
first channel only /mono:



- Select *Channel B* if you want to hear the original version.

The tool bar then shows the reception mode MTS/
second channel only/mono:



- Select *Channel A+B* if you want to hear both versions simultaneously.

The tool bar then shows the reception mode MTS/
both channels simultaneously:



Full screen/768 x 576/384 x 288

The pop-up menu lets you choose between the image sizes Fullscreen, 768 x 576, and 384 x 288. To achieve the optimum image quality, select 768 x 576. In this case, both half frames are displayed. At a resolution of 384 x 288, only one half frame is displayed.

4:3 / 16:9

This option toggles between the 4:3 and the 16:9 aspect ratio. 4:3 is the common TV format.

X:Y

This option lets you change the width and the height of the window without keeping the aspect ratio. When the mouse pointer turns into a double-arrow drag the window frame to the desired size.

Cropping

When enabling *Cropping*, your TV image will have no black image margin.

Making the image smaller

You can make the image smaller, by clicking with the right mouse key on the lower right corner and moving the corner so that the window will have the desired size. You can switch the menu bar on and off by double-clicking the right mouse key on the window.

Function keys

The <F2> function key calls the context menu.

<F3> switches the task bar/menu bar on/off. The <F5> key freezes the current image.

Recording current TV image

The <F4> key stops and saves the current image (BMP format).

miroAV-CONTROL

miroAV-Control is a tool bar offering all functions you require for using your capture program (e. g. VidCon32).

miroAV-Control lets you select the sound inputs, the channels, the connected video source and start the capture program (by default VidCon32 is selected).

Starting

- Start the *miroAV-Control* application from the miroVIDEO PCTV program group
or
select *Programs* from the *Start* menu and the *MS-DOS-Prompt*. In the DOS box, enter
`mirotv32 /NOVIDEO.`

The miroAV-Control tool bar appears:

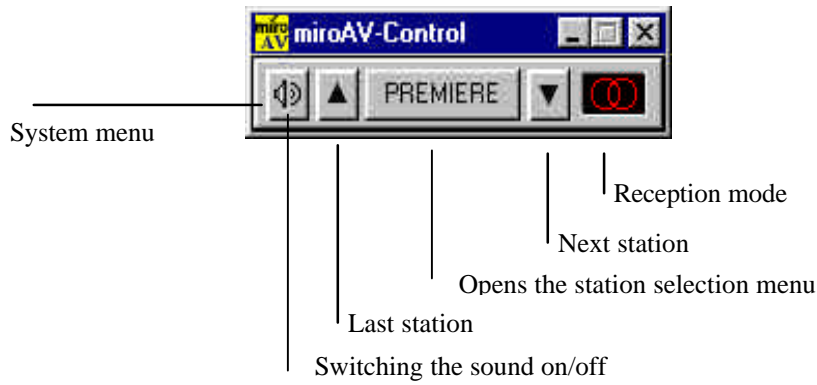

System menu

Clicking the system menu button opens the system menu:



Here you can make the settings for your windows and close the program.

When you select the *Audio* command, a sub-menu opens where you can select the sound input.

When clicking the *Execute ...* command, a dialog appears where you can call a capture program:

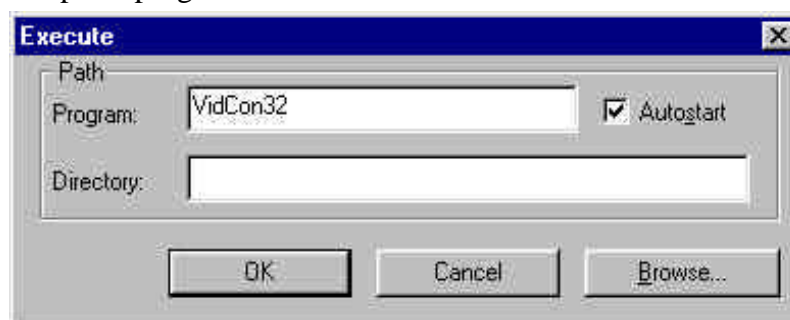

- Under *Program* and *Directory*, enter the name and the path of the capture program you want to start (default: VidCon32).
- Mark the *Autostart* option if you want the selected program to start automatically when launching miroAV-Control.

miroTELETEXT (WINDOWS 95 ONLY)



Teletext cannot be received in all countries and not all channel broadcast teletext.

To start the miroTELETEXT application, click miroTELETEXT in the miroVIDEO PCTV program group.

If the channel you currently selected broadcasts teletext, the miroTELETEXT main window appears and the index page is opened automatically (page 100).

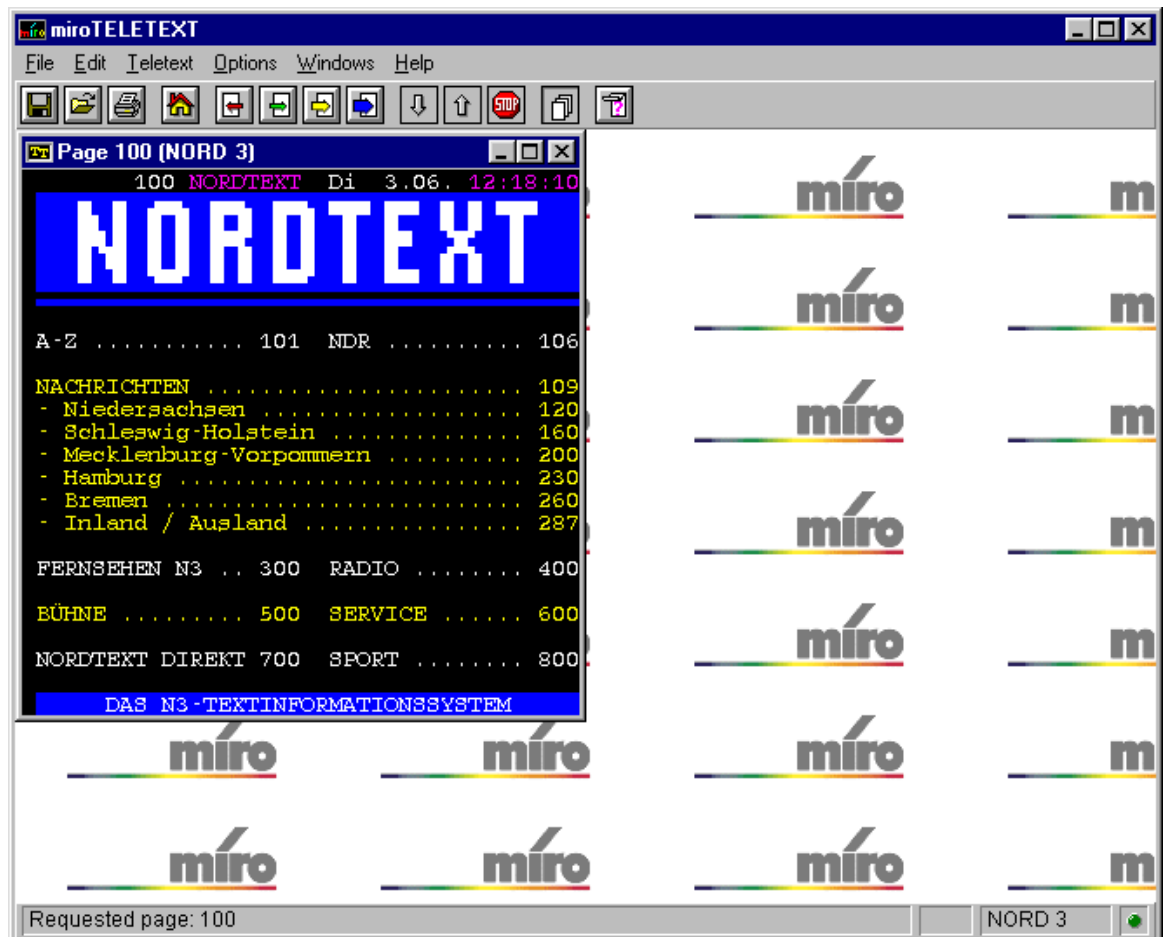

You can select teletext pages in several ways:

- ◆ Enter a three-digit page number.
- ◆ In the *Teletext* menu, select the *Open* command. Then, enter the desired page number(s). To open several individual pages, separate the page numbers by commas. To select subsequent pages, enter the numbers with a hyphen.
- ◆ Keep the left mouse button pressed and drag the mouse pointer over the page numbers shown in the teletext window. The page number to which the mouse cursor points is highlighted. When releasing the mouse key, the page is selected.

You can close the miroTELETEXT application by clicking the close button in the title bar.

The main window looks the same as the one you are already familiar with from Windows applications. At the top you find the title bar with the familiar

icons you can use to control the windows with the default (*File*, *Edit*, and *Help*) and other menus. In the icon bar you find buttons to control the application. The status bar at the bottom of the window gives you information about the current status or the function of the individual icons in the icon bar.

Menus

File The *File* menu lets you save the page of the current window to hard disk or print it.

Save as text...

Select this command if you want to save the page as text (in the TXT format). Enter the name and the directory of the file in the dialog window.

Save as BMP...

Select this command if you want to save the file as image. Enter the name and the directory of the file in the dialog window, which will then be saved in the BMP format.

Print

To print the active page, select the *Print* command. The Windows 95 active printer will be used.

Edit The *Edit* menu allows you to copy teletext pages to the Windows clipboard.

Copy as TXT

Select this command to copy the current page as text. You can use a word processing program (e. g. the Windows text editor) to edit the teletext page contents.

Copy as BMP

Select this command to copy the current page as image.

Teletext *Open*

To open one or several pages, select the *Open* command. Enter the desired page number (it appears in the status bar) and click OK. Individual pages are separated by a comma, subsequent pages are entered with a hyphen (e. g.: 101-105, 107). When calling up several pages, the *Multiple page windows* option will be enabled automatically, see also *Options* menu.

Index

This command opens the index page 100.

Previous

With this command you start the previous page.

Next

This command opens the next page.

Next block page

This command calls up the next page terminating with a number of 10. If e.g. page 501 is currently active, miroTELETEXT will jump to page 510.

Next group page

This command calls up the next page terminating with a number of 00. If e.g. page 501 is currently active, miroTELETEXT will jump to page 600.

Previous/Next sub-page

One teletext page can include several sub-pages, the miroTELETEXT software will automatically browse through the sub-pages. If sub-pages have already been received, you can browse through these pages using the

corresponding menu items. Automatic updating of sub-pages will be stopped. Further incoming sub-pages will be registered in the background and existing sub-pages will be updated.

Example: In the title bar 6/2 appears, that means that 6 pages have been transmitted already and that you are viewing page 2 .

Browse sub-pages automatically:

If one teletext page consists of several sub-pages, every new sub-page is automatically displayed. The *Browse sub-pages automatically* item is marked with a ✓, by default. If you want to display a sub-page longer, you can stop the browse function by clicking on this menu item. Clicking it again, switches the browse function back on again.

Options *Multiple page windows*

To work with several windows, click this command. Clicking the command again, disables this function.

Show hidden text

On some teletext pages information is hidden, e.g. solutions for TV quizzes. To show this information, enable the *Show hidden text* menu item.

Previous/next channel

To view teletext pages of the previous or the next channel, click the corresponding menu item.

Channel...

This menu item lets you call the channel dialog containing the list with existing channels.

Switching the channels is only possible when miroTELEVISION is active. In the multipage mode, pages from different channels with the same page number can be displayed simultaneously: a new window is created and is displayed simultaneously with the one which is currently open. In the single-page mode the window which is currently active will be updated when switching to another channel.

Windows In the Window menu you will find options allowing you to arrange the windows:

Cascade

The windows will be arranged so that they overlap.

Arrange icons

The minimized windows will be arranged in the task bar.

Close all

All windows will be closed.

Minimize all

All windows will be minimized to icon size.

miroTELETEXT icon bar

The icon bar allows you to directly access frequently used commands:

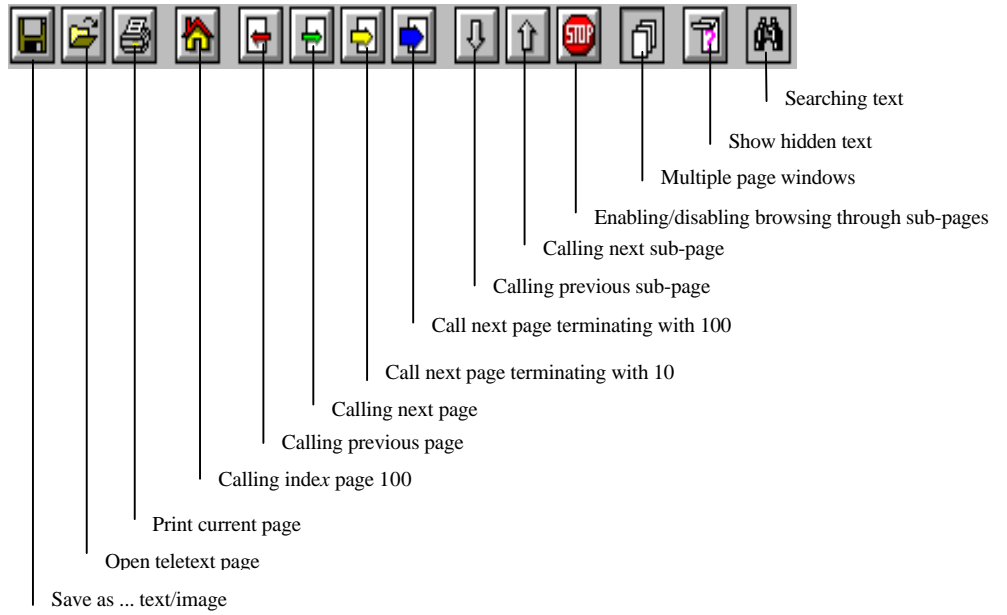

miroRADIO (ONLY WINDOWS 95)

This application features a FM Radio with stereo capabilities.

To start the miroRADIO application, click miroRADIO in the miroVIDEO PCTV program group. The miroRADIO main window will appear:

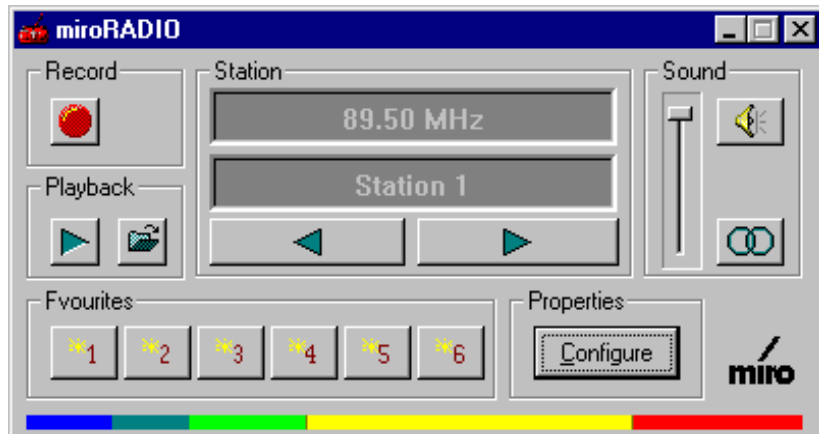

Station

Here the current channel and frequency will be displayed.



lets you select the subsequent channel from the channel list.



lets you select the previous channel from the channel list.

Sound

This group box enables you to control the stereo/mono signal. You can use the slider to set the appropriate audio volume, if you installed a sound board in your system and the external miroVIDEO PCTV audio output has been connected to the Line-In input of the sound board.



The installation program checks if a sound board has been installed. If this is not the case, you cannot control the volume.



mutes/unmutes audio output



toggles between the stereo and the mono signal.

Record

Click on the  button to start recording, the following window will appear.

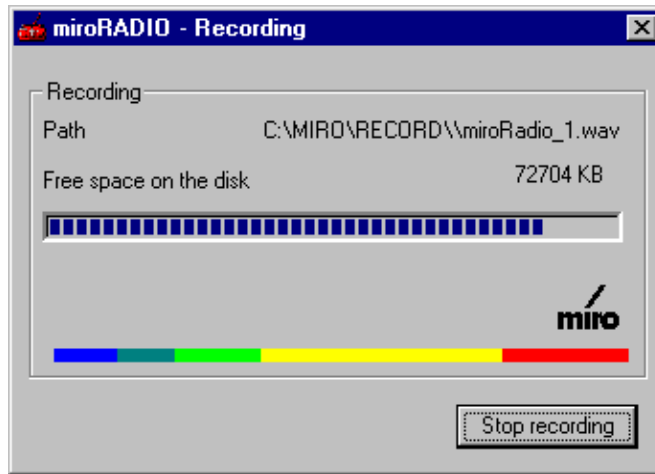

Clicking *Stop recording* aborts recording immediately.

If you do not abort recording manually, the process stops automatically when the predefined time-out (see radio configuration below) value has been reached.

Playback

The last recorded audio sequence can be played back using the  button. Audio output will switch from radio to wav. The station fields will show the file currently playing. Use the volume slider to control audio output volume. The playback can be stopped at any time.

Use the  button to select and play a file from the miroRADIO record folder. The dialog field *Open* will show a list of wav files recorded with miroRADIO. Selecting a file will start playing.



Recording and playing back is only possible when a sound board is installed in your system which has been configured by the miroRADIO application. If the sound board configuration did not succeed or if no board has been installed, the controls are grey.

Favourites

Use these buttons to call pre-programmed channels. Pre-programming channels is done via the radio configuration.

Configuring the miroRADIO application

When clicking *Properties* under *Configure* a configuration dialog appears with the *Station list* and *Recording* tabs.

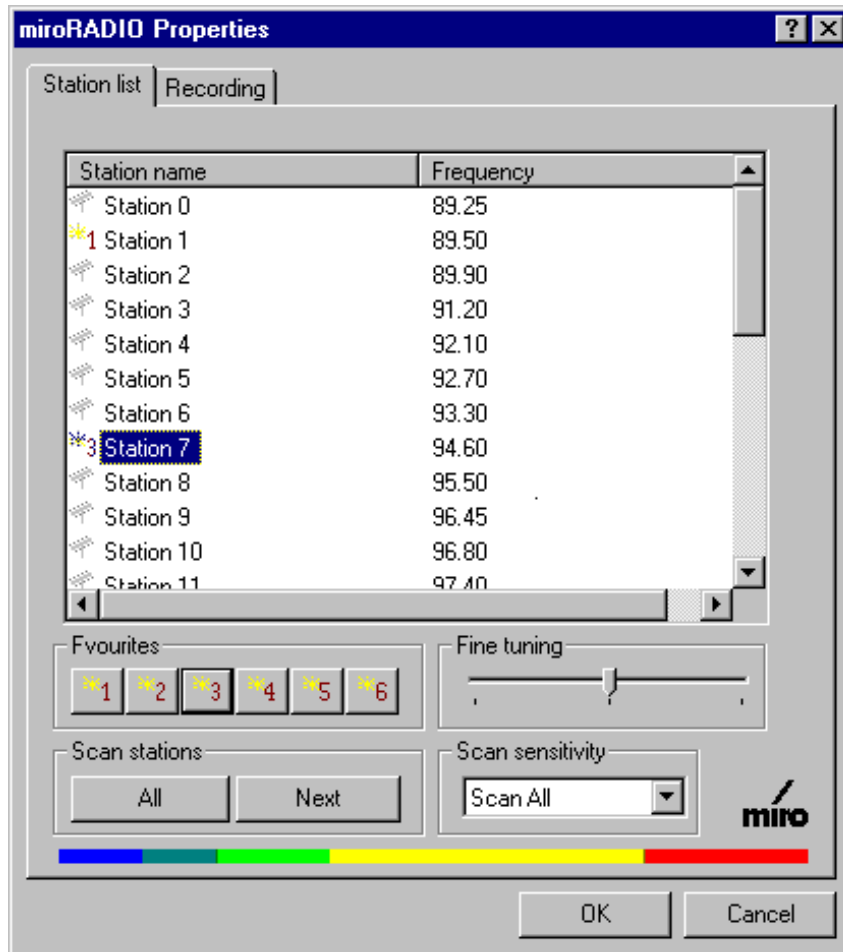

After starting the program for the first time, the application searches for channels and shows all found channels and their frequency in a list.

Station Name	Frequency
Station 6	96.80
Station 7	97.40

Editing station list

- Edit station the name** You can edit the station name at any time, to change the frequency, however, use the fine-tune slider. To edit a name, select the entry and change it.
- Adding stations** Select a station and press the <Insert> key to add a new station. It is then added to the end of the list. Enter the desired frequency which must lie between 87.50 MHz and 108.00 MHz. The frequency is then added to the frequency column and the station name is entered automatically.
- Deleting a station** To delete a station, select it and press the key.
To delete several stations, keep the <Strg> key pressed, select the subsequent stations and press the key.
- Re-position the station** To put a station to another position in the list, use the mouse to point to the station list. Keep the left mouse button pressed and drag the channel to the desired position, release the mouse key.

Favorites/ Allocating stations to the keys



Mark a channel and click one of the station keys:



After a complete search process, the station keys are no longer allocated.

Channel search

The *All* button starts a new channel search. The existing list will be deleted. The channels are searched with the selected *Scan sensitivity* (see below).

Search next channel

The *Next* button searches the channel with the next-higher frequency. If the channel which has been found is not included in the list, it will be added to the end of the list.

Setting the scan sensitivity

Under *Scan sensitivity* you can adjust the sensitivity used for searching the channels. You can choose among 4 quality levels:

- ♦ **best:** the scan routine will accept stations with the best signal strength
- ♦ **high:** the scan routine will accept stations with high signal strength
- ♦ **medium:** scan routine will accept stations with medium signal strength
- ♦ **low:** scan routine will accept stations with low signal strength

Select the desired level and click *All*.

Fine tuning

The *Fine tuning* slider lets you adjust the frequency of the channel you currently selected within ± 50 kHz.

Closing the dialog

When clicking *OK* all settings are accepted and saved. The window will be closed.

Clicking *Cancel* rejects the settings and the window will be closed.

Configuring the recording parameters

The *Recording* tab lets you select the recording parameters:

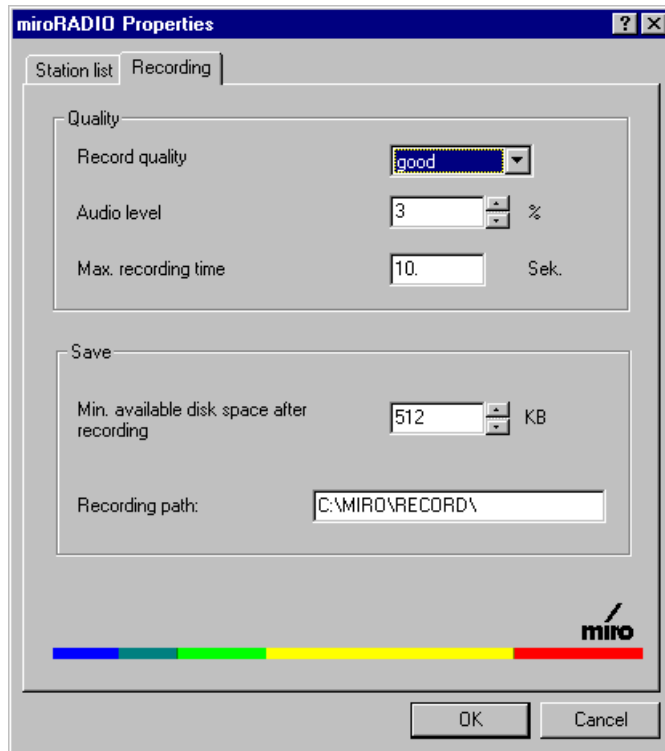

Here you can,

- ♦ select the recording quality choosing the CD, Radio or Telephone parameters,
- ♦ adjust the pitch for the recording (in %),
- ♦ select the maximum recording time (after this time has expired, recording is aborted),
- ♦ specify the remaining memory you want to be available after recording,
- ♦ enter the path and the directory where you want to save the file.

The *Default* button sets all parameters to default values.

CAPTURING VIDEO WITH VIDCON32

To capture AVI files we recommend using VidCon32 This program has been copied into your Windows directory and into the Windows Start menu.

Starting Click on VidCon32 in the miroVIDEO PCTV program group. The VidCon32 main window appears. The icon bar includes the following buttons:

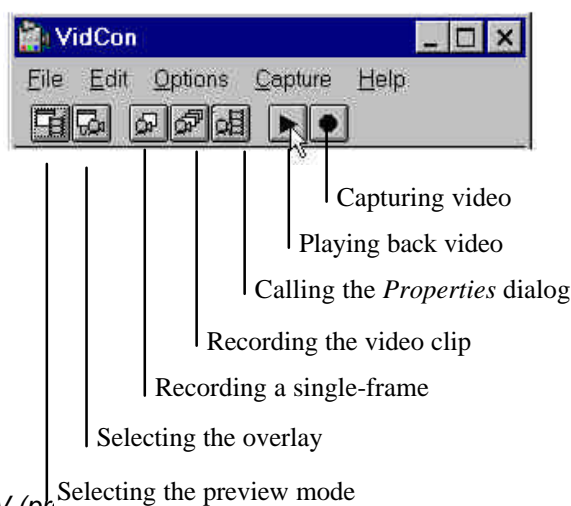

The “Tricks & Tips” chapter gives you more helpful tips on how to use VidCon32 (see chapter 7).

To record video sequences, please proceed as follows:

1. Switch on the video source.
2. If you connected a VCR to your board, search for the beginning of the video clip you want to play back and press *Pause*.
3. Start VidCon32.exe from the Windows *Start* menu.



4. From the *Options* menu select the *Video Source* dialog box.

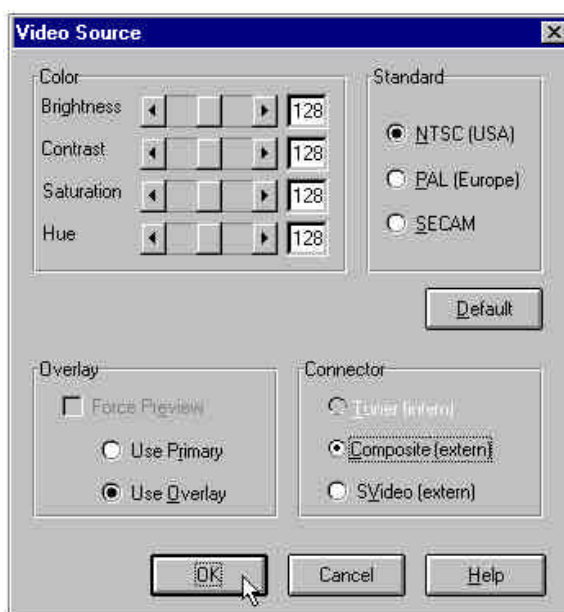

You will find a detailed description of the *Video Source* dialog box under „Settings in VidCon32“ (see page 38).

5. Change the settings if required.
6. From the *Options* menu, select the *Video Format* dialog box.

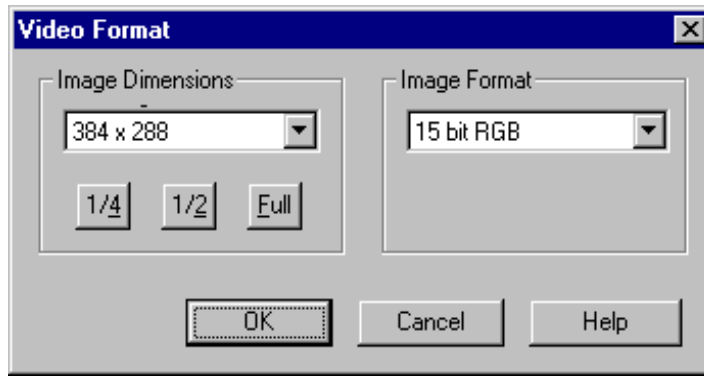

7. Please make the following settings:

- Adjust the image size under *Image Dimensions*. The options vary depending on the video standard. Please also refer to the table on page 39.
- Select the format for displaying and capturing under *Image Format*. For detailed information, refer to the table on page 39.

8. If you have a sound board installed in your computer and you also want to digitize the audio signal:

- Select *Options* and *Audio Format*. Make the desired settings.

9. In the *File* menu call *Set Capture File*.

- Create a file to which VidCon32 copies the incoming data. When creating a new file, the *Set File Size* window appears automatically.
- Specify a sufficient file size under *Set File Size*.

In this way, you make sure that a clip is saved to the hard disk in one piece (without being fragmented). This setting reserves a sufficiently large area on the hard disk.

10. Select *Capture / Video* to get the *CaptureSetup* dialogue box.

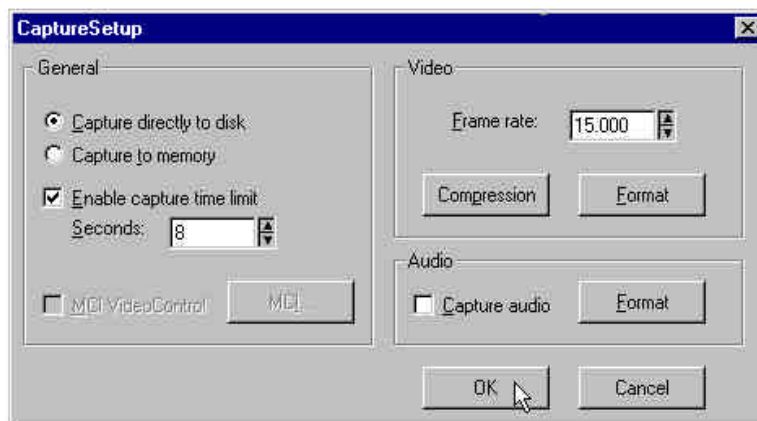

11. Please select the following settings:

- Select either *Directly to disk* or *Capture to memory*.



For large video clips the best results are achieved by selecting the *Directly to disk* option.

- If necessary, enable the *Enable Capture time limit* option and determine how long you want the digitizing process to take. After the predefined time VidCon32 stops capturing.
- Specify the frame rate:
For PAL and SECAM, select 25 fps. For NTSC, select 30 fps.
- If you want to compress captured video sequences, click *Compression*, select a suitable compression method and select the compression quality.
- If you have a sound board installed in your computer and you also want to digitize the audio signal, enable the *Capture Audio* option.
- The *Audio Format* button lets you specify the desired audio format and determine the name of the audio file.

12. Click *OK* to close the windows.

13. If you connected a VCR, start playing the video clip now.

14. Click the *Record* button to start capturing video.

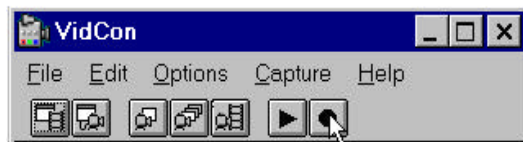

15. Press the right mouse button to finish capturing.

If you do not do so, the board stops capturing after the time limit you specified in the *Capture Video Sequence* dialog box.

16. In the *File* menu select the *Save captured Video as...* command.

17. Save the file under another name and, if necessary, in another directory.

RECORDING SINGLE FRAMES WITH VIDCON32

Proceed as follows to make single frames rather than a video sequence:

1. Switch on the video source.
2. Start *VidCon32* from the Windows *Start* menu.
3. Select the *Options* menu and the *Video Source* command.
4. Select the *Options* menu and the *Video Format* command.
Make the settings in the *Video Format* window as described on page 34.
5. If you connected the VCR, start the desired video clip now.
6. Select *Single Frame* from the *Capture* menu or click the *Record* button for capturing single-frames.
7. Select the *Save Single Frame* command from the *File* menu.
8. Specify the desired drive, directory, and file name, then click *OK*.



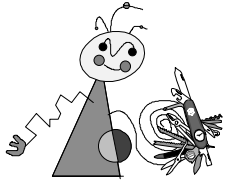

This chapter gives you important hints and tips & tricks for the miroVIDEO PCTV (pro) board.

HARDWARE REQUIREMENTS

The hardware requirements depend on how you want to use the miroVIDEO PCTV (pro) board.

- **Computer:**

If you only want to use the TV functionality of the miroVIDEO PCTV (pro) board, a less powerful computer is sufficient. If you want to use the full function range of the board and want to capture video clips, you need powerful hardware, that is a fast computer (Pentium) and a fast hard disk.

- **Hard disk:**

If the hard disk works too slow, the PC cannot save the digitized images fast enough and the drop-out rate increases. The drop-out rate is the number of images which are not saved during capturing. This results in jerky playback. Your hard disk should offer a transfer rate of 3 Mbytes/sec under Windows.

If your hard disk is too slow to save all images, either select a smaller image format or lower the frame rate to e.g. 15 fps.

- **Partitioning the hard disk:**

You can reserve a hard disk or a partition of the hard disk exclusively for digitizing video clips.

- **Defragmenting your hard disk:**

Usually, the hard disk is searched for free spaces. If a hard disk is in use for some time, the files are fragmented and saved in different segments of the disk. During the digitising process the hard disk tries to fill the free gaps. This increases the access time and the drop-out rate. In this way some images are missing and the video playback is jerky. After defragmentation the images are saved on a contiguous segment. For this purpose, Windows 95 offers the *Defrag* tool.

- **Memory:**

In general one can say that the more memory available, the better the capturing capabilities are.

- **Screensaver/TSR programs:**

Switch the screensaver and the TSR programs off. These can disturb the capturing process.

- **Requirements of the video source:**

If you can choose between the composite and the S-Video input, use the S-Video input for quality reasons.

INSTALLING miroVIDEO PCTV (PRO)

PCI revision as of 2.1

To enable busmastering with the miroVIDEO PCTV (pro) board, your motherboard must support the PCI bus revision as of 2.1. This is not the case for older 486 boards and some Pentium boards with the Intel P60/66.

Problems with graphics boards

Combining the miroVIDEO PCTV (pro) board with graphics boards containing an S3 Vision868 or 968 graphics processor may cause system crashes after starting the miroTELEVISION application. The processor of the graphics board causes a memory conflict, if the system allocated the miroVIDEO PCTV (pro) memory area directly behind the graphics board's memory area.

Although the memory areas do not seem to overlap, a conflict may occur because the S3 Vision 868 and the 968 processor need a larger memory area than the one entered in the Device Manager so that it may happen that the graphics driver accesses the memory area of the miroVIDEO PCTV (pro). To view the memory addresses, proceed as follows:

1. If you have not done so already, start Windows 95.
2. From the *Start* menu, select *Settings* and the *Control Panel*.
3. Select *System*, the *Device Manager* tab and the *Properties* button.
4. Select the *Memory* option.
5. Go to the end of the list.

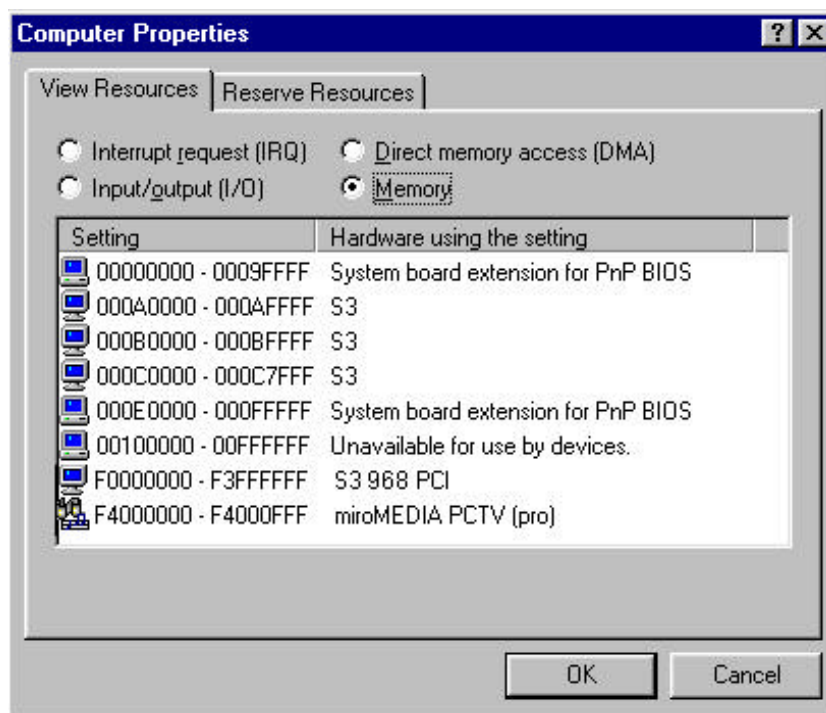

In this example the last address of the graphics board (F3FFFFFF) is located directly before the miroVIDEO PCTV start address (F4000000). Please make a note of the starting and the ending addresses of your graphics and your miroVIDEO PCTV board (starting address: left-hand side, ending address: right-hand side).

The following tells you how to change the miroVIDEO PCTV (pro) address range manually:

1. Click *OK* to go back to the Device Manager.

2. Select the *Audio, Video and Game Controller* icon.
3. Double-click *miroVIDEO PCTV (pro)* and select the *Resources* tab.
4. Disable *Use automatic settings*.
5. Mark the *Memory Range*.
6. Click *Change setting*.
7. Add 04000000 h to the memory range of your graphics board (example: F0000000 h + 04000000 h = F4000000 h)*.
8. Enter the value you calculated (e. g. F4000000 h) as *miroVIDEO PCTV* starting address.
9. Enter the starting address as ending address and replace the three zeros by FFF (e. g.: F4000FFF h).
8. Click *OK* and restart Windows.

SETTINGS IN VIDCON32

Video Source settings

Overlay

- ♦ *Force Preview:*
When you selected *Force Preview*, the video image will be displayed in the preview mode. In this mode, the video data will be transferred first to the main memory of the computer. From there the data is transmitted at fixed time intervals to the graphics board memory. The advantage of this mode is that it is compatible with any standard VGA board. The disadvantage is that the image quality may be limited depending on the number of colors. The video sequence will not be displayed in real-time, that means that only a few images per second are displayed.
- ♦ *Use Primary:*
The Primary mode is a kind of Overlay mode and is in some cases better than the Overlay mode. Here the *miroVIDEO PCTV* board takes on the scaling of the displayed image. For this purpose, the video data is transferred directly to the video memory of the graphics board. Which sizes are available depends on the video standard of the input signal.
The advantage of this setting is the optimal image quality of 16/32-bit resolution (16.7 million colors) while disturbing effects are avoided. With 8-bit resolution the color transitions are not smooth due to the limited number of colors.
- ♦ *Use Overlay:*
In the Overlay mode the graphics board scales the images. The video data is transferred into the the part of the graphics board's memory which is not used for displaying graphics data. The graphics board processor displays the video signal supplied by the *miroVIDEO PCTV*

* To calculate the addresses, use the Calculator from the Windows Accessories folder: In the *View* menu, select the *Scientific* mode. Then, select the Hex(adecimal) mode.

board. You can also change the image size by selecting a different video format.

If the graphics board is equipped with sufficient memory, the full-screen mode is possible. Independently of the number of colors you selected for your graphics board, the overlay appears in real colors.



The settings you make in the *Video Source* window under *Overlay* only influence the displayed overlay but not the captured video.

Video Format settings

Image Dimensions

The following table explains the relationship between the selected video standard and the available resolutions:

	NTSC	PAL/SECAM
<i>1/4</i>	160 x 120 pixels	192 x 142 pixels
<i>1/2</i>	320 x 240 pixels	384 x 284 pixels
<i>Full</i>	640 x 480 pixels	768 x 576 pixels
	360 x 240 pixels (CCIR601)	160 x 120 pixels
	240 x 180 pixels	240 x 180 pixels
		320 x 240 pixels
		360 x 288 pixels (CCIR601)
		640 x 480 pixels

Image Format

The following table explains the individual settings:

Setting	BPP (bit per pixel)	Explanation
Y8	8	This format uses only the brightness information, corresponds to 8 bits in grey scales.
YUV9	9	Suitable for capturing video clips which you want to compress later using an Indeo41-Codec. Advantage: During capturing a comparatively low amount of data is produced. (The brightness value is taken from each pixel, the color value is calculated from the mean color value of 9 pixels forming a square.)
BTYUV	12	Corresponds to the YUV411 format, supplies a higher quality than YUV9 but creates approximately 33% more data. (One color value is allocated to 4 pixels with in a line.)
YUV12	12	Suited for capturing video clips which you want to compress later using an MPEG format. This format provides an optimal image quality at relatively low data rates. (At this format one brightness and one color value is used for 4 pixels (arranged in a square).)
15 bit RGB	15	Windows standard graphics format. Suited for capturing video clips and single-frames which can be played back on any system without additional hardware and software. This format offers a good image quality but produces on the other hand a medium amount of data.
YUY2	16	Especially high-quality capturing format which nearly provides the quality of a TrueColor file (24 bit RGB), the resulting amount of data is relatively small. Is especially suited for capturing video clips in the CinePak format. (From 2 pixels 1 color value is taken.)
24 bit RGB	24	Windows standard graphics format. Recommended for capturing single-frames which you want to edit later.
32 bit RGBA	32	Corresponds to 24 bit RGB. Recommended for capturing single-frames which you want to edit later.

Capture format and data rate

The following table gives you an overview over the different capture formats and the data rates which are produced during capturing.

The data rates have been measured when capturing video files (AVI) without compression and sound.

For the 768 x 576 and the 640 x 480 resolutions you can only capturing is only possible in the Preview mode.

Capture format	Video standard	Resolution	Frames/sec.	Data rate (Mbytes/sec.)
15 bit RGB/YUY2 (16 Bit)	PAL/SECAM	192 x 142 384 x 284 768 x 576	25	1,3 5,5 22,1
	NTSC	160 x 120 320 x 240 640 x 480	30	1,1 4,5 18
15 bit RGB/YUY2 (16 Bit)	PAL/SECAM	192 x 142 384 x 284 768 x 576	15	0,8 3,2 12,8
	NTSC	160 x 120 320 x 240 640 x 480		0,6 2,3 9
BTYUV (12 Bit)	PAL/SECAM	192 x 142 384 x 284 768 x 576	25	1 4 16
	NTSC	160 x 120 320 x 240 640 x 480	30	0,8 3,4 13,5
BTYUV (12 Bit)	PAL/SECAM	192 x 142 384 x 284 768 x 576	15	0,6 2,4 9,6
	NTSC	160 x 120 320 x 240 640 x 480		0,4 1,7 6,8
YUV9 (9 Bit)	PAL/SECAM	192 x 142 384 x 284 768 x 576	25	- 3 no preview
	NTSC	160 x 120 320 x 240 640 x 480	30	0,5 2,1 15
YUV9 (9 Bit)	PAL/SECAM	192 x 142 384 x 284 768 x 576	15	- 1,8 no preview
	NTSC	160 x 120 320 x 240 640 x 480		0,3 1 7,5
24 bit RGB (24 Bit)	PAL/SECAM	192 x 142 384 x 284 768 x 576	25	2 8 32
	NTSC	160 x 120 320 x 240 640 x 480	30	1,7 6,8 27
24 bit RGB (24 Bit)	PAL/SECAM	192 x 142 384 x 284 768 x 576	15	1,2 7,5 19
	NTSC	160 x 120 320 x 240 640 x 480		0,8 3,4 13,5
32 bit RGB (32 Bit)	PAL/SECAM	192 x 142 384 x 284 768 x 576	25	2,7 10,7 42,6
	NTSC	160 x 120 320 x 240 640 x 480	30	2,3 9 36
32 bit RGB (32 Bit)	PAL/SECAM	192 x 142 384 x 284 768 x 576	15	1,6 6,4 25,6
	NTSC	160 x 120 320 x 240 640 x 480		1,1 4,5 18

Settings in the Capture Video Sequence window

Saving data on the hard disk/in the memory:

Usually, video is directly stored on the hard disk. This process takes up very much space on the hard disk, on the other hand no processor performance is used for converting and compressing data and it is possible to take full advantage of the hard disk's performance.

If it is not possible to capture a video clip with drop-out rates of under 20% although you tried out different settings, do not save the data directly on the hard disk but in the memory. To be able to do so the computer has to have at least 16 Mbytes of RAM. You will find a table with the amount of data on page 41.

VidCon and file name extensions:

If you create a capture file using the *File* menu and enter a new file name, we recommend to add the extensions (AVI for video clips, DIB or BMP for single-frames). VidCon32 does not add these automatically.

Determining the file size:

If you choose the VidCon32 *File* menu and select the *Set Capture File* dialog box, create the file in which you want VidCon32 to save the incoming data. If you create a new file, you will be automatically asked how much memory you want to reserve on the hard disk.

This size is not equal to the final file size of the AVI file. It only serves as buffer for uncompressed video.

Create a sufficiently large file. If you select a value which is too low for the file size, VidCon32 automatically sets the file size to the required value. If you select a file size which is too high, you might possibly waste disk space. You can solve this problem by saving the file again under another name.

VidCon32 can always access this disk space. Please check the file space time after time via the *Allocate file Space* item in the *File* menu.

You can avoid that the file size increases without being able to control it by

- ♦ creating a capture file via the *File* menu and the *Set Capture File* command,
- ♦ reserve a file size of 1 Mbyte,
- ♦ save the file under another file name, if necessary, in another directory,
- ♦ capture the next video clip in a capture file and save it again under another file name, and so on.

In this way, you make sure that VidCon32 always accesses the space on the hard disk you reserved.

Three examples for capturing video clips

To illustrate the relationship between the image size and the frame rate, we chose three typical examples:

Example 1 Capturing a video clip in full size (768 x 576)

When capturing images in the full image size, high amounts of data occur per single-frame. The number of images which can be recorded per second is low.

Depending on the color depth you selected, amounts of data of 500 KB up to 1.4 Mbytes occur per image (uncompressed). Therefore it is recommended to select a lower frame rate (1 to 3 frames per second).

Depending on the format 1.5 up to 4 Mbytes per second are created.



You should select an RGB color (15, 16, or 24 bit) or YUY2 format. In your capture program the preview mode must be selected.

Example 2 Recording a video clip with the full frame rate (25 or 30 frames per second)

Even at a compact video format such as YUV9 data rates of up to 3 Mbytes per second occur (uncompressed) (see also table on 41).



It is recommended to reduce the resolution:
under NTSC e. g. 320 x 240 (30 frames per second),
under PAL e. g. 384 x 288 (25 frames per second).

Using software compressors (Codecs) allows to reduce the amount of data to 400 Kbytes per second while the image quality remains the same. For this purpose, you need a powerful computer (at least a Pentium 133 computer).

Partly, the Codecs will be accelerated by the MMX* architecture.

The capture performance can be improved considerably under PAL at a reduced resolution (e. g. 320 x 240) because of the lower amount of data and because the Codecs can work more efficiently with this format.

Example 3 Capturing a sequence in the 240 x 180 format at 25 or 30 frames per second (very small videos)

For these videos, compressors are required which are used for video conferencing (e. g. H.263). With these compressors you can achieve 50 KB per seconds. Such compressors are supplied with video conferencing software. If required, you can also use another Codec, e. g. YUV9 with Indeo Video interactive Codec (then the data rates are higher).

* Intels Multimedia Extensions: Additional commands of the microprocessor accelerating multimedia applications.

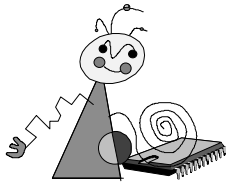

miroVIDEO PCTV

- Bus system** PCI
- Video decoder** Brooktree Bt848
- VideoDecoder** ITT VPX3220
- TV tuner** Depending on the delivery scope; corresponds to tuner standards:

Country specific versions		
D, A, CH, I	PAL B/G tuner	48.25 - 855.25 MHz
UK	PAL I tuner	45.75 - 855.25 MHz
F	SECAM tuner	45.75 - 855.25 MHz
US	NTSC tuner	48.25 - 855.25 MHz

- Video Inputs** S-Video input, Composite video input
- Output** Audio output
- Antenna input** 75 ohms IEC adapter (Europa), F connector (USA)
- Software**
 - ♦ miroTELEVISION/miroAV-Control (application for selecting channels; only for Europe)
 - ♦ miroTELETEXT (teletext application)
 - ♦ miroRADIO (radio application)
 - ♦ VidCon32

miroVIDEO PCTV pro upgrade

- Hardware**
 - ♦ Add-on board for miroVIDEO PCTV
 - ♦ Antenna connector with 75 ohms via IEC connector
 - ♦ Stereo audio decoder:

Country-specific versions	
EU	CCIR stereo audio decoder using dual carrier method
US	BTSC stereo audio decoder
GB	Stereo audio decoder for Nicam I and Nicam B/G

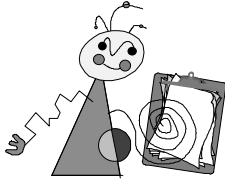

IDENTIFYING THE WINDOWS 95 VERSION

To identify the installed Windows 95 version, you have to start the MS-DOS Prompt.

1. In the *Start* menu, select the *Programs* command and the *MS-DOS Prompt*.

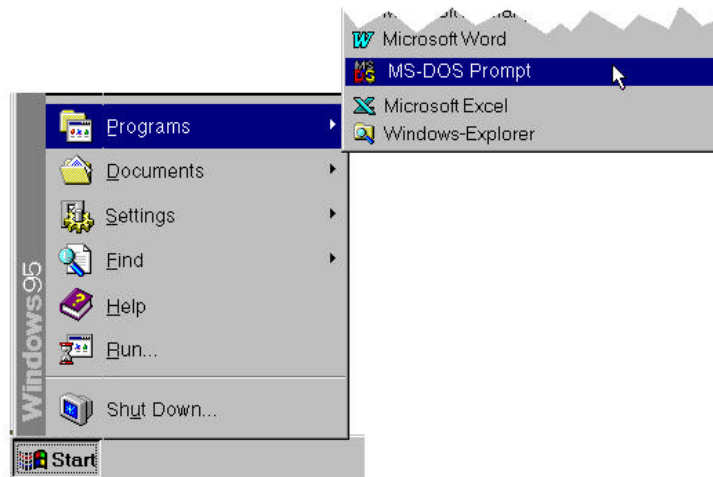

2. In the *MS-DOS Prompt* window type **ver**, and press <Enter>. The installed Windows 95 version will be displayed.

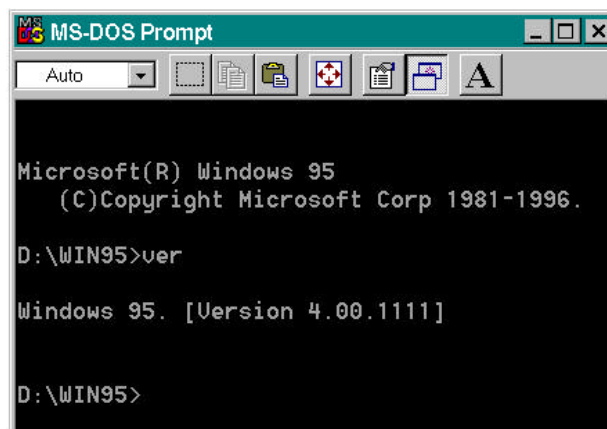

The Windows 95 OSR 2 (OEM-Service-Release 2) version has the version number Windows 95. [Version 4.00.1111]; the August Windows 95 Release has the version number Windows 95. [Version 4.00.950].

3. Close the *MS-DOS Prompt*.

INTERNAL CONNECTORS

Depending on the board type, the miroVIDEO PCTV base board includes up to 5 internal connectors (ST1, ST6, ST7, ST8, ST9) you can use to attach other boards with internal connectors (e.g. video capture boards).

ST1 is occupied by the miroVIDEO PCTV pro upgrade.

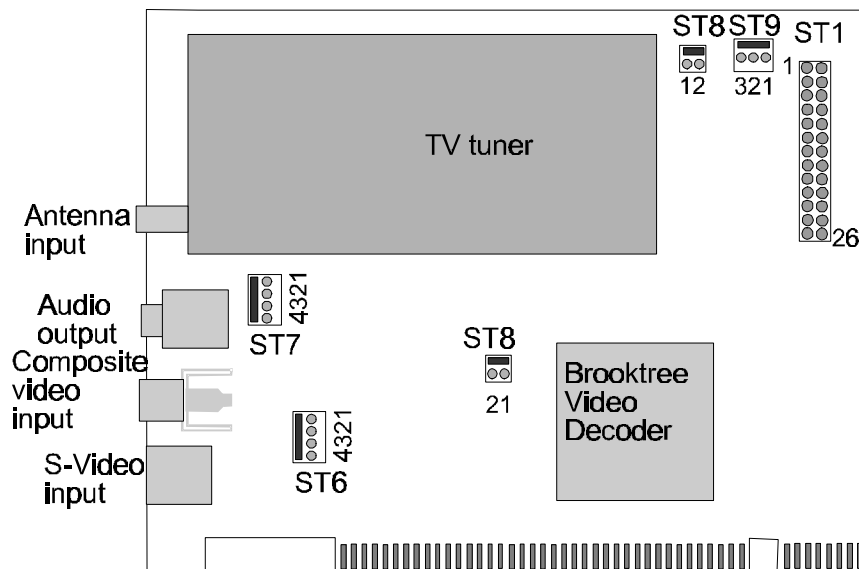

miroVIDEO PCTV: Internal connectors

ST1 = Combined audio/video expansion connector

ST6 = Internal Audio input

ST7 = Internal Audio output

ST8 = Internal TV output

ST9 = Internal I²C Port

The following table shows the corresponding pin assignments.

Designation	Pin Assignment	Significance
ST1	1 = +5V 2 = Audio Left Input 3 = +12V 4 = Audio Right Input 5 = GND 6 = SDA 7 = D9 8 = SCL 9 = D8 10 = D2 11 = D19 12 = D5 13 = D20 14 = D6 15 = D21/Reset 16 = D7 17 = GND 18 = D18 19 = -12V 20 = D17 21 = TV FBAS 22 = D16 23 = TV Audio 24 = D15 25 = TV Basisband 26 = D14	Combined audio/video expansion connector
ST6	1 = Left 2 = GND 3 = GND 4 = Right	Internal Audio input (separate Audio input for connecting additional analog audio signals (e.g. CD-ROM))
ST7	1 = Left 2 = GND 3 = GND 4 = Right	Internal Audio output
ST8	1 = FBAS 2 = GND	Internal TV output for the connection of a miroVIDEO DC10/ miroVIDEO DC30 board
ST9	1 = SDA 2 = GND 3 = SCL	Internal I ² C Port

SUPPORTED GRAPHICS BOARDS

A graphics board which has to run together with the miroVIDEO PCTV (pro), has to support DirectDraw and Video overlay under Windows 95. To ensure the best performance, the graphics board has to be equipped with 2 Mbytes of memory.

In the following graphics boards are listed which have been tested successfully with the miroVIDEO PCTV board:



















- ♦ boards with a S3 TRIO 64V+- or S3 ViRGE graphics processor, i. e.:
 - ♦ miroVIDEO View
 - ♦ miroVIDEO 3D
 - ♦ miroVIDEO 22SD
- ♦ VT and GT series by ATI (MACH64 graphics processor)
- ♦ boards with Cirrus Logic 5446 graphics processor
- ♦ boards with Tseng ET6000 graphics processor
- ♦ Matrox MGA Millenium and Mystique
- ♦ miroCRYSTAL VRX
- ♦ miroCRYSTAL VR 2000/4000
- ♦ miroCRYSTAL DVD.











If you have problems with graphics boards, read the “Problems with graphics boards” section under “Tips & Tricks” on page 37.

GLOSSARY



This glossary contains the most important concepts from the field of computer hardware, software and video. Cross-references are marked by this symbol .

- Address** All memory positions in a computer have numbers (addresses). Through these addresses each memory position can be addressed. Some addresses are reserved for certain  hardware components and must not be used. If two hardware components use the same address, there is an address conflict.
- ANSI** American National Standards Institute. ANSI character set ( Font): used by Microsoft Windows and Windows applications. The character assignment only differs slightly from the assignment of the  ASCII character set.
- ASCII** American Standards Committee of Information Interchange. ASCII character set ( Font): standard character set used by IBM and compatible computers. The ASCII character set consists of 256 characters, the first 128 of which are standardized.
- AUTOEXEC.BAT** A special DOS  batch file which is processed automatically after the computer has been started. The file contains among other things commands which load the country-specific keyboard driver ( Driver) or load programs automatically.
- AVI** Abbreviation for **A**udio **V**ideo **I**nterleaved, standard format for digital video ( Video for Windows).
- Batch file** A  DOS file where a sequence of commands is processed one after the other.
- BIOS** **B**asic **I**nput **O**utput **S**ystem. Number of basic input and output commands stored in a  ROM, PROM or EPROM. The  operating system uses these commands. The basic task of the BIOS is to control the data input and output. After starting the system the ROM BIOS performs some tests (checking the  interfaces, the disk drives, etc.).
- Bit** **B**inary **D**igit. Smallest information unit in a computer. One bit can take on two states: “0” and “1”, two bits can take on $2^2=4$ states and three bits $2^3=8$, etc. In a computer those states are realized by “0 V” (no current = 0) and “5 V” (current = 1). To display a character (letter, number etc.), 8 bits = 1  byte are required.
- Bus** In a computer, the bus provides for the communication between the  processor and the installed hardware (hard disk, graphics board, etc.). Depending on the bus width, the bus transfers a different amount of information. An 8-bit bus can transfer 8  bits (=  byte = one character) at a time.
- Byte** One byte consists of eight  bits. One byte represents exactly one character (letter, number etc.). The characters are binary-coded with “zero” (0) and “one” (1). The character “E” has the  ASCII code “01000101” or “45h” (hexadecimal).
- CD-I** A  CD-ROM standard designed for the field of entertainment which is independent of and not compatible with the conventional CD-ROM standard. Interactive components (e.g. for games) can only be played back with an original CD-I playback device.

CD-ROM	CD-ROMs are mass storage media for digital data, such as  digital video. CD-ROMs can only be read.
CGA	C olor G raphics A dapter (IBM). Graphics board which displays four colors in the graphics mode.
Clock frequency	Rate at which individual commands are processed in a processor. The higher the  clock frequency, the quicker the commands are processed.
CLUT	C olor L ook U p T able. Color table which contains all indexed color values.
CODEC	Acronym for C ompressor/ D ecompressor, compresses (packs) and decompresses (unpacks) image data.
Color depth	Number of  bits containing color information for each  pixel. A color depth of 1 bit displays only black and white ($2^1=2$ colors). At a color depth of 8 bits $2^8=256$ colors are available and at 24 bits $2^{24}=16,777,216$ ( TrueColor) colors are available.
Composite video	Composite video encodes all image information in one signal.
CONFIG.SYS	A  DOS configuration file which is processed automatically when the system starts. The CONFIG.SYS file includes  drivers which control the output to the monitor and the keyboard and the mouse.
Data rate	Data per second, e.g. amount of data which a mass storage medium (hard disk or CD-ROM) saves/plays back per second or the amount of data of a video sequence per second.
Digital video	Digital video stores information bit by bit in a file (in contrast to analog storage media).
Direct3D	A software interface developed by Microsoft for 3D games and other 3D applications under Windows 95. Enables Direct3D-capable applications to access 3D hardware efficiently.
DirectDraw	Software interface developed by Microsoft for Windows 95 which enables applications to access the graphics hardware.
DirectVideo	Successor of Video for Windows for Windows95. Has been expanded by Microsoft and will be designated by ActiveMovie in future.
DirectX	Direct (X) Extensions is a collection of several system extensions developed by Microsoft for Windows 95 (among others  DirectDraw,  Direct3D), to enable video and games acceleration.
DIP switch	D ual I ncline P ackage switch. A row of small switches designed to make certain hardware presettings.
Dithering	Method to avoid extreme color contrasts, which occur with a reduced number of colors.
DOS	D isk O perating S ystem. The most common  operating system for PCs (P ersonal C omputer). MS DOS is the M icrosoft version of DOS.
Driver	Programs which integrate the hardware (e.g. driver for a CD-ROM drive) in the computer and which adapt the software to the hardware (e.g. driver for a graphical user interface, such as Microsoft Windows). The software then uses the features of the graphics board.
EDO-DRAM	E (xtended) D (ata) O (ut)-DRAM is a new, significantly faster variant of DRAM.
EGA	E nhanced G raphics A dapter (IBM), graphics board which displays 16 colors in the graphics mode.

EISA bus	Extended Industry Standard Architecture. 32-bit bus: The EISA bus can transfer an amount of data of 33 Mbytes per second at a clock frequency of 8.33 Mhz.
Fixed-frequency monitor	Monitor operating at a very small frequency range (multifrequency monitor).
Font	Character set in a certain type, size and style, e.g. Times New Roman 11, normal; Times New Roman 11, italics; Times New Roman 11, bold; Times New Roman 11, bold, italics.
Frame Rate	Image rate measured in frames per second when capturing and recording video clips.
Graphics board	Graphics boards are the “link” between the computer and the monitor. Without a graphics board no image appears on the screen. Graphics boards operate in two modes: the text mode and the graphics mode. In the text mode only ASCII characters are displayed. The ASCII character set includes some simple “graphical” characters to display simple graphics. The graphics mode uses individual pixels. The more pixels available (the higher the resolution) the more detailed characters and graphics can be displayed.
Hardware	The hardware includes all computer components which are “hard”, such as the monitor, the hard disk, the keyboard, the mouse and the printer.
HGC	Hercules Graphics Card, monochrome (black and white) graphics board.
Horizontal scan rate	Number of horizontal scans of the electron beam per second required to create a new line. The higher the resolution the higher the required horizontal scan rate.
Intercast	The designation “Intercast” is composed of Internet and broadcast. With Intercast, internet pages are linked to TV programs. In the USA some big TV stations broadcast Internet pages for free.
Interface	Link between two parts of a system or between two systems where information, pulses and signals are adapted in a way that the receiving part can understand the sending part. For example, signals which the computer sends to the printer have to be adapted by an interface so that the printer “understands” what it has to print.
Interlaced	Image refreshing technique: the screen is subdivided into lines. When refreshing the image first all even lines and then all odd lines are refreshed.
ISA bus	International Standard Architecture. 16-bit bus which transfers 8 Mbytes of data per second at a clock frequency of 8 MHz.
Jumper	Jumpers can set up or interrupt electrical leads. To establish electrical leads with a jumper, the jumper has to be mounted, to interrupt the lead the jumper has to be removed.
KB	1 KB (Kilobyte) is equal to 1024 bytes. Here “K” (kilo) is always equal to “1024”.
Mbytes	1 Mbytes (Megabyte) equals 1024 KB.
MDA	Monochrome Display Adapter. Monochrome (black and white) graphics board.
MPEG	Abbreviation for Motion Pictures Experts Group. Standard for the compression of moving images.

Multifrequency monitor	A multifrequency monitor adapts itself automatically to different frequencies supplied by the graphics board (📖 fixed-frequency monitor) and can display different 📖 resolutions.
NICAM	NICAM is a digital transmission method for audio signals in the TV technology.
Non-interlaced	Image refresh method, where the complete image is generated without skipping lines. A non-interlaced image flickers much less than an 📖 interlaced image.
NTSC	Abbreviation for National Television System Committee . Color TV standard spread in the USA using 525 lines and 60 image fields per second.
Operating system	The operating system provides for the communication between 📖 hardware, 📖 software and the user. The tasks of the operating system are among others the file and the program management.
PAL	Abbreviation for Phase Alternation Line . Color TV standard developed in Germany using 625 lines and 50 image fields per seconds.
Parallel interface	The parallel or Centronics 📖 interface transfers data through an 8-bit data line. This means that 8 📖 bits (1 📖 byte) can be transferred at a time. The transfer through the parallel interface is considerably faster than the transfer through the 📖 serial interface, over long distances the parallel data transfer is, however, more susceptible to interference. Parallel interfaces are designated by LPT and a number (e.g. LPT1).
PCI Local Bus	Peripheral Component Interconnect . Local Bus concept by Intel: 32-bit bus, a PCI bus can transfer 132 Mbytes per second (max.) at a 📖 clock frequency of 33 MHz.
Pixel	Picture element. Pixels are the smallest elements of a monitor image (📖 resolution).
Pixel frequency	Rate at which the pixels appear on the screen.
Preview	The TV image appears on the monitor with the number of colors the graphics board supplies and possibly not in full size. See also 📖 TV overlay.
RAM	Random Access Memory . A RAM is a read-write memory component from which data can be read and to which data can be written any time. The computer memory is equipped with RAM components. The memory is a so-called “volatile” memory meaning that the memory contents are removed as soon as the computer is switched off.
Refresh rate	Also vertical scan rate. Number of image refreshes per second measured in Hertz (Hz). The higher the vertical scan rate the less flicker.
Resolution	Number of 📖 horizontal and vertical pixels. 1408 x 1024 means that 1408 pixels are displayed horizontally and 1024 pixels are displayed on the monitor vertically. The higher the resolution the more details the monitor can display.
RGB	Abbreviation for Red, Green and Blue , the basic colors of additive color mixing. RGB describes the method used in computer technology where image information is transferred by dividing it into the three basic colors.

ROM	Read Only Memory. A ROM is a memory component which can only be read but which cannot be modified. The ROM's contents remain in the component also after the computer has been switched off. All functions which have to be available immediately after switching the computer on, e.g. the data for the system test, the character output on the screen, etc. are stored in ROM components. There are also PROMs (P rogrammable R OM) EPROMs (E rasable P ROM) and EEPROMs (E lectric E PROM).
Scaling	Adaptation of an image to a different size.
SECAM	Abbreviation for S équentiel C ouleur à M émoire. Color television system developed on the basis of the 📖 NTSC system operating with 625 lines and 50 image halves per second.
Serial interface	Also RS232. The serial interface transfers data through a data line bit by bit (all 📖 bits of a 📖 byte one after the other). The serial data transfer is considerably slower than the transfer through the 📖 parallel interface but it is less susceptible to interference. Serial interfaces are designated by COM and a number (e.g. COM1).
Software	General term for all programs a computer can run (system programs, application programs, 📖 drivers etc.) and files.
S-VHS	Improved standard for home VCRs using S-Video signals to improve the color reproduction (📖 Y/C).
S-Video	With S-Video signals the brightness (luminance) and the color information (chrominance) are transferred separately.
TrueColor	16.7 million colors can be displayed at a time (📖 color depth).
TV Overlay	Inserting the TV image into the image supplied by the graphics board: The TV image is supplied via the PCI bus, inserted into the image supplied by the graphics board, and displayed in a window. The playback will be without jerks and will not depend on the number of colors supplied by the graphics board. The quality of the TV overlay is better than the 📖 Preview.
VESA	V ideo E lectronic S tandards A ssociation. Committee founded in 1988 in the USA which establishes common standards for the computer technology.
VESA Local Bus	Bus concept defined by the 📖 VESA committee: 32-bit bus operating at a 📖 clock frequency of up to 50 MHz. At a clock frequency of 33 MHz the VL bus transfers up to 132 📖 Mbytes per second (max.).
VGA	V ideo G raphics A rray (IBM), graphics board which displays 256 colors in the graphics mode.
VHS	Abbreviation for V ideo H ome S ystem. System commonly used for home VCRs to record and play back images and sound using 1/2" tape. VH systems use 📖 composite signals consisting of brightness and color information.
Video-8	Video system using a 8 mm tape. Video 8 recorders generate a 📖 composite signal.
Video decoder	Converts analog signals into digital information.
Video encoder	Converts digital information into analog signals.
Y/C	Y/C is a signal consisting of two components: Y = Brightness information, C = Color information.
YUV	Color model where Y delivers the brightness information and U and V the color information.

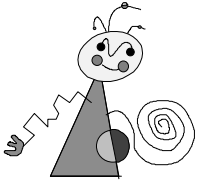

FCC Compliance Statement

FOR YOUR OWN SAFETY

NOTE: Shielded cables should be used for a composite interface. This is to ensure continued protection against radio frequency interference.

FCC WARNING STATEMENT

NOTE: This equipment has been tested and found to comply with the limits for a Class B digital device, pursuant to Part 15 of the FCC Rules. These limits are designed to provide reasonable protection against harmful interference in a residential installation. This equipment generates, uses and can radiate radio frequency energy and, if not installed and used in accordance with the instructions, may cause harmful interference to radio communications. However, there is no guarantee that interference will not occur in a particular installation. If this equipment does cause harmful interference to radio or television reception, which can be determined by turning the equipment off and on, the user is encouraged to try to correct the interference by one or more of the following measures:

- ♦ Reorient or relocate the receiving antenna.
- ♦ Increase the separation between the equipment and receiver.
- ♦ Connect the equipment into an outlet on a circuit different from that to which the receiver is connected.
- ♦ Consult the dealer or an experienced radio/TV technician for help.

CAUTION

Changes or modifications not expressly approved by the party responsible for compliance could void the user's authority to operate the equipment.

Shielded interface cable must be used in order to comply with the emission limits.

LABEL WARNING

This device complies with Part 15 of the FCC Rules. Operation is subject to the following two conditions: (1) this device may not cause harmful interference, and (2) this device must accept any interference received, including interference that may cause undesired operation.

Pinnacle Systems GmbH miroVIDEO PCTV



Tested To Comply
With FCC Standards

FOR HOME OR OFFICE USE

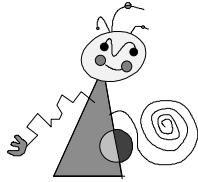

FCC Compliance Statement

FOR YOUR OWN SAFETY

NOTE: Shielded cables should be used for a composite interface. This is to ensure continued protection against radio frequency interference.

FCC WARNING STATEMENT

NOTE: This equipment has been tested and found to comply with the limits for a Class B digital device, pursuant to Part 15 of the FCC Rules. These limits are designed to provide reasonable protection against harmful interference in a residential installation. This equipment generates, uses and can radiate radio frequency energy and, if not installed and used in accordance with the instructions, may cause harmful interference to radio communications. However, there is no guarantee that interference will not occur in a particular installation. If this equipment does cause harmful interference to radio or television reception, which can be determined by turning the equipment off and on, the user is encouraged to try to correct the interference by one or more of the following measures:

- ♦ Reorient or relocate the receiving antenna.
- ♦ Increase the separation between the equipment and receiver.
- ♦ Connect the equipment into an outlet on a circuit different from that to which the receiver is connected.
- ♦ Consult the dealer or an experienced radio/TV technician for help.

CAUTION

Changes or modifications not expressly approved by the party responsible for compliance could void the user's authority to operate the equipment.

Shielded interface cable must be used in order to comply with the emission limits.

LABEL WARNING

This device complies with Part 15 of the FCC Rules. Operation is subject to the following two conditions: (1) this device may not cause harmful interference, and (2) this device must accept any interference received, including interference that may cause undesired operation.

Pinnacle Systems GmbH

miroVIDEO PCTV pro



Tested To Comply
With FCC Standards

FOR HOME OR OFFICE USE

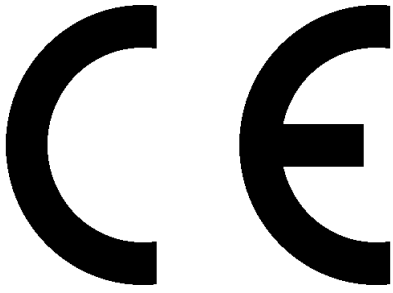

KONFORMITÄTSERKLÄRUNG
DECLARATION OF CONFORMITY

Geräteart: Multi Media Card
Type of equipment: Multi Media Card

Produkt / Product : **miroVIDEO PCTV**

Das bezeichnete Produkt stimmt mit den Vorschriften folgender EU- Richtlinie(n) überein:
The aforementioned product complies with the following European Council directive(s):

89/336/EWG Richtlinie des Rates zur Angleichung der Rechtsvorschriften der Mitgliedstaaten über die elektromagnetische Verträglichkeit
Council directive 89/336/EEC on the approximation of the laws of the Member States relating to electromagnetic compatibility

Zur vollständigen Einhaltung dieser Richtlinie(n) wurden folgende Normen herangezogen:
To fully comply with this (these) directive(s), the following standards have been used:

EN 55022 Class B : 1994 / A1:1995
EN 50082-1 : 1992 (IEC 801-2,-4 / ENV50140 / ENV 50141)

Dieser Erklärung liegt zugrunde: Prüfbericht(e) des EMV-Prüflabors
This certification is based on: Test report(s) generated by EMI test laboratory

Aussteller / Holder of certificate : **Pinnacle Systems GmbH**
Carl-Miele-Str. 4
D - 38112 Braunschweig

Braunschweig, October 08th, 1997

Oliver Hoheisel

Engineering Manager

Georg Blinn

Vorstand / Board of Management
(rechtverbindliche Unterschrift / legally binding)

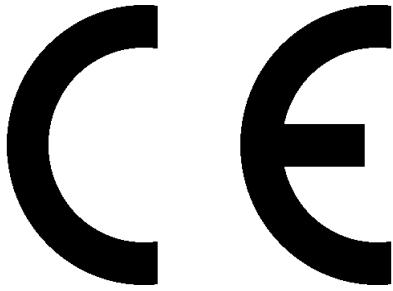

KONFORMITÄTSERKLÄRUNG DECLARATION OF CONFORMITY

Geräteart: Multi Media Card
Type of equipment: Multi Media Card

Produkt / Product : **miroVIDEO PCTVpro**

Das bezeichnete Produkt stimmt mit den Vorschriften folgender EU- Richtlinie(n) überein:
The aforementioned product complies with the following European Council directive(s):

89/336/EWG Richtlinie des Rates zur Angleichung der Rechtsvorschriften der Mitgliedstaaten über die elektromagnetische Verträglichkeit
Council directive 89/336/EEC on the approximation of the laws of the Member States relating to electromagnetic compatibility

Zur vollständigen Einhaltung dieser Richtlinie(n) wurden folgende Normen herangezogen:
To fully comply with this (these) directive(s), the following standards have been used:

EN 55022 Class B : 1994 / A1:1995
EN 50082-1 : 1992 (IEC801-2, -4, ENV500140, ENV500141)

Dieser Erklärung liegt zugrunde: Prüfbericht(e) des EMV-Prüflabors
This certification is based on: Test report(s) generated by EMI test laboratory

Aussteller / Holder of certificate : **Pinnacle Systems GmbH**
Carl-Miele-Str. 4
D - 38112 Braunschweig

Braunschweig, October 08th, 1997

Oliver Hoheisel

Engineering Manager

Georg Blinn

Vorstand / Board of Management
(rechtverbindliche Unterschrift / legally binding)

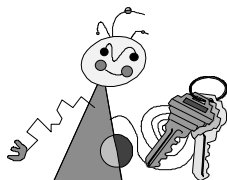

Index

C

Cables 5
Charge ii
Connecting
 miroMEDIA PCTV pro 7
Connecting the video/audio
 devices 15
Connectors 15

D

DirectDraw 3
DirectDraw support 3

F

Features
 miroMEDIA PCTV 1
 miroMEDIA PCTV pro 1

G

Glossary V

I

Inserting miroMEDIA PCTV
 (pro 8
Internal connectors II

M

miroAV-Control 22
miroRADIO 28
miroTELETEXT 2; 24
miroTELEVISION and
 Windows NT 17
MS-DOS Prompt I

N

NTSC 4

P

Package contents 5
PAL 4
Problems with graphics
 boards 37

R

README ii

S

SECAM 4
Settings in VidCon32 38
Single frames 35
Software installation
 Windows 95 10
Software installation
 Windows NT 13
Subheadings ii
Supported graphics boards IV
System requirements 3

T

Technical Data
 miroMEDIA PCTV 44
 miroMEDIA PCTV pro 44

V

VidCon32 32

W

Windows 95
 August 95-Release 10; 11
Windows NT 2; 13
Winows 95 I

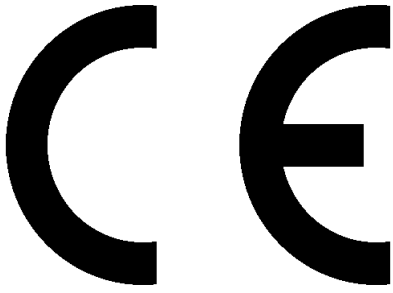

KONFORMITÄTSERKLÄRUNG
DECLARATION OF CONFORMITY

Geräteart: Multi Media Card
Type of equipment: Multi Media Card

Produkt / Product : **miroVIDEO PCTVpro**

Das bezeichnete Produkt stimmt mit den Vorschriften folgender EU- Richtlinie(n) überein:
The aforementioned product complies with the following European Council directive(s):

89/336/EWG Richtlinie des Rates zur Angleichung der Rechtsvorschriften der Mitgliedstaaten über die
elektromagnetische Verträglichkeit
Council directive 89/336/EEC on the approximation of the laws of the Member States
relating to electromagnetic compatibility

Zur vollständigen Einhaltung dieser Richtlinie(n) wurden folgende Normen herangezogen:
To fully comply with this (these) directive(s), the following standards have been used:

EN 55022 Class B : 1994 / A1:1995
EN 50082-1 : 1992 (IEC801-2, -4, ENV500140, ENV500141)

Dieser Erklärung liegt zugrunde: Prüfbericht(e) des EMV-Prüflabors
This certification is based on: Test report(s) generated by EMI test laboratory

Aussteller / Holder of certificate : **Pinnacle Systems GmbH**
Carl-Miele-Str. 4
D - 38112 Braunschweig

Braunschweig, October 08th, 1997

Oliver Hoheisel

Engineering Manager

Georg Blinn

Vorstand / Board of Management
(rechtverbindliche Unterschrift / legally binding)

Notes

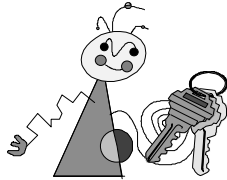

Index

C

- Cables 5
- Charge ii
- Connecting
 - miroMEDIA PCTV pro 7
- Connecting the video/audio devices 15
- Connectors 15

D

- DirectDraw 3
- DirectDraw support 3

F

- Features
 - miroMEDIA PCTV 1
 - miroMEDIA PCTV pro 1

G

- Glossary V

I

- Inserting miroMEDIA PCTV (pro) 8
- Internal connectors II

M

- miroAV-Control 22
- miroRADIO 28
- miroTELETEXT 2; 24
- miroTELEVISION and Windows NT 17
- MS-DOS Prompt I

N

- NTSC 4

P

- Package contents 5
- PAL 4
- Problems with graphics boards 37

R

- README ii

S

- SECAM 4
- Settings in VidCon32 38
- Single frames 35
- Software installation
 - Windows 95 10
- Software installation
 - Windows NT 13
- Subheadings ii
- Supported graphics boards IV
- System requirements 3

T

- Technical Data
 - miroMEDIA PCTV 44
 - miroMEDIA PCTV pro 44

V

- VidCon32 32

W

- Windows 95
 - August 95-Release 10; 11
- Windows NT 2; 13
- Windows 95 I