

Intel[®] I/O Controller Hub 10 (ICH10) Family

Datasheet

October 2008



INFORMATION IN THIS DOCUMENT IS PROVIDED IN CONNECTION WITH INTEL® PRODUCTS. NO LICENSE, EXPRESS OR IMPLIED, BY ESTOPPEL OR OTHERWISE, TO ANY INTELLECTUAL PROPERTY RIGHTS IS GRANTED BY THIS DOCUMENT. EXCEPT AS PROVIDED IN INTEL'S TERMS AND CONDITIONS OF SALE FOR SUCH PRODUCTS, INTEL ASSUMES NO LIABILITY WHATSOEVER, AND INTEL DISCLAIMS ANY EXPRESS OR IMPLIED WARRANTY, RELATING TO SALE AND/OR USE OF INTEL PRODUCTS INCLUDING LIABILITY OR WARRANTIES RELATING TO FITNESS FOR A PARTICULAR PURPOSE, MERCHANTABILITY, OR INFRINGEMENT OF ANY PATENT, COPYRIGHT OR OTHER INTELLECTUAL PROPERTY RIGHT.

UNLESS OTHERWISE AGREED IN WRITING BY INTEL, THE INTEL PRODUCTS ARE NOT DESIGNED NOR INTENDED FOR ANY APPLICATION IN WHICH THE FAILURE OF THE INTEL PRODUCT COULD CREATE A SITUATION WHERE PERSONAL INJURY OR DEATH MAY OCCUR.

Intel may make changes to specifications and product descriptions at any time, without notice. Designers must not rely on the absence or characteristics of any features or instructions marked "reserved" or "undefined." Intel reserves these for future definition and shall have no responsibility whatsoever for conflicts or incompatibilities arising from future changes to them. The information here is subject to change without notice. Do not finalize a design with this information.

The Intel® I/O Controller Hub 10 (ICH10) Family chipset component may contain design defects or errors known as errata which may cause the product to deviate from published specifications. Current characterized errata are available on request.

Contact your local Intel sales office or your distributor to obtain the latest specifications and before placing your product order.

I²C is a two-wire communications bus/protocol developed by Philips. SMBus is a subset of the I²C bus/protocol and was developed by Intel. Implementations of the I²C bus/protocol may require licenses from various entities, including Philips Electronics N.V. and North American Philips Corporation.

Intel® Active Management Technology requires the computer system to have an Intel® AMT-enabled chipset, network hardware and software, as well as connection with a power source and a corporate network connection. Setup requires configuration by the purchaser and may require scripting with the management console or further integration into existing security frameworks to enable certain functionality. It may also require modifications of implementation of new business processes. With regard to notebooks, Intel AMT may not be available or certain capabilities may be limited over a host OS-based VPN or when connecting wirelessly, on battery power, sleeping, hibernating or powered off. For more information, see www.intel.com/technology/platform-technology/intel-amt/

Intel® Virtualization Technology requires a computer system with an enabled Intel® processor, BIOS, virtual machine monitor (VMM) and, for some uses, certain computer system software enabled for it. Functionality, performance or other benefits will vary depending on hardware and software configurations and may require a BIOS update. Software applications may not be compatible with all operating systems. Please check with your application vendor.

No computer system can provide absolute security under all conditions. Intel® Trusted Execution Technology (Intel® TXT) requires a computer system with Intel® Virtualization Technology, an Intel TXT-enabled processor, chipset, BIOS, Authenticated Code Modules and an Intel TXT-compatible measured launched environment (MLE). The MLE could consist of a virtual machine monitor, an OS or an application. In addition, Intel TXT requires the system to contain a TPM v1.2, as defined by the Trusted Computing Group and specific software for some uses. For more information, see <http://www.intel.com/technology/security>

Home networking capability and many Intel® Viiv™ technology-based usage models will require additional hardware devices, software or services. Functionality of Intel® Viiv™ technology verified devices will vary; check product details for desired features. System and component performance and functionality will vary depending on your specific hardware and software configurations. See www.intel.com/go/viiv_info for more information.

Intel® High Definition Audio requires a system with an appropriate Intel chipset and a motherboard with an appropriate codec and the necessary drivers installed. System sound quality will vary depending on actual implementation, controller, codec, drivers and speakers. For more information about Intel® HD audio, refer to <http://www.intel.com/>

Intel, Intel logo, Intel SpeedStep, Intel Viiv, and Intel vPro are trademarks of Intel Corporation in the U.S. and other countries.

*Other names and brands may be claimed as the property of others.

Copyright © 2008, Intel Corporation

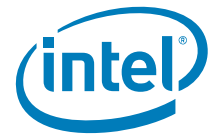

Contents

| | | |
|----------|------------------------------------------------------|-----------|
| 1 | Introduction | 33 |
| 1.1 | About This Manual | 33 |
| 1.2 | Overview | 37 |
| 1.2.1 | Capability Overview | 39 |
| 1.3 | Intel® ICH10 Family High-Level Component Differences | 44 |
| 2 | Signal Description | 45 |
| 2.1 | Direct Media Interface (DMI) to Host Controller | 47 |
| 2.2 | PCI Express* Interface | 48 |
| 2.3 | LAN Connect Interface | 48 |
| 2.4 | Gigabit LAN Connect Interface | 49 |
| 2.5 | Firmware Hub Interface | 50 |
| 2.6 | PCI Interface | 50 |
| 2.7 | Serial ATA Interface | 52 |
| 2.8 | LPC Interface | 55 |
| 2.9 | Interrupt Interface | 55 |
| 2.10 | USB Interface | 56 |
| 2.11 | Power Management Interface | 58 |
| 2.12 | Processor Interface | 61 |
| 2.13 | SMBus Interface | 62 |
| 2.14 | System Management Interface | 63 |
| 2.15 | Real Time Clock Interface | 64 |
| 2.16 | Other Clocks | 65 |
| 2.17 | Miscellaneous Signals | 65 |
| 2.18 | Intel® High Definition Audio Link | 66 |
| 2.19 | Serial Peripheral Interface (SPI) | 67 |
| 2.20 | Controller Link | 68 |
| 2.21 | Intel® Quiet System Technology | 68 |
| 2.22 | JTAG Signals (Intel® ICH10 Corporate Family Only) | 69 |
| 2.23 | General Purpose I/O Signals | 70 |
| 2.24 | Power and Ground Signals | 73 |
| 2.25 | Pin Straps | 75 |
| 2.25.1 | Functional Straps | 75 |
| 2.25.2 | External RTC Circuitry | 79 |
| 3 | Intel® ICH10 Pin States | 81 |
| 3.1 | Integrated Pull-Ups and Pull-Downs | 81 |
| 3.2 | Output and I/O Signals Planes and States | 83 |
| 3.3 | Power Planes for Input Signals | 88 |
| 4 | Intel® ICH10 and System Clock Domains | 91 |
| 5 | Functional Description | 93 |
| 5.1 | DMI-to-PCI Bridge (D30:F0) | 93 |
| 5.1.1 | PCI Bus Interface | 93 |
| 5.1.2 | PCI Bridge As an Initiator | 93 |
| 5.1.3 | Parity Error Detection and Generation | 95 |
| 5.1.4 | PCIRST# | 96 |
| 5.1.5 | Peer Cycles | 96 |
| 5.1.6 | PCI-to-PCI Bridge Model | 96 |
| 5.1.7 | IDSEL to Device Number Mapping | 97 |
| 5.1.8 | Standard PCI Bus Configuration Mechanism | 97 |
| 5.2 | PCI Express* Root Ports (D28:F0,F1,F2,F3,F4,F5) | 97 |
| 5.2.1 | Interrupt Generation | 97 |
| 5.2.2 | Power Management | 98 |
| 5.2.3 | SERR# Generation | 99 |
| 5.2.4 | Hot-Plug | 100 |
| 5.3 | Gigabit Ethernet Controller (B0:D25:F0) | 101 |
| 5.3.1 | Gigabit Ethernet PCI Bus Interface | 102 |
| 5.3.2 | Error Events and Error Reporting | 103 |
| 5.3.3 | Ethernet Interface | 103 |
| 5.3.4 | PCI Power Management | 104 |
| 5.3.5 | Configurable LEDs | 105 |



| | | |
|---------|------------------------------------------------------------|-----|
| 5.3.6 | Function Level Reset Support (FLR) | 106 |
| 5.4 | LPC Bridge (w/ System and Management Functions) (D31:F0) | 107 |
| 5.4.1 | LPC Interface | 107 |
| 5.5 | DMA Operation (D31:F0) | 112 |
| 5.5.1 | Channel Priority | 113 |
| 5.5.2 | Address Compatibility Mode | 113 |
| 5.5.3 | Summary of DMA Transfer Sizes | 114 |
| 5.5.4 | Autoinitialize | 114 |
| 5.5.5 | Software Commands | 115 |
| 5.6 | LPC DMA | 115 |
| 5.6.1 | Asserting DMA Requests | 115 |
| 5.6.2 | Abandoning DMA Requests | 116 |
| 5.6.3 | General Flow of DMA Transfers | 116 |
| 5.6.4 | Terminal Count | 116 |
| 5.6.5 | Verify Mode | 117 |
| 5.6.6 | DMA Request Deassertion | 117 |
| 5.6.7 | SYNC Field / LDRQ# Rules | 118 |
| 5.7 | 8254 Timers (D31:F0) | 118 |
| 5.7.1 | Timer Programming | 119 |
| 5.7.2 | Reading from the Interval Timer | 120 |
| 5.8 | 8259 Interrupt Controllers (PIC) (D31:F0) | 121 |
| 5.8.1 | Interrupt Handling | 122 |
| 5.8.2 | Initialization Command Words (ICWx) | 123 |
| 5.8.3 | Operation Command Words (OCW) | 124 |
| 5.8.4 | Modes of Operation | 124 |
| 5.8.5 | Masking Interrupts | 127 |
| 5.8.6 | Steering PCI Interrupts | 127 |
| 5.9 | Advanced Programmable Interrupt Controller (APIC) (D31:F0) | 128 |
| 5.9.1 | Interrupt Handling | 128 |
| 5.9.2 | Interrupt Mapping | 128 |
| 5.9.3 | PCI / PCI Express* Message-Based Interrupts | 129 |
| 5.9.4 | Front Side Bus Interrupt Delivery | 129 |
| 5.9.5 | IOxAPIC Address Remapping | 131 |
| 5.9.6 | External Interrupt Controller Support | 131 |
| 5.10 | Serial Interrupt (D31:F0) | 132 |
| 5.10.1 | Start Frame | 132 |
| 5.10.2 | Data Frames | 133 |
| 5.10.3 | Stop Frame | 133 |
| 5.10.4 | Specific Interrupts Not Supported via SERIRQ | 133 |
| 5.10.5 | Data Frame Format | 134 |
| 5.11 | Real Time Clock (D31:F0) | 135 |
| 5.11.1 | Update Cycles | 135 |
| 5.11.2 | Interrupts | 136 |
| 5.11.3 | Lockable RAM Ranges | 136 |
| 5.11.4 | Century Rollover | 136 |
| 5.11.5 | Clearing Battery-Backed RTC RAM | 136 |
| 5.12 | Processor Interface (D31:F0) | 138 |
| 5.12.1 | Processor Interface Signals | 138 |
| 5.12.2 | Dual-Processor Issues | 141 |
| 5.13 | Power Management (D31:F0) | 142 |
| 5.13.1 | Features | 142 |
| 5.13.2 | Intel® ICH10 and System Power States | 142 |
| 5.13.3 | System Power Planes | 145 |
| 5.13.4 | SMI#/SCI Generation | 145 |
| 5.13.5 | Dynamic Processor Clock Control | 148 |
| 5.13.6 | Sleep States | 151 |
| 5.13.7 | Thermal Management | 154 |
| 5.13.8 | Event Input Signals and Their Usage | 155 |
| 5.13.9 | ALT Access Mode | 158 |
| 5.13.10 | System Power Supplies, Planes, and Signals | 162 |
| 5.13.11 | Clock Generators | 164 |
| 5.13.12 | Legacy Power Management Theory of Operation | 165 |
| 5.13.13 | Reset Behavior | 165 |
| 5.14 | System Management (D31:F0) | 167 |
| 5.14.1 | Theory of Operation | 167 |
| 5.14.2 | TCO Modes | 169 |
| 5.15 | General Purpose I/O (D31:F0) | 173 |

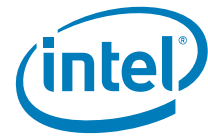

| | | |
|---------|----------------------------------------------------------------------|-----|
| 5.15.1 | Power Wells | 173 |
| 5.15.2 | SMI# and SCI Routing | 173 |
| 5.15.3 | Triggering | 173 |
| 5.15.4 | GPIO Registers Lockdown | 173 |
| 5.15.5 | Serial POST Codes Over GPIO | 174 |
| 5.15.6 | Intel Management Engine GPIOs | 176 |
| 5.16 | SATA Host Controller (D31:F2, F5) | 176 |
| 5.16.1 | SATA Feature Support | 177 |
| 5.16.2 | Theory of Operation | 178 |
| 5.16.3 | SATA Swap Bay Support | 178 |
| 5.16.4 | Hot Plug Operation | 178 |
| 5.16.5 | Function Level Reset Support (FLR) | 179 |
| 5.16.6 | Intel® Matrix Storage Technology Configuration | 180 |
| 5.16.7 | Power Management Operation | 181 |
| 5.16.8 | SATA Device Presence | 183 |
| 5.16.9 | SATA LED | 184 |
| 5.16.10 | AHCI Operation | 184 |
| 5.16.11 | Serial ATA Reference Clock Low Power Request (SATACLKREQ#) | 184 |
| 5.16.12 | SGPIO Signals | 185 |
| 5.16.13 | External SATA | 189 |
| 5.17 | High Precision Event Timers | 189 |
| 5.17.1 | Timer Accuracy | 189 |
| 5.17.2 | Interrupt Mapping | 190 |
| 5.17.3 | Periodic vs. Non-Periodic Modes | 190 |
| 5.17.4 | Enabling the Timers | 191 |
| 5.17.5 | Interrupt Levels | 191 |
| 5.17.6 | Handling Interrupts | 192 |
| 5.17.7 | Issues Related to 64-Bit Timers with 32-Bit Processors | 192 |
| 5.18 | USB UHCI Host Controllers (D29:F0, F1, F2, F3 and D26:F0, F1 and F2) | 192 |
| 5.18.1 | Data Structures in Main Memory | 193 |
| 5.18.2 | Data Transfers to/from Main Memory | 193 |
| 5.18.3 | Data Encoding and Bit Stuffing | 193 |
| 5.18.4 | Bus Protocol | 193 |
| 5.18.5 | Packet Formats | 194 |
| 5.18.6 | USB Interrupts | 194 |
| 5.18.7 | USB Power Management | 197 |
| 5.18.8 | USB Legacy Keyboard Operation | 197 |
| 5.18.9 | Function Level Reset Support (FLR) | 200 |
| 5.19 | USB EHCI Host Controllers (D29:F7 and D26:F7) | 201 |
| 5.19.1 | EHC Initialization | 201 |
| 5.19.2 | Data Structures in Main Memory | 202 |
| 5.19.3 | USB 2.0 Enhanced Host Controller DMA | 202 |
| 5.19.4 | Data Encoding and Bit Stuffing | 202 |
| 5.19.5 | Packet Formats | 203 |
| 5.19.6 | USB 2.0 Interrupts and Error Conditions | 203 |
| 5.19.7 | USB 2.0 Power Management | 204 |
| 5.19.8 | Interaction with UHCI Host Controllers | 205 |
| 5.19.9 | USB 2.0 Legacy Keyboard Operation | 208 |
| 5.19.10 | USB 2.0 Based Debug Port | 209 |
| 5.19.11 | USB Pre-Fetch Based Pause | 213 |
| 5.19.12 | Function Level Reset Support (FLR) | 214 |
| 5.20 | SMBus Controller (D31:F3) | 214 |
| 5.20.1 | Host Controller | 215 |
| 5.20.2 | Bus Arbitration | 219 |
| 5.20.3 | Bus Timing | 220 |
| 5.20.4 | Interrupts / SMI# | 221 |
| 5.20.5 | SMBALERT# | 222 |
| 5.20.6 | SMBus CRC Generation and Checking | 222 |
| 5.20.7 | SMBus Slave Interface | 222 |
| 5.21 | Intel® High Definition Audio Overview | 228 |
| 5.22 | Intel® Active Management Technology (Intel® AMT) (Corporate Only) | 228 |
| 5.22.1 | Intel® AMT Features | 229 |
| 5.22.2 | Intel® AMT Requirements | 229 |
| 5.23 | Serial Peripheral Interface (SPI) | 229 |
| 5.23.1 | SPI Supported Feature Overview | 230 |
| 5.23.2 | Flash Descriptor | 232 |
| 5.23.3 | Flash Access | 234 |

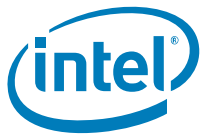

| | | |
|-----------|---------------------------------------------------------|------------|
| 5.23.4 | Serial Flash Device Compatibility Requirements | 235 |
| 5.23.5 | Multiple Page Write Usage Model | 237 |
| 5.23.6 | Flash Device Configurations | 238 |
| 5.23.7 | SPI Flash Device Recommended Pinout | 238 |
| 5.23.8 | Serial Flash Device Package | 239 |
| 5.24 | Intel® Quiet System Technology (Intel® QST) | 240 |
| 5.24.1 | PWM Outputs | 240 |
| 5.24.2 | TACH Inputs | 240 |
| 5.25 | Thermal Sensors | 240 |
| 5.26 | Feature Capability Mechanism | 241 |
| 5.27 | Integrated Trusted Platform Module (Corporate Only) | 241 |
| 5.27.1 | Integrated TPM Hardware Requirements | 241 |
| 5.27.2 | Enabling integrated TPM | 242 |
| 6 | Ballout Definition | 243 |
| 6.1 | Intel® ICH10 Ballout | 243 |
| 7 | Package Information | 253 |
| 7.1 | Intel® ICH10 Package | 253 |
| 8 | Electrical Characteristics | 255 |
| 8.1 | Thermal Specifications | 255 |
| 8.2 | Absolute Maximum Ratings | 255 |
| 8.3 | DC Characteristics | 255 |
| 8.4 | AC Characteristics | 268 |
| 8.5 | Timing Diagrams | 280 |
| 9 | Register and Memory Mapping | 293 |
| 9.1 | PCI Devices and Functions | 294 |
| 9.2 | PCI Configuration Map | 295 |
| 9.3 | I/O Map | 295 |
| 9.3.1 | Fixed I/O Address Ranges | 295 |
| 9.3.2 | Variable I/O Decode Ranges | 298 |
| 9.4 | Memory Map | 299 |
| 9.4.1 | Boot-Block Update Scheme | 300 |
| 10 | Chipset Configuration Registers | 303 |
| 10.1 | Chipset Configuration Registers (Memory Space) | 303 |
| 10.1.1 | VCH—Virtual Channel Capability Header Register | 306 |
| 10.1.2 | VCAP1—Virtual Channel Capability #1 Register | 306 |
| 10.1.3 | VCAP2—Virtual Channel Capability #2 Register | 307 |
| 10.1.4 | PVC—Port Virtual Channel Control Register | 307 |
| 10.1.5 | PVS—Port Virtual Channel Status Register | 307 |
| 10.1.6 | VOCAP—Virtual Channel 0 Resource Capability Register | 308 |
| 10.1.7 | VOCTL—Virtual Channel 0 Resource Control Register | 308 |
| 10.1.8 | VOSTS—Virtual Channel 0 Resource Status Register | 309 |
| 10.1.9 | V1CAP—Virtual Channel 1 Resource Capability Register | 309 |
| 10.1.10 | V1CTL—Virtual Channel 1 Resource Control Register | 310 |
| 10.1.11 | V1STS—Virtual Channel 1 Resource Status Register | 310 |
| 10.1.12 | PAT—Port Arbitration Table (Consumer Only) | 311 |
| 10.1.13 | CIR1—Chipset Initialization Register 1 | 311 |
| 10.1.14 | REC—Root Error Command Register | 311 |
| 10.1.15 | RCTCL—Root Complex Topology Capabilities List Register | 312 |
| 10.1.16 | ESD—Element Self Description Register | 312 |
| 10.1.17 | ULD—Upstream Link Descriptor Register | 312 |
| 10.1.18 | ULBA—Upstream Link Base Address Register | 313 |
| 10.1.19 | RP1D—Root Port 1 Descriptor Register | 313 |
| 10.1.20 | RP1BA—Root Port 1 Base Address Register | 313 |
| 10.1.21 | RP2D—Root Port 2 Descriptor Register | 314 |
| 10.1.22 | RP2BA—Root Port 2 Base Address Register | 314 |
| 10.1.23 | RP3D—Root Port 3 Descriptor Register | 314 |
| 10.1.24 | RP3BA—Root Port 3 Base Address Register | 315 |
| 10.1.25 | RP4D—Root Port 4 Descriptor Register | 315 |
| 10.1.26 | RP4BA—Root Port 4 Base Address Register | 315 |
| 10.1.27 | HDD—Intel® High Definition Audio Descriptor Register | 316 |
| 10.1.28 | HDBA—Intel® High Definition Audio Base Address Register | 316 |
| 10.1.29 | RP5D—Root Port 5 Descriptor Register | 316 |
| 10.1.30 | RP5BA—Root Port 5 Base Address Register | 317 |

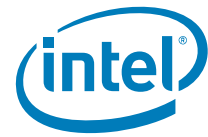

| | | |
|-----------|---------------------------------------------------------------------|------------|
| 10.1.31 | RP6D—Root Port 6 Descriptor Register | 317 |
| 10.1.32 | RP6BA—Root Port 6 Base Address Register | 317 |
| 10.1.33 | ILCL—Internal Link Capabilities List Register | 318 |
| 10.1.34 | LCAP—Link Capabilities Register | 318 |
| 10.1.35 | LCTL—Link Control Register | 318 |
| 10.1.36 | LSTS—Link Status Register | 319 |
| 10.1.37 | CIR2 — Chipset Initialization Register 2 | 319 |
| 10.1.38 | CIR3 — Chipset Initialization Register 3 | 319 |
| 10.1.39 | BCR — Backbone Configuration Register | 319 |
| 10.1.40 | RPC—Root Port Configuration Register | 320 |
| 10.1.41 | DMIC—DMI Control Register | 321 |
| 10.1.42 | RPFN—Root Port Function Number and Hide for PCI Express* Root Ports | 321 |
| 10.1.43 | FLRSTAT—FLR Pending Status Register | 323 |
| 10.1.44 | CIR13—Chipset Initialization Register 13 | 324 |
| 10.1.45 | CIR5—Chipset Initialization Register 5 | 324 |
| 10.1.46 | TRSR—Trap Status Register | 324 |
| 10.1.47 | TRCR—Trapped Cycle Register | 325 |
| 10.1.48 | TWDR—Trapped Write Data Register | 325 |
| 10.1.49 | IOTRn — I/O Trap Register (0-3) | 326 |
| 10.1.50 | DMC—DMI Miscellaneous Control Register | 327 |
| 10.1.51 | CIR6—Chipset Initialization Register 6 | 327 |
| 10.1.52 | CIR7—Chipset Initialization Register 7 | 327 |
| 10.1.53 | TCTL—TCO Configuration Register | 328 |
| 10.1.54 | D31IP—Device 31 Interrupt Pin Register | 329 |
| 10.1.55 | D30IP—Device 30 Interrupt Pin Register | 330 |
| 10.1.56 | D29IP—Device 29 Interrupt Pin Register | 330 |
| 10.1.57 | D28IP—Device 28 Interrupt Pin Register | 331 |
| 10.1.58 | D27IP—Device 27 Interrupt Pin Register | 332 |
| 10.1.59 | D26IP—Device 26 Interrupt Pin Register | 333 |
| 10.1.60 | D25IP—Device 25 Interrupt Pin Register | 334 |
| 10.1.61 | D31IR—Device 31 Interrupt Route Register | 334 |
| 10.1.62 | D30IR—Device 30 Interrupt Route Register | 335 |
| 10.1.63 | D29IR—Device 29 Interrupt Route Register | 336 |
| 10.1.64 | D28IR—Device 28 Interrupt Route Register | 337 |
| 10.1.65 | D27IR—Device 27 Interrupt Route Register | 338 |
| 10.1.66 | D26IR—Device 26 Interrupt Route Register | 339 |
| 10.1.67 | D25IR—Device 25 Interrupt Route Register | 340 |
| 10.1.68 | OIC—Other Interrupt Control Register (Corporate Only) | 341 |
| 10.1.69 | OIC—Other Interrupt Control Register (Consumer Only) | 341 |
| 10.1.70 | SBEMC3—Scheduled Break Event C3 Exit Latency | 342 |
| 10.1.71 | SBEMC4—Scheduled Break Event C4 Exit Latency | 342 |
| 10.1.72 | PRSTS—Power and Reset Status (Corporate Only) | 343 |
| 10.1.73 | RC—RTC Configuration Register | 344 |
| 10.1.74 | HPTC—High Precision Timer Configuration Register | 344 |
| 10.1.75 | GCS—General Control and Status Register | 345 |
| 10.1.76 | BUC—Backed Up Control Register | 347 |
| 10.1.77 | FD—Function Disable Register | 348 |
| 10.1.78 | CG—Clock Gating | 350 |
| 10.1.79 | FDSW—Function Disable SUS Well | 352 |
| 10.1.80 | CIR8—Chipset Initialization Register 8 | 352 |
| 10.1.81 | CIR9—Chipset Initialization Register 9 | 352 |
| 10.1.82 | PPO—Port Power Off | 352 |
| 10.1.83 | CIR10—Chipset Initialization Register 10 | 353 |
| 10.1.84 | MAP—Remap Control Register | 353 |
| 11 | PCI-to-PCI Bridge Registers (D30:F0) | 355 |
| 11.1 | PCI Configuration Registers (D30:F0) | 355 |
| 11.1.1 | VID— Vendor Identification Register (PCI-PCI—D30:F0) | 356 |
| 11.1.2 | DID— Device Identification Register (PCI-PCI—D30:F0) | 356 |
| 11.1.3 | PCICMD—PCI Command (PCI-PCI—D30:F0) | 357 |
| 11.1.4 | PSTS—PCI Status Register (PCI-PCI—D30:F0) | 357 |
| 11.1.5 | RID—Revision Identification Register (PCI-PCI—D30:F0) | 359 |
| 11.1.6 | CC—Class Code Register (PCI-PCI—D30:F0) | 359 |
| 11.1.7 | PMLT—Primary Master Latency Timer Register (PCI-PCI—D30:F0) | 360 |
| 11.1.8 | HEADTYP—Header Type Register (PCI-PCI—D30:F0) | 360 |
| 11.1.9 | BNUM—Bus Number Register (PCI-PCI—D30:F0) | 360 |



| | | |
|-----------|-------------------------------------------------------------------------------------------|------------|
| 11.1.10 | SMLT—Secondary Master Latency Timer Register (PCI-PCI—D30:F0) | 361 |
| 11.1.11 | IOBASE_LIMIT—I/O Base and Limit Register (PCI-PCI—D30:F0) | 361 |
| 11.1.12 | SECSTS—Secondary Status Register (PCI-PCI—D30:F0) | 362 |
| 11.1.13 | MEMBASE_LIMIT—Memory Base and Limit Register (PCI-PCI—D30:F0) | 363 |
| 11.1.14 | PREF_MEM_BASE_LIMIT—Prefetchable Memory Base and Limit Register (PCI-PCI—D30:F0) | 363 |
| 11.1.15 | PMBU32—Prefetchable Memory Base Upper 32 Bits Register (PCI-PCI—D30:F0) | 364 |
| 11.1.16 | PMLU32—Prefetchable Memory Limit Upper 32 Bits Register (PCI-PCI—D30:F0) | 364 |
| 11.1.17 | CAPP—Capability List Pointer Register (PCI-PCI—D30:F0) | 364 |
| 11.1.18 | INTR—Interrupt Information Register (PCI-PCI—D30:F0) | 364 |
| 11.1.19 | BCTRL—Bridge Control Register (PCI-PCI—D30:F0) | 365 |
| 11.1.20 | SPDH—Secondary PCI Device Hiding Register (PCI-PCI—D30:F0) | 366 |
| 11.1.21 | DTC—Delayed Transaction Control Register (PCI-PCI—D30:F0) | 367 |
| 11.1.22 | BPS—Bridge Proprietary Status Register (PCI-PCI—D30:F0) | 368 |
| 11.1.23 | BPC—Bridge Policy Configuration Register (PCI-PCI—D30:F0) | 369 |
| 11.1.24 | SVCAP—Subsystem Vendor Capability Register (PCI-PCI—D30:F0) | 370 |
| 11.1.25 | SVID—Subsystem Vendor IDs Register (PCI-PCI—D30:F0) | 370 |
| 12 | Gigabit LAN Configuration Registers | 371 |
| 12.1 | Gigabit LAN Configuration Registers (Gigabit LAN — D25:F0) | 371 |
| 12.1.1 | VID—Vendor Identification Register (Gigabit LAN—D25:F0) | 372 |
| 12.1.2 | DID—Device Identification Register (Gigabit LAN—D25:F0) | 372 |
| 12.1.3 | PCICMD—PCI Command Register (Gigabit LAN—D25:F0) | 373 |
| 12.1.4 | PCISTS—PCI Status Register (Gigabit LAN—D25:F0) | 374 |
| 12.1.5 | RID—Revision Identification Register (Gigabit LAN—D25:F0) | 375 |
| 12.1.6 | CC—Class Code Register (Gigabit LAN—D25:F0) | 375 |
| 12.1.7 | CLS—Cache Line Size Register (Gigabit LAN—D25:F0) | 375 |
| 12.1.8 | PLT—Primary Latency Timer Register (Gigabit LAN—D25:F0) | 375 |
| 12.1.9 | HT—Header Type Register (Gigabit LAN—D25:F0) | 375 |
| 12.1.10 | MBARA—Memory Base Address Register A (Gigabit LAN—D25:F0) | 376 |
| 12.1.11 | MBARB—Memory Base Address Register B (Gigabit LAN—D25:F0) | 376 |
| 12.1.12 | MBARC—Memory Base Address Register C (Gigabit LAN—D25:F0) | 377 |
| 12.1.13 | SVID—Subsystem Vendor ID Register (Gigabit LAN—D25:F0) | 377 |
| 12.1.14 | SID—Subsystem ID Register (Gigabit LAN—D25:F0) | 377 |
| 12.1.15 | ERBA—Expansion ROM Base Address Register (Gigabit LAN—D25:F0) | 377 |
| 12.1.16 | CAPP—Capabilities List Pointer Register (Gigabit LAN—D25:F0) | 378 |
| 12.1.17 | INTR—Interrupt Information Register (Gigabit LAN—D25:F0) | 378 |
| 12.1.18 | MLMG—Maximum Latency/Minimum Grant Register (Gigabit LAN—D25:F0) | 378 |



| | | |
|-----------|------------------------------------------------------------------------------------------------------|------------|
| 12.1.19 | CLIST 1—Capabilities List Register 1 (Gigabit LAN—D25:F0) | 378 |
| 12.1.20 | PMC—PCI Power Management Capabilities Register (Gigabit LAN—D25:F0) | 379 |
| 12.1.21 | PMCS—PCI Power Management Control and Status Register (Gigabit LAN—D25:F0) | 380 |
| 12.1.22 | DR—Data Register (Gigabit LAN—D25:F0) | 381 |
| 12.1.23 | CLIST 2—Capabilities List Register 2 (Gigabit LAN—D25:F0) | 381 |
| 12.1.24 | MCTL—Message Control Register (Gigabit LAN—D25:F0) | 381 |
| 12.1.25 | MADDL—Message Address Low Register (Gigabit LAN—D25:F0) | 382 |
| 12.1.26 | MADDH—Message Address High Register (Gigabit LAN—D25:F0) | 382 |
| 12.1.27 | MDAT—Message Data Register (Gigabit LAN—D25:F0) | 382 |
| 12.1.28 | FLRCAP—Function Level Reset Capability (Gigabit LAN—D25:F0) | 382 |
| 12.1.29 | FLRCLV—Function Level Reset Capability Length and Version (Gigabit LAN—D25:F0) | 383 |
| 12.1.30 | DEVCTRL—Device Control (Gigabit LAN—D25:F0) | 383 |
| 12.2 | MBARA—Gigabit LAN Base Address A Registers | 384 |
| 12.2.1 | LDR4—LAN Device Initialization Register 4 (Gigabit LAN Memory Mapped Base Address Register) | 384 |
| 12.2.2 | LDR3—LAN Device Initialization Register 3 (Gigabit LAN Memory Mapped Base Address Register) | 384 |
| 12.2.3 | LDCR2—LAN Device Control Register 2 (Gigabit LAN Memory Mapped Base Address Register) | 385 |
| 12.2.4 | LDCR4—LAN Device Control Register 4 (Gigabit LAN Memory Mapped Base Address Register) | 385 |
| 12.2.5 | LDR5—LAN Device Control Register 5 (Gigabit LAN Memory Mapped Base Address Register) | 385 |
| 12.2.6 | LDR1—LAN Device Initialization Register 1 (Gigabit LAN Memory Mapped Base Address Register) | 385 |
| 13 | LPC Interface Bridge Registers (D31:F0) | 387 |
| 13.1 | PCI Configuration Registers (LPC I/F—D31:F0) | 387 |
| 13.1.1 | VID—Vendor Identification Register (LPC I/F—D31:F0) | 389 |
| 13.1.2 | DID—Device Identification Register (LPC I/F—D31:F0) | 389 |
| 13.1.3 | PCICMD—PCI COMMAND Register (LPC I/F—D31:F0) | 389 |
| 13.1.4 | PCISTS—PCI Status Register (LPC I/F—D31:F0) | 390 |
| 13.1.5 | RID—Revision Identification Register (LPC I/F—D31:F0) | 391 |
| 13.1.6 | PI—Programming Interface Register (LPC I/F—D31:F0) | 391 |
| 13.1.7 | SCC—Sub Class Code Register (LPC I/F—D31:F0) | 391 |
| 13.1.8 | BCC—Base Class Code Register (LPC I/F—D31:F0) | 391 |
| 13.1.9 | PLT—Primary Latency Timer Register (LPC I/F—D31:F0) | 391 |
| 13.1.10 | HEADTYP—Header Type Register (LPC I/F—D31:F0) | 392 |
| 13.1.11 | SS—Sub System Identifiers Register (LPC I/F—D31:F0) | 392 |
| 13.1.12 | PMBASE—ACPI Base Address Register (LPC I/F—D31:F0) | 392 |
| 13.1.13 | ACPI_CNTL—ACPI Control Register (LPC I/F — D31:F0) | 393 |
| 13.1.14 | GPIOBASE—GPIO Base Address Register (LPC I/F — D31:F0) | 393 |
| 13.1.15 | GC—GPIO Control Register (LPC I/F — D31:F0) | 394 |
| 13.1.16 | PIRQ[n]_ROUT—PIRQ[A,B,C,D] Routing Control Register (LPC I/F—D31:F0) | 395 |
| 13.1.17 | SIRQ_CNTL—Serial IRQ Control Register (LPC I/F—D31:F0) | 396 |
| 13.1.18 | PIRQ[n]_ROUT—PIRQ[E,F,G,H] Routing Control Register (LPC I/F—D31:F0) | 397 |
| 13.1.19 | LPC_IBDF—IOxAPIC Bus: Device: Function (LPC I/F—D31:F0) | 398 |
| 13.1.20 | LPC_HnBDF — HPET n Bus: Device: Function (LPC I/F—D31:F0) | 398 |
| 13.1.21 | LPC_I/O_DEC—I/O Decode Ranges Register (LPC I/F—D31:F0) | 399 |
| 13.1.22 | LPC_EN—LPC I/F Enables Register (LPC I/F—D31:F0) | 400 |
| 13.1.23 | GEN1_DEC—LPC I/F Generic Decode Range 1 Register (LPC I/F—D31:F0) | 401 |
| 13.1.24 | GEN2_DEC—LPC I/F Generic Decode Range 2 Register (LPC I/F—D31:F0) | 401 |



| | | |
|---------|-----------------------------------------------------------------------------------|-----|
| 13.1.25 | GEN3_DEC—LPC I/F Generic Decode Range 3 Register (LPC I/F—D31:F0) | 402 |
| 13.1.26 | GEN4_DEC—LPC I/F Generic Decode Range 4 Register (LPC I/F—D31:F0) | 403 |
| 13.1.27 | LGMR — LPC I/F Generic Memory Range (LPC I/F—D31:F0) (Corporate Only) | 403 |
| 13.1.28 | FWH_SEL1—Firmware Hub Select 1 Register (LPC I/F—D31:F0) | 404 |
| 13.1.29 | FWH_SEL2—Firmware Hub Select 2 Register (LPC I/F—D31:F0) | 405 |
| 13.1.30 | FWH_DEC_EN1—Firmware Hub Decode Enable Register (LPC I/F—D31:F0) | 406 |
| 13.1.31 | BIOS_CNTL—BIOS Control Register (LPC I/F—D31:F0) | 408 |
| 13.1.32 | FDCAP—Feature Detection Capability ID (LPC I/F—D31:F0) | 409 |
| 13.1.33 | FDLEN—Feature Detection Capability Length (LPC I/F—D31:F0) | 409 |
| 13.1.34 | FDVER—Feature Detection Version (LPC I/F—D31:F0) | 409 |
| 13.1.35 | FDVCT—Feature Vector (LPC I/F—D31:F0) | 410 |
| 13.1.36 | RCBA—Root Complex Base Address Register (LPC I/F—D31:F0) | 410 |
| 13.2 | DMA I/O Registers (LPC I/F—D31:F0) | 411 |
| 13.2.1 | DMABASE_CA—DMA Base and Current Address Registers (LPC I/F—D31:F0) | 412 |
| 13.2.2 | DMABASE_CC—DMA Base and Current Count Registers (LPC I/F—D31:F0) | 413 |
| 13.2.3 | DMAMEM_LP—DMA Memory Low Page Registers (LPC I/F—D31:F0) | 413 |
| 13.2.4 | DMACMD—DMA Command Register (LPC I/F—D31:F0) | 414 |
| 13.2.5 | DMASTA—DMA Status Register (LPC I/F—D31:F0) | 414 |
| 13.2.6 | DMA_WRSMSK—DMA Write Single Mask Register (LPC I/F—D31:F0) | 415 |
| 13.2.7 | DMACH_MODE—DMA Channel Mode Register (LPC I/F—D31:F0) | 416 |
| 13.2.8 | DMA Clear Byte Pointer Register (LPC I/F—D31:F0) | 417 |
| 13.2.9 | DMA Master Clear Register (LPC I/F—D31:F0) | 417 |
| 13.2.10 | DMA_CLMSK—DMA Clear Mask Register (LPC I/F—D31:F0) | 417 |
| 13.2.11 | DMA_WRMSK—DMA Write All Mask Register (LPC I/F—D31:F0) | 418 |
| 13.3 | Timer I/O Registers (LPC I/F—D31:F0) | 419 |
| 13.3.1 | TCW—Timer Control Word Register (LPC I/F—D31:F0) | 420 |
| 13.3.2 | SBYTE_FMT—Interval Timer Status Byte Format Register (LPC I/F—D31:F0) | 422 |
| 13.3.3 | Counter Access Ports Register (LPC I/F—D31:F0) | 423 |
| 13.4 | 8259 Interrupt Controller (PIC) Registers (LPC I/F—D31:F0) | 424 |
| 13.4.1 | Interrupt Controller I/O MAP (LPC I/F—D31:F0) | 424 |
| 13.4.2 | ICW1—Initialization Command Word 1 Register (LPC I/F—D31:F0) | 425 |
| 13.4.3 | ICW2—Initialization Command Word 2 Register (LPC I/F—D31:F0) | 426 |
| 13.4.4 | ICW3—Master Controller Initialization Command Word 3 Register (LPC I/F—D31:F0) | 427 |
| 13.4.5 | ICW3—Slave Controller Initialization Command Word 3 Register (LPC I/F—D31:F0) | 427 |
| 13.4.6 | ICW4—Initialization Command Word 4 Register (LPC I/F—D31:F0) | 428 |
| 13.4.7 | OCW1—Operational Control Word 1 (Interrupt Mask) Register (LPC I/F—D31:F0) | 428 |
| 13.4.8 | OCW2—Operational Control Word 2 Register (LPC I/F—D31:F0) | 429 |
| 13.4.9 | OCW3—Operational Control Word 3 Register (LPC I/F—D31:F0) | 430 |
| 13.4.10 | ELCR1—Master Controller Edge/Level Triggered Register (LPC I/F—D31:F0) | 431 |
| 13.4.11 | ELCR2—Slave Controller Edge/Level Triggered Register (LPC I/F—D31:F0) | 432 |
| 13.5 | Advanced Programmable Interrupt Controller (APIC)(D31:F0) | 433 |
| 13.5.1 | APIC Register Map (LPC I/F—D31:F0) | 433 |
| 13.5.2 | IND—Index Register (LPC I/F—D31:F0) | 434 |
| 13.5.3 | DAT—Data Register (LPC I/F—D31:F0) | 434 |
| 13.5.4 | EOIR—EOI Register (LPC I/F—D31:F0) | 435 |

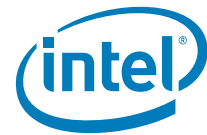

| | | |
|-----------|-------------------------------------------------------------------------|------------|
| 13.5.5 | ID—Identification Register (LPC I/F—D31:F0) | 436 |
| 13.5.6 | VER—Version Register (LPC I/F—D31:F0) | 436 |
| 13.5.7 | REDIR_TBL—Redirection Table (LPC I/F—D31:F0) | 437 |
| 13.6 | Real Time Clock Registers | 439 |
| 13.6.1 | I/O Register Address Map | 439 |
| 13.6.2 | Indexed Registers | 440 |
| 13.7 | Processor Interface Registers (LPC I/F—D31:F0) | 444 |
| 13.7.1 | NMI_SC—NMI Status and Control Register (LPC I/F—D31:F0) | 444 |
| 13.7.2 | NMI_EN—NMI Enable (and Real Time Clock Index) Register (LPC I/F—D31:F0) | 445 |
| 13.7.3 | PORT92—Fast A20 and Init Register (LPC I/F—D31:F0) | 445 |
| 13.7.4 | COPROC_ERR—Coprocessor Error Register (LPC I/F—D31:F0) | 446 |
| 13.7.5 | RST_CNT—Reset Control Register (LPC I/F—D31:F0) | 446 |
| 13.8 | Power Management Registers (PM—D31:F0) | 447 |
| 13.8.1 | Power Management PCI Configuration Registers (PM—D31:F0) | 447 |
| 13.8.2 | APM I/O Decode | 460 |
| 13.8.3 | Power Management I/O Registers | 461 |
| 13.9 | System Management TCO Registers (D31:F0) | 483 |
| 13.9.1 | TCO_RLD—TCO Timer Reload and Current Value Register | 483 |
| 13.9.2 | TCO_DAT_IN—TCO Data In Register | 484 |
| 13.9.3 | TCO_DAT_OUT—TCO Data Out Register | 484 |
| 13.9.4 | TCO1_STS—TCO1 Status Register | 484 |
| 13.9.5 | TCO2_STS—TCO2 Status Register | 486 |
| 13.9.6 | TCO1_CNT—TCO1 Control Register | 488 |
| 13.9.7 | TCO2_CNT—TCO2 Control Register | 489 |
| 13.9.8 | TCO_MESSAGE1 and TCO_MESSAGE2 Registers | 489 |
| 13.9.9 | TCO_WDCNT—TCO Watchdog Control Register | 490 |
| 13.9.10 | SW_IRQ_GEN—Software IRQ Generation Register | 490 |
| 13.9.11 | TCO_TMR—TCO Timer Initial Value Register | 490 |
| 13.10 | General Purpose I/O Registers (D31:F0) | 491 |
| 13.10.1 | GPIO_USE_SEL—GPIO Use Select Register | 492 |
| 13.10.2 | GP_IO_SEL—GPIO Input/Output Select Register | 492 |
| 13.10.3 | GP_LVL—GPIO Level for Input or Output Register | 493 |
| 13.10.4 | GPO_BLINK—GPO Blink Enable Register | 493 |
| 13.10.5 | GP_SER_BLINK—GP Serial Blink | 494 |
| 13.10.6 | GP_SB_CMDSTS—GP Serial Blink Command Status | 495 |
| 13.10.7 | GP_SB_DATA—GP Serial Blink Data | 495 |
| 13.10.8 | GPI_INV—GPIO Signal Invert Register | 496 |
| 13.10.9 | GPIO_USE_SEL2—GPIO Use Select 2 Register | 497 |
| 13.10.10 | GP_IO_SEL2—GPIO Input/Output Select 2 Register | 498 |
| 13.10.11 | GP_LVL2—GPIO Level for Input or Output 2 Register | 498 |
| 13.10.12 | GPIO_USE_SEL3—GPIO Use Select 3 Register (Corporate Only) | 499 |
| 13.10.13 | GP_IO_SEL3—GPIO Input/Output Select 3 Register (Corporate Only) | 499 |
| 13.10.14 | GP_LVL3—GPIO Level for Input or Output 3 Register (Corporate Only) | 500 |
| 13.10.15 | GP_RST_SEL — GPIO Reset Select | 500 |
| 14 | SATA Controller Registers (D31:F2) | 501 |
| 14.1 | PCI Configuration Registers (SATA—D31:F2) | 501 |
| 14.1.1 | VID—Vendor Identification Register (SATA—D31:F2) | 503 |
| 14.1.2 | DID—Device Identification Register (SATA—D31:F2) | 503 |
| 14.1.3 | PCICMD—PCI Command Register (SATA—D31:F2) | 503 |
| 14.1.4 | PCISTS — PCI Status Register (SATA—D31:F2) | 504 |
| 14.1.5 | RID—Revision Identification Register (SATA—D31:F2) | 505 |
| 14.1.6 | PI—Programming Interface Register (SATA—D31:F2) | 505 |
| 14.1.7 | SCC—Sub Class Code Register (SATA—D31:F2) | 506 |
| 14.1.8 | BCC—Base Class Code Register (SATA—D31:F2) | 506 |
| 14.1.9 | PMLT—Primary Master Latency Timer Register (SATA—D31:F2) | 507 |
| 14.1.10 | HTYPE—Header Type (SATA—D31:F2) | 507 |
| 14.1.11 | PCMD_BAR—Primary Command Block Base Address Register (SATA—D31:F2) | 507 |
| 14.1.12 | PCNL_BAR—Primary Control Block Base Address Register (SATA—D31:F2) | 508 |
| 14.1.13 | SCMD_BAR—Secondary Command Block Base Address Register (IDE D31:F1) | 508 |

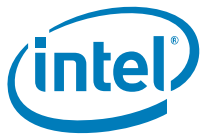

| | | |
|-----------|-------------------------------------------------------------------------------------------------------|------------|
| 14.1.14 | SCNL_BAR—Secondary Control Block Base Address Register (IDE D31:F1) | 508 |
| 14.1.15 | BAR — Legacy Bus Master Base Address Register (SATA–D31:F2) | 509 |
| 14.1.16 | ABAR/SIDPBA1 — AHCI Base Address Register/Serial ATA Index Data Pair Base Address (SATA–D31:F2) | 509 |
| 14.1.17 | SVID—Subsystem Vendor Identification Register (SATA–D31:F2) | 510 |
| 14.1.18 | SID—Subsystem Identification Register (SATA–D31:F2) | 510 |
| 14.1.19 | CAP—Capabilities Pointer Register (SATA–D31:F2) | 510 |
| 14.1.20 | INT_LN—Interrupt Line Register (SATA–D31:F2) | 511 |
| 14.1.21 | INT_PN—Interrupt Pin Register (SATA–D31:F2) | 511 |
| 14.1.22 | IDE_TIM — IDE Timing Register (SATA–D31:F2) | 511 |
| 14.1.23 | PID—PCI Power Management Capability Identification Register (SATA–D31:F2) | 511 |
| 14.1.24 | PC—PCI Power Management Capabilities Register (SATA–D31:F2) | 512 |
| 14.1.25 | PMCS—PCI Power Management Control and Status Register (SATA–D31:F2) | 512 |
| 14.1.26 | MSIC1—Message Signaled Interrupt Capability Identification (SATA–D31:F2) | 513 |
| 14.1.27 | MSIMC—Message Signaled Interrupt Message Control (SATA–D31:F2) | 514 |
| 14.1.28 | MSIMA— Message Signaled Interrupt Message Address (SATA–D31:F2) | 515 |
| 14.1.29 | MSIMD—Message Signaled Interrupt Message Data (SATA–D31:F2) | 515 |
| 14.1.30 | MAP—Address Map Register (SATA–D31:F2) | 516 |
| 14.1.31 | PCS—Port Control and Status Register (SATA–D31:F2) | 516 |
| 14.1.32 | SCLKCG—SATA Clock Gating Control Register | 519 |
| 14.1.33 | SCLKGC—SATA Clock General Configuration Register | 520 |
| 14.1.34 | FLRCID—FLR Capability ID (SATA–D31:F2) | 522 |
| 14.1.35 | FLRCLV—FLR Capability Length and Version (SATA–D31:F2) | 522 |
| 14.1.36 | FLRC—FLR Control (SATA–D31:F2) | 523 |
| 14.1.37 | ATC—APM Trapping Control Register (SATA–D31:F2) | 523 |
| 14.1.38 | ATS—APM Trapping Status Register (SATA–D31:F2) | 524 |
| 14.1.39 | SP Scratch Pad Register (SATA–D31:F2) | 524 |
| 14.1.40 | BFCFS—BIST FIS Control/Status Register (SATA–D31:F2) | 525 |
| 14.1.41 | BFTD1—BIST FIS Transmit Data1 Register (SATA–D31:F2) | 527 |
| 14.1.42 | BFTD2—BIST FIS Transmit Data2 Register (SATA–D31:F2) | 527 |
| 14.2 | Bus Master IDE I/O Registers (D31:F2) | 528 |
| 14.2.1 | BMIC[P,S]—Bus Master IDE Command Register (D31:F2) | 529 |
| 14.2.2 | BMIS[P,S]—Bus Master IDE Status Register (D31:F2) | 530 |
| 14.2.3 | BMID[P,S]—Bus Master IDE Descriptor Table Pointer Register (D31:F2) | 531 |
| 14.2.4 | AIR—AHCI Index Register (D31:F2) | 531 |
| 14.2.5 | AIDR—AHCI Index Data Register (D31:F2) | 531 |
| 14.3 | Serial ATA Index/Data Pair Superset Registers | 532 |
| 14.3.1 | SINDX – Serial ATA Index (D31:F2) | 532 |
| 14.3.2 | SDATA – Serial ATA Data (D31:F2) | 532 |
| 14.4 | AHCI Registers (D31:F2) | 536 |
| 14.4.1 | AHCI Generic Host Control Registers (D31:F2) | 537 |
| 14.4.2 | Vendor Specific Registers (D31:F2) | 545 |
| 14.4.3 | Port Registers (D31:F2) | 545 |
| 15 | SATA Controller Registers (D31:F5) | 563 |
| 15.1 | PCI Configuration Registers (SATA–D31:F5) | 563 |
| 15.1.1 | VID—Vendor Identification Register (SATA–D31:F5) | 564 |
| 15.1.2 | DID—Device Identification Register (SATA–D31:F5) | 565 |
| 15.1.3 | PCICMD—PCI Command Register (SATA–D31:F5) | 565 |
| 15.1.4 | PCISTS — PCI Status Register (SATA–D31:F5) | 566 |
| 15.1.5 | RID—Revision Identification Register (SATA–D31:F5) | 566 |
| 15.1.6 | PI—Programming Interface Register (SATA–D31:F5) | 567 |
| 15.1.7 | SCC—Sub Class Code Register (SATA–D31:F5) | 567 |
| 15.1.8 | BCC—Base Class Code Register (SATA–D31:F5) | 567 |
| 15.1.9 | PMLT—Primary Master Latency Timer Register (SATA–D31:F5) | 568 |
| 15.1.10 | PCMD_BAR—Primary Command Block Base Address Register (SATA–D31:F5) | 568 |



| | | |
|-----------|---------------------------------------------------------------------------|------------|
| 15.1.11 | PCNL_BAR—Primary Control Block Base Address Register (SATA–D31:F5) | 568 |
| 15.1.12 | SCMD_BAR—Secondary Command Block Base Address Register (IDE D31:F1) | 569 |
| 15.1.13 | SCNL_BAR—Secondary Control Block Base Address Register (IDE D31:F1) | 569 |
| 15.1.14 | BAR — Legacy Bus Master Base Address Register (SATA–D31:F5) | 570 |
| 15.1.15 | SIDPBA — SATA Index/Data Pair Base Address Register (SATA–D31:F5) | 570 |
| 15.1.16 | SVID—Subsystem Vendor Identification Register (SATA–D31:F5) | 571 |
| 15.1.17 | SID—Subsystem Identification Register (SATA–D31:F5) | 571 |
| 15.1.18 | CAP—Capabilities Pointer Register (SATA–D31:F5) | 571 |
| 15.1.19 | INT_LN—Interrupt Line Register (SATA–D31:F5) | 571 |
| 15.1.20 | INT_PN—Interrupt Pin Register (SATA–D31:F5) | 571 |
| 15.1.21 | IDE_TIM — IDE Timing Register (SATA–D31:F5) | 572 |
| 15.1.22 | PID—PCI Power Management Capability Identification Register (SATA–D31:F5) | 572 |
| 15.1.23 | PC—PCI Power Management Capabilities Register (SATA–D31:F5) | 572 |
| 15.1.24 | PMCS—PCI Power Management Control and Status Register (SATA–D31:F5) | 573 |
| 15.1.25 | MID—Message Signal Interrupt Identifier (SATA–D31:F5) (Consumer Only) | 573 |
| 15.1.26 | MC—Message Signal Interrupt Message Control (SATA–D31:F5) (Consumer Only) | 574 |
| 15.1.27 | MA—Message Signal Interrupt Message Address (SATA–D31:F5) (Consumer Only) | 574 |
| 15.1.28 | MD—Message Signal Interrupt Message Data (SATA–D31:F5) (Consumer Only) | 574 |
| 15.1.29 | MAP—Address Map Register (SATA–D31:F5) 16 | 575 |
| 15.1.30 | PCS—Port Control and Status Register (SATA–D31:F5) | 576 |
| 15.1.31 | SATACR0— SATA Capability Register 0 (SATA–D31:F5) | 577 |
| 15.1.32 | SATACR1— SATA Capability Register 1 (SATA–D31:F5) | 577 |
| 15.1.33 | FLRCID— FLR Capability ID (SATA–D31:F5) | 577 |
| 15.1.34 | FLRCLV— FLR Capability Length and Value (SATA–D31:F5) | 578 |
| 15.1.35 | FLRCTRL— FLR Control (SATA–D31:F5) | 578 |
| 15.1.36 | ATC—APM Trapping Control Register (SATA–D31:F5) | 579 |
| 15.1.37 | ATC—APM Trapping Control (SATA–D31:F5) | 579 |
| 15.2 | Bus Master IDE I/O Registers (D31:F5) | 580 |
| 15.2.1 | BMIC[P,S]—Bus Master IDE Command Register (D31:F5) | 581 |
| 15.2.2 | BMIS[P,S]—Bus Master IDE Status Register (D31:F5) | 582 |
| 15.2.3 | BMID[P,S]—Bus Master IDE Descriptor Table Pointer Register (D31:F5) | 582 |
| 15.3 | Serial ATA Index/Data Pair Superset Registers | 583 |
| 15.3.1 | SINDX—SATA Index Register (D31:F5) | 583 |
| 15.3.2 | SDATA—SATA Index Data Register (D31:F5) | 583 |
| 16 | UHCI Controllers Registers | 589 |
| 16.1 | PCI Configuration Registers (USB–D29:F0/F1/F2/F3, D26:F0/F1/F2) | 589 |
| 16.1.1 | VID—Vendor Identification Register (USB–D29:F0/F1/F2/F3, D26:F0/F1/F2) | 590 |
| 16.1.2 | DID—Device Identification Register (USB–D29:F0/F1/F2/F3, D26:F0/F1/F2) | 590 |
| 16.1.3 | PCICMD—PCI Command Register (USB–D29:F0/F1/F2/F3, D26:F0/F1/F2) | 591 |
| 16.1.4 | PCISTS—PCI Status Register (USB–D29:F0/F1/F2/F3, D26:F0/F1/F2) | 592 |
| 16.1.5 | RID—Revision Identification Register (USB–D29:F0/F1/F2/F3, D26:F0/F1/F2) | 592 |
| 16.1.6 | PI—Programming Interface Register (USB–D29:F0/F1/F2/F3, D26:F0/F1/F2) | 593 |
| 16.1.7 | SCC—Sub Class Code Register (USB–D29:F0/F1/F2/F3, D26:F0/F1/F2) | 593 |
| 16.1.8 | BCC—Base Class Code Register (USB–D29:F0/F1/F2/F3, D26:F0/F1/F2) | 593 |

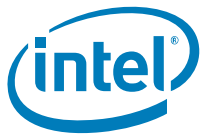

| | | |
|-----------|----------------------------------------------------------------------------------------------------|------------|
| 16.1.9 | MLT—Master Latency Timer Register (USB—D29: F0/F1/F2/F3, D26: F0/F1/F2) | 593 |
| 16.1.10 | HEADTYP—Header Type Register (USB—D29: F0/F1/F2/F3, D26: F0/F1/F2) | 594 |
| 16.1.11 | BASE—Base Address Register (USB—D29: F0/F1/F2/F3, D26: F0/F1/F2) | 594 |
| 16.1.12 | SVID — Subsystem Vendor Identification Register (USB—D29: F0/F1/F2/F3, D26: F0/F1/F2) | 594 |
| 16.1.13 | SID — Subsystem Identification Register (USB—D29: F0/F1/F2/F3, D26: F0/F1/F2) | 595 |
| 16.1.14 | CAP_PTR—Capabilities Pointer (USB—D29: F0/F1/F2/F3, D26: F0/F1/F2) | 595 |
| 16.1.15 | INT_LN—Interrupt Line Register (USB—D29: F0/F1/F2/F3, D26: F0/F1/F2) | 595 |
| 16.1.16 | INT_PN—Interrupt Pin Register (USB—D29: F0/F1/F2/F3, D26: F0/F1/F2) | 596 |
| 16.1.17 | FLRCID—Function Level Reset Capability ID (USB—D29: F0/F1/F2/F3, D26: F0/F1/F2) | 596 |
| 16.1.18 | FLRNCP—Function Level Reset Next Capability Pointer (USB—D29: F0/F1/F2/F3, D26: F0/F1/F2) | 596 |
| 16.1.19 | FLRCLV—Function Level Reset Capability Length and Version (USB—D29: F0/F1/F2/F3, D26: F0/F1/F2) | 597 |
| 16.1.20 | USB_FLRCTRL—FLR Control Register (USB—D29: F0/F1/F2/F3, D26: F0/F1/F2) | 597 |
| 16.1.21 | USB_FLRSTAT—FLR Status Register (USB—D29: F0/F1/F2/F3, D26: F0/F1/F2) | 598 |
| 16.1.22 | USB_RELNUM—Serial Bus Release Number Register (USB—D29: F0/F1/F2/F3, D26: F0/F1/F2) | 598 |
| 16.1.23 | USB_LEGKEY—USB Legacy Keyboard/Mouse Control Register (USB—D29: F0/F1/F2/F3, D26: F0/F1/F2) | 598 |
| 16.1.24 | USB_RES—USB Resume Enable Register (USB—D29: F0/F1/F2/F3, D26: F0/F1/F2) | 600 |
| 16.1.25 | CWP—Core Well Policy Register (USB—D29: F0/F1/F2/F3, D26: F0/F1/F2) | 601 |
| 16.1.26 | UCR1—UCHI Configuration Register 1 (USB—D29: F0/F1/F2/F3, D26: F0/F1/F2) | 601 |
| 16.2 | USB I/O Registers | 602 |
| 16.2.1 | USBCMD—USB Command Register | 603 |
| 16.2.2 | USBSTS—USB Status Register | 606 |
| 16.2.3 | USBINTR—USB Interrupt Enable Register | 607 |
| 16.2.4 | FRNUM—Frame Number Register | 607 |
| 16.2.5 | FRBASEADD—Frame List Base Address Register | 608 |
| 16.2.6 | SOFMOD—Start of Frame Modify Register | 608 |
| 16.2.7 | PORTSC[0,1]—Port Status and Control Register | 609 |
| 17 | EHCI Controller Registers (D29:F7, D26:F7) | 611 |
| 17.1 | USB EHCI Configuration Registers (USB EHCI—D29:F7, D26:F7) | 611 |
| 17.1.1 | VID—Vendor Identification Register (USB EHCI—D29:F7, D26:F7) | 612 |
| 17.1.2 | DID—Device Identification Register (USB EHCI—D29:F7, D26:F7) | 612 |
| 17.1.3 | PCICMD—PCI Command Register (USB EHCI—D29:F7, D26:F7) | 613 |
| 17.1.4 | PCISTS—PCI Status Register (USB EHCI—D29:F7, D26:F7) | 614 |
| 17.1.5 | RID—Revision Identification Register (USB EHCI—D29:F7, D26:F7) | 615 |
| 17.1.6 | PI—Programming Interface Register (USB EHCI—D29:F7, D26:F7) | 615 |
| 17.1.7 | SCC—Sub Class Code Register (USB EHCI—D29:F7, D26:F7) | 615 |
| 17.1.8 | BCC—Base Class Code Register (USB EHCI—D29:F7, D26:F7) | 615 |
| 17.1.9 | PMLT—Primary Master Latency Timer Register (USB EHCI—D29:F7, D26:F7) | 616 |
| 17.1.10 | MEM_BASE—Memory Base Address Register (USB EHCI—D29:F7, D26:F7) | 616 |



| | | |
|-----------|----------------------------------------------------------------------------------------------------------|------------|
| 17.1.11 | SVID—USB EHCI Subsystem Vendor ID Register (USB EHCI—D29:F7, D26:F7) | 616 |
| 17.1.12 | SID—USB EHCI Subsystem ID Register (USB EHCI—D29:F7, D26:F7) | 617 |
| 17.1.13 | CAP_PTR—Capabilities Pointer Register (USB EHCI—D29:F7, D26:F7) | 617 |
| 17.1.14 | INT_LN—Interrupt Line Register (USB EHCI—D29:F7, D26:F7) | 617 |
| 17.1.15 | INT_PN—Interrupt Pin Register (USB EHCI—D29:F7, D26:F7) | 617 |
| 17.1.16 | PWR_CAPID—PCI Power Management Capability ID Register (USB EHCI—D29:F7, D26:F7) | 618 |
| 17.1.17 | NXT_PTR1—Next Item Pointer #1 Register (USB EHCI—D29:F7, D26:F7) | 618 |
| 17.1.18 | PWR_CAP—Power Management Capabilities Register (USB EHCI—D29:F7, D26:F7) | 619 |
| 17.1.19 | PWR_CNTL_STS—Power Management Control/ Status Register (USB EHCI—D29:F7, D26:F7) | 620 |
| 17.1.20 | DEBUG_CAPID—Debug Port Capability ID Register (USB EHCI—D29:F7, D26:F7) | 621 |
| 17.1.21 | NXT_PTR2—Next Item Pointer #2 Register (USB EHCI—D29:F7, D26:F7) | 621 |
| 17.1.22 | DEBUG_BASE—Debug Port Base Offset Register (USB EHCI—D29:F7, D26:F7) | 621 |
| 17.1.23 | USB_RELNUM—USB Release Number Register (USB EHCI—D29:F7, D26:F7) | 621 |
| 17.1.24 | FL_ADJ—Frame Length Adjustment Register (USB EHCI—D29:F7, D26:F7) | 622 |
| 17.1.25 | PWAKE_CAP—Port Wake Capability Register (USB EHCI—D29:F7, D26:F7) | 623 |
| 17.1.26 | LEG_EXT_CAP—USB EHCI Legacy Support Extended Capability Register (USB EHCI—D29:F7, D26:F7) | 624 |
| 17.1.27 | LEG_EXT_CS—USB EHCI Legacy Support Extended Control / Status Register (USB EHCI—D29:F7, D26:F7) | 624 |
| 17.1.28 | SPECIAL_SMI—Intel Specific USB 2.0 SMI Register (USB EHCI—D29:F7, D26:F7) | 626 |
| 17.1.29 | ACCESS_CNTL—Access Control Register (USB EHCI—D29:F7, D26:F7) | 628 |
| 17.1.30 | EHCIIR1—EHCI Initialization Register 1 (USB EHCI—D29:F7, D26:F7) | 628 |
| 17.1.31 | FLR_CID—Function Level Reset Capability ID (USB EHCI—D29:F7, D26:F7) | 628 |
| 17.1.32 | FLR_NEXT—Function Level Reset Next Capability Pointer (USB EHCI—D29:F7, D26:F7) | 629 |
| 17.1.33 | FLR_CLV—Function Level Reset Capability Length and Version (USB EHCI—D29:F7, D26:F7) | 629 |
| 17.1.34 | FLR_CTRL—Function Level Reset Control Register (USB EHCI—D29:F7, D26:F7) | 630 |
| 17.1.35 | FLR_STS—Function Level Reset Status Register (USB EHCI—D29:F7, D26:F7) | 630 |
| 17.1.36 | EHCIIR2—EHCI Initialization Register 2 (USB EHCI—D29:F7, D26:F7) | 630 |
| 17.2 | Memory-Mapped I/O Registers | 631 |
| 17.2.1 | Host Controller Capability Registers | 631 |
| 17.2.2 | Host Controller Operational Registers | 635 |
| 17.2.3 | USB 2.0-Based Debug Port Register | 649 |
| 18 | Intel® High Definition Audio Controller Registers (D27:F0) | 653 |
| 18.1 | Intel® High Definition Audio PCI Configuration Space (Intel® High Definition Audio— D27:F0) | 653 |
| 18.1.1 | VID—Vendor Identification Register (Intel® High Definition Audio Controller—D27:F0) | 655 |
| 18.1.2 | DID—Device Identification Register (Intel® High Definition Audio Controller—D27:F0) | 655 |
| 18.1.3 | PCICMD—PCI Command Register (Intel® High Definition Audio Controller—D27:F0) | 655 |



| | | |
|---------|---------------------------------------------------------------------------------------------------------------------|-----|
| 18.1.4 | PCISTS—PCI Status Register (Intel® High Definition Audio Controller—D27:F0) | 656 |
| 18.1.5 | RID—Revision Identification Register (Intel® High Definition Audio Controller—D27:F0) | 657 |
| 18.1.6 | PI—Programming Interface Register (Intel® High Definition Audio Controller—D27:F0) | 657 |
| 18.1.7 | SCC—Sub Class Code Register (Intel® High Definition Audio Controller—D27:F0) | 657 |
| 18.1.8 | BCC—Base Class Code Register (Intel® High Definition Audio Controller—D27:F0) | 657 |
| 18.1.9 | CLS—Cache Line Size Register (Intel® High Definition Audio Controller—D27:F0) | 657 |
| 18.1.10 | LT—Latency Timer Register (Intel® High Definition Audio Controller—D27:F0) | 658 |
| 18.1.11 | HEADTYP—Header Type Register (Intel® High Definition Audio Controller—D27:F0) | 658 |
| 18.1.12 | HDBARL—Intel® High Definition Audio Lower Base Address Register (Intel® High Definition Audio—D27:F0) | 658 |
| 18.1.13 | HDBARU—Intel® High Definition Audio Upper Base Address Register (Intel® High Definition Audio Controller—D27:F0) | 658 |
| 18.1.14 | SVID—Subsystem Vendor Identification Register (Intel® High Definition Audio Controller—D27:F0) | 659 |
| 18.1.15 | SID—Subsystem Identification Register (Intel® High Definition Audio Controller—D27:F0) | 659 |
| 18.1.16 | CAPPTR—Capabilities Pointer Register (Intel® High Definition Audio Controller—D27:F0) | 659 |
| 18.1.17 | INTLN—Interrupt Line Register (Intel® High Definition Audio Controller—D27:F0) | 660 |
| 18.1.18 | INTPN—Interrupt Pin Register (Intel® High Definition Audio Controller—D27:F0) | 660 |
| 18.1.19 | HDCTL—Intel® High Definition Audio Control Register (Intel® High Definition Audio Controller—D27:F0) | 660 |
| 18.1.20 | TCSEL—Traffic Class Select Register (Intel® High Definition Audio Controller—D27:F0) | 661 |
| 18.1.21 | PID—PCI Power Management Capability ID Register (Intel® High Definition Audio Controller—D27:F0) | 661 |
| 18.1.22 | PC—Power Management Capabilities Register (Intel® High Definition Audio Controller—D27:F0) | 662 |
| 18.1.23 | PCS—Power Management Control and Status Register (Intel® High Definition Audio Controller—D27:F0) | 663 |
| 18.1.24 | MID—MSI Capability ID Register (Intel® High Definition Audio Controller—D27:F0) | 664 |
| 18.1.25 | MMC—MSI Message Control Register (Intel® High Definition Audio Controller—D27:F0) | 664 |
| 18.1.26 | MMLA—MSI Message Lower Address Register (Intel® High Definition Audio Controller—D27:F0) | 664 |
| 18.1.27 | MMUA—MSI Message Upper Address Register (Intel® High Definition Audio Controller—D27:F0) | 664 |
| 18.1.28 | MMD—MSI Message Data Register (Intel® High Definition Audio Controller—D27:F0) | 665 |
| 18.1.29 | PXID—PCI Express* Capability ID Register (Intel® High Definition Audio Controller—D27:F0) | 665 |
| 18.1.30 | PXC—PCI Express* Capabilities Register (Intel® High Definition Audio Controller—D27:F0) | 665 |
| 18.1.31 | DEVCAP—Device Capabilities Register (Intel® High Definition Audio Controller—D27:F0) | 666 |
| 18.1.32 | DEVC—Device Control Register (Intel® High Definition Audio Controller—D27:F0) | 667 |
| 18.1.33 | DEVS—Device Status Register (Intel® High Definition Audio Controller—D27:F0) | 668 |
| 18.1.34 | VCCAP—Virtual Channel Enhanced Capability Header (Intel® High Definition Audio Controller—D27:F0) | 668 |
| 18.1.35 | PVCCAP1—Port VC Capability Register 1 (Intel® High Definition Audio Controller—D27:F0) | 669 |
| 18.1.36 | PVCCAP2—Port VC Capability Register 2 (Intel® High Definition Audio Controller—D27:F0) | 669 |



| | | |
|---------|-----------------------------------------------------------------------------------------------------------------------------------|-----|
| 18.1.37 | PVCCTL — Port VC Control Register (Intel® High Definition Audio Controller—D27:F0) | 669 |
| 18.1.38 | PVCSTS—Port VC Status Register (Intel® High Definition Audio Controller—D27:F0) | 670 |
| 18.1.39 | VCOCAP—VCO Resource Capability Register (Intel® High Definition Audio Controller—D27:F0) | 670 |
| 18.1.40 | VCOCTL—VCO Resource Control Register (Intel® High Definition Audio Controller—D27:F0) | 671 |
| 18.1.41 | VCOSTS—VCO Resource Status Register (Intel® High Definition Audio Controller—D27:F0) | 671 |
| 18.1.42 | VCiCAP—VCi Resource Capability Register (Intel® High Definition Audio Controller—D27:F0) | 672 |
| 18.1.43 | VCiCTL—VCi Resource Control Register (Intel® High Definition Audio Controller—D27:F0) | 672 |
| 18.1.44 | VCiSTS—VCi Resource Status Register (Intel® High Definition Audio Controller—D27:F0) | 673 |
| 18.1.45 | RCCAP—Root Complex Link Declaration Enhanced Capability Header Register (Intel® High Definition Audio Controller—D27:F0) | 673 |
| 18.1.46 | ESD—Element Self Description Register (Intel® High Definition Audio Controller—D27:F0) | 673 |
| 18.1.47 | L1DESC—Link 1 Description Register (Intel® High Definition Audio Controller—D27:F0) | 674 |
| 18.1.48 | L1ADDL—Link 1 Lower Address Register (Intel® High Definition Audio Controller—D27:F0) | 674 |
| 18.1.49 | L1ADDU—Link 1 Upper Address Register (Intel® High Definition Audio Controller—D27:F0) | 674 |
| 18.2 | Intel® High Definition Audio Memory Mapped Configuration Registers (Intel® High Definition Audio— D27:F0) | 675 |
| 18.2.1 | GCAP—Global Capabilities Register (Intel® High Definition Audio Controller—D27:F0) | 679 |
| 18.2.2 | VMIN—Minor Version Register (Intel® High Definition Audio Controller—D27:F0) | 679 |
| 18.2.3 | VMAJ—Major Version Register (Intel® High Definition Audio Controller—D27:F0) | 679 |
| 18.2.4 | OUTPAY—Output Payload Capability Register (Intel® High Definition Audio Controller—D27:F0) | 680 |
| 18.2.5 | INPAY—Input Payload Capability Register (Intel® High Definition Audio Controller—D27:F0) | 680 |
| 18.2.6 | GCTL—Global Control Register (Intel® High Definition Audio Controller—D27:F0) | 681 |
| 18.2.7 | WAKEEN—Wake Enable Register (Intel® High Definition Audio Controller—D27:F0) | 682 |
| 18.2.8 | STATESTS—State Change Status Register (Intel® High Definition Audio Controller—D27:F0) | 682 |
| 18.2.9 | GSTS—Global Status Register (Intel® High Definition Audio Controller—D27:F0) | 683 |
| 18.2.10 | OUTSTRMPAY—Output Stream Payload Capability (Intel® High Definition Audio Controller—D27:F0) | 683 |
| 18.2.11 | INSTRMPAY—Input Stream Payload Capability (Intel® High Definition Audio Controller—D27:F0) | 684 |
| 18.2.12 | INTCTL—Interrupt Control Register (Intel® High Definition Audio Controller—D27:F0) | 685 |
| 18.2.13 | INTSTS—Interrupt Status Register (Intel® High Definition Audio Controller—D27:F0) | 686 |
| 18.2.14 | WALCLK—Wall Clock Counter Register (Intel® High Definition Audio Controller—D27:F0) | 686 |
| 18.2.15 | SSYNC—Stream Synchronization Register (Intel® High Definition Audio Controller—D27:F0) | 687 |
| 18.2.16 | CORBLBASE—CORB Lower Base Address Register (Intel® High Definition Audio Controller—D27:F0) | 687 |
| 18.2.17 | CORBUBASE—CORB Upper Base Address Register (Intel® High Definition Audio Controller—D27:F0) | 688 |
| 18.2.18 | CORBWP—CORB Write Pointer Register (Intel® High Definition Audio Controller—D27:F0) | 688 |
| 18.2.19 | CORBRP—CORB Read Pointer Register (Intel® High Definition Audio Controller—D27:F0) | 688 |

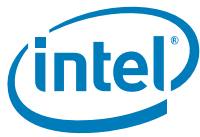

| | | |
|-----------|-----------------------------------------------------------------------------------------------------------------------------------------------|------------|
| 18.2.20 | CORBCTL—CORB Control Register (Intel® High Definition Audio Controller—D27:F0) | 689 |
| 18.2.21 | CORBST—CORB Status Register (Intel® High Definition Audio Controller—D27:F0) | 689 |
| 18.2.22 | CORBSIZE—CORB Size Register (Intel® High Definition Audio Controller—D27:F0) | 689 |
| 18.2.23 | RIRBLBASE—RIRB Lower Base Address Register (Intel® High Definition Audio Controller—D27:F0) | 690 |
| 18.2.24 | RIRBUBASE—RIRB Upper Base Address Register (Intel® High Definition Audio Controller—D27:F0) | 690 |
| 18.2.25 | RIRBWP—RIRB Write Pointer Register (Intel® High Definition Audio Controller—D27:F0) | 690 |
| 18.2.26 | RINTCNT—Response Interrupt Count Register (Intel® High Definition Audio Controller—D27:F0) | 691 |
| 18.2.27 | RIRBCTL—RIRB Control Register (Intel® High Definition Audio Controller—D27:F0) | 691 |
| 18.2.28 | RIRBSTS—RIRB Status Register (Intel® High Definition Audio Controller—D27:F0) | 692 |
| 18.2.29 | RIRBSIZE—RIRB Size Register (Intel® High Definition Audio Controller—D27:F0) | 692 |
| 18.2.30 | IC—Immediate Command Register (Intel® High Definition Audio Controller—D27:F0) | 692 |
| 18.2.31 | IR—Immediate Response Register (Intel® High Definition Audio Controller—D27:F0) | 693 |
| 18.2.32 | IRS—Immediate Command Status Register (Intel® High Definition Audio Controller—D27:F0) | 693 |
| 18.2.33 | DPLBASE—DMA Position Lower Base Address Register (Intel® High Definition Audio Controller—D27:F0) | 694 |
| 18.2.34 | DPUBASE—DMA Position Upper Base Address Register (Intel® High Definition Audio Controller—D27:F0) | 694 |
| 18.2.35 | SDCTL—Stream Descriptor Control Register (Intel® High Definition Audio Controller—D27:F0) | 695 |
| 18.2.36 | SDSTS—Stream Descriptor Status Register (Intel® High Definition Audio Controller—D27:F0) | 697 |
| 18.2.37 | SDLPIB—Stream Descriptor Link Position in Buffer Register (Intel® High Definition Audio Controller—D27:F0) | 698 |
| 18.2.38 | SDCBL—Stream Descriptor Cyclic Buffer Length Register (Intel® High Definition Audio Controller—D27:F0) | 698 |
| 18.2.39 | SDLVI—Stream Descriptor Last Valid Index Register (Intel® High Definition Audio Controller—D27:F0) | 699 |
| 18.2.40 | SDFIFOW—Stream Descriptor FIFO Watermark Register (Intel® High Definition Audio Controller—D27:F0) | 699 |
| 18.2.41 | SDFIFOS—Stream Descriptor FIFO Size Register (Intel® High Definition Audio Controller—D27:F0) | 700 |
| 18.2.42 | SDFMT—Stream Descriptor Format Register (Intel® High Definition Audio Controller—D27:F0) | 701 |
| 18.2.43 | SDBDPL—Stream Descriptor Buffer Descriptor List Pointer Lower Base Address Register (Intel® High Definition Audio Controller—D27:F0) | 702 |
| 18.2.44 | SDBDPU—Stream Descriptor Buffer Descriptor List Pointer Upper Base Address Register (Intel® High Definition Audio Controller—D27:F0) | 702 |
| 19 | SMBus Controller Registers (D31:F3) | 703 |
| 19.1 | PCI Configuration Registers (SMBus—D31:F3) | 703 |
| 19.1.1 | VID—Vendor Identification Register (SMBus—D31:F3) | 703 |
| 19.1.2 | DID—Device Identification Register (SMBus—D31:F3) | 704 |
| 19.1.3 | PCICMD—PCI Command Register (SMBus—D31:F3) | 704 |
| 19.1.4 | PCISTS—PCI Status Register (SMBus—D31:F3) | 705 |
| 19.1.5 | RID—Revision Identification Register (SMBus—D31:F3) | 705 |
| 19.1.6 | PI—Programming Interface Register (SMBus—D31:F3) | 706 |
| 19.1.7 | SCC—Sub Class Code Register (SMBus—D31:F3) | 706 |
| 19.1.8 | BCC—Base Class Code Register (SMBus—D31:F3) | 706 |
| 19.1.9 | SMBMBAR0—D31_F3_SMBus Memory Base Address 0 (SMBus—D31:F3) | 706 |
| 19.1.10 | SMBMBAR1—D31_F3_SMBus Memory Base Address 1 (SMBus—D31:F3) | 707 |
| 19.1.11 | SMB_BASE—SMBus Base Address Register (SMBus—D31:F3) | 707 |



| | | |
|---------|---------------------------------------------------------------------------------------------|-----|
| 19.1.12 | SVID—Subsystem Vendor Identification Register (SMBus—D31:F2/F4) | 707 |
| 19.1.13 | SID—Subsystem Identification Register (SMBus—D31:F2/F4) | 708 |
| 19.1.14 | INT_LN—Interrupt Line Register (SMBus—D31:F3) | 708 |
| 19.1.15 | INT_PN—Interrupt Pin Register (SMBus—D31:F3) | 708 |
| 19.1.16 | HOSTC—Host Configuration Register (SMBus—D31:F3) | 709 |
| 19.2 | SMBus I/O and Memory Mapped I/O Registers | 710 |
| 19.2.1 | HST_STS—Host Status Register (SMBus—D31:F3) | 711 |
| 19.2.2 | HST_CNT—Host Control Register (SMBus—D31:F3) | 712 |
| 19.2.3 | HST_CMD—Host Command Register (SMBus—D31:F3) | 714 |
| 19.2.4 | XMIT_SLVA—Transmit Slave Address Register (SMBus—D31:F3) | 714 |
| 19.2.5 | HST_D0—Host Data 0 Register (SMBus—D31:F3) | 714 |
| 19.2.6 | HST_D1—Host Data 1 Register (SMBus—D31:F3) | 714 |
| 19.2.7 | Host_BLOCK_DB—Host Block Data Byte Register (SMBus—D31:F3) | 715 |
| 19.2.8 | PEC—Packet Error Check (PEC) Register (SMBus—D31:F3) | 715 |
| 19.2.9 | RCV_SLVA—Receive Slave Address Register (SMBus—D31:F3) | 716 |
| 19.2.10 | SLV_DATA—Receive Slave Data Register (SMBus—D31:F3) | 716 |
| 19.2.11 | AUX_STS—Auxiliary Status Register (SMBus—D31:F3) | 716 |
| 19.2.12 | AUX_CTL—Auxiliary Control Register (SMBus—D31:F3) | 717 |
| 19.2.13 | SMLINK_PIN_CTL—SMLink Pin Control Register (SMBus—D31:F3) | 717 |
| 19.2.14 | SMBus_PIN_CTL—SMBus Pin Control Register (SMBus—D31:F3) | 718 |
| 19.2.15 | SLV_STS—Slave Status Register (SMBus—D31:F3) | 718 |
| 19.2.16 | SLV_CMD—Slave Command Register (SMBus—D31:F3) | 719 |
| 19.2.17 | NOTIFY_DADDR—Notify Device Address Register (SMBus—D31:F3) | 719 |
| 19.2.18 | NOTIFY_DLOW—Notify Data Low Byte Register (SMBus—D31:F3) | 720 |
| 19.2.19 | NOTIFY_DHIGH—Notify Data High Byte Register (SMBus—D31:F3) | 720 |
| 20 | PCI Express* Configuration Registers | 721 |
| 20.1 | PCI Express* Configuration Registers (PCI Express—D28:F0/F1/F2/F3/F4/F5) | 721 |
| 20.1.1 | VID—Vendor Identification Register (PCI Express—D28:F0/F1/F2/F3/F4/F5) | 724 |
| 20.1.2 | DID—Device Identification Register (PCI Express—D28:F0/F1/F2/F3/F4/F5) | 724 |
| 20.1.3 | PCICMD—PCI Command Register (PCI Express—D28:F0/F1/F2/F3/F4/F5) | 725 |
| 20.1.4 | PCISTS—PCI Status Register (PCI Express—D28:F0/F1/F2/F3/F4/F5) | 726 |
| 20.1.5 | RID—Revision Identification Register (PCI Express—D28:F0/F1/F2/F3/F4/F5) | 727 |
| 20.1.6 | PI—Programming Interface Register (PCI Express—D28:F0/F1/F2/F3/F4/F5) | 727 |
| 20.1.7 | SCC—Sub Class Code Register (PCI Express—D28:F0/F1/F2/F3/F4/F5) | 727 |
| 20.1.8 | BCC—Base Class Code Register (PCI Express—D28:F0/F1/F2/F3/F4/F5) | 727 |
| 20.1.9 | CLS—Cache Line Size Register (PCI Express—D28:F0/F1/F2/F3/F4/F5) | 728 |
| 20.1.10 | PLT—Primary Latency Timer Register (PCI Express—D28:F0/F1/F2/F3/F4/F5) | 728 |
| 20.1.11 | HEADTYP—Header Type Register (PCI Express—D28:F0/F1/F2/F3/F4/F5) | 728 |
| 20.1.12 | BNUM—Bus Number Register (PCI Express—D28:F0/F1/F2/F3/F4/F5) | 728 |
| 20.1.13 | SLT—Secondary Latency Timer (PCI Express—D28:F0/F1/F2/F3/F4/F5) | 729 |
| 20.1.14 | IOBL—I/O Base and Limit Register (PCI Express—D28:F0/F1/F2/F3/F4/F5) | 729 |
| 20.1.15 | SSTS—Secondary Status Register (PCI Express—D28:F0/F1/F2/F3/F4/F5) | 730 |
| 20.1.16 | MBL—Memory Base and Limit Register (PCI Express—D28:F0/F1/F2/F3/F4/F5) | 731 |
| 20.1.17 | PMBL—Prefetchable Memory Base and Limit Register (PCI Express—D28:F0/F1/F2/F3/F4/F5) | 731 |
| 20.1.18 | PMBU32—Prefetchable Memory Base Upper 32 Bits Register (PCI Express—D28:F0/F1/F2/F3/F4/F5) | 731 |
| 20.1.19 | PMLU32—Prefetchable Memory Limit Upper 32 Bits Register (PCI Express—D28:F0/F1/F2/F3/F4/F5) | 732 |



| | | |
|---------|-----------------------------------------------------------------------------------------------|-----|
| 20.1.20 | CAPP—Capabilities List Pointer Register (PCI Express—D28:F0/F1/F2/F3/F4/F5) | 732 |
| 20.1.21 | INTR—Interrupt Information Register (PCI Express—D28:F0/F1/F2/F3/F4/F5) | 732 |
| 20.1.22 | BCTRL—Bridge Control Register (PCI Express—D28:F0/F1/F2/F3/F4/F5) | 733 |
| 20.1.23 | CLIST—Capabilities List Register (PCI Express—D28:F0/F1/F2/F3/F4/F5) | 734 |
| 20.1.24 | XCAP—PCI Express* Capabilities Register (PCI Express—D28:F0/F1/F2/F3/F4/F5) | 734 |
| 20.1.25 | DCAP—Device Capabilities Register (PCI Express—D28:F0/F1/F2/F3/F4/F5) | 735 |
| 20.1.26 | DCTL—Device Control Register (PCI Express—D28:F0/F1/F2/F3/F4/F5) | 736 |
| 20.1.27 | DSTS—Device Status Register (PCI Express—D28:F0/F1/F2/F3/F4/F5) | 737 |
| 20.1.28 | LCAP—Link Capabilities Register (PCI Express—D28:F0/F1/F2/F3/F4/F5) | 738 |
| 20.1.29 | LCTL—Link Control Register (PCI Express—D28:F0/F1/F2/F3/F4/F5) | 740 |
| 20.1.30 | LSTS—Link Status Register (PCI Express—D28:F0/F1/F2/F3/F4/F5) | 741 |
| 20.1.31 | SLCAP—Slot Capabilities Register (PCI Express—D28:F0/F1/F2/F3/F4/F5) | 742 |
| 20.1.32 | SLCTL—Slot Control Register (PCI Express—D28:F0/F1/F2/F3/F4/F5) | 743 |
| 20.1.33 | SLSTS—Slot Status Register (PCI Express—D28:F0/F1/F2/F3/F4/F5) | 744 |
| 20.1.34 | RCTL—Root Control Register (PCI Express—D28:F0/F1/F2/F3/F4/F5) | 745 |
| 20.1.35 | RSTS—Root Status Register (PCI Express—D28:F0/F1/F2/F3/F4/F5) | 745 |
| 20.1.36 | DCAP2—Device Capabilities 2 Register (Corporate Only) (PCI Express—D28:F0/F1/F2/F3/F4/F5) | 746 |
| 20.1.37 | DCTL2—Device Control 2 Register (Corporate Only) (PCI Express—D28:F0/F1/F2/F3/F4/F5) | 746 |
| 20.1.38 | LCTL2—Link Control 2 Register (Corporate Only) (PCI Express—D28:F0/F1/F2/F3/F4/F5) | 747 |
| 20.1.39 | MID—Message Signaled Interrupt Identifiers Register (PCI Express—D28:F0/F1/F2/F3/F4/F5) | 747 |
| 20.1.40 | MC—Message Signaled Interrupt Message Control Register (PCI Express—D28:F0/F1/F2/F3/F4/F5) | 747 |
| 20.1.41 | MA—Message Signaled Interrupt Message Address Register (PCI Express—D28:F0/F1/F2/F3/F4/F5) | 748 |
| 20.1.42 | MD—Message Signaled Interrupt Message Data Register (PCI Express—D28:F0/F1/F2/F3/F4/F5) | 748 |
| 20.1.43 | SVCAP—Subsystem Vendor Capability Register (PCI Express—D28:F0/F1/F2/F3/F4/F5) | 748 |
| 20.1.44 | SVID—Subsystem Vendor Identification Register (PCI Express—D28:F0/F1/F2/F3/F4/F5) | 748 |
| 20.1.45 | PMCAP—Power Management Capability Register (PCI Express—D28:F0/F1/F2/F3/F4/F5) | 749 |
| 20.1.46 | PMC—PCI Power Management Capabilities Register (PCI Express—D28:F0/F1/F2/F3/F4/F5) | 749 |
| 20.1.47 | PMCS—PCI Power Management Control and Status Register (PCI Express—D28:F0/F1/F2/F3/F4/F5) | 750 |
| 20.1.48 | MPC2—Miscellaneous Port Configuration Register 2 (PCI Express—D28:F0/F1/F2/F3/F4/F5) | 751 |
| 20.1.49 | MPC—Miscellaneous Port Configuration Register (PCI Express—D28:F0/F1/F2/F3/F4/F5) | 752 |
| 20.1.50 | SMSCS—SMI/SCI Status Register (PCI Express—D28:F0/F1/F2/F3/F4/F5) | 754 |
| 20.1.51 | RPDCGEN—Root Port Dynamic Clock Gating Enable (PCI Express—D28:F0/F1/F2/F3/F4/F5) | 755 |
| 20.1.52 | PECR1—PCI Express* Configuration Register 1 (PCI Express—D28:F0/F1/F2/F3/F4/F5) | 755 |

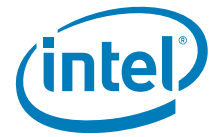

| | | |
|-----------|------------------------------------------------------------------------------------------------------|------------|
| 20.1.53 | VCH—Virtual Channel Capability Header Register (PCI Express—D28: F0/F1/F2/F3/F4/F5)..... | 756 |
| 20.1.54 | VCAP2—Virtual Channel Capability 2 Register (PCI Express—D28: F0/F1/F2/F3/F4/F5)..... | 756 |
| 20.1.55 | PVC—Port Virtual Channel Control Register (PCI Express—D28: F0/F1/F2/F3/F4/F5)..... | 756 |
| 20.1.56 | PVS—Port Virtual Channel Status Register (PCI Express—D28: F0/F1/F2/F3/F4/F5)..... | 757 |
| 20.1.57 | V0CAP—Virtual Channel 0 Resource Capability Register (PCI Express—D28: F0/F1/F2/F3/F4/F5)..... | 757 |
| 20.1.58 | V0CTL—Virtual Channel 0 Resource Control Register (PCI Express—D28: F0/F1/F2/F3/F4/F5)..... | 758 |
| 20.1.59 | V0STS—Virtual Channel 0 Resource Status Register (PCI Express—D28: F0/F1/F2/F3/F4/F5)..... | 758 |
| 20.1.60 | UES—Uncorrectable Error Status Register (PCI Express—D28: F0/F1/F2/F3/F4/F5)..... | 759 |
| 20.1.61 | UEM—Uncorrectable Error Mask (PCI Express—D28: F0/F1/F2/F3/F4/F5)..... | 760 |
| 20.1.62 | UEV — Uncorrectable Error Severity (PCI Express—D28: F0/F1/F2/F3/F4/F5)..... | 761 |
| 20.1.63 | CES — Correctable Error Status Register (PCI Express—D28: F0/F1/F2/F3/F4/F5)..... | 762 |
| 20.1.64 | CEM — Correctable Error Mask Register (PCI Express—D28: F0/F1/F2/F3/F4/F5)..... | 762 |
| 20.1.65 | AECC — Advanced Error Capabilities and Control Register (PCI Express—D28: F0/F1/F2/F3/F4/F5)..... | 763 |
| 20.1.66 | RES — Root Error Status Register (PCI Express—D28: F0/F1/F2/F3/F4/F5)..... | 763 |
| 20.1.67 | RCTCL — Root Complex Topology Capability List Register (PCI Express—D28: F0/F1/F2/F3/F4/F5)..... | 763 |
| 20.1.68 | ESD—Element Self Description Register (PCI Express—D28: F0/F1/F2/F3/F4/F5)..... | 764 |
| 20.1.69 | ULD — Upstream Link Description Register (PCI Express—D28: F0/F1/F2/F3/F4/F5)..... | 764 |
| 20.1.70 | ULBA — Upstream Link Base Address Register (PCI Express—D28: F0/F1/F2/F3/F4/F5)..... | 765 |
| 20.1.71 | PECR2 — PCI Express* Configuration Register 2 (PCI Express—D28: F0/F1/F2/F3/F4/F5)..... | 765 |
| 20.1.72 | PEETM — PCI Express* Extended Test Mode Register (PCI Express—D28: F0/F1/F2/F3/F4/F5)..... | 765 |
| 20.1.73 | PEC1 — PCI Express* Configuration Register 1 (PCI Express—D28: F0/F1/F2/F3/F4/F5)..... | 766 |
| 21 | High Precision Event Timer Registers | 767 |
| 21.1 | Memory Mapped Registers | 767 |
| 21.1.1 | GCAP_ID—General Capabilities and Identification Register | 769 |
| 21.1.2 | GEN_CONF—General Configuration Register | 770 |
| 21.1.3 | GINTR_STA—General Interrupt Status Register | 770 |
| 21.1.4 | MAIN_CNT—Main Counter Value Register | 771 |
| 21.1.5 | TIMn_CONF—Timer n Configuration and Capabilities Register | 772 |
| 21.1.6 | TIMn_COMP—Timer n Comparator Value Register | 775 |
| 22 | Serial Peripheral Interface (SPI) | 777 |
| 22.1 | Serial Peripheral Interface Memory Mapped Configuration Registers | 777 |
| 22.1.1 | BFPR —BIOS Flash Primary Region Register (SPI Memory Mapped Configuration Registers) | 779 |
| 22.1.2 | HSFS—Hardware Sequencing Flash Status Register (SPI Memory Mapped Configuration Registers) | 779 |
| 22.1.3 | HSFC—Hardware Sequencing Flash Control Register (SPI Memory Mapped Configuration Registers) | 781 |
| 22.1.4 | FADDR—Flash Address Register (SPI Memory Mapped Configuration Registers) | 781 |
| 22.1.5 | FDATA0—Flash Data 0 Register (SPI Memory Mapped Configuration Registers) | 782 |
| 22.1.6 | FATAN—Flash Data [N] Register (SPI Memory Mapped Configuration Registers) | 782 |

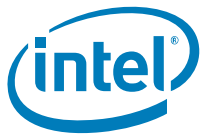

| | | |
|---------|-----------------------------------------------------------------------------------------------------------------|-----|
| 22.1.7 | FRAP—Flash Regions Access Permissions Register (SPI Memory Mapped Configuration Registers) | 783 |
| 22.1.8 | FREG0—Flash Region 0 (Flash Descriptor) Register (SPI Memory Mapped Configuration Registers) | 784 |
| 22.1.9 | FREG1—Flash Region 1 (BIOS Descriptor) Register (SPI Memory Mapped Configuration Registers) | 784 |
| 22.1.10 | FREG2—Flash Region 2 (ME) Register (SPI Memory Mapped Configuration Registers) | 785 |
| 22.1.11 | FREG3—Flash Region 3 (GbE) Register (SPI Memory Mapped Configuration Registers) | 785 |
| 22.1.12 | FREG4—Flash Region 4 (Platform Data) Register (SPI Memory Mapped Configuration Registers) | 786 |
| 22.1.13 | PRO—Protected Range 0 Register (SPI Memory Mapped Configuration Registers) | 786 |
| 22.1.14 | PR1—Protected Range 1 Register (SPI Memory Mapped Configuration Registers) | 787 |
| 22.1.15 | PR2—Protected Range 2 Register (SPI Memory Mapped Configuration Registers) | 788 |
| 22.1.16 | PR3—Protected Range 3 Register (SPI Memory Mapped Configuration Registers) | 788 |
| 22.1.17 | PR4—Protected Range 4 Register (SPI Memory Mapped Configuration Registers) | 789 |
| 22.1.18 | SSFS—Software Sequencing Flash Status Register (SPI Memory Mapped Configuration Registers) | 790 |
| 22.1.19 | SSFC—Software Sequencing Flash Control Register (SPI Memory Mapped Configuration Registers) | 791 |
| 22.1.20 | PREOP—Prefix Opcode Configuration Register (SPI Memory Mapped Configuration Registers) | 792 |
| 22.1.21 | OPTYPE—Opcode Type Configuration Register (SPI Memory Mapped Configuration Registers) | 792 |
| 22.1.22 | OPMENU—Opcode Menu Configuration Register (SPI Memory Mapped Configuration Registers) | 793 |
| 22.1.23 | BBAR—BIOS Base Address Configuration Register (SPI Memory Mapped Configuration Registers) | 794 |
| 22.1.24 | FDOC—Flash Descriptor Observability Control Register (SPI Memory Mapped Configuration Registers) | 794 |
| 22.1.25 | FDOD—Flash Descriptor Observability Data Register (SPI Memory Mapped Configuration Registers) | 795 |
| 22.1.26 | AFC—Additional Flash Control Register (SPI Memory Mapped Configuration Registers) | 795 |
| 22.1.27 | LVSCC—Host Lower Vendor Specific Component Capabilities Register (SPI Memory Mapped Configuration Registers) | 796 |
| 22.1.28 | UVSCC—Host Upper Vendor Specific Component Capabilities Register (SPI Memory Mapped Configuration Registers) | 797 |
| 22.1.29 | FPB — Flash Partition Boundary (SPI Memory Mapped Configuration Registers) | 799 |
| 22.2 | Flash Descriptor Registers | 800 |
| 22.2.1 | Flash Descriptor Content | 800 |
| 22.2.2 | Flash Descriptor Component Section | 802 |
| 22.2.3 | Flash Descriptor Region Section | 805 |
| 22.2.4 | Flash Descriptor Master Section | 807 |
| 22.2.5 | Descriptor Upper Map Section | 810 |
| 22.2.6 | Intel ME Vendor Specific Component Capabilities Table | 810 |
| 22.3 | OEM Section | 815 |
| 22.4 | GbE SPI Flash Program Registers | 815 |
| 22.4.1 | GLFPR —Gigabit LAN Flash Primary Region Register (GbE LAN Memory Mapped Configuration Registers) | 816 |
| 22.4.2 | HSFS—Hardware Sequencing Flash Status Register (GbE LAN Memory Mapped Configuration Registers) | 817 |
| 22.4.3 | HSFC—Hardware Sequencing Flash Control Register (GbE LAN Memory Mapped Configuration Registers) | 818 |
| 22.4.4 | FADDR—Flash Address Register (GbE LAN Memory Mapped Configuration Registers) | 818 |
| 22.4.5 | FDATA0—Flash Data 0 Register (GbE LAN Memory Mapped Configuration Registers) | 819 |
| 22.4.6 | FRAP—Flash Regions Access Permissions Register (GbE LAN Memory Mapped Configuration Registers) | 820 |



| | | |
|-----------|-----------------------------------------------------------------------------------------------------|------------|
| 22.4.7 | FREG0—Flash Region 0 (Flash Descriptor) Register (GbE LAN Memory Mapped Configuration Registers) | 821 |
| 22.4.8 | FREG1—Flash Region 1 (BIOS Descriptor) Register (GbE LAN Memory Mapped Configuration Registers) | 821 |
| 22.4.9 | FREG2—Flash Region 2 (ME) Register (GbE LAN Memory Mapped Configuration Registers) | 821 |
| 22.4.10 | FREG3—Flash Region 3 (GbE) Register (GbE LAN Memory Mapped Configuration Registers) | 822 |
| 22.4.11 | FPRO—Flash Protected Range 0 Register (GbE LAN Memory Mapped Configuration Registers) | 822 |
| 22.4.12 | FPR1—Flash Protected Range 1 Register (GbE LAN Memory Mapped Configuration Registers) | 823 |
| 22.4.13 | SSFS—Software Sequencing Flash Status Register (GbE LAN Memory Mapped Configuration Registers) | 824 |
| 22.4.14 | SSFC—Software Sequencing Flash Control Register (GbE LAN Memory Mapped Configuration Registers) | 825 |
| 22.4.15 | PREOP—Prefix Opcode Configuration Register (GbE LAN Memory Mapped Configuration Registers) | 826 |
| 22.4.16 | OPTYPE—Opcode Type Configuration Register (GbE LAN Memory Mapped Configuration Registers) | 826 |
| 22.4.17 | OPMENU—Opcode Menu Configuration Register (GbE LAN Memory Mapped Configuration Registers) | 827 |
| 23 | Thermal Sensor Registers (D31:F6) | 829 |
| 23.1 | PCI Bus Configuration Registers | 829 |
| 23.1.1 | VID—Vendor Identification | 830 |
| 23.1.2 | DID—Device Identification | 830 |
| 23.1.3 | CMD—Command | 830 |
| 23.1.4 | STS—Status | 831 |
| 23.1.5 | RID—Revision Identification | 831 |
| 23.1.6 | PI—Programming Interface | 831 |
| 23.1.7 | SCC—Sub Class Code | 832 |
| 23.1.8 | BCC—Base Class Code | 832 |
| 23.1.9 | CLS—Cache Line Size | 832 |
| 23.1.10 | LT—Latency Timer | 832 |
| 23.1.11 | BIST—Built-in Self Test | 833 |
| 23.1.12 | TBAR—Thermal Base | 833 |
| 23.1.13 | TBARH—Thermal Base High DWord | 833 |
| 23.1.14 | SVID—Subsystem Vendor ID | 834 |
| 23.1.15 | SID—Subsystem ID | 834 |
| 23.1.16 | CAP_PTR—Capabilities Pointer | 834 |
| 23.1.17 | Offset 3Ch – INTLN—Interrupt Line | 834 |
| 23.1.18 | INTPN—Interrupt Pin | 835 |
| 23.1.19 | TBARB—BIOS Assigned Thermal Base Address | 835 |
| 23.1.20 | TBARBH—BIOS Assigned Thermal Base High DWord | 835 |
| 23.1.21 | PID—PCI Power Management Capability ID | 836 |
| 23.1.22 | PC—Power Management Capabilities | 836 |
| 23.1.23 | PCS—Power Management Control And Status | 837 |
| 23.2 | Thermal Memory Mapped Configuration Registers (Thermal Sensor - D31:F26) | 838 |
| 23.2.1 | TSxE—Thermal Sensor [1:0] Enable | 838 |
| 23.2.2 | TSxS—Thermal Sensor [1:0] Status | 839 |
| 23.2.3 | TSxTTP—Thermal Sensor [1:0] Catastrophic Trip Point | 839 |
| 23.2.4 | TSxCO—Thermal Sensor [1:0] Catastrophic Lock-Down | 839 |
| 23.2.5 | TSxPC—Thermal Sensor [1:0] Policy Control | 840 |
| 23.2.6 | TSxLOCK—Thermal Sensor [1:0] Register Lock Control | 840 |



Figures

| | | |
|------|-------------------------------------------------------------------------------------------------|-----|
| 2-1 | Intel® ICH10 Interface Signals Block Diagram | 46 |
| 2-1 | Example External RTC Circuit | 79 |
| 4-1 | ICH10 Conceptual System Clock Diagram | 92 |
| 5-1 | Generation of SERR# to Platform | 99 |
| 5-2 | LPC Interface Diagram | 107 |
| 5-3 | Intel® ICH10 DMA Controller | 112 |
| 5-4 | DMA Request Assertion through LDRO# | 115 |
| 5-5 | Coprocessor Error Timing Diagram | 140 |
| 5-6 | TCO Legacy/Compatible Mode SMBus Configuration | 169 |
| 5-7 | Advanced TCO Intel® ME SMBus/SMLink Configuration | 171 |
| 5-8 | Advanced TCO BMC Mode SMBus/SMLink Configuration | 172 |
| 5-9 | Serial Post over GPIO Reference Circuit | 174 |
| 5-10 | SATA Power States | 181 |
| 5-11 | Flow for Port Enable / Device Present Bits | 183 |
| 5-12 | Serial Data transmitted over the SGPIO Interface | 188 |
| 5-13 | USB Legacy Keyboard Flow Diagram | 198 |
| 5-14 | Intel® ICH10-USB Port Connections Default Six and Six Configuration | 206 |
| 5-15 | Intel® ICH10-USB Port Connections Eight and Four Configuration | 206 |
| 5-16 | Flash Partition Boundary | 231 |
| 5-17 | Flash Descriptor Sections | 232 |
| 6-1 | Intel® ICH10 Ballout (Top view–Left Side) | 244 |
| 6-2 | Intel® ICH10 Ballout (Top view–Right Side) | 245 |
| 7-1 | Intel® ICH10 Package (Top View) | 253 |
| 7-2 | Intel® ICH10 Package (Bottom View) | 254 |
| 7-3 | Intel® ICH10 Package (Side View) | 254 |
| 8-1 | Clock Timing | 280 |
| 8-2 | Valid Delay from Rising Clock Edge | 280 |
| 8-3 | Setup and Hold Times | 281 |
| 8-4 | Float Delay | 281 |
| 8-5 | Pulse Width | 281 |
| 8-6 | Output Enable Delay | 281 |
| 8-7 | USB Rise and Fall Times | 282 |
| 8-8 | USB Jitter | 282 |
| 8-9 | USB EOP Width | 282 |
| 8-10 | SMBus Transaction | 283 |
| 8-11 | SMBus Timeout | 283 |
| 8-12 | SPI Timings | 284 |
| 8-13 | Intel® High Definition Audio Input and Output Timings | 284 |
| 8-14 | Power Sequencing and Reset Signal Timings | 285 |
| 8-15 | G3 (Mechanical Off) to S0 Timings | 286 |
| 8-16 | S0 to S1 to S0 Timings | 287 |
| 8-17 | S0 to S5 to S0 Timings | 287 |
| 8-18 | C0 to C2 to C0 Timings | 288 |
| 8-19 | C0 to C3 to C0 Timings | 288 |
| 8-20 | C0 to C4 to C0 Timings | 289 |
| 8-21 | Sleep control signal relationship - Host boots and Intel Management Engine off | 290 |
| 8-22 | Sleep control signal relationship - Host and Intel Management Engine boot after G3 | 290 |
| 8-23 | Sleep control signal relationship - Host stays in S5 and Intel Management Engine boots after G3 | 291 |
| 8-24 | S4, S5/M1 to S0/M0 | 291 |
| 8-25 | S0 to S3/S4/S5 and G3 Timings | 291 |

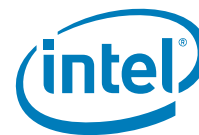

Tables

| | | |
|------|---------------------------------------------------------------------------|-----|
| 1-1 | Industry Specifications | 33 |
| 1-2 | PCI Devices and Functions | 37 |
| 1-3 | Intel® ICH10 Components | 44 |
| 2-1 | Direct Media Interface Signals | 47 |
| 2-2 | PCI Express* Signals..... | 48 |
| 2-3 | LAN Connect Interface Signals..... | 48 |
| 2-4 | Gigabit LAN Connect Interface Signals | 49 |
| 2-5 | Firmware Hub Interface Signals | 50 |
| 2-6 | PCI Interface Signals..... | 50 |
| 2-7 | Serial ATA Interface Signals | 52 |
| 2-8 | LPC Interface Signals | 55 |
| 2-9 | Interrupt Signals | 55 |
| 2-10 | USB Interface Signals..... | 56 |
| 2-11 | Power Management Interface Signals | 58 |
| 2-12 | Processor Interface Signals | 61 |
| 2-13 | SMBus Interface Signals | 62 |
| 2-14 | System Management Interface Signals | 63 |
| 2-15 | Real Time Clock Interface | 64 |
| 2-16 | Other Clocks | 65 |
| 2-17 | Miscellaneous Signals | 65 |
| 2-18 | Intel® High Definition Audio Link Signals | 66 |
| 2-19 | Serial Peripheral Interface (SPI) Signals..... | 67 |
| 2-20 | Controller Link Signals..... | 68 |
| 2-21 | Intel® Quiet System Technology Signals | 68 |
| 2-22 | JTAG Signals..... | 69 |
| 2-23 | General Purpose I/O Signals..... | 70 |
| 2-24 | Power and Ground Signals | 73 |
| 2-25 | Functional Strap Definitions..... | 75 |
| 3-1 | Integrated Pull-Up and Pull-Down Resistors | 81 |
| 3-2 | Power Plane and States for Output and I/O Signals for Configurations..... | 83 |
| 3-3 | Power Plane for Input Signals for Configurations | 88 |
| 4-1 | Intel® ICH10 and System Clock Domains | 91 |
| 5-1 | PCI Bridge Initiator Cycle Types..... | 93 |
| 5-2 | Type 1 Address Format..... | 96 |
| 5-3 | MSI versus PCI IRQ Actions..... | 98 |
| 5-4 | LAN Mode Support | 103 |
| 5-5 | LPC Cycle Types Supported | 108 |
| 5-6 | Start Field Bit Definitions | 108 |
| 5-7 | Cycle Type Bit Definitions | 109 |
| 5-8 | Transfer Size Bit Definition..... | 109 |
| 5-9 | SYNC Bit Definition | 110 |
| 5-10 | DMA Transfer Size | 114 |
| 5-11 | Address Shifting in 16-Bit I/O DMA Transfers..... | 114 |
| 5-12 | Counter Operating Modes | 119 |
| 5-13 | Interrupt Controller Core Connections..... | 121 |
| 5-14 | Interrupt Status Registers..... | 122 |
| 5-15 | Content of Interrupt Vector Byte..... | 122 |
| 5-16 | APIC Interrupt Mapping ¹ | 128 |
| 5-17 | Interrupt Message Address Format..... | 130 |
| 5-18 | Interrupt Message Data Format | 131 |
| 5-19 | Stop Frame Explanation..... | 133 |
| 5-20 | Data Frame Format..... | 134 |
| 5-21 | Configuration Bits Reset by RTCRST# Assertion | 137 |
| 5-22 | INIT# Going Active | 139 |
| 5-23 | NMI Sources | 140 |
| 5-24 | DP Signal Differences | 141 |
| 5-25 | General Power States for Systems Using Intel® ICH10..... | 143 |
| 5-26 | State Transition Rules for Intel® ICH10 | 144 |
| 5-27 | System Power Plane..... | 145 |
| 5-28 | Causes of SMI# and SCI | 146 |
| 5-29 | Break Events..... | 149 |
| 5-30 | Sleep Types | 151 |
| 5-31 | Causes of Wake Events..... | 152 |
| 5-32 | GPI Wake Events | 153 |
| 5-33 | Transitions Due to Power Failure | 154 |

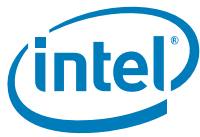

| | | |
|------|---------------------------------------------------------------------------------|-----|
| 5-34 | Transitions Due to Power Button | 155 |
| 5-35 | Transitions Due to RI# Signal | 157 |
| 5-36 | Write Only Registers with Read Paths in ALT Access Mode | 159 |
| 5-37 | PIC Reserved Bits Return Values | 161 |
| 5-38 | Register Write Accesses in ALT Access Mode | 161 |
| 5-39 | Intel® ICH10 Clock Inputs | 164 |
| 5-40 | Causes of Host and Global Resets | 166 |
| 5-41 | Event Transitions that Cause Messages | 170 |
| 5-42 | Multi-activity LED message type | 187 |
| 5-43 | Legacy Replacement Routing | 190 |
| 5-44 | Bits Maintained in Low Power States | 197 |
| 5-45 | USB Legacy Keyboard State Transitions | 198 |
| 5-46 | UHCI vs. EHCI | 201 |
| 5-47 | Debug Port Behavior | 210 |
| 5-48 | I ² C Block Read | 218 |
| 5-49 | Enable for SMBALERT# | 221 |
| 5-50 | Enables for SMBus Slave Write and SMBus Host Events | 221 |
| 5-51 | Enables for the Host Notify Command | 221 |
| 5-52 | Slave Write Registers | 223 |
| 5-53 | Command Types | 223 |
| 5-54 | Slave Read Cycle Format | 224 |
| 5-55 | Data Values for Slave Read Registers | 225 |
| 5-56 | Host Notify Format | 227 |
| 5-57 | Region Size versus Erase Granularity of Flash Components | 231 |
| 5-58 | Region Access Control Table | 233 |
| 5-59 | Hardware Sequencing Commands and Opcode Requirements | 236 |
| 5-60 | Flash Protection Mechanism Summary | 237 |
| 5-61 | Recommended Pinout for 8-Pin Serial Flash Device | 238 |
| 5-62 | Recommended Pinout for 16-Pin Serial Flash Device | 239 |
| 6-1 | Intel® ICH10 Ballout by Signal Name | 246 |
| 8-1 | Intel® ICH10 Absolute Maximum Ratings | 255 |
| 8-2 | DC Current Characteristics (Consumer Only)1 | 255 |
| 8-3 | DC Current Characteristics (Corporate Only) | 257 |
| 8-4 | DC Characteristic Input Signal Association | 258 |
| 8-5 | DC Input Characteristics | 260 |
| 8-6 | DC Characteristic Output Signal Association | 262 |
| 8-7 | DC Output Characteristics | 264 |
| 8-8 | Other DC Characteristics | 266 |
| 8-9 | Clock Timings | 268 |
| 8-10 | PCI Interface Timing | 269 |
| 8-11 | Universal Serial Bus Timing | 270 |
| 8-12 | SATA Interface Timings | 271 |
| 8-13 | SMBus Timing | 272 |
| 8-14 | Intel® High Definition Audio Timing | 272 |
| 8-15 | LPC Timing | 273 |
| 8-16 | Miscellaneous Timings | 273 |
| 8-17 | SPI Timings (20 MHz) | 273 |
| 8-18 | SPI Timings (33 MHz) | 274 |
| 8-19 | SST Timings | 274 |
| 8-20 | PECI Timings | 275 |
| 8-21 | Power Sequencing and Reset Signal Timings | 275 |
| 8-22 | Power Management Timings | 277 |
| 9-1 | PCI Devices and Functions | 294 |
| 9-2 | Fixed I/O Ranges Decoded by Intel® ICH10 | 296 |
| 9-3 | Variable I/O Decode Ranges | 298 |
| 9-4 | Memory Decode Ranges from Processor Perspective | 299 |
| 10-1 | Chipset Configuration Register Memory Map (Memory Space) | 303 |
| 11-1 | PCI Bridge Register Address Map (PCI-PCI—D30:F0) | 355 |
| 12-1 | Gigabit LAN Configuration Registers Address Map (Gigabit LAN —D25:F0) | 371 |
| 12-2 | Gigabit LAN Base Address A Registers Address Map (Gigabit LAN— D25:F0) | 384 |
| 13-1 | LPC Interface PCI Register Address Map (LPC I/F—D31:F0) | 387 |
| 13-2 | DMA Registers | 411 |
| 13-3 | PIC Registers (LPC I/F—D31:F0) | 424 |
| 13-4 | APIC Direct Registers (LPC I/F—D31:F0) | 433 |
| 13-5 | APIC Indirect Registers (LPC I/F—D31:F0) | 433 |

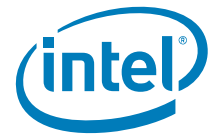

| | | |
|-------|-------------------------------------------------------------------------------------------------------------|-----|
| 13-6 | RTC I/O Registers | 439 |
| 13-7 | RTC (Standard) RAM Bank | 440 |
| 13-8 | Processor Interface PCI Register Address Map (LPC I/F—D31:F0) | 444 |
| 13-9 | Power Management PCI Register Address Map (PM—D31:F0) | 447 |
| 13-10 | APM Register Map | 460 |
| 13-11 | ACPI and Legacy I/O Register Map | 461 |
| 13-12 | TCO I/O Register Address Map | 483 |
| 13-13 | Registers to Control GPIO Address Map | 491 |
| 14-1 | SATA Controller PCI Register Address Map (SATA—D31:F2) | 501 |
| 14-2 | Bus Master IDE I/O Register Address Map | 528 |
| 14-3 | AHCI Register Address Map | 536 |
| 14-4 | Generic Host Controller Register Address Map | 537 |
| 14-5 | Port [5:0] DMA Register Address Map | 545 |
| 15-1 | SATA Controller PCI Register Address Map (SATA—D31:F5) | 563 |
| 15-2 | Bus Master IDE I/O Register Address Map | 580 |
| 16-1 | UHCI Controller PCI Configuration Map | 589 |
| 16-2 | UHCI Controller PCI Register Address Map (USB—D29:F0/F1/F2/F3, D26:F0/F1/F2) | 589 |
| 16-3 | USB I/O Registers | 602 |
| 16-4 | Run/Stop, Debug Bit Interaction SWDBG (Bit 5), Run/Stop (Bit 0) Operation | 605 |
| 17-1 | USB EHCI PCI Register Address Map (USB EHCI—D29:F7, D26:F7) | 611 |
| 17-2 | Enhanced Host Controller Capability Registers | 631 |
| 17-3 | Enhanced Host Controller Operational Register Address Map | 635 |
| 17-4 | Debug Port Register Address Map | 649 |
| 18-1 | Intel® High Definition Audio PCI Register Address Map (Intel® High Definition Audio D27:F0) | 653 |
| 18-2 | Intel® High Definition Audio PCI Register Address Map (Intel® High Definition Audio D27:F0) | 675 |
| 19-1 | SMBus Controller PCI Register Address Map (SMBus—D31:F3) | 703 |
| 19-2 | SMBus I/O and Memory Mapped I/O Register Address Map | 710 |
| 20-1 | PCI Express* Configuration Registers Address Map (PCI Express—D28:F0/F1/F2/F3/F4/F5) | 721 |
| 21-1 | Memory-Mapped Registers | 767 |
| 22-1 | Serial Peripheral Interface (SPI) Register Address Map (SPI Memory Mapped Configuration Registers) | 777 |
| 22-2 | Gigabit LAN SPI Flash Program Register Address Map (GbE LAN Memory Mapped Configuration Registers) | 815 |
| 23-1 | Thermal Sensor Register Address Map | 829 |
| 23-2 | Thermal Memory Mapped Configuration Register Address Map | 838 |

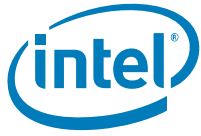

Revision History

| Revision Number | Description | Revision Date |
|-----------------|--------------------------------------------------------------------------------------------------------------------------------------------------------------------------------------------------------------------------------------------------------------------------------------------------------------------------------------------------------------------------------------------------------|----------------|
| -001 | <ul style="list-style-type: none">Initial release. | June 2008 |
| -002 | <ul style="list-style-type: none">Added Intel ICH10 corporate componentsAdded Notes 12 and 13 to Table 2-23, updated signal description for VccGLAN1_5 and VccGLAN3_3 in Table 2-24, and updated GPIO33 and GPIO49 strap definitions in Table 2-25.Updated register descriptions for USBIR1 (Section 10.1.82), USBIR2 (Section 10.1.83), and EHCIIR1 (Section 17.1.30) | September 2008 |
| -003 | <ul style="list-style-type: none">Updated Intel ICH10 corporate components table | October 2008 |



Intel® ICH10 Features

- Direct Media Interface
 - 10 Gb/s each direction, full duplex
 - Transparent to software
- PCI Express*
 - 6 PCI Express root ports
 - Supports PCI Express 1.1
 - Ports 1-4 can be statically configured as 4x1, or 1x4
 - Support for full 2.5 Gb/s bandwidth in each direction per x1 lane
 - Module based Hot-Plug supported (e.g., ExpressCard*)
- PCI Bus Interface
 - Supports PCI Rev 2.3 Specification at 33 MHz
 - Four available PCI REQ/GNT pairs
 - Support for 64-bit addressing on PCI using DAC protocol
- Integrated Serial ATA Host Controller
 - Up to six SATA ports
 - Data transfer rates up to 3.0 Gb/s (300 MB/s).
 - Integrated AHCI controller
- External SATA support
 - Port Disable Capability
- Intel® Matrix Storage Technology
 - Configures the ICH10 SATA controller as a RAID controller supporting RAID 0/1/5/10
- Intel® High Definition Audio Interface
 - PCI Express endpoint
 - Independent Bus Master logic for eight general purpose streams: four input and four output
 - Support four external Codecs
 - Supports variable length stream slots
 - Supports multichannel, 32-bit sample depth, 192 kHz sample rate output
 - Provides mic array support
 - Allows for non-48 kHz sampling output
 - Support for ACPI Device States
 - Low Voltage Mode
- Intel® Quiet System Technology
 - Four TACH signals and three PWM signals
 - Improved algorithms for better performance
- Simple Serial Transport (SST) 1.0 Bus and Platform Environment Control Interface (PECI)
- USB 2.0
 - Six UHCI Host Controllers, supporting up to twelve external ports
 - Two EHCI Host Controllers, supporting up to twelve external ports
 - Two Configuration Options for EHCI Controllers 6+6 and 8+4
 - Per-Port-Disable Capability
 - Includes up to two USB 2.0 High-speed Debug Ports
 - Supports wake-up from sleeping states S1-S4
 - Supports legacy Keyboard/Mouse software
- Integrated Gigabit LAN Controller
 - Integrated ASF Management Controller
 - Network security with System Defense
 - Supports IEEE 802.3
 - LAN Connect Interface (LCI) and Gigabit LAN Connect Interface (GLCI)
 - 10/100/1000 Mbps Ethernet Support
 - Jumbo Frame Support
- Intel® Active Management Technology with System Defense (Corporate Only)
 - Network Outbreak Containment Heuristics
- Intel® I/O Virtualization (VT-d) Support
- Intel® Trusted Execution Technology (Intel TXT) Support (Corporate Only)
- Power Management Logic
 - Supports ACPI 3.0b
 - ACPI-defined power states (C1, C2, C3, C4, S1, S3-S5)
 - ACPI Power Management Timer
 - SMI# generation
 - All registers readable/restorable for proper resume from 0 V suspend states
 - Support for APM-based legacy power management for non-ACPI implementations
- External Glue Integration
 - Integrated Pull-up, Pull-down and Series Termination resistors on processor I/F
 - Integrated Pull-down and Series resistors on USB
- Enhanced DMA Controller
 - Two cascaded 8237 DMA controllers
 - Supports LPC DMA

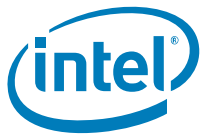

- SMBus
 - Faster speed, up to 100 kbps
 - Flexible SMBus/SMLink architecture to optimize for ASF
 - Provides independent manageability bus through SMLink interface
 - Supports SMBus 2.0 Specification
 - Host interface allows processor to communicate via SMBus
 - Slave interface allows an internal or external Microcontroller to access system resources
 - Compatible with most two-wire components that are also I²C compatible
- High Precision Event Timers
 - Advanced operating system interrupt scheduling
- Timers Based on 82C54
 - System timer, Refresh request, Speaker tone output
- Real-Time Clock
 - 256 Byte battery-backed CMOS RAM
 - Integrated oscillator components
 - Lower Power DC/DC Converter implementation
- System TCO Reduction Circuits
 - Timers to generate SMI# and Reset upon detection of system hang
 - Timers to detect improper processor reset
 - Integrated processor frequency strap logic
 - Supports ability to disable external devices
- Interrupt Controller
 - Supports up to eight PCI interrupt pins
 - Supports PCI 2.3 Message Signaled Interrupts
 - Two cascaded 82C59 with 15 interrupts
 - Integrated I/O APIC capability with 24 interrupts
 - Supports Processor System Bus interrupt delivery
- 1.1 V operation with 1.5 and 3.3 V I/O
 - 5 V tolerant buffers on PCI, USB and selected Legacy signals
- 1.1 V Core Voltage
- Five Integrated Voltage Regulators for different power rails
- Firmware Hub I/F supports BIOS Memory size up to 8 MBytes
- Serial Peripheral Interface (SPI)
 - Supports up to two SPI devices
 - Supports 20 MHz and 33 MHz SPI devices
 - NEW: Dual erase support
- Low Pin Count (LPC) I/F
 - Supports two Master/DMA devices.
 - Support for Security Device (Trusted Platform Module) connected to LPC.
- GPIO
 - TTL, Open-Drain, Inversion
 - GPIO lock down
- NEW: JTAG (Corporate Only)
 - Boundary Scan for testing during board manufacturing
- Package 31x31 mm 676 mBGA

Note: Not all features are available on all ICH10 components. See [Section 1.3](#) for more details.

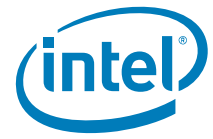

Intel® ICH10 Configuration

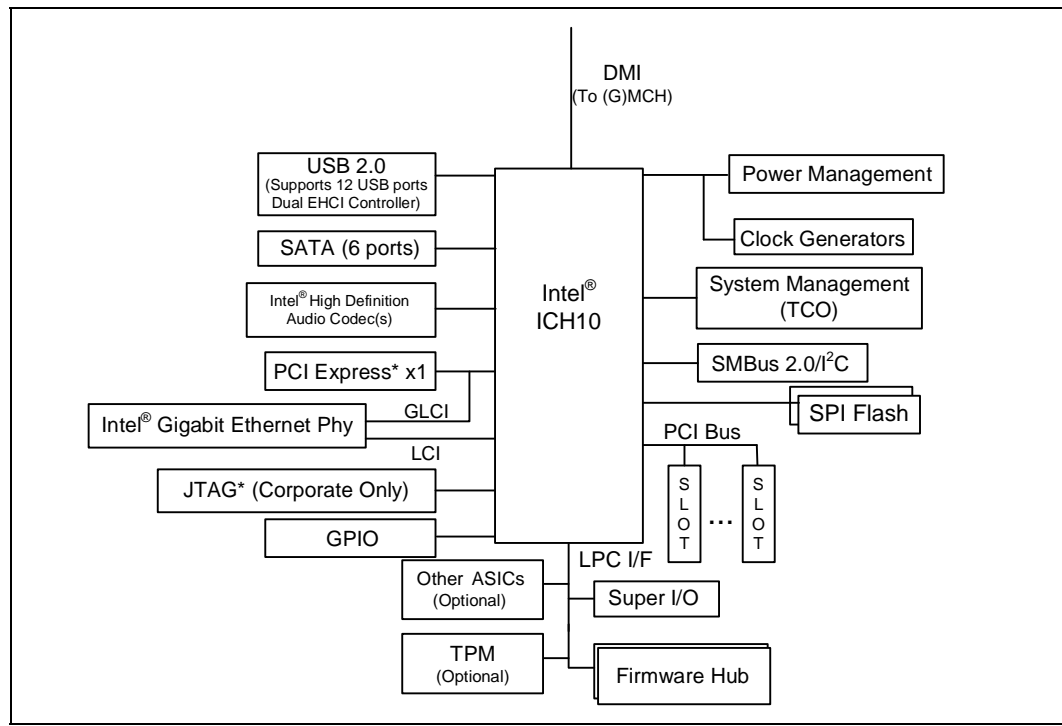

§ §





1 Introduction

This document is intended for Original Equipment Manufacturers and BIOS vendors creating Intel® I/O Controller Hub 10 (ICH10) Family based products. This document is for the following components:

Consumer Family

- Intel® 82801JIB ICH10 Consumer Base (ICH10)
- Intel® 82801JIR ICH10 RAID (ICH10R)

Corporate Family

- Intel® 82801JD ICH10 Corporate Base (ICH10D)
- Intel® 82801JDO ICH10 Digital Office (ICH10DO)

Section 1.3 provides high-level feature differences for the ICH10 Family components.

Note: Throughout this document, ICH10 is used as a general ICH10 term and refers to the Intel 82801JIB ICH10, Intel 82801JIR ICH10R, Intel 82801JD ICH10D, Intel 82801JDO ICH10DO components, unless specifically noted otherwise.

Note: Throughout this document, the term “Consumer Only” refers to information that is for the Intel 82801JIB ICH10 and Intel 82801JIR ICH10R, unless specifically noted otherwise. The term “Corporate Only” refers to information that is for the Intel 82801JD ICH10D and 82801JDO ICH10DO, unless specifically noted otherwise.

1.1 About This Manual

This manual assumes a working knowledge of the vocabulary and principles of PCI Express*, USB, AHCI, SATA, Intel® High Definition Audio (Intel® HD Audio), SMBus, PCI, ACPI, and LPC. Although some details of these features are described within this manual, refer to the individual industry specifications listed in Table 1-1 for the complete details.

Table 1-1. Industry Specifications

| Specification | Location |
|-----------------------------------------------------------------|---------------------------------------------------------------------------------------------------------------------------------------|
| PCI Express* Base Specification, Revision 1.1 | http://www.pcisig.com/specifications |
| Low Pin Count Interface Specification, Revision 1.1 (LPC) | http://developer.intel.com/design/chipsets/industry/lpc.htm |
| System Management Bus Specification, Version 2.0 (SMBus) | http://www.smbus.org/specs/ |
| PCI Local Bus Specification, Revision 2.3 (PCI) | http://www.pcisig.com/specifications |
| PCI Power Management Specification, Revision 1.1 | http://www.pcisig.com/specifications |
| Universal Serial Bus Specification (USB), Revision 2.0 | http://www.usb.org/developers/docs |
| Advanced Configuration and Power Interface, Version 3.0b (ACPI) | http://www.acpi.info/spec.htm |
| Universal Host Controller Interface, Revision 1.1 (UHCI) | http://developer.intel.com/design/USB/UHCI11D.htm |

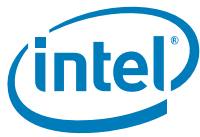

Table 1-1. Industry Specifications

| Specification | Location |
|----------------------------------------------------------------------------------------------------------------------------------------------------------------------------------------------------------------------------------|-----------------------------------------------------------------------------------------------------------------------------------------------------------------------------------------------------------------------------------------------------------------------------------------------------------|
| Enhanced Host Controller Interface Specification for Universal Serial Bus, Revision 1.0 (EHCI) | http://developer.intel.com/technology/usb/ehcispec.htm |
| Serial ATA Specification, Revision 2.5 | http://www.serialata.org/specifications.asp |
| Serial ATA II: Extensions to Serial ATA 1.0, Revision 1.0 | http://www.serialata.org/specifications.asp |
| Serial ATA II Cables and Connectors Volume 2 Gold | http://www.serialata.org/specifications.asp |
| Alert Standard Format Specification, Version 1.03 | http://www.dmtf.org/standards/asf |
| IEEE 802.3 Fast Ethernet | http://standards.ieee.org/getieee802/ |
| AT Attachment - 6 with Packet Interface (ATA/ATAPI - 6) | http://T13.org (T13 1410D) |
| IA-PC HPET (High Precision Event Timers) Specification, Revision 0.98a | http://www.intel.com/hardware/design/hpetspec.htm |
| TPM Specification 1.02, Level 2 Revision 103 | http://www.trustedcomputinggroup.org/specs/TPM |
| Intel® I/O Controller Hub 10 (ICH10) Family Specification Update | http://www.intel.com/design/chipsets/specupdt/319974.pdf |
| Intel® I/O Controller Hub 10 (ICH10) Family Thermal and Mechanical Design Guidelines | http://www.intel.com/design/chipsets/designex/319975.pdf |
| Intel® ICH10 EDS Spec. Update, Latest Revision | <p>Intel Users: http://esales.intel.com Search for "ICH10"</p> <p>External Users: http://www.intel.com/ibl Chipsets > South Bridges/IO Controller Hub > ICH Family > ICH10 > Technical</p> |
| <p><i>Intel® ICH10 Chipset Mechanical Ballout File, Latest Revision</i></p> <p><i>Intel® ICH10 Family XOR Chains In-Circuit Tester Package, Revision TBD</i></p> <p><i>Intel® ICH10 IBIS Model, Revision Latest Revision</i></p> | <p>Intel Users: http://esales.intel.com Search for "ICH10"</p> <p>External Users: http://www.intel.com/ibl Chipsets > South Bridges/IO Controller Hub > ICH Family > ICH10 > Technical</p> |



Chapter 1. Introduction

[Chapter 1](#) introduces the ICH10 and provides information on manual organization and gives a general overview of the ICH10.

Chapter 2. Signal Description

[Chapter 2](#) provides a block diagram of the ICH10 and a detailed description of each signal. Signals are arranged according to interface and details are provided as to the drive characteristics (Input/Output, Open-drain, etc.) of all signals.

Chapter 3. Intel® ICH10 Pin States

[Chapter 3](#) provides a complete list of signals, their associated power well, their logic level in each suspend state, and their logic level before and after reset.

Chapter 4. Intel® ICH10 and System Clock Domains

[Chapter 4](#) provides a list of each clock domain associated with the ICH10 in an ICH10 based system.

Chapter 5. Functional Description

[Chapter 5](#) provides a detailed description of the functions in the ICH10. All PCI buses, devices and functions in this manual are abbreviated using the following nomenclature; Bus:Device:Function. This manual abbreviates buses as B0 and B1, devices as D8, D27, D28, D29, D30 and D31 and functions as F0, F1, F2, F3, F4, F5, F6 and F7. For example Device 31 Function 0 is abbreviated as D31:F0, Bus 1 Device 8 Function 0 is abbreviated as B1:D8:F0. Generally, the bus number will not be used, and can be considered to be Bus 0. Note that the ICH10's external PCI bus is typically Bus 1, but may be assigned a different number depending upon system configuration.

Chapter 6. Ballout Definition

[Chapter 6](#) provides a table of each signal and its ball assignment in the 676-mBGA package.

Chapter 7. Package Information

[Chapter 7](#) provides drawings of the physical dimensions and characteristics of the 676-mBGA package.

Chapter 8. Electrical Characteristics

[Chapter 8](#) provides all AC and DC characteristics including detailed timing diagrams.

Chapter 9. Register and Memory Mappings

[Chapter 9](#) provides an overview of the registers, fixed I/O ranges, variable I/O ranges and memory ranges decoded by the ICH10.

Chapter 10. Chipset Configuration Registers

[Chapter 10](#) provides a detailed description of all registers and base functionality that is related to chipset configuration and not a specific interface (such as LPC, PCI, or PCI Express*). It contains the root complex register block, which describes the behavior of the upstream internal link.

Chapter 11. PCI-to-PCI Bridge Registers

[Chapter 11](#) provides a detailed description of all registers that reside in the PCI-to-PCI bridge. This bridge resides at Device 30, Function 0 (D30:F0).

Chapter 12. Integrated LAN Controller Registers

[Chapter 12](#) provides a detailed description of all registers that reside in the ICH10's integrated LAN controller. The integrated LAN Controller resides at Device 25, Function 0 (D25:F0).

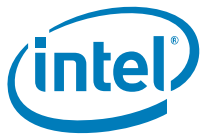
**Chapter 13. LPC Bridge Registers**

[Chapter 13](#) provides a detailed description of all registers that reside in the LPC bridge. This bridge resides at Device 31, Function 0 (D31:F0). This function contains registers for many different units within the ICH10 including DMA, Timers, Interrupts, Processor Interface, GPIO, Power Management, System Management and RTC.

Chapter 14. SATA Controller Registers

[Chapter 14](#) provides a detailed description of all registers that reside in the SATA controller #1. This controller resides at Device 31, Function 2 (D31:F2).

Chapter 15. SATA Controller Registers

[Chapter 15](#) provides a detailed description of all registers that reside in the SATA controller #2. This controller resides at Device 31, Function 5 (D31:F5).

Chapter 16. UHCI Controller Registers

[Chapter 16](#) provides a detailed description of all registers that reside in the six UHCI host controllers. These controllers reside at Device 29, Functions 0, 1, 2, and 3 (D29:F0/F1/F2/F3) and Device 26, Function 0, 1 and 2 (D26:F0/F1/F2).

Chapter 17. EHCI Controller Registers

[Chapter 17](#) provides a detailed description of all registers that reside in the two EHCI host controllers. These controllers reside at Device 29, Function 7 (D29:F7) and Device 26, Function 7 (D26:F7).

Chapter 18. SMBus Controller Registers

[Chapter 19](#) provides a detailed description of all registers that reside in the SMBus controller. This controller resides at Device 31, Function 3 (D31:F3).

Chapter 19. Intel® High Definition Audio Controller Registers

[Chapter 18](#) provides a detailed description of all registers that reside in the Intel High Definition Audio controller. This controller resides at Device 27, Function 0 (D27:F0).

Chapter 20. PCI Express* Port Controller Registers

[Chapter 20](#) provides a detailed description of all registers that reside in the PCI Express controller. This controller resides at Device 28, Functions 0 to 5 (D30:F0-F5).

Chapter 21. High Precision Event Timers Registers

[Chapter 21](#) provides a detailed description of all registers that reside in the multimedia timer memory mapped register space.

Chapter 22. Serial Peripheral Interface Registers

[Chapter 22](#) provides a detailed description of all registers that reside in the SPI memory mapped register space.

Chapter 23. Thermal Sensors

[Chapter 23](#) provides a detailed description of all registers that reside in the thermal sensors PCI configuration space. The registers reside at Device 31, Function 6 (D31:F6).



1.2 Overview

The ICH10 provides extensive I/O support. Functions and capabilities include:

- *PCI Express* Base Specification*, Revision 1.1 support
- *PCI Local Bus Specification*, Revision 2.3 support for 33 MHz PCI operations (supports up to four Req/Gnt pairs).
- ACPI Power Management Logic Support, Revision 3.0b
- Enhanced DMA controller, interrupt controller, and timer functions
- Integrated Serial ATA host controllers with independent DMA operation on up to six ports.
- USB host interface with support for up to twelve USB ports; six UHCI host controllers; two EHCI high-speed USB 2.0 Host controllers
- Integrated 10/100/1000 Gigabit Ethernet MAC with System Defense
- *System Management Bus (SMBus) Specification*, Version 2.0 with additional support for I²C devices
- Supports Intel® High Definition Audio
- Supports Intel® Matrix Storage Technology
- Supports Intel® Active Management Technology (Corporate Only)
- Supports Intel® Virtualization Technology for Directed I/O
- Supports Intel® Trusted Execution Technology (Corporate Only)
- Low Pin Count (LPC) interface
- Firmware Hub (FWH) interface support
- Serial Peripheral Interface (SPI) support
- Intel® Quiet System Technology
- Integrated TPM 1.2 (Corporate Only)
- JTAG Boundary Scan support (Corporate Only)

The Intel ICH10 incorporates a variety of PCI devices and functions, as shown in [Table 1-2](#). They are divided into seven logical devices. The first is the DMI-To-PCI bridge (Device 30). The second device (Device 31) contains most of the standard PCI functions that always existed in the PCI-to-ISA bridges (South Bridges), such as the Intel PIIX4. The third and fourth (Device 29 and Device 26) are the USB host controller devices. The fifth (Device 28) is PCI Express device. The sixth (Device 27) is the HD Audio controller device, and the seventh (Device 25) is the Gigabit Ethernet controller device.

Table 1-2. PCI Devices and Functions (Sheet 1 of 2)

| Bus:Device:Function | Function Description |
|------------------------------|---------------------------------|
| Bus 0: Device 30: Function 0 | DMI-to-PCI Bridge |
| Bus 0: Device 31: Function 0 | LPC Controller ¹ |
| Bus 0: Device 31: Function 2 | SATA Controller #1 |
| Bus 0: Device 31: Function 5 | SATA Controller #2 ³ |
| Bus 0: Device 31: Function 6 | Thermal Subsystem |
| Bus 0: Device 31: Function 3 | SMBus Controller |
| Bus 0: Device 29: Function 0 | USB FS/LS UHCI Controller #1 |

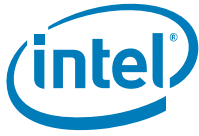
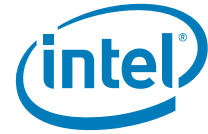

Table 1-2. PCI Devices and Functions (Sheet 2 of 2)

| Bus:Device:Function | Function Description |
|------------------------------|-----------------------------------------------------|
| Bus 0: Device 29: Function 1 | USB FS/LS UHCI Controller #2 |
| Bus 0: Device 29: Function 2 | USB FS/LS UHCI Controller #3 |
| Bus 0: Device 29: Function 3 | USB FS/LS UHCI Controller #6 ² |
| Bus 0: Device 29: Function 7 | USB HS EHCI Controller #1 |
| Bus 0: Device 26: Function 0 | USB FS/LS UHCI Controller #4 |
| Bus 0: Device 26: Function 1 | USB FS/LS UHCI Controller #5 |
| Bus 0: Device 26: Function 2 | USB FS/LS UHCI Controller #6 ² |
| Bus 0: Device 26: Function 7 | USB HS EHCI Controller #2 |
| Bus 0: Device 28: Function 0 | PCI Express* Port 1 |
| Bus 0: Device 28: Function 1 | PCI Express Port 2 |
| Bus 0: Device 28: Function 2 | PCI Express Port 3 |
| Bus 0: Device 28: Function 3 | PCI Express Port 4 |
| Bus 0: Device 28: Function 4 | PCI Express Port 5 |
| Bus 0: Device 28: Function 5 | PCI Express Port 6 |
| Bus 0: Device 27: Function 0 | Intel [®] High Definition Audio Controller |
| Bus 0: Device 25: Function 0 | Gigabit Ethernet Controller |

NOTES:

1. The PCI-to-LPC bridge contains registers that control LPC, Power Management, System Management, GPIO, Processor Interface, RTC, Interrupts, Timers, and DMA
2. Device 26:Function 2 maybe configured as Device 29:Function 3 during BIOS Post.
3. SATA Controller 2 is only visible when D31:F2 CC.SCC=01h.



1.2.1 Capability Overview

The following sub-sections provide an overview of the ICH10 capabilities.

Direct Media Interface (DMI)

Direct Media Interface (DMI) is the chip-to-chip connection between the Memory Controller Hub / Graphics Memory Controller Hub ((G)MCH) and I/O Controller Hub 10 (ICH10). This high-speed interface integrates advanced priority-based servicing allowing for concurrent traffic and true isochronous transfer capabilities. Base functionality is completely software-transparent, permitting current and legacy software to operate normally.

PCI Express* Interface

The ICH10 provides up to 6 PCI Express Root Ports, supporting the *PCI Express Base Specification*, Revision 1.1. Each Root Port supports 2.5 GB/s bandwidth in each direction (5 GB/s concurrent). PCI Express Root Ports 1–4 can be statically configured as four x1 Ports or ganged together to form one x4 port. Ports 5 and 6 can only be used as two x1 ports.

Note: The integrated Gigabit Ethernet controllers data lines for 1000 MB/s speed are multiplexed with PCI Express* Root Port 6 and therefore unavailable if a Gigabit Ethernet PHY is connected. The use of a 10/100 MB/s PHY does not consume PCI Express Root Port 6 and therefore the port is available to be utilized as a x1 Port.

Serial ATA (SATA) Controller

The ICH10 has two integrated SATA host controllers that support independent DMA operation on up to six ports and supports data transfer rates of up to 3.0 GB/s (300 MB/s). The SATA controller contains two modes of operation – a legacy mode using I/O space, and an AHCI mode using memory space. Software that uses legacy mode will not have AHCI capabilities.

The ICH10 supports the *Serial ATA Specification*, Revision 1.0a. The ICH10 also supports several optional sections of the Serial ATA II: Extensions to *Serial ATA 1.0 Specification*, Revision 1.0 (AHCI support is required for some elements).

AHCI

The ICH10 provides hardware support for Advanced Host Controller Interface (AHCI), a new programming interface for SATA host controllers. Platforms supporting AHCI may take advantage of performance features such as no master/slave designation for SATA devices—each device is treated as a master—and hardware-assisted native command queuing. AHCI also provides usability enhancements such as Hot-Plug. AHCI requires appropriate software support (e.g., an AHCI driver) and for some features, hardware support in the SATA device or additional platform hardware. See [Section 1.3](#) for details on component feature availability.

Intel® Matrix Storage Technology

The ICH10 provides support for Intel® Matrix Storage Technology, providing both AHCI (see above for details on AHCI) and integrated RAID functionality. The industry-leading RAID capability provides high-performance RAID 0, 1, 5, and 10 functionality on up to 6 SATA ports of ICH10. Matrix RAID support is provided to allow multiple RAID levels to be combined on a single set of hard drives, such as RAID 0 and RAID 1 on two disks. Other RAID features include hot spare support, SMART alerting, and RAID 0 auto replace. Software components include an Option ROM for pre-boot configuration and



boot functionality, a Microsoft Windows* compatible driver, and a user interface for configuration and management of the RAID capability of ICH10. See [Section 1.3](#) for details on component feature availability.

PCI Interface

The ICH10 PCI interface provides a 33 MHz, Revision 2.3 implementation. The ICH10 integrates a PCI arbiter that supports up to four external PCI bus masters in addition to the internal ICH10 requests. This allows for combinations of up to four PCI down devices and PCI slots.

Low Pin Count (LPC) Interface

The ICH10 implements an LPC Interface as described in the *LPC 1.1 Specification*. The Low Pin Count (LPC) bridge function of the ICH10 resides in PCI Device 31:Function 0. In addition to the LPC bridge interface function, D31:F0 contains other functional units including DMA, interrupt controllers, timers, power management, system management, GPIO, and RTC.

Serial Peripheral Interface (SPI)

The ICH10 implements an SPI Interface as an alternative interface for the BIOS flash device. An SPI flash device can be used as a replacement for the FWH, and is required to support Gigabit Ethernet, Intel® Active Management Technology, and integrated Intel® Quiet System Technology. The ICH10 supports up to two SPI flash devices with speed up to 33 MHz using two chip select pins.

Compatibility Modules (DMA Controller, Timer/Counters, Interrupt Controller)

The DMA controller incorporates the logic of two 82C37 DMA controllers, with seven independently programmable channels. Channels 0–3 are hardwired to 8-bit, count-by-byte transfers, and channels 5–7 are hardwired to 16-bit, count-by-word transfers. Any two of the seven DMA channels can be programmed to support fast Type-F transfers. Channel 4 is reserved as a generic bus master request.

The ICH10 supports LPC DMA, which is similar to ISA DMA, through the ICH10's DMA controller. LPC DMA is handled through the use of the LDRQ# lines from peripherals and special encoding on LAD[3:0] from the host. Single, Demand, Verify, and Increment modes are supported on the LPC interface.

The timer/counter block contains three counters that are equivalent in function to those found in one 82C54 programmable interval timer. These three counters are combined to provide the system timer function, and speaker tone. The 14.31818 MHz oscillator input provides the clock source for these three counters.

The ICH10 provides an ISA-Compatible Programmable Interrupt Controller (PIC) that incorporates the functionality of two, 82C59 interrupt controllers. The two interrupt controllers are cascaded so that 14 external and two internal interrupts are possible. In addition, the ICH10 supports a serial interrupt scheme.

All of the registers in these modules can be read and restored. This is required to save and restore system state after power has been removed and restored to the platform.

Advanced Programmable Interrupt Controller (APIC)

In addition to the standard ISA compatible Programmable Interrupt controller (PIC) described in the previous section, the ICH10 incorporates the Advanced Programmable Interrupt Controller (APIC).



Universal Serial Bus (USB) Controllers

The ICH10 contains up to two Enhanced Host Controller Interface (EHCI) host controllers that support USB high-speed signaling. High-speed USB 2.0 allows data transfers up to 480 Mb/s which is 40 times faster than full-speed USB. The ICH10 also contains up to six Universal Host Controller Interface (UHCI) controllers that support USB full-speed and low-speed signaling.

The ICH10 supports up to twelve USB 2.0 ports. All twelve ports are high-speed, full-speed, and low-speed capable. ICH10's port-routing logic determines whether a USB port is controlled by one of the UHCI or EHCI controllers. See [Section 5.18](#) and [Section 5.19](#) for details.

Gigabit Ethernet Controller

The Gigabit Ethernet Controller provides a system interface via a PCI function. The controller provides a full memory-mapped or IO mapped interface along with a 64 bit address master support for systems using more than 4 GB of physical memory and DMA (Direct Memory Addressing) mechanisms for high performance data transfers. Its bus master capabilities enable the component to process high-level commands and perform multiple operations; this lowers processor utilization by off-loading communication tasks from the processor. Two large configurable transmit and receive FIFOs (up to 20 KB each) help prevent data underruns and overruns while waiting for bus accesses. This enables the integrated LAN controller to transmit data with minimum interframe spacing (IFS).

The LAN controller can operate at multiple speeds (10/100/1000 MB/s) and in either full duplex or half duplex mode. In full duplex mode the LAN controller adheres to the *IEEE 802.3x Flow Control* Specification. Half duplex performance is enhanced by a proprietary collision reduction mechanism. See [Section 5.3](#) for details.

RTC

The ICH10 contains a Motorola MC146818A-compatible real-time clock with 256 bytes of battery-backed RAM. The real-time clock performs two key functions: keeping track of the time of day and storing system data, even when the system is powered down. The RTC operates on a 32.768 KHz crystal and a 3 V battery.

The RTC also supports two lockable memory ranges. By setting bits in the configuration space, two 8-byte ranges can be locked to read and write accesses. This prevents unauthorized reading of passwords or other system security information.

The RTC also supports a date alarm that allows for scheduling a wake up event up to 30 days in advance, rather than just 24 hours in advance.

GPIO

Various general purpose inputs and outputs are provided for custom system design. The number of inputs and outputs varies depending on ICH10 configuration.

Enhanced Power Management

The ICH10's power management functions include enhanced clock control and various low-power (suspend) states (e.g., Suspend-to-RAM and Suspend-to-Disk). A hardware-based thermal management circuit permits software-independent entrance to low-power states. The ICH10 contains full support for the *Advanced Configuration and Power Interface (ACPI) Specification, Revision 3.0a*.



Intel® Active Management Technology (Intel® AMT) (Not available on all ICH10 components)

Intel® Active Management Technology is the next generation of client manageability via the wired network. Intel AMT is a set of advanced manageability features developed as a direct result of IT customer feedback gained through Intel market research. With the new implementation of System Defense in ICH10, the advanced manageability feature set of Intel AMT is further enhanced. See [Section 1.3](#) for details on component feature availability.

Manageability

In addition to Intel AMT, ICH10 integrates several functions designed to manage the system and lower the total cost of ownership (TCO) of the system. These system management functions are designed to report errors, diagnose the system, and recover from system lockups without the aid of an external microcontroller.

- **TCO Timer.** The ICH10's integrated programmable TCO timer is used to detect system locks. The first expiration of the timer generates an SMI# that the system can use to recover from a software lock. The second expiration of the timer causes a system reset to recover from a hardware lock.
- **Processor Present Indicator.** The ICH10 looks for the processor to fetch the first instruction after reset. If the processor does not fetch the first instruction, the ICH10 will reboot the system.
- **ECC Error Reporting.** When detecting an ECC error, the host controller has the ability to send one of several messages to the ICH10. The host controller can instruct the ICH10 to generate either an SMI#, NMI, SERR#, or TCO interrupt.
- **Function Disable.** The ICH10 provides the ability to disable the following integrated functions: LAN, USB, LPC, Intel HD Audio, SATA, PCI Express or SMBus. Once disabled, these functions no longer decode I/O, memory, or PCI configuration space. Also, no interrupts or power management events are generated from the disabled functions.
- **Intruder Detect.** The ICH10 provides an input signal (INTRUDER#) that can be attached to a switch that is activated by the system case being opened. The ICH10 can be programmed to generate an SMI# or TCO interrupt due to an active INTRUDER# signal.

System Management Bus (SMBus 2.0)

The ICH10 contains an SMBus Host interface that allows the processor to communicate with SMBus slaves. This interface is compatible with most I²C devices. Special I²C commands are implemented.

The ICH10's SMBus host controller provides a mechanism for the processor to initiate communications with SMBus peripherals (slaves). Also, the ICH10 supports slave functionality, including the Host Notify protocol. Hence, the host controller supports eight command protocols of the SMBus interface (see *System Management Bus (SMBus) Specification, Version 2.0*): Quick Command, Send Byte, Receive Byte, Write Byte/Word, Read Byte/Word, Process Call, Block Read/Write, and Host Notify.

ICH10's SMBus also implements hardware-based Packet Error Checking for data robustness and the Address Resolution Protocol (ARP) to dynamically provide address to all SMBus devices.



Intel® High Definition Audio Controller

The *Intel® High Definition Audio Specification* defines a digital interface that can be used to attach different types of codecs, such as audio and modem codecs. The ICH10 Intel® HD Audio controller supports up to 4 codecs. The link can operate at either 3.3 V or 1.5 V.

With the support of multi-channel audio stream, 32-bit sample depth, and sample rate up to 192 kHz, the Intel® HD Audio controller provides audio quality that can deliver CE levels of audio experience. On the input side, the ICH10 adds support for an array of microphones.

Intel® Quiet System Technology (Intel® QST)

The ICH10 integrates four fan speed sensors (four TACH signals) and 3 fan speed controllers (three Pulse Width Modulator signals), which enables monitoring and controlling up to four fans on the system. With the new implementation of the single-wire Simple Serial Transport (SST) 1.0 bus and Platform Environmental Control Interface (PECI), the ICH10 provides an easy way to connect to SST-based thermal sensors and access the processor thermal data. In addition, coupled with the new sophisticated fan speed control algorithms, Intel® QST provides effective thermal and acoustic management for the platform.

Note: Intel® Quiet System Technology functionality requires a correctly configured system, including an appropriate (G)MCH with Intel ME, Intel ME firmware, and system BIOS support.

Intel® Trusted Platform Module (Corporate Only)

The Intel Trusted Platform Module (Intel® TPM) implementation consists of firmware, Intel® Management Engine resources and dedicated hardware within the ICH and the (G)MCH. The Intel TPM supports all requirements of the TPM Specification Version 1.2, Revision 103, as published by the Trusted Computing Group. The Intel TPM behaves like a discrete TPM device, and can support third party applications, as well as Microsoft* specific functionality in the Windows Vista* OS.

Note: Intel TPM functionality requires a correctly configured system, including an appropriate (G)MCH with Intel Management Engine firmware, ICH10 and SPI Flash.

JTAG Boundary-Scan (Corporate Only)

ICH10 adds the industry standard JTAG interface and enables Boundary-Scan in place of the XOR chains used in previous generations of the ICH. Boundary-Scan can be used to ensure device connectivity during the board manufacturing process. The JTAG interface allows system manufacturers to improve efficiency by using industry available tools to test the ICH on an assembled board. Since JTAG is a serial interface, it eliminates the need to create probe points for every pin in an XOR chain. This eases pin breakout and trace routing and simplifies the interface between the system and a bed-of-nails tester.

Note: Contact your local Intel Field Sales Representative for additional information about JTAG usage on ICH10.



1.3 Intel® ICH10 Family High-Level Component Differences

Table 1-3. Intel® ICH10 Components

| Feature | | Consumer | | Corporate | |
|----------------------------------------------------|-----------------------|---------------------|------------------|----------------------|----------------------|
| | | ICH10 | ICH10R | ICH10D | ICH10DO |
| Component Name | | ICH10 Consumer Base | ICH10 RAID | ICH10 Corporate Base | ICH10 Digital Office |
| Intel® Turbo Memory Support | | No | Yes | No | No |
| Intel® Matrix Storage Technology | AHCI | No ³ | Yes | Yes | Yes |
| | RAID 0/1/5/10 Support | No | Yes | No | Yes |
| Intel® Active Management Technology Release 5.0 | Basic | No | No | Yes | No |
| | Professional | No | No | No | Yes |
| Intel® Trusted Platform Module (Intel® TPM) | | No | No | Yes | Yes |
| Wake on VoIP | | Yes ⁴ | Yes ⁴ | No | No |
| Intel® Viiiv™ Processor Technology Support | | Yes | Yes | No | No |
| Intel® Remote Wake Technology (Intel® RWT) Support | | Yes | Yes | No | No |
| JTAG Boundary Scan | | No | No | Yes | Yes |

NOTES:

1. Contact your local Intel Field Sales Representative for currently available ICH10 components.
2. Table above shows feature difference between ICH10 components. If a feature is not listed in the table it is considered a Base feature that is included in all components.
3. ICH10 Consumer Base provides hardware support for AHCI functionality when enabled by appropriate system configuration and software driver.
4. Wake on VoIP support provided by Intel® Remote Wake Technology (Intel® RWT) Support.
5. All components support 6 SATA, 6 PCIe*, and 14 USB ports.





2 Signal Description

This chapter provides a detailed description of each signal. The signals are arranged in functional groups according to their associated interface.

The “#” symbol at the end of the signal name indicates that the active, or asserted state occurs when the signal is at a low voltage level. When “#” is not present, the signal is asserted when at the high voltage level.

The following notations are used to describe the signal type:

| | |
|-------------|---------------------------------------------|
| I | Input Pin |
| O | Output Pin |
| OD O | Open-drain Output Pin. |
| I/OD | Bi-directional Input/Open-drain Output Pin. |
| I/O | Bi-directional Input / Output Pin. |

The “Type” for each signal is indicative of the functional operating mode of the signal. Unless otherwise noted in [Section 3.2](#) or [Section 3.3](#), a signal is considered to be in the functional operating mode after RTCRST# deasserts for signals in the RTC well, after RSMRST# deasserts for signals in the suspend well, after PWROK asserts for signals in the core well, and after LAN_RST# deasserts for signals in the LAN well.

Figure 2-1. Intel® ICH10 Interface Signals Block Diagram

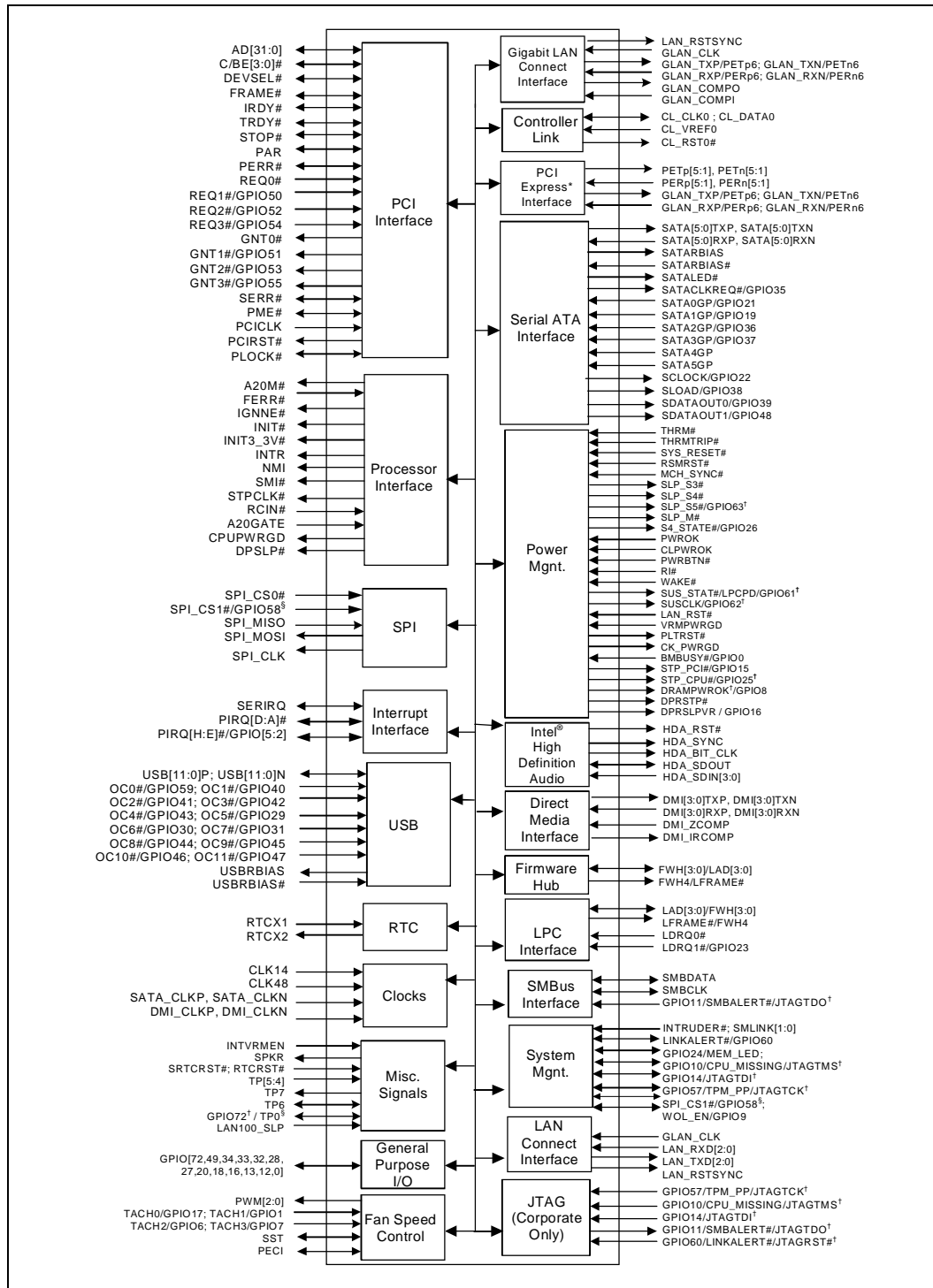

NOTES:

- § symbol indicates a particular use of a pin is Consumer Only.
- † symbol indicates a particular use of a pin is Corporate Only.



2.1 Direct Media Interface (DMI) to Host Controller

Table 2-1. Direct Media Interface Signals

| Name | Type | Description |
|---------------------|------|-------------------------------------------------------------------------------------------------|
| DMI0TXP, DMI0TXN | 0 | Direct Media Interface Differential Transmit Pair 0 |
| DMI0RXP, DMI0RXN | 1 | Direct Media Interface Differential Receive Pair 0 |
| DMI1TXP, DMI1TXN | 0 | Direct Media Interface Differential Transmit Pair 1 |
| DMI1RXP, DMI1RXN | 1 | Direct Media Interface Differential Receive Pair 1 |
| DMI2TXP, DMI2TXN | 0 | Direct Media Interface Differential Transmit Pair 2 |
| DMI2RXP, DMI2RXN | 1 | Direct Media Interface Differential Receive Pair 2 |
| DMI3TXP, DMI3TXN | 0 | Direct Media Interface Differential Transmit Pair 3 |
| DMI3RXP, DMI3RXN | 1 | Direct Media Interface Differential Receive Pair 3 |
| DMI_ZCOMP | 1 | Impedance Compensation Input: Determines DMI input impedance. |
| DMI_IRCOMP | 0 | Impedance/Current Compensation Output: Determines DMI output impedance and bias current. |



2.2 PCI Express* Interface

Table 2-2. PCI Express* Signals

| Name | Type | Description |
|-------------------------------------------|------|------------------------------------------------------------------------------------------------------------------------------------------------------------------------------------------------|
| PETp1, PETn1 | O | PCI Express* Differential Transmit Pair 1 |
| PERp1, PERn1 | I | PCI Express Differential Receive Pair 1 |
| PETp2, PETn2 | O | PCI Express Differential Transmit Pair 2 |
| PERp2, PERn2 | I | PCI Express Differential Receive Pair 2 |
| PETp3, PETn3 | O | PCI Express Differential Transmit Pair 3 |
| PERp3, PERn3 | I | PCI Express Differential Receive Pair 3 |
| PETp4, PETn4 | O | PCI Express Differential Transmit Pair 4 |
| PERp4, PERn4 | I | PCI Express Differential Receive Pair 4 |
| PETp5, PETn5 | O | PCI Express Differential Transmit Pair 5 |
| PERp5, PERn5 | I | PCI Express Differential Receive Pair 5 |
| PETp6/ GLAN_TXp, PETn6/ GLAN_TXn | O | PCI Express Differential Transmit Pair 6: The differential pair will function as the Gigabit LAN Connect Interface transmit pair when the integrated Gigabit LAN controller is enabled. |
| PERp6/ GLAN_RXp, PERn6/ GLAN_RXn | I | PCI Express Differential Receive Pair 6: The differential pair will function as the Gigabit LAN Connect Interface receive pair when the integrated Gigabit LAN controller is enabled. |

2.3 LAN Connect Interface

Table 2-3. LAN Connect Interface Signals

| Name | Type | Description |
|--------------|------|----------------------------------------------------------------------------------------------------------------------------------------------------------------------------------------------------------------------------------------------------|
| GLAN_CLK | I | Gigabit LAN Input Clock: Clock driven by the Platform LAN Connect device. The frequency will vary depending on link speed. NOTE: The clock is shared between the LAN Connect Interface and the Gigabit LAN Connect Interface. |
| LAN_RXD[2:0] | I | Received Data: The Platform LAN Connect device uses these signals to transfer data and control information to the integrated LAN controller. These signals have integrated weak pull-up resistors. |



Table 2-3. LAN Connect Interface Signals

| Name | Type | Description |
|---------------------------|------|----------------------------------------------------------------------------------------------------------------------------------------------------------------------------------------------------------------------------------------------------------------------------------------------------------------------------------------------------------------------------------------------------------------------|
| LAN_TXD[2:0] | O | Transmit Data: The integrated LAN controller uses these signals to transfer data and control information to the Platform LAN Connect component. |
| LAN_RSTSYNC | O | LAN Reset/Sync: This is the reset/sync signal from the LAN Connect Interface to the physical device. The Platform LAN Connect device's Reset and Sync signals are multiplexed onto this pin. NOTE: The signal is shared between LAN Connect Interface and Gigabit LAN Connect Interface. |
| LAN_PHY_PWR_CTRL / GPIO12 | O | LAN PHY Power Control: This signal may optionally be connected to a switch to turn 3.3 V PHY power off when LAN is disabled for additional power savings. This capability is configured in the NVM. When using an 82567 PHY solution, the LAN_PHY_PWR_CTRL signal should be connected to the PHY's LAN_DISABLE_N pin for a hardware based LAN disable mechanism. Signal can instead be used as GPIO12. |

2.4 Gigabit LAN Connect Interface

Table 2-4. Gigabit LAN Connect Interface Signals

| Name | Type | Description |
|-----------------------------------|------|---------------------------------------------------------------------------------------------------------------------------------------------------------------------------------------------------------------------------------------------------------------------------------------------------------------|
| GLAN_CLK | I | Gigabit LAN Input Clock: Clock driven by the Platform LAN Connect device. The frequency will vary depending on link speed. NOTE: The clock is shared between the LAN Connect Interface and the Gigabit LAN Connect Interface. |
| GLAN_TXp/PETp6; GLAN_TXn/PETn6 | O | Gigabit LAN Differential Transmit Pair. Can be instead used as PCI Express port 6 differential transmit pair. |
| GLAN_RXp/PERp6; GLAN_RXn/PERn6 | I | Gigabit LAN Differential Receive Pair. Can be instead used as PCI Express port 6 differential receive pair. |
| GLAN_COMPO | O | Impedance Compensation Output pad: Determines Gigabit LAN Connect Interface output impedance and bias current. |
| GLAN_COMPI | I | Impedance Compensation Input pad: Determines Gigabit LAN Connect Interface input impedance. |
| LAN_RSTSYNC | O | LAN Reset/Sync: This is the reset/sync signal from the Gigabit LAN interface to the physical device. The Platform LAN Connect device's Reset and Sync signals are multiplexed onto this pin. NOTE: The signal is shared between LAN Connect Interface and Gigabit LAN Connect Interface. |



2.5 Firmware Hub Interface

Table 2-5. Firmware Hub Interface Signals

| Name | Type | Description |
|----------------------------|------|---------------------------------------------------------------------------------------------------|
| FWH[3:0] / LAD[3:0] | I/O | Firmware Hub Signals. These signals are multiplexed with the LPC address signals. |
| FWH4 / LFRAME# | O | Firmware Hub Signals. This signal is multiplexed with the LPC LFRAME# signal. |
| INIT3_3V# | O | Initialization 3.3 V: This is the identical 3.3 V copy of INIT# intended for Firmware Hub. |

2.6 PCI Interface

Table 2-6. PCI Interface Signals (Sheet 1 of 3)

| Name | Type | Description | | | | | | | | | | | | | | | | | | | | | | |
|-------------------|-----------------------------|---------------------------------------------------------------------------------------------------------------------------------------------------------------------------------------------------------------------------------------------------------------------------------------------------------------------------------------------------------------------------------------------------------------------------------------------------------------------------------------------------------------------------------------------------------------------------------------------------------------------------------------------------------------------------------------------------------------------------------------------------------------------------------------------------------------------------------------------------------------------------------------------------------------------------------------------------------------------------------------------------------------------------------------------------------------------------------------------|-------|-----------------------|-------|---------------|-------|----------|-------|-----------|-------|-------------|-------|--------------|-------|--------------------|-------|---------------------|-------|----------------------|-------|------------------|-------|-----------------------------|
| AD[31:0] | I/O | PCI Address/Data: AD[31:0] is a multiplexed address and data bus. During the first clock of a transaction, AD[31:0] contain a physical address (32 bits). During subsequent clocks, AD[31:0] contain data. The Intel ICH10 will drive all 0s on AD[31:0] during the address phase of all PCI Special Cycles. | | | | | | | | | | | | | | | | | | | | | | |
| C/BE[3:0]# | I/O | <p>Bus Command and Byte Enables: The command and byte enable signals are multiplexed on the same PCI pins. During the address phase of a transaction, C/BE[3:0]# define the bus command. During the data phase C/BE[3:0]# define the Byte Enables.</p> <p>C/BE[3:0]# Command Type</p> <table border="0"> <tr><td>0000b</td><td>Interrupt Acknowledge</td></tr> <tr><td>0001b</td><td>Special Cycle</td></tr> <tr><td>0010b</td><td>I/O Read</td></tr> <tr><td>0011b</td><td>I/O Write</td></tr> <tr><td>0110b</td><td>Memory Read</td></tr> <tr><td>0111b</td><td>Memory Write</td></tr> <tr><td>1010b</td><td>Configuration Read</td></tr> <tr><td>1011b</td><td>Configuration Write</td></tr> <tr><td>1100b</td><td>Memory Read Multiple</td></tr> <tr><td>1110b</td><td>Memory Read Line</td></tr> <tr><td>1111b</td><td>Memory Write and Invalidate</td></tr> </table> <p>All command encodings not shown are reserved. The ICH10 does not decode reserved values, and therefore will not respond if a PCI master generates a cycle using one of the reserved values.</p> | 0000b | Interrupt Acknowledge | 0001b | Special Cycle | 0010b | I/O Read | 0011b | I/O Write | 0110b | Memory Read | 0111b | Memory Write | 1010b | Configuration Read | 1011b | Configuration Write | 1100b | Memory Read Multiple | 1110b | Memory Read Line | 1111b | Memory Write and Invalidate |
| 0000b | Interrupt Acknowledge | | | | | | | | | | | | | | | | | | | | | | | |
| 0001b | Special Cycle | | | | | | | | | | | | | | | | | | | | | | | |
| 0010b | I/O Read | | | | | | | | | | | | | | | | | | | | | | | |
| 0011b | I/O Write | | | | | | | | | | | | | | | | | | | | | | | |
| 0110b | Memory Read | | | | | | | | | | | | | | | | | | | | | | | |
| 0111b | Memory Write | | | | | | | | | | | | | | | | | | | | | | | |
| 1010b | Configuration Read | | | | | | | | | | | | | | | | | | | | | | | |
| 1011b | Configuration Write | | | | | | | | | | | | | | | | | | | | | | | |
| 1100b | Memory Read Multiple | | | | | | | | | | | | | | | | | | | | | | | |
| 1110b | Memory Read Line | | | | | | | | | | | | | | | | | | | | | | | |
| 1111b | Memory Write and Invalidate | | | | | | | | | | | | | | | | | | | | | | | |
| DEVSEL# | I/O | Device Select: The ICH10 asserts DEVSEL# to claim a PCI transaction. As an output, the ICH10 asserts DEVSEL# when a PCI master peripheral attempts an access to an internal ICH10 address or an address destined for DMI (main memory or graphics). As an input, DEVSEL# indicates the response to an ICH10-initiated transaction on the PCI bus. DEVSEL# is tri-stated from the leading edge of PLTRST#. DEVSEL# remains tri-stated by the ICH10 until driven by a target device. | | | | | | | | | | | | | | | | | | | | | | |



Table 2-6. PCI Interface Signals (Sheet 2 of 3)

| Name | Type | Description |
|---------------|------|----------------------------------------------------------------------------------------------------------------------------------------------------------------------------------------------------------------------------------------------------------------------------------------------------------------------------------------------------------------------------------------------------------------------------------------------------------------------------------------------------------------------------------------------------------------------------------------------------------------------------------------------------------------------------------------------------------------------------------------------------------------------------------------------------------------------------------------------------------------------------------------------------------------------------------------------------------------------------------------------------------------------------------------------------------------------------------------------|
| FRAME# | I/O | Cycle Frame: The current initiator drives FRAME# to indicate the beginning and duration of a PCI transaction. While the initiator asserts FRAME#, data transfers continue. When the initiator negates FRAME#, the transaction is in the final data phase. FRAME# is an input to the ICH10 when the ICH10 is the target, and FRAME# is an output from the ICH10 when the ICH10 is the initiator. FRAME# remains tri-stated by the ICH10 until driven by an initiator. |
| IRDY# | I/O | Initiator Ready: IRDY# indicates the ICH10's ability, as an initiator, to complete the current data phase of the transaction. It is used in conjunction with TRDY#. A data phase is completed on any clock both IRDY# and TRDY# are sampled asserted. During a write, IRDY# indicates the ICH10 has valid data present on AD[31:0]. During a read, it indicates the ICH10 is prepared to latch data. IRDY# is an input to the ICH10 when the ICH10 is the target and an output from the ICH10 when the ICH10 is an initiator. IRDY# remains tri-stated by the ICH10 until driven by an initiator. |
| TRDY# | I/O | Target Ready: TRDY# indicates the ICH10's ability as a target to complete the current data phase of the transaction. TRDY# is used in conjunction with IRDY#. A data phase is completed when both TRDY# and IRDY# are sampled asserted. During a read, TRDY# indicates that the ICH10, as a target, has placed valid data on AD[31:0]. During a write, TRDY# indicates the ICH10, as a target is prepared to latch data. TRDY# is an input to the ICH10 when the ICH10 is the initiator and an output from the ICH10 when the ICH10 is a target. TRDY# is tri-stated from the leading edge of PLTRST#. TRDY# remains tri-stated by the ICH10 until driven by a target. |
| STOP# | I/O | Stop: STOP# indicates that the ICH10, as a target, is requesting the initiator to stop the current transaction. STOP# causes the ICH10, as an initiator, to stop the current transaction. STOP# is an output when the ICH10 is a target and an input when the ICH10 is an initiator. |
| PAR | I/O | Calculated/Checked Parity: PAR uses "even" parity calculated on 36 bits, AD[31:0] plus C/BE[3:0]#. "Even" parity means that the ICH10 counts the number of ones within the 36 bits plus PAR and the sum is always even. The ICH10 always calculates PAR on 36 bits regardless of the valid byte enables. The ICH10 generates PAR for address and data phases and only ensures PAR to be valid one PCI clock after the corresponding address or data phase. The ICH10 drives and tri-states PAR identically to the AD[31:0] lines except that the ICH10 delays PAR by exactly one PCI clock. PAR is an output during the address phase (delayed one clock) for all ICH10 initiated transactions. PAR is an output during the data phase (delayed one clock) when the ICH10 is the initiator of a PCI write transaction, and when it is the target of a read transaction. ICH10 checks parity when it is the target of a PCI write transaction. If a parity error is detected, the ICH10 will set the appropriate internal status bits, and has the option to generate an NMI# or SMI#. |
| PERR# | I/O | Parity Error: An external PCI device drives PERR# when it receives data that has a parity error. The ICH10 drives PERR# when it detects a parity error. The ICH10 can either generate an NMI# or SMI# upon detecting a parity error (either detected internally or reported via the PERR# signal). |



Table 2-6. PCI Interface Signals (Sheet 3 of 3)

| Name | Type | Description |
|-----------------------------------------------------------------------------------------|------|--------------------------------------------------------------------------------------------------------------------------------------------------------------------------------------------------------------------------------------------------------------------------------------------------------------------------------------------------------------------------------|
| REQ0# REQ1# / GPIO50 REQ2# / GPIO52 REQ3# / GPIO54 | I | PCI Requests: The ICH10 supports up to 4 masters on the PCI bus. REQ[3:1]# pins can instead be used as GPIO. |
| GNT0# GNT1# / GPIO51 GNT2# / GPIO53 GNT3# / GPIO55 | O | PCI Grants: The ICH10 supports up to 4 masters on the PCI bus. GNT[3:1]# pins can instead be used as GPIO. Pull-up resistors are not required on these signals. If pull-ups are used, they should be tied to the Vcc3_3 power rail. NOTE: GNT[3:0]# are sampled as a functional strap. See Section 2.25.1 for details. |
| PCICLK | I | PCI Clock: This is a 33 MHz clock. PCICLK provides timing for all transactions on the PCI Bus. |
| PCRST# | O | PCI Reset: This is the Secondary PCI Bus reset signal. It is a logical OR of the primary interface PLTRST# signal and the state of the Secondary Bus Reset bit of the Bridge Control register (D30:F0:3Eh, bit 6). |
| PLOCK# | I/O | PCI Lock: This signal indicates an exclusive bus operation and may require multiple transactions to complete. ICH10 asserts PLOCK# when it performs non-exclusive transactions on the PCI bus. PLOCK# is ignored when PCI masters are granted the bus. |
| SERR# | I/OD | System Error: SERR# can be pulsed active by any PCI device that detects a system error condition. Upon sampling SERR# active, the ICH10 has the ability to generate an NMI, SMI#, or interrupt. |
| PME# | I/OD | PCI Power Management Event: PCI peripherals drive PME# to wake the system from low-power states S1–S5. PME# assertion can also be enabled to generate an SCI from the S0 state. In some cases the ICH10 may drive PME# active due to an internal wake event. The ICH10 will not drive PME# high, but it will be pulled up to VccSus3_3 by an internal pull-up resistor. |

2.7 Serial ATA Interface

Table 2-7. Serial ATA Interface Signals (Sheet 1 of 3)

| Name | Type | Description |
|------------------------------------|------|------------------------------------------------------------------------------------------------------------------------------------------------------------------------------------------------|
| SATA0TXP SATA0TXN | O | Serial ATA 0 Differential Transmit Pairs: These are outbound high-speed differential signals to Port 0. In compatible mode, SATA Port 0 is the primary master of SATA Controller 1. |
| SATA0RXP SATA0RXN | I | Serial ATA 0 Differential Receive Pair: These are inbound high-speed differential signals from Port 0. In compatible mode, SATA Port 0 is the primary master of SATA Controller 1. |
| SATA1TXP SATA1TXN | O | Serial ATA 1 Differential Transmit Pair: These are outbound high-speed differential signals to Port 1. In compatible mode, SATA Port 1 is the secondary master of SATA Controller 1. |

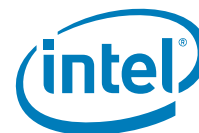

Table 2-7. Serial ATA Interface Signals (Sheet 2 of 3)

| Name | Type | Description |
|----------------------|------|---------------------------------------------------------------------------------------------------------------------------------------------------------------------------------------------------------------------------------------------------------------------------------------------------------------------------------------------------------------------------------------------------------|
| SATA1RXP SATA1RXN | I | Serial ATA 1 Differential Receive Pair: These are inbound high-speed differential signals from Port 1. In compatible mode, SATA Port 1 is the secondary master of SATA Controller 1 |
| SATA2TXP SATA2TXN | O | Serial ATA 2 Differential Transmit Pair: These are outbound high-speed differential signals to Port 2. In compatible mode, SATA Port 2 is the primary slave of SATA Controller 1. |
| SATA2RXP SATA2RXN | I | Serial ATA 2 Differential Receive Pair: These are inbound high-speed differential signals from Port 2. In compatible mode, SATA Port 2 is the primary slave of SATA Controller 1 |
| SATA3TXP SATA3TXN | O | Serial ATA 3 Differential Transmit Pair: These are outbound high-speed differential signals to Port 3. In compatible mode, SATA Port 3 is the secondary slave of SATA Controller 1 |
| SATA3RXP SATA3RXN | I | Serial ATA 3 Differential Receive Pair: These are inbound high-speed differential signals from Port 3. In compatible mode, SATA Port 3 is the secondary slave of SATA Controller 1 |
| SATA4TXP SATA4TXN | O | Serial ATA 4 Differential Transmit Pair: These are outbound high-speed differential signals to Port 4. In compatible mode, SATA Port 4 is the primary master of SATA Controller 2 |
| SATA4RXP SATA4RXN | I | Serial ATA 4 Differential Receive Pair: These are inbound high-speed differential signals from Port 4. In compatible mode, SATA Port 4 is the primary master of SATA Controller 2 |
| SATA5TXP SATA5TXN | O | Serial ATA 5 Differential Transmit Pair: These are outbound high-speed differential signals to Port 5. In compatible mode, SATA Port 5 is the secondary master of SATA Controller 2 |
| SATA5RXP SATA5RXN | I | Serial ATA 5 Differential Receive Pair: These are inbound high-speed differential signals from Port 5. In compatible mode, SATA Port 5 is the secondary master of SATA Controller 2 |
| SATARBIAS | O | Serial ATA Resistor Bias: This is an analog connection point for an external resistor to ground. |
| SATARBIAS# | I | Serial ATA Resistor Bias Complement: This is an analog connection point for an external resistor to ground. |
| SATA0GP / GPIO21 | I | Serial ATA 0 General Purpose: This is an input pin which can be configured as an interlock switch corresponding to SATA Port 0. When used as an interlock switch status indication, this signal should be drive to '0' to indicate that the switch is closed and to '1' to indicate that the switch is open. If interlock switches are not required, this pin can be configured as GPIO21. |

Table 2-7. Serial ATA Interface Signals (Sheet 3 of 3)

| Name | Type | Description |
|------------------------------------------------------------|------|------------------------------------------------------------------------------------------------------------------------------------------------------------------------------------------------------------------------------------------------------------------------------------------------------------------------------------------------------------------------------------------------------------------------------------------|
| SATA1GP / GPIO19 | I | Serial ATA 1 General Purpose: Same function as SATA0GP, except for SATA Port 1. If interlock switches are not required, this pin can be configured as GPIO19. |
| SATA2GP / GPIO36 | I | Serial ATA 2 General Purpose: Same function as SATA0GP, except for SATA Port 2. If interlock switches are not required, this pin can be configured as GPIO36. NOTE: This signal can also be used as GPIO36. |
| SATA3GP / GPIO37 | I | Serial ATA 3 General Purpose: Same function as SATA0GP, except for SATA Port 3. If interlock switches are not required, this pin can be configured as GPIO37. NOTE: This signal can also be used as GPIO37. |
| SATA4GP | I | Serial ATA 4 General Purpose: Same function as SATA0GP, except for SATA Port 4. |
| SATA5GP | I | Serial ATA 5 General Purpose: Same function as SATA0GP, except for SATA Port 5. |
| SATALED# | OD O | Serial ATA LED: This signal is an open-drain output pin driven during SATA command activity. It is to be connected to external circuitry that can provide the current to drive a platform LED. When active, the LED is on. When tri-stated, the LED is off. An external pull-up resistor to Vcc3_3 is required. NOTE: This signal is sampled as a functional strap. See Section 2.25.1 for details. |
| SATACLKREQ# /GPIO35 | OD O | Serial ATA Clock Request: This signal is an open-drain output pin when configured as SATACLKREQ#. It is used to connect to the system clock chip. When active, request for SATA Clock running is asserted. When tri-stated, it tells the Clock Chip that SATA Clock can be stopped. An external pull-up resistor is required. |
| SCLOCK/ GPIO22 | OD O | SGPIO Reference Clock: The SATA controller uses rising edges of this clock to transmit serial data, and the target uses the falling edge of this clock to latch data. If SGPIO interface is not used, this signal can be used as a GPIO. |
| SLOAD/GPIO38 | OD O | SGPIO Load: The controller drives a '1' at the rising edge of SCLOCK to indicate either the start or end of a bit stream. A 4-bit vendor specific pattern will be transmitted right after the signal assertion. If SGPIO interface is not used, this signal can be used as a GPIO. |
| SDATAOUT0/ GPIO39 SDATAOUT1/ GPIO48 | OD O | SGPIO Dataout: Driven by the controller to indicate the drive status in the following sequence: drive 0, 1, 2, 3, 4, 5, 0, 1, 2... If SGPIO interface is not used, the signals can be used as GPIO. |



2.8 LPC Interface

Table 2-8. LPC Interface Signals

| Name | Type | Description |
|-------------------------|------|--------------------------------------------------------------------------------------------------------------------------------------------------------------------------------------------------------------------------------------------------------------------------------|
| LAD[3:0] / FWH[3:0] | I/O | LPC Multiplexed Command, Address, Data: For LAD[3:0], internal pull-ups are provided. |
| LFRAME# / FWH4 | O | LPC Frame: LFRAME# indicates the start of an LPC cycle, or an abort. |
| LDRQ0#, LDRQ1# / GPIO23 | I | LPC Serial DMA/Master Request Inputs: LDRQ[1:0]# are used to request DMA or bus master access. These signals are typically connected to an external Super I/O device. An internal pull-up resistor is provided on these signals. LDRQ1# may optionally be used as GPIO. |

2.9 Interrupt Interface

Table 2-9. Interrupt Signals

| Name | Type | Description |
|------------------------|------|---------------------------------------------------------------------------------------------------------------------------------------------------------------------------------------------------------------------------------------------------------------------------------------------------------------------------------------------------------------------------------------------------------------------------------------------------------------------------------------------------------------------------------------|
| SERIRQ | I/OD | Serial Interrupt Request: This pin implements the serial interrupt protocol. |
| PIRQ[D:A]# | I/OD | PCI Interrupt Requests: In non-APIC mode the PIRQx# signals can be routed to interrupts 3, 4, 5, 6, 7, 9, 10, 11, 12, 14 or 15 as described in Section 5.8.6 . Each PIRQx# line has a separate Route Control register. In APIC mode, these signals are connected to the internal I/O APIC in the following fashion: PIRQA# is connected to IRQ16, PIRQB# to IRQ17, PIRQC# to IRQ18, and PIRQD# to IRQ19. This frees the legacy interrupts. |
| PIRQ[H:E]# / GPIO[5:2] | I/OD | PCI Interrupt Requests: In non-APIC mode the PIRQx# signals can be routed to interrupts 3, 4, 5, 6, 7, 9, 10, 11, 12, 14 or 15 as described in Section 5.8.6 . Each PIRQx# line has a separate Route Control register. In APIC mode, these signals are connected to the internal I/O APIC in the following fashion: PIRQE# is connected to IRQ20, PIRQF# to IRQ21, PIRQG# to IRQ22, and PIRQH# to IRQ23. This frees the legacy interrupts. If not needed for interrupts, these signals can be used as GPIO. |



2.10 USB Interface

Table 2-10. USB Interface Signals

| Name | Type | Description |
|-----------------------------------------|------|-------------------------------------------------------------------------------------------------------------------------------------------------------------------------------------------------------------------------------------------------------------------------------------------------------------------------------------------------------------------------------------------------------------------------------------------------------------------------------------------|
| USBP0P, USBP0N, USBP1P, USBP1N | I/O | <p>Universal Serial Bus Port [1:0] Differential: These differential pairs are used to transmit Data/Address/Command signals for ports 0 and 1. These ports can be routed to UHCI controller #1 or the EHCI controller #1.</p> <p>NOTE: No external resistors are required on these signals. The Intel ICH10 integrates 15 kΩ pull-downs and provides an output driver impedance of 45 Ω which requires no external series resistor.</p> |
| USBP2P, USBP2N, USBP3P, USBP3N | I/O | <p>Universal Serial Bus Port [3:2] Differential: These differential pairs are used to transmit data/address/command signals for ports 2 and 3. These ports can be routed to UHCI controller #2 or the EHCI controller #1.</p> <p>NOTE: No external resistors are required on these signals. The ICH10 integrates 15 kΩ pull-downs and provides an output driver impedance of 45 Ω which requires no external series resistor.</p> |
| USBP4P, USBP4N, USBP5P, USBP5N | I/O | <p>Universal Serial Bus Port [5:4] Differential: These differential pairs are used to transmit Data/Address/Command signals for ports 4 and 5. These ports can be routed to UHCI controller #3 or the EHCI controller #1.</p> <p>NOTE: No external resistors are required on these signals. The ICH10 integrates 15 kΩ pull-downs and provides an output driver impedance of 45 Ω which requires no external series resistor.</p> |
| USBP6P, USBP6N, USBP7P, USBP7N | I/O | <p>Universal Serial Bus Port [7:6] Differential: These differential pairs are used to transmit Data/Address/Command signals for ports 6 and 7. These ports can be routed to UHCI controller #4 or the EHCI controller #2.</p> <p>NOTE: No external resistors are required on these signals. The ICH10 integrates 15 kΩ pull-downs and provides an output driver impedance of 45 Ω which requires no external series resistor.</p> |
| USBP8P, USBP8N, USBP9P, USBP9N | I/O | <p>Universal Serial Bus Port [9:8] Differential: These differential pairs are used to transmit Data/Address/Command signals for ports 8 and 9. These ports can be routed to UHCI controller #5 or the EHCI controller #2.</p> <p>NOTE: No external resistors are required on these signals. The ICH10 integrates 15 kΩ pull-downs and provides an output driver impedance of 45 Ω which requires no external series resistor.</p> |



Table 2-10. USB Interface Signals

| Name | Type | Description |
|------------------------------------------------------------------------------------------------------------------------------------------------------------------------------------------------------------|------|----------------------------------------------------------------------------------------------------------------------------------------------------------------------------------------------------------------------------------------------------------------------------------------------------------------------------------------------------------------------------------------------------------------------------------------------------------------------------------------------------------------------------------------------------------------------------------|
| USBP10P, USBP10N, USBP11P, USBP11N | I/O | <p>Universal Serial Bus Port [11:10] Differential: These differential pairs are used to transmit Data/Address/Command signals for ports 10 and 11. These ports can be routed to UHCI controller #6 or the EHCI controller #2. These ports can be optionally routed to EHCI Controller #1 when bit 0 RCBA 35F0h is set.</p> <p>NOTE: No external resistors are required on these signals. The ICH10 integrates 15 kΩ pull-downs and provides an output driver impedance of 45 Ω which requires no external series resistor.</p> |
| OC0# / GPIO59 OC1# / GPIO40 OC2# / GPIO41 OC3# / GPIO42 OC4# / GPIO43 OC5# / GPIO29 OC6# / GPIO30 OC7# / GPIO31 OC8# / GPIO44 OC9# / GPIO45 OC10# / GPIO46 OC11# / GPIO47 | I | <p>Overcurrent Indicators: These signals set corresponding bits in the USB controllers to indicate that an overcurrent condition has occurred.</p> <p>OC[11:0]# may optionally be used as GPIOs.</p> <p>NOTE: OC[11:0]# are not 5 V tolerant.</p> |
| USBRBIAS | O | <p>USB Resistor Bias: Analog connection point for an external resistor. Used to set transmit currents and internal load resistors.</p> |
| USBRBIAS# | I | <p>USB Resistor Bias Complement: Analog connection point for an external resistor. Used to set transmit currents and internal load resistors.</p> |



2.11 Power Management Interface

Table 2-11. Power Management Interface Signals (Sheet 1 of 3)

| Name | Type | Description |
|-----------------------------------|------|-----------------------------------------------------------------------------------------------------------------------------------------------------------------------------------------------------------------------------------------------------------------------------------------------------------------------------------------------------------------------------------------------------------------------------------------------------------------------------------------------------------------------------------------------------------------------------------------------------------------------------------------------------------------------------------------------------------------------|
| PLTRST# | O | <p>Platform Reset: The ICH10 asserts PLTRST# to reset devices on the platform (e.g., SIO, FWH, LAN, (G)MCH, TPM, etc.). The ICH10 asserts PLTRST# during power-up and when S/W initiates a hard reset sequence through the Reset Control register (I/O Register CF9h). The ICH10 drives PLTRST# inactive a minimum of 1 ms after both PWROK and VRMPWRGD are driven high. The ICH10 drives PLTRST# active a minimum of 1 ms when initiated through the Reset Control register (I/O Register CF9h).</p> <p>NOTE: PLTRST# is in the VccSus3_3 well.</p> |
| THRM# | I | <p>Thermal Alarm: Active low signal generated by external hardware to generate an SMI# or SCI.</p> |
| THRMTRIP# | I | <p>Thermal Trip: When low, this signal indicates that a thermal trip from the processor occurred, and the ICH10 will immediately transition to a S5 state. The ICH10 will not wait for the processor stop grant cycle since the processor has overheated.</p> |
| SLP_S3# | O | <p>S3 Sleep Control: SLP_S3# is for power plane control. This signal shuts off power to all non-critical systems when in S3 (Suspend To RAM), S4 (Suspend to Disk), or S5 (Soft Off) states.</p> |
| SLP_S4# | O | <p>S4 Sleep Control: SLP_S4# is for power plane control. This signal shuts power to all non-critical systems when in the S4 (Suspend to Disk) or S5 (Soft Off) state.</p> <p>NOTE: This pin must be used to control the DRAM power in order to use the ICH10's DRAM power-cycling feature. Refer to Chapter 5.13.10.2 for details</p> <p>NOTE: In a system with Intel AMT support, this signal should be used to control the DRAM power. In M1 state (where the host platform is in S3-S5 states and the manageability sub-system is running) the signal is forced high along with SLP_M# in order to properly maintain power to the DIMM used for manageability sub-system.</p> |
| SLP_S5# / GPIO63 (Corporate Only) | O | <p>S5 Sleep Control: SLP_S5# is for power plane control. This signal is used to shut power off to all non-critical systems when in the S5 (Soft Off) states.</p> <p>ICH10 Corporate Family: pin may also be used as GPIO63.</p> |
| SLP_M# | O | <p>Manageability Sleep State Control: This signal is used to control power planes to the Intel AMT sub-system. If no Intel Management Engine firmware is present, SLP_M# will have the same timings as SLP_S3#.</p> |
| S4_STATE# / GPIO26 | O | <p>S4 State Indication: This signal asserts low when the host platform is in S4 or S5 state. In platforms where the Intel Management Engine is forcing the SLP_S4# high along with SLP_M#, this signal can be used by other devices on the board to know when the host platform is below the S3 state.</p> |

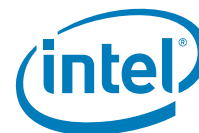

Table 2-11. Power Management Interface Signals (Sheet 2 of 3)

| Name | Type | Description |
|------------|------|-------------------------------------------------------------------------------------------------------------------------------------------------------------------------------------------------------------------------------------------------------------------------------------------------------------------------------------------------------------------------------------------------------------------------------------------------------------------------------------------------------------------------------------------------------------------------------------------------------------------------------------------------------------------------------------------------------------------------------------------------------------------------------|
| PWROK | I | <p>Power OK: When asserted, PWROK is an indication to the ICH10 that all power rails have been stable for 99 ms and that PCICLK has been stable for 1 ms. PWROK can be driven asynchronously. When PWROK is negated, the ICH10 asserts PLTRST#.</p> <p>NOTE:</p> <ol style="list-style-type: none"> PWROK must deassert for a minimum of three RTC clock periods in order for the ICH10 to fully reset the power and properly generate the PLTRST# output. PWROK must not glitch, even if RSMRST# is low. |
| CLPWROK | I | <p>Controller Link Power OK: When asserted, indicates that power to the Controller Link subsystem (MCH, ICH, etc.) is stable and tells the ICH to de-assert CL_RST# to the (G)MCH.</p> <p>NOTES:</p> <ol style="list-style-type: none"> CLPWROK must not assert before RSMRST# deasserts. CLPWROK must not assert after PWROK asserts. |
| PWRBTN# | I | <p>Power Button: The Power Button will cause SMI# or SCI to indicate a system request to go to a sleep state. If the system is already in a sleep state, this signal will cause a wake event. If PWRBTN# is pressed for more than 4 seconds, this will cause an unconditional transition (power button override) to the S5 state. Override will occur even if the system is in the S1–S4 states. This signal has an internal pull-up resistor and has an internal 16 ms de-bounce on the input.</p> |
| RI# | I | <p>Ring Indicate: This signal is an input from a modem. It can be enabled as a wake event, and this is preserved across power failures.</p> |
| SYS_RESET# | I | <p>System Reset: This pin forces an internal reset after being debounced. The ICH10 will reset immediately if the SMBus is idle; otherwise, it will wait up to 25 ms \pm 2 ms for the SMBus to idle before forcing a reset on the system.</p> |
| RSMRST# | I | <p>Resume Well Reset: This signal is used for resetting the resume power plane logic. This signal must be asserted for at least 10 ms after the suspend power wells are valid. When deasserted, this signal is an indication that the suspend power wells are stable.</p> |
| LAN_RST# | I | <p>LAN Reset: When asserted, the internal LAN controller is in reset. This signal must be asserted until the LAN power wells (VccLAN3_3 and VccLAN1_1) and VccCL3_3 power well are valid. When deasserted, this signal is an indication that the LAN power wells are stable.</p> <p>NOTES:</p> <ol style="list-style-type: none"> LAN_RST# must not deassert before RSMRST# deasserts LAN_RST# must not deassert after PWROK asserts. LAN_RST# must not deassert until 1ms after the LAN power wells (VccLAN3_3 and VccLAN1_1 and VccCL3_3 power well are valid. If integrated LAN is not used LAN_RST# must be tied to Vss. LAN_RST# must assert a minimum of 20 ns before LAN Power rails become inactive. |
| WAKE# | I | <p>PCI Express* Wake Event: Sideband wake signal on PCI Express asserted by components requesting wake up.</p> |
| MCH_SYNC# | I | <p>MCH SYNC: This input is internally ANDed with the PWROK input. Connect to the ICH_SYNC# output of the (G)MCH.</p> |

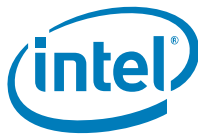

Table 2-11. Power Management Interface Signals (Sheet 3 of 3)

| Name | Type | Description |
|--------------------------------------------------------------|------|--------------------------------------------------------------------------------------------------------------------------------------------------------------------------------------------------------------------------------------------------------------------------------------------------------------------------------------------------------------------------------------------------------------------------------------------------------------------------------------------------------|
| SUS_STAT# / LPCPD# / GPIO61 (Corporate Only) | O | Suspend Status: This signal is asserted by the ICH10 to indicate that the system will be entering a low power state soon. This can be monitored by devices with memory that need to switch from normal refresh to suspend refresh mode. It can also be used by other peripherals as an indication that they should isolate their outputs that may be going to powered-off planes. This signal is called LPCPD# on the LPC interface. ICH10 Corporate Family: pin may also be used as GPIO61. |
| SUSCLK / GPIO62 (Corporate Only) | O | Suspend Clock: This clock is an output of the RTC generator circuit to use by other chips for refresh clock. ICH10 Corporate Family: pin may also be used as GPIO62. |
| VRMPWRGD | I | VRM Power Good: This signal should be connected to the processor's VRM Power Good signifying the VRM is stable. This signal is internally ANDed with the PWROK input. This signal is in the suspend well. |
| DRAMPWROK (Corporate Only) / GPIO8 | OD O | DRAM Power OK: This signal should connect to the (G)MCH's DDR3_DRAM_PWROK pin. The ICH asserts this pin to indicate when DRAM power is off. An external pull-up resistor is required. This pin is not open-drain when operating in GPIO mode. |
| CK_PWRGD | O | Clock Generator Power Good: This signal indicates to the clock generator when the main power well is valid. This signal is asserted high when both SLP_S3# and VRMPWRGD are high. |
| BMBUSY# / GPIO0 | I | Bus Master Busy: This signal is used to support the C3 state. It indicates that a bus master device is busy. When this signal is asserted, the BM_STS bit will be set. If this signal goes active in a C3 state, it is treated as a break event. NOTE: This signal is internally synchronized using the PCICLK and a two-stage synchronizer. It does not need to meet any particular setup or hold time. Signal may also be used as a GPIO. |
| STP_PCI# / GPIO15 | O | Stop PCI Clock: This signal is an output to the external clock generator for it to turn off the PCI clock. It is used to support the C3 state. This signal can instead be used as a GPIO. |
| STP_CPU# / GPIO25 (Corporate Only) | O | Stop CPU Clock: This signal is an output to the external clock generator for it to turn off the processor clock. Corporate Only: This signal can instead be used as a GPIO. |
| DPRSTP# | O | Deeper Stop: This is a copy of the DPRSLPVR and it is active low. |
| DPRSLPVR / GPIO16 | O | Deeper Sleep - Voltage Regulator: This signal is used to lower the voltage of the VRM during the C4 state. When the signal is high, the voltage regulator outputs the lower "Deeper Sleep" voltage. When low (default), the voltage regulator outputs the higher "Normal" voltage. This signal can instead be used as a GPIO. |



2.12 Processor Interface

Table 2-12. Processor Interface Signals (Sheet 1 of 2)

| Name | Type | Description |
|----------------|------|-----------------------------------------------------------------------------------------------------------------------------------------------------------------------------------------------------------------------------------------------------------------------------------------------------------------------------------------------------------------------------------------------------------------------------------------------------------------------------------------------------------------------------------------------------------------------------------------------------------------------------------------------------------------------------------------------------------------------------------------------------------------------------------------------------------------------------------------------------------------|
| A2OM# | O | Mask A20: A2OM# will go active based on either setting the appropriate bit in the Port 92h register, or based on the A20GATE input being active. |
| FERR# | I | Numeric Coprocessor Error: This signal is tied to the coprocessor error signal on the processor. FERR# is only used if the ICH10 coprocessor error reporting function is enabled in the OIC.CEN register (Chipset Config Registers: Offset 31FFh: bit 1 for Consumer Family and Offset 31FEh: bit 9 for Corporate family). If FERR# is asserted, the ICH10 generates an internal IRQ13 to its interrupt controller unit. It is also used to gate the IGNNE# signal to ensure that IGNNE# is not asserted to the processor unless FERR# is active. FERR# requires an external weak pull-up to ensure a high level when the coprocessor error function is disabled. NOTE: FERR# can be used in some states for notification by the processor of pending interrupt events. This functionality is independent of the OIC register bit setting. |
| IGNNE# | O | Ignore Numeric Error: This signal is connected to the ignore error pin on the processor. IGNNE# is only used if the ICH10 coprocessor error reporting function is enabled in the OIC.CEN register (Chipset Config Registers: Offset 31FFh: bit 1 for Consumer Family and Offset 31FEh: bit 9 for Corporate family). If FERR# is active, indicating a coprocessor error, a write to the Coprocessor Error register (I/O register F0h) causes the IGNNE# to be asserted. IGNNE# remains asserted until FERR# is negated. If FERR# is not asserted when the Coprocessor Error register is written, the IGNNE# signal is not asserted. |
| INIT# | O | Initialization: INIT# is asserted by the ICH10 for 16 PCI clocks to reset the processor. ICH10 can be configured to support processor Built In Self Test (BIST). |
| INTR | O | CPU Interrupt: INTR is asserted by the ICH10 to signal to the processor that an interrupt request is pending and needs to be serviced. It is an asynchronous output and normally driven low. |
| NMI | O | Non-Maskable Interrupt: NMI is used to force a non-Maskable interrupt to the processor. The ICH10 can generate an NMI when either SERR# is asserted or IOCHK# goes active via the SERIRQ# stream. The processor detects an NMI when it detects a rising edge on NMI. NMI is reset by setting the corresponding NMI source enable/disable bit in the NMI Status and Control register (I/O Register 61h). |
| SMI# | O | System Management Interrupt: SMI# is an active low output synchronous to PCICLK. It is asserted by the ICH10 in response to one of many enabled hardware or software events. |
| STPCLK# | O | Stop Clock Request: STPCLK# is an active low output synchronous to PCICLK. It is asserted by the ICH10 in response to one of many hardware or software events. When the processor samples STPCLK# asserted, it responds by stopping its internal clock. |



Table 2-12. Processor Interface Signals (Sheet 2 of 2)

| Name | Type | Description |
|----------|------|------------------------------------------------------------------------------------------------------------------------------------------------------------------------------------------------------------------------------------------------------------------------------------------------------------------------------------------------------------------------------------------|
| RCIN# | I | <p>Keyboard Controller Reset CPU: The keyboard controller can generate INIT# to the processor. This saves the external OR gate with the ICH10's other sources of INIT#. When the ICH10 detects the assertion of this signal, INIT# is generated for 16 PCI clocks.</p> <p>NOTE: The ICH10 will ignore RCIN# assertion during transitions to the S3, S4, and S5 states.</p> |
| A20GATE | I | <p>A20 Gate: A20GATE is from the keyboard controller. The signal acts as an alternative method to force the A20M# signal active. It saves the external OR gate needed with various other chipsets.</p> |
| CPUPWRGD | O | <p>CPU Power Good: This signal should be connected to the processor's PWRGOOD input to indicate when the processor power is valid. This is an output signal that represents a logical AND of the ICH10's PWROK and VRMPWRGD signals.</p> |
| DPSLP# | O | <p>Deeper Sleep: DPSLP# is asserted by the ICH10 to the processor. When the signal is low, the processor enters the deep sleep state by gating off the processor Core Clock inside the processor. When the signal is high (default), the processor is not in the deep sleep state.</p> |
| DPSLP# | O | <p>Deeper Sleep: DPSLP# is asserted by the ICH10 to the processor. When the signal is low, the processor enters the deep sleep state by gating off the processor Core Clock inside the processor. When the signal is high (default), the processor is not in the deep sleep state.</p> |

2.13 SMBus Interface

Table 2-13. SMBus Interface Signals

| Name | Type | Description |
|-----------------------------------------------|------|-----------------------------------------------------------------------------------------------------------------------------------------------------------------------------------------------------------------------------------|
| SMBDATA | I/OD | <p>SMBus Data: External pull-up resistor is required.</p> |
| SMBCLK | I/OD | <p>SMBus Clock: External pull-up resistor is required.</p> |
| SMBALERT# / GPIO11 / JTAGTDO (Corporate Only) | I | <p>SMBus Alert: This signal is used to wake the system or generate SMI#.</p> <p>ICH10 Consumer Family: This signal may be used as GPIO11.</p> <p>ICH10 Corporate Family: This signal may be used as GPIO11 or JTAGTDO.</p> |



2.14 System Management Interface

Table 2-14. System Management Interface Signals (Sheet 1 of 2)

| Name | Type | Description |
|--------------------------------------------------------------------|------|---------------------------------------------------------------------------------------------------------------------------------------------------------------------------------------------------------------------------------------------------------------------------------------------------------------------------------------------------------------------------------------------|
| INTRUDER# | I | Intruder Detect: This signal can be set to disable system if box detected open. This signal's status is readable, so it can be used like a GPIO if the Intruder Detection is not needed. |
| SMLINK[1:0] | I/OD | System Management Link: SMBus link to optional external system management ASIC or LAN controller. External pull-ups are required. Note that SMLINK0 corresponds to an SMBus Clock signal, and SMLINK1 corresponds to an SMBus Data signal. |
| LINKALERT# / GPIO60 / JTAGRST# (Corporate Only) | O OD | SMLink Alert: Output of the integrated LAN controller and input to either the integrated ASF, Intel AMT or an external management controller in order for the LAN's SMLINK slave to be serviced. External pull-up resistor is required. ICH10 Consumer: This signal can instead be used as a GPIO60. ICH10 Corporate: This signal can instead be used as a GPIO60 or JTAGRST#. |
| MEM_LED / GPIO24 | O OD | Memory LED: Provides DRAM-powered LED control. Allows for the blinking of an LED to indicate memory activity in all power states. This functionality is configured and controlled by the Intel Management Engine. This signal can instead be used as GPIO24. |

Table 2-14. System Management Interface Signals (Sheet 2 of 2)

| Name | Type | Description |
|-----------------------------------------------------------------|------|---------------------------------------------------------------------------------------------------------------------------------------------------------------------------------------------------------------------------------------------------------------------------------------------------------------------------------------------------------------------------------------------------------------------------------------------------------------------------------------------------------------------------------------------------------------------------------------------------------------------------------------------------------------------------------------------------------------------------------------------------------------------------------------------------------------------------------------------------------------------------------------------------------------------------------------------------------------------------------------------------------------------------------------------------------------|
| WOL_EN / GPIO9 | O | <p>Wake On LAN Power Enable. In an Intel AMT or ASF enabled system, this output signal is driven high by the ICH to control the LAN subsystem power (VccLAN3_3, VccCL3_3, LAN PHY Power, and SPI device) to support Wake on LAN (WOL) when the Intel Management Engine is powered off. This functionality is configured and controlled by the Intel Management Engine prior to entering the powered off state.</p> <p>NOTES:</p> <ol style="list-style-type: none"> This signal should be OR'd with the SLP_M# signal on the motherboard to determine when to power the LAN subsystem. In order to support WOL out of a G3 state, the WOL_EN pin needs to be pulled high by an external resistor until the Intel Management Engine is initialized. <p>If ASF or Intel AMT are disabled on a board that is configured for WOL_EN support, BIOS must utilize GPIO9 to control power to the LAN subsystem when entering S3-S5.</p> <p>In platforms that do not support Intel AMT or ASF, this signal is used as GPIO9.</p> |
| CPU_MISSING / GPIO10 / JTAGTMS (Corporate Only) | I | <p>CPU Missing. This signal provides CPU Missing functionality and is configured and controlled by the Manageability Engine.</p> <p>This signal must be connected to the CPU SKTOCC# output to indicate to the Intel Manageability Engine that the CPU is not physically present when asserted.</p> <p>ICH10 Consumer Family: This signal may be used as GPIO10.</p> <p>ICH10 Corporate Family: This signal may be used as GPIO10 or JTAGTMS.</p> |
| TPM_PP / GPIO57 / JTAGTCK (Corporate Only) | I | <p>TPM Physical Presence. This signal is asserted to indicate Physical Presence to the integrated TPM module.</p> <p>ICH10 Consumer Family: This signal may be used as GPIO57.</p> <p>ICH10 Corporate Family: This signal may be used as GPIO57 or JTAGTCK.</p> |

2.15 Real Time Clock Interface

Table 2-15. Real Time Clock Interface

| Name | Type | Description |
|--------------|---------|-------------------------------------------------------------------------------------------------------------------------------------------------------------------|
| RTCX1 | Special | Crystal Input 1: This signal is connected to the 32.768 kHz crystal. If no external crystal is used, then RTCX1 can be driven with the desired clock rate. |
| RTCX2 | Special | Crystal Input 2: This signal is connected to the 32.768 kHz crystal. If no external crystal is used, then RTCX2 should be left floating. |

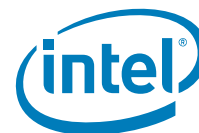

2.16 Other Clocks

Table 2-16. Other Clocks

| Name | Type | Description |
|------------------------|------|----------------------------------------------------------------------------------------------------------------------------------------------------------|
| CLK14 | I | Oscillator Clock: Used for 8254 timers. Runs at 14.31818 MHz. This clock is permitted to stop during S3 (or lower) states. |
| CLK48 | I | 48 MHz Clock: Used to run the USB controller. Runs at 48.000 MHz. This clock is permitted to stop during S3 (or lower) states. |
| SATA_CLKP SATA_CLKN | I | 100 MHz Differential Clock: These signals are used to run the SATA controller at 100 MHz. This clock is permitted to stop during S3/S4/S5 states. |
| DMI_CLKP, DMI_CLKN | I | 100 MHz Differential Clock: These signals are used to run the Direct Media Interface. Runs at 100 MHz. |

2.17 Miscellaneous Signals

Table 2-17. Miscellaneous Signals (Sheet 1 of 2)

| Name | Type | Description |
|------------|------|---------------------------------------------------------------------------------------------------------------------------------------------------------------------------------------------------------------------------------------------------------------------------------------------------------------------------------------------------------------------------------------------------------------------------------------------------------|
| INTVRMEN | I | Internal Voltage Regulator Enable: This signal enables the internal VccSus1_1, VccSus1_5 and VccCL1_5 regulators. This signal must be pulled-up to VccRTC. |
| LAN100_SLP | I | Internal Voltage Regulator Enable: When connected to VccRTC, this signal enables the internal voltage regulators powering VccLAN1_1 and VccCL1_1. This signal must be pulled-up to VccRTC. |
| SPKR | O | Speaker: The SPKR signal is the output of counter 2 and is internally "ANDed" with Port 61h bit 1 to provide Speaker Data Enable. This signal drives an external speaker driver device, which in turn drives the system speaker. Upon PLTRST#, its output state is 0. NOTE: SPKR is sampled as a functional strap. See Section 2.25.1 for more details. There is a weak integrated pull-down resistor on SPKR pin. |
| RTCST# | I | RTC Reset: When asserted, this signal resets register bits in the RTC well. NOTES: 1. Unless CMOS is being cleared (only to be done in the G3 power state), the RTCST# input must always be high when all other RTC power planes are on. 2. In the case where the RTC battery is dead or missing on the platform, the RTCST# pin must rise before the RSMRST# pin. |

Table 2-17. Miscellaneous Signals (Sheet 2 of 2)

| Name | Type | Description |
|-----------------------------------------|------|------------------------------------------------------------------------------------------------------------------------------------------------------------------------------------------------------------------------------------------------------------------------------------------------------------------------------------------------------------------------|
| SRTCST# | I | Secondary RTC Reset: This signal resets the manageability register bits in the RTC well when the RTC battery is removed. NOTES: 1. The SRTCST# input must always be high when all other RTC power planes are on. 2. In the case where the RTC battery is dead or missing on the platform, the SRTCST# pin must rise before the RSMRST# pin. |
| TPO / GPIO72 (Corporate Only) | I | Test Point 0: This signal must have an external pull-up to VccSus3_3. ICH10 Corporate: Pin can instead be used as GPIO72. |
| TP3 | I/O | Test Point 3: Route signal to a test point. |
| TP4 | I/O | Test Point 4: Route signal to a test point. |
| TP5 | I/O | Test Point 5: Route signal to a test point. |
| TP6 | I | Test Point 6: Route signal to a test point. |
| TP7 | O | Test Point 7: Route signal to a test point. |

2.18 Intel® High Definition Audio Link

Table 2-18. Intel® High Definition Audio Link Signals

| Name | Type | Description |
|-----------------|------|------------------------------------------------------------------------------------------------------------------------------------------------------------------------------------------------------------------------------------------------------------------------------------------------------------------|
| HDA_RST# | O | Intel® High Definition Audio Reset: Master hardware reset to external codec(s). |
| HDA_SYNC | O | Intel High Definition Audio Sync: 48 kHz fixed rate sample sync to the codec(s). Also used to encode the stream number. NOTE: This signal is sampled as a functional strap. See Section 2.25.1 for more details. There is a weak integrated pull-down resistor on this pin. |



Table 2-18. Intel® High Definition Audio Link Signals

| Name | Type | Description |
|---------------|------|--------------------------------------------------------------------------------------------------------------------------------------------------------------------------------------------------------------------------------------------------------------------------------------------------------------------------------------------------------------------------------------------------|
| HDA_BIT_CLK | O | Intel High Definition Audio Bit Clock Output: 24.000 MHz serial data clock generated by the Intel High Definition Audio controller (the Intel ICH10). This signal has a weak internal pull-down resistor. |
| HDA_SDOUT | O | Intel High Definition Audio Serial Data Out: Serial TDM data output to the codec(s). This serial output is double-pumped for a bit rate of 48 Mb/s for Intel High Definition Audio. NOTE: This signal is sampled as a functional strap. See Section 2.25.1 for more details. There is a weak integrated pull-down resistor on this pin. |
| HDA_SDIN[3:0] | I | Intel High Definition Audio Serial Data In [3:0]: Serial TDM data inputs from the codecs. The serial input is single-pumped for a bit rate of 24 Mb/s for Intel High Definition Audio. These signals have integrated pull-down resistors, which are always enabled. NOTE: During enumeration, the ICH will drive this signal. During normal operation, the CODEC will drive it. |

2.19 Serial Peripheral Interface (SPI)

Table 2-19. Serial Peripheral Interface (SPI) Signals

| Name | Type | Description |
|----------|------|-------------------------------------------------------------------------------------------------------------------------------------------------------------------------------------------------------------------------------------------|
| SPI_CS0# | O | SPI Chip Select 0: Used as the SPI bus request signal. NOTE: This signal is sampled as a functional strap. See Section 2.25.1 for more details. |
| SPI_CS1# | O | SPI Chip Select 1: Used as the SPI bus request signal. NOTE: This signal is sampled as a functional strap. See Section 2.25.1 for more details. There is a weak integrated pull-up resistor on this pin. |
| SPI_MISO | I | SPI Master IN Slave OUT: Data input pin for ICH10. |
| SPI_MOSI | O | SPI Master OUT Slave IN: Data output pin for ICH10. NOTE: This signal is sampled as a functional strap. See Section 2.25.1 for more details. There is a weak integrated pull-down resistor on this pin. |
| SPI_CLK | O | SPI Clock: SPI clock signal, during idle the bus owner will drive the clock signal low. 17.86 MHz and 31.25 MHz. |



2.20 Controller Link

Table 2-20. Controller Link Signals

| Signal Name | Type | Description |
|-------------|------|------------------------------------------------------------------------------------------------------------------------------------------------------------------------------------------------------------------------------------------------------------------------------------------------------------------------------------------------------------------------------------------------------|
| CL_CLK0 | I/O | Controller Link Clock 0: bi-directional clock that connects to the (G)MCH. |
| CL_DATA0 | I/O | Controller Link Data 0: bi-directional data that connects to the (G)MCH. |
| CL_VREF0 | I | Controller Link Reference Voltage 0: External reference voltage for Controller Link 0. ICH10 Corporate: When using internal reference voltage as configured by CLINKVREFSEL (ICHSTRP0:bit 5), an external circuit is not required and pin is No Connect (Recommended Configuration). Optionally, an external reference voltage generation circuit may be used (requires CLINKVREFSEL = 1). |
| CL_RST0# | O | Controller Link Reset 0: North Controller Link reset that connects to the (G)MCH. |

2.21 Intel® Quiet System Technology

Table 2-21. Intel® Quiet System Technology Signals

| Signal Name | Type | Description |
|-----------------------------------------------------------|------|----------------------------------------------------------------------------------------------------------------------------------------------------------------------------------------------------------------------------------------------------------------------------------------------------------------------------------------------------------------------------------------------------------------------------------------------------------------------|
| PWM[2:0] | OD O | Fan Pulse Width Modulation Outputs: Pulse Width Modulated duty cycle output signal that is used for Intel® Quiet System Technology. When controlling a 3-wire fan, this signal controls a power transistor that, in turn, controls power to the fan. When controlling a 4-wire fan, this signal is connected to the "Control" signal on the fan. The polarity of this signal is programmable. The output default is low. These signals are 5V tolerant. |
| TACH0/GPIO17 TACH1/GPIO1 TACH2/GPIO6 TACH3/GPIO7 | I | Fan Tachometer Inputs: Tachometer pulse input signal that is used to measure fan speed. This signal is connected to the "Sense" signal on the fan. Can instead be used as a GPIO. |



Table 2-21. Intel® Quiet System Technology Signals

| Signal Name | Type | Description |
|-----------------------------------------------------------------------------|------|-----------------------------------------------------------------------------------------------------------------------------------------------------------------------------------------------------------------------------------------------------------------------------------------------------------------------------------------------------------------------------------------------------------------------------------------------------------------------------------------------------------------------------------------------------------------------------------------------------------------------------------------------------------------------------------------------------------------------------------------------------------------------------|
| SST | I/O | Simple Serial Transport: Single-wire, serial bus. Connect to SST compliant devices such as SST thermal sensors or voltage sensors. |
| PECI | I/O | Platform Environment Control Interface: Single-wire, serial bus. Connect to corresponding pin of the processor for accessing processor digital thermometer. |
| QST_BMBUSY# (Consumer Only) / JTAGTDI (Corporate Only) / GPIO14 | O | Intel QST BMBUSY# Interconnect (Consumer Only): This signal is used for Intel ICH10 Consumer based platforms that support Intel QST and C3 and/or C4 processor states. QST_BMBUSY# is asserted by the ICH10 to ensure that Intel QST can read the processor thermal sensor since the sensor is inaccessible when the platform is in C3 or C4. QST_BMBUSY# must be externally tied to the BMBUSY# signal on the ICH10 to cause the platform to exit or prevent entry into C3 or C4. QST_BMBUSY# functionality is configured and controlled by the Intel Management Engine firmware. ICH10 Consumer: In non-Intel QST based platforms, this signal can instead be used as a GPIO14. ICH10 Corporate: This signal is instead used as a GPIO14 or JTAGTDI. |

2.22 JTAG Signals (Intel® ICH10 Corporate Family Only)

Table 2-22. JTAG Signals

| Name | Type | Description |
|-----------------------------------------------------------------|------|----------------------------------------------------------------------------------------------------------------------------------------------------------------------------------------------------------------------------------------------------------|
| JTAGTCK (Corporate Only) / GPIO57 / TPM_PP | I/O | Test Clock Input (TCK): The test clock input provides the clock for the JTAG test logic. |
| JTAGTMS (Corporate Only) / GPIO10 / CPU_MISSING | I/O | Test Mode Select (TMS): The signal is decoded by the Test Access Port (TAP) controller to control test operations. |
| JTAGTDI (Corporate Only) / GPIO14 / QST_BMBUSY# | I/O | Test Data Input (TDI): Serial test instructions and data are received by the test logic at TDI. |
| JTAGTDO (Corporate Only) / GPIO11 / SMBALERT# | I/O | Test Data Output (TDO): TDO is the serial output for test instructions and data from the test logic defined in this standard. |
| JTAGRST# (Corporate Only) / LINKALERT# / GPIO60 | I/O | Test Reset (RST): RST is an active low asynchronous signal that can reset the Test Access Port (TAP) controller. NOTE: The RST signal is optional per the IEEE 114.1 specification, and is not functional for Boundary Scan Testing |

NOTE: JTAG Pin definitions are from IEEE Standard Test Access Port and Boundary-Scan Architecture (IEEE Std. 1149.1-2001)

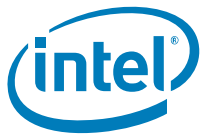

2.23 General Purpose I/O Signals

Table 2-23. General Purpose I/O Signals (Sheet 1 of 3)

| Name | Type | Tolerance | Power Well | Default | Description |
|----------------------------|------|-----------|------------|---------|---------------------------------------------------------------------------------------------------------------------------------------------------|
| GPIO72 (Corporate Only) | I/O | 3.3 V | Core | Native | ICH10 Consumer Family: Pin implemented as TP0 only. ICH10 Corporate Family: Pin is multiplexed with TP0. (NOTE 13) |
| GPIO63 (Corporate Only) | I/O | 3.3 V | Suspend | Native | ICH10 Consumer Family: Pin may only be used as SLP_S5#. ICH10 Corporate Family: Pin is multiplexed with SLP_S5# (NOTE 13) |
| GPIO62 (Corporate Only) | I/O | 3.3 V | Suspend | Native | ICH10 Consumer Family: Pin may only be used as SUSCLK ICH10 Corporate Family: Pin is multiplexed with SUSCLK (NOTE 13) |
| GPIO61 (Corporate Only) | I/O | 3.3 V | Suspend | Native | ICH10 Consumer Family: Pin May only be used as SUS_STAT# / LPCPD# ICH10 Corporate Family: Pin is multiplexed with SUS_STAT# / LPCPD# (NOTE 13) |
| GPIO60 | I/O | 3.3 V | Suspend | Native | ICH10 Consumer Family: Multiplexed with LINKALERT#. ICH10 Corporate Family: Multiplexed with LINKALERT# and JTAGRST#. (NOTE 13) |
| GPIO59 | I/O | 3.3 V | Suspend | Native | Multiplexed with OC[0]#. (NOTE 13) |
| GPIO57 | I/O | 3.3 V | Suspend | GPI | ICH10 Consumer Family: Can be used as TPM_PP. ICH10 Corporate Family Can be used as TPM_PP or JTAGTCK. |
| GPIO56 | I/O | 3.3 V | Suspend | GPI | UnMultiplexed |
| GPIO55 | I/O | 3.3 V | Core | Native | Multiplexed with GNT3# (Note 8). |
| GPIO54 | I/O | 5.0 V | Core | Native | Multiplexed with REQ3#. (NOTE 13) |
| GPIO53 | I/O | 3.3 V | Core | Native | Multiplexed with GNT2# (Note 8). |
| GPIO52 | I/O | 5.0 V | Core | Native | Multiplexed with REQ2#. (NOTE 13) |
| GPIO51 | I/O | 3.3 V | Core | Native | Multiplexed with GNT1# (Note 8). |
| GPIO50 | I/O | 5.0 V | Core | Native | Multiplexed with REQ1#. (NOTE 13) |
| GPIO49 | I/O | 3.3V | Core | GPO | UnMultiplexed (Note 8). |
| GPIO48 | I/O | 3.3 V | Core | GPI | Multiplexed with SDATAOUT1. |
| GPIO[47:44] | I/O | 3.3V | Suspend | Native | Multiplexed with OC[11:8]#. (NOTE 13) |
| GPIO[43:40] | I/O | 3.3 V | Suspend | Native | Multiplexed with OC[4:1]#. (NOTE 13) |
| GPIO39 | I/O | 3.3 V | Core | GPI | Multiplexed with SDATAOUT0. |
| GPIO38 | I/O | 3.3 V | Core | GPI | Multiplexed with SLOAD. |
| GPIO37 | I/O | 3.3 V | Core | GPI | Multiplexed with SATA3GP. |
| GPIO36 | I/O | 3.3 V | Core | GPI | Multiplexed with SATA2GP. |



Table 2-23. General Purpose I/O Signals (Sheet 2 of 3)

| Name | Type | Tolerance | Power Well | Default | Description |
|-------------------------------|------|----------------------------|------------|------------------|-------------------------------------------------------------------------------------------------------------------------------------|
| GPIO35 | I/O | 3.3 V | Core | GPO | Multiplexed with SATACLKREQ#. |
| GPIO34 | I/O | 1.5 V / 3.3 V (Note 12) | VccHDA | GPO | UnMultiplexed. |
| GPIO33 | I/O | 3.3 V | Core | GPO | UnMultiplexed. |
| GPIO32 | I/O | 3.3 V | Core | GPO | UnMultiplexed. |
| GPIO31 | I/O | 3.3 V | Suspend | Native | Multiplexed with OC7#. (NOTE 13) |
| GPIO30 | I/O | 3.3 V | Suspend | Native | Multiplexed with OC6#. (NOTE 13) |
| GPIO29 | I/O | 3.3 V | Suspend | Native | Multiplexed with OC5#. (NOTE 13) |
| GPIO28 | I/O | 3.3 V | Suspend | GPO | UnMultiplexed. |
| GPIO27 | I/O | 3.3 V | Suspend | GPO | UnMultiplexed |
| GPIO26 | I/O | 3.3 V | Suspend | Native | Multiplexed with S4_STATE#. (Note 9) |
| GPIO25 (Corporate Only) | I/O | 3.3 V | Suspend | Native | Default as STP_CPU# (Note 3). |
| GPIO24 | I/O | 3.3 V | Suspend | GPO | Can be used as MEM_LED. GPIO24 configuration register bits are not cleared by CF9h reset event. |
| GPIO23 | I/O | 3.3 V | Core | Native | Multiplexed with LDRQ1#. (NOTE 13) |
| GPIO22 | I/O | 3.3 V | Core | GPI | Multiplexed with SCLOCK. |
| GPIO21 | I/O | 3.3 V | Core | GPI | Multiplexed with SATAOGP. |
| GPIO20 | I/O | 3.3 V | Core | GPO | UnMultiplexed. (Note 8) |
| GPIO19 | I/O | 3.3 V | Core | GPI | Multiplexed with SATA1GP. |
| GPIO18 | I/O | 3.3 V | Core | GPO (Note 11) | UnMultiplexed. |
| GPIO17 | I/O | 3.3 V | Core | GPI | Multiplexed with TACH0. |
| GPIO16 | I/O | 3.3 V | Core | Native | May also be used as DPRSLPVR |
| GPIO15 | I/O | 3.3 V | Suspend | Native | default as STP_PCI#. (Note 3) |
| GPIO14 | I/O | 3.3 V | Suspend | GPI | ICH10 Consumer Family: Can be used as QST_BMBUSY#. ICH10 Corporate Family: Can be used as JTAGTD, or QST_BMBUSY#I. |
| GPIO13 | I/O | 3.3 V | Suspend | GPI | UnMultiplexed. |
| GPIO12 | I/O | 3.3 V | Suspend | GPO | Multiplexed with LAN_PHY_PWR_CTRL. (NOTE 13) |
| GPIO11 | I/O | 3.3 V | Suspend | Native | ICH10 Consumer Family: Can be used as SMBALERT#. (NOTE 13) ICH10 Corporate Family Can be used as SMBALERT# or JTAGTDO. (NOTE 13) |
| GPIO10 | I/O | 3.3 V | Suspend | GPI | ICH10 Consumer Family: Can be used as CPU_MISSING. ICH10 Corporate Family: Can be used as CPU_MISSING or JTAGTMS. |



Table 2-23. General Purpose I/O Signals (Sheet 3 of 3)

| Name | Type | Tolerance | Power Well | Default | Description |
|-----------|------|-----------|------------|--------------------------------------------------|-------------------------------------------------------------------------------------------|
| GPIO9 | I/O | 3.3 V | Suspend | Native | Can be used as WOL_EN. |
| GPIO8 | I/O | 3.3 V | Suspend | Corporate Only GPI Consumer Only Native | ICH10 Corporate Family: Can be used as DRAMPWROK. ICH10 Consumer Family: Unmultiplexed |
| GPIO[7:6] | I/O | 3.3 V | Core | GPI | Multiplexed with TACH[3:2]. |
| GPIO[5:2] | I/OD | 5 V | Core | GPI | Multiplexed with PIRQ[H:E]# (Note 6). |
| GPIO1 | I/O | 3.3 V | Core | GPI | Multiplexed with TACH1. |
| GPIO0 | I/O | 3.3 V | Core | GPI | Multiplexed with BMBUSY#. |

NOTES:

- All GPIOs can be configured as either input or output.
- GPIO[15:0] can be configured to cause a SMI# or SCI. Note that a GPI can be routed to either an SMI# or an SCI, but not both.
- Some GPIOs exist in the VccSus3_3 power plane. Care must be taken to make sure GPIO signals are not driven high into powered-down planes. Also, external devices should not be driving powered down GPIOs high. Some ICH10 GPIOs may be connected to pins on devices that exist in the core well. If these GPIOs are outputs, there is a danger that a loss of core power (PWROK low) or a Power Button Override event will result in the Intel ICH10 driving a pin to a logic 1 to another device that is powered down.
- The functionality that is multiplexed with the GPIO may not be utilized in desktop configuration.
- This GPIO is not an open-drain when configured as an output.
- SPI_CS1# is located in the VccCL3_3 well.
- When this signal is configured as GPO the output stage is an open-drain.
- This signal is sampled as a functional strap. See [Section 2.25.1](#) for more details.
- The GPIO_USE_SEL bit for this signal is overridden by bit 8 in the GEN_PMCON_3 Register (D31:F0).
- The GPIO_USE_SEL bit for this is ignored. Functionality is set by bits 9:8 of FLMAPO register.
- GPIO18 will toggle at a frequency of approximately 1 Hz when the ICH10 comes out of reset.
- The tolerance of this pin is determined by the voltage of VccHDA either 3.3 V or 1.5 V.
- When the multiplexed GPIO is used as GPIO functionality, care should be taken to ensure the signal is stable in its inactive state of the native functionality, immediately after reset until it is initialized to GPIO functionality.



2.24 Power and Ground Signals

Table 2-24. Power and Ground Signals (Sheet 1 of 2)

| Name | Description |
|-------------------|----------------------------------------------------------------------------------------------------------------------------------------------------------------------------------------------------------------------------------------------------------------------------------------------------------------|
| V5REF | Reference for 5 V tolerance on core well inputs. This power may be shut off in S3, S4, S5 or G3 states. |
| V5REF_Sus | Reference for 5 V tolerance on suspend well inputs. This power is not expected to be shut off unless the system is unplugged. |
| Vcc1_1 | 1.1 V supply for core well logic. This power may be shut off in S3, S4, S5 or G3 states. |
| Vcc1_5_A | 1.5 V supply for Logic and I/O. This power may be shut off in S3, S4, S5 or G3 states. |
| Vcc1_5_B | 1.5 V supply for Logic and I/O. This power may be shut off in S3, S4, S5 or G3 states. |
| Vcc3_3 | 3.3 V supply for core well I/O buffers. This power may be shut off in S3, S4, S5 or G3 states. |
| VccCL1_1 | 1.1V supply for Controller Link. This plane must be on in S0 and other times Controller Link is used. This voltage is generated internally (see Section 2.25.1 for strapping option) and, this pin can be left as No Connect unless decoupling is required. |
| VccCL1_5 | 1.5V supply for Controller Link. This plane must be on in S0 and other times Controller Link is used. This voltage is generated internally (see Section 2.25.1 for strapping option), and this pin can be left as No Connect unless decoupling is required. |
| VccCL3_3 | 3.3V supply for Controller Link. This is a separate power plane that may or may not be powered in S3–S5 states. This plane must be on in S0 and other times Controller Link is used. NOTE: VccCL3_3 must always be powered when VccLAN3_3 is powered. |
| VccDMI | Power supply for DMI. 1.05V, 1.25V or 1.5V depending on (G)MCH's DMI voltage. |
| VccDMIPLL | 1.5 V supply for core well logic. This signal is used for the DMI PLL. This power may be shut off in S3, S4, S5 or G3 states. |
| VccGLAN1_5 | 1.5V supply for integrated Gigabit LAN I/O buffers. This power is on in S0 and is turned off in S3, S4, S5, even it integrated Gigabit LAN is not used. |
| VccGLAN3_3 | 3.3V supply for integrated Gigabit LAN logic and I/O. This power is on in S0 and is turned off in S3, S4, S5, even it integrated Gigabit LAN is not used. |
| VccGLANPLL | 1.5V supply for core well logic. This signal is used for the integrated Gigabit LAN PLL. This power is shut off in S3, S4, S5 and G3 states. |
| VccHDA | Core supply for Intel High Definition Audio. This pin can be either 1.5 or 3.3 V. This power may be shut off in S3, S4, S5 or G3 states. NOTE: VccSusHDA and VccHDA can be connected to either 1.5 V or 3.3 V supplies, but both pins must be connected to supplies that are the same nominal value. |
| VccLAN1_1 | 1.1 V supply for LAN controller logic. This is a separate power plane that may or may not be powered in S3–S5 states. This voltage is generated internally (see Section 2.25.1 for strapping option) and, these pins can be left as No Connect unless decoupling is required. |

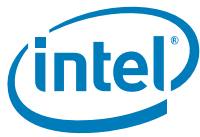

Table 2-24. Power and Ground Signals (Sheet 2 of 2)

| Name | Description |
|------------|------------------------------------------------------------------------------------------------------------------------------------------------------------------------------------------------------------------------------------------------------------------------------------------------------------------------------------------------------------------------|
| VccLAN3_3 | 3.3 V supply for LAN Connect interface buffers. This is a separate power plane that may or may not be powered in S3–S5 states. This plane must be on in S0. NOTE: VccLAN3_3 must always be powered when VccCL3_3 or Vcc3_3 is powered. |
| VccRTC | 3.3 V (can drop to 2.0 V min. in G3 state) supply for the RTC well. This power is not expected to be shut off unless the RTC battery is removed or completely drained. Note: Implementations should not attempt to clear CMOS by using a jumper to pull VccRTC low. Clearing CMOS in an Intel ICH10-based platform can be done by using a jumper on RTCRST# or GPI. |
| VccSATAPLL | 1.5 V supply for core well logic. This signal is used for the SATA PLL. This power may be shut off in S3, S4, S5 or G3 states. Must be powered even if SATA is not used. |
| VccSus1_1 | 1.1 V supply for suspend well logic. This power is not expected to be shut off unless the system is unplugged. This voltage is generated internally (see Section 2.25.1 for strapping option). These pins can be left as No Connects unless decoupling is required. |
| VccSus1_5 | 1.5V supply for the suspend well I/O. This power is not expected to be shut off unless the system is unplugged. This voltage is generated internally (see Section 2.25.1 for strapping option). These pins can be left as No Connects unless decoupling is required. |
| VccSus3_3 | 3.3 V supply for suspend well I/O buffers. This power is not expected to be shut off unless the system is unplugged. |
| VccSusHDA | Suspend supply for Intel® High Definition Audio. This pin can be either 1.5 or 3.3 V. T NOTE: VccSusHDA and VccHDA can be connected to either 1.5 V or 3.3 V supplies, but both pins must be connected to supplies that are the same nominal value. |
| VccUSBPLL | 1.5 V supply for core well logic. This signal is used for the USB PLL. This power may be shut off in S3, S4, S5 or G3 states. Must be powered even if USB not used. |
| Vss | Grounds. |
| V_CPU_IO | Powered by the same supply as the processor I/O voltage. This supply is used to drive the processor interface signals listed in Table 2-12 . |



2.25 Pin Straps

2.25.1 Functional Straps

The following signals are used for static configuration. They are sampled at the rising edge of PWROK to select configurations (except as noted), and then revert later to their normal usage. To invoke the associated mode, the signal should be driven at least four PCI clocks prior to the time it is sampled.

The ICH10 has implemented Soft Straps. Soft Straps are used to configure specific functions within the ICH and (G)MCH very early in the boot process before BIOS or SW intervention. When Descriptor Mode is enabled, the ICH will read Soft Strap data out of the SPI device prior to the de-assertion of reset to both the Intel Management Engine and the Host system. Refer to [Section 5.23.2](#) for information on Descriptor Mode and [Section](#) for more information on Soft Straps and their settings.

Table 2-25. Functional Strap Definitions (Sheet 1 of 4)

| Signal | Usage | When Sampled | Comment |
|--------------------------------|-------------------------------------------------------------|----------------------|-----------------------------------------------------------------------------------------------------------------------------------------------------------------------------------------------------------------------------------------------------------------------------------------------------------------------------------------------------------------------------------------------------------------------------------------------------|
| HDA_SDOUT | XOR Chain Entrance | Rising Edge of PWROK | Allows entrance to XOR Chain testing when TP3 pulled low at rising edge of PWROK. |
| HDA_SDOUT | PCI Express* Port Config 1 bit 1 (Port 1-4) (Consumer Only) | Rising Edge of PWROK | When TP3 not pulled low at rising edge of PWROK, sets bit 1 of RPC.PC (Chipset Config Registers: Offset 224h). This signal has a weak internal pull-down. |
| HDA_SYNC (Consumer Only) | PCI Express Port Config 1 bit 0 (Port 1-4) | Rising Edge of PWROK | This signal has a weak internal pull-down. Sets bit 0 of RPC.PC (Chipset Config Registers: Offset 224h) |
| GNT2# / GPIO53 (Consumer Only) | PCI Express Port Config 2 bit 2 (Port 5-6) | Rising Edge of PWROK | This signal has a weak internal pull-up. Sets bit 2 of RPC.PC2 (Chipset Config Registers: Offset 0224h) when sampled low. |
| GPIO20 | Reserved | Rising Edge of PWROK | This signal has a weak internal pull-down. NOTE: This signal should not be pulled high |
| GNT1#/GPIO51 | ESI Strap (Server/ Workstation Only) | Rising edge of PWROK | Tying this strap low configures DMI for ESI-compatible operation. This signal has a weak internal pull-up. NOTE: ESI compatible mode is for server platforms only. This signal should not be pulled low for desktop. |
| GNT3# / GPIO55 | Top-Block Swap Override | Rising Edge of PWROK | The signal has a weak internal pull-up. If the signal is sampled low, this indicates that the system is strapped to the "top-block swap" mode (Intel ICH10 inverts A16 for all cycles targeting BIOS space). The status of this strap is readable via the Top Swap bit (Chipset Config Registers: Offset 3414h: bit 0). Note that software will not be able to clear the Top-Swap bit until the system is rebooted without GNT3# being pulled down. |



Table 2-25. Functional Strap Definitions (Sheet 2 of 4)

| Signal | Usage | When Sampled | Comment | | | | | | | | | | | | | | | |
|--------|-----------------------------------|-----------------------|------------------------------------------------------------------------------------------------------------------------------------------------------------------------------------------------------------------------------------------------------------------------------------------------------------------------------------------------------------------------------------------------------------------------------------------------------------------------------------------------------------------------------------------------------------------------------------------------------------------------------------------------------------------------------------------------------------------------------------------------------------------------------------------------------------------------------------------------------------------------------------------------------------------------------------------------------------------------------------------------------------------------------------------------------------------------------------------------------------------------------------------------|-------|--------|-----------------------|---|---|-----|---|---|-----|---|---|-----|---|---|----------|
| GNT0# | Boot BIOS Destination Selection 0 | Rising Edge of PWROK | <p>This field determines the destination of accesses to the BIOS memory range. Signals have weak internal pull-ups. Also controllable via Boot BIOS Destination bit (Chipset Config Registers: Offset 3410h:bit 11). This strap is used in conjunction with Boot BIOS Destination Selection 1 strap.</p> <table border="1"> <thead> <tr> <th>Bit11</th> <th>Bit 10</th> <th>Boot BIOS Destination</th> </tr> </thead> <tbody> <tr> <td>0</td> <td>1</td> <td>SPI</td> </tr> <tr> <td>1</td> <td>0</td> <td>PCI</td> </tr> <tr> <td>1</td> <td>1</td> <td>LPC</td> </tr> <tr> <td>0</td> <td>0</td> <td>Reserved</td> </tr> </tbody> </table> <p>NOTE: If option 11 LPC is selected, BIOS may still be placed on LPC, but all platforms with ICH10 (Corporate Only) require SPI flash connected directly to the ICH's SPI bus with a valid descriptor in order to boot.</p> <p>NOTE: Booting to PCI is intended for debut/testing only. Boot BIOS Destination Select to LPC/PCI by functional strap or via Boot BIOS Destination Bit will not affect SPI accesses initiated by Intel Management Engine or Integrated GbE LAN.</p> | Bit11 | Bit 10 | Boot BIOS Destination | 0 | 1 | SPI | 1 | 0 | PCI | 1 | 1 | LPC | 0 | 0 | Reserved |
| Bit11 | Bit 10 | Boot BIOS Destination | | | | | | | | | | | | | | | | |
| 0 | 1 | SPI | | | | | | | | | | | | | | | | |
| 1 | 0 | PCI | | | | | | | | | | | | | | | | |
| 1 | 1 | LPC | | | | | | | | | | | | | | | | |
| 0 | 0 | Reserved | | | | | | | | | | | | | | | | |



Table 2-25. Functional Strap Definitions (Sheet 3 of 4)

| Signal | Usage | When Sampled | Comment | | | | | | | | | | | | | | | |
|--------------------------|---------------------------------------|------------------------|-----------------------------------------------------------------------------------------------------------------------------------------------------------------------------------------------------------------------------------------------------------------------------------------------------------------------------------------------------------------------------------------------------------------------------------------------------------------------------------------------------------------------------------------------------------------------------------------------------------------------------------------------------------------------------------------------------------------------------------------------------------------------------------------------------------------------------------------------------------------------------------------------------------------------------------------------------------------------------------------------------------------------------------------------------------------------------------------------------------------------------------------------|-------|--------|-----------------------|---|---|-----|---|---|-----|---|---|-----|---|---|----------|
| SPI_CS1# | Boot BIOS Destination Selection 1 | Rising Edge of CLPWROK | <p>This field determines the destination of accesses to the BIOS memory range. Signals have weak internal pull-ups. Also controllable via Boot BIOS Destination bit (Chipset Config Registers: Offset 3410h:bit 10). This strap is used in conjunction with Boot BIOS Destination Selection 0 strap.</p> <table border="1"> <thead> <tr> <th>Bit11</th> <th>Bit 10</th> <th>Boot BIOS Destination</th> </tr> </thead> <tbody> <tr> <td>0</td> <td>1</td> <td>SPI</td> </tr> <tr> <td>1</td> <td>0</td> <td>PCI</td> </tr> <tr> <td>1</td> <td>1</td> <td>LPC</td> </tr> <tr> <td>0</td> <td>0</td> <td>Reserved</td> </tr> </tbody> </table> <p>NOTE: If option 11 LPC is selected BIOS may still be placed on LPC, but all platforms with ICH10 (Corporate Only) require SPI flash connected directly to the ICH's SPI bus with a valid descriptor in order to boot.</p> <p>NOTE: Booting to PCI is intended for debut/testing only. Boot BIOS Destination Select to LPC/PCI by functional strap or via Boot BIOS Destination Bit will not affect SPI accesses initiated by Intel Management Engine or Integrated GbE LAN.</p> | Bit11 | Bit 10 | Boot BIOS Destination | 0 | 1 | SPI | 1 | 0 | PCI | 1 | 1 | LPC | 0 | 0 | Reserved |
| Bit11 | Bit 10 | Boot BIOS Destination | | | | | | | | | | | | | | | | |
| 0 | 1 | SPI | | | | | | | | | | | | | | | | |
| 1 | 0 | PCI | | | | | | | | | | | | | | | | |
| 1 | 1 | LPC | | | | | | | | | | | | | | | | |
| 0 | 0 | Reserved | | | | | | | | | | | | | | | | |
| SATALED# (Consumer Only) | PCI Express Lane Reversal (Lanes 1-4) | Rising Edge of PWROK | Signal has weak internal pull-up. Sets bit 27 of MPC.LR (Device 28: Function 0: Offset D8) | | | | | | | | | | | | | | | |
| SPKR | No Reboot | Rising Edge of PWROK | The signal has a weak internal pull-down. If the signal is sampled high, this indicates that the system is strapped to the "No Reboot" mode (ICH10 will disable the TCO Timer system reboot feature). The status of this strap is readable via the NO REBOOT bit (Chipset Config Registers: Offset 3410h:bit 5). | | | | | | | | | | | | | | | |
| TP3 | XOR Chain Entrance | Rising Edge of PWROK | See Intel® ICH10 Family XOR Chains In-Circuit Tester Package for functionality information. This signal has a weak internal pull-up. NOTE: This signal should not be pulled low unless using XOR Chain testing. | | | | | | | | | | | | | | | |

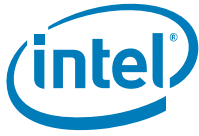
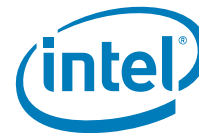

Table 2-25. Functional Strap Definitions (Sheet 4 of 4)

| Signal | Usage | When Sampled | Comment |
|------------------------------|---------------------------------------------------|---------------------------|--------------------------------------------------------------------------------------------------------------------------------------------------------------------------------------------------------------------------------------------------------------------------------------------------------------------------------------------------------------------------------------------------------------------------------|
| GPIO33 / HDA_DOCK_EN# | Flash Descriptor Security Override Strap | Rising Edge of PWROK | If sampled low, the Flash Descriptor Security will be overridden. If high, the security measures defined in the Flash Descriptor will be in effect. NOTE: This strap should only be enabled in manufacturing environments using an external pull-down resistor. NOTE: Asserting the GPIO33 low on the rising edge of PWROK will also disable Intel Management Engine and Intel Management Engine features. |
| GPIO49 | DMI Termination Voltage | Rising Edge of PWROK | This signal has a weak internal pull-up. NOTE: When DMI is DC coupled this signal should not be pulled low during the time the strap is sampled. NOTE: When DMI is AC coupled, this signal should be pulled low during the time the strap is sampled. |
| SPI_MOSI (Corporate Only) | Integrated TPM Enable | Rising Edge of CLPWROK | This signal has a weak internal pull-down resistor. When the signal is sampled low the Integrated TPM will be disabled. When the signal is sampled high, the (G)MCH TPM enable strap is sampled low and the TPM Disable bit is clear, the Integrated TPM will be enabled. NOTE: For Consumer applications this signal is required to be floating or pulled low. |

NOTE: See [Section 3.1](#) for full details on pull-up/pull-down resistors.



2.25.2 External RTC Circuitry

The ICH10 implements an internal oscillator circuit that is sensitive to step voltage changes in VccRTC. Figure 2-1 shows an example schematic recommended to ensure correct operation of the ICH10 RTC.

Figure 2-1. Example External RTC Circuit

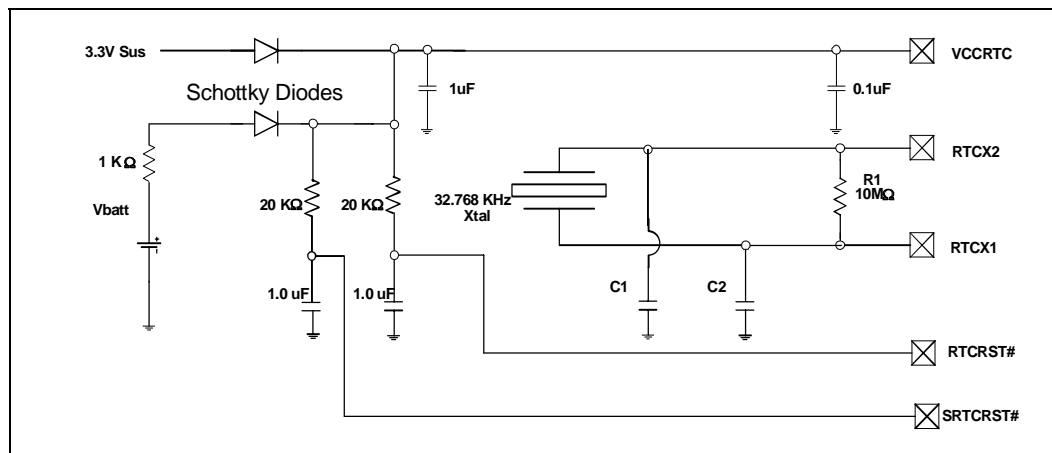

NOTE: C1 and C2 depend on crystal load.

§ §





3 Intel® ICH10 Pin States

3.1 Integrated Pull-Ups and Pull-Downs

Table 3-1. Integrated Pull-Up and Pull-Down Resistors

| Signal | Resistor Type | Nominal Value | Notes |
|---------------------------------|----------------------|----------------|-----------|
| CL_CLK0 | Pull-up | 20 kΩ | 13 |
| CL_DATA0 | Pull-up | 20 kΩ | 13 |
| CL_RST0# | Pull-up | 10 kΩ | 4 |
| DPRS LPVR/GPIO16 | Pull-down | 20 kΩ | 2, 10 |
| HDA_BIT_CLK | Pull-down | 20 kΩ | 1, 9 |
| HDA_DOCK_EN#/GPIO33 | Pull-up | 20 kΩ | 3, 7 |
| HDA_RST# | Pull-down | 20 kΩ | 2 |
| HDA_SDIN[3:0] | Pull-down | 20 kΩ | 2 |
| HDA_SDOUT | Pull-down | 20 kΩ | 2, 7 |
| HDA_SYNC | Pull-down | 20 kΩ | 2, 7 |
| GLAN_DOCK# | Pull-up PULL-down | 20 kΩ 20 kΩ | 3, 14 |
| GNT0#, GNT[3:1]#/GPIO[55,53,51] | Pull-up | 20 kΩ | 3, 11, 12 |
| GPIO20 | Pull-down | 20 kΩ | 3, 7 |
| GPIO49 | Pull-up | 20 kΩ | 3, 7 |
| LAD[3:0]# / FHW[3:0]# | Pull-up | 20 kΩ | 3 |
| LAN_RXD[2:0] | Pull-up | 20 kΩ | 4 |
| LDRQ0 | Pull-up | 20 kΩ | 3 |
| LDRQ1 / GPIO23 | Pull-up | 20 kΩ | 3 |
| PME# | Pull-up | 20 kΩ | 3 |
| PWRBTN# | Pull-up | 20 kΩ | 3 |
| SATALED# | Pull-up | 15 kΩ | 8 |
| SPI_CS1# | Pull-up | 20 kΩ | 3, 10 |
| SPI_MOSI | Pull-down | 20 kΩ | 3, 7 |
| SPI_MISO | Pull-up | 20 kΩ | 3 |
| SPKR | Pull-down | 20 kΩ | 2 |
| TACH[3:0] | Pull-up | 20 kΩ | 3 |
| TP3 | Pull-up | 20 kΩ | 6 |
| USB[11:0] [P,N] | Pull-down | 15 kΩ | 5 |

NOTES:

1. Simulation data shows that these resistor values can range from 10 kΩ to 40 kΩ.
2. Simulation data shows that these resistor values can range from 9 kΩ to 50 kΩ.



3. Simulation data shows that these resistor values can range from 15 k Ω to 35 k Ω .
4. Simulation data shows that these resistor values can range from 7.5 k Ω to 16 k Ω .
5. Simulation data shows that these resistor values can range from 14.25 k Ω to 24.8 k Ω .
6. Simulation data shows that these resistor values can range from 10 k Ω to 30 k Ω .
7. The pull-up or pull-down on this signal is only enabled at boot/reset for strapping function.
8. Simulation data shows that these resistor values can range from 10 k Ω to 20 k Ω . The internal pull-up is only enabled during PLTRST# assertion.
9. The pull-down on this signal is only enabled when in S3.
10. The pull-up or pull-down on this signal is only enabled during reset.
11. The pull-up on this signal is not enabled when PCIRST# is high.
12. The pull-up on this signal is not enabled when PWROK is low.
13. Simulation data shows that these resistor values can range from 15 k Ω to 31 k Ω .
14. The pull-up or pull-down on this pin is only active when configured for native GLAN_DOCK# functionality and is determined by the LAN controller.



3.2 Output and I/O Signals Planes and States

Table 3-2 shows the power plane associated with the output and I/O signals, as well as the state at various times. Within the table, the following terms are used:

| | |
|-------------|--------------------------------------------------------------------------------------------------------------------|
| “High-Z” | Tri-state. ICH10 not driving the signal high or low. |
| “High” | ICH10 is driving the signal to a logic 1. |
| “Low” | ICH10 is driving the signal to a logic 0. |
| “Defined” | Driven to a level that is defined by the function or external pull-up/pull-down resistor (will be high or low). |
| “Undefined” | ICH10 is driving the signal, but the value is indeterminate. |
| “Running” | Clock is toggling or signal is transitioning because function not stopping. |
| “Off” | The power plane is off; ICH10 is not driving when configured as an output or sampling when configured as an input. |
| “Input” | ICH10 is sampling and signal state determined by external driver. |

Note: Signal levels are the same in S4 and S5, except as noted.

The ICH10 suspend well signal states are indeterminate and undefined and may glitch prior to RSMRST# deassertion. This does not apply to LAN_RST#, SLP_S3#, SLP_S4#, S4_STATE# and SLP_S5#. These signals are determinate and defined prior to RSMRST# deassertion.

The ICH10 core well signal states are indeterminate and undefined and may glitch prior to PWROK assertion. This does not apply to FERR# and THRMTRIP#. These signals are determinate and defined prior to PWROK assertion.

Table 3-2. Power Plane and States for Output and I/O Signals for Configurations (Sheet 1 of 5)

| Signal Name | Power Plane | During Reset ⁴ | Immediately after Reset ⁴ | C3/C4 | S1 | S3 | S4/S5 |
|------------------------------------------------------------------------|-------------|---------------------------|--------------------------------------|-------|---------|-----|-------|
| PCI Express* | | | | | | | |
| PETp[5:1], PETn[5:1], PETp6 / GLANTXp, PETn6 / GLANTXn | Core | High | High ⁸ | | Defined | Off | Off |
| DMI | | | | | | | |
| DMI[3:0]TXP, DMI[3:0]TXN | Core | High | High | | Defined | Off | Off |
| PCI Bus | | | | | | | |
| AD[31:0] | Core | Low | Undefined | | Defined | Off | Off |
| C/BE[3:0]# | Core | Low | Undefined | | Defined | Off | Off |
| DEVSEL# | Core | High-Z | High-Z | | High-Z | Off | Off |
| FRAME# | Core | High-Z | High-Z | | High-Z | Off | Off |
| GNT0# ¹¹ , GNT[3:1]# ¹¹ / GPIO[55, 53, 51] | Core | High-Z | High | | High | Off | Off |
| IRDY#, TRDY# | Core | High-Z | High-Z | | High-Z | Off | Off |



Table 3-2. Power Plane and States for Output and I/O Signals for Configurations (Sheet 2 of 5)

| Signal Name | Power Plane | During Reset ⁴ | Immediately after Reset ⁴ | C3/C4 | S1 | S3 | S4/S5 |
|----------------------------------------------|-------------|---------------------------|--------------------------------------|-------|---------|---------|---------|
| PAR | Core | Low | Undefined | | Defined | Off | Off |
| PCIRST# | Suspend | Low | High | | High | Low | Low |
| PERR# | Core | High-Z | High-Z | | High-Z | Off | Off |
| PLOCK# | Core | High-Z | High-Z | | High-Z | Off | Off |
| STOP# | Core | High-Z | High-Z | | High-Z | Off | Off |
| LPC Interface | | | | | | | |
| LAD[3:0] / FWH[3:0] | Core | High | High | | High | Off | Off |
| LFRAME# / FWH[4] | Core | High | High | | High | Off | Off |
| LPCPD# / SUS_STAT# / GPIO61 (Corporate Only) | Suspend | Low | High | | High | Low | Low |
| Firmware Hub | | | | | | | |
| INIT3_3V# | Core | High | High | | High | Off | Off |
| LAN Connect Interface | | | | | | | |
| LAN_RSTSYNC | LAN | High | Low | | Defined | Defined | Defined |
| LAN_TXD[2:0] | LAN | Low | Low | | Defined | Defined | Defined |
| Gigabit LAN Connect Interface | | | | | | | |
| GLAN_TXp / PETp6, GLAN_TXn / PETn6 | GLAN | High | High | | Defined | Off | Off |
| LAN_RSTSYNC | LAN | High | Low | | Defined | Defined | Defined |
| SATA Interface | | | | | | | |
| SATA[5:0]TXP, SATA[5:0]TXN | Core | High-Z | High-Z | | Defined | Off | Off |
| SATALED# ¹¹ | Core | High-Z | High-Z | | Defined | Off | Off |
| SATARBIAS | Core | High-Z | High-Z | | Defined | Off | Off |
| SATACLKREQ# / GPIO35 | Core | Low | Low | | Defined | Off | Off |
| SCLOCK/GPIO22 | Core | Input | Input | | Defined | Off | Off |
| SLOAD/GPIO38 | Core | Input | Input | | Defined | Off | Off |
| SDATAOUT[1:0]/ GPIO[48,39] | Core | Input | Input | | Defined | Off | Off |
| Interrupts | | | | | | | |
| PIRQ[A:D]#, | Core | High-Z | High-Z | | High-Z | Off | Off |
| PIRQ[H:E]# / GPIO[5:2] | Core | Input | Input | | Defined | Off | Off |
| SERIRQ | Core | High-Z | High-Z | | High-Z | Off | Off |
| USB Interface | | | | | | | |
| USB[11:0][P,N] | Suspend | Low | Low | | Defined | Defined | Defined |
| USBRBIAS | Suspend | High-Z | High-Z | | Defined | Defined | Defined |
| Power Management | | | | | | | |
| DPRSLPVR | Core | Low | Low | | High | Off | Off |

Table 3-2. Power Plane and States for Output and I/O Signals for Configurations (Sheet 3 of 5)

| Signal Name | Power Plane | During Reset ⁴ | Immediately after Reset ⁴ | C3/C4 | S1 | S3 | S4/S5 | |
|-------------------------------------------------------|-------------|-----------------------------------|--------------------------------------|---------|---------|-------------------------------|-------------------------------|--|
| DPRSTP# | CPU | High | High | | High | Off | Off | |
| PLTRST# | Suspend | Low | High | | High | Low | Low | |
| SLP_M# ⁹ | Suspend | Low | High | | High | Defined | Defined | |
| SLP_S3# | Suspend | Low | High | | High | Low | Low | |
| SLP_S4# | Suspend | Low | High | | High | High | Defined | |
| S4_STATE# / GPIO26 | Suspend | Low | Defined | | Defined | Defined | Defined | |
| SLP_S5# / GPIO63 (Corporate Only) | Suspend | Low | High | | High | High | Low ⁶ | |
| SUS_STAT# / LPCPD# / GPIO61 (Corporate Only) | Suspend | Low | High | | High | Low | Low | |
| SUSCLK | Suspend | Low | Running | | | | | |
| CK_PWRGD | Suspend | Low | High | | High | Low | Low | |
| STP_PCI# / GPIO15 | Suspend | High | High | | Defined | Defined | Defined | |
| STP_CPU# / GPIO25 (Corporate Only) | Suspend | High | High | | Defined | Defined | Defined | |
| Corporate Only: DRAMPWROK / GPIO8 | Suspend | Low | Low | Defined | Defined | Defined/ Low ¹² | Defined/ Low ¹² | |
| Processor Interface | | | | | | | | |
| DPSLP# | CPU | High | High | | High | Off | Off | |
| A20M# | CPU | Dependant on A20GATE Signal | See Note 1 | | High | Off | Off | |
| CPUPWRGD | CPU | Low ³ | High | | High | Off | Off | |
| IGNNE# | CPU | High | See Note 1 | | High | Off | Off | |
| INIT# | CPU | High | High | | High | Off | Off | |
| INTR | CPU | See Note 5 | See Note 5 | | Low | Off | Off | |
| NMI | CPU | See Note 5 | See Note 5 | | Low | Off | Off | |
| SMI# | CPU | High | High | | High | Off | Off | |
| STPCLK# | CPU | High | High | | Low | Off | Off | |
| SMBus Interface | | | | | | | | |
| SMBCLK, SMBDATA | Suspend | High-Z | High-Z | | Defined | Defined | Defined | |
| System Management Interface | | | | | | | | |
| MEM_LED / GPIO24 | Suspend | Low | Low | | Defined | Defined | Defined | |
| CPU_MISSING / GPIO10 / JTAGTMS (Corporate Only) | Suspend | Input | Input | | Defined | Defined | Defined | |
| GPIO14 / JTAGTDI (Corporate Only) / QST_BMBUSY# | Suspend | Input | Input | | Defined | Defined | Defined | |
| WOL_EN / GPIO9 | Suspend | High-Z | High-Z | | Defined | Defined | Defined | |

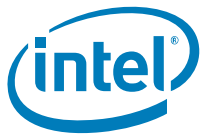

Table 3-2. Power Plane and States for Output and I/O Signals for Configurations (Sheet 4 of 5)

| Signal Name | Power Plane | During Reset ⁴ | Immediately after Reset ⁴ | C3/C4 | S1 | S3 | S4/S5 |
|-------------------------------------------------|-----------------|---------------------------|--------------------------------------|-------|-----------------------|-----------------------|-----------------------|
| LINKALERT# / GPIO60 / JTAGRST# (Corporate Only) | Suspend | High-Z | High-Z | | Defined | Defined | Defined |
| TPM_PP / GPIO57 / JTAGTCK (Corporate Only) | Suspend | Input | Input | | Defined | Defined | Defined |
| SPI_CS[1]# ¹¹ | Suspend | High | High | | Defined | Defined | Defined |
| SMLINK[1:0] | Suspend | High-Z | High-Z | | Defined | Defined | Defined |
| Miscellaneous Signals | | | | | | | |
| SPKR ¹¹ | Core | High-Z | Low | | Defined | Off | Off |
| Intel® High Definition Audio Interface | | | | | | | |
| HDA_RST# | HDA Suspend | Low | Low ⁷ | | Defined | Low | Low |
| HDA_SDOUT ¹¹ | HDA | Low | Low | | Low | Off | Off |
| HDA_SYNC | HDA | Low | Low | | Low | Off | Off |
| HDA_BIT_CLK | HDA | Low | Low | | Low | Off | Off |
| UnMultiplexed GPIO Signals | | | | | | | |
| GPIO0 / BMBUSY# | Core | Input | Input | | Defined | Off | Off |
| Consumer Only: GPIO8 | Suspend | Input | Input | | Defined | Defined | Defined |
| GPIO12 / LAN_PHY_PWR_CTRL | Suspend | Low | Low | | Defined | Defined | Defined |
| GPIO13 | Suspend | Input | Input | | Defined | Defined | Defined |
| GPIO16/DPRSLPVR | Core | Low | Low | | Defined | Off | Off |
| GPIO18 | Core | High | See Note 2 | | Defined | Off | Off |
| GPIO20 ¹¹ | Core | Low | High | | Defined | Off | Off |
| GPIO[28:27] | Suspend | Low | Low | | Defined | Defined | Defined |
| GPIO33 ¹¹ , GPIO32 | Core | High | High | | Defined | Off | Off |
| GPIO34 | HDA | Low | Low | | Defined | Off | Off |
| GPIO49 ¹¹ | Core | High | High | | Defined | Off | Off |
| GPIO56 | Suspend | Input | Input | | Defined | Defined | Defined |
| SPI Interface | | | | | | | |
| SPI_CS0# | Controller Link | High | High | | Defined | Defined | Defined |
| SPI_CS1# ¹¹ | Controller Link | High | High | | Defined | Defined | Defined |
| SPI_MOSI ¹¹ | Controller Link | Low | Low | | Defined | Defined | Defined |
| SPI_CLK | Controller Link | Low | Low | | Running | Defined | Defined |
| Controller Link | | | | | | | |
| CL_CLK0 | Controller Link | Low | Low | | Defined ¹⁰ | Defined ¹⁰ | Defined ¹⁰ |



Table 3-2. Power Plane and States for Output and I/O Signals for Configurations (Sheet 5 of 5)

| Signal Name | Power Plane | During Reset ⁴ | Immediately after Reset ⁴ | C3/C4 | S1 | S3 | S4/S5 |
|---------------------------------------|-----------------|---------------------------|--------------------------------------|-------|-----------------------|-----------------------|-----------------------|
| CL_DATA0 | Controller Link | Low | Low | | Defined ¹⁰ | Defined ¹⁰ | Defined ¹⁰ |
| CL_RST0# | Suspend | Low | High | | Defined ¹⁰ | Defined ¹⁰ | Defined ¹⁰ |
| Intel® Quiet System Technology | | | | | | | |
| PWM[2:0] | Core | High-Z | Low | | Defined | Off | Off |
| SST | Controller Link | High-Z | Low | | Defined | Off | Off |
| PECI | CPU | High-Z | Low | | Defined | Off | Off |

NOTES:

1. ICH10 drives these signals High after the processor Reset
2. GPIO[18] will toggle at a frequency of approximately 1 Hz when the ICH10 comes out of reset
3. CPUPWRGD represents a logical AND of the ICH10's VRMPWRGD and PWROK signals, and thus will be driven low by ICH10 when either VRMPWRGD or PWROK are inactive. During boot, or during a hard reset with power cycling, CPUPWRGD will be expected to transition from low to High-Z.
4. The states of Core and processor signals are evaluated at the times During PLTRST# and Immediately after PLTRST#. The states of the LAN and GLAN signals are evaluated at the times During LAN_RST# and Immediately after LAN_RST#. The states of the Controller Link signals are taken at the times During CL_RST# and Immediately after CL_RST#. The states of the Suspend signals are evaluated at the times During RSMRST# and Immediately after RSMRST#. The states of the HDA signals are evaluated at the times During HDA_RST# and Immediately after HDA_RST#.
5. ICH10 drives these signals Low before PWROK rising and Low after the processor Reset.
6. SLP_S5# signals will be high in the S4 state.
7. Low until Intel High Definition Audio Controller Reset bit set (D27:F0:Offset HDBAR+08h:bit 0), at which time HDA_RST# will be High and HDA_BIT_CLK will be Running.
8. PETp/n[6:1] high until port is enabled by software.
9. The SLP_M# state will be determined by Intel AMT Policies.
10. The state of signals in S3-5 will be defined by Intel AMT Policies.
11. This signal is sampled as a functional strap during reset.
12. The state of DRAMPWROK during S3/S4/S5 is dependent on the SLP_S4# and CLPWROK signals.



3.3 Power Planes for Input Signals

Table 3-3 shows the power plane associated with each input signal, as well as what device drives the signal at various times. Valid states include:

- High
- Low
- Static: Will be high or low, but will not change
- Driven: Will be high or low, and is allowed to change
- Running: For input clocks

The ICH10 suspend well signal states are indeterminate and undefined and may glitch prior to RSMRST# deassertion. This does not apply to LAN_RST#, SLP_S3#, SLP_S4#, S4_STATE# and SLP_S5#. These signals are determinate and defined prior to RSMRST# deassertion.

The ICH10 core well signal states are indeterminate and undefined and may glitch prior to PWROK assertion. This does not apply to FERR# and THRMTRIP#. These signals are determinate and defined prior to PWROK assertion.

Table 3-3. Power Plane for Input Signals for Configurations (Sheet 1 of 3)

| Signal Name | Power Well | Driver During Reset | C3/C4 | S1 | S3 | S4/S5 |
|-----------------------------------------------------------------------------------------------------|------------|-----------------------|-------|---------|--------|--------|
| DMI | | | | | | |
| DMI_CLKP, DMI_CLKN | Core | Clock Generator | | Running | Off | Off |
| DMI[3:0]RXP, DMI[3:0]RXN | Core | (G)MCH | | Driven | Off | Off |
| PCI Express* | | | | | | |
| PERp[5:1], PERn[5:1], PERp6 / GLAN_RXp, PERn6 / GLAN_RXn | Core | PCI Express* Device | | Driven | Off | Off |
| PCI Bus | | | | | | |
| REQ0#, REQ1# / GPIO50 ¹ REQ2# / GPIO52 ¹ REQ3# / GPIO54 ¹ | Core | External Pull-up | | Driven | Off | Off |
| PCICLK | Core | Clock Generator | | Running | Off | Off |
| PME# | Suspend | Internal Pull-up | | Driven | Driven | Driven |
| SERR# | Core | PCI Bus Peripherals | | High | Off | Off |
| LPC Interface | | | | | | |
| LDRQ0# | Core | LPC Devices | | High | Off | Off |
| LDRQ1# / GPIO23 ¹ | Core | LPC Devices | | High | Off | Off |
| LAN Connect Interface | | | | | | |
| GLAN_CLK | Suspend | LAN Connect Component | | Driven | Off | Off |
| LAN_RXD[2:0] | Suspend | LAN Connect Component | | Driven | Driven | Driven |

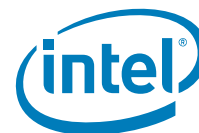

Table 3-3. Power Plane for Input Signals for Configurations (Sheet 2 of 3)

| Signal Name | Power Well | Driver During Reset | C3/C4 | S1 | S3 | S4/S5 |
|--------------------------------------------------------------------------------------------------------|------------|--------------------------------------------------|-------|---------|--------|--------|
| Gigabit LAN Connect Interface | | | | | | |
| GLAN_RXp / PERp6, GLAN_RXn / PERn6 | Suspend | Gigabit Lan Connect Component | | Driven | Off | Off |
| SATA Interface | | | | | | |
| SATA_CLKP, SATA_CLKN | Core | Clock Generator | | Running | Off | Off |
| SATA[5:0]RXP, SATA[5:0]RXN | Core | SATA Drive | | Driven | Off | Off |
| SATARBIAS# | Core | External Pull-down | | Driven | Off | Off |
| SATA[5:4]GP SATA[3:0]GP / GPIO[37, 36, 19, 21] ¹ | Core | External Device or External Pull-up/Pull-down | | Driven | Off | Off |
| USB Interface | | | | | | |
| OC0# / GPIO59, OC[4:1]# / GPIO[43:40], OC[7:5]# / GPIO [31:29], OC[11:8]# / GPIO[47:44] | Suspend | External Pull-ups | | Driven | Driven | Driven |
| USBRBIAS# | Suspend | External Pull-down | | Driven | Driven | Driven |
| Power Management | | | | | | |
| BMBUSY# /GPIO0 ¹ | Core | Graphics Component [(G)MCH] | | Driven | High | Off |
| CLPWROK | Suspend | External Circuit | | Driven | Driven | Driven |
| LAN_RST# | Suspend | External Circuit | | High | High | High |
| MCH_SYNC# | Core | (G)MCH | | Driven | Off | Off |
| PWRBTN# | Suspend | Internal Pull-up | | Driven | Driven | Driven |
| PWROK | RTC | System Power Supply | | Driven | Off | Off |
| RI# | Suspend | Serial Port Buffer | | Driven | Driven | Driven |
| RSMRST# | RTC | External RC Circuit | | High | High | High |
| SYS_RESET# | Suspend | External Circuit | | Driven | Driven | Driven |
| THRM# | Core | Thermal Sensor | | Driven | Off | Off |
| THRMTRIP# | CPU | Thermal Sensor | | Driven | Off | Off |
| VRMPWRGD | Suspend | Processor Voltage Regulator | | High | Low | Low |
| WAKE# | Suspend | External Pull-up | | Driven | Driven | Driven |
| Processor Interface | | | | | | |
| A20GATE | Core | External Microcontroller | | Static | Off | Off |
| FERR# | Core | Processor | | Static | Off | Off |
| RCIN# | Core | External Microcontroller | | High | Off | Off |



Table 3-3. Power Plane for Input Signals for Configurations (Sheet 3 of 3)

| Signal Name | Power Well | Driver During Reset | C3/C4 | S1 | S3 | S4/S5 |
|------------------------------------------------------------|-----------------|-----------------------------------------------------------------------------------------------|-------|---------|--------|--------|
| SMBus Interface | | | | | | |
| SMBALERT# / GPIO11 / JTAGTDO ¹ (Corporate Only) | Suspend | External Pull-up | | Driven | Driven | Driven |
| System Management Interface | | | | | | |
| INTRUDER# | RTC | External Switch | | Driven | High | High |
| Miscellaneous Signals | | | | | | |
| INTVRMEN | RTC | External Pull-up | | High | High | High |
| LAN100_SLP | RTC | External Pull-up | | High | High | High |
| RTCST# | RTC | External RC Circuit | | High | High | High |
| SRTCST# | RTC | External RC Circuit | | High | High | High |
| CL_VREF0 | Controller Link | Consumer Only: External Circuit ² Corporate Only: Internal Circuit ³ | | Driven | Driven | Driven |
| TPO / GPIO72 (Corporate Only) | Suspend | External Pull-up | | High | High | High |
| Intel® High Definition Audio Interface | | | | | | |
| HDA_SDIN[3:0] | Suspend | Intel High Definition Audio Codec | | Low | Low | Low |
| SPI Interface | | | | | | |
| SPI_MISO | Controller Link | Internal Pull-up | | Driven | Driven | Driven |
| Intel® Quiet System Technology | | | | | | |
| TACH[3:0]/ GPIO[7,6,1,17] ¹ | Core | External Pull-up | | Driven | Off | Off |
| Clocks | | | | | | |
| CLK14 | Core | Clock Generator | | Running | Off | Off |
| CLK48 | Core | Clock Generator | | Running | Off | Off |

NOTES:

1. These signals can be configured as outputs in GPIO mode. The state of the DPRSLPVR and DPRSTP# signals in C4 are high if Deeper Sleep is enabled or low if it is disabled.
2. Consumer Only: CL_VREF0 is driven by an external circuit except on platforms where the MCH does not support Controller Link. In these platforms, the signal is not driven.
3. Corporate Only: CL_VREF0 may optionally be driven by an external circuit, as configured by CLINKVREFSEL (ICHSTRP0:bit 5).

§ §



4 Intel® ICH10 and System Clock Domains

Table 4-1 shows the system clock domains. Figure 4-1 shows the assumed connection of the various system components, including the clock generator. For complete details of the system clocking solution, refer to the system's clock generator component specification.

Table 4-1. Intel® ICH10 and System Clock Domains

| Clock Domain | Frequency | Source | Usage |
|----------------------------|-------------------------|-----------------------|-----------------------------------------------------------------------------------------------------------------------------------------|
| ICH10 SATA_CLKP, SATA_CLKN | 100 MHz | Main Clock Generator | Differential clock pair used for SATA. |
| ICH10 DMI_CLKP, DMI_CLKN | 100 MHz | Main Clock Generator | Differential clock pair used for DMI. |
| ICH10 PCICLK | 33 MHz | Main Clock Generator | Free-running PCI Clock to Intel ICH10. This clock remains on during S0 and S1 state, and is expected to be shut off during S3 or below. |
| System PCI | 33 MHz | Main Clock Generator | PCI Bus, LPC I/F. These only go to external PCI and LPC devices. |
| ICH10 CLK48 | 48.000 MHz | Main Clock Generator | Super I/O, USB controllers. Expected to be shut off during S3. |
| ICH10 CLK14 | 14.31818 MHz | Main Clock Generator | Used for ACPI timer and HPET timers. Expected to be shut off during S3. |
| GLAN_CLK | 5 to 62.5 MHz | LAN Connect Component | Generated by the LAN Connect component. Expected to be shut off during S3. |
| SPI_CLK | 17.86 MHz/ 31.25 MHz | ICH | Generated by the ICH. Expected to be shut off during S3. |



Figure 4-1. ICH10 Conceptual System Clock Diagram

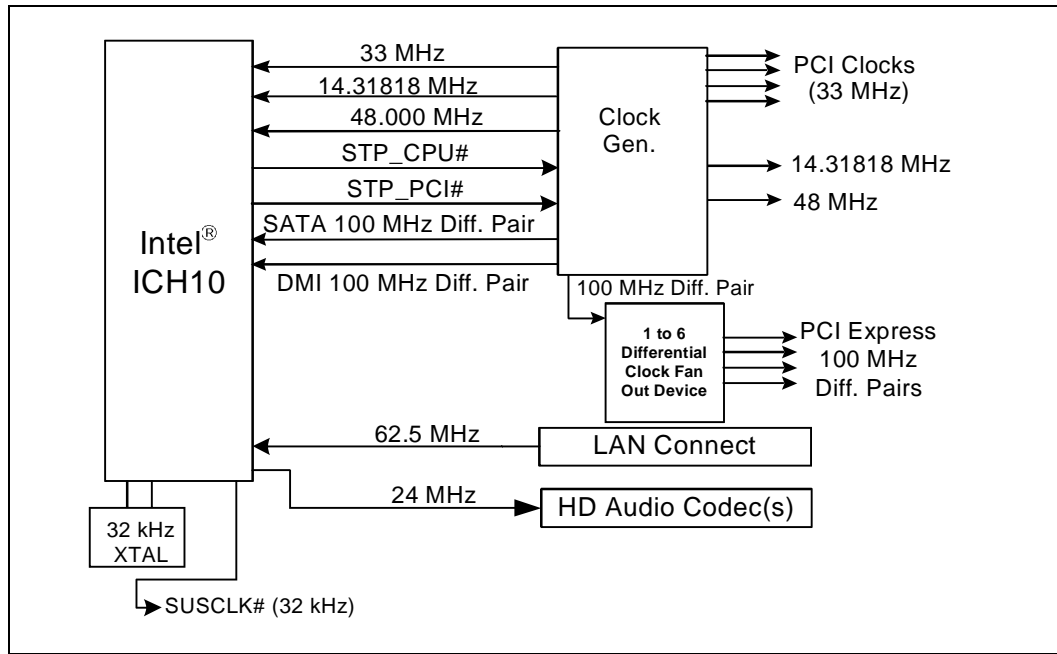

55

§ §

§



5 Functional Description

This chapter describes the functions and interfaces of the Intel ICH10 family.

5.1 DMI-to-PCI Bridge (D30:F0)

The DMI-to-PCI bridge resides in PCI Device 30, Function 0 on bus #0. This portion of the ICH10 implements the buffering and control logic between PCI and Direct Media Interface (DMI). The arbitration for the PCI bus is handled by this PCI device. The PCI decoder in this device must decode the ranges for the DMI. All register contents are lost when core well power is removed.

Direct Media Interface (DMI) is the chip-to-chip connection between the Memory Controller Hub / Graphics and Memory Controller Hub ((G)MCH) and I/O Controller Hub 10 (ICH10). This high-speed interface integrates advanced priority-based servicing allowing for concurrent traffic and true isochronous transfer capabilities. Base functionality is completely software transparent permitting current and legacy software to operate normally.

To provide for true isochronous transfers and configurable Quality of Service (QoS) transactions, the ICH10 supports two virtual channels on DMI: VC0 and VC1. These two channels provide a fixed arbitration scheme where VC1 is always the highest priority. VC0 is the default conduit of traffic for DMI and is always enabled. VC1 must be specifically enabled and configured at both ends of the DMI link (i.e., the ICH10 and (G)MCH).

Configuration registers for DMI, virtual channel support, and DMI active state power management (ASPM) are in the RCRB space in the Chipset Config Registers ([Chapter 10](#)).

DMI is also capable of operating in an Enterprise Southbridge Interface (ESI) compatible mode. ESI is a chip-to-chip connection for server chipsets. In this ESI-compatible mode, the DMI signals require AC coupling. A hardware strap is used to configure DMI in ESI-compatible mode see [Section 2.25](#) for details.

5.1.1 PCI Bus Interface

The ICH10 PCI interface supports *PCI Local Bus Specification*, Revision 2.3, at 33 MHz. The ICH10 integrates a PCI arbiter that supports up to four external PCI bus masters in addition to the internal ICH10 requests.

5.1.2 PCI Bridge As an Initiator

The bridge initiates cycles on the PCI bus when granted by the PCI arbiter. The bridge generates the cycle types listed in [Table 5-1](#).

Table 5-1. PCI Bridge Initiator Cycle Types

| Command | C/BE# | Notes |
|--------------------------|-------|-------------------|
| I/O Read/Write | 2h/3h | Non-posted |
| Memory Read/Write | 6h/7h | Writes are posted |
| Configuration Read/Write | Ah/Bh | Non-posted |
| Special Cycles | 1h | Posted |

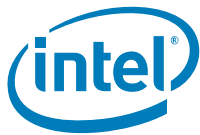

5.1.2.1 Memory Reads and Writes

The bridge bursts memory writes on PCI that are received as a single packet from DMI.

5.1.2.2 I/O Reads and Writes

The bridge generates single DW I/O read and write cycles. When the cycle completes on the PCI bus, the bridge generates a corresponding completion on DMI. If the cycle is retried, the cycle is kept in the down bound queue and may be passed by a postable cycle.

5.1.2.3 Configuration Reads and Writes

The bridge generates single DW configuration read and write cycles. When the cycle completes on the PCI bus, the bridge generates a corresponding completion. If the cycle is retried, the cycle is kept in the down bound queue and may be passed by a postable cycle.

5.1.2.4 Locked Cycles

The bridge propagates locks from DMI per the *PCI Local Bus Specification*. The PCI bridge implements bus lock, which means the arbiter will not grant to any agent except DMI while locked.

If a locked read results in a target or master abort, the lock is not established (as per the *PCI Local Bus Specification*). Agents north of the ICH10 must not forward a subsequent locked read to the bridge if they see the first one finish with a failed completion.

5.1.2.5 Target / Master Aborts

When a cycle initiated by the bridge is master/target aborted, the bridge will not re-attempt the same cycle. For multiple DW cycles, the bridge increments the address and attempts the next DW of the transaction. For all non-postable cycles, a target abort response packet is returned for each DW that was master or target aborted on PCI. The bridge drops posted writes that abort.

5.1.2.6 Secondary Master Latency Timer

The bridge implements a Master Latency Timer via the SMLT register which, upon expiration, causes the de-assertion of FRAME# at the next legal clock edge when there is another active request to use the PCI bus.

5.1.2.7 Dual Address Cycle (DAC)

The bridge will issue full 64-bit dual address cycles for device memory-mapped registers above 4 GB.



5.1.2.8 Memory and I/O Decode to PCI

The PCI bridge in the ICH10 is a **subtractive decode agent**, which follows the following rules when forwarding a cycle from DMI to the PCI interface:

- The PCI bridge will **positively** decode any memory/IO address within its window registers, assuming PCICMD.MSE (D30:F0:Offset 04h:bit 1) is set for memory windows and PCICMD.IOSE (D30:F0:Offset 04h:bit 0) is set for IO windows.
- The PCI bridge will **subtractively** decode any 64-bit memory address not claimed by another agent, assuming PCICMD.MSE (D30:F0:Offset 04h:bit 1) is set.
- The PCI bridge will **subtractively** decode any 16-bit I/O address not claimed by another agent assuming PCICMD.IOSE (D30:F0:Offset 04h:bit 0) is set.
- If BCTRL.IE (D30:F0:Offset 3Eh:bit 2) is set, the PCI bridge will **not positively** forward from primary to secondary called out ranges in the IO window per *PCI Local Bus Specification* (I/O transactions addressing the last 768 bytes in each, 1 KB block: offsets 100h to 3FFh). The PCI bridge will still take them subtractively assuming the above rules.
- If BCTRL.VGAE (D30:F0:Offset 3Eh:bit 3) is set, the PCI bridge will **positively** forward from primary to secondary I/O and memory ranges as called out in the *PCI Bridge Specification*, assuming the above rules are met.

5.1.3 Parity Error Detection and Generation

PCI parity errors can be detected and reported. The following behavioral rules apply:

- When a parity error is detected on PCI, the bridge sets the SECSTS.DPE (D30:F0:Offset 1Eh:bit 15).
- If the bridge is a master and BCTRL.PERE (D30:F0:Offset 3Eh:bit 0) is set and one of the parity errors defined below is detected on PCI, then the bridge will set SECSTS.DPD (D30:F0:Offset 1Eh:bit 8) and will also generate an internal SERR#.
 - During a write cycle, the PERR# signal is active, or
 - A data parity error is detected while performing a read cycle
- If an address or command parity error is detected on PCI and PCICMD.SEE (D30:F0:Offset 04h:bit 8), BCTRL.PERE, and BCTRL.SEE (D30:F0:Offset 3Eh:bit 1) are all set, the bridge will set PSTS.SSE (D30:F0:Offset 06h:bit 14) and generate an internal SERR#.
- If the PSTS.SSE is set because of an address parity error and the PCICMD.SEE is set, the bridge will generate an internal SERR#
- When bad parity is detected from DMI, bad parity will be driven on all data from the bridge.
- When an address parity error is detected on PCI, the PCI bridge will never claim the cycle. This is a slight deviation from the PCI bridge specification, which says that a cycle should be claimed if BCTRL.PERE is not set. However, DMI does not have a concept of address parity error, so claiming the cycle could result in the rest of the system seeing a bad transaction as a good transaction.

5.1.4 PCIRST#

The PCIRST# pin is generated under two conditions:

- PLTRST# active
- BCTRL.SBR (D30:F0:Offset 3Eh:bit 6) set to 1

The PCIRST# pin is in the suspend well. PCIRST# should be tied to PCI bus agents, but not other agents in the system.

5.1.5 Peer Cycles

The PCI bridge may be the initiator of peer cycles. Peer cycles include memory, IO, and configuration cycle types. Peer cycles are only allowed through VC0, and are enabled with the following bits:

- BPC.PDE (D30:F0:Offset 4Ch:bit 2) – Memory and I/O cycles
- BPC.CDE (D30:F0:Offset 4Ch:bit 1) – Configuration cycles

When enabled for peer for one of the above cycle types, the PCI bridge will perform a peer decode to see if a peer agent can receive the cycle. When not enabled, memory cycles (posted and/or non-posted) are sent to DMI, and I/O and/or configuration cycles are not claimed.

Configuration cycles have special considerations. Under the *PCI Local Bus Specification*, these cycles are not allowed to be forwarded upstream through a bridge. However, to enable things such as manageability, BPC.CDE can be set. When set, type 1 cycles are allowed into the part. The address format of the type 1 cycle is slightly different from a standard PCI configuration cycle to allow addressing of extended PCI space. The format is shown in [Table 5-2](#).

Table 5-2. Type 1 Address Format

| Bits | Definition |
|-------|---------------------------------------------------------------------------------------------------------------------------------|
| 31:27 | Reserved (same as the <i>PCI Local Bus Specification</i>) |
| 26:24 | Extended Configuration Address – allows addressing of up to 4K. These bits are combined with bits 7:2 to get the full register. |
| 23:16 | Bus Number (same as the <i>PCI Local Bus Specification</i>) |
| 15:11 | Device Number (same as the <i>PCI Local Bus Specification</i>) |
| 10:8 | Function Number (same as the <i>PCI Local Bus Specification</i>) |
| 7:2 | Register (same as the <i>PCI Local Bus Specification</i>) |
| 1 | 0 |
| 0 | Must be 1 to indicate a type 1 cycle. Type 0 cycles are not decoded. |

Note: The ICH10's USB controllers cannot perform peer-to-peer traffic.

5.1.6 PCI-to-PCI Bridge Model

From a software perspective, the ICH10 contains a PCI-to-PCI bridge. This bridge connects DMI to the PCI bus. By using the PCI-to-PCI bridge software model, the ICH10 can have its decode ranges programmed by existing plug-and-play software such that PCI ranges do not conflict with graphics aperture ranges in the Host controller.



5.1.7 IDSEL to Device Number Mapping

When addressing devices on the external PCI bus (with the PCI slots), the ICH10 asserts one address signal as an IDSEL. When accessing device 0, the ICH10 asserts AD16. When accessing Device 1, the ICH10 asserts AD17. This mapping continues all the way up to device 15 where the ICH10 asserts AD31. Note that the ICH10's internal functions (Intel High Definition Audio, USB, SATA and PCI Bridge) are enumerated like they are off of a separate PCI bus (DMI) from the external PCI bus.

5.1.8 Standard PCI Bus Configuration Mechanism

The PCI Bus defines a slot based "configuration space" that allows each device to contain up to eight functions with each function containing up to 256, 8-bit configuration registers. The *PCI Local Bus Specification*, Revision 2.3 defines two bus cycles to access the PCI configuration space: Configuration Read and Configuration Write. Memory and I/O spaces are supported directly by the processor. Configuration space is supported by a mapping mechanism implemented within the ICH10. The *PCI Local Bus Specification*, Revision 2.3 defines two mechanisms to access configuration space, Mechanism 1 and Mechanism 2. The ICH10 only supports Mechanism 1.

Warning: Configuration writes to internal devices, when the devices are disabled, are invalid and may cause undefined results.

5.2 PCI Express* Root Ports (D28:F0,F1,F2,F3,F4,F5)

There are six root ports available in ICH10. These all reside in device 28, and take function 0 – 5. Port 1 is function 0, port 2 is function 1, port 3 is function 2, port 4 is function 3, port 5 is function 4, and port 6 is function 5.

PCI Express Root Ports 1-4 can be statically configured as four x1 Ports or ganged together to form one x4 port. Ports 5 and 6 can only be used as two x1 ports. The port configuration is set by RCBA 224h [Bits 1:0] see [Section 10.1.38](#) for more details.

5.2.1 Interrupt Generation

The root port generates interrupts on behalf of Hot-Plug and power management events, when enabled. These interrupts can either be pin based, or can be MSIs, when enabled.

When an interrupt is generated via the legacy pin, the pin is internally routed to the ICH10 interrupt controllers. The pin that is driven is based upon the setting of the chipset configuration registers. Specifically, the chipset configuration registers used are the D28IP (Base address + 310Ch) and D28IR (Base address + 3146h) registers.



Table 5-3 summarizes interrupt behavior for MSI and wire-modes. In the table “bits” refers to the Hot-Plug and PME interrupt bits.

Table 5-3. MSI versus PCI IRQ Actions

| Interrupt Register | Wire-Mode Action | MSI Action |
|----------------------------------------------------------------------------------|------------------|--------------|
| All bits 0 | Wire inactive | No action |
| One or more bits set to 1 | Wire active | Send message |
| One or more bits set to 1, new bit gets set to 1 | Wire active | Send message |
| One or more bits set to 1, software clears some (but not all) bits | Wire active | Send message |
| One or more bits set to 1, software clears all bits | Wire inactive | No action |
| Software clears one or more bits, and one or more bits are set on the same clock | Wire active | Send message |

5.2.2 Power Management

5.2.2.1 S3/S4/S5 Support

Software initiates the transition to S3/S4/S5 by performing an IO write to the Power Management Control register in the ICH10. After the IO write completion has been returned to the processor, each root port will send a PME_Turn_Off TLP (Transaction Layer Packet) message on its downstream link. The device attached to the link will eventually respond with a PME_TO_Ack TLP message followed by sending a PM_Enter_L23 DLLP (Data Link Layer Packet) request to enter the L2/L3 Ready state. When all of the ICH10 root ports links are in the L2/L3 Ready state, the ICH10 power management control logic will proceed with the entry into S3/S4/S5.

Prior to entering S3, software is required to put each device into D3_{HOT}. When a device is put into D3_{HOT} it will initiate entry into a L1 link state by sending a PM_Enter_L1 DLLP. Thus under normal operating conditions when the root ports sends the PME_Turn_Off message the link will be in state L1. However, when the root port is instructed to send the PME_Turn_Off message, it will send it whether or not the link was in L1. Endpoints attached to ICH can make no assumptions about the state of the link prior to receiving a PME_Turn_Off message.

5.2.2.2 Resuming from Suspended State

The root port contains enough circuitry in the suspend well to detect a wake event through the WAKE# signal and to wake the system. When WAKE# is detected asserted, an internal signal is sent to the power management controller of the ICH10 to cause the system to wake up. This internal message is not logged in any register, nor is an interrupt/GPE generated due to it.

5.2.2.3 Device Initiated PM_PME Message

When the system has returned to a working state from a previous low power state, a device requesting service will send a PM_PME message continuously, until acknowledge by the root port. The root port will take different actions depending upon whether this is the first PM_PME has been received, or whether a previous message has been received but not yet serviced by the operating system.



If this is the first message received (RSTS.PS - D28:F0/F1/F2/F3/F4/F5: Offset 60h: bit 16 is cleared), the root port will set RSTS.PS, and log the PME Requester ID into RSTS.RID (D28:F0/F1/F2/F3/F4/F5: Offset 60h: bits 15:0). If an interrupt is enabled via RCTL.PIE (D28:F0/F1/F2/F3/F4/F5: Offset 5Ch: bit 3), an interrupt will be generated. This interrupt can be either a pin or an MSI if MSI is enabled via MC.MSIE (D28:F0/F1/F2/F3/F4/F5: Offset 82h: bit 0). See [Section 5.2.2.4](#) for SMI/SCI generation.

If this is a subsequent message received (RSTS.PS is already set), the root port will set RSTS.PP (D28:F0/F1/F2/F3/F4/F5: Offset 60h: bit 17) and log the PME Requester ID from the message in a hidden register. No other action will be taken.

When the first PME event is cleared by software clearing RSTS.PS, the root port will set RSTS.PS, clear RSTS.PP, and move the requester ID from the hidden register into RSTS.RID.

If RCTL.PIE is set, an interrupt will be generated. If RCTL.PIE is not set, a message will be sent to the power management controller so that a GPE can be set. If messages have been logged (RSTS.PS is set), and RCTL.PIE is later written from a 0 to a 1, an interrupt will be generated. This last condition handles the case where the message was received prior to the operating system re-enabling interrupts after resuming from a low power state.

5.2.2.4 SMI/SCI Generation

Interrupts for power management events are not supported on legacy operating systems. To support power management on non-PCI Express aware operating systems, PM events can be routed to generate SCI. To generate SCI, MPC.PMCE must be set. When set, a power management event will cause SMSCS.PMCS (D28:F0/F1/F2/F3/F4/F5: Offset DCh: bit 31) to be set.

Additionally, BIOS workarounds for power management can be supported by setting MPC.PMME (D28:F0/F1/F2/F3/F4/F5: Offset D8h: bit 0). When this bit is set, power management events will set SMSCS.PMMS (D28:F0/F1/F2/F3/F4/F5: Offset DCh: bit 0), and SMI # will be generated. This bit will be set regardless of whether interrupts or SCI is enabled. The SMI# may occur concurrently with an interrupt or SCI.

5.2.3 SERR# Generation

SERR# may be generated via two paths – through PCI mechanisms involving bits in the PCI header, or through PCI Express mechanisms involving bits in the PCI Express capability structure.

Figure 5-1. Generation of SERR# to Platform

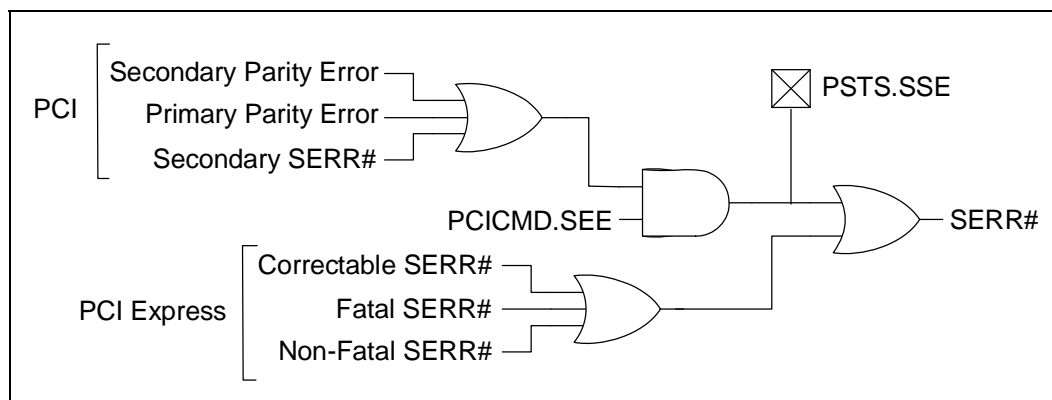

5.2.4 Hot-Plug

Each root port implements a Hot-Plug controller which performs the following:

- Messages to turn on / off / blink LEDs
- Presence and attention button detection
- Interrupt generation

The root port only allows Hot-Plug with modules (e.g., ExpressCard*). Edge-connector based Hot-Plug is not supported.

5.2.4.1 Presence Detection

When a module is plugged in and power is supplied, the physical layer will detect the presence of the device, and the root port sets SLSTS.PDS (D28:F0/F1/F2/F3/F4/F5:Offset 5Ah:bit 6) and SLSTS.PDC (D28:F0/F1/F2/F3:Offset 6h:bit 3). If SLCTL.PDE (D28:F0/F1/F2/F3F4/F5:Offset 58h:bit 3) and SLCTL.HPE (D28:F0/F1/F2/F3F4/F5:Offset 58h:bit 5) are both set, the root port will also generate an interrupt.

When a module is removed (via the physical layer detection), the root port clears SLSTS.PDS and sets SLSTS.PDC. If SLCTL.PDE and SLCTL.HPE are both set, the root port will also generate an interrupt.

5.2.4.2 Message Generation

When system software writes to SLCTL.AIC (D28:F0/F1/F2/F3F4/F5:Offset 58h:bits 7:6) or SLCTL.PIC (D28:F0/F1/F2/F3F4/F5:Offset 58h:bits 9:8), the root port will send a message down the link to change the state of LEDs on the module.

Writes to these fields are non-postable cycles, and the resulting message is a postable cycle. When receiving one of these writes, the root port performs the following:

- Changes the state in the register.
- Generates a completion into the upstream queue
- Formulates a message for the downstream port if the field is written to regardless of if the field changed.
- Generates the message on the downstream port
- When the last message of a command is transmitted, sets SLSTS.CCE (D28:F0/F1/F2/F3F4/F5:Offset 58h:bit 4) to indicate the command has completed. If SLCTL.CCE and SLCTL.HPE (D28:F0/F1/F2/F3F4/F5:Offset 58h:bit 5) are set, the root port generates an interrupt.

The command completed register (SLSTS.CC) applies only to commands issued by software to control the Attention Indicator (SLCTL.AIC), Power Indicator (SLCTL.PIC), or Power Controller (SLCTL.PCC). However, writes to other parts of the Slot Control Register would invariably end up writing to the indicators, power controller fields; Hence, any write to the Slot Control Register is considered a command and if enabled, will result in a command complete interrupt. The only exception to this rule is a write to disable the command complete interrupt which will not result in a command complete interrupt.

A single write to the Slot Control register is considered to be a single command, and hence receives a single command complete, even if the write affects more than one field in the Slot Control Register.



5.2.4.3 Attention Button Detection

When an attached device is ejected, an attention button could be pressed by the user. This attention button press will result in a the PCI Express message "Attention_Button_Pressed" from the device. Upon receiving this message, the root port will set SLSTS.ABP (D28:F0/F1/F2/F3F4/F5: Offset 5Ah: bit 0).

If SLCTL.ABE (D28:F0/F1/F2/F3F4/F5: Offset 58h: bit 0) and SLCTL.HPE (D28:F0/F1/F2/F3F4/F5: Offset 58h: bit 5) are set, the Hot-Plug controller will also generate an interrupt. The interrupt is generated on an edge-event. For example, if SLSTS.ABP is already set, a new interrupt will not be generated.

5.2.4.4 SMI /SCI Generation

Interrupts for Hot-Plug events are not supported on legacy operating systems. To support Hot-Plug on non-PCI Express aware operating systems, Hot-Plug events can be routed to generate SCI. To generate SCI, MPC.HPCE (D28:F0/F1/F2/F3F4/F5: Offset D8h: bit 30) must be set. When set, enabled Hot-Plug events will cause SMSCS.HPCS (D28:F0/F1/F2/F3F4/F5: Offset DCh: bit 30) to be set.

Additionally, BIOS workarounds for Hot-Plug can be supported by setting MPC.HPME (D28:F0/F1/F2/F3F4/F5: Offset D8h: bit 1). When this bit is set, Hot-Plug events can cause SMI status bits in SMSCS to be set. Supported Hot-Plug events and their corresponding SMSCS bit are:

- Command Completed - SCSCS.HPCCM (D28:F0/F1/F2/F3/F4/F5: Offset DCh: bit 3)
- Presence Detect Changed - SMSCS.HPPDM (D28:F0/F1/F2/F3/F4/F5: Offset DCh: bit 1)
- Attention Button Pressed - SMSCS.HPABM (D28:F0/F1/F2/F3/F4/F5: Offset DCh: bit 2)
- Link Active State Changed - SMSCS.HPLAS (D28:F0/F1/F2/F3/F4/F5: Offset DCh: bit 4)

When any of these bits are set, SMI # will be generated. These bits are set regardless of whether interrupts or SCI is enabled for Hot-Plug events. The SMI# may occur concurrently with an interrupt or SCI.

5.3 Gigabit Ethernet Controller (B0:D25:F0)

The ICH10 integrates a Gigabit Ethernet Controller. The integrated Gigabit Ethernet controller is compatible with Gigabit Ethernet PHY (Intel® 82567 Gigabit Platform LAN Connect device). The integrated Gigabit Ethernet controller provides two interfaces: LAN Connect Interface (LCI) for 10/100 operation and Gigabit LAN Connect Interface (GLCI) for Gigabit Ethernet operation. The GLCI is shared with the ICH10's PCI Express port 6 and can be enabled via a soft strap that is stored in system SPI flash, see [Section](#) for details.

The ICH10 integrated Gigabit Ethernet controller supports multi speed operation, 10/100/1000 MB/s. The integrated Gigabit Ethernet can operate in full-duplex at all supported speeds or half-duplex at 10/100 MB/s, and adheres with the *IEEE 802.3x Flow Control Specification*.

Note: Gigabit Ethernet (1000Mb/s) is only supported in S0.

The controller provides a system interface via a PCI function. A full memory-mapped or IO-mapped interface is provided to the software, along with DMA mechanisms for high performance data transfer.

The following summarizes the ICH10 integrated Gigabit Ethernet controller features:

- Configurable LED operation for customization of LED display.
- IPv4 and IPv6 Checksum Offload support (receive, transmit, and large send).
- 64-bit address master support for system using more than 4 GB of physical memory.
- Configurable receive and transmit data FIFO, programmable in 1 KB increments.
- Intelligent interrupt generation to enhance driver performance.
- Compliance with Advanced Configuration and Power Interface and PCI Power Management standards.
- ACPI register set and power down functionality supporting D0 and D3 states.
- Full wake-up support (APM and ACPI).
- Magic Packet wake-up enable with unique MAC address.
- Fragmented UDP checksum off load for package reassembly.
- Jumbo frames supported.
- LinkSec support (802.3ae compliant)
- TimeSync support (802.1as compliant)

5.3.1 Gigabit Ethernet PCI Bus Interface

The Gigabit Ethernet controller has a PCI interface to the host processor and host memory. The following sections detail the transaction on the bus.

5.3.1.1 Transaction Layer

The upper layer of the host architecture is the transaction layer. The transaction layer connects to the device core using an implementation specific protocol. Through this core-to-transaction-layer protocol, the application-specific parts of the device interact with the subsystem and transmit and receive requests to or from the remote agent, respectively.

5.3.1.2 Data Alignment

5.3.1.2.1 4 K Boundary

PCI requests must never specify an Address/Length combination that causes a Memory Space access to cross a 4 K boundary. It is the HW responsibility to break requests into 4 K-aligned requests (if needed). This does not pose any requirement on SW. However, if SW allocates a buffer across a 4 K boundary, HW will issue multiple requests for the buffer. SW should consider aligning buffers to 4 KB boundary in cases where it improves performance.

The alignment to the 4 K boundaries is done in the core. The Transaction layer will not do any alignment according to these boundaries.

5.3.1.2.2 64 Bytes

PCI requests are multiples of 64 bytes and aligned to make better use of memory controller resources. Writes, however, can be on any boundary and can cross a 64 byte alignment boundary

5.3.1.3 Configuration Request Retry Status

The LAN Controller might have a delay in initialization due to NVM read. If the NVM configuration read operation is not completed and the device receives a Configuration Request, the device will respond with a Configuration Request Retry Completion Status to terminate the Request, and thus effectively stall the Configuration Request until such time that the subsystem has completed local initialization and is ready to communicate with the host.



5.3.2 Error Events and Error Reporting

5.3.2.1 Data Parity Error

The PCI Host bus does not provide parity protection, but it does forward parity errors from bridges. The LAN Controller recognizes parity errors through the internal bus interface and will set the Parity Error bit in PCI Configuration space. If parity errors are enabled in configuration space, a system error will be indicated on the PCI Host bus to the chipset. The offending cycle with a parity error will be dropped and not processed by the LAN Controller.

5.3.2.2 Completion with Unsuccessful Completion Status

A completion with unsuccessful completion status (any status other than "000") will be dropped and not processed by the LAN Controller. Furthermore, the request that corresponds to the unsuccessful completion will not be retried. When this unsuccessful completion status is received, the System Error bit in the PCI Configuration space will be set. If the system errors are enabled in configuration space, a system error will be indicated on the PCI Host bus to the chipset.

5.3.3 Ethernet Interface

The integrated LAN controller provides a complete CSMA/CD function supporting IEEE 802.3 (10Mb/s), 802.3u (100Mb/s) implementations. It also supports the IEEE 802.3z and 802.3ab (1000Mb/s) implementations. The device performs all of the functions required for transmission, reception and collision handling called out in the standards.

The mode used to communicate between the LAN controller and the LAN connect device supports 10/100/1000 Mbps operation, with both half- and full-duplex operation at 10/100 Mbps, and full-duplex operation at 1000 Mbps.

5.3.3.1 MAC/LAN Connect Interface

The integrated LAN controller and LAN Connect Device communicate through either the platform LAN connect interface (LCI) or Gigabit LAN connect interface (GLCI). All controller configuration is performed using device control registers mapped into system memory or I/O space. The LAN Connect Device is configured via the LCI or Gigabit Ethernet Lan connect interface.

The integrated MAC supports various modes as summarized in the following table

Table 5-4. LAN Mode Support

| Mode | Interface Active | Connections |
|--------------------|------------------|--------------------------------------------------|
| Normal 10/100/1000 | LCI, GLCI | Intel® 82567 Gigabit Platform LAN Connect Device |



5.3.4 PCI Power Management

The LAN Controller supports the Advanced Configuration and Power Interface (ACPI) specification as well as Advanced Power Management (APM). This allows the host to be awoken (i.e., from Sx (S3-S5) to S0) by network-related activity via an internal host wake signal.

The LAN controller contains power management registers for PCI, and supports D0 and D3 states. PCI transactions are only allowed in the D0 state, except for host accesses to the LAN controller's PCI configuration registers.

5.3.4.1 Wake-Up

The LAN Controller supports two types of wakeup mechanisms:

1. Advanced Power Management (APM) Wakeup
2. ACPI Power Management Wakeup

Both mechanisms use an internal WAKE# signal to wake the system up. This signal is connected to the suspend wake logic in the ICH10. The wake-up steps are as follows:

1. Host Wake Event occurs (note that packet is not delivered to host)
2. PME_STATUS bit is set
3. Internal WAKE# signal asserted by Host LAN function
4. System wakes from Sx state to S0 state
5. The Host LAN function is transitioned to D0
6. The Host clears the PME_STATUS bit
7. Internal WAKE# signal is deasserted by Host LAN function

5.3.4.1.1 Advanced Power Management Wakeup

Advanced Power Management Wakeup, or APM Wakeup, was previously known as Wake on LAN. It is a feature that has existed in the 10/100 Mbps NICs for several generations. The basic premise is to receive a broadcast or unicast packet with an explicit data pattern, and then to assert a signal to wake-up the system. In the earlier generations, this was accomplished by using a special signal that ran across a cable to a defined connector on the motherboard. The NIC would assert the signal for approximately 50ms to signal a wakeup. The LAN Controller uses (if configured to) an in-band PM_PME message for this.

On power-up, the LAN Controller will read the APM Enable bits from the NVM PCI Init Control Word into the APM Enable (APME) bits of the Wakeup Control Register (WUC). These bits control enabling of APM Wakeup.

When APM Wakeup is enabled, the LAN Controller checks all incoming packets for Magic Packets.

Once the LAN Controller receives a matching magic packet, it will:

- Set the Magic Packet Received bit in the Wake Up Status Register (WUS).
- Set the PME_Status bit in the Power Management Control / Status Register (PMCSR) and assert the internal WAKE# signal.

APM Wakeup is supported in all power states and only disabled if a subsequent NVM read results in the APM Wake Up bit being cleared or the software explicitly writes a 0 to the APM Wake Up (APM) bit of the WUC register.



5.3.4.1.2 ACPI Power Management Wakeup

The LAN Controller supports ACPI Power Management based Wakeups. It can generate system wake-up events from three sources:

- Reception of a Magic Packet.
- Reception of a Network Wakeup Packet.
- Detection of a link change of state.

Activating ACPI Power Management Wakeup requires the following steps:

- The driver programs the Wake Up Filter Control Register (WUFC) to indicate the packets it wishes to wake up from and supplies the necessary data to the Ipv4 Address Table (IP4AT) and the Flexible Filter Mask Table (FFMT), Flexible Filter Length Table (FFLT), and the Flexible Filter Value Table (FFVT). It can also set the Link Status Change Wake Up Enable (LNKC) bit in the Wake Up Filter Control Register (WUFC) to cause wakeup when the link changes state.
- The OS (at configuration time) writes a 1 to the PME_EN bit of the Power Management Control / Status Register (PMCSR.8).

Normally, after enabling wakeup, the OS will write 11b to the lower two bits of the PMCSR to put the LAN Controller into low-power mode.

Once Wakeup is enabled, the LAN Controller monitors incoming packets, first filtering them according to its standard address filtering method, then filtering them with all of the enabled wakeup filters. If a packet passes both the standard address filtering and at least one of the enabled wakeup filters, the LAN Controller will:

- Set the PME_Status bit in the Power Management Control / Status Register (PMCSR)
- If the PME_EN bit in the Power Management Control / Status Register (PMCSR) is set, assert the internal WAKE# signal.
- Set one or more of the Received bits in the Wake Up Status Register (WUS). (More than one bit will be set if a packet matches more than one filter.)

If enabled, a link state change wakeup will cause similar results, setting PME_Status, asserting the internal WAKE# signal and setting the Link Status Changed (LNKC) bit in the Wake Up Status Register (WUS) when the link goes up or down.

The internal WAKE# signal will remain asserted until the OS either writes a 1 to the PME_Status bit of the PMCSR register or writes a 0 to the PME_En bit.

After receiving a wakeup packet, the LAN Controller will ignore any subsequent wakeup packets until the driver clears all of the Received bits in the Wake Up Status Register (WUS). It will also ignore link change events until the driver clears the Link Status Changed (LNKC) bit in the Wake Up Status Register (WUS).

5.3.5 Configurable LEDs

The LAN Controller supports 3 controllable and configurable LEDs that are driven from the LAN Connect Device. Each of the three LED outputs can be individually configured to select the particular event, state, or activity, which will be indicated on that output. In addition, each LED can be individually configured for output polarity as well as for blinking versus non-blinking (steady-state) indication.

The configuration for LED outputs is specified via the LEDCTL register. Furthermore, the hardware-default configuration for all the LED outputs, can be specified via NVM fields, thereby supporting LED displays configurable to a particular OEM preference.



Each of the 3 LED's may be configured to use one of a variety of sources for output indication. The MODE bits control the LED source:

- LINK_100/1000 is asserted when link is established at either 100 or 1000Mbps.
- LINK_10/1000 is asserted when link is established at either 10 or 1000Mbps.
- LINK_UP is asserted when any speed link is established and maintained. ACTIVITY is asserted when link is established and packets are being transmitted or received.
- LINK/ACTIVITY is asserted when link is established AND there is NO transmit or receive activity
- LINK_10 is asserted when a 10Mbps link is established and maintained.
- LINK_100 is asserted when a 100Mbps link is established and maintained.
- LINK_1000 is asserted when a 1000Mbps link is established and maintained.
- FULL_DUPLEX is asserted when the link is configured for full duplex operation.
- COLLISION is asserted when a collision is observed.
- PAUSED is asserted when the device's transmitter is flow controlled.
- LED_ON is always asserted; LED_OFF is always de-asserted.

The IVRT bits allow the LED source to be inverted before being output or observed by the blink-control logic. LED outputs are assumed to normally be connected to the negative side (cathode) of an external LED.

The BLINK bits control whether the LED should be blinked while the LED source is asserted, and the blinking frequency (either 200 ms on and 200 ms off or 83 ms on and 83 ms off). The blink control may be especially useful for ensuring that certain events, such as ACTIVITY indication, cause LED transitions, which are sufficiently visible to a human eye. The same blinking rate is shared by all LEDs.

5.3.6 Function Level Reset Support (FLR)

The Gigabit LAN Controller supports the Function Level Reset (FLR) capability. The FLR capability can be used in conjunction with Intel Virtualization Technology. FLR allows an Operating System in a Virtual Machine to have complete control over a device, including its initialization, without interfering with the rest of the platform. The device provides a software interface that enables the Operating System to reset the whole device as if a PCI reset was asserted.

5.3.6.1 FLR Steps

5.3.6.1.1 FLR Initialization

1. A FLR is initiated by software writing a 1 to the Initiate FLR bit.
2. All subsequent requests targeting the Function will not be claimed and will be Master Abort Immediate on the bus. This includes any configuration, I/O or Memory cycles, however, the Function shall continue to accept completions targeting the Function.

5.3.6.1.2 FLR Operation

Function will Reset all configuration, I/O and memory registers of the Function except those indicated otherwise and reset all internal states of the Function to the default or initial condition.

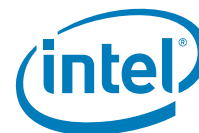

5.3.6.1.3 FLR Completion

The Initiate FLR bit is reset (cleared) when the FLR reset is completed. This bit can be used to indicate to the software that the FLR reset is completed.

Note: From the time Initiate FLR bit is written to 1 software must wait at least 100 ms before accessing the function.

5.4 LPC Bridge (w/ System and Management Functions) (D31:F0)

The LPC bridge function of the ICH10 resides in PCI Device 31:Function 0. In addition to the LPC bridge function, D31:F0 contains other functional units including DMA, Interrupt controllers, Timers, Power Management, System Management, GPIO, and RTC. In this chapter, registers and functions associated with other functional units (power management, GPIO, USB, etc.) are described in their respective sections.

Note: The LPC bridge cannot be configured as a subtractive decode agent.

5.4.1 LPC Interface

The ICH10 implements an LPC interface as described in the *Low Pin Count Interface Specification*, Revision 1.1. The LPC interface to the ICH10 is shown in Figure 5-2. Note that the ICH10 implements all of the signals that are shown as optional, but peripherals are not required to do so.

Figure 5-2. LPC Interface Diagram

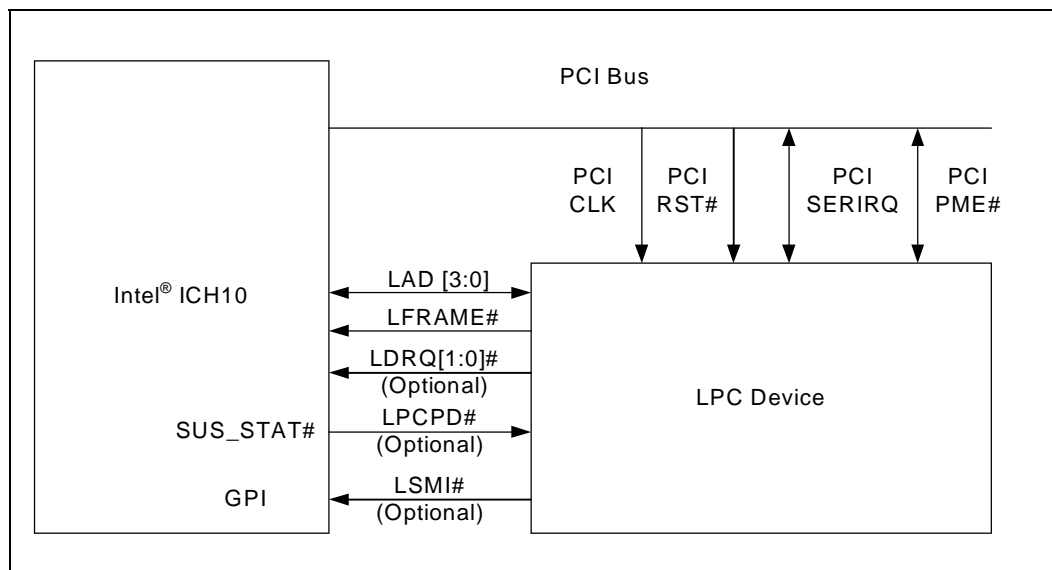



5.4.1.1 LPC Cycle Types

The ICH10 (Corporate only) implements all of the cycle types described in the *Low Pin Count Interface Specification, Revision 1.1*. ICH10 Consumer does not provide a generic mechanism for decoding memory ranges and forwarding them as standard LPC Memory cycles on the LPC bus. Table 5-5 shows the cycle types supported by the ICH10.

Table 5-5. LPC Cycle Types Supported

| Cycle Type | Comment |
|-------------------------------|---------------------------------------------------------------------------------------------------|
| Memory Read (Corporate only) | 1 byte only. (See Note 1 below) |
| Memory Write (Corporate only) | 1 byte only. (See Note 1 below) |
| I/O Read | 1 byte only. Intel ICH10 breaks up 16- and 32-bit processor cycles into multiple 8-bit transfers. |
| I/O Write | 1 byte only. ICH10 breaks up 16- and 32-bit processor cycles into multiple 8-bit transfers. |
| DMA Read | Can be 1, or 2 bytes |
| DMA Write | Can be 1, or 2 bytes |
| Bus Master Read | Can be 1, 2, or 4 bytes. (See Note 2 below) |
| Bus Master Write | Can be 1, 2, or 4 bytes. (See Note 2 below) |

NOTES:

1. ICH10 (Corporate only) provides a single generic memory range (LGMR) for decoding memory cycles and forwarding them as LPC Memory cycles on the LPC bus. The LGMR memory decode range is 64 KB in size and can be defined as being anywhere in the 4 GB memory space. This range needs to be configured by BIOS during POST to provide the necessary memory resources. BIOS should advertise the LPC Generic Memory Range as Reserved to the OS in order to avoid resource conflict. For larger transfers, the ICH10 performs multiple 8-bit transfers. If the cycle is not claimed by any peripheral, it is subsequently aborted, and the ICH10 returns a value of all 1s to the processor. This is done to maintain compatibility with ISA memory cycles where pull-up resistors would keep the bus high if no device responds.
2. Bus Master Read or Write cycles must be naturally aligned. For example, a 1-byte transfer can be to any address. However, the 2-byte transfer must be word-aligned (i.e., with an address where A0=0). A dword transfer must be dword-aligned (i.e., with an address where A1 and A0 are both 0).

5.4.1.2 Start Field Definition

Table 5-6. Start Field Bit Definitions

| Bits[3:0] Encoding | Definition |
|--------------------|------------------------------------------|
| 0000 | Start of cycle for a generic target |
| 0010 | Grant for bus master 0 |
| 0011 | Grant for bus master 1 |
| 1111 | Stop/Abort: End of a cycle for a target. |

NOTE: All other encodings are RESERVED.



5.4.1.3 Cycle Type / Direction (CYCTYPE + DIR)

The ICH10 always drives bit 0 of this field to 0. Peripherals running bus master cycles must also drive bit 0 to 0. [Table 5-7](#) shows the valid bit encodings.

Table 5-7. Cycle Type Bit Definitions

| Bits[3:2] | Bit1 | Definition |
|-----------|------|-----------------------------------------------------------------------------------------------------------------|
| 00 | 0 | I/O Read |
| 00 | 1 | I/O Write |
| 01 | 0 | Memory Read |
| 01 | 1 | Memory Read |
| 10 | 0 | DMA Read |
| 10 | 1 | DMA Write |
| 11 | x | Reserved. If a peripheral performing a bus master cycle generates this value, the Intel ICH10 aborts the cycle. |

5.4.1.4 Size

Bits[3:2] are reserved. The ICH10 always drives them to 00. Peripherals running bus master cycles are also supposed to drive 00 for bits 3:2; however, the ICH10 ignores those bits. Bits[1:0] are encoded as listed in [Table 5-8](#).

Table 5-8. Transfer Size Bit Definition

| Bits[1:0] | Size |
|-----------|----------------------------------------------------------------------------------------------------------------------------------------------------------------|
| 00 | 8-bit transfer (1 byte) |
| 01 | 16-bit transfer (2 bytes) |
| 10 | Reserved. The Intel ICH10 never drives this combination. If a peripheral running a bus master cycle drives this combination, the ICH10 may abort the transfer. |
| 11 | 32-bit transfer (4 bytes) |



5.4.1.5 SYNC

Valid values for the SYNC field are shown in [Table 5-9](#).

Table 5-9. SYNC Bit Definition

| Bits[3:0] | Indication |
|-----------|--------------------------------------------------------------------------------------------------------------------------------------------------------------------------------------------------------------------------------------------------------------------------------------------------------------------------------------------------------------------------|
| 0000 | Ready: SYNC achieved with no error. For DMA transfers, this also indicates DMA request deassertion and no more transfers desired for that channel. |
| 0101 | Short Wait: Part indicating wait-states. For bus master cycles, the Intel® ICH10 does not use this encoding. Instead, the ICH10 uses the Long Wait encoding (see next encoding below). |
| 0110 | Long Wait: Part indicating wait-states, and many wait-states will be added. This encoding driven by the ICH10 for bus master cycles, rather than the Short Wait (0101). |
| 1001 | Ready More (Used only by peripheral for DMA cycle): SYNC achieved with no error and more DMA transfers desired to continue after this transfer. This value is valid only on DMA transfers and is not allowed for any other type of cycle. |
| 1010 | Error: Sync achieved with error. This is generally used to replace the SERR# or IOCHK# signal on the PCI/ISA bus. It indicates that the data is to be transferred, but there is a serious error in this transfer. For DMA transfers, this not only indicates an error, but also indicates DMA request deassertion and no more transfers desired for that channel. |

NOTES:

1. All other combinations are RESERVED.
2. If the LPC controller receives any SYNC returned from the device other than short (0101), long wait (0110), or ready (0000) when running a FWH cycle, indeterminate results may occur. A FWH device is not allowed to assert an Error SYNC.

5.4.1.6 SYNC Time-Out

There are several error cases that can occur on the LPC interface. The ICH10 responds as defined in section 4.2.1.9 of the *Low Pin Count Interface Specification*, Revision 1.1 to the stimuli described therein. There may be other peripheral failure conditions; however, these are not handled by the ICH10.

5.4.1.7 SYNC Error Indication

The ICH10 responds as defined in section 4.2.1.10 of the *Low Pin Count Interface Specification*, Revision 1.1.

Upon recognizing the SYNC field indicating an error, the ICH10 treats this as an SERR by reporting this into the Device 31 Error Reporting Logic.



5.4.1.8 LFRAME# Usage

The ICH10 follows the usage of LFRAME# as defined in the *Low Pin Count Interface Specification*, Revision 1.1.

The ICH10 performs an abort for the following cases (possible failure cases):

- ICH10 starts a Memory, I/O, or DMA cycle, but no device drives a valid SYNC after four consecutive clocks.
- ICH10 starts a Memory, I/O, or DMA cycle, and the peripheral drives an invalid SYNC pattern.
- A peripheral drives an invalid address when performing bus master cycles.
- A peripheral drives an invalid value.

5.4.1.9 I/O Cycles

For I/O cycles targeting registers specified in the ICH10's decode ranges, the ICH10 performs I/O cycles as defined in the *Low Pin Count Interface Specification*, Revision 1.1. These are 8-bit transfers. If the processor attempts a 16-bit or 32-bit transfer, the ICH10 breaks the cycle up into multiple 8-bit transfers to consecutive I/O addresses.

Note: If the cycle is not claimed by any peripheral (and subsequently aborted), the ICH10 returns a value of all 1s (FFh) to the processor. This is to maintain compatibility with ISA I/O cycles where pull-up resistors would keep the bus high if no device responds.

5.4.1.10 Bus Master Cycles

The ICH10 supports Bus Master cycles and requests (using LDRQ#) as defined in the *Low Pin Count Interface Specification*, Revision 1.1. The ICH10 has two LDRQ# inputs, and thus supports two separate bus master devices. It uses the associated START fields for Bus Master 0 (0010b) or Bus Master 1 (0011b).

Note: The ICH10 does not support LPC Bus Masters performing I/O cycles. LPC Bus Masters should only perform memory read or memory write cycles.

5.4.1.11 LPC Power Management

LPCPD# Protocol

Same timings as for SUS_STAT#. Upon driving SUS_STAT# low, LPC peripherals drive LDRQ# low or tri-state it. ICH10 shuts off the LDRQ# input buffers. After driving SUS_STAT# active, the ICH10 drives LFRAME# low, and tri-states (or drive low) LAD[3:0].

Note: The *Low Pin Count Interface Specification*, Revision 1.1 defines the LPCPD# protocol where there is at least 30 μ s from LPCPD# assertion to LRST# assertion. This specification explicitly states that this protocol only applies to entry/exit of low power states which does not include asynchronous reset events. The ICH10 asserts both SUS_STAT# (connects to LPCPD#) and PLTRST# (connects to LRST#) at the same time when the core logic is reset (via CF9h, PWROK, or SYS_RESET#, etc.). This is not inconsistent with the LPC LPCPD# protocol.

5.4.1.12 Configuration and Intel® ICH10 Implications

LPC I/F Decoders

To allow the I/O cycles and memory mapped cycles to go to the LPC interface, the ICH10 includes several decoders. During configuration, the ICH10 must be programmed with the same decode ranges as the peripheral. The decoders are programmed via the Device 31:Function 0 configuration space.

Note: The ICH10 cannot accept PCI write cycles from PCI-to-PCI bridges or devices with similar characteristics (specifically those with a “Retry Read” feature which is enabled) to an LPC device if there is an outstanding LPC read cycle towards the same PCI device or bridge. These cycles are not part of normal system operation, but may be encountered as part of platform validation testing using custom test fixtures.

Bus Master Device Mapping and START Fields

Bus Masters must have a unique START field. In the case of the ICH10 that supports two LPC bus masters, it drives 0010 for the START field for grants to bus master #0 (requested via LDRQ0#) and 0011 for grants to bus master #1 (requested via LDRQ1#.). Thus, no registers are needed to configure the START fields for a particular bus master.

5.5 DMA Operation (D31:F0)

The ICH10 supports LPC DMA using the ICH10’s DMA controller. The DMA controller has registers that are fixed in the lower 64 KB of I/O space. The DMA controller is configured using registers in the PCI configuration space. These registers allow configuration of the channels for use by LPC DMA.

The DMA circuitry incorporates the functionality of two 82C37 DMA controllers with seven independently programmable channels (Figure 5-3). DMA controller 1 (DMA-1) corresponds to DMA channels 0–3 and DMA controller 2 (DMA-2) corresponds to channels 5–7. DMA channel 4 is used to cascade the two controllers and defaults to cascade mode in the DMA Channel Mode (DCM) Register. Channel 4 is not available for any other purpose. In addition to accepting requests from DMA slaves, the DMA controller also responds to requests that software initiates. Software may initiate a DMA service request by setting any bit in the DMA Channel Request Register to a 1.

Figure 5-3. Intel® ICH10 DMA Controller

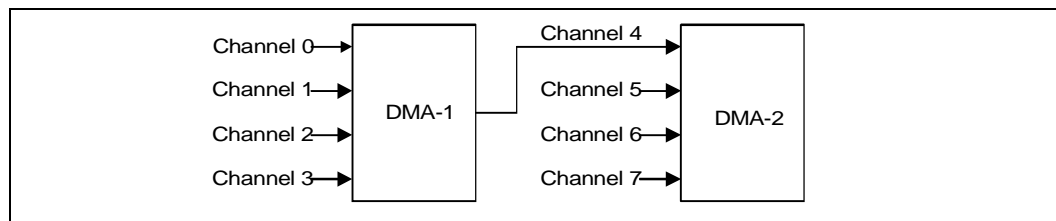

Each DMA channel is hardwired to the compatible settings for DMA device size: channels [3:0] are hardwired to 8-bit, count-by-bytes transfers, and channels [7:5] are hardwired to 16-bit, count-by-words (address shifted) transfers.

ICH10 provides 24-bit addressing in compliance with the ISA-Compatible specification. Each channel includes a 16-bit ISA-Compatible Current Register which holds the 16 least-significant bits of the 24-bit address, an ISA-Compatible Page Register which contains the eight next most significant bits of address.

The DMA controller also features refresh address generation, and auto-initialization following a DMA termination.



5.5.1 Channel Priority

For priority resolution, the DMA consists of two logical channel groups: channels 0–3 and channels 4–7. Each group may be in either fixed or rotate mode, as determined by the DMA Command Register.

DMA I/O slaves normally assert their DREQ line to arbitrate for DMA service. However, a software request for DMA service can be presented through each channel's DMA Request Register. A software request is subject to the same prioritization as any hardware request. See the detailed register description for Request Register programming information in [Section 13.2](#).

5.5.1.1 Fixed Priority

The initial fixed priority structure is as follows:

| High priority | Low priority |
|---------------|--------------|
| 0, 1, 2, 3 | 5, 6, 7 |

The fixed priority ordering is 0, 1, 2, 3, 5, 6, and 7. In this scheme, channel 0 has the highest priority, and channel 7 has the lowest priority. Channels [3:0] of DMA-1 assume the priority position of channel 4 in DMA-2, thus taking priority over channels 5, 6, and 7.

5.5.1.2 Rotating Priority

Rotation allows for “fairness” in priority resolution. The priority chain rotates so that the last channel serviced is assigned the lowest priority in the channel group (0–3, 5–7).

Channels 0–3 rotate as a group of 4. They are always placed between channel 5 and channel 7 in the priority list.

Channel 5–7 rotate as part of a group of 4. That is, channels (5–7) form the first three positions in the rotation, while channel group (0–3) comprises the fourth position in the arbitration.

5.5.2 Address Compatibility Mode

When the DMA is operating, the addresses do not increment or decrement through the High and Low Page Registers. Therefore, if a 24-bit address is 01FFFFh and increments, the next address is 010000h, not 020000h. Similarly, if a 24-bit address is 020000h and decrements, the next address is 02FFFFh, not 01FFFFh. However, when the DMA is operating in 16-bit mode, the addresses still do not increment or decrement through the High and Low Page Registers but the page boundary is now 128 K. Therefore, if a 24-bit address is 01FFFEh and increments, the next address is 000000h, not 0100000h. Similarly, if a 24-bit address is 020000h and decrements, the next address is 03FFFEh, not 02FFFEh. This is compatible with the 82C37 and Page Register implementation used in the PC-AT. This mode is set after CPURST is valid.



5.5.3 Summary of DMA Transfer Sizes

Table 5-10 lists each of the DMA device transfer sizes. The column labeled “Current Byte/Word Count Register” indicates that the register contents represents either the number of bytes to transfer or the number of 16-bit words to transfer. The column labeled “Current Address Increment/Decrement” indicates the number added to or taken from the Current Address register after each DMA transfer cycle. The DMA Channel Mode Register determines if the Current Address Register will be incremented or decremented.

5.5.3.1 Address Shifting When Programmed for 16-Bit I/O Count by Words

Table 5-10. DMA Transfer Size

| DMA Device Data Size And Word Count | Current Byte/Word Count Register | Current Address Increment/Decrement |
|----------------------------------------------|----------------------------------|-------------------------------------|
| 8-Bit I/O, Count By Bytes | Bytes | 1 |
| 16-Bit I/O, Count By Words (Address Shifted) | Words | 1 |

The ICH10 maintains compatibility with the implementation of the DMA in the PC AT that used the 82C37. The DMA shifts the addresses for transfers to/from a 16-bit device count-by-words.

Note: The least significant bit of the Low Page Register is dropped in 16-bit shifted mode. When programming the Current Address Register (when the DMA channel is in this mode), the Current Address must be programmed to an even address with the address value shifted right by one bit.

The address shifting is shown in Table 5-11.

Table 5-11. Address Shifting in 16-Bit I/O DMA Transfers

| Output Address | 8-Bit I/O Programmed Address (Ch 0–3) | 16-Bit I/O Programmed Address (Ch 5–7) (Shifted) |
|---------------------------|---------------------------------------|--------------------------------------------------|
| A0 A[16:1] A[23:17] | A0 A[16:1] A[23:17] | 0 A[15:0] A[23:17] |

NOTE: The least significant bit of the Page Register is dropped in 16-bit shifted mode.

5.5.4 Autoinitialize

By programming a bit in the DMA Channel Mode Register, a channel may be set up as an autoinitialize channel. When a channel undergoes autoinitialization, the original values of the Current Page, Current Address and Current Byte/Word Count Registers are automatically restored from the Base Page, Address, and Byte/Word Count Registers of that channel following TC. The Base Registers are loaded simultaneously with the Current Registers by the microprocessor when the DMA channel is programmed and remain unchanged throughout the DMA service. The mask bit is not set when the channel is in autoinitialize. Following autoinitialize, the channel is ready to perform another DMA service, without processor intervention, as soon as a valid DREQ is detected.

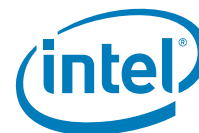

5.5.5 Software Commands

There are three additional special software commands that the DMA controller can execute. The three software commands are:

- Clear Byte Pointer Flip-Flop
- Master Clear
- Clear Mask Register

They do not depend on any specific bit pattern on the data bus.

5.6 LPC DMA

DMA on LPC is handled through the use of the LDRQ# lines from peripherals and special encodings on LAD[3:0] from the host. Single, Demand, Verify, and Increment modes are supported on the LPC interface. Channels 0–3 are 8 bit channels. Channels 5–7 are 16-bit channels. Channel 4 is reserved as a generic bus master request.

5.6.1 Asserting DMA Requests

Peripherals that need DMA service encode their requested channel number on the LDRQ# signal. To simplify the protocol, each peripheral on the LPC I/F has its own dedicated LDRQ# signal (they may not be shared between two separate peripherals). The ICH10 has two LDRQ# inputs, allowing at least two devices to support DMA or bus mastering.

LDRQ# is synchronous with LCLK (PCI clock). As shown in Figure 5-4, the peripheral uses the following serial encoding sequence:

- Peripheral starts the sequence by asserting LDRQ# low (start bit). LDRQ# is high during idle conditions.
- The next three bits contain the encoded DMA channel number (MSB first).
- The next bit (ACT) indicates whether the request for the indicated DMA channel is active or inactive. The ACT bit is 1 (high) to indicate if it is active and 0 (low) if it is inactive. The case where ACT is low is rare, and is only used to indicate that a previous request for that channel is being abandoned.
- After the active/inactive indication, the LDRQ# signal must go high for at least 1 clock. After that one clock, LDRQ# signal can be brought low to the next encoding sequence.

If another DMA channel also needs to request a transfer, another sequence can be sent on LDRQ#. For example, if an encoded request is sent for channel 2, and then channel 3 needs a transfer before the cycle for channel 2 is run on the interface, the peripheral can send the encoded request for channel 3. This allows multiple DMA agents behind an I/O device to request use of the LPC interface, and the I/O device does not need to self-arbitrate before sending the message.

Figure 5-4. DMA Request Assertion through LDRQ#

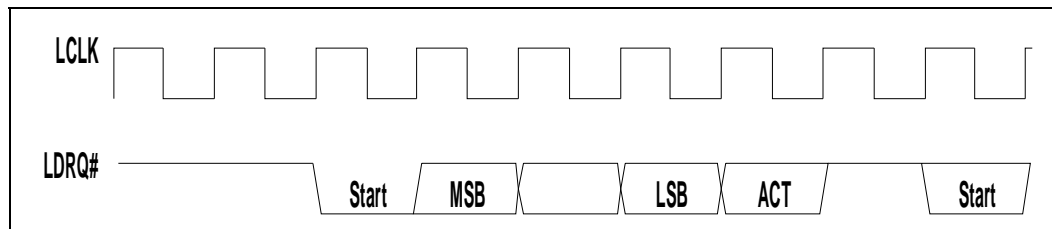

5.6.2 Abandoning DMA Requests

DMA Requests can be deasserted in two fashions: on error conditions by sending an LDRQ# message with the 'ACT' bit set to 0, or normally through a SYNC field during the DMA transfer. This section describes boundary conditions where the DMA request needs to be removed prior to a data transfer.

There may be some special cases where the peripheral desires to abandon a DMA transfer. The most likely case of this occurring is due to a floppy disk controller which has overrun or underrun its FIFO, or software stopping a device prematurely.

In these cases, the peripheral wishes to stop further DMA activity. It may do so by sending an LDRQ# message with the ACT bit as 0. However, since the DMA request was seen by the ICH10, there is no assurance that the cycle has not been granted and will shortly run on LPC. Therefore, peripherals must take into account that a DMA cycle may still occur. The peripheral can choose not to respond to this cycle, in which case the host will abort it, or it can choose to complete the cycle normally with any random data.

This method of DMA deassertion should be prevented whenever possible, to limit boundary conditions both on the ICH10 and the peripheral.

5.6.3 General Flow of DMA Transfers

Arbitration for DMA channels is performed through the 8237 within the host. Once the host has won arbitration on behalf of a DMA channel assigned to LPC, it asserts LFRAME# on the LPC I/F and begins the DMA transfer. The general flow for a basic DMA transfer is as follows:

1. ICH10 starts transfer by asserting 0000b on LAD[3:0] with LFRAME# asserted.
2. ICH10 asserts 'cycle type' of DMA, direction based on DMA transfer direction.
3. ICH10 asserts channel number and, if applicable, terminal count.
4. ICH10 indicates the size of the transfer: 8 or 16 bits.
5. If a DMA read...
 - The ICH10 drives the first 8 bits of data and turns the bus around.
 - The peripheral acknowledges the data with a valid SYNC.
 - If a 16-bit transfer, the process is repeated for the next 8 bits.
6. If a DMA write...
 - The ICH10 turns the bus around and waits for data.
 - The peripheral indicates data ready through SYNC and transfers the first byte.
 - If a 16-bit transfer, the peripheral indicates data ready and transfers the next byte.
7. The peripheral turns around the bus.

5.6.4 Terminal Count

Terminal count is communicated through LAD[3] on the same clock that DMA channel is communicated on LAD[2:0]. This field is the CHANNEL field. Terminal count indicates the last byte of transfer, based upon the size of the transfer.

For example, on an 8-bit transfer size (SIZE field is 00b), if the TC bit is set, then this is the last byte. On a 16-bit transfer (SIZE field is 01b), if the TC bit is set, then the second byte is the last byte. The peripheral, therefore, must internalize the TC bit when the CHANNEL field is communicated, and only signal TC when the last byte of that transfer size has been transferred.



5.6.5 Verify Mode

Verify mode is supported on the LPC interface. A verify transfer to the peripheral is similar to a DMA write, where the peripheral is transferring data to main memory. The indication from the host is the same as a DMA write, so the peripheral will be driving data onto the LPC interface. However, the host will not transfer this data into main memory.

5.6.6 DMA Request Deassertion

An end of transfer is communicated to the ICH10 through a special SYNC field transmitted by the peripheral. An LPC device must not attempt to signal the end of a transfer by deasserting LDREQ#. If a DMA transfer is several bytes (e.g., a transfer from a demand mode device) the ICH10 needs to know when to deassert the DMA request based on the data currently being transferred.

The DMA agent uses a SYNC encoding on each byte of data being transferred, which indicates to the ICH10 whether this is the last byte of transfer or if more bytes are requested. To indicate the last byte of transfer, the peripheral uses a SYNC value of 0000b (ready with no error), or 1010b (ready with error). These encodings tell the ICH10 that this is the last piece of data transferred on a DMA read (ICH10 to peripheral), or the byte that follows is the last piece of data transferred on a DMA write (peripheral to ICH10).

When the ICH10 sees one of these two encodings, it ends the DMA transfer after this byte and deasserts the DMA request to the 8237. Therefore, if the ICH10 indicated a 16-bit transfer, the peripheral can end the transfer after one byte by indicating a SYNC value of 0000b or 1010b. The ICH10 does not attempt to transfer the second byte, and deasserts the DMA request internally.

If the peripheral indicates a 0000b or 1010b SYNC pattern on the last byte of the indicated size, then the ICH10 only deasserts the DMA request to the 8237 since it does not need to end the transfer.

If the peripheral wishes to keep the DMA request active, then it uses a SYNC value of 1001b (ready plus more data). This indicates to the 8237 that more data bytes are requested after the current byte has been transferred, so the ICH10 keeps the DMA request active to the 8237. Therefore, on an 8-bit transfer size, if the peripheral indicates a SYNC value of 1001b to the ICH10, the data will be transferred and the DMA request will remain active to the 8237. At a later time, the ICH10 will then come back with another START-CYCTYPE-CHANNEL-SIZE etc. combination to initiate another transfer to the peripheral.

The peripheral must not assume that the next START indication from the ICH10 is another grant to the peripheral if it had indicated a SYNC value of 1001b. On a single mode DMA device, the 8237 will re-arbitrate after every transfer. Only demand mode DMA devices can be assured that they will receive the next START indication from the ICH10.

Note: Indicating a 0000b or 1010b encoding on the SYNC field of an odd byte of a 16-bit channel (first byte of a 16-bit transfer) is an error condition.

Note: The host stops the transfer on the LPC bus as indicated, fills the upper byte with random data on DMA writes (peripheral to memory), and indicates to the 8237 that the DMA transfer occurred, incrementing the 8237's address and decrementing its byte count.

5.6.7 SYNC Field / LDRQ# Rules

Since DMA transfers on LPC are requested through an LDRQ# assertion message, and are ended through a SYNC field during the DMA transfer, the peripheral must obey the following rule when initiating back-to-back transfers from a DMA channel.

The peripheral must not assert another message for eight LCLKs after a deassertion is indicated through the SYNC field. This is needed to allow the 8237, that typically runs off a much slower internal clock, to see a message deasserted before it is re-asserted so that it can arbitrate to the next agent.

Under default operation, the host only performs 8-bit transfers on 8-bit channels and 16-bit transfers on 16-bit channels.

The method by which this communication between host and peripheral through system BIOS is performed is beyond the scope of this specification. Since the LPC host and LPC peripheral are motherboard devices, no “plug-n-play” registry is required.

The peripheral must not assume that the host is able to perform transfer sizes that are larger than the size allowed for the DMA channel, and be willing to accept a SIZE field that is smaller than what it may currently have buffered.

To that end, it is recommended that future devices that may appear on the LPC bus, that require higher bandwidth than 8-bit or 16-bit DMA allow, do so with a bus mastering interface and not rely on the 8237.

5.7 8254 Timers (D31:F0)

The ICH10 contains three counters that have fixed uses. All registers and functions associated with the 8254 timers are in the core well. The 8254 unit is clocked by a 14.31818 MHz clock.

Counter 0, System Timer

This counter functions as the system timer by controlling the state of IRQ0 and is typically programmed for Mode 3 operation. The counter produces a square wave with a period equal to the product of the counter period (838 ns) and the initial count value. The counter loads the initial count value 1 counter period after software writes the count value to the counter I/O address. The counter initially asserts IRQ0 and decrements the count value by two each counter period. The counter negates IRQ0 when the count value reaches 0. It then reloads the initial count value and again decrements the initial count value by two each counter period. The counter then asserts IRQ0 when the count value reaches 0, reloads the initial count value, and repeats the cycle, alternately asserting and negating IRQ0.

Counter 1, Refresh Request Signal

This counter provides the refresh request signal and is typically programmed for Mode 2 operation and only impacts the period of the REF_TOGGLE bit in Port 61. The initial count value is loaded one counter period after being written to the counter I/O address. The REF_TOGGLE bit will have a square wave behavior (alternate between 0 and 1) and will toggle at a rate based on the value in the counter. Programming the counter to anything other than Mode 2 will result in undefined behavior for the REF_TOGGLE bit.

Counter 2, Speaker Tone

This counter provides the speaker tone and is typically programmed for Mode 3 operation. The counter provides a speaker frequency equal to the counter clock frequency (1.193 MHz) divided by the initial count value. The speaker must be enabled by a write to port 061h (see NMI Status and Control ports).



5.7.1 Timer Programming

The counter/timers are programmed in the following fashion:

1. Write a control word to select a counter.
2. Write an initial count for that counter.
3. Load the least and/or most significant bytes (as required by Control Word bits 5, 4) of the 16-bit counter.
4. Repeat with other counters.

Only two conventions need to be observed when programming the counters. First, for each counter, the control word must be written before the initial count is written. Second, the initial count must follow the count format specified in the control word (least significant byte only, most significant byte only, or least significant byte and then most significant byte).

A new initial count may be written to a counter at any time without affecting the counter's programmed mode. Counting is affected as described in the mode definitions. The new count must follow the programmed count format.

If a counter is programmed to read/write two-byte counts, the following precaution applies: A program must not transfer control between writing the first and second byte to another routine which also writes into that same counter. Otherwise, the counter will be loaded with an incorrect count.

The Control Word Register at port 43h controls the operation of all three counters. Several commands are available:

- **Control Word Command.** Specifies which counter to read or write, the operating mode, and the count format (binary or BCD).
- **Counter Latch Command.** Latches the current count so that it can be read by the system. The countdown process continues.
- **Read Back Command.** Reads the count value, programmed mode, the current state of the OUT pins, and the state of the Null Count Flag of the selected counter.

Table 5-12 lists the six operating modes for the interval counters.

Table 5-12. Counter Operating Modes

| Mode | Function | Description |
|------|--------------------------------------|---------------------------------------------------------------------------------------------------------------------------------------------------------|
| 0 | Out signal on end of count (=0) | Output is 0. When count goes to 0, output goes to 1 and stays at 1 until counter is reprogrammed. |
| 1 | Hardware retriggerable one-shot | Output is 0. When count goes to 0, output goes to 1 for one clock time. |
| 2 | Rate generator (divide by n counter) | Output is 1. Output goes to 0 for one clock time, then back to 1 and counter is reloaded. |
| 3 | Square wave output | Output is 1. Output goes to 0 when counter rolls over, and counter is reloaded. Output goes to 1 when counter rolls over, and counter is reloaded, etc. |
| 4 | Software triggered strobe | Output is 1. Output goes to 0 when count expires for one clock time. |
| 5 | Hardware triggered strobe | Output is 1. Output goes to 0 when count expires for one clock time. |



5.7.2 Reading from the Interval Timer

It is often desirable to read the value of a counter without disturbing the count in progress. There are three methods for reading the counters: a simple read operation, counter Latch command, and the Read-Back command. Each is explained below.

With the simple read and counter latch command methods, the count must be read according to the programmed format; specifically, if the counter is programmed for two byte counts, two bytes must be read. The two bytes do not have to be read one right after the other. Read, write, or programming operations for other counters may be inserted between them.

5.7.2.1 Simple Read

The first method is to perform a simple read operation. The counter is selected through port 40h (counter 0), 41h (counter 1), or 42h (counter 2).

Note: Performing a direct read from the counter does not return a determinate value, because the counting process is asynchronous to read operations. However, in the case of counter 2, the count can be stopped by writing to the GATE bit in port 61h.

5.7.2.2 Counter Latch Command

The Counter Latch command, written to port 43h, latches the count of a specific counter at the time the command is received. This command is used to ensure that the count read from the counter is accurate, particularly when reading a two-byte count. The count value is then read from each counter's Count register as was programmed by the Control register.

The count is held in the latch until it is read or the counter is reprogrammed. The count is then unlatched. This allows reading the contents of the counters on the fly without affecting counting in progress. Multiple Counter Latch Commands may be used to latch more than one counter. Counter Latch commands do not affect the programmed mode of the counter in any way.

If a Counter is latched and then, some time later, latched again before the count is read, the second Counter Latch command is ignored. The count read is the count at the time the first Counter Latch command was issued.

5.7.2.3 Read Back Command

The Read Back command, written to port 43h, latches the count value, programmed mode, and current states of the OUT pin and Null Count flag of the selected counter or counters. The value of the counter and its status may then be read by I/O access to the counter address.

The Read Back command may be used to latch multiple counter outputs at one time. This single command is functionally equivalent to several counter latch commands, one for each counter latched. Each counter's latched count is held until it is read or reprogrammed. Once read, a counter is unlatched. The other counters remain latched until they are read. If multiple count Read Back commands are issued to the same counter without reading the count, all but the first are ignored.

The Read Back command may additionally be used to latch status information of selected counters. The status of a counter is accessed by a read from that counter's I/O port address. If multiple counter status latch operations are performed without reading the status, all but the first are ignored.



Both count and status of the selected counters may be latched simultaneously. This is functionally the same as issuing two consecutive, separate Read Back commands. If multiple count and/or status Read Back commands are issued to the same counters without any intervening reads, all but the first are ignored.

If both count and status of a counter are latched, the first read operation from that counter returns the latched status, regardless of which was latched first. The next one or two reads, depending on whether the counter is programmed for one or two type counts, returns the latched count. Subsequent reads return unlatched count.

5.8 8259 Interrupt Controllers (PIC) (D31:F0)

The ICH10 incorporates the functionality of two 8259 interrupt controllers that provide system interrupts for the ISA compatible interrupts. These interrupts are: system timer, keyboard controller, serial ports, parallel ports, floppy disk, mouse, and DMA channels. In addition, this interrupt controller can support the PCI based interrupts, by mapping the PCI interrupt onto the compatible ISA interrupt line. Each 8259 core supports eight interrupts, numbered 0–7. [Table 5-13](#) shows how the cores are connected.

Table 5-13. Interrupt Controller Core Connections

| 8259 | 8259 Input | Typical Interrupt Source | Connected Pin / Function |
|--------|------------|--------------------------|-------------------------------------------------------------------------------------------------------------------------------|
| Master | 0 | Internal | Internal Timer / Counter 0 output / HPET #0 |
| | 1 | Keyboard | IRQ1 via SERIRQ |
| | 2 | Internal | Slave controller INTR output |
| | 3 | Serial Port A | IRQ3 via SERIRQ, PIRQ# |
| | 4 | Serial Port B | IRQ4 via SERIRQ, PIRQ# |
| | 5 | Parallel Port / Generic | IRQ5 via SERIRQ, PIRQ# |
| | 6 | Floppy Disk | IRQ6 via SERIRQ, PIRQ# |
| | 7 | Parallel Port / Generic | IRQ7 via SERIRQ, PIRQ# |
| Slave | 0 | Internal Real Time Clock | Internal RTC / HPET #1 |
| | 1 | Generic | IRQ9 via SERIRQ, SCI, TCO, or PIRQ# |
| | 2 | Generic | IRQ10 via SERIRQ, SCI, TCO, or PIRQ# |
| | 3 | Generic | IRQ11 via SERIRQ, SCI, TCO, or PIRQ#, or HPET #2 |
| | 4 | PS/2 Mouse | IRQ12 via SERIRQ, SCI, TCO, or PIRQ#, or HPET #3 |
| | 5 | Internal | State Machine output based on processor FERR# assertion. May optionally be used for SCI or TCO interrupt if FERR# not needed. |
| | 6 | SATA | SATA Primary (legacy mode), or via SERIRQ or PIRQ# |
| | 7 | SATA | SATA Secondary (legacy mode) or via SERIRQ or PIRQ# |

The ICH10 cascades the slave controller onto the master controller through master controller interrupt input 2. This means there are only 15 possible interrupts for the ICH10 PIC.



Interrupts can individually be programmed to be edge or level, except for IRQ0, IRQ2, IRQ8#, and IRQ13.

Note: Active-low interrupt sources (e.g., the PIRQ#s) are inverted inside the ICH10. In the following descriptions of the 8259s, the interrupt levels are in reference to the signals at the internal interface of the 8259s, after the required inversions have occurred. Therefore, the term "high" indicates "active," which means "low" on an originating PIRQ#.

5.8.1 Interrupt Handling

5.8.1.1 Generating Interrupts

The PIC interrupt sequence involves three bits, from the IRR, ISR, and IMR, for each interrupt level. These bits are used to determine the interrupt vector returned, and status of any other pending interrupts. Table 5-14 defines the IRR, ISR, and IMR.

Table 5-14. Interrupt Status Registers

| Bit | Description |
|-----|---------------------------------------------------------------------------------------------------------------------------------------------------------------------------------------------------------------------------------------------------------------------------|
| IRR | Interrupt Request Register. This bit is set on a low to high transition of the interrupt line in edge mode, and by an active high level in level mode. This bit is set whether or not the interrupt is masked. However, a masked interrupt will not generate INTR. |
| ISR | Interrupt Service Register. This bit is set, and the corresponding IRR bit cleared, when an interrupt acknowledge cycle is seen, and the vector returned is for that interrupt. |
| IMR | Interrupt Mask Register. This bit determines whether an interrupt is masked. Masked interrupts will not generate INTR. |

5.8.1.2 Acknowledging Interrupts

The processor generates an interrupt acknowledge cycle that is translated by the host bridge into a PCI Interrupt Acknowledge Cycle to the ICH10. The PIC translates this command into two internal INTA# pulses expected by the 8259 cores. The PIC uses the first internal INTA# pulse to freeze the state of the interrupts for priority resolution. On the second INTA# pulse, the master or slave sends the interrupt vector to the processor with the acknowledged interrupt code. This code is based upon bits [7:3] of the corresponding ICW2 register, combined with three bits representing the interrupt within that controller.

Table 5-15. Content of Interrupt Vector Byte

| Master, Slave Interrupt | Bits [7:3] | Bits [2:0] |
|-------------------------|------------|------------|
| IRQ7,15 | ICW2[7:3] | 111 |
| IRQ6,14 | | 110 |
| IRQ5,13 | | 101 |
| IRQ4,12 | | 100 |
| IRQ3,11 | | 011 |
| IRQ2,10 | | 010 |
| IRQ1,9 | | 001 |
| IRQ0,8 | | 000 |



5.8.1.3 Hardware/Software Interrupt Sequence

1. One or more of the Interrupt Request lines (IRQ) are raised high in edge mode, or seen high in level mode, setting the corresponding IRR bit.
2. The PIC sends INTR active to the processor if an asserted interrupt is not masked.
3. The processor acknowledges the INTR and responds with an interrupt acknowledge cycle. The cycle is translated into a PCI interrupt acknowledge cycle by the host bridge. This command is broadcast over PCI by the ICH10.
4. Upon observing its own interrupt acknowledge cycle on PCI, the ICH10 converts it into the two cycles that the internal 8259 pair can respond to. Each cycle appears as an interrupt acknowledge pulse on the internal INTA# pin of the cascaded interrupt controllers.
5. Upon receiving the first internally generated INTA# pulse, the highest priority ISR bit is set and the corresponding IRR bit is reset. On the trailing edge of the first pulse, a slave identification code is broadcast by the master to the slave on a private, internal three bit wide bus. The slave controller uses these bits to determine if it must respond with an interrupt vector during the second INTA# pulse.
6. Upon receiving the second internally generated INTA# pulse, the PIC returns the interrupt vector. If no interrupt request is present because the request was too short in duration, the PIC returns vector 7 from the master controller.
7. This completes the interrupt cycle. In AEOI mode the ISR bit is reset at the end of the second INTA# pulse. Otherwise, the ISR bit remains set until an appropriate EOI command is issued at the end of the interrupt subroutine.

5.8.2 Initialization Command Words (ICWx)

Before operation can begin, each 8259 must be initialized. In the ICH10, this is a four byte sequence. The four initialization command words are referred to by their acronyms: ICW1, ICW2, ICW3, and ICW4.

The base address for each 8259 initialization command word is a fixed location in the I/O memory space: 20h for the master controller, and A0h for the slave controller.

5.8.2.1 ICW1

An I/O write to the master or slave controller base address with data bit 4 equal to 1 is interpreted as a write to ICW1. Upon sensing this write, the ICH10 PIC expects three more byte writes to 21h for the master controller, or A1h for the slave controller, to complete the ICW sequence.

A write to ICW1 starts the initialization sequence during which the following automatically occur:

1. Following initialization, an interrupt request (IRQ) input must make a low-to-high transition to generate an interrupt.
2. The Interrupt Mask Register is cleared.
3. IRQ7 input is assigned priority 7.
4. The slave mode address is set to 7.
5. Special mask mode is cleared and Status Read is set to IRR.

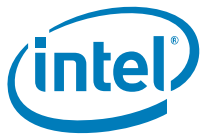

5.8.2.2 ICW2

The second write in the sequence (ICW2) is programmed to provide bits [7:3] of the interrupt vector that will be released during an interrupt acknowledge. A different base is selected for each interrupt controller.

5.8.2.3 ICW3

The third write in the sequence (ICW3) has a different meaning for each controller.

- For the master controller, ICW3 is used to indicate which IRQ input line is used to cascade the slave controller. Within the ICH10, IRQ2 is used. Therefore, bit 2 of ICW3 on the master controller is set to a 1, and the other bits are set to 0s.
- For the slave controller, ICW3 is the slave identification code used during an interrupt acknowledge cycle. On interrupt acknowledge cycles, the master controller broadcasts a code to the slave controller if the cascaded interrupt won arbitration on the master controller. The slave controller compares this identification code to the value stored in its ICW3, and if it matches, the slave controller assumes responsibility for broadcasting the interrupt vector.

5.8.2.4 ICW4

The final write in the sequence (ICW4) must be programmed for both controllers. At the very least, bit 0 must be set to a 1 to indicate that the controllers are operating in an Intel Architecture-based system.

5.8.3 Operation Command Words (OCW)

These command words reprogram the Interrupt controller to operate in various interrupt modes.

- OCW1 masks and unmask interrupt lines.
- OCW2 controls the rotation of interrupt priorities when in rotating priority mode, and controls the EOI function.
- OCW3 sets up ISR/IRR reads, enables/disables the special mask mode (SMM), and enables/disables polled interrupt mode.

5.8.4 Modes of Operation

5.8.4.1 Fully Nested Mode

In this mode, interrupt requests are ordered in priority from 0 through 7, with 0 being the highest. When an interrupt is acknowledged, the highest priority request is determined and its vector placed on the bus. Additionally, the ISR for the interrupt is set. This ISR bit remains set until: the processor issues an EOI command immediately before returning from the service routine; or if in AEIOI mode, on the trailing edge of the second INTA#. While the ISR bit is set, all further interrupts of the same or lower priority are inhibited, while higher levels generate another interrupt. Interrupt priorities can be changed in the rotating priority mode.



5.8.4.2 Special Fully-Nested Mode

This mode is used in the case of a system where cascading is used, and the priority has to be conserved within each slave. In this case, the special fully-nested mode is programmed to the master controller. This mode is similar to the fully-nested mode with the following exceptions:

- When an interrupt request from a certain slave is in service, this slave is not locked out from the master's priority logic and further interrupt requests from higher priority interrupts within the slave are recognized by the master and initiate interrupts to the processor. In the normal-nested mode, a slave is masked out when its request is in service.
- When exiting the Interrupt Service routine, software has to check whether the interrupt serviced was the only one from that slave. This is done by sending a Non-Specific EOI command to the slave and then reading its ISR. If it is 0, a non-specific EOI can also be sent to the master.

5.8.4.3 Automatic Rotation Mode (Equal Priority Devices)

In some applications, there are a number of interrupting devices of equal priority. Automatic rotation mode provides for a sequential 8-way rotation. In this mode, a device receives the lowest priority after being serviced. In the worst case, a device requesting an interrupt has to wait until each of seven other devices are serviced at most once.

There are two ways to accomplish automatic rotation using OCW2; the Rotation on Non-Specific EOI Command (R=1, SL=0, EOI=1) and the rotate in automatic EOI mode which is set by (R=1, SL=0, EOI=0).

5.8.4.4 Specific Rotation Mode (Specific Priority)

Software can change interrupt priorities by programming the bottom priority. For example, if IRQ5 is programmed as the bottom priority device, then IRQ6 is the highest priority device. The Set Priority Command is issued in OCW2 to accomplish this, where: R=1, SL=1, and LO–L2 is the binary priority level code of the bottom priority device.

In this mode, internal status is updated by software control during OCW2. However, it is independent of the EOI command. Priority changes can be executed during an EOI command by using the Rotate on Specific EOI Command in OCW2 (R=1, SL=1, EOI=1, and LO–L2=IRQ level to receive bottom priority.

5.8.4.5 Poll Mode

Poll mode can be used to conserve space in the interrupt vector table. Multiple interrupts that can be serviced by one interrupt service routine do not need separate vectors if the service routine uses the poll command. Poll mode can also be used to expand the number of interrupts. The polling interrupt service routine can call the appropriate service routine, instead of providing the interrupt vectors in the vector table. In this mode, the INTR output is not used and the microprocessor internal Interrupt Enable flip-flop is reset, disabling its interrupt input. Service to devices is achieved by software using a Poll command.

The Poll command is issued by setting P=1 in OCW3. The PIC treats its next I/O read as an interrupt acknowledge, sets the appropriate ISR bit if there is a request, and reads the priority level. Interrupts are frozen from the OCW3 write to the I/O read. The byte returned during the I/O read contains a 1 in bit 7 if there is an interrupt, and the binary code of the highest priority level in bits 2:0.

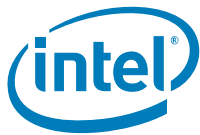

5.8.4.6 Cascade Mode

The PIC in the ICH10 has one master 8259 and one slave 8259 cascaded onto the master through IRQ2. This configuration can handle up to 15 separate priority levels. The master controls the slaves through a three bit internal bus. In the ICH10, when the master drives 010b on this bus, the slave controller takes responsibility for returning the interrupt vector. An EOI command must be issued twice: once for the master and once for the slave.

5.8.4.7 Edge and Level Triggered Mode

In ISA systems this mode is programmed using bit 3 in ICW1, which sets level or edge for the entire controller. In the ICH10, this bit is disabled and a new register for edge and level triggered mode selection, per interrupt input, is included. This is the Edge/Level control Registers ELCR1 and ELCR2.

If an ELCR bit is 0, an interrupt request will be recognized by a low-to-high transition on the corresponding IRQ input. The IRQ input can remain high without generating another interrupt. If an ELCR bit is 1, an interrupt request will be recognized by a high level on the corresponding IRQ input and there is no need for an edge detection. The interrupt request must be removed before the EOI command is issued to prevent a second interrupt from occurring.

In both the edge and level triggered modes, the IRQ inputs must remain active until after the falling edge of the first internal INTA#. If the IRQ input goes inactive before this time, a default IRQ7 vector is returned.

5.8.4.8 End of Interrupt (EOI) Operations

An EOI can occur in one of two fashions: by a command word write issued to the PIC before returning from a service routine, the EOI command; or automatically when AEIOI bit in ICW4 is set to 1.

5.8.4.9 Normal End of Interrupt

In normal EOI, software writes an EOI command before leaving the interrupt service routine to mark the interrupt as completed. There are two forms of EOI commands: Specific and Non-Specific. When a Non-Specific EOI command is issued, the PIC clears the highest ISR bit of those that are set to 1. Non-Specific EOI is the normal mode of operation of the PIC within the ICH10, as the interrupt being serviced currently is the interrupt entered with the interrupt acknowledge. When the PIC is operated in modes that preserve the fully nested structure, software can determine which ISR bit to clear by issuing a Specific EOI. An ISR bit that is masked is not cleared by a Non-Specific EOI if the PIC is in the special mask mode. An EOI command must be issued for both the master and slave controller.

5.8.4.10 Automatic End of Interrupt Mode

In this mode, the PIC automatically performs a Non-Specific EOI operation at the trailing edge of the last interrupt acknowledge pulse. From a system standpoint, this mode should be used only when a nested multi-level interrupt structure is not required within a single PIC. The AEIOI mode can only be used in the master controller and not the slave controller.



5.8.5 Masking Interrupts

5.8.5.1 Masking on an Individual Interrupt Request

Each interrupt request can be masked individually by the Interrupt Mask Register (IMR). This register is programmed through OCW1. Each bit in the IMR masks one interrupt channel. Masking IRQ2 on the master controller masks all requests for service from the slave controller.

5.8.5.2 Special Mask Mode

Some applications may require an interrupt service routine to dynamically alter the system priority structure during its execution under software control. For example, the routine may wish to inhibit lower priority requests for a portion of its execution but enable some of them for another portion.

The special mask mode enables all interrupts not masked by a bit set in the Mask register. Normally, when an interrupt service routine acknowledges an interrupt without issuing an EOI to clear the ISR bit, the interrupt controller inhibits all lower priority requests. In the special mask mode, any interrupts may be selectively enabled by loading the Mask Register with the appropriate pattern. The special mask mode is set by OCW3 where: SSMM=1, SMM=1, and cleared where SSMM=1, SMM=0.

5.8.6 Steering PCI Interrupts

The ICH10 can be programmed to allow PIRQA#-PIRQH# to be routed internally to interrupts 3-7, 9-12, 14 or 15. The assignment is programmable through the PIRQx Route Control registers, located at 60-63h and 68-6Bh in Device 31:Function 0. One or more PIRQx# lines can be routed to the same IRQx input. If interrupt steering is not required, the Route registers can be programmed to disable steering.

The PIRQx# lines are defined as active low, level sensitive to allow multiple interrupts on a PCI board to share a single line across the connector. When a PIRQx# is routed to specified IRQ line, software must change the IRQ's corresponding ELCR bit to level sensitive mode. The ICH10 internally inverts the PIRQx# line to send an active high level to the PIC. When a PCI interrupt is routed onto the PIC, the selected IRQ can no longer be used by an active high device (through SERIRQ). However, active low interrupts can share their interrupt with PCI interrupts.

Internal sources of the PIRQs, including SCI and TCO interrupts, cause the external PIRQ to be asserted. The ICH10 receives the PIRQ input, like all of the other external sources, and routes it accordingly.



5.9 Advanced Programmable Interrupt Controller (APIC) (D31:F0)

In addition to the standard ISA-compatible PIC described in the previous chapter, the ICH10 incorporates the APIC. While the standard interrupt controller is intended for use in a uni-processor system, APIC can be used in either a uni-processor or multi-processor system.

5.9.1 Interrupt Handling

The I/O APIC handles interrupts very differently than the 8259. Briefly, these differences are:

- **Method of Interrupt Transmission.** The I/O APIC transmits interrupts through memory writes on the normal datapath to the processor, and interrupts are handled without the need for the processor to run an interrupt acknowledge cycle.
- **Interrupt Priority.** The priority of interrupts in the I/O APIC is independent of the interrupt number. For example, interrupt 10 can be given a higher priority than interrupt 3.
- **More Interrupts.** The I/O APIC in the ICH10 supports a total of 24 interrupts.
- **Multiple Interrupt Controllers.** The I/O APIC architecture allows for multiple I/O APIC devices in the system with their own interrupt vectors.

5.9.2 Interrupt Mapping

The I/O APIC within the ICH10 supports 24 APIC interrupts. Each interrupt has its own unique vector assigned by software. The interrupt vectors are mapped as follows, and match “Config 6” of the *Multi-Processor Specification*.

Table 5-16. APIC Interrupt Mapping¹ (Sheet 1 of 2)

| IRQ # | Via SERIRQ | Direct from Pin | Via PCI Message | Internal Modules |
|-------|------------|-----------------|-----------------|---------------------------------------|
| 0 | No | No | No | Cascade from 8259 #1 |
| 1 | Yes | No | Yes | |
| 2 | No | No | No | 8254 Counter 0, HPET #0 (legacy mode) |
| 3 | Yes | No | Yes | |
| 4 | Yes | No | Yes | |
| 5 | Yes | No | Yes | |
| 6 | Yes | No | Yes | |
| 7 | Yes | No | Yes | |
| 8 | No | No | No | RTC, HPET #1 (legacy mode) |
| 9 | Yes | No | Yes | Option for SCI, TCO |
| 10 | Yes | No | Yes | Option for SCI, TCO |
| 11 | Yes | No | Yes | HPET #2, Option for SCI, TCO (Note2) |
| 12 | Yes | No | Yes | HPET #3 (Note 3) |
| 13 | No | No | No | FERR# logic |
| 14 | Yes | No | Yes | SATA Primary (legacy mode) |
| 15 | Yes | No | Yes | SATA Secondary (legacy mode) |

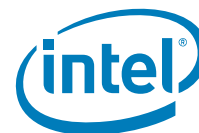
Table 5-16. APIC Interrupt Mapping¹ (Sheet 2 of 2)

| IRQ # | Via SERIRQ | Direct from Pin | Via PCI Message | Internal Modules |
|-------|------------|---------------------|-----------------|---------------------------------------------------------------------------------------------------------------------------------------------------------|
| 16 | PIRQA# | PIRQA# | Yes | Internal devices are routable; see Section 10.1.54 through Section 10.1.60 . |
| 17 | PIRQB# | PIRQB# | | |
| 18 | PIRQC# | PIRQC# | | |
| 19 | PIRQD# | PIRQD# | | |
| 20 | N/A | PIRQE# ⁴ | Yes | Option for SCI, TCO, HPET #0,1,2, 3. Other internal devices are routable; see Section 10.1.54 through Section 10.1.60 . |
| 21 | N/A | PIRQF# ⁴ | | |
| 22 | N/A | PIRQG# ⁴ | | |
| 23 | N/A | PIRQH# ⁴ | | |

NOTES:

- When programming the polarity of internal interrupt sources on the APIC, interrupts 0 through 15 receive active-high internal interrupt sources, while interrupts 16 through 23 receive active-low internal interrupt sources.
- If IRQ 11 is used for HPET #2, software should ensure IRQ 11 is not shared with any other devices to ensure the proper operation of HPET #2. ICH10 hardware does not prevent sharing of IRQ 11.
- If IRQ 12 is used for HPET #3, software should ensure IRQ 12 is not shared with any other devices to ensure the proper operation of HPET #3. ICH10 hardware does not prevent sharing of IRQ 12.
- PIRQ[E:H] are Multiplexed with GPIO pins. Interrupts PIRQ[E:H] will not be exposed if they are configured as GPIOs.

5.9.3 PCI / PCI Express* Message-Based Interrupts

When external devices through PCI / PCI Express wish to generate an interrupt, they will send the message defined in the *PCI Express* Base Specification*, Revision 1.0a for generating INTA# - INTD#. These will be translated internal assertions/de-assertions of INTA# – INTD#.

5.9.4 Front Side Bus Interrupt Delivery

For processors that support Front Side Bus (FSB) interrupt delivery, the ICH10 requires that the I/O APIC deliver interrupt messages to the processor in a parallel manner, rather than using the I/O APIC serial scheme.

This is done by the ICH10 writing (via DMI) to a memory location that is snooped by the processor(s). The processor(s) snoop the cycle to know which interrupt goes active.

The following sequence is used:

- When the ICH10 detects an interrupt event (active edge for edge-triggered mode or a change for level-triggered mode), it sets or resets the internal IRR bit associated with that interrupt.
- Internally, the ICH10 requests to use the bus in a way that automatically flushes upstream buffers. This can be internally implemented similar to a DMA device request.
- The ICH10 then delivers the message by performing a write cycle to the appropriate address with the appropriate data. The address and data formats are described below in [Section 5.9.4.4](#).

Note: FSB Interrupt Delivery compatibility with processor clock control depends on the processor, not the ICH10.



5.9.4.1 Edge-Triggered Operation

In this case, the “Assert Message” is sent when there is an inactive-to-active edge on the interrupt.

5.9.4.2 Level-Triggered Operation

In this case, the “Assert Message” is sent when there is an inactive-to-active edge on the interrupt. If after the EOI the interrupt is still active, then another “Assert Message” is sent to indicate that the interrupt is still active.

5.9.4.3 Registers Associated with Front Side Bus Interrupt Delivery

Capabilities Indication: The capability to support Front Side Bus interrupt delivery is indicated via ACPI configuration techniques. This involves the BIOS creating a data structure that gets reported to the ACPI configuration software.

5.9.4.4 Interrupt Message Format

The ICH10 writes the message to PCI (and to the Host controller) as a 32-bit memory write cycle. It uses the formats shown in Table 5-17 and Table 5-18 for the address and data.

The local APIC (in the processor) has a delivery mode option to interpret Front Side Bus messages as a SMI in which case the processor treats the incoming interrupt as a SMI instead of as an interrupt. This does not mean that the ICH10 has any way to have a SMI source from ICH10 power management logic cause the I/O APIC to send an SMI message (there is no way to do this). The ICH10’s I/O APIC can only send interrupts due to interrupts which do not include SMI, NMI or INIT. This means that in IA-32/ Intel® 64 based platforms, Front Side Bus interrupt message format delivery modes 010 (SMI/PMI), 100 (NMI), and 101 (INIT) as indicated in this section, must not be used and is not supported. Only the hardware pin connection is supported by ICH10.

Table 5-17. Interrupt Message Address Format

| Bit | Description |
|-------|----------------------------------------------------------------------------------------------------------------------------------------------------------------------------------------------------------------------------------------------------------------------------------------------------------------------------------------------------------------------------------------------------------------------------------------------------------------------------------------------------------------------------------------------------------------------------|
| 31:20 | Will always be FEEh |
| 19:12 | Destination ID: This is the same as bits 63:56 of the I/O Redirection Table entry for the interrupt associated with this message. |
| 11:4 | Extended Destination ID: This is the same as bits 55:48 of the I/O Redirection Table entry for the interrupt associated with this message. |
| 3 | Redirection Hint: This bit is used by the processor host bridge to allow the interrupt message to be redirected. 0 = The message will be delivered to the agent (processor) listed in bits 19:12. 1 = The message will be delivered to an agent with a lower interrupt priority This can be derived from bits 10:8 in the Data Field (see below). The Redirection Hint bit will be a 1 if bits 10:8 in the delivery mode field associated with corresponding interrupt are encoded as 001 (Lowest Priority). Otherwise, the Redirection Hint bit will be 0 |
| 2 | Destination Mode: This bit is used only the Redirection Hint bit is set to 1. If the Redirection Hint bit and the Destination Mode bit are both set to 1, then the logical destination mode is used, and the redirection is limited only to those processors that are part of the logical group as based on the logical ID. |
| 1:0 | Will always be 00. |



Table 5-18. Interrupt Message Data Format

| Bit | Description |
|-------|-----------------------------------------------------------------------------------------------------------------------------------------------------------------------------------------------------------------------------------------------|
| 31:16 | Will always be 0000h. |
| 15 | Trigger Mode: 1 = Level, 0 = Edge. Same as the corresponding bit in the I/O Redirection Table for that interrupt. |
| 14 | Delivery Status: 1 = Assert, 0 = Deassert. Only Assert messages are sent. This bit is always 1. |
| 13:12 | Will always be 00 |
| 11 | Destination Mode: 1 = Logical. 0 = Physical. Same as the corresponding bit in the I/O Redirection Table for that interrupt. |
| 10:8 | Delivery Mode: This is the same as the corresponding bits in the I/O Redirection Table for that interrupt. 000 = Fixed 100 = NMI 001 = Lowest Priority 101 = INIT 010 = SMI/PMI 110 = Reserved 011 = Reserved 111 = ExtINT |
| 7:0 | Vector: This is the same as the corresponding bits in the I/O Redirection Table for that interrupt. |

5.9.5 IOxAPIC Address Remapping

To support Intel® Virtualization Technology, interrupt messages are required to go through similar address remapping as any other memory request. Address remapping allows for domain isolation for interrupts, so a device assigned in one domain is not allowed to generate an interrupt to another domain.

The address remapping is based on the Bus: Device: Function field associated with the requests. The internal APIC is required to initiate the interrupt message using a unique Bus: Device: function.

ICH10 allows BIOS to program the unique Bus: Device: Function address for the internal APIC. This address field does not change the APIC functionality and the APIC is not promoted as a stand-alone PCI device. See Device 31: Function 0 Offset 6Ch for additional information.

5.9.6 External Interrupt Controller Support

The ICH10 supports external APICs off of PCI Express ports, and does not support APICs on the PCI bus. The EOI special cycle is only forwarded to PCI Express ports.

5.10 Serial Interrupt (D31:F0)

The ICH10 supports a serial IRQ scheme. This allows a single signal to be used to report interrupt requests. The signal used to transmit this information is shared between the host, the ICH10, and all peripherals that support serial interrupts. The signal line, SERIRQ, is synchronous to PCI clock, and follows the sustained tri-state protocol that is used by all PCI signals. This means that if a device has driven SERIRQ low, it will first drive it high synchronous to PCI clock and release it the following PCI clock. The serial IRQ protocol defines this sustained tri-state signaling in the following fashion:

- **S – Sample Phase.** Signal driven low
- **R – Recovery Phase.** Signal driven high
- **T – Turn-around Phase.** Signal released

The ICH10 supports a message for 21 serial interrupts. These represent the 15 ISA interrupts (IRQ0–1, 2–15), the four PCI interrupts, and the control signals SMI# and IOCHK#. The serial IRQ protocol does not support the additional APIC interrupts (20–23).

Note: When the SATA controller is configured for legacy IDE mode, IRQ14 and IRQ15 are expected to behave as ISA legacy interrupts, which cannot be shared (i.e., through the Serial Interrupt pin). If IRQ14 and IRQ15 are shared with Serial Interrupt pin, then abnormal system behavior may occur. For example, IRQ14/15 may not be detected by ICH10's interrupt controller. When the SATA controller is not running in Native IDE mode, IRQ14 and IRQ15 are used as special interrupts. If the SATA controller is in native modes, these interrupts can be mapped to other devices accordingly.

5.10.1 Start Frame

The serial IRQ protocol has two modes of operation which affect the start frame. These two modes are: Continuous, where the ICH10 is solely responsible for generating the start frame; and Quiet, where a serial IRQ peripheral is responsible for beginning the start frame.

The mode that must first be entered when enabling the serial IRQ protocol is continuous mode. In this mode, the ICH10 asserts the start frame. This start frame is 4, 6, or 8 PCI clocks wide based upon the Serial IRQ Control Register, bits 1:0 at 64h in Device 31:Function 0 configuration space. This is a polling mode.

When the serial IRQ stream enters quiet mode (signaled in the Stop Frame), the SERIRQ line remains inactive and pulled up between the Stop and Start Frame until a peripheral drives the SERIRQ signal low. The ICH10 senses the line low and continues to drive it low for the remainder of the Start Frame. Since the first PCI clock of the start frame was driven by the peripheral in this mode, the ICH10 drives the SERIRQ line low for 1 PCI clock less than in continuous mode. This mode of operation allows for a quiet, and therefore, lower power operation.



5.10.2 Data Frames

Once the Start frame has been initiated, all of the SERIRQ peripherals must start counting frames based on the rising edge of SERIRQ. Each of the IRQ/DATA frames has exactly 3 phases of 1 clock each:

- **Sample Phase.** During this phase, the SERIRQ device drives SERIRQ low if the corresponding interrupt signal is low. If the corresponding interrupt is high, then the SERIRQ devices tri-state the SERIRQ signal. The SERIRQ line remains high due to pull-up resistors (there is no internal pull-up resistor on this signal, an external pull-up resistor is required). A low level during the IRQ0–1 and IRQ2–15 frames indicates that an active-high ISA interrupt is not being requested, but a low level during the PCI INT[A:D], SMI#, and IOCHK# frame indicates that an active-low interrupt is being requested.
- **Recovery Phase.** During this phase, the device drives the SERIRQ line high if in the Sample Phase it was driven low. If it was not driven in the sample phase, it is tri-stated in this phase.
- **Turn-around Phase.** The device tri-states the SERIRQ line.

5.10.3 Stop Frame

After all data frames, a Stop Frame is driven by the ICH10. The SERIRQ signal is driven low by the ICH10 for 2 or 3 PCI clocks. The number of clocks is determined by the SERIRQ configuration register. The number of clocks determines the next mode (see Table 5-19).

Table 5-19. Stop Frame Explanation

| Stop Frame Width | Next Mode |
|------------------|---------------------------------------------------------------------------------|
| 2 PCI clocks | Quiet Mode. Any SERIRQ device may initiate a Start Frame |
| 3 PCI clocks | Continuous Mode. Only the host (Intel® ICH10) may initiate a Start Frame |

5.10.4 Specific Interrupts Not Supported via SERIRQ

There are three interrupts seen through the serial stream that are not supported by the ICH10. These interrupts are generated internally, and are not sharable with other devices within the system. These interrupts are:

- IRQ0. Heartbeat interrupt generated off of the internal 8254 counter 0.
- IRQ8#. RTC interrupt can only be generated internally.
- IRQ13. Floating point error interrupt generated off of the processor assertion of FERR#.

The ICH10 ignores the state of these interrupts in the serial stream, and does not adjust their level based on the level seen in the serial stream.



5.10.5 Data Frame Format

Table 5-20 shows the format of the data frames. For the PCI interrupts (A–D), the output from the ICH10 is AND'd with the PCI input signal. This way, the interrupt can be signaled via both the PCI interrupt input signal and via the SERIRQ signal (they are shared).

Table 5-20. Data Frame Format

| Data Frame # | Interrupt | Clocks Past Start Frame | Comment |
|--------------|-----------|-------------------------|-----------------------------------------------------------|
| 1 | IRQ0 | 2 | Ignored. IRQ0 can only be generated via the internal 8524 |
| 2 | IRQ1 | 5 | |
| 3 | SMI# | 8 | Causes SMI# if low. Will set the SERIRQ_SMI_STS bit. |
| 4 | IRQ3 | 11 | |
| 5 | IRQ4 | 14 | |
| 6 | IRQ5 | 17 | |
| 7 | IRQ6 | 20 | |
| 8 | IRQ7 | 23 | |
| 9 | IRQ8 | 26 | Ignored. IRQ8# can only be generated internally. |
| 10 | IRQ9 | 29 | |
| 11 | IRQ10 | 32 | |
| 12 | IRQ11 | 35 | |
| 13 | IRQ12 | 38 | |
| 14 | IRQ13 | 41 | Ignored. IRQ13 can only be generated from FERR# |
| 15 | IRQ14 | 44 | Not attached to SATA logic |
| 16 | IRQ15 | 47 | Not attached to SATA logic |
| 17 | IOCHCK# | 50 | Same as ISA IOCHCK# going active. |
| 18 | PCI INTA# | 53 | Drive PIROA# |
| 19 | PCI INTB# | 56 | Drive PIROB# |
| 20 | PCI INTC# | 59 | Drive PIROC# |
| 21 | PCI INTD# | 62 | Drive PIROD# |



5.11 Real Time Clock (D31:F0)

The Real Time Clock (RTC) module provides a battery backed-up date and time keeping device with two banks of static RAM with 128 bytes each, although the first bank has 114 bytes for general purpose usage. Three interrupt features are available: time of day alarm with once a second to once a month range, periodic rates of 122 μ s to 500 ms, and end of update cycle notification. Seconds, minutes, hours, days, day of week, month, and year are counted. Daylight savings compensation is no longer supported. The hour is represented in twelve or twenty-four hour format, and data can be represented in BCD or binary format. The design is functionally compatible with the Motorola MS146818B. The time keeping comes from a 32.768 kHz oscillating source, which is divided to achieve an update every second. The lower 14 bytes on the lower RAM block has very specific functions. The first ten are for time and date information. The next four (0Ah to 0Dh) are registers, which configure and report RTC functions.

The time and calendar data should match the data mode (BCD or binary) and hour mode (12 or 24 hour) as selected in register B. It is up to the programmer to make sure that data stored in these locations is within the reasonable values ranges and represents a possible date and time. The exception to these ranges is to store a value of C0–FFh in the Alarm bytes to indicate a don't care situation. All Alarm conditions must match to trigger an Alarm Flag, which could trigger an Alarm Interrupt if enabled. The SET bit must be 1 while programming these locations to avoid clashes with an update cycle. Access to time and date information is done through the RAM locations. If a RAM read from the ten time and date bytes is attempted during an update cycle, the value read do not necessarily represent the true contents of those locations. Any RAM writes under the same conditions are ignored.

Note: The leap year determination for adding a 29th day to February does not take into account the end-of-the-century exceptions. The logic simply assumes that all years divisible by 4 are leap years. According to the Royal Observatory Greenwich, years that are divisible by 100 are typically not leap years. In every fourth century (years divisible by 400, like 2000), the 100-year-exception is over-ridden and a leap-year occurs. Note that the year 2100 will be the first time in which the current RTC implementation would incorrectly calculate the leap-year.

The ICH10 does not implement month/year alarms.

5.11.1 Update Cycles

An update cycle occurs once a second, if the SET bit of register B is not asserted and the divide chain is properly configured. During this procedure, the stored time and date are incremented, overflow is checked, a matching alarm condition is checked, and the time and date are rewritten to the RAM locations. The update cycle will start at least 488 μ s after the UIP bit of register A is asserted, and the entire cycle does not take more than 1984 μ s to complete. The time and date RAM locations (0–9) are disconnected from the external bus during this time.

To avoid update and data corruption conditions, external RAM access to these locations can safely occur at two times. When a updated-ended interrupt is detected, almost 999 ms is available to read and write the valid time and date data. If the UIP bit of Register A is detected to be low, there is at least 488 μ s before the update cycle begins.

Warning: The overflow conditions for leap years adjustments are based on more than one date or time item. To ensure proper operation when adjusting the time, the new time and data values should be set at least two seconds before leap year occurs.



5.11.2 Interrupts

The real-time clock interrupt is internally routed within the ICH10 both to the I/O APIC and the 8259. It is mapped to interrupt vector 8. This interrupt does not leave the ICH10, nor is it shared with any other interrupt. IRQ8# from the SERIRQ stream is ignored. However, the High Performance Event Timers can also be mapped to IRQ8#; in this case, the RTC interrupt is blocked.

5.11.3 Lockable RAM Ranges

The RTC's battery-backed RAM supports two 8-byte ranges that can be locked via the configuration space. If the locking bits are set, the corresponding range in the RAM will not be readable or writable. A write cycle to those locations will have no effect. A read cycle to those locations will not return the location's actual value (resultant value is undefined).

Once a range is locked, the range can be unlocked only by a hard reset, which will invoke the BIOS and allow it to relock the RAM range.

5.11.4 Century Rollover

The ICH10 detects a rollover when the Year byte (RTC I/O space, index offset 09h) transitions from 99 to 00. Upon detecting the rollover, the ICH10 sets the NEWCENTURY_STS bit (TCOBASE + 04h, bit 7). If the system is in an S0 state, this causes an SMI#. The SMI# handler can update registers in the RTC RAM that are associated with century value. If the system is in a sleep state (S1–S5) when the century rollover occurs, the ICH10 also sets the NEWCENTURY_STS bit, but no SMI# is generated. When the system resumes from the sleep state, BIOS should check the NEWCENTURY_STS bit and update the century value in the RTC RAM.

5.11.5 Clearing Battery-Backed RTC RAM

Clearing CMOS RAM in an ICH10-based platform can be done by using a jumper on RTCRST# or GPI. Implementations should not attempt to clear CMOS by using a jumper to pull VccRTC low.

Using RTCRST# to Clear CMOS

A jumper on RTCRST# can be used to clear CMOS values, as well as reset to default, the state of those configuration bits that reside in the RTC power well. When the RTCRST# is strapped to ground, the RTC_PWR_STS bit (D31:F0:A4h bit 2) will be set and those configuration bits in the RTC power well will be set to their default state. BIOS can monitor the state of this bit, and manually clear the RTC CMOS array once the system is booted. The normal position would cause RTCRST# to be pulled up through a weak pull-up resistor. [Table 5-21](#) shows which bits are set to their default state when RTCRST# is asserted. This RTCRST# jumper technique allows the jumper to be moved and then replaced—all while the system is powered off. Then, once booted, the RTC_PWR_STS can be detected in the set state.



Table 5-21. Configuration Bits Reset by RTCRST# Assertion

| Bit Name | Register | Location | Bit(s) | Default State |
|--------------------------------------------|----------------------------------------------------|----------------------------------------|--------|---------------|
| Alarm Interrupt Enable (AIE) | Register B (General Configuration) (RTC_REGB) | I/O space (RTC Index + 0Bh) | 5 | X |
| Alarm Flag (AF) | Register C (Flag Register) (RTC_REGC) | I/O space (RTC Index + 0Ch) | 5 | X |
| SWSMI_RATE_SEL | General PM Configuration 3 Register GEN_PMCON_3 | D31:F0:A4h | 7:6 | 0 |
| SLP_S4# Minimum Assertion Width | General PM Configuration 3 Register GEN_PMCON_3 | D31:F0:A4h | 5:4 | 0 |
| SLP_S4# Assertion Stretch Enable | General PM Configuration 3 Register GEN_PMCON_3 | D31:F0:A4h | 3 | 0 |
| RTC Power Status (RTC_PWR_STS) | General PM Configuration 3 Register GEN_PMCON_3 | D31:F0:A4h | 2 | 0 |
| Power Failure (PWR_FLR) | General PM Configuration 3 Register (GEN_PMCON_3) | D31:F0:A4h | 1 | 0 |
| AFTERG3_EN | General PM Configuration 3 Register GEN_PMCON_3 | D31:F0:A4h | 0 | 0 |
| Power Button Override Status (PRBTNOR_STS) | Power Management 1 Status Register (PM1_STS) | PMBase + 00h | 11 | 0 |
| RTC Event Enable (RTC_EN) | Power Management 1 Enable Register (PM1_EN) | PMBase + 02h | 10 | 0 |
| Sleep Type (SLP_TYP) | Power Management 1 Control (PM1_CNT) | PMBase + 04h | 12:10 | 0 |
| PME_EN | General Purpose Event 0 Enables Register (GPE0_EN) | PMBase + 2Ch | 11 | 0 |
| BATLOW_EN | General Purpose Event 0 Enables Register (GPE0_EN) | PMBase + 2Ch | 10 | 0 |
| RI_EN | General Purpose Event 0 Enables Register (GPE0_EN) | PMBase + 2Ch | 8 | 0 |
| NEWCENTURY_STS | TCO1 Status Register (TCO1_STS) | TCOBase + 04h | 7 | 0 |
| Intruder Detect (INTRD_DET) | TCO2 Status Register (TCO2_STS) | TCOBase + 06h | 0 | 0 |
| Top Swap (TS) | Backed Up Control Register (BUC) | Chipset Config Registers: Offset 3414h | 0 | X |



Using a GPI to Clear CMOS

A jumper on a GPI can also be used to clear CMOS values. BIOS would detect the setting of this GPI on system boot-up, and manually clear the CMOS array.

Note: The GPI strap technique to clear CMOS requires multiple steps to implement. The system is booted with the jumper in new position, then powered back down. The jumper is replaced back to the normal position, then the system is rebooted again.

Warning: Do not implement a jumper on VccRTC to clear CMOS.

5.12 Processor Interface (D31:F0)

The ICH10 interfaces to the processor with a variety of signals

- Standard Outputs to processor: A20M#, SMI#, NMI, INIT#, INTR, STPCLK#, IGNNE#, CPUPWRGD, DPSP#
- Standard Input from processor: FERR#, THRMTRIP#

Most ICH10 outputs to the processor use standard buffers. The ICH10 has separate V_{CPU_IO} signals that are pulled up at the system level to the processor voltage, and thus determines VOH for the outputs to the processor.

5.12.1 Processor Interface Signals

This section describes each of the signals that interface between the ICH10 and the processor(s). Note that the behavior of some signals may vary during processor reset, as the signals are used for frequency strapping.

5.12.1.1 A20M# (Mask A20)

The A20M# signal is active (low) when both of the following conditions are true:

- The ALT_A20_GATE bit (Bit 1 of PORT92 register) is a 0
- The A20GATE input signal is a 0

The A20GATE input signal is expected to be generated by the external microcontroller (KBC).



5.12.1.2 INIT# (Initialization)

The INIT# signal is active (driven low) based on any one of several events described in Table 5-22. When any of these events occur, INIT# is driven low for 16 PCI clocks, then driven high.

Note: The 16-clock counter for INIT# assertion halts while STPCLK# is active. Therefore, if INIT# is supposed to go active while STPCLK# is asserted, it actually goes active after STPCLK# goes inactive.

This section refers to INIT#, but applies to two signals: INIT# and INIT3_3V#, as INIT3_3V# is functionally identical to INIT#, but signaling at 3.3 V.

Table 5-22. INIT# Going Active

| Cause of INIT# Going Active | Comment |
|----------------------------------------------------------------------------------------------------|------------------------------------------------------------------------------------------------------------------------------------------------------------------------------------------------------------------------------------------------------------------------------------------------------------------------------------------------------|
| Shutdown special cycle from processor observed on ICH-(G)MCH interconnect (from (G)MCH). | INIT# assertion based on value of Shutdown Policy Select register (SPS) |
| PORT92 write, where INIT_NOW (bit 0) transitions from 0-to-1. | |
| PORTCF9 write, where SYS_RST (bit 1) was a 0 and RST_CPU (bit 2) transitions from 0-to-1. | |
| RCIN# input signal goes low. RCIN# is expected to be driven by the external microcontroller (KBC). | 0-to-1 transition on RCIN# must occur before the Intel® ICH10 will arm INIT# to be generated again. NOTE: RCIN# signal is expected to be low during S3, S4, and S5 states. Transition on the RCIN# signal in those states (or the transition to those states) may not necessarily cause the INIT# signal to be generated to the processor. |
| CPU BIST | To enter BIST, software sets CPU_BIST_EN bit and then does a full processor reset using the CF9 register. |

5.12.1.3 FERR#/IGNNE# (Numeric Coprocessor Error/ Ignore Numeric Error)

The ICH10 supports the coprocessor error function with the FERR#/IGNNE# pins. The function is enabled via the COPROC_ERR_EN bit (Chipset Config Registers: Offset 31FFh: bit 1 for Consumer Family and Offset 31FEh: bit 9 for Corporate family). FERR# is tied directly to the Coprocessor Error signal of the processor. If FERR# is driven active by the processor, IRQ13 goes active (internally). When it detects a write to the COPROC_ERR register (I/O Register F0h), the ICH10 negates the internal IRQ13 and drives IGNNE# active. IGNNE# remains active until FERR# is driven inactive. IGNNE# is never driven active unless FERR# is active.

Figure 5-5. Coprocessor Error Timing Diagram

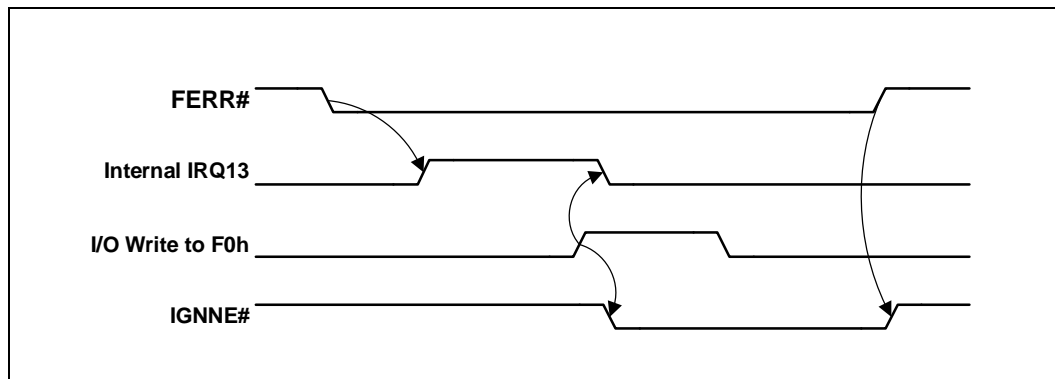

If COPROC_ERR_EN is not set, the assertion of FERR# will not generate an internal IRQ13, nor will the write to F0h generate IGNNE#.

5.12.1.4 NMI (Non-Maskable Interrupt)

Non-Maskable Interrupts (NMIs) can be generated by several sources, as described in Table 5-23.

Table 5-23. NMI Sources

| Cause of NMI | Comment |
|------------------------------------------------------------------------------------------------|----------------------------------------------------------------------------------------------------------------------|
| SERR# goes active (either internally, externally via SERR# signal, or via message from (G)MCH) | Can instead be routed to generate an SCI, through the NMI2SCI_EN bit (Device 31:Function 0, TCO Base + 08h, bit 11). |
| IOCHK# goes active via SERIRQ# stream (ISA system Error) | Can instead be routed to generate an SCI, through the NMI2SCI_EN bit (Device 31:Function 0, TCO Base + 08h, bit 11). |

5.12.1.5 Stop Clock Request (STPCLK#)

The ICH10 power management logic controls this active-low signal. Refer to Section 5.13 for more information on the functionality of this signal.

5.12.1.6 CPU Power Good (CPUPWRGD)

This signal is connected to the processor's PWRGOOD input. This signal represents a logical AND of the ICH10's PWROK and VRMPWRGD signals.

5.12.1.7 Deeper Sleep (DPSLP#)

This active-low signal controls the internal gating of the processor's core clock. This signal asserts before and deasserts after the STP_CPU# signal to effectively stop the processor's clock (internally) in the states in which STP_CPU# can be used to stop the processor's clock externally.



5.12.2 Dual-Processor Issues

5.12.2.1 Signal Differences

In dual-processor designs, some of the processor signals are unused or used differently than for uniprocessor designs.

Table 5-24. DP Signal Differences

| Signal | Difference |
|-----------------|----------------------------------------------------------------------------------------------------------------------------------------------------------------------------------|
| A20M# / A20GATE | Generally not used, but still supported by Intel® ICH10. |
| STPCLK# | Used for S1 State as well as preparation for entry to S3–S5 Also allows for THRM# based throttling (not via ACPI control methods). Should be connected to both processors. |
| FERR# / IGNNE# | Generally not used, but still supported by ICH10. |

5.12.2.2 Power Management

For multiple-processor (or Multiple-core) configurations in which more than one Stop Grant cycle may be generated, the (G)MCH is expected to count Stop Grant cycles and only pass the last one through to the ICH10. This prevents the ICH10 from getting out of sync with the processor on multiple STPCLK# assertions.

Because the S1 state will have the STPCLK# signal active, the STPCLK# signal can be connected to both processors. However, for ACPI implementations, the BIOS must indicate that the ICH10 only supports the C1 state for dual-processor designs.

In going to the S1 state, multiple Stop-Grant cycles will be generated by the processors. It is assumed that prior to setting the SLP_EN bit (which causes the transition to the S1 state), the processors will not be executing code that is likely to delay the Stop-Grant cycles.

In going to the S3, S4, or S5 states, the system will appear to pass through the S1 state; thus, STPCLK# and SLP# are also used. During the S3, S4, and S5 states, both processors will lose power. Upon exit from those states, the processors will have their power restored.

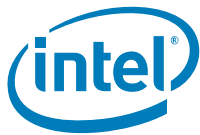

5.13 Power Management (D31:F0)

5.13.1 Features

- Support for *Advanced Configuration and Power Interface, Version 3.0a (ACPI)* providing power and thermal management
 - ACPI 24-Bit Timer
 - Software initiated throttling of processor performance for Thermal and Power Reduction
 - Hardware Override to throttle processor performance if system too hot
 - SCI and SMI# Generation
 - ACPI C2 state Stop-Grant state (using STPCLK# signal) halts processor's instruction stream
- PCI PME# signal for Wake Up from Low-Power states
- System Clock Control
 - ACPI C3 State: Ability to halt processor clock (but not memory clock)
 - ACPI C4 State: Ability to lower processor voltage.
- System Sleep State Control
 - ACPI S1 state: Stop Grant (using STPCLK# signal) halts processor's instruction stream (only STPCLK# active)
 - ACPI S3 state — Suspend to RAM (STR)
 - ACPI S4 state — Suspend-to-Disk (STD)
 - ACPI G2/S5 state — Soft Off (SOFF)
 - Power Failure Detection and Recovery
- Intel Management Engine Power Management Support
 - New Wake events from the Intel Management Engine (enabled from all S-States including Catastrophic S5 conditions)
- Streamlined Legacy Power Management for APM-Based Systems

5.13.2 Intel® ICH10 and System Power States

Table 5-25 shows the power states defined for ICH10-based platforms. The state names generally match the corresponding ACPI states.



Table 5-25. General Power States for Systems Using Intel® ICH10

| State/ Substates | Legacy Name / Description |
|---------------------|--------------------------------------------------------------------------------------------------------------------------------------------------------------------------------------------------------------------------------------------------------------------------------------------------------------------------------------------------------------------------------------------------------------------------------------------------------------------------------------------------------------------------------------------------------------------------|
| G0/S0/C0 | Full On: Processor operating. Individual devices may be shut down to save power. The different processor operating levels are defined by Cx states, as shown in Table 5-26. Within the C0 state, the Intel® ICH10 can throttle the processor using the STPCLK# signal to reduce power consumption. The throttling can be initiated by software or by the operating system or BIOS. |
| G0/S0/C1 | Auto-Halt: Processor has executed an AutoHalt instruction and is not executing code. The processor snoops the bus and maintains cache coherency. |
| G0/S0/C2 | Stop-Grant: The STPCLK# signal goes active to the processor. The processor performs a Stop-Grant cycle, halts its instruction stream, and remains in that state until the STPCLK# signal goes inactive. In the Stop-Grant state, the processor snoops the bus and maintains cache coherency. |
| G0/S0/C3 | Stop-Clock: The STPCLK# signal goes active to the processor. The processor performs a Stop-Grant cycle, halts its instruction stream. ICH10 then asserts DPSP# followed by STP_CPU#, which forces the clock generator to stop the processor clock. Accesses to memory (by graphics, PCI, or internal units) is not permitted while in a C3 state. |
| G0/S0/C4 | Stop-Clock with Lower Processor Voltage: This closely resembles the G0/S0/C3 state. However, after the ICH10 has asserted STP_CPU#, it then lowers the voltage to the processor. This reduces the leakage on the processor. Prior to exiting the C4 state, the ICH10 increases the voltage to the processor. |
| G1/S1 | Stop-Grant: Similar to G0/S0/C2 state. Note: The behavior for this state is slightly different when supporting Intel 64 processors. |
| G1/S3 | Suspend-To-RAM (STR): The system context is maintained in system DRAM, but power is shut off to non-critical circuits. Memory is retained, and refreshes continue. All clocks stop except RTC clock. |
| G1/S4 | Suspend-To-Disk (STD): The context of the system is maintained on the disk. All power is then shut off to the system except for the logic required to resume. |
| G2/S5 | Soft Off (SOFF): System context is not maintained. All power is shut off except for the logic required to restart. A full boot is required when waking. |
| G3 | Mechanical Off (MOFF): System context not maintained. All power is shut off except for the RTC. No "Wake" events are possible, because the system does not have any power. This state occurs if the user removes the batteries, turns off a mechanical switch, or if the system power supply is at a level that is insufficient to power the "waking" logic. When system power returns, transition will depend on the state just prior to the entry to G3 and the AFTERG3 bit in the GEN_PMC3 register (D31:F0, offset A4). Refer to Table 5-33 for more details. |

Table 5-26 shows the transitions rules among the various states. Note that transitions among the various states may appear to temporarily transition through intermediate states. For example, in going from S0 to S1, it may appear to pass through the G0/S0 states. These intermediate transitions and states are not listed in the table.



Table 5-26. State Transition Rules for Intel® ICH10

| Present State | Transition Trigger | Next State |
|------------------------|---------------------------------------------------------------------------------------------------------------------------------------------------------------------------------------------------------------------------------------------|---------------------------------------------------------------------------------------------------------------------------------------------------------------------------------------------------------------------------------------------------------------------------------|
| G0/S0/C0 | <ul style="list-style-type: none"> Processor halt instruction Level 2 Read Level 3 Read Level 4 Read SLP_EN bit set Power Button Override Mechanical Off/Power Failure | <ul style="list-style-type: none"> G0/S0/C1 G0/S0/C2 G0/S0/C3 or G0/S0/C4 - depending on C4onC3_EN bit (D31:F0: Offset A0h: bit 7) and BM_STS_ZERO_EN bit (D31:F0: Offset A9h: bit 2) G1/Sx or G2/S5 state G2/S5 G3 |
| G0/S0/C1 | <ul style="list-style-type: none"> Any Enabled Break Event STPCLK# goes active Power Button Override Power Failure | <ul style="list-style-type: none"> G0/S0/C0 G0/S0/C2 G2/S5 G3 |
| G0/S0/C2 | <ul style="list-style-type: none"> Any Enabled Break Event Power Button Override Power Failure Previously in C3/C4 and bus masters idle | <ul style="list-style-type: none"> G0/S0/C0 G2/S5 G3 C3 or C4 - depending on PDME bit (D31:F0: Offset A9h: bit 4) |
| G0/S0/C3 | <ul style="list-style-type: none"> Any Enabled Break Event Any Bus Master Event Power Button Override Power Failure Previously in C4 and bus masters idle | <ul style="list-style-type: none"> G0/S0/C0 G0/S0/C2 - if PUME bit (D31:F0: Offset A9h: bit 3) is set, else G0/S0/C0 G2/S5 G3 C4 - depending on PDME bit (D31:F0: Offset A9h: bit 4) |
| G0/S0/C4 | <ul style="list-style-type: none"> Any Enabled Break Event Any Bus Master Event Power Button Override Power Failure | <ul style="list-style-type: none"> G0/S0/C0 G0/S0/C2 - if PUME bit (D31:F0: Offset A9h: bit 3) is set, else G0/S0/C0 G2/S5 G3 |
| G1/S1, G1/S3, or G1/S4 | <ul style="list-style-type: none"> Any Enabled Wake Event Power Button Override Power Failure | <ul style="list-style-type: none"> G0/S0/C0 G2/S5 G3 |
| G2/S5 | <ul style="list-style-type: none"> Any Enabled Wake Event Power Failure | <ul style="list-style-type: none"> G0/S0/C0 G3 |
| G3 | <ul style="list-style-type: none"> Power Returns | <ul style="list-style-type: none"> Optional to go to S0/C0 (reboot) or G2/S5 (stay off until power button pressed or other wake event). (See Note 1) |

NOTES:

- Some wake events can be preserved through power failure.



5.13.3 System Power Planes

The system has several independent power planes, as described in [Table 5-27](#). Note that when a particular power plane is shut off, it should go to a 0 V level.

Table 5-27. System Power Plane

| Plane | Controlled By | Description |
|-----------------|----------------------------------|---------------------------------------------------------------------------------------------------------------------------------------------------------------------------------------------------------------------------------------------------------------------------------------------------------------------------------------------------------------------------------------------------------------------------------------------------------------------------|
| CPU | SLP_S3# signal | The SLP_S3# signal can be used to cut the power to the processor completely. The DPRSLPVR support allows lowering the processor's voltage during the C4 state. |
| MAIN | SLP_S3# signal | When SLP_S3# goes active, power can be shut off to any circuit not required to wake the system from the S3 state. Since the S3 state requires that the memory context be preserved, power must be retained to the main memory. The processor, devices on the PCI bus, LPC I/F, and graphics will typically be shut off when the Main power plane is shut, although there may be small subsections powered. |
| MEMORY | SLP_S4# signal SLP_S5# signal | When the SLP_S4# goes active, power can be shut off to any circuit not required to wake the system from the S4. Since the memory context does not need to be preserved in the S4 state, the power to the memory can also be shut down. When SLP_S5# goes active, power can be shut to any circuit not required to wake the system from the S5 state. Since the memory context does not need to be preserved in the S5 state, the power to the memory can also be shut. |
| Link Controller | SLP_M# | This pin is asserted when the manageability platform goes to MOff. Depending on the platform, this pin may be used to control the (G)MCH, ICH controller link power planes, the clock chip power, and the SPI flash power. |
| DEVICE[n] | GPIO | Individual subsystems may have their own power plane. For example, GPIO signals may be used to control the power to disk drives, audio amplifiers, or the display screen. |

5.13.4 SMI #/SCI Generation

On any SMI# event taking place, ICH10 asserts SMI# to the processor, which causes it to enter SMM space. SMI# remains active until the EOS bit is set. When the EOS bit is set, SMI# goes inactive for a minimum of 4 PCI clocks. If another SMI event occurs, SMI# is driven active again.

The SCI is a level-mode interrupt that is typically handled by an ACPI-aware operating system. In non-APIC systems (which is the default), the SCI IRQ is routed to one of the 8259 interrupts (IRQ 9, 10, or 11). The 8259 interrupt controller must be programmed to level mode for that interrupt.

In systems using the APIC, the SCI can be routed to interrupts 9, 10, 11, 20, 21, 22, or 23. The interrupt polarity changes depending on whether it is on an interrupt shareable with a PIRQ or not (see [Section 13.1.3](#)). The interrupt remains asserted until all SCI sources are removed.

[Table 5-28](#) shows which events can cause an SMI# and SCI. Note that some events can be programmed to cause either an SMI# or SCI. The usage of the event for SCI (instead of SMI#) is typically associated with an ACPI-based system. Each SMI# or SCI source has a corresponding enable and status bit.



Table 5-28. Causes of SMI # and SCI (Sheet 1 of 2)

| Cause | SCI | SMI | Additional Enables | Where Reported |
|-------------------------------------------------------------|-----|-----|----------------------------------------------------------------|------------------------|
| PME# | Yes | Yes | PME_EN=1 | PME_STS |
| PME_B0 (Internal, Bus 0, PME-Capable Agents) | Yes | Yes | PME_B0_EN=1 | PME_B0_STS |
| PCI Express* PME Messages | Yes | Yes | PCI_EXP_EN=1 (Not enabled for SMI) | PCI_EXP_STS |
| PCI Express Hot Plug Message | Yes | Yes | HOT_PLUG_EN=1 (Not enabled for SMI) | HOT_PLUG_STS |
| Power Button Press | Yes | Yes | PWRBTN_EN=1 | PWRBTN_STS |
| Power Button Override (Note 7) | Yes | No | None | PRBTNOR_STS |
| RTC Alarm | Yes | Yes | RTC_EN=1 | RTC_STS |
| Ring Indicate | Yes | Yes | RI_EN=1 | RI_STS |
| USB#1 wakes | Yes | Yes | USB1_EN=1 | USB1_STS |
| USB#2 wakes | Yes | Yes | USB2_EN=1 | USB2_STS |
| USB#3 wakes | Yes | Yes | USB3_EN=1 | USB3_STS |
| USB#4 wakes | Yes | Yes | USB4_EN=1 | USB4_STS |
| USB#5 wakes | Yes | Yes | USB5_EN=1 | USB5_STS |
| USB#6 wakes | Yes | Yes | USB6_EN=1 | USB6_STS |
| THRM# pin active | Yes | Yes | THRM_EN=1 | THRM_STS |
| ACPI Timer overflow (2.34 sec.) | Yes | Yes | TMROF_EN=1 | TMROF_STS |
| Any GPI | Yes | Yes | GPI[x]_Route=10 (SCI) GPI[x]_Route=01 (SMI) GPE0[x]_EN=1 | GPI[x]_STS GPE0_STS |
| TCO SCI Logic | Yes | No | TCOSCI_EN=1 | TCOSCI_STS |
| TCO SCI message from (G)MCH | Yes | No | none | MCHSCI_STS |
| TCO SMI Logic | No | Yes | TCO_EN=1 | TCO_STS |
| TCO SMI — Year 2000 Rollover | No | Yes | none | NEWCENTURY_STS |
| TCO SMI — TCO TIMEROUT | No | Yes | none | TIMEOUT |
| TCO SMI — OS writes to TCO_DAT_IN register | No | Yes | none | OS_TCO_SMI |
| TCO SMI — Message from (G)MCH | No | Yes | none | MCHSMI_STS |
| TCO SMI — NMI occurred (and NMIs mapped to SMI) | No | Yes | NMI2SMI_EN=1 | NMI2SMI_STS |
| TCO SMI — INTRUDER# signal goes active | No | Yes | INTRD_SEL=10 | INTRD_DET |
| TCO SMI ⁸ — Change of the BIOSWP bit from 0 to 1 | No | Yes | BC.LE=1 | BIOSWR_STS |

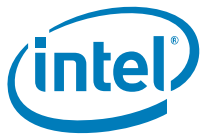

Table 5-28. Causes of SMI# and SCI (Sheet 2 of 2)

| Cause | SCI | SMI | Additional Enables | Where Reported |
|-------------------------------------------------------|-----|-----|---------------------------------------------|----------------------------------|
| TCO SMI — Write attempted to BIOS | No | Yes | BIOSWP=1 | BIOSWR_STS |
| BIOS_RLS written to | Yes | No | GBL_EN=1 | GBL_STS |
| GBL_RLS written to | No | Yes | BIOS_EN=1 | BIOS_STS |
| Write to B2h register | No | Yes | APMC_EN = 1 | APM_STS |
| Periodic timer expires | No | Yes | PERIODIC_EN=1 | PERIODIC_STS |
| 64 ms timer expires | No | Yes | SWSMI_TMR_EN=1 | SWSMI_TMR_STS |
| Enhanced USB Legacy Support Event | No | Yes | LEGACY_USB2_EN = 1 | LEGACY_USB2_STS |
| Enhanced USB Intel Specific Event | No | Yes | INTEL_USB2_EN = 1 | INTEL_USB2_STS |
| UHCI USB Legacy logic | No | Yes | LEGACY_USB_EN=1 | LEGACY_USB_STS |
| Serial IRQ SMI reported | No | Yes | none | SERIRQ_SMI_STS |
| Device monitors match address in its range | No | Yes | none | DEVTRAP_STS |
| SMBus Host Controller | No | Yes | SMB_SMI_EN Host Controller Enabled | SMBus host status reg. |
| SMBus Slave SMI message | No | Yes | none | SMBUS_SMI_STS |
| SMBus SMBALERT# signal active | No | Yes | none | SMBUS_SMI_STS |
| SMBus Host Notify message received | No | Yes | HOST_NOTIFY_INTREN | SMBUS_SMI_STS HOST_NOTIFY_STS |
| Access microcontroller 62h/66h | No | Yes | MCSMI_EN | MCSMI_STS |
| SLP_EN bit written to 1 | No | Yes | SMI_ON_SLP_EN=1 | SMI_ON_SLP_EN_STS |
| USB Per-Port Registers Write Enable bit changes to 1. | No | Yes | USB2_EN=1, Write_Enable_SMI_En able=1 | USB2_STS, Write Enable Status |
| Write attempted to BIOS | No | Yes | BIOSWPD = 0 | BIOSWR_STS |
| GPIO Lockdown Enable bit changes from '1' to '0'. | No | Yes | GPIO_UNLOCK_SMI_EN=1 | GPIO_UNLOCK_SMI_STS |

NOTES:

1. SCI_EN must be 1 to enable SCI. SCI_EN must be 0 to enable SMI.
2. SCI can be routed to cause interrupt 9:11 or 20:23 (20:23 only available in APIC mode).
3. GBL_SMI_EN must be 1 to enable SMI.
4. EOS must be written to 1 to re-enable SMI for the next 1.
5. ICH10 must have SMI# fully enabled when ICH10 is also enabled to trap cycles. If SMI# is not enabled in conjunction with the trap enabling, then hardware behavior is undefined.
6. Only GPI[15:0] may generate an SMI# or SCI.
7. When a power button override first occurs, the system will transition immediately to S5. The SCI will only occur after the next wake to S0 if the residual status bit (PRBTNOR_STS) is not cleared prior to setting SCI_EN.
8. This SMI is a synchronous event.



PCI Express ports and the (G)MCH (via DMI) have the ability to cause PME using messages. When a PME message is received, ICH10 will set the PCI_EXP_STS bit. If the PCI_EXP_EN bit is also set, the ICH10 can cause an SCI via the GPE1_STS register.

PCI Express has a Hot-Plug mechanism and is capable of generating a SCI via the GPE1 register. It is also capable of generating an SMI. However, it is not capable of generating a wake event.

5.13.5 Dynamic Processor Clock Control

The ICH10 has extensive control for dynamically starting and stopping system clocks. The clock control is used for transitions among the various S0/Cx states, and processor throttling. Each dynamic clock control method is described in this section. The various sleep states may also perform types of non-dynamic clock control.

The ICH10 supports the ACPI C0, C1, C2, C3, and C4 states.

The Dynamic Processor Clock control is handled using the following signals:

- STPCLK#: Used to halt processor instruction stream.
- STP_CPU#: Used to stop processor's clock
- DPSLP#: Used to force Deeper Sleep for processor.
- DPRSLPVR: Used to lower voltage of VRM during C4 state.
- DPRSTP#: Used to alert the processor of C4 state. Also works in conjunction with DPRSLPVR to communicate to the VRM whether a slow or fast voltage ramp should be used.

The C1 state is entered based on the processor performing an auto halt instruction.

The C2 state is entered based on the processor reading the Level 2 register in the ICH10.

The C2 state can also be entered from C3 or C4 states if bus masters require snoops and the PUME bit (D31:F0: Offset A9h: bit 3) is set.

The C3 state is entered based on the processor reading the Level 3 register in the ICH10 and when the C4onC3_EN bit is clear (D31:F0: Offset A0: bit 7). This state can also be entered after a temporary return to C2 from a prior C3 or C4 state.

The C4 state is entered based on the processor reading the Level 4 register in the ICH10, or by reading the Level 3 register when the C4onC3_EN bit is set. This state can also be entered after a temporary return to C2 from a prior C4 state.

A C1, C2, C3, or C4 state ends due to a Break event. Based on the break event, the ICH10 returns the system to C0 state.

Table 5-29 lists the possible break events from C2, C3, or C4. The break events from C1 are indicated in the processor's datasheet.



Table 5-29. Break Events

| Event | Breaks from | Comment |
|----------------------------------------------------------------------------------------------------------------------------|-------------|---------------------------------------------------------------------------------------------------------------------------------------------------------------------------------------------------------------------------------|
| Any unmasked interrupt goes active | C2 | IRQ[0:15] when using the 8259s, IRQ[0:23] for I/O APIC. Since SCI is an interrupt, any SCI will also be a break event. |
| Any internal event that cause an NMI or SMI# | C2 | Many possible sources |
| Any internal event that cause INIT# to go active | C2 | Could be indicated by the keyboard controller via the RCIN input signal. |
| Any bus master request (internal, external or DMA, or BMBUSY#) goes active and BM_RLD=1 (D31:F0: Offset PMBASE+04h: bit 1) | C3, C4 | Need to wake up processor so it can do snoops Note: If the PUME bit (D31:F0: Offset A9h: bit 3) is set, then bus master activity will NOT be treated as a break event. Instead, there will be a return only to the C2 state. |
| Processor Pending Break Event Indication | C2 | Only available if FERR# enabled for break event indication (See FERR# Mux Enable in GCS, Chipset Config Registers: Offset 3410h: bit 6) |
| REQ-C0 Message from (G)MCH | C2 | Can be sent at any time after the Ack-C2 message and before the Ack-C0 message, when not in C0 state. |

5.13.5.1 Slow C4 Exit

In order to eliminate the audible noise caused by aggressive voltage ramps when exiting C4 the states at a regular, periodic frequency, the ICH10 supports a method to slow down the voltage ramp at the processor VR for certain break events. If enabled for this behavior, the ICH10 treats IRQ0 and IRQ8 as “slow” break events since both of these can be the system timer tick interrupt. Rather than carefully tracking the interrupt and timer configuration information to track the one correct interrupt, it was deemed acceptable to simplify the logic and slow the break exit sequence for both interrupts. Other break event sources invoke the normal exit timings.

The ICH10 indicates that a slow voltage ramp is desired by deasserting DPRSTP# (high) and leaving DPRSLPVR asserted (high). The normal voltage ramp rate is communicated by deasserting DPRSTP# (high) and deasserting DPRSLPVR (low).

The ICH10 waits an additional delay before starting the normal voltage ramp timer during the C4 or C5 exit sequence. If a “fast” break event occurs during the additional, slow-Exit time delay, the ICH10 quickly deasserts DPRSLPVR (low), thereby speeding up the voltage ramp and reducing the delay to a value that is typically seen by the device in the past. In the event that a fast break event and a slow break event occur together, the fast flow is taken.

5.13.5.2 Transition Rules among S0/Cx and Throttling States

The following priority rules and assumptions apply among the various S0/Cx and throttling states:

- Entry to any S0/Cx state is mutually exclusive with entry to any S1–S5 state. This is because the processor can only perform one register access at a time and Sleep states have higher priority than thermal throttling.
- When the SLP_EN bit is set (system going to a S1 - S5 sleep state), the THTL_EN and FORCE_THTL bits can be internally treated as being disabled (no throttling while going to sleep state).
- If the THTL_EN or FORCE_THTL bits are set, and a Level 2, Level 3 or Level 4 read then occurs, the system should immediately go and stay in a C2, C3 or C4 state until a break event occurs. A Level 2, Level 3 or Level 4 read has higher priority than the software initiated throttling.
- After an exit from a C2, C3 or C4 state (due to a Break event), and if the THTL_EN or FORCE_THTL bits are still set the system will continue to throttle STPCLK#. Depending on the time of break event, the first transition on STPCLK# active can be delayed by up to one THRM period (1024 PCI clocks = 30.72 μ s).
- The Host controller must post Stop-Grant cycles in such a way that the processor gets an indication of the end of the special cycle prior to the ICH10 observing the Stop-Grant cycle. This ensures that the STPCLK# signals stays active for a sufficient period after the processor observes the response phase.
- If in the C1 state and the STPCLK# signal goes active, the processor will generate a Stop-Grant cycle, and the system should go to the C2 state. When STPCLK# goes inactive, it should return to the C1 state.

5.13.5.3 Deferred C3/C4

Due to the new DMI protocol, if there is any bus master activity (other than true isochronous), then the C0 to C3 transition will pause at the C2 state. ICH10 will keep the processor in a C2 state until:

- ICH10 sees no bus master activity.
- A break event occurs. In this case, the ICH10 will perform the C2 to C0 sequence. Note that bus master traffic is not a break event in this case.

To take advantage of the Deferred C3/C4 mode, the BM_STS_ZERO_EN bit must be set. This will cause the BM_STS bit to read as 0 even if some bus master activity is present. If this is not done, then the software may avoid even attempting to go to the C3 or C4 state if it sees the BM_STS bit as 1.

If the PUME bit (D31:F0: Offset A9h: bit 3) is 0, then the ICH10 will treat bus master activity as a break event. When reaching the C2 state, if there is any bus master activity, the ICH10 will return the processor to a C0 state.

5.13.5.4 POPUP (Auto C3/C4 to C2)

When the PUME bit (D31:F0: Offset A9h: bit 3) is set, the ICH10 enables a mode of operation where standard (non-isochronous) bus master activity will not be treated as a full break event from the C3 or C4 states. Instead, these will be treated merely as bus master events and return the platform to a C2 state, and thus allow snoops to be performed.

After returning to the C2 state, the bus master cycles will be sent to the (G)MCH, even if the ARB_DIS bit is set.



5.13.5.5 POPDOWN (Auto C2 to C3/C4)

After returning to the C2 state from C3/C4, if the PDME bit (D31:F0: Offset A9h: bit 4) is set, the platform can return to a C3 or C4 state (depending on where it was prior to going back up to C2). This behaves similar to the Deferred C3/C4 transition, and will keep the processor in a C2 state until:

- Bus masters are no longer active.
- A break event occurs. Note: Bus master traffic is not a break event in this case.

5.13.6 Sleep States

5.13.6.1 Sleep State Overview

The ICH10 directly supports different sleep states (S1–S5), which are entered by setting the SLP_EN bit, or due to a Power Button press. The entry to the Sleep states is based on several assumptions:

- Entry to a Cx state is mutually exclusive with entry to a Sleep state. This is because the processor can only perform one register access at a time. A request to Sleep always has higher priority than throttling.
- Prior to setting the SLP_EN bit, the software turns off processor-controlled throttling. Note that thermal throttling cannot be disabled, but setting the SLP_EN bit disables thermal throttling (since S1–S5 sleep state has higher priority).
- The G3 state cannot be entered via any software mechanism. The G3 state indicates a complete loss of power.

5.13.6.2 Initiating Sleep State

Sleep states (S1–S5) are initiated by:

- Masking interrupts, turning off all bus master enable bits, setting the desired type in the SLP_TYP field, and then setting the SLP_EN bit. The hardware then attempts to gracefully put the system into the corresponding Sleep state.
- Pressing the PWRBTN# Signal for more than 4 seconds to cause a Power Button Override event. In this case the transition to the S5 state is less graceful, since there are no dependencies on observing Stop-Grant cycles from the processor or on clocks other than the RTC clock.
- Assertion of the THRMTRIP# signal will cause a transition to the S5 state. This can occur when system is in S0 or S1 state.

Table 5-30. Sleep Types

| Sleep Type | Comment |
|------------|---------------------------------------------------------------------------------------------------------------------------------------------------------------------------------------------|
| S1 | Intel ICH10 asserts the STPCLK# signal. This lowers the processor's power consumption. No snooping is possible in this state. |
| S3 | ICH10 asserts SLP_S3#. The SLP_S3# signal controls the power to non-critical circuits. Power is only retained to devices needed to wake from this sleeping state, as well as to the memory. |
| S4 | ICH10 asserts SLP_S3# and SLP_S4#. The SLP_S4# signal shuts off the power to the memory subsystem. Only devices needed to wake from this state should be powered. |
| S5 | Same power state as S4. ICH10 asserts SLP_S3#, SLP_S4# and SLP_S5#. |

5.13.6.3 Exiting Sleep States

Sleep states (S1–S5) are exited based on Wake events. The Wake events forces the system to a full on state (S0), although some non-critical subsystems might still be shut off and have to be brought back manually. For example, the hard disk may be shut off during a sleep state, and have to be enabled via a GPIO pin before it can be used.

Upon exit from the ICH10-controlled Sleep states, the WAK_STS bit is set. The possible causes of Wake Events (and their restrictions) are shown in [Table 5-31](#).

Table 5-31. Causes of Wake Events

| Cause | States Can Wake From | How Enabled |
|------------------------------------|----------------------|----------------------------------------------------------------------------------------------------------------------------------------------------------------------------------|
| RTC Alarm | S1–S5 (Note 1) | Set RTC_EN bit in PM1_EN register |
| Power Button | S1–S5 | Always enabled as Wake event. (Note 2). |
| GPI[0:15] | S1–S5 (Note 1) | GPE0_EN register NOTE: GPIs that are in the core well are not capable of waking the system from sleep states when the core well is not powered. |
| Classic USB | S1–S4 | Set USB1_EN, USB 2_EN, USB3_EN, USB4_EN, USB5_EN, and USB6_EN bits in GPE0_EN register |
| LAN | S1–S5 | Will use PME#. Wake enable set with LAN logic. |
| RI# | S1–S5 (Note 1) | Set RI_EN bit in GPE0_EN register |
| Intel® High Definition Audio | S1–S5 | Event sets PME_B0_STS bit; PM_B0_EN must be enabled. Can not wake from S5 state if it was entered due to power failure or power button override. |
| Primary PME# | S1–S5 (Note 1) | PME_B0_EN bit in GPE0_EN register |
| Secondary PME# | S1–S5 | Set PME_EN bit in GPE0_EN register. |
| PCI_EXP_WAKE# | S1–S5 | PCI_EXP_WAKE bit (Note 3) |
| SATA | S1 | Set PME_EN bit in GPE0_EN register. (Note 4) |
| PCI_EXP PME Message | S1 | Must use the PCI Express* WAKE# pin rather than messages for wake from S3,S4, or S5. |
| SMBALERT# | S1–S5 | Always enabled as Wake event |
| SMBus Slave Wake Message (01h) | S1–S5 | Wake/SMI# command always enabled as a Wake event. NOTE: SMBus Slave Message can wake the system from S1–S5, as well as from S5 due to Power Button Override. (Note 2). |
| SMBus Host Notify message received | S1–S5 | HOST_NOTIFY_WKEN bit SMBus Slave Command register. Reported in the SMB_WAK_STS bit in the GPE0_STS register. |
| ME Non-Maskable Wake | S1–S5 | Always enabled as Wake event. (Note 2). |

NOTES:

- This is a wake event from S5 only if the sleep state was entered by setting the SLP_EN and SLP_TYP bits via software, or if there is a power failure.
- If in the S5 state due to a power button override or THRMTRIP#, the possible wake events are due to Power Button, Hard Reset Without Cycling (See Command Type 3 in [Table 5-53](#)), Hard Reset System (See Command Type 4 in [Table 5-53](#)), Wake SMBus Slave Message (01h), and ME initiated non-maskable wake.



3. When the WAKE# pin is active and the PCI Express device is enabled to wake the system, the ICH10 will wake the platform.
4. SATA can only trigger a wake event in S1, but if PME is asserted prior to S3/S4/S5 entry and software does not clear the PME_BO_STS, a wake event would still result.

It is important to understand that the various GPIs have different levels of functionality when used as wake events. The GPIs that reside in the core power well can only generate wake events from sleep states where the core well is powered. Also, only certain GPIs are "ACPI Compliant," meaning that their Status and Enable bits reside in ACPI I/O space. Table 5-32 summarizes the use of GPIs as wake events.

Table 5-32. GPI Wake Events

| GPI | Power Well | Wake From | Notes |
|-----------|------------|-----------|----------------|
| GPI[7:0] | Core | S1 | ACPI Compliant |
| GPI[15:8] | Suspend | S1–S5 | ACPI Compliant |

The latency to exit the various Sleep states varies greatly and is heavily dependent on power supply design, so much so that the exit latencies due to the ICH10 are insignificant.

5.13.6.4 PCI Express * WAKE# Signal and PME Event Message

PCI Express ports can wake the platform from any sleep state (S1, S3, S4, or S5) using the WAKE# pin. WAKE# is treated as a wake event, but does not cause any bits to go active in the GPE_STS register.

PCI Express ports and the (G)MCH (via DMI) have the ability to cause PME using messages. When a PME message is received, ICH10 will set the PCI_EXP_STS bit.

5.13.6.5 Sx-G3-Sx, Handling Power Failures

Depending on when the power failure occurs and how the system is designed, different transitions could occur due to a power failure.

The AFTER_G3 bit provides the ability to program whether or not the system should boot once power returns after a power loss event. If the policy is to not boot, the system remains in an S5 state (unless previously in S4). There are only three possible events that will wake the system after a power failure.

1. **PWRBTN#:** PWRBTN# is always enabled as a wake event. When RSMRST# is low (G3 state), the PWRBTN_STS bit is reset. When the ICH10 exits G3 after power returns (RSMRST# goes high), the PWRBTN# signal is already high (because V_{CC}-standby goes high before RSMRST# goes high) and the PWRBTN_STS bit is 0.
2. **RI #:** RI# does not have an internal pull-up. Therefore, if this signal is enabled as a wake event, it is important to keep this signal powered during the power loss event. If this signal goes low (active), when power returns the RI_STS bit is set and the system interprets that as a wake event.
3. **RTC Alarm:** The RTC_EN bit is in the RTC well and is preserved after a power loss. Like PWRBTN_STS the RTC_STS bit is cleared when RSMRST# goes low.

The ICH10 monitors both PWROK and RSMRST# to detect for power failures. If PWROK goes low, the PWROK_FLR bit is set. If RSMRST# goes low, PWR_FLR is set.

Note: Although PME_EN is in the RTC well, this signal cannot wake the system after a power loss. PME_EN is cleared by RTCRST#, and PME_STS is cleared by RSMRST#.



Table 5-33. Transitions Due to Power Failure

| State at Power Failure | AFTERG3_EN bit | Transition When Power Returns |
|------------------------|----------------|-------------------------------|
| S0, S1, S3 | 1 | S5 |
| | 0 | S0 |
| S4 | 1 | S4 |
| | 0 | S0 |
| S5 | 1 | S5 |
| | 0 | S0 |

5.13.7 Thermal Management

The ICH10 has mechanisms to assist with managing thermal problems in the system.

5.13.7.1 THRM# Signal

The THRM# signal is used as a status input for a thermal sensor. Based on the THRM# signal going active, the ICH10 generates an SMI# or SCI (depending on SCI_EN).

If the THRM_POL bit is set low, when the THRM# signal goes low, the THRM_STS bit will be set. This is an indicator that the thermal threshold has been exceeded. If the THRM_EN bit is set, then when THRM_STS goes active, either an SMI# or SCI will be generated (depending on the SCI_EN bit being set).

The power management software (BIOS or ACPI) can then take measures to start reducing the temperature. Examples include shutting off unwanted subsystems, or halting the processor.

By setting the THRM_POL bit to high, another SMI# or SCI can optionally be generated when the THRM# signal goes back high. This allows the software (BIOS or ACPI) to turn off the cooling methods.

Note: THRM# assertion does not cause a TCO event message in S3 or S4. The level of the signal is not reported in the heartbeat message.

5.13.7.2 Software Initiated Passive Cooling

This mode is initiated by software setting the THTL_EN or FORCE_THTL bits.

Software sets the THTL_DTY or THRM_DTY bits to select throttle ratio and THTL_EN or FORCE_THTL bit to enable the throttling.

Throttling results in STPCLK# active for a minimum time of 12.5% and a maximum of 87.5%. The period is 1024 PCI clocks. Thus, the STPCLK# signal can be active for as little as 128 PCI clocks or as much as 896 PCI clocks. The actual slowdown (and cooling) of the processor depends on the instruction stream, because the processor is allowed to finish the current instruction. Furthermore, the ICH10 waits for the STOP-GRANT cycle before starting the count of the time the STPCLK# signal is active.



5.13.7.3 THRM# Override Software Bit

The FORCE_THTL bit allows the BIOS to force passive cooling, independent of the ACPI software (which uses the THTL_EN and THTL_DTY bits). If this bit is set, the ICH10 starts throttling using the ratio in the THRM_DTY field.

When this bit is cleared the ICH10 stops throttling, unless the THTL_EN bit is set (indicating that ACPI software is attempting throttling).

If both the THTL_EN and FORCE_THTL bits are set, then the ICH should use the duty cycle defined by the THRM_DTY field, not the THTL_DTY field.

5.13.7.4 Active Cooling

Active cooling involves fans. The GPIO signals from the ICH10 can be used to turn on/off a fan.

5.13.8 Event Input Signals and Their Usage

The ICH10 has various input signals that trigger specific events. This section describes those signals and how they should be used.

5.13.8.1 PWRBTN# (Power Button)

The ICH10 PWRBTN# signal operates as a “Fixed Power Button” as described in the *Advanced Configuration and Power Interface, Version 2.0b*. PWRBTN# signal has a 16 ms de-bounce on the input. The state transition descriptions are included in [Table 5-34](#). Note that the transitions start as soon as the PWRBTN# is pressed (but after the debounce logic), and does not depend on when the Power Button is released.

Note: During the time that the SLP_S4# signal is stretched for the minimum assertion width (if enabled), the Power Button is not a wake event. Refer to Power Button Override Function section below for further detail.

Table 5-34. Transitions Due to Power Button

| Present State | Event | Transition/Action | Comment |
|---------------|-----------------------------------------------------|---------------------------------------------------------------------------------------|-----------------------------------------------------------------------------|
| S0/Cx | PWRBTN# goes low | SMI# or SCI generated (depending on SCI_EN, PWRBTN_INIT_EN, PWRBTN_EN and GLB_SMI_EN) | Software typically initiates a Sleep state |
| S1–S5 | PWRBTN# goes low | Wake Event. Transitions to S0 state | Standard wakeup |
| G3 | PWRBTN# pressed | None | No effect since no power Not latched nor detected |
| S0–S4 | PWRBTN# held low for at least 4 consecutive seconds | Unconditional transition to S5 state | No dependence on processor (e.g., Stop-Grant cycles) or any other subsystem |



Power Button Override Function (ICH10 Consumer Only)

If PWRBTN# is observed active for at least four consecutive seconds, the state machine unconditionally transitions to the G2/S5 state, regardless of present state (S0-S4), even if PWROK is not active. In this case, the transition to the G2/S5 state does not depend on any particular response from the processor (e.g., a Stop-Grant cycle), nor any similar dependency from any other subsystem. The PWRBTN# status is readable to check if the button is currently being pressed or has been released. The status is taken after the de-bounce, and is readable via the PWRBTN_LVL bit.

Note: The 4-second PWRBTN# assertion should only be used if a system lock-up has occurred.

The 4-second timer starts counting when the ICH10 is in a S0 state. If the PWRBTN# signal is asserted and held active when the system is in a suspend state (S1-S5), the assertion causes a wake event. Once the system has resumed to the S0 state, the 4-second timer starts.

Note: During the time that the SLP_S4# signal is stretched for the minimum assertion width (if enabled by D31:F0:A4h bit 3), the Power Button is not a wake event.

Power Button Override Function (ICH10 Corporate Only)

If PWRBTN# is observed active for at least four consecutive seconds when in S0/S1 or at least nine consecutive seconds when in S3-S4, the state machine unconditionally transitions to the G2/S5 state, even if PWROK is not active. In this case, the transition to the G2/S5 state does not depend on any particular response from the processor (e.g., a Stop-Grant cycle), nor any similar dependency from any other subsystem. The PWRBTN# status is readable to check if the button is currently being pressed or has been released. The status is taken after the de-bounce, and is readable via the PWRBTN_LVL bit.

Note: A 4 to 9 second PWRBTN# assertion should only be used if a system lock-up has occurred.

The power button override timer starts counting when PWRBTN# is asserted and will be set to 4 seconds when the platform is in S0/S1 and 9 seconds when the platform is in S3-S4 in order to trigger a power button override event.

Note: During the time that the SLP_S3#/SLP_S4# signal is stretched for the minimum assertion width (if enabled in D31:F0:A4h), a Power Button is not wake event. For this reason, the ICH10 Corporate will always extend the power button override timer to 9 seconds when in S3/S4 to allow for a wake event that is delayed by SLP_S3#/SLP_S4# stretching to be observed before accidentally triggering a power button override event.

Sleep Button

The *Advanced Configuration and Power Interface, Version 2.0b* defines an optional Sleep button. It differs from the power button in that it only is a request to go from S0 to S1-S4 (not S5). Also, in an S5 state, the Power Button can wake the system, but the Sleep Button cannot.

Although the ICH10 does not include a specific signal designated as a Sleep Button, one of the GPIO signals can be used to create a "Control Method" Sleep Button. See the *Advanced Configuration and Power Interface, Version 2.0b* for implementation details.



5.13.8.2 RI# (Ring Indicator)

The Ring Indicator can cause a wake event (if enabled) from the S1–S5 states.

Table 5-35 shows when the wake event is generated or ignored in different states. If in the G0/S0/Cx states, the ICH10 generates an interrupt based on RI# active, and the interrupt will be set up as a Break event.

Table 5-35. Transitions Due to RI# Signal

| Present State | Event | RI_EN | Event |
|---------------|------------|-------|------------|
| S0 | RI# Active | X | Ignored |
| S1–S5 | RI# Active | 0 | Ignored |
| | | 1 | Wake Event |

Note: Filtering/Debounce on RI# will not be done in ICH10. Can be in modem or external.

5.13.8.3 PME# (PCI Power Management Event)

The PME# signal comes from a PCI device to request that the system be restarted. The PME# signal can generate an SMI#, SCI, or optionally a Wake event. The event occurs when the PME# signal goes from high to low. No event is caused when it goes from low to high.

There is also an internal PME_B0 bit. This is separate from the external PME# signal and can cause the same effect.

5.13.8.4 SYS_RESET# Signal

When the SYS_RESET# pin is detected as active after the 16 ms debounce logic, the ICH10 attempts to perform a “graceful” reset, by waiting up to 25 ms for the SMBus to go idle. If the SMBus is idle when the pin is detected active, the reset occurs immediately; otherwise, the counter starts. If at any point during the count the SMBus goes idle the reset occurs. If, however, the counter expires and the SMBus is still active, a reset is forced upon the system even though activity is still occurring.

Once the reset is asserted, it remains asserted for 5 to 6 ms regardless of whether the SYSRESET# input remains asserted or not. It cannot occur again until SYS_RESET# has been detected inactive after the debounce logic, and the system is back to a full S0 state with PLTRST# inactive. Note that if bit 3 of the CF9h I/O register is set then SYS_RESET# will result in a full power cycle reset.

5.13.8.5 THRMTRIP# Signal

If THRMTRIP# goes active, the processor is indicating an overheat condition, and the ICH10 immediately transitions to an S5 state. However, since the processor has overheated, it does not respond to the ICH10's STPCLK# pin with a stop grant special cycle. Therefore, the ICH10 does not wait for one. Immediately upon seeing THRMTRIP# low, the ICH10 initiates a transition to the S5 state, drive SLP_S3#, SLP_S4#, SLP_S5# low, and set the CTS bit. The transition looks like a power button override.

When a THRMTRIP# event occurs, the ICH10 will power down immediately without following the normal S0 -> S5 path. The ICH10 will immediately drive SLP_S3#, SLP_S4#, and SLP_S5# low after sampling THRMTRIP# active.

If the processor is running extremely hot and is heating up, it is possible (although very unlikely) that components around it, such as the ICH10, are no longer executing cycles properly. Therefore, if THRMTRIP# goes active, and the ICH10 is relying on state machine logic to perform the power down, the state machine may not be working, and the system will not power down.



The ICH provides filtering for short low glitches on the THRMTRIP# signal in order to prevent erroneous system shut downs from noise. Glitches shorter than 25nsec are ignored.

During boot, THRMTRIP# is ignored until SLP_S3#, PWROK, VRMPWRGD/VGATE, and PLTRST# are all '1'. During entry into a powered-down state (due to S3, S4, S5 entry, power cycle reset, etc.) THRMTRIP# is ignored until either SLP_S3# = 0, or PWROK = 0, or VRMPWRGD/VGATE = 0.

Note:

A thermal trip event will:

- Set the AFTERG3_EN bit
- Clear the PWRBTN_STS bit
- Clear all the GPE0_EN register bits
- Clear the SMB_WAK_STS bit only if SMB_SAK_STS was set due to SMBus slave receiving message and not set due to SMBAlert

5.13.8.6 BMBUSY#

The BMBUSY# signal is an input from a graphics component to indicate if it is busy. If prior to going to the C3 state, the BMBUSY# signal is active, then the BM_STS bit will be set. If after going to the C3 state, the BMBUSY# signal goes back active, the ICH10 will treat this as if one of the PCI REQ# signals went active. This is treated as a break event.

5.13.9 ALT Access Mode

Before entering a low power state, several registers from powered down parts may need to be saved. In the majority of cases, this is not an issue, as registers have read and write paths. However, several of the ISA compatible registers are either read only or write only. To get data out of write-only registers, and to restore data into read-only registers, the ICH10 implements an ALT access mode.

If the ALT access mode is entered and exited after reading the registers of the ICH10 timer (8254), the timer starts counting faster (13.5 ms). The following steps listed below can cause problems:

1. BIOS enters ALT access mode for reading the ICH10 timer related registers.
2. BIOS exits ALT access mode.
3. BIOS continues through the execution of other needed steps and passes control to the operating system.

After getting control in step #3, if the operating system does not reprogram the system timer again, the timer ticks may be happening faster than expected. For example DOS and its associated software assume that the system timer is running at 54.6 ms and as a result the time-outs in the software may be happening faster than expected.

Operating systems (e.g., Microsoft Windows* 98, Windows* 2000, and Windows NT*) reprogram the system timer and therefore do not encounter this problem.

For some other operating systems (e.g., Microsoft MS-DOS*) the BIOS should restore the timer back to 54.6 ms before passing control to the operating system. If the BIOS is entering ALT access mode before entering the suspend state it is not necessary to restore the timer contents after the exit from ALT access mode.



5.13.9.1 Write Only Registers with Read Paths in ALT Access Mode

The registers described in Table 5-36 have read paths in ALT access mode. The access number field in the table indicates which register will be returned per access to that port.

Table 5-36. Write Only Registers with Read Paths in ALT Access Mode (Sheet 1 of 2)

| Restore Data | | | | Restore Data | | | |
|--------------|----------|--------|-----------------------------------|--------------|----------|----------------------------------------------|--------------------------------------|
| I/O Addr | # of Rds | Access | Data | I/O Addr | # of Rds | Access | Data |
| 00h | 2 | 1 | DMA Chan 0 base address low byte | 40h | 7 | 1 | Timer Counter 0 status, bits [5:0] |
| | | 2 | DMA Chan 0 base address high byte | | | 2 | Timer Counter 0 base count low byte |
| 01h | 2 | 1 | DMA Chan 0 base count low byte | | | 3 | Timer Counter 0 base count high byte |
| | | 2 | DMA Chan 0 base count high byte | | | 4 | Timer Counter 1 base count low byte |
| 02h | 2 | 1 | DMA Chan 1 base address low byte | | | 5 | Timer Counter 1 base count high byte |
| | | 2 | DMA Chan 1 base address high byte | | | 6 | Timer Counter 2 base count low byte |
| 03h | 2 | 1 | DMA Chan 1 base count low byte | | | 7 | Timer Counter 2 base count high byte |
| | | 2 | DMA Chan 1 base count high byte | 41h | 1 | Timer Counter 1 status, bits [5:0] | |
| 04h | 2 | 1 | DMA Chan 2 base address low byte | 42h | 1 | Timer Counter 2 status, bits [5:0] | |
| | | 2 | DMA Chan 2 base address high byte | 70h | 1 | Bit 7 = NMI Enable, Bits [6:0] = RTC Address | |
| 05h | 2 | 1 | DMA Chan 2 base count low byte | C4h | 2 | 1 | DMA Chan 5 base address low byte |
| | | 2 | DMA Chan 2 base count high byte | | | 2 | DMA Chan 5 base address high byte |
| 06h | 2 | 1 | DMA Chan 3 base address low byte | C6h | 2 | 1 | DMA Chan 5 base count low byte |
| | | 2 | DMA Chan 3 base address high byte | | | 2 | DMA Chan 5 base count high byte |
| 07h | 2 | 1 | DMA Chan 3 base count low byte | C8h | 2 | 1 | DMA Chan 6 base address low byte |
| | | 2 | DMA Chan 3 base count high byte | | | 2 | DMA Chan 6 base address high byte |



Table 5-36. Write Only Registers with Read Paths in ALT Access Mode (Sheet 2 of 2)

| Restore Data | | | | Restore Data | | | | |
|--------------|----------|--------|--------------------------------------------|--------------|----------|--------|-----------------------------------|--|
| I/O Addr | # of Rds | Access | Data | I/O Addr | # of Rds | Access | Data | |
| 08h | 6 | 1 | DMA Chan 0–3 Command ² | CAh | 2 | 1 | DMA Chan 6 base count low byte | |
| | | 2 | DMA Chan 0–3 Request | | | 2 | DMA Chan 6 base count high byte | |
| | | 3 | DMA Chan 0 Mode: Bits(1:0) = 00 | CCh | 2 | 1 | DMA Chan 7 base address low byte | |
| | | 4 | DMA Chan 1 Mode: Bits(1:0) = 01 | | | 2 | DMA Chan 7 base address high byte | |
| | | 5 | DMA Chan 2 Mode: Bits(1:0) = 10 | CEh | 2 | 1 | DMA Chan 7 base count low byte | |
| | | 6 | DMA Chan 3 Mode: Bits(1:0) = 11. | | | 2 | DMA Chan 7 base count high byte | |
| 20h | 12 | 1 | PIC ICW2 of Master controller | D0h | 6 | 1 | DMA Chan 4–7 Command ² | |
| | | 2 | PIC ICW3 of Master controller | | | 2 | DMA Chan 4–7 Request | |
| | | 3 | PIC ICW4 of Master controller | | | 3 | DMA Chan 4 Mode: Bits(1:0) = 00 | |
| | | 4 | PIC OCW1 of Master controller ¹ | | | 4 | DMA Chan 5 Mode: Bits(1:0) = 01 | |
| | | 5 | PIC OCW2 of Master controller | | | 5 | DMA Chan 6 Mode: Bits(1:0) = 10 | |
| | | 6 | PIC OCW3 of Master controller | | | 6 | DMA Chan 7 Mode: Bits(1:0) = 11. | |
| | | 7 | PIC ICW2 of Slave controller | | | | | |
| | | 8 | PIC ICW3 of Slave controller | | | | | |
| | | 9 | PIC ICW4 of Slave controller | | | | | |
| | | 10 | PIC OCW1 of Slave controller ¹ | | | | | |
| | | 11 | PIC OCW2 of Slave controller | | | | | |
| | | 12 | PIC OCW3 of Slave controller | | | | | |

NOTES:

1. The OCW1 register must be read before entering ALT access mode.
2. Bits 5, 3, 1, and 0 return 0.



5.13.9.2 PIC Reserved Bits

Many bits within the PIC are reserved, and must have certain values written in order for the PIC to operate properly. Therefore, there is no need to return these values in ALT access mode. When reading PIC registers from 20h and A0h, the reserved bits shall return the values listed in [Table 5-37](#).

Table 5-37. PIC Reserved Bits Return Values

| PIC Reserved Bits | Value Returned |
|-------------------|----------------|
| ICW2(2:0) | 000 |
| ICW4(7:5) | 000 |
| ICW4(3:2) | 00 |
| ICW4(0) | 0 |
| OCW2(4:3) | 00 |
| OCW3(7) | 0 |
| OCW3(5) | Reflects bit 6 |
| OCW3(4:3) | 01 |

5.13.9.3 Read Only Registers with Write Paths in ALT Access Mode

The registers described in [Table 5-38](#) have write paths to them in ALT access mode. Software restores these values after returning from a powered down state. These registers must be handled special by software. When in normal mode, writing to the base address/count register also writes to the current address/count register. Therefore, the base address/count must be written first, then the part is put into ALT access mode and the current address/count register is written.

Table 5-38. Register Write Accesses in ALT Access Mode

| I/O Address | Register Write Value |
|-------------|---------------------------------------|
| 08h | DMA Status Register for channels 0–3. |
| D0h | DMA Status Register for channels 4–7. |



5.13.10 System Power Supplies, Planes, and Signals

5.13.10.1 Power Plane Control with SLP_S3#, SLP_S4#, SLP_S5# and SLP_M#

The SLP_S3# output signal can be used to cut power to the system core supply, since it only goes active for the Suspend-to-RAM state (typically mapped to ACPI S3). Power must be maintained to the ICH10 suspend well, and to any other circuits that need to generate Wake signals from the Suspend-to-RAM state. During S3 (Suspend-to-RAM) all signals attached to powered down plans will be tri-stated or driven low, unless they are pulled via a pull-up resistor.

Cutting power to the core may be done via the power supply, or by external FETs on the motherboard.

The SLP_S4# or SLP_S5# output signal can be used to cut power to the system core supply, as well as power to the system memory, since the context of the system is saved on the disk. Cutting power to the memory may be done via the power supply, or by external FETs on the motherboard.

The SLP_S4# output signal is used to remove power to additional subsystems that are powered during SLP_S3#.

SLP_S5# output signal can be used to cut power to the system core supply, as well as power to the system memory, since the context of the system is saved on the disk. Cutting power to the memory may be done via the power supply, or by external FETs on the motherboard.

SLP_M# output signal can be used to cut power to the Controller Link, Clock chip and SPI flash on a platform that supports Intel AMT.

5.13.10.2 SLP_S4# and Suspend-To-RAM Sequencing

The system memory suspend voltage regulator is controlled by the Glue logic. The SLP_S4# signal should be used to remove power to system memory rather than the SLP_S5# signal. The SLP_S4# logic in the ICH10 provides a mechanism to fully cycle the power to the DRAM and/or detect if the power is not cycled for a minimum time.

Note: To use the minimum DRAM power-down feature that is enabled by the SLP_S4# Assertion Stretch Enable bit (D31:F0:A4h bit 3), the DRAM power must be controlled by the SLP_S4# signal.



5.13.10.3 PWROK Signal

The PWROK input should go active based on the core supply voltages becoming valid. PWROK should go active no sooner than 99 ms after Vcc3_3 and Vcc1_5 have reached their nominal values. PWROK must not glitch, even if RSMRST# is low.

Note:

1. SYSRESET# is recommended for implementing the system reset button. This saves external logic that is needed if the PWROK input is used. Additionally, it allows for better handling of the SMBus and processor resets, and avoids improperly reporting power failures.
2. PWROK and RSMRST# are sampled using the RTC clock. Therefore, low times that are less than one RTC clock period may not be detected by the ICH10.
3. In the case of true PWROK failure, PWROK will go low before VRMPWRGD.
4. When PWROK goes inactive, a host power cycle reset will occur. A host power cycle is the assertion of SLP_S3#, SLP_S4#, and SLP_S5#, and the deassertion of these signals 3-5 seconds later. The Intel Management Engine remains powered throughout this cycle.

5.13.10.4 CPUPWRGD Signal

This signal is connected to the processor's VRM via the VRMPWRGD signal and is internally AND'd with the PWROK signal that comes from the system power supply.

5.13.10.5 VRMPWRGD Signal

VRMPWRGD is an input from the regulator indicating that all of the outputs from the regulator are on and within specification. Platforms that use the VRMPWRGD signal to start the clock chip PLLs assume that it asserts milliseconds before PWROK in order to provide valid clocks in time for the PWROK rising.

Note:

When VRMPWRGD goes inactive, a host power cycle reset will occur. A host power cycle is the assertion of SLP_S3#, SLP_S4#, and SLP_S5#, and the deassertion of these signals 3-5 seconds later. The Intel Management Engine remains powered throughout this cycle.

5.13.10.6 DRAMPWROK Signal (Corporate Only)

The DRAMPWROK output is sent to the (G)MCH as an indication of when DRAM power is turned off. The (G)MCH uses this information as one of the conditions for asserting the DDR3 Reset signal.

The ICH10's open-drain buffer pulls the signal low when SLP_S4# is asserted and CLPWROK deasserted.



5.13.11 Clock Generators

The clock generator is expected to provide the frequencies shown in Table 5-39.

Table 5-39. Intel® ICH10 Clock Inputs

| Clock Domain | Frequency | Source | Usage |
|--------------|-------------------------|----------------------------|--------------------------------------------------------------------------------------------------------------------|
| SATA_CLK | 100 MHz Differential | Main Clock Generator | Used by SATA controller. Stopped in S3 – S based on SLP_S3# assertion. |
| DMI_CLK | 100 MHz Differential | Main Clock Generator | Used by DMI and PCI Express*. Stopped in S3 – S5 based on SLP_S3# assertion. |
| PCICLK | 33 MHz | Main Clock Generator | Free-running PCI Clock to ICH10. Stopped in S3 – S5 based on SLP_S3# assertion. |
| CLK48 | 48.000 MHz | Main Clock Generator | Used by USB controllers and Intel High Definition Audio controller. Stopped in S3 – S5 based on SLP_S3# assertion. |
| CLK14 | 14.318 MHz | Main Clock Generator | Used by ACPI timers. Stopped in S3 – S5 based on SLP_S3# assertion. |
| GLAN_CLK | 5 to 62.5 MHz | Platform LAN Connect | LAN Connect Interface and Gigabit LAN Connect Interface. Control policy is determined by the clock source. |

5.13.11.1 Clock Control Signals from Intel® ICH10 to Clock Synthesizer

The clock generator is assumed to have direct connect from the following ICH10 signals:

- STP_CPU#: Stops processor clocks in C3 and C4 states
- STP_PCI#: Stops system PCI clocks (not the ICH10 free-running 33 MHz clock) due to CLKRUN# protocol
- SLP_S3#: Expected to drive clock chip PWRDOWN (through inverter), to stop clocks in S3 to S5.



5.13.12 Legacy Power Management Theory of Operation

Instead of relying on ACPI software, legacy power management uses BIOS and various hardware mechanisms. The scheme relies on the concept of detecting when individual subsystems are idle, detecting when the whole system is idle, and detecting when accesses are attempted to idle subsystems.

However, the operating system is assumed to be at least APM enabled. Without APM calls, there is no quick way to know when the system is idle between keystrokes. The ICH10 does not support burst modes.

5.13.12.1 APM Power Management

The ICH10 has a timer that, when enabled by the 1MIN_EN bit in the SMI Control and Enable register, generates an SMI# once per minute. The SMI handler can check for system activity by reading the DEVACT_STS register. If none of the system bits are set, the SMI handler can increment a software counter. When the counter reaches a sufficient number of consecutive minutes with no activity, the SMI handler can then put the system into a lower power state.

If there is activity, various bits in the DEVACT_STS register will be set. Software clears the bits by writing a 1 to the bit position.

The DEVACT_STS register allows for monitoring various internal devices, or Super I/O devices (SP, PP, FDC) on LPC or PCI, keyboard controller accesses, or audio functions on LPC or PCI. Other PCI activity can be monitored by checking the PCI interrupts.

5.13.13 Reset Behavior

When a reset is triggered, the ICH10 will send a warning message to the (G)MCH to allow the (G)MCH to attempt to complete any outstanding memory cycles and put memory into a safe state before the platform is reset. When the (G)MCH is ready, it will send an acknowledge message to the ICH10. Once the message is received the ICH10 asserts PLTRST#.

The ICH10 does not require an acknowledge message from the (G)MCH to trigger PLTRST#. A global reset will occur after 4 seconds if an acknowledge from the (G)MCH is not received.

Note: When the ICH10 causes a reset by asserting PLTRST# its output signals will go to their reset states as defined in [Chapter 3](#).

A reset in which the host platform is reset and PLTRST# is asserted is called a Host Reset or Host Partition Reset. Depending on the trigger a host reset may also result in power cycling see [Chapter 5-40](#) for details. If a host reset is triggered and the ICH10 times out before receiving an acknowledge message from the (G)MCH a Global Reset with power cycle will occur. A reset in which the host and ME partitions of the platform are reset is called a Global Reset.

Table 5-40 shows the various reset triggers.

Table 5-40. Causes of Host and Global Resets

| Trigger | Host Reset without Power Cycle | Host Reset with Power Cycle | Global Reset with Power Cycle |
|----------------------------------------------------------------------------------------|--------------------------------|-----------------------------|-------------------------------|
| Write of 0Eh to CF9h Register when Global Reset bit = 0b (D31:F0:ACH:20) | No | Yes | No (Note 1) |
| Write of 06h to CF9h Register when Global Reset bit = 0b | Yes | No | No (Note 1) |
| Write of 06h or 0Eh to CF9h register when Global Reset bit = 1b | No | No | Yes |
| SYS_RESET# Asserted and CF9h bit 3 = 0 | Yes | No | No (Note 1) |
| SYS_RESET# Asserted and CF9h bit 3 = 1 | No | Yes | No (Note 1) |
| SMBus Slave Message received for Reset with Power Cycle | No | Yes | No (Note 1) |
| SMBus Slave Message received for Reset without Power Cycle | Yes | No | No (Note 1) |
| TCO Watchdog timer reaches zero two times | Yes | No | No (Note 1) |
| Power Failure: PWROK signal or VRMPWRGD signal goes inactive or RSMRST# asserts | No | No | Yes (Note 2) |
| Special shutdown cycle from CPU causes CF9h-like PLTRST# and CF9h Global Reset bit = 1 | No | No | Yes |
| Special shutdown cycle from CPU causes CF9h-like PLTRST# and CF9h bit 3 = 1 | No | Yes | No (Note 2) |
| Special Shutdown Cycle from CPU causes CF9h-like PLTRST# and CF9h Global Reset bit = 0 | Yes | No | No (Note 1) |
| Intel® Management Engine Triggered Host Reset without power cycle | Yes | No | No (Note 1) |
| Intel Management Engine Triggered Host Reset with power cycle | No | Yes | No (Note 1) |
| Intel Management Engine Triggered Global Reset | No | No | Yes |
| Intel Management Engine Initiated Host Reset with power down | No | Yes (Note 3) | No (Note 1) |
| Intel Management Engine Watchdog Timer | No | Yes (Note 4) | No (Note 1) |
| Power Management Watchdog Timer | No | Yes (Note 4) | No (note 1) |

NOTES:

1. Trigger will result in Global Reset with power cycle if the acknowledge message is not received by the ICH10.
2. ICH10 does not send warning message to (G)MCH, reset occurs without delay.
3. ICH10 waits for enabled wake event to complete reset.
4. System stays in S5 state.



5.14 System Management (D31:F0)

The ICH10 provides various functions to make a system easier to manage and to lower the Total Cost of Ownership (TCO) of the system. In addition, ICH10 provides integrated ASF Management support, requires use of SPI Flash and Intel Management Engine firmware. Features and functions can be augmented via external A/D converters and GPIO, as well as an external microcontroller.

The following features and functions are supported by the ICH10:

- Processor present detection
 - Detects if processor fails to fetch the first instruction after reset
- Various Error detection (such as ECC Errors) indicated by host controller
 - Can generate SMI#, SCI, SERR, NMI, or TCO interrupt
- Intruder Detect input
 - Can generate TCO interrupt or SMI# when the system cover is removed
 - INTRUDER# allowed to go active in any power state, including G3
- Detection of bad BIOS Flash (FWH or Flash on SPI) programming
 - Detects if data on first read is FFh (indicates that BIOS flash is not programmed)
- Ability to hide a PCI device
 - Allows software to hide a PCI device in terms of configuration space through the use of a device hide register (See [Section 10.1.75](#))

Note: Voltage ID from the processor can be read via GPI signals. ASF functionality with the integrated ICH10 ASF controller requires a correctly configured system, including an appropriate SKU of the ICH10 (see [Section 1.3](#)), (G)MCH with Intel Management Engine, Intel Management Engine Firmware, system BIOS support, and appropriate Platform LAN Connect Device.

5.14.1 Theory of Operation

The System Management functions are designed to allow the system to diagnose failing subsystems. The intent of this logic is that some of the system management functionality can be provided without the aid of an external microcontroller.

5.14.1.1 Detecting a System Lockup

When the processor is reset, it is expected to fetch its first instruction. If the processor fails to fetch the first instruction after reset, the TCO timer times out twice and the ICH10 asserts PLTRST#.



5.14.1.2 Handling an Intruder

The ICH10 has an input signal, INTRUDER#, that can be attached to a switch that is activated by the system's case being open. This input has a two RTC clock debounce. If INTRUDER# goes active (after the debouncer), this will set the INTRD_DET bit in the TCO_STS register. The INTRD_SEL bits in the TCO_CNT register can enable the ICH10 to cause an SMI# or interrupt. The BIOS or interrupt handler can then cause a transition to the S5 state by writing to the SLP_EN bit.

The software can also directly read the status of the INTRUDER# signal (high or low) by clearing and then reading the INTRD_DET bit. This allows the signal to be used as a GPI if the intruder function is not required.

If the INTRUDER# signal goes inactive some point after the INTRD_DET bit is written as a 1, then the INTRD_DET signal will go to a 0 when INTRUDER# input signal goes inactive. Note that this is slightly different than a classic sticky bit, since most sticky bits would remain active indefinitely when the signal goes active and would immediately go inactive when a 1 is written to the bit.

Note: The INTRD_DET bit resides in the ICH10's RTC well, and is set and cleared synchronously with the RTC clock. Thus, when software attempts to clear INTRD_DET (by writing a 1 to the bit location) there may be as much as two RTC clocks (about 65 μ s) delay before the bit is actually cleared. Also, the INTRUDER# signal should be asserted for a minimum of 1 ms to ensure that the INTRD_DET bit will be set.

Note: If the INTRUDER# signal is still active when software attempts to clear the INTRD_DET bit, the bit remains set and the SMI is generated again immediately. The SMI handler can clear the INTRD_SEL bits to avoid further SMIs. However, if the INTRUDER# signal goes inactive and then active again, there will not be further SMIs, since the INTRD_SEL bits would select that no SMI# be generated.

5.14.1.3 Detecting Improper Firmware Hub Programming

The ICH10 can detect the case where the BIOS flash is not programmed. This results in the first instruction fetched to have a value of FFh. If this occurs, the ICH10 sets the BAD_BIOS bit. The BIOS flash may reside in FWH or flash on the SPI bus.

5.14.1.4 Heartbeat and Event Reporting via SMLink/SMBus

Heartbeat and event reporting via SMLink/SMBus is no longer supported. The Intel AMT logic in ICH10 can be programmed to generate an interrupt to the Intel Management Engine when an event occurs. The Intel Management Engine will poll the TCO registers to gather appropriate bits to send the event message to the Gigabit Ethernet controller, if Intel Management Engine is programmed to do so.

The Intel Management Engine is responsible for sending ASF 2.0 messages if programmed to do so.

In Advanced TCO BMC mode, the external micro-controller (BMC) accesses the TCO info through SMBus.



5.14.2 TCO Modes

5.14.2.1 TCO Legacy/Compatible Mode

In TCO Legacy/Compatible mode the Intel Management Engine and Intel AMT logic and SMBus controllers are disabled. To enable Legacy/Compatible TCO mode the TCOMODE bit 7 in the ICHSTRP0 register in the SPI device must be 0.

Note: SMBus and SMLink may be tied together externally, if a device has a single SMBus interface and needs access to the TCO slave and be visible to the host SMBus controller.

Figure 5-6. TCO Legacy/Compatible Mode SMBus Configuration

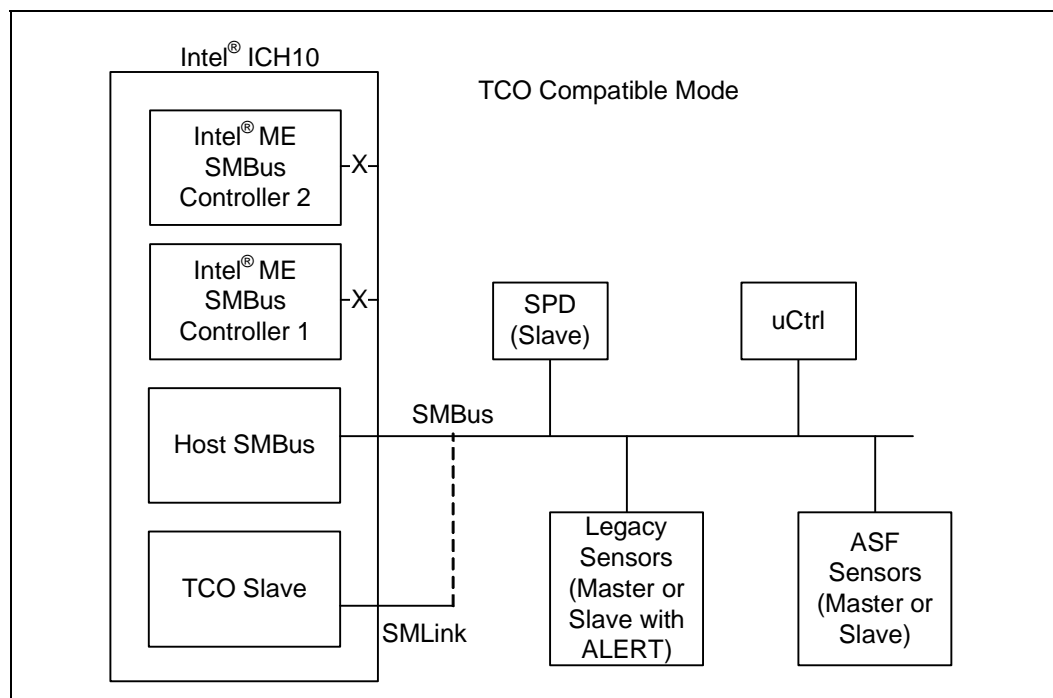



In TCO Legacy/Compatible mode the Intel ICH10 can function directly with the integrated Gigabit Ethernet controller or equivalent external LAN controller to report messages to a network management console without the aid of the system processor. This is crucial in cases where the processor is malfunctioning or cannot function due to being in a low-power state. Table 5-41 includes a list of events that will report messages to the network management console.

Table 5-41. Event Transitions that Cause Messages

| Event | Assertion? | Deassertion? | Comments |
|------------------------|------------|--------------|----------------------------------------------------------------------------------------------------------------------------------------|
| INTRUDER# pin | yes | no | Must be in "S1 or hung S0" state |
| THRM# pin | yes | yes | Must be in "S1 or hung S0" state. Note that the THRM# pin is isolated when the core power is off, thus preventing this event in S3-S5. |
| Watchdog Timer Expired | yes | no (NA) | "S1 or hung S0" state entered |
| GPIO[11]/SMBALERT# pin | yes | yes | Must be in "S1 or hung S0" state |
| BATLOW# | yes | yes | Must be in "S1 or hung S0" state |
| CPU_PWR_FLR | yes | no | "S1 or hung S0" state entered |

NOTE: The GPIO11/SMBALERT#/JTAGTDO pin will trigger an event message (when enabled by the GPIO11_ALERT_DISABLE bit) regardless of whether it is configured as a GPI or not.

5.14.2.2 Advanced TCO Mode

Intel ICH10 supports two modes of Advanced TCO. Intel Manageability Engine (Intel ME) mode and BMC mode. To enable Advance TCO mode (Intel ME or BMC mode) the TCOMODE bit 7 in the ICHSTRP0 register in the SPI device must be 1.

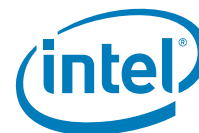

5.14.2.2.1 Advanced TCO Intel® Manageability Engine Mode

In this mode, Intel ME SMBus Controller 1, Host SMBus and SMLink are connected together internally. See Figure 5-7. This mode is enabled when the BMCMODE bit 15 in the ICHSTRP0 register in the SPI device is 0.

The Intel ME SMBus Controller 2 can be connected to either the SMBus pins or the SMLink pins by the MESM2SEL bit 23 in the ICHSTRP0 register in the SPI device. The default is to have the Intel ME SMBus Controller 2 connected to SMLink. The Intel ME SMBus Controller 2 has no connection to LINKALERT#.

Figure 5-7. Advanced TCO Intel® ME SMBus/SMLink Configuration

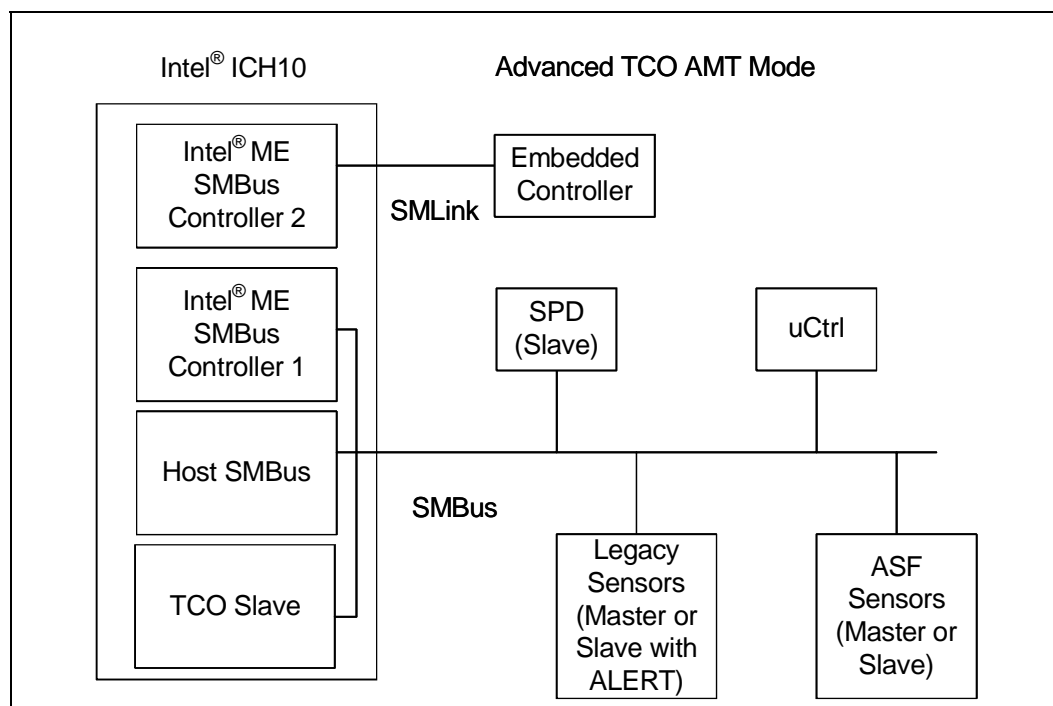

5.14.2.2.2 Advanced TCO BMC Mode

In this mode, the external microcontroller (BMC) is connected to both SMLink and SMBus. The BMC communicates with Intel Management Engine through Intel ME SMBus connected to SMLink. The host and TCO slave communicated with BMC through SMBus. See [Figure 5-8](#). This mode is enabled when the BMCMODE bit 15 in the ICHSTRP0 register in the SPI device is 1.

Figure 5-8. Advanced TCO BMC Mode SMBus/SMLink Configuration

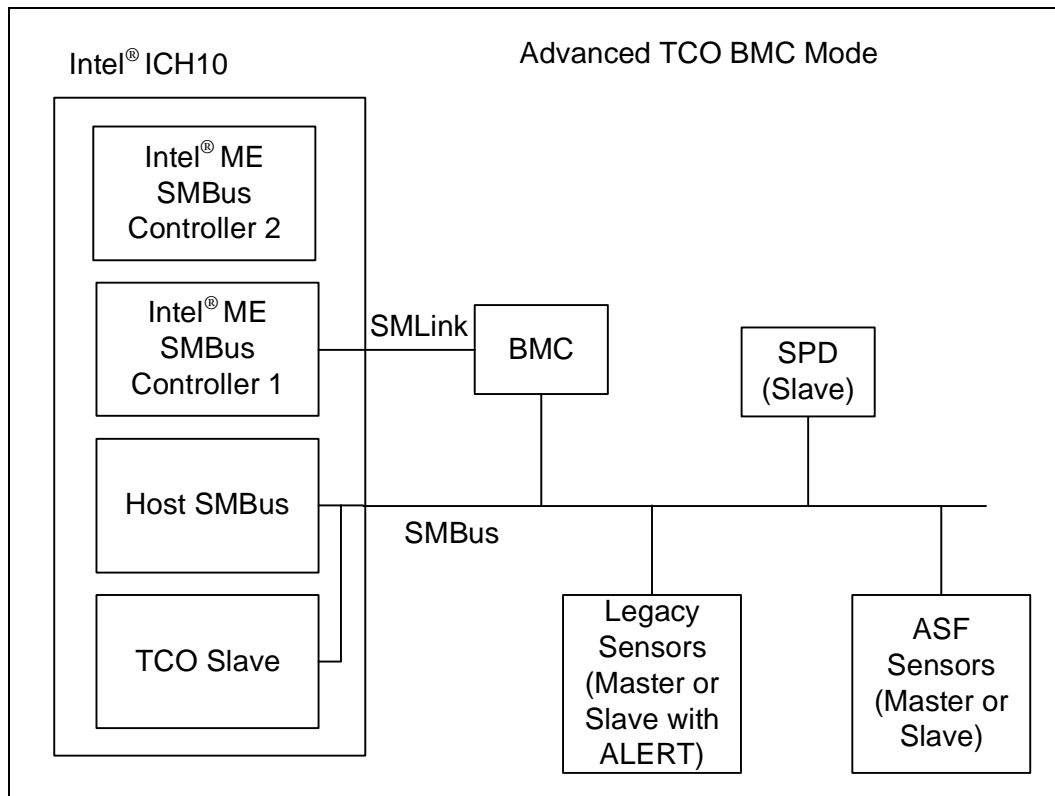



5.15 General Purpose I/O (D31:F0)

The ICH10 contains up to 61 General Purpose Input/Output (GPIO) signals. Each GPIO can be configured as an input or output signal. The number of inputs and outputs varies depending on ICH10 configuration.

5.15.1 Power Wells

Some GPIOs exist in the suspend power plane. Care must be taken to make sure GPIO signals are not driven high into powered-down planes. Some ICH10 GPIOs may be connected to pins on devices that exist in the core well. If these GPIOs are outputs, there is a danger that a loss of core power (PWROK low) or a Power Button Override event results in the ICH10 driving a pin to a logic 1 to another device that is powered down.

5.15.2 SMI# and SCI Routing

The routing bits for GPIO[0:15] allow an input to be routed to SMI# or SCI, or neither. Note that a bit can be routed to either an SMI# or an SCI, but not both.

5.15.3 Triggering

GPIO[1:15] have “sticky” bits on the input. Refer to the GPE0_STS register. As long as the signal goes active for at least 2 clock cycles, the ICH10 keeps the sticky status bit active. The active level can be selected in the GP_LVL register. If the system is in an S0 or an S1 state, the GPI inputs are sampled at 33 MHz, so the signal only needs to be active for about 60 ns to be latched. In the S3–S5 states, the GPI inputs are sampled at 32.768 kHz, and thus must be active for at least 61 microseconds to be latched. If the input signal is still active when the latch is cleared, it will again be set. Another edge trigger is not required. This makes these signals “level” triggered inputs.

5.15.4 GPIO Registers Lockdown

The following GPIO registers are locked down when the GPIO Lockdown Enable (GLE) bit is set. The GLE bit resides in D31:F0:GPIO Control (GC) register.

- Offset 00h: GPIO_USE_SEL
- Offset 04h: GP_IO_SEL
- Offset 0Ch: GP_LVL
- Offset 30h: GPIO_USE_SEL2
- Offset 34h: GPI_IO_SEL2
- Offset 38h: GP_LVL2
- Offset 40h: GPIO_USE_SEL3 (Corporate Only)
- Offset 44h: GPI_IO_SEL3 (Corporate Only)
- Offset 48h: GP_LVL3 (Corporate Only)
- Offset 60h: GP_RST_SEL

Once these registers are locked down, they become Read-Only registers and any software writes to these registers will have no effect. To unlock the registers, the GPIO Lockdown Enable (GLE) bit is required to be cleared to '0'. When the GLE bit changes from a '1' to a '0' a System Management Interrupt (SMI#) is generated if enabled. Once the GPIO_UNLOCK_SMI bit is set, it can not be changed until a PLTRST# occurs.

This ensures that only BIOS can change the GPIO configuration. If the GLE bit is cleared by unauthorized software, BIOS will set the GLE bit again when the SMI# is triggered and these registers will continue to be locked down.

5.15.5 Serial POST Codes Over GPIO

ICH10 adds the extended capability allowing system software to serialize POST or other messages on GPIO. This capability negates the requirement for dedicated diagnostic LEDs on the platform. Additionally, based on the newer BTX form factors, the PCI bus as a target for POST codes is increasingly difficult to support as the total number of PCI devices supported are decreasing.

5.15.5.1 Theory of operation

For the ICH10 generation POST code serialization logic will be shared with GPIO. These GPIOs will likely be shared with LED control offered by the Super I/O (SIO) component. The following reference diagram shows a likely configuration.

Figure 5-9. Serial Post over GPIO Reference Circuit

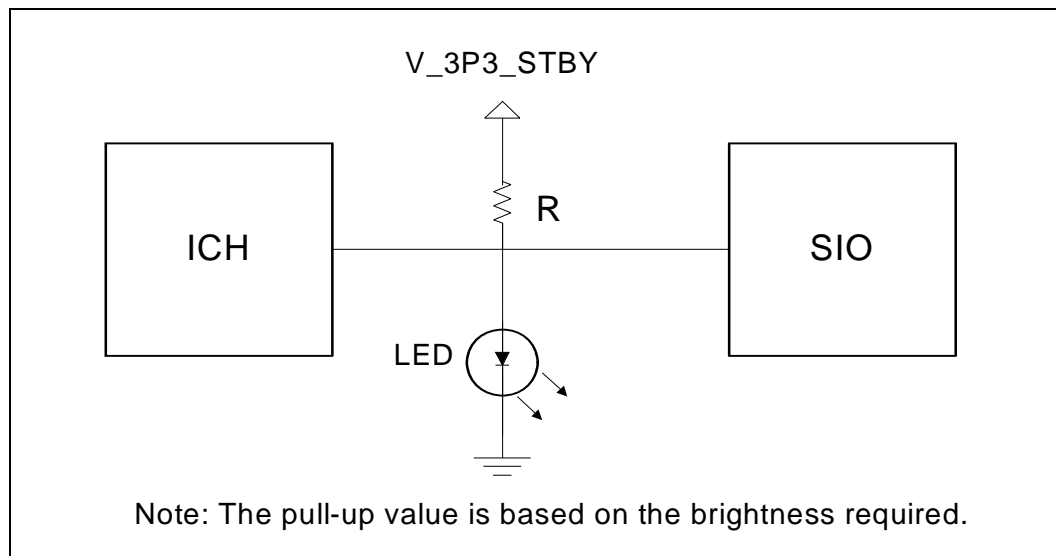

The anticipated usage model is that either the ICH10 or the SIO can drive a pin low to turn off an LED. In the case of the power LED, the SIO would normally leave its corresponding pin in a high-Z state to allow the LED to turn on. In this state, the ICH10 can blink the LED by driving its corresponding pin low and subsequently tri-stating the buffer.

An external optical sensing device can detect the on/off state of the LED. By externally post-processing the information from the optical device, the serial bit stream can be recovered. The hardware will supply a 'sync' byte before the actual data transmission to allow external detection of the transmit frequency. The frequency of transmission should be limited to 1 transition every 1 μ s to ensure the detector can reliably sample the on/off state of the LED. To allow flexibility in pull-up resistor values for power optimization, the frequency of the transmission is programmable via the DRS field in the GP_SB_CMDSTS register (Section 13.10.6).

The serial bit stream is Manchester encoded. This choice of transmission ensures that a transition will be seen on every clock. The 1 or 0 data is based on the transmission happening during the high or low phase of the clock.



A simplified hardware/software register interface provides control and status information to track the activity of this block. Software enabling the serial blink capability should implement an algorithm referenced below to send the serialized message on the enabled GPIO.

1. Read the Go/Busy status bit in the GP_SB_CMDSTS register and verify it is cleared. This will ensure that the GPIO is idled and a previously requested message is still not in progress.
2. Write the data to serialize into the GP_SB_DATA register ([Section 13.10.7](#)).
3. Write the DLS and DRS values into the GP_SB_CMDSTS register and set the Go bit. This may be accomplished using a single write.

The reference diagram shows the LEDs being powered from the suspend supply. By providing a generic capability that can be used both in the main and the suspend power planes maximum flexibility can be achieved. A key point to make is that the ICH will not unintentionally drive the LED control pin low unless a serialization is in progress. System board connections utilizing this serialization capability are required to use the same power plane controlling the LED as the ICH10 GPIO pin. Otherwise, the ICH10 GPIO may float low during the message and prevent the LED from being controlled from the SIO. The hardware will only be serializing messages when the core power well is powered and the processor is operational.

Care should be taken to prevent the ICH10 from driving an active '1' on a pin sharing the serial LED capability. Since the SIO could be driving the line to 0, having the ICH drive a 1 would create a high current path. A recommendation to avoid this condition involves choosing a GPIO defaulting to an input. The GP_SER_BLINK register ([Section 13.10.7](#)) should be set first before changing the direction of the pin to an output. This sequence ensures the open-drain capability of the buffer is properly configured before enabling the pin as an output.

5.15.5.2 Serial Message Format

In order to serialize the data onto the GPIO, an initial state of high-Z is assumed. The SIO is required to have its LED control pin in a high-Z state as well to allow ICH10 to blink the LED (refer to the reference diagram).

The three components of the serial message include the sync, data, and idle fields. The sync field is 7 bits of '1' data followed by 1 bit of '0' data. Starting from the high-Z state (LED on) provides external hardware a known initial condition and a known pattern. In case one or more of the leading 1 sync bits are lost, the 1s followed by 0 provide a clear indication of 'end of sync'. This pattern will be used to 'lock' external sampling logic to the encoded clock.

The data field is shifted out with the highest byte first (MSB). Within each byte, the most significant bit is shifted first (MSb).

The idle field is enforced by the hardware and is at least 2 bit times long. The hardware will not clear the Busy and Go bits until this idle time is met. Supporting the idle time in hardware prevents time-based counting in BIOS as the hardware is immediately ready for the next serial code when the Go bit is cleared. Note that the idle state is represented as a high-Z condition on the pin. If the last transmitted bit is a 1, returning to the idle state will result in a final 0-1 transition on the output Manchester data. Two full bit times of idle correspond to a count of 4 time intervals (the width of the time interval is controlled by the DRS field).

The following waveform shows a 1-byte serial write with a data byte of 5Ah. The internal clock and bit position are for reference purposes only. The Manchester D is the resultant data generated and serialized onto the GPIO. Since the buffer is operating in open-drain mode the transitions are from high-Z to 0 and back.

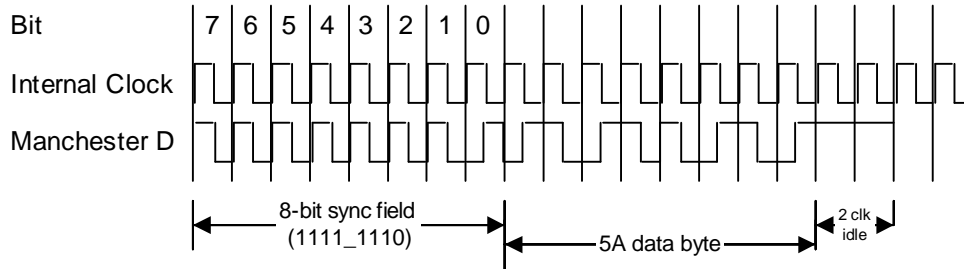

5.15.6 Intel Management Engine GPIOs

The following GPIOs can be used as Controller Link GPIOs: GPIO9/WOL_EN, GPIO10/CPU_MISSING/JTAGTMS (Corporate Only), GPIO24/MEM_LED, and GPIO57/TPM_PP/JTAGTCK (Corporate Only). Controller Link GPIOs are only available on Intel AMT or ASF enabled platforms with supporting Intel Management Engine firmware. Controller Link GPIOs are owned by the Intel Management Engine and are configured by Intel Management Engine firmware. When configured a Controller Link GPIO the GPIO_USE_SEL bit is ignored. If the Controller Link GPIO is utilized in a platform, its associated GPIO functionality is no longer available to the host. If the Controller Link GPIO is not utilized in a platform, the signal can instead be used as its associated General Purpose I/O.

5.16 SATA Host Controller (D31:F2, F5)

The SATA function in the ICH10 has three modes of operation to support different operating system conditions. In the case of Native IDE enabled operating systems, the ICH10 utilizes two controllers to enable all six ports of the bus. The first controller (Device 31: Function 2) supports ports 0–3 and the second controller (Device 31: Function 5) supports ports 4 and 5. When using a legacy operating system, only one controller (Device 31: Function 2) is available that supports ports 0 - 3. In AHCI or RAID mode, only one controller (Device 31: Function 2) is used enabling all six ports.

The MAP register, [Section 15.1.29](#), provides the ability to share PCI functions. When sharing is enabled, all decode of I/O is done through the SATA registers. Device 31, Function 1 (IDE controller) is hidden by software writing to the Function Disable Register (D31, F0, offset F2h, bit 1), and its configuration registers are not used.

The ICH10 SATA controllers feature six sets of interface signals (ports) that can be independently enabled or disabled (they cannot be tri-stated or driven low). Each interface is supported by an independent DMA controller.

The ICH10 SATA controllers interact with an attached mass storage device through a register interface that is equivalent to that presented by a traditional IDE host adapter. The host software follows existing standards and conventions when accessing the register interface and follows standard command protocol conventions.

Note: SATA interface transfer rates are independent of UDMA mode settings. SATA interface transfer rates will operate at the bus's maximum speed, regardless of the UDMA mode reported by the SATA device or the system BIOS.



5.16.1 SATA Feature Support

| Feature | ICH10 (AHCI/RAID Disabled) | ICH10 (AHCI/RAID Enabled) |
|----------------------------------------|----------------------------------|---------------------------------|
| Native Command Queuing (NCQ) | N/A | Supported |
| Auto Activate for DMA | N/A | Supported |
| Hot Plug Support | N/A | Supported |
| Asynchronous Signal Recovery | N/A | Supported |
| 3 Gb/s Transfer Rate | Supported | Supported |
| ATAPI Asynchronous Notification | N/A | Supported |
| Host & Link Initiated Power Management | N/A | Supported |
| Staggered Spin-Up | Supported | Supported |
| Command Completion Coalescing | N/A | N/A |
| External SATA | N/A | Supported |

| Feature | Description |
|----------------------------------------|-----------------------------------------------------------------------------------------------------------------------------------------------------------|
| Native Command Queuing (NCQ) | Allows the device to reorder commands for more efficient data transfers |
| Auto Activate for DMA | Collapses a DMA Setup then DMA Activate sequence into a DMA Setup only |
| Hot Plug Support | Allows for device detection without power being applied and ability to connect and disconnect devices without prior notification to the system |
| Asynchronous Signal Recovery | Provides a recovery from a loss of signal or establishing communication after hot plug |
| 3 Gb/s Transfer Rate | Capable of data transfers up to 3Gb/s |
| ATAPI Asynchronous Notification | A mechanism for a device to send a notification to the host that the device requires attention |
| Host & Link Initiated Power Management | Capability for the host controller or device to request Partial and Slumber interface power states |
| Staggered Spin-Up | Enables the host the ability to spin up hard drives sequentially to prevent power load problems on boot |
| Command Completion Coalescing | Reduces interrupt and completion overhead by allowing a specified number of commands to complete and then generating an interrupt to process the commands |
| External SATA | Technology that allows for an outside the box connection of up to 2 meters (when using the cable defined in SATA-IO) |



5.16.2 Theory of Operation

5.16.2.1 Standard ATA Emulation

The ICH10 contains a set of registers that shadow the contents of the legacy IDE registers. The behavior of the Command and Control Block registers, PIO, and DMA data transfers, resets, and interrupts are all emulated.

Note: The ICH10 will assert INTR when the master device completes the EDD command regardless of the command completion status of the slave device. If the master completes EDD first, an INTR is generated and BSY will remain '1' until the slave completes the command. If the slave completes EDD first, BSY will be '0' when the master completes the EDD command and asserts INTR. Software must wait for busy to clear (0) before completing an EDD command, as required by the ATA5 through ATA7 (T13) industry standards.

5.16.2.2 48-Bit LBA Operation

The SATA host controller supports 48-bit LBA through the host-to-device register FIS when accesses are performed via writes to the task file. The SATA host controller will ensure that the correct data is put into the correct byte of the host-to-device FIS.

There are special considerations when reading from the task file to support 48-bit LBA operation. Software may need to read all 16-bits. Since the registers are only 8-bits wide and act as a FIFO, a bit must be set in the device/control register, which is at offset 3F6h for primary and 376h for secondary (or their native counterparts).

If software clears bit 7 of the control register before performing a read, the last item written will be returned from the FIFO. If software sets bit 7 of the control register before performing a read, the first item written will be returned from the FIFO.

5.16.3 SATA Swap Bay Support

The ICH10 provides for basic SATA swap bay support using the PSC register configuration bits and power management flows. A device can be powered down by software and the port can then be disabled, allowing removal and insertion of a new device.

Note: This SATA swap bay operation requires board hardware (implementation specific), BIOS, and operating system support.

5.16.4 Hot Plug Operation

ICH10 supports Hot Plug Surprise removal and Insertion Notification in the PARTIAL, SLUMBER and Listen Mode states when used with Low Power Device Presence Detection. Software can take advantage of power savings in the low power states while enabling hot plug operation. Refer to chapter 7 of the AHCI specification for details.

5.16.4.1 Low Power Device Presence Detection

Low Power Device Presence Detection enables SATA Link Power Management to co-exist with hot plug (insertion and removal) without interlock switch or cold presence detect. The detection mechanism allows Hot Plug events to be detectable by hardware across all link power states (Active, PARTIAL, SLUMBER) as well as AHCI Listen Mode.

If the Low Power Device Presence Detection circuit is disabled the ICH10 reverts to Hot Plug Surprise Removal Notification (without an interlock switch) mode that is mutually exclusive of the PARTIAL and SLUMBER power management states.



5.16.5 Function Level Reset Support (FLR)

The SATA Host Controller supports the Function Level Reset (FLR) capability. The FLR capability can be used in conjunction with Intel Virtualization Technology. FLR allows an Operating System in a Virtual Machine to have complete control over a device, including its initialization, without interfering with the rest of the platform. The device provides a software interface that enables the Operating System to reset the whole device as if a PCI reset was asserted.

5.16.5.1 FLR Steps

5.16.5.1.1 FLR Initialization

1. A FLR is initiated by software writing a '1' to the Initiate FLR bit.
2. All subsequent requests targeting the Function will not be claimed and will be Master Abort Immediate on the bus. This includes any configuration, I/O or Memory cycles, however, the Function shall continue to accept completions targeting the Function.

5.16.5.1.2 FLR Operation

The Function will Reset all configuration, I/O and memory registers of the Function except those indicated otherwise and reset all internal states of the Function to the default or initial condition.

5.16.5.1.3 FLR Completion

The Initiate FLR bit is reset (cleared) when the FLR reset is completed. This bit can be used to indicate to the software that the FLR reset is completed.

Note: From the time Initiate FLR bit is written to '1' software must wait at least 100 ms before accessing the function.



5.16.6 Intel® Matrix Storage Technology Configuration

The Intel® Matrix Storage Technology offers several diverse options for RAID (redundant array of independent disks) to meet the needs of the end user. AHCI support provides higher performance and alleviates disk bottlenecks by taking advantage of the independent DMA engines that each SATA port offers in ICH10.

- RAID Level 0 performance scaling up to 4 drives, enabling higher throughput for data intensive applications such as video editing.
- Data security is offered through RAID Level 1, which performs mirroring.
- RAID Level 10 provides high levels of storage performance with data protection, combining the fault-tolerance of RAID Level 1 with the performance of RAID Level 0. By striping RAID Level 1 segments, high I/O rates can be achieved on systems that require both performance and fault-tolerance. RAID Level 10 requires 4 hard drives, and provides the capacity of two drives.
- RAID Level 5 provides highly efficient storage while maintaining fault-tolerance on 3 or more drives. By striping parity, and rotating it across all disks, fault tolerance of any single drive is achieved while only consuming 1 drive worth of capacity. That is, a 3 drive RAID 5 has the capacity of 2 drives, or a 4 drive RAID 5 has the capacity of 3 drives. RAID 5 has high read transaction rates, with a medium write rate. RAID 5 is well suited for applications that require high amounts of storage while maintaining fault tolerance.

By using the ICH10's built-in Intel Matrix Storage Technology, there is no loss of PCI resources (request/grant pair) or add-in card slot.

Intel Matrix Storage Technology functionality requires the following items:

1. ICH10 component enabled for Intel Matrix Storage Technology (see [Section 1.3](#))
2. Intel Matrix Storage Manager RAID Option ROM must be on the platform
3. Intel Matrix Storage Manager drivers, most recent revision.
4. At least two SATA hard disk drives (minimum depends on RAID configuration).

Intel Matrix Storage Technology is not available in the following configurations:

1. The SATA controller is in compatible mode.

5.16.6.1 Intel® Matrix Storage Manager RAID Option ROM

The Intel Matrix Storage Manager RAID Option ROM is a standard PnP Option ROM that is easily integrated into any System BIOS. When in place, it provides the following three primary functions:

- Provides a text mode user interface that allows the user to manage the RAID configuration on the system in a pre-operating system environment. Its feature set is kept simple to keep size to a minimum, but allows the user to create & delete RAID volumes and select recovery options when problems occur.
- Provides boot support when using a RAID volume as a boot disk. It does this by providing Int13 services when a RAID volume needs to be accessed by DOS applications (such as NTLDR) and by exporting the RAID volumes to the System BIOS for selection in the boot order.
- At each boot up, provides the user with a status of the RAID volumes and the option to enter the user interface by pressing CTRL-I.



5.16.7 Power Management Operation

Power management of the ICH10 SATA controller and ports will cover operations of the host controller and the SATA wire.

5.16.7.1 Power State Mappings

The D0 PCI power management state for device is supported by the ICH10 SATA controller.

SATA devices may also have multiple power states. From parallel ATA, three device states are supported through ACPI. They are:

- **D0** – Device is working and instantly available.
- **D1** – device enters when it receives a STANDBY IMMEDIATE command. Exit latency from this state is in seconds
- **D3** – from the SATA device’s perspective, no different than a D1 state, in that it is entered via the STANDBY IMMEDIATE command. However, an ACPI method is also called which will reset the device and then cut its power.

Each of these device states are subsets of the host controller’s D0 state.

Finally, SATA defines three PHY layer power states, which have no equivalent mappings to parallel ATA. They are:

- **PHY READY** – PHY logic and PLL are both on and active
- **Partial** – PHY logic is powered, but in a reduced state. Exit latency is no longer than 10 ns
- **Slumber** – PHY logic is powered, but in a reduced state. Exit latency can be up to 10 ms.

Since these states have much lower exit latency than the ACPI D1 and D3 states, the SATA controller defines these states as sub-states of the device D0 state.

Figure 5-10. SATA Power States

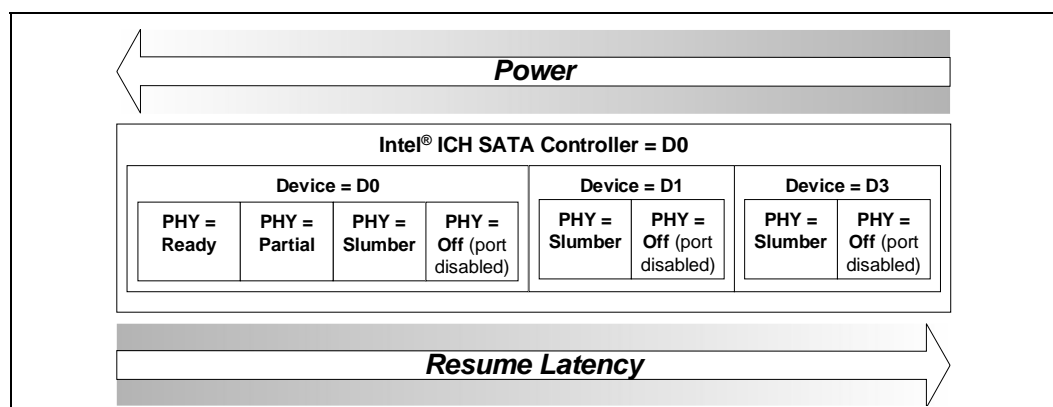

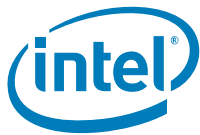

5.16.7.2 Power State Transitions

5.16.7.2.1 Partial and Slumber State Entry/Exit

The partial and slumber states save interface power when the interface is idle. The SATA controller defines PHY layer power management (as performed via primitives) as a driver operation from the host side, and a device proprietary mechanism on the device side. The SATA controller accepts device transition types, but does not issue any transitions as a host. All received requests from a SATA device will be ACKed.

When an operation is performed to the SATA controller such that it needs to use the SATA cable, the controller must check whether the link is in the Partial or Slumber states, and if so, must issue a COM_WAKE to bring the link back online. Similarly, the SATA device must perform the same action.

5.16.7.2.2 Device D1, D3 States

These states are entered after some period of time when software has determined that no commands will be sent to this device for some time. The mechanism for putting a device in these states does not involve any work on the host controller, other than sending commands over the interface to the device. The command most likely to be used in ATA/ATAPI is the "STANDBY IMMEDIATE" command.

5.16.7.2.3 Host Controller D3_{HOT} State

After the interface and device have been put into a low power state, the SATA host controller may be put into a low power state. This is performed via the PCI power management registers in configuration space. There are two very important aspects to note when using PCI power management.

1. When the power state is D3, only accesses to configuration space are allowed. Any attempt to access the memory or I/O spaces will result in master abort.
2. When the power state is D3, no interrupts may be generated, even if they are enabled. If an interrupt status bit is pending when the controller transitions to D0, an interrupt may be generated.

When the controller is put into D3, it is assumed that software has properly shut down the device and disabled the ports. Therefore, there is no need to sustain any values on the port wires. The interface will be treated as if no device is present on the cable, and power will be minimized.

When returning from a D3 state, an internal reset will not be performed.

5.16.7.2.4 Non-AHCI Mode PME# Generation

When in non-AHCI mode (legacy mode) of operation, the SATA controller does not generate PME#. This includes attach events (since the port must be disabled), or interlock switch events (via the SATAGP pins).

5.16.7.3 SMI Trapping (APM)

Device 31:Function2:Offset C0h (see [Section 14.1.37](#)) contain control for generating SMI# on accesses to the IDE I/O spaces. These bits map to the legacy ranges (1F0–1F7h, 3F6h, 170–177h, and 376h) and native IDE ranges defined by PCMDBA, PCTLBA, SCMDBA and SCTLBA. If the SATA controller is in legacy mode and is using these addresses, accesses to one of these ranges with the appropriate bit set causes the cycle to not be forwarded to the SATA controller, and for an SMI# to be generated. If an access to the Bus-Master IDE registers occurs while trapping is enabled for the device being accessed, then the register is updated, an SMI# is generated, and the device activity status bits ([Section 14.1.38](#)) are updated indicating that a trap occurred.

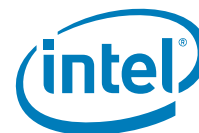

5.16.8 SATA Device Presence

In legacy mode, the SATA controller does not generate interrupts based on hot plug/unplug events. However, the SATA PHY does know when a device is connected (if not in a partial or slumber state), and it's beneficial to communicate this information to host software as this will greatly reduce boot times and resume times.

The flow used to indicate SATA device presence is shown in Figure 5-11. The 'PxE' bit refers to PCS.P[3:0]E bits, depending on the port being checked and the 'PxP' bits refer to the PCS.P[3:0]P bits, depending on the port being checked. If the PCS/PxP bit is set a device is present, if the bit is cleared a device is not present. If a port is disabled, software can check to see if a new device is connected by periodically reenabling the port and observing if a device is present, if a device is not present it can disable the port and check again later. If a port remains enabled, software can periodically poll PCS.PxP to see if a new device is connected.

Figure 5-11. Flow for Port Enable / Device Present Bits

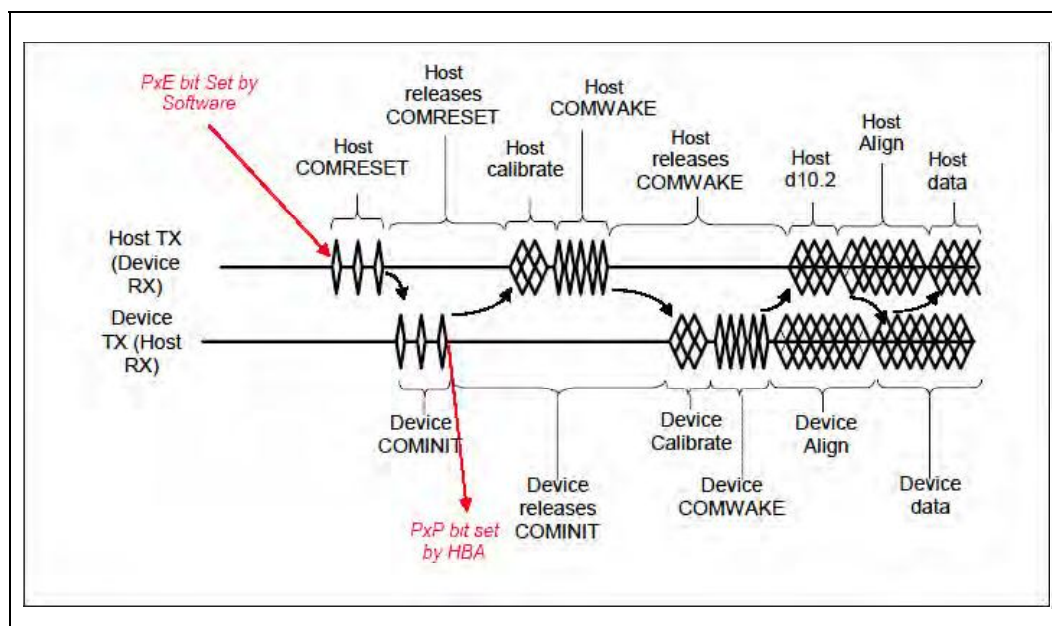



5.16.9 SATA LED

The SATALED# output is driven whenever the BSY bit is set in any SATA port. The SATALED# is an active-low open-drain output. When SATALED# is low, the LED should be active. When SATALED# is high, the LED should be inactive.

5.16.10 AHCI Operation

The ICH10 provides hardware support for Advanced Host Controller Interface (AHCI), a programming interface for SATA host controllers developed through a joint industry effort. AHCI defines transactions between the SATA controller and software and enables advanced performance and usability with SATA. Platforms supporting AHCI may take advantage of performance features such as no master/slave designation for SATA devices—each device is treated as a master—and hardware assisted native command queuing. AHCI also provides usability enhancements such as Hot-Plug. AHCI requires appropriate software support (e.g., an AHCI driver) and for some features, hardware support in the SATA device or additional platform hardware.

The ICH10 supports all of the mandatory features of the *Serial ATA Advanced Host Controller Interface Specification*, Revision 1.2 and many optional features, such as hardware assisted native command queuing, aggressive power management, LED indicator support, and Hot-Plug through the use of interlock switch support (additional platform hardware and software may be required depending upon the implementation).

Note: For reliable device removal notification while in AHCI operation without the use of interlock switches (surprise removal), interface power management should be disabled for the associated port. See Section 7.3.1 of the *AHCI Specification* for more information.

5.16.11 Serial ATA Reference Clock Low Power Request (SATACLKREQ#)

The 100 MHz Serial ATA Reference Clock (SATACLKP, SATACLKN) is implemented on the system as a ground-terminated low-voltage differential signal pair driven by the system Clock Chip. When all the SATA links are in Slumber or disabled, the SATA Reference Clock is not needed and may be stopped and tri-stated at the clock chip allowing system-level power reductions.

The ICH10 uses the SATACLKREQ# output signal to communicate with the system Clock Chip to request either SATA clock running or to tell the system clock chip that it can stop the SATA Reference Clock. ICH10 drives this signal low to request clock running, and tristates the signal to indicate that the SATA Reference Clock may be stopped (the ICH10 never drives the pin high). When the SATACLKREQ# is tristated by the ICH10, the clock chip may stop the SATA Reference Clock within 100 ns, anytime after 100 ns, or not at all. If the SATA Reference Clock is not already running, it will start within 100 ns after a SATACLKREQ# is driven low by the ICH10.

To enable SATA Reference Clock Low Power Request:

1. Configure GPIO35 to native function
2. Set SATA Clock Request Enable (SCRE) bit to '1' (Dev 31:F2:Offset 94h:bit 28).

Note: The reset default for SATACLKREQ# is low to insure that the SATA Reference Clock is running after system reset.



5.16.12 SGPIO Signals

The SGPIO signals, in accordance to the SFF-8485 specification, support per-port LED signaling. These signals are not related to SATALED#, which allows for simplified indication of SATA command activity. The SGPIO group interfaces with an external controller chip that fetches and serializes the data for driving across the SGPIO bus. The output signals then control the LEDs. This feature is only valid in AHCI/RAID mode.

5.16.12.1 Mechanism

The enclosure management for SATA Controller 1 (Device 31: Function 2) involves sending messages that control LEDs in the enclosure. The messages for this function are stored after the normal registers in the AHCI BAR, at Offset 400h bytes for ICH10 from the beginning of the AHCI BAR as specified by the EM_LOC global register (Section 14.4.1.8).

Software creates messages for transmission in the enclosure management message buffer. The data in the message buffer should not be changed if CTL.TM bit is set by software to transmit an update message. Software should only update the message buffer when CTL.TM bit is cleared by hardware otherwise the message transmitted will be indeterminate. Software then writes a register to cause hardware to transmit the message or take appropriate action based on the message content. The software should only create message types supported by the controller, which is LED messages for ICH10. If the software creates other non LED message types (e.g. SAF-TE, SES-2), the SGPIO interface may hang and the result is indeterminate.

During reset all SGPIO pins will be in tri-state state. The interface will continue to be in tri-state state after reset until the first transmission occurs when software programs the message buffer and sets the transmit bit CTL.TM. The SATA Host controller will initiate the transmission by driving SCLOCK and at the same time drive the SLOAD to '0' prior to the actual bit stream transmission. The Host will drive SLOAD low for at least 5 SCLOCK then only start the bit stream by driving the SLOAD to high. SLOAD will be driven high for 1 SCLOCK follow by vendor specific pattern that is default to "0000" if software has yet to program the value. A total of 18-bit stream from 6 ports (Port0, Port1, Port2, Port3, Port4 and Port5) of 3-bit per port LED message will be transmitted on SDATAOUT0 pin after the SLOAD is driven high for 1 SCLOCK. Only 2 ports (port4 and port5) of 6 bit total LED message follow by 12 bits of tri-state value will be transmitted out on SDATAOUT1 pin.

All the default LED message values will be high prior to software setting them, except the Activity LED message that is configured to be hardware driven that will be generated based on the activity from the respective port. All the LED message values will be driven to '1' for the port that is unimplemented as indicated in the Port Implemented register regardless of the software programmed value through the message buffer.

There are 2 different ways of resetting ICH SGPIO interface, asynchronous reset and synchronous reset. Asynchronous reset is caused by platform reset to cause the SGPIO interface to be tri-state asynchronously. Synchronous reset is caused by setting the CTL.RESET bit, clearing the GHC.AE bit or HBA reset, where Host Controller will complete the existing full bit stream transmission then only tri-state all the SGPIO pins. After the reset, both synchronous and asynchronous, the SGPIO pins will stay tri-stated.

Note:

ICH Host Controller does not ensure to cause the target SGPIO device or controller to be reset. Software is responsible to keep ICH SGPIO interface in tri-state stated for 2 second in order to cause a reset on the target of the SGPIO interface.



5.16.12.2 Message Format

Messages shall be constructed with a one Dword header that describes the message to be sent followed by the actual message contents. The first Dword shall be constructed as follows:

| Bit | Description |
|-------|-------------------------------------------------------------------------------------------------------------------------------------------------------------------------------------------------------------------------------------------------------------------------------------------------------------------------------------------------------------------------------------------------------------------------|
| 31:28 | Reserved |
| 27:24 | Message Type (MTYPE) : Specifies the type of the message. The message types are: 0h = LED 1h = SAF-TE 2h = SES-2 3h = SGPIO (register based interface) All other values reserved |
| 23:16 | Data Size (DSIZE) : Specifies the data size in bytes. If the message (enclosure services command) has a data buffer that is associated with it that is transferred, the size of that data buffer is specified in this field. If there is no separate data buffer, this field shall have a value of '0'. The data directly follows the message in the message buffer. For ICH10, this value should always be '0'. |
| 15:8 | Message Size (MSIZE) : Specifies the size of the message in bytes. The message size does not include the one Dword header. A value of '0' is invalid. For ICH10, the message size is always 4 bytes. |
| 7:0 | Reserved |

The SAF-TE, SES-2, and SGPIO message formats are defined in the corresponding specifications, respectively. The LED message type is defined in [Section 5.16.12.3](#). It is the responsibility of software to ensure the content of the message format is correct. If the message type is not programmed as 'LED' for this controller, the controller shall not take any action to update its LEDs. Note that for LED message type, the message size is always consisted of 4 bytes.

5.16.12.3 LED Message Type

The LED message type specifies the status of up to three LEDs. Typically, the usage for these LEDs is activity, fault, and locate. Not all implementations necessarily contain all LEDs (for example, some implementations may not have a locate LED). The message identifies the HBA port number that the slot status applies to. The format of the LED message type is defined in [Table 5-42](#). The LEDs shall retain their values until there is a following update for that particular slot.

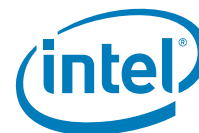
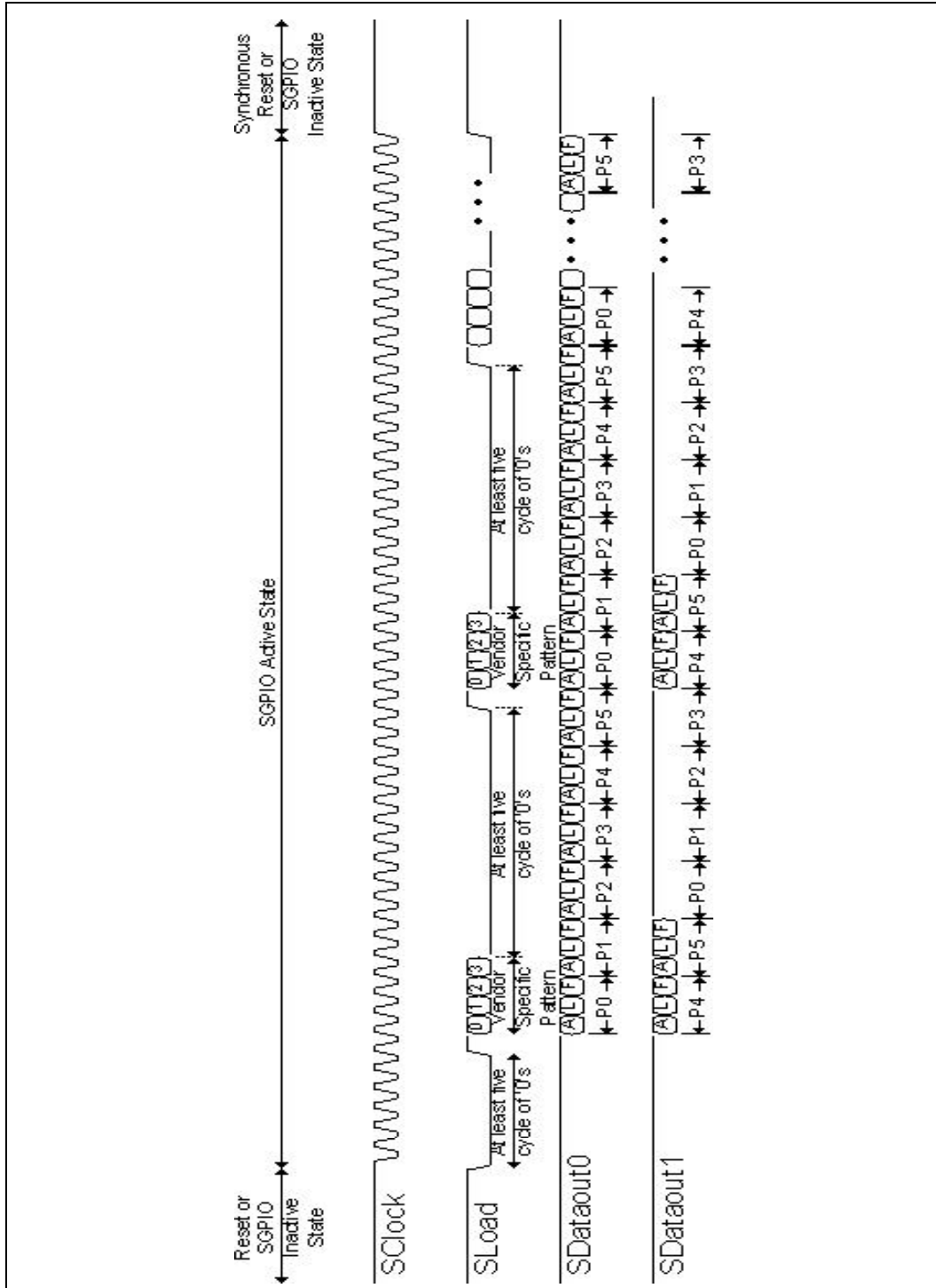

Table 5-42. Multi-activity LED message type

| Byte | Description |
|------|------------------------------------------------------------------------------------------------------------------------------------------------------------------------------------------------------------------------------------------------------------------------------------------------------------------------------------------------------------------------------------------------------------------------------------------------------------------------------------------------------------------------------------------------------------------------------------------------------------------------------------------------------------------------------------------------------------------------------------------------------------------------------------------------------------------------------------------------------------------------------------------------------------------------------------------------------------------------------------------------------------------------------------------------------------------------------------------------------------------------------------------------------------------------------------------------------------------------------------------------------------------------------------------------------------------------------------------|
| 3-2 | <p>Value (VAL): This field describes the state of each LED for a particular location. There are three LEDs that may be supported by the HBA. Each LED has 3 bits of control.</p> <p>LED values are: 000b - LED shall be off 001b - LED shall be solid on as perceived by human eye All other values reserved</p> <p>The LED bit locations are: Bits 2:0 - Activity LED (may be driven by hardware) Bits 5:3 - Vendor Specific LED (e.g. locate) Bits 8:6 - Vendor Specific LED (e.g. fault) Bits 15:9 - Reserved</p> <p>Vendor specific message is: Bit 3:0 - Vendor Specific Pattern Bit 15:4 - Reserved</p> <p>Note: If Activity LED Hardware Driven (ATTR.ALHD) bit is set, host will output the hardware LED value sampled internally and will ignore software written activity value on bit [2:0]. Since ICH10 Enclosure Management does not support port multiplier based LED message, the LED message will be generated independently based on respective port's operation activity. Vendor specific LED values Locate (Bits 5:3) and Fault (Bits 8:6) always are driven by software.</p> |
| 1 | <p>Port Multiplier Information: Specifies slot specific information related to Port Multiplier.</p> <p>Bits 3:0 specify the Port Multiplier port number for the slot that requires the status update. If a Port Multiplier is not attached to the device in the affected slot, the Port Multiplier port number shall be '0'. Bits 7:4 are reserved. ICH10 does not support LED messages for devices behind a Port Multiplier. This byte should be 0.</p> |
| 0 | <p>HBA Information: Specifies slot specific information related to the HBA.</p> <p>Bits 4:0 - HBA port number for the slot that requires the status update. Bit 5 - If set to '1', Value is a vendor specific message that applies to the entire enclosure. If cleared to '0', Value applies to the port specified in bits 4:0. Bits 7:6 - Reserved</p> |

5.16.12.4 SGPIO Waveform

Figure 5-12. Serial Data transmitted over the SGPIO Interface





5.16.13 External SATA

ICH10 supports external SATA. External SATA utilizes the SATA interface outside of the system box. The usage model for this feature must comply with the Serial ATA II Cables and Connectors Volume 2 Gold specification at www.sata-io.org. Intel validates two configurations:

1. The cable-up solution involves an internal SATA cable that connects to the SATA motherboard connector and spans to a back panel PCI bracket with an e-SATA connector. A separate e-SATA cable is required to connect an e-SATA device.
2. The back-panel solution involves running a trace to the I/O back panel and connecting a device via an external SATA connector on the board.

5.17 High Precision Event Timers

This function provides a set of timers that can be used by the operating system. The timers are defined such that in the future, the operating system may be able to assign specific timers to used directly by specific applications. Each timer can be configured to cause a separate interrupt.

ICH10 provides eight (Corporate Family) or four (Consumer Family) timers. The timers are implemented as a single counter each with its own comparator and value register. This counter increases monotonically. Each individual timer can generate an interrupt when the value in its value register matches the value in the main counter.

The registers associated with these timers are mapped to a memory space (much like the I/O APIC). However, it is not implemented as a standard PCI function. The BIOS reports to the operating system the location of the register space. The hardware can support an assignable decode space; however, the BIOS sets this space prior to handing it over to the operating system (See [Section 9.4](#)). It is not expected that the operating system will move the location of these timers once it is set by the BIOS.

5.17.1 Timer Accuracy

1. The timers are accurate over any 1 ms period to within 0.05% of the time specified in the timer resolution fields.
2. Within any 100 microsecond period, the timer reports a time that is up to two ticks too early or too late. Each tick is less than or equal to 100 ns, so this represents an error of less than 0.2%.
3. The timer is monotonic. It does not return the same value on two consecutive reads (unless the counter has rolled over and reached the same value).

The main counter is clocked by the 14.31818 MHz clock, synchronized into the 66.666 MHz domain. This results in a non-uniform duty cycle on the synchronized clock, but does have the correct average period. The accuracy of the main counter is as accurate as the 14.31818 MHz clock.



5.17.2 Interrupt Mapping

Mapping Option #1 (Legacy Replacement Option)

In this case, the Legacy Replacement Rout bit (LEG_RT_CNF) is set. This forces the mapping found in [Table 5-43](#).

Table 5-43. Legacy Replacement Routing

| Timer | 8259 Mapping | APIC Mapping | Comment |
|--------------------------------|------------------------|-----------------------|------------------------------------------------------------|
| 0 | IRQ0 | IRQ2 | In this case, the 8254 timer will not cause any interrupts |
| 1 | IRQ8 | IRQ8 | In this case, the RTC will not cause any interrupts. |
| 2 & 3 | Per IRQ Routing Field. | Per IRQ Routing Field | |
| 4, 5, 6, 7 (Corporate Only) | not available | not available | |

NOTE: (Corporate Only) The Legacy Option does not preclude delivery of IRQ0/IRQ8 via direct FSB interrupt messages.

Mapping Option #2 (Standard Option)

In this case, the Legacy Replacement Rout bit (LEG_RT_CNF) is 0. Each timer has its own routing control. The interrupts can be routed to various interrupts in the 8259 or I/O APIC. A capabilities field indicates which interrupts are valid options for routing. If a timer is set for edge-triggered mode, the timers should not be share with any PCI interrupts.

For the Intel ICH10, the only supported interrupt values are as follows:

Timer 0 and 1: IRQ20, 21, 22 & 23 (I/O APIC only).

Timer 2: IRQ11 (8259 or I/O APIC) and IRQ20, 21, 22, and 23 (I/O APIC only).

Timer 3: IRQ12 (8259 or I/O APIC) and IRQ 20, 21, 22, and 23 (I/O APIC only).

Interrupts from Timer 4, 5, 6, 7 (Corporate Only) can only be delivered via direct FSB interrupt messages.

5.17.3 Periodic vs. Non-Periodic Modes

Non-Periodic Mode

Timer 0 is configurable to 32 (default) or 64-bit mode, whereas Timers 1, 2 and 3 only support 32-bit mode (See [Section 21.1.5](#)).

All of the timers support non-periodic mode.

Consult Section 2.3.9.2.1 of the *IA-PC HPET Specification* for a description of this mode.

Periodic Mode

Timer 0 is the only timer that supports periodic mode. Consult Section 2.3.9.2.2 of the *IA-PC HPET Specification* for a description of this mode.



The following usage model is expected:

1. Software clears the ENABLE_CNF bit to prevent any interrupts
2. Software Clears the main counter by writing a value of 00h to it.
3. Software sets the TIMERO_VAL_SET_CNF bit.
4. Software writes the new value in the TIMERO_COMPARATOR_VAL register
5. Software sets the ENABLE_CNF bit to enable interrupts.

The Timer 0 Comparator Value register cannot be programmed reliably by a single 64-bit write in a 32-bit environment except if only the periodic rate is being changed during run-time. If the actual Timer 0 Comparator Value needs to be reinitialized, then the following software solution will always work regardless of the environment:

1. Set TIMERO_VAL_SET_CNF bit
2. Set the lower 32 bits of the Timer0 Comparator Value register
3. Set TIMERO_VAL_SET_CNF bit
4. Set the upper 32 bits of the Timer0 Comparator Value register

5.17.4 Enabling the Timers

The BIOS or operating system PnP code should route the interrupts. This includes the Legacy Rout bit, Interrupt Rout bit (for each timer), interrupt type (to select the edge or level type for each timer)

The Device Driver code should do the following for an available timer:

1. Set the Overall Enable bit (Offset 10h, bit 0).
2. Set the timer type field (selects one-shot or periodic).
3. Set the interrupt enable
4. Set the comparator value

5.17.5 Interrupt Levels

Interrupts directed to the internal 8259s are active high. See [Section 5.9](#) for information regarding the polarity programming of the I/O APIC for detecting internal interrupts.

If the interrupts are mapped to the 8259 or I/O APIC and set for level-triggered mode, they can be shared with PCI interrupts. They may be shared although it's unlikely for the operating system to attempt to do this.

If more than one timer is configured to share the same IRQ (using the TIMERN_INT_ROUT_CNF fields), then the software must configure the timers to level-triggered mode. Edge-triggered interrupts cannot be shared.

5.17.6 Handling Interrupts

If each timer has a unique interrupt and the timer has been configured for edge-triggered mode, then there are no specific steps required. No read is required to process the interrupt.

If a timer has been configured to level-triggered mode, then its interrupt must be cleared by the software. This is done by reading the interrupt status register and writing a 1 back to the bit position for the interrupt to be cleared.

Independent of the mode, software can read the value in the main counter to see how time has passed between when the interrupt was generated and when it was first serviced.

If Timer 0 is set up to generate a periodic interrupt, the software can check to see how much time remains until the next interrupt by checking the timer value register.

5.17.7 Issues Related to 64-Bit Timers with 32-Bit Processors

A 32-bit timer can be read directly using processors that are capable of 32-bit or 64-bit instructions. However, a 32-bit processor may not be able to directly read 64-bit timer. A race condition comes up if a 32-bit processor reads the 64-bit register using two separate 32-bit reads. The danger is that just after reading one half, the other half rolls over and changes the first half.

If a 32-bit processor needs to access a 64-bit timer, it must first halt the timer before reading both the upper and lower 32-bits of the timer. If a 32-bit processor does not want to halt the timer, it can use the 64-bit timer as a 32-bit timer by setting the `TIMERn_32MODE_CNF` bit. This causes the timer to behave as a 32-bit timer. The upper 32-bits are always 0.

Alternatively, software may do a multiple read of the counter while it is running. Software can read the high 32 bits, then the low 32 bits, the high 32 bits again. If the high 32 bits have not changed between the two reads, then a rollover has not happened and the low 32 bits are valid. If the high 32 bits have changed between reads, then the multiple reads are repeated until a valid read is performed.

Note: On a 64-bit platform, if software attempts a 64 bit read of the 64-bit counter, software must be aware that some platforms may split the 64 bit read into two 32 bit reads. The read maybe inaccurate if the low 32 bits roll over between the high and low reads.

5.18 USB UHCI Host Controllers (D29:F0, F1, F2, F3 and D26:F0, F1 and F2)

The ICH10 contains six USB full/low-speed host controllers that support the standard Universal Host Controller Interface (UHCI), Revision 1.1. Each UHCI Host Controller (UHC) includes a root hub with two separate USB ports each, for a total of twelve USB ports.

- Overcurrent detection on all twelve USB ports is supported. The overcurrent inputs are *not* 5 V tolerant, and can be used as GPIs if not needed.
- The ICH10's UHCI host controllers are arbitrated differently than standard PCI devices to improve arbitration latency.
- The UHCI controllers use the Analog Front End (AFE) embedded cell that allows support for USB full-speed signaling rates, instead of USB I/O buffers.

Note: D26:F2 can be configured as D29:F3 during BIOS Post.



5.18.1 Data Structures in Main Memory

Section 3.1 - 3.3 of the *Universal Host Controller Interface Specification, Revision 1.1* details the data structures used to communicate control, status, and data between software and the ICH10.

5.18.2 Data Transfers to/from Main Memory

Section 3.4 of the *Universal Host Controller Interface Specification, Revision 1.1* describes the details on how HCD and the ICH10 communicate via the Schedule data structures.

5.18.3 Data Encoding and Bit Stuffing

The ICH10 USB employs NRZI data encoding (Non-Return to Zero Inverted) when transmitting packets. Full details on this implementation are given in the *Universal Serial Bus Specification, Revision 2.0*.

5.18.4 Bus Protocol

5.18.4.1 Bit Ordering

Bits are sent out onto the bus least significant bit (LSb) first, followed by next LSb, through to the most significant bit (MSb) last.

5.18.4.2 SYNC Field

All packets begin with a synchronization (SYNC) field, which is a coded sequence that generates a maximum edge transition density. The SYNC field appears on the bus as IDLE followed by the binary string "KJKJKJKK," in its NRZI encoding. It is used by the input circuitry to align incoming data with the local clock and is defined to be 8 bits in length. SYNC serves only as a synchronization mechanism. The last two bits in the SYNC field are a marker that is used to identify the first bit of the PID. All subsequent bits in the packet must be indexed from this point.

5.18.4.3 Packet Field Formats

All packets have distinct start and end of packet delimiters. Full details are given in the *Universal Serial Bus Specification, Revision 2.0*, in Section 8.3.1.

5.18.4.4 Address Fields

Function endpoints are addressed using the function address field and the endpoint field. Full details on this are given in the *Universal Serial Bus Specification, Revision 2.0*, in Section 8.3.2.

5.18.4.5 Frame Number Field

The frame number field is an 11-bit field that is incremented by the host on a per frame basis. The frame number field rolls over upon reaching its maximum value of 7FFh, and is sent only for SOF tokens at the start of each frame.

5.18.4.6 Data Field

The data field may range from 0 to 1023 bytes and must be an integral numbers of bytes. Data bits within each byte are shifted out LSB first.



5.18.4.7 Cyclic Redundancy Check (CRC)

CRC is used to protect the all non-PID fields in token and data packets. In this context, these fields are considered to be protected fields. Full details on this are given in the *Universal Serial Bus Specification, Revision 2.0*, in Section 8.3.5.

5.18.5 Packet Formats

The USB protocol calls out several packet types: token, data, and handshake packets. Full details on this are given in the *Universal Serial Bus Specification, Revision 2.0*, in Section 8.4.

5.18.6 USB Interrupts

There are two general groups of USB interrupt sources, those resulting from execution of transactions in the schedule, and those resulting from an ICH10 operation error. All transaction-based sources can be masked by software through the ICH10's Interrupt Enable register. Additionally, individual transfer descriptors can be marked to generate an interrupt on completion.

When the ICH10 drives an interrupt for USB, it internally drives the PIRQA# pin for USB function #0 and USB function #3, PIRQD# pin for USB function #1, and the PIRQC# pin for USB function #2, until all sources of the interrupt are cleared. In order to accommodate some operating systems, the Interrupt Pin register must contain a different value for each function of this new multi-function device.

5.18.6.1 Transaction-Based Interrupts

These interrupts are not signaled until after the status for the last complete transaction in the frame has been written back to host memory. This ensures that software can safely process through (Frame List Current Index -1) when it is servicing an interrupt.

CRC Error / Time-Out

A CRC/Time-Out error occurs when a packet transmitted from the ICH10 to a USB device or a packet transmitted from a USB device to the ICH10 generates a CRC error. The ICH10 is informed of this event by a time-out from the USB device or by the ICH10's CRC checker generating an error on reception of the packet. Additionally, a USB bus time-out occurs when USB devices do not respond to a transaction phase within 19-bit times of an EOP. Either of these conditions causes the C_ERR field of the TD to decrement.

When the C_ERR field decrements to 0, the following occurs:

- The Active bit in the TD is cleared
- The Stalled bit in the TD is set
- The CRC/Time-out bit in the TD is set.
- At the end of the frame, the USB Error Interrupt bit is set in the HC status register.

If the CRC/Time out interrupt is enabled in the Interrupt Enable register, a hardware interrupt will be signaled to the system.



Interrupt on Completion

Transfer Descriptors contain a bit that can be set to cause an interrupt on their completion. The completion of the transaction associated with that block causes the USB Interrupt bit in the HC Status Register to be set at the end of the frame in which the transfer completed. When a TD is encountered with the IOC bit set to 1, the IOC bit in the HC Status register is set to 1 at the end of the frame if the active bit in the TD is set to 0 (even if it was set to 0 when initially read).

If the IOC Enable bit of Interrupt Enable register (bit 2 of I/O offset 04h) is set, a hardware interrupt is signaled to the system. The USB Interrupt bit in the HC status register is set either when the TD completes successfully or because of errors. If the completion is because of errors, the USB Error bit in the HC status register is also set.

Short Packet Detect

A transfer set is a collection of data which requires more than one USB transaction to completely move the data across the USB. An example might be a large print file which requires numerous TDs in multiple frames to completely transfer the data. Reception of a data packet that is less than the endpoint's Max Packet size during Control, Bulk or Interrupt transfers signals the completion of the transfer set, even if there are active TDs remaining for this transfer set. Setting the SPD bit in a TD indicates to the HC to set the USB Interrupt bit in the HC status register at the end of the frame in which this event occurs. This feature streamlines the processing of input on these transfer types. If the Short Packet Interrupt Enable bit in the Interrupt Enable register is set, a hardware interrupt is signaled to the system at the end of the frame where the event occurred.

Serial Bus Babble

When a device transmits on the USB for a time greater than its assigned Max Length, it is said to be babbling. Since isochrony can be destroyed by a babbling device, this error results in the Active bit in the TD being cleared to 0 and the Stalled and Babble bits being set to 1. The C_ERR field is not decremented for a babble. The USB Error Interrupt bit in the HC Status register is set to 1 at the end of the frame. A hardware interrupt is signaled to the system.

If an EOF babble was caused by the ICH10 (due to incorrect schedule for instance), the ICH10 forces a bit stuff error followed by an EOP and the start of the next frame.

Stalled

This event indicates that a device/endpoint returned a STALL handshake during a transaction or that the transaction ended in an error condition. The TDs Stalled bit is set and the Active bit is cleared. Reception of a STALL does not decrement the error counter. A hardware interrupt is signaled to the system.

Data Buffer Error

This event indicates that an overrun of incoming data or a under-run of outgoing data has occurred for this transaction. This would generally be caused by the ICH10 not being able to access required data buffers in memory within necessary latency requirements. Either of these conditions causes the C_ERR field of the TD to be decremented.

When C_ERR decrements to 0, the Active bit in the TD is cleared, the Stalled bit is set, the USB Error Interrupt bit in the HC Status register is set to 1 at the end of the frame and a hardware interrupt is signaled to the system.



Bit Stuff Error

A bit stuff error results from the detection of a sequence of more than six 1s in a row within the incoming data stream. This causes the C_ERR field of the TD to be decremented. When the C_ERR field decrements to 0, the Active bit in the TD is cleared to 0, the Stalled bit is set to 1, the USB Error Interrupt bit in the HC Status register is set to 1 at the end of the frame and a hardware interrupt is signaled to the system.

5.18.6.2 Non-Transaction Based Interrupts

If an ICH10 process error or system error occurs, the ICH10 halts and immediately issues a hardware interrupt to the system.

Resume Received

This event indicates that the ICH10 received a RESUME signal from a device on the USB bus during a global suspend. If this interrupt is enabled in the Interrupt Enable register, a hardware interrupt is signaled to the system allowing the USB to be brought out of the suspend state and returned to normal operation.

ICH10 Process Error

The HC monitors certain critical fields during operation to ensure that it does not process corrupted data structures. These include checking for a valid PID and verifying that the MaxLength field is less than 1280. If it detects a condition that would indicate that it is processing corrupted data structures, it immediately halts processing, sets the HC Process Error bit in the HC Status register and signals a hardware interrupt to the system.

This interrupt cannot be disabled through the Interrupt Enable register.

Host System Error

The ICH10 sets this bit to 1 when a Parity error, Master Abort, or Target Abort occurs. When this error occurs, the ICH10 clears the Run/Stop bit in the Command register to prevent further execution of the scheduled TDs. This interrupt cannot be disabled through the Interrupt Enable register.



5.18.7 USB Power Management

The Host controller can be put into a suspended state and its power can be removed. This requires that certain bits of information are retained in the suspend power plane of the ICH10 so that a device on a port may wake the system. Such a device may be a fax-modem, which will wake up the machine to receive a fax or take a voice message. The settings of the following bits in I/O space will be maintained when the ICH10 enters the S3, S4, or S5 states.

Table 5-44. Bits Maintained in Low Power States

| Register | Offset | Bit | Description |
|-------------------------|-----------|-----|----------------------------------|
| Command | 00h | 3 | Enter Global Suspend Mode (EGSM) |
| Status | 02h | 2 | Resume Detect |
| Port Status and Control | 10h & 12h | 2 | Port Enabled/Disabled |
| | | 6 | Resume Detect |
| | | 8 | Low-speed Device Attached |
| | | 12 | Suspend |

When the ICH10 detects a resume event on any of its ports, it sets the corresponding USB_STS bit in ACPI space. If USB is enabled as a wake/break event, the system wakes up and an SCI generated.

5.18.8 USB Legacy Keyboard Operation

When a USB keyboard is plugged into the system, and a standard keyboard is not, the system may not boot, and MS-DOS legacy software will not run, because the keyboard will not be identified. The ICH10 implements a series of trapping operations which will snoop accesses that go to the keyboard controller, and put the expected data from the USB keyboard into the keyboard controller.

Note: The scheme described below assumes that the keyboard controller (8042 or equivalent) is on the LPC bus.

This legacy operation is performed through SMM space. [Figure 5-13](#) shows the Enable and Status path. The latched SMI source (60R, 60W, 64R, 64W) is available in the Status Register. Because the enable is after the latch, it is possible to check for other events that didn't necessarily cause an SMI. It is the software's responsibility to logically AND the value with the appropriate enable bits.

Note also that the SMI is generated before the PCI cycle completes (e.g., before TRDY# goes active) to ensure that the processor doesn't complete the cycle before the SMI is observed.

The logic also needs to block the accesses to the 8042. If there is an external 8042, then this is simply accomplished by not activating the 8042 CS. This is done by logically ANDing the four enables (60R, 60W, 64R, 64W) with the 4 types of accesses to determine if 8042CS should go active. An additional term is required for the "pass-through" case.

The state table for [Figure 5-13](#) is shown in [Table 5-45](#).

Figure 5-13. USB Legacy Keyboard Flow Diagram

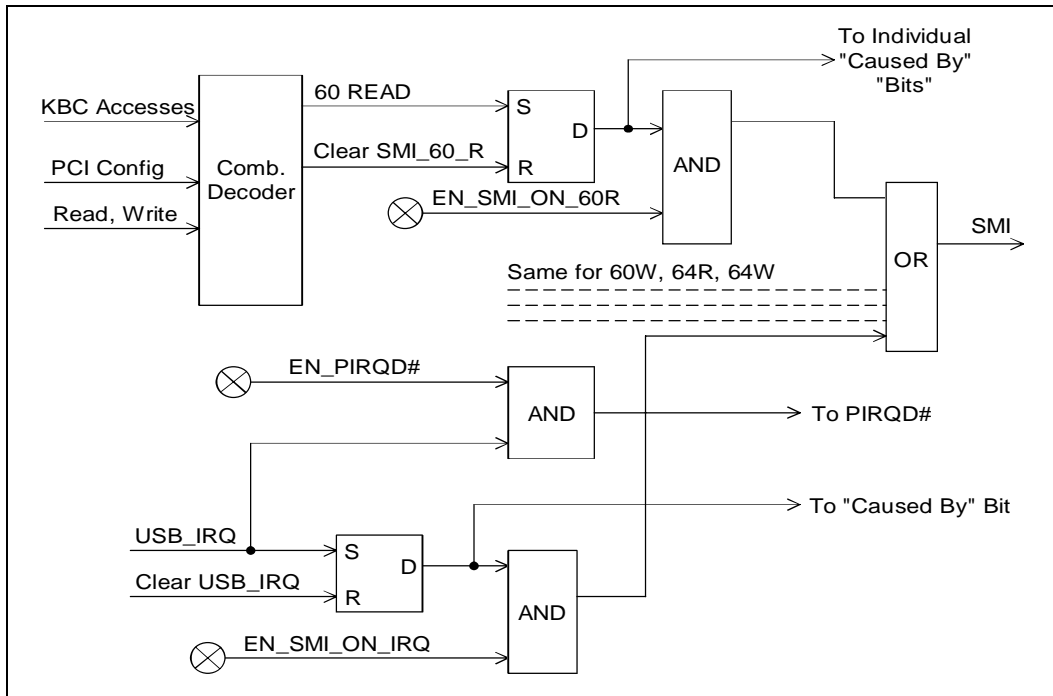

Table 5-45. USB Legacy Keyboard State Transitions (Sheet 1 of 2)

| Current State | Action | Data Value | Next State | Comment |
|---------------|-------------|------------|------------|--------------------------------------------------------------------------------------------------------------------------------------------------------------------------------------------|
| IDLE | 64h / Write | D1h | GateState1 | Standard D1 command. Cycle passed through to 8042. SMI# doesn't go active. PSTATE (offset C0, bit 6) goes to 1. |
| IDLE | 64h / Write | Not D1h | IDLE | Bit 3 in Config Register determines if cycle passed through to 8042 and if SMI# generated. |
| IDLE | 64h / Read | N/A | IDLE | Bit 2 in Config Register determines if cycle passed through to 8042 and if SMI# generated. |
| IDLE | 60h / Write | Don't Care | IDLE | Bit 1 in Config Register determines if cycle passed through to 8042 and if SMI# generated. |
| IDLE | 60h / Read | N/A | IDLE | Bit 0 in Config Register determines if cycle passed through to 8042 and if SMI# generated. |
| GateState1 | 60h / Write | XXh | GateState2 | Cycle passed through to 8042, even if trap enabled in Bit 1 in Config Register. No SMI# generated. PSTATE remains 1. If data value is not DFh or DDh then the 8042 may chose to ignore it. |



Table 5-45. USB Legacy Keyboard State Transitions (Sheet 2 of 2)

| Current State | Action | Data Value | Next State | Comment |
|---------------|-------------|------------|------------|--------------------------------------------------------------------------------------------------------------------------------------------------------------------------------------------------------------|
| GateState1 | 64h / Write | D1h | GateState1 | Cycle passed through to 8042, even if trap enabled via Bit 3 in Config Register. No SMI# generated. PSTATE remains 1. Stay in GateState1 because this is part of the double-trigger sequence. |
| GateState1 | 64h / Write | Not D1h | ILDE | Bit 3 in Config space determines if cycle passed through to 8042 and if SMI# generated. PSTATE goes to 0. If Bit 7 in Config Register is set, then SMI# should be generated. |
| GateState1 | 60h / Read | N/A | IDLE | This is an invalid sequence. Bit 0 in Config Register determines if cycle passed through to 8042 and if SMI# generated. PSTATE goes to 0. If Bit 7 in Config Register is set, then SMI# should be generated. |
| GateState1 | 64h / Read | N/A | GateState1 | Just stay in same state. Generate an SMI# if enabled in Bit 2 of Config Register. PSTATE remains 1. |
| GateState2 | 64 / Write | FFh | IDLE | Standard end of sequence. Cycle passed through to 8042. PSTATE goes to 0. Bit 7 in Config Space determines if SMI# should be generated. |
| GateState2 | 64h / Write | Not FFh | IDLE | Improper end of sequence. Bit 3 in Config Register determines if cycle passed through to 8042 and if SMI# generated. PSTATE goes to 0. If Bit 7 in Config Register is set, then SMI# should be generated. |
| GateState2 | 64h / Read | N/A | GateState2 | Just stay in same state. Generate an SMI# if enabled in Bit 2 of Config Register. PSTATE remains 1. |
| GateState2 | 60h / Write | XXh | IDLE | Improper end of sequence. Bit 1 in Config Register determines if cycle passed through to 8042 and if SMI# generated. PSTATE goes to 0. If Bit 7 in Config Register is set, then SMI# should be generated. |
| GateState2 | 60h / Read | N/A | IDLE | Improper end of sequence. Bit 0 in Config Register determines if cycle passed through to 8042 and if SMI# generated. PSTATE goes to 0. If Bit 7 in Config Register is set, then SMI# should be generated. |



5.18.9 Function Level Reset Support (FLR)

The USB UHCI Controllers support the Function Level Reset (FLR) capability. The FLR capability can be used in conjunction with Intel Virtualization Technology. FLR allows an Operating System in a Virtual Machine to have complete control over a device, including its initialization, without interfering with the rest of the platform. The device provides a software interface that enables the Operating System to reset the whole device as if a PCI reset was asserted.

5.18.9.1 FLR Steps

5.18.9.1.1 FLR Initialization

1. A FLR is initiated by software writing a 1 to the Initiate FLR bit.
2. All subsequent requests targeting the Function will not be claimed and will be Master Abort Immediate on the bus. This includes any configuration, I/O or Memory cycles, however, the Function shall continue to accept completions targeting the Function.

5.18.9.1.2 FLR Operation

The Function will Reset all configuration, I/O and memory registers of the Function except those indicated otherwise and reset all internal states of the Function to the default or initial condition.

5.18.9.1.3 FLR Completion

The Initiate FLR bit is reset (cleared) when the FLR reset is completed. This bit can be used to indicate to the software that the FLR reset is completed.

Note: From the time Initiate FLR bit is written to 1, software must wait at least 100 ms before accessing the function.

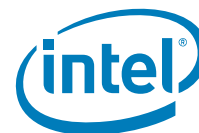

5.19 USB EHCI Host Controllers (D29:F7 and D26:F7)

The ICH10 contains two Enhanced Host Controller Interface (EHCI) host controllers which support up to twelve USB 2.0 high-speed root ports. USB 2.0 allows data transfers up to 480 Mb/s using the same pins as the twelve USB full-speed/low-speed ports. The ICH10 contains port-routing logic that determines whether a USB port is controlled by one of the UHCI controllers or by one of the EHCI controllers. USB 2.0 based Debug Port is also implemented in the ICH10.

A summary of the key architectural differences between the USB UHCI host controllers and the EHCI host controller are shown in [Table 5-46](#).

Table 5-46. UHCI vs. EHCI

| Parameter | USB UHCI | USB EHCI |
|--------------------------------|--------------------|---------------------------------------------------|
| Accessible by | I/O space | Memory Space |
| Memory Data Structure | Single linked list | Separated into Periodic and Asynchronous lists |
| Differential Signaling Voltage | 3.3 V | 400 mV |
| Ports per Controller | 2 | 6 or 8 (controller #1) and 6 or 4 (Controller #2) |

5.19.1 EHC Initialization

The following descriptions step through the expected ICH10 Enhanced Host Controller (EHC) initialization sequence in chronological order, beginning with a complete power cycle in which the suspend well and core well have been off.

5.19.1.1 BIOS Initialization

BIOS performs a number of platform customization steps after the core well has powered up. Contact your Intel Field Representative for additional ICH10 BIOS information.

5.19.1.2 Driver Initialization

See Chapter 4 of the *Enhanced Host Controller Interface Specification for Universal Serial Bus*, Revision 1.0.



5.19.1.3 EHC Resets

In addition to the standard ICH10 hardware resets, portions of the EHC are reset by the HCRESET bit and the transition from the D3_{HOT} device power management state to the D0 state. The effects of each of these resets are:

| Reset | Does Reset | Does not Reset | Comments |
|----------------------------------------------------------------------------------|---------------------------------------------------------------------------------|--------------------------------------------------------------|--------------------------------------------------------------------------------------------------------------------------------------------------------------------------------------------------------|
| HCRESET bit set. | Memory space registers except Structural Parameters (which is written by BIOS). | Configuration registers. | The HCRESET must only affect registers that the EHCI driver controls. PCI Configuration space and BIOS-programmed parameters can not be reset. |
| Software writes the Device Power State from D3 _{HOT} (11b) to D0 (00b). | Core well registers (except BIOS-programmed registers). | Suspend well registers; BIOS-programmed core well registers. | The D3-to-D0 transition must not cause wake information (suspend well) to be lost. It also must not clear BIOS-programmed registers because BIOS may not be invoked following the D3-to-D0 transition. |

If the detailed register descriptions give exceptions to these rules, those exceptions override these rules. This summary is provided to help explain the reasons for the reset policies.

5.19.2 Data Structures in Main Memory

See Section 3 and Appendix B of the *Enhanced Host Controller Interface Specification for Universal Serial Bus*, Revision 1.0 for details.

5.19.3 USB 2.0 Enhanced Host Controller DMA

The ICH10 USB 2.0 EHC implements three sources of USB packets. They are, in order of priority on USB during each microframe:

1. The USB 2.0 Debug Port (see Section USB 2.0 Based Debug Port),
2. The Periodic DMA engine, and
3. The Asynchronous DMA engine.

The ICH10 always performs any currently-pending debug port transaction at the beginning of a microframe, followed by any pending periodic traffic for the current microframe. If there is time left in the microframe, then the EHC performs any pending asynchronous traffic until the end of the microframe (EOF1). Note that the debug port traffic is only presented on one port (Port #0), while the other ports are idle during this time.

5.19.4 Data Encoding and Bit Stuffing

See Chapter 8 of the *Universal Serial Bus Specification, Revision 2.0*.



5.19.5 Packet Formats

See Chapter 8 of the *Universal Serial Bus Specification, Revision 2.0*.

The ICH10 EHCI allows entrance to USB test modes, as defined in the USB 2.0 specification, including Test J, Test Packet, etc. However note that the ICH10 Test Packet test mode interpacket gap timing may not meet the USB 2.0 specification.

5.19.6 USB 2.0 Interrupts and Error Conditions

Section 4 of the *Enhanced Host Controller Interface Specification for Universal Serial Bus, Revision 1.0* goes into detail on the EHC interrupts and the error conditions that cause them. All error conditions that the EHC detects can be reported through the EHCI Interrupt status bits. Only ICH10-specific interrupt and error-reporting behavior is documented in this section. The EHCI Interrupts Section must be read first, followed by this section of the datasheet to fully comprehend the EHC interrupt and error-reporting functionality.

- Based on the EHC's Buffer sizes and buffer management policies, the Data Buffer Error can never occur on the ICH10.
- Master Abort and Target Abort responses from hub interface on EHC-initiated read packets will be treated as Fatal Host Errors. The EHC halts when these conditions are encountered.
- The ICH10 may assert the interrupts which are based on the interrupt threshold as soon as the status for the last complete transaction in the interrupt interval has been posted in the internal write buffers. The requirement in the *Enhanced Host Controller Interface Specification for Universal Serial Bus, Revision 1.0* (that the status is written to memory) is met internally, even though the write may not be seen on DMI before the interrupt is asserted.
- Since the ICH10 supports the 1024-element Frame List size, the Frame List Rollover interrupt occurs every 1024 milliseconds.
- The ICH10 delivers interrupts using PIRQ#.
- The ICH10 does not modify the CERR count on an Interrupt IN when the "Do Complete-Split" execution criteria are not met.
- For complete-split transactions in the Periodic list, the "Missed Microframe" bit does not get set on a control-structure-fetch that fails the late-start test. If subsequent accesses to that control structure do not fail the late-start test, then the "Missed Microframe" bit will get set and written back.

5.19.6.1 Aborts on USB 2.0-Initiated Memory Reads

If a read initiated by the EHC is aborted, the EHC treats it as a fatal host error. The following actions are taken when this occurs:

- The Host System Error status bit is set
- The DMA engines are halted after completing up to one more transaction on the USB interface
- If enabled (by the Host System Error Enable), then an interrupt is generated
- If the status is Master Abort, then the Received Master Abort bit in configuration space is set
- If the status is Target Abort, then the Received Target Abort bit in configuration space is set
- If enabled (by the SERR Enable bit in the function's configuration space), then the Signaled System Error bit in configuration bit is set.

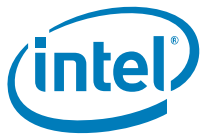

5.19.7 USB 2.0 Power Management

5.19.7.1 Pause Feature

This feature allows platforms to dynamically enter low-power states during brief periods when the system is idle (i.e., between keystrokes). This is useful for enabling power management features in the ICH10. The policies for entering these states typically are based on the recent history of system bus activity to incrementally enter deeper power management states. Normally, when the EHC is enabled, it regularly accesses main memory while traversing the DMA schedules looking for work to do; this activity is viewed by the power management software as a non-idle system, thus preventing the power managed states to be entered. Suspending all of the enabled ports can prevent the memory accesses from occurring, but there is an inherent latency overhead with entering and exiting the suspended state on the USB ports that makes this unacceptable for the purpose of dynamic power management. As a result, the EHCI software drivers are allowed to pause the EHC's DMA engines when it knows that the traffic patterns of the attached devices can afford the delay. The pause only prevents the EHC from generating memory accesses; the SOF packets continue to be generated on the USB ports (unlike the suspended state).

5.19.7.2 Suspend Feature

The *Enhanced Host Controller Interface (EHCI) For Universal Serial Bus Specification*, Section 4.3 describes the details of Port Suspend and Resume.

5.19.7.3 ACPI Device States

The USB 2.0 function only supports the D0 and D3 PCI Power Management states. Notes regarding the ICH10 implementation of the Device States:

1. The EHC hardware does not inherently consume any more power when it is in the D0 state than it does in the D3 state. However, software is required to suspend or disable all ports prior to entering the D3 state such that the maximum power consumption is reduced.
2. In the D0 state, all implemented EHC features are enabled.
3. In the D3 state, accesses to the EHC memory-mapped I/O range will master abort. Note that, since the Debug Port uses the same memory range, the Debug Port is only operational when the EHC is in the D0 state.
4. In the D3 state, the EHC interrupt must never assert for any reason. The internal PME# signal is used to signal wake events, etc.
5. When the Device Power State field is written to D0 from D3, an internal reset is generated. See section EHC Resets for general rules on the effects of this reset.
6. Attempts to write any other value into the Device Power State field other than 00b (D0 state) and 11b (D3 state) will complete normally without changing the current value in this field.



5.19.7.4 ACPI System States

The EHC behavior as it relates to other power management states in the system is summarized in the following list:

- The System is always in the S0 state when the EHC is in the D0 state. However, when the EHC is in the D3 state, the system may be in any power management state (including S0).
- When in D0, the Pause feature (See [Section 5.19.7.1](#)) enables dynamic processor low-power states to be entered.
- The PLL in the EHC is disabled when entering the S3/S4/S5 states (core power turns off).
- All core well logic is reset in the S3/S4/S5 states.

5.19.8 Interaction with UHCI Host Controllers

The Enhanced Host controllers share its ports with UHCI Host controllers in the ICH10. The UHC at D29:F0 shares ports 0 and 1; the UHC at D29:F1 shares ports 2 and 3; the UHC at D29:F2 shares ports 4 and 5 with the EHC at D29:F7, while the UHC at D26:F0 shares ports 6 and 7, the UHC at D26:F1 shares ports 8 and 9, and the UHC at D26:F2 shares ports 10 and 11 with EHC at D26:F7. There is very little interaction between the Enhanced and the UHCI controllers other than the muxing control which is provided as part of the EHC. [Figure 5-14](#) shows the USB Port Connections at a conceptual level.

Note: D26:F2 can be configured as D29:F3 during BIOS post.

5.19.8.1 Port-Routing Logic

Integrated into the EHC functionality is port-routing logic, which performs the muxing between the UHCI and EHCI host controllers. The ICH10 conceptually implements this logic as described in Section 4.2 of the *Enhanced Host Controller Interface Specification for Universal Serial Bus*, Revision 1.0. If a device is connected that is not capable of USB 2.0's high-speed signaling protocol or if the EHCI software drivers are not present as indicated by the Configured Flag, then the UHCI controller owns the port. Owning the port means that the differential output is driven by the owner and the input stream is only visible to the owner. The host controller that is not the owner of the port internally sees a disconnected port.

Figure 5-14. Intel® ICH10-USB Port Connections Default Six and Six Configuration

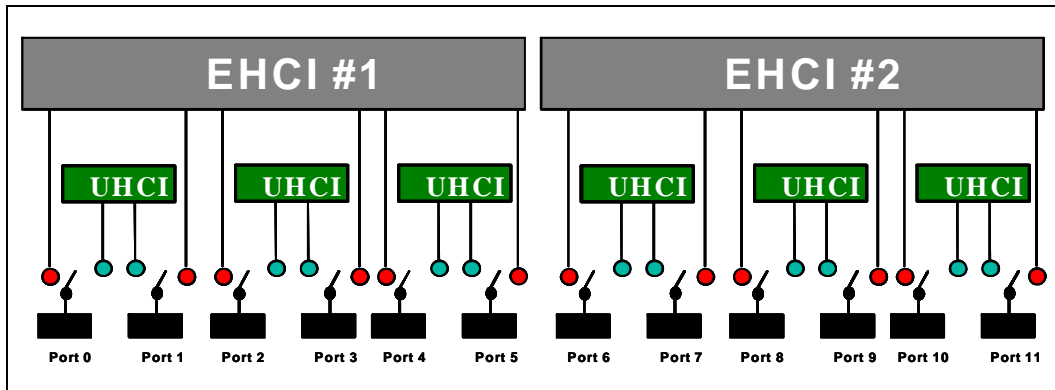
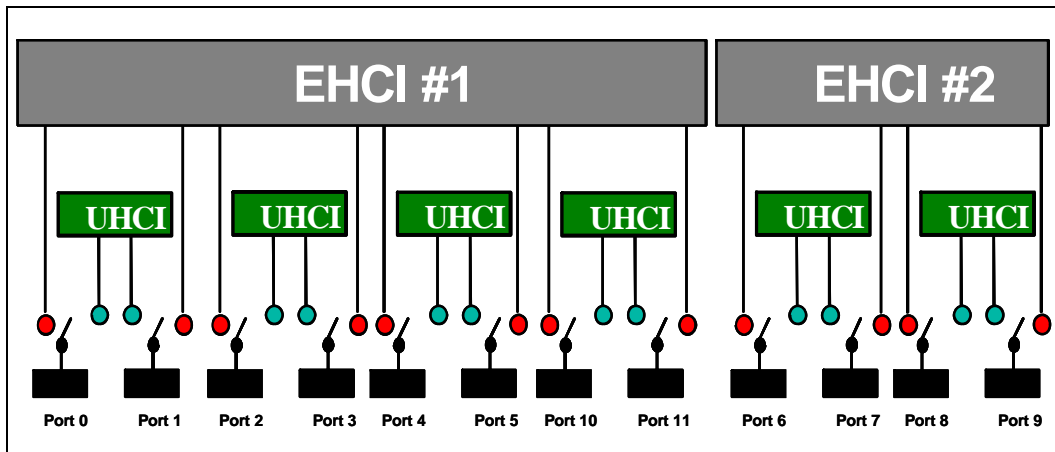

Figure 5-15. Intel® ICH10-USB Port Connections Eight and Four Configuration



Note that the port-routing logic is the only block of logic within the ICH10 that observes the physical (real) connect/disconnect information. The port status logic inside each of the host controllers observes the electrical connect/disconnect information that is generated by the port-routing logic.

Only the differential signal pairs are multiplexed/de-multiplexed between the UHCI and EHCI host controllers. The other USB functional signals are handled as follows:

- The Overcurrent inputs (OC[11:0]#) are directly routed to both controllers. An overcurrent event is recorded in both controllers' status registers.

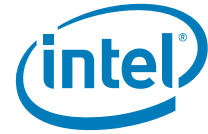

The Port-Routing logic is implemented in the Suspend power well so that re-enumeration and re-mapping of the USB ports is not required following entering and exiting a system sleep state in which the core power is turned off.

The ICH10 also allows the USB Debug Port traffic to be routed in and out of Port #0 and Port #6. When in this mode, the Enhanced Host controller is the owner of Port #0 and Port #6.

5.19.8.2 Device Connects

The *Enhanced Host Controller Interface Specification for Universal Serial Bus*, Revision 1.0 describes the details of handling Device Connects in Section 4.2. There are four general scenarios that are summarized below.

1. Configure Flag = 0 and a full-speed/low-speed-only Device is connected
 - In this case, the UHC is the owner of the port both before and after the connect occurs. The EHC (except for the port-routing logic) never sees the connect occur. The UHCI driver handles the connection and initialization process.
2. Configure Flag = 0 and a high-speed-capable Device is connected
 - In this case, the UHC is the owner of the port both before and after the connect occurs. The EHC (except for the port-routing logic) never sees the connect occur. The UHCI driver handles the connection and initialization process. Since the UHC does not perform the high-speed chirp handshake, the device operates in compatible mode.
3. Configure Flag = 1 and a full-speed/low-speed-only Device is connected
 - In this case, the EHC is the owner of the port before the connect occurs. The EHCI driver handles the connection and performs the port reset. After the reset process completes, the EHC hardware has cleared (not set) the Port Enable bit in the EHC's PORTSC register. The EHCI driver then writes a 1 to the Port Owner bit in the same register, causing the UHC to see a connect event and the EHC to see an "electrical" disconnect event. The UHCI driver and hardware handle the connection and initialization process from that point on. The EHCI driver and hardware handle the perceived disconnect.
4. Configure Flag = 1 and a high-speed-capable Device is connected
 - In this case, the EHC is the owner of the port before, and remains the owner after, the connect occurs. The EHCI driver handles the connection and performs the port reset. After the reset process completes, the EHC hardware has set the Port Enable bit in the EHC's PORTSC register. The port is functional at this point. The UHC continues to see an unconnected port.



5.19.8.3 Device Disconnects

The *Enhanced Host Controller Interface Specification for Universal Serial Bus*, Revision 1.0 describes the details of handling Device Disconnects in Section 4.2. There are three general scenarios that are summarized below.

1. Configure Flag = 0 and the device is disconnected
 - In this case, the UHC is the owner of the port both before and after the disconnect occurs. The EHC (except for the port-routing logic) never sees a device attached. The UHCI driver handles disconnection process.
2. Configure Flag = 1 and a full-speed/low-speed-capable Device is disconnected
 - In this case, the UHC is the owner of the port before the disconnect occurs. The disconnect is reported by the UHC and serviced by the associated UHCI driver. The port-routing logic in the EHC cluster forces the Port Owner bit to 0, indicating that the EHC owns the unconnected port.
3. Configure Flag = 1 and a high-speed-capable Device is disconnected
 - In this case, the EHC is the owner of the port before, and remains the owner after, the disconnect occurs. The EHCI hardware and driver handle the disconnection process. The UHC never sees a device attached.

5.19.8.4 Effect of Resets on Port-Routing Logic

As mentioned above, the Port Routing logic is implemented in the suspend power well so that remuneration and re-mapping of the USB ports is not required following entering and exiting a system sleep state in which the core power is turned off.

| Reset Event | Effect on Configure Flag | Effect on Port Owner Bits |
|--------------------|--------------------------|---------------------------|
| Suspend Well Reset | cleared (0) | set (1) |
| Core Well Reset | no effect | no effect |
| D3-to-D0 Reset | no effect | no effect |
| HCRESET | cleared (0) | set (1) |

5.19.9 USB 2.0 Legacy Keyboard Operation

The ICH10 must support the possibility of a keyboard downstream from either a full-speed/low-speed or a high-speed port. The description of the legacy keyboard support is unchanged from USB 1.1 (See [Section 5.18.8](#)).

The EHC provides the basic ability to generate SMIs on an interrupt event, along with more sophisticated control of the generation of SMIs.



5.19.10 USB 2.0 Based Debug Port

The ICH10 supports the elimination of the legacy COM ports by providing the ability for new debugger software to interact with devices on a USB 2.0 port.

High-level restrictions and features are:

- Operational before USB 2.0 drivers are loaded.
- Functions even when the port is disabled.
- Works even though non-configured port is default-routed to the UHCI. Note that the Debug Port can not be used to debug an issue that requires a full-speed/low-speed device on Port #0 using the UHCI drivers.
- Allows normal system USB 2.0 traffic in a system that may only have one USB port.
- Debug Port device (DPD) must be high-speed capable and connect directly to Port #0 and Port #6 on ICH10 systems (e.g., the DPD cannot be connected to Port #0/Port #6 through a hub).
- Debug Port FIFO always makes forward progress (a bad status on USB is simply presented back to software).
- The Debug Port FIFO is only given one USB access per microframe.

The Debug port facilitates operating system and device driver debug. It allows the software to communicate with an external console using a USB 2.0 connection. Because the interface to this link does not go through the normal USB 2.0 stack, it allows communication with the external console during cases where the operating system is not loaded, the USB 2.0 software is broken, or where the USB 2.0 software is being debugged. Specific features of this implementation of a debug port are:

- Only works with an external USB 2.0 debug device (console)
- Implemented for a specific port on the host controller
- Operational anytime the port is not suspended AND the host controller is in D0 power state.
- Capability is interrupted when port is driving USB RESET

5.19.10.1 Theory of Operation

There are two operational modes for the USB debug port:

1. Mode 1 is when the USB port is in a disabled state from the viewpoint of a standard host controller driver. In Mode 1, the Debug Port controller is required to generate a “keepalive” packets less than 2 ms apart to keep the attached debug device from suspending. The keepalive packet should be a standalone 32-bit SYNC field.
2. Mode 2 is when the host controller is running (i.e., host controller’s *Run/Stop#* bit is 1). In Mode 2, the normal transmission of SOF packets will keep the debug device from suspending.

Behavioral Rules

1. In both modes 1 and 2, the Debug Port controller must check for software requested debug transactions at least every 125 microseconds.
2. If the debug port is enabled by the debug driver, and the standard host controller driver resets the USB port, USB debug transactions are held off for the duration of the reset and until after the first SOF is sent.
3. If the standard host controller driver suspends the USB port, then USB debug transactions are held off for the duration of the suspend/resume sequence and until after the first SOF is sent.
4. The ENABLED_CNT bit in the debug register space is independent of the similar port control bit in the associated Port Status and Control register.

Table 5-47 shows the debug port behavior related to the state of bits in the debug registers as well as bits in the associated Port Status and Control register.

Table 5-47. Debug Port Behavior

| OWNER_CNT | ENABLED_CT | Port Enable | Run / Stop | Suspend | Debug Port Behavior |
|-----------|------------|-------------|------------|---------|--------------------------------------------------------------------------------------------------------------------------------------------------------------------------------------|
| 0 | X | X | X | X | Debug port is not being used. Normal operation. |
| 1 | 0 | X | X | X | Debug port is not being used. Normal operation. |
| 1 | 1 | 0 | 0 | X | Debug port in Mode 1. SYNC keepalives sent plus debug traffic |
| 1 | 1 | 0 | 1 | X | Debug port in Mode 2. SOF (and only SOF) is sent as keepalive. Debug traffic is also sent. Note that no other normal traffic is sent out this port, because the port is not enabled. |
| 1 | 1 | 1 | 0 | 0 | invalid. Host controller driver should never put controller into this state (enabled, not running and not suspended). |
| 1 | 1 | 1 | 0 | 1 | Port is suspended. No debug traffic sent. |
| 1 | 1 | 1 | 1 | 0 | Debug port in Mode 2. Debug traffic is interspersed with normal traffic. |
| 1 | 1 | 1 | 1 | 1 | Port is suspended. No debug traffic sent. |

5.19.10.1.1 OUT Transactions

An Out transaction sends data to the debug device. It can occur only when the following are true:

- The debug port is enabled
- The debug software sets the GO_CNT bit
- The WRITE_READ#_CNT bit is set

The sequence of the transaction is:

1. Software sets the appropriate values in the following bits:
 - USB_ADDRESS_CNF
 - USB_ENDPOINT_CNF
 - DATA_BUFFER[63:0]
 - TOKEN_PID_CNT[7:0]
 - SEND_PID_CNT[15:8]
 - DATA_LEN_CNT
 - WRITE_READ#_CNT: (note: this will always be 1 for OUT transactions)
 - GO_CNT: (note: this will always be 1 to initiate the transaction)



2. The debug port controller sends a token packet consisting of:
 - SYNC
 - TOKEN_PID_CNT field
 - USB_ADDRESS_CNT field
 - USB_ENDPOINT_CNT field
 - 5-bit CRC field
3. After sending the token packet, the debug port controller sends a data packet consisting of:
 - SYNC
 - SEND_PID_CNT field
 - The number of data bytes indicated in DATA_LEN_CNT from the DATA_BUFFER
 - 16-bit CRC

NOTE: 'A DATA_LEN_CNT value of 0 is valid in which case no data bytes would be included in the packet.
4. After sending the data packet, the controller waits for a handshake response from the debug device.
 - If a handshake is received, the debug port controller:
 - a. Places the received PID in the RECEIVED_PID_STS field
 - b. Resets the ERROR_GOOD#_STS bit
 - c. Sets the DONE_STS bit
 - If no handshake PID is received, the debug port controller:
 - a. Sets the EXCEPTION_STS field to 001b
 - b. Sets the ERROR_GOOD#_STS bit
 - c. Sets the DONE_STS bit

5.19.10.1.2 IN Transactions

An IN transaction receives data from the debug device. It can occur only when the following are true:

- The debug port is enabled
- The debug software sets the GO_CNT bit
- The WRITE_READ#_CNT bit is reset

The sequence of the transaction is:

1. Software sets the appropriate values in the following bits:
 - USB_ADDRESS_CNF
 - USB_ENDPOINT_CNF
 - TOKEN_PID_CNT[7:0]
 - DATA_LEN_CNT
 - WRITE_READ#_CNT: (Note: This will always be 0 for IN transactions.)
 - GO_CNT: (Note: This will always be 1 to initiate the transaction.)

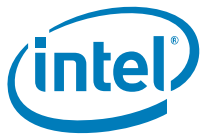

2. The debug port controller sends a token packet consisting of:
 - SYNC
 - TOKEN_PID_CNT field
 - USB_ADDRESS_CNT field
 - USB_ENDPOINT_CNT field
 - 5-bit CRC field.
3. After sending the token packet, the debug port controller waits for a response from the debug device.
If a response is received:
 - The received PID is placed into the RECEIVED_PID_STS field
 - Any subsequent bytes are placed into the DATA_BUFFER
 - The DATA_LEN_CNT field is updated to show the number of bytes that were received after the PID.
4. If a valid packet was received from the device that was one byte in length (indicating it was a handshake packet), then the debug port controller:
 - Resets the ERROR_GOOD#_STS bit
 - Sets the DONE_STS bit
5. If a valid packet was received from the device that was more than one byte in length (indicating it was a data packet), then the debug port controller:
 - Transmits an ACK handshake packet
 - Resets the ERROR_GOOD#_STS bit
 - Sets the DONE_STS bit
6. If no valid packet is received, then the debug port controller:
 - Sets the EXCEPTION_STS field to 001b
 - Sets the ERROR_GOOD#_STS bit
 - Sets the DONE_STS bit.

5.19.10.1.3 Debug Software

Enabling the Debug Port

There are two mutually exclusive conditions that debug software must address as part of its startup processing:

- The EHCI has been initialized by system software
- The EHCI has not been initialized by system software

Debug software can determine the current 'initialized' state of the EHCI by examining the Configure Flag in the EHCI USB 2.0 Command Register. If this flag is set, then system software has initialized the EHCI. Otherwise the EHCI should not be considered initialized. Debug software will initialize the debug port registers depending on the state of the EHCI. However, before this can be accomplished, debug software must determine which root USB port is designated as the debug port.

Determining the Debug Port

Debug software can easily determine which USB root port has been designated as the debug port by examining bits 20:23 of the EHCI Host Controller Structural Parameters register. This 4-bit field represents the numeric value assigned to the debug port (i.e., 0000 = port 0).



Debug Software Startup with Non-Initialized EHCI

Debug software can attempt to use the debug port if after setting the OWNER_CNT bit, the Current Connect Status bit in the appropriate (See Determining the Debug Port) PORTSC register is set. If the Current Connect Status bit is not set, then debug software may choose to terminate or it may choose to wait until a device is connected.

If a device is connected to the port, then debug software must reset/enable the port. Debug software does this by setting and then clearing the Port Reset bit the PORTSC register. To ensure a successful reset, debug software should wait at least 50 ms before clearing the Port Reset bit. Due to possible delays, this bit may not change to 0 immediately; reset is complete when this bit reads as 0. Software must not continue until this bit reads 0.

If a high-speed device is attached, the EHCI will automatically set the Port Enabled/Disabled bit in the PORTSC register and the debug software can proceed. Debug software should set the ENABLED_CNT bit in the Debug Port Control/Status register, and then reset (clear) the Port Enabled/Disabled bit in the PORTSC register (so that the system host controller driver does not see an enabled port when it is first loaded).

Debug Software Startup with Initialized EHCI

Debug software can attempt to use the debug port if the Current Connect Status bit in the appropriate (See Determining the Debug Port) PORTSC register is set. If the Current Connect Status bit is not set, then debug software may choose to terminate or it may choose to wait until a device is connected.

If a device is connected, then debug software must set the OWNER_CNT bit and then the ENABLED_CNT bit in the Debug Port Control/Status register.

Determining Debug Peripheral Presence

After enabling the debug port functionality, debug software can determine if a debug peripheral is attached by attempting to send data to the debug peripheral. If all attempts result in an error (Exception bits in the Debug Port Control/Status register indicates a Transaction Error), then the attached device is not a debug peripheral. If the debug port peripheral is not present, then debug software may choose to terminate or it may choose to wait until a debug peripheral is connected.

5.19.11 USB Pre-Fetch Based Pause

The Pre-Fetch Based Pause is a power management feature in USB (EHCI) host controllers to ensure maximum C3/C4 processor power state time with C2 popup. This feature applies to the period schedule, and works by allowing the DMA engine to identify periods of idleness and preventing the DMA engine from accessing memory when the periodic schedule is idle. Typically in the presence of periodic devices with multiple millisecond poll periods, the periodic schedule will be idle for several frames between polls.

The USB Pre-Fetch Based Pause feature is disabled by setting bit 4 of EHCI Configuration Register [Section 17.1.30](#).

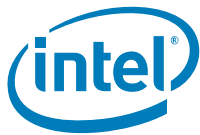

5.19.12 Function Level Reset Support (FLR)

The USB EHCI Controllers support the Function Level Reset (FLR) capability. The FLR capability can be used in conjunction with Intel Virtualization Technology. FLR allows an Operating System in a Virtual Machine to have complete control over a device, including its initialization, without interfering with the rest of the platform. The device provides a software interface that enables the Operating System to reset the whole device as if a PCI reset was asserted.

5.19.12.1 FLR Steps

5.19.12.1.1 FLR Initialization

1. A FLR is initiated by software writing a '1' to the Initiate FLR bit.
2. All subsequent requests targeting the Function will not be claimed and will be Master Abort Immediate on the bus. This includes any configuration, I/O or Memory cycles, however, the Function shall continue to accept completions targeting the Function.

5.19.12.1.2 FLR Operation

The Function will Reset all configuration, I/O and memory registers of the Function except those indicated otherwise and reset all internal states of the Function to the default or initial condition.

5.19.12.1.3 FLR Completion

The Initiate FLR bit is reset (cleared) when the FLR reset is completed. This bit can be used to indicate to the software that the FLR reset is completed.

Note: From the time Initiate FLR bit is written to 1, software must wait at least 100 ms before accessing the function.

5.20 SMBus Controller (D31:F3)

The ICH10 provides an System Management Bus (SMBus) 2.0 host controller as well as an SMBus Slave Interface. The host controller provides a mechanism for the processor to initiate communications with SMBus peripherals (slaves). The ICH10 is also capable of operating in a mode in which it can communicate with I²C compatible devices.

The ICH10 can perform SMBus messages with either packet error checking (PEC) enabled or disabled. The actual PEC calculation and checking is performed in hardware by the ICH10.

The Slave Interface allows an external master to read from or write to the ICH10. Write cycles can be used to cause certain events or pass messages, and the read cycles can be used to determine the state of various status bits. The ICH10's internal host controller cannot access the ICH10's internal Slave Interface.

The ICH10 SMBus logic exists in Device 31:Function 3 configuration space, and consists of a transmit data path, and host controller. The transmit data path provides the data flow logic needed to implement the seven different SMBus command protocols and is controlled by the host controller. The ICH10 SMBus controller logic is clocked by RTC clock.

The SMBus Address Resolution Protocol (ARP) is supported by using the existing host controller commands through software, except for the new Host Notify command (which is actually a received message).



The programming model of the host controller is combined into two portions: a PCI configuration portion, and a system I/O mapped portion. All static configuration, such as the I/O base address, is done via the PCI configuration space. Real-time programming of the Host interface is done in system I/O space.

The ICH10 SMBus host controller checks for parity errors as a target. If an error is detected, the detected parity error bit in the PCI Status Register (Device 31:Function 3:Offset 06h:bit 15) is set. If bit 6 and bit 8 of the PCI Command Register (Device 31:Function 3:Offset 04h) are set, an SERR# is generated and the signaled SERR# bit in the PCI Status Register (bit 14) is set.

5.20.1 Host Controller

The SMBus host controller is used to send commands to other SMBus slave devices. Software sets up the host controller with an address, command, and, for writes, data and optional PEC; and then tells the controller to start. When the controller has finished transmitting data on writes, or receiving data on reads, it generates an SMI# or interrupt, if enabled.

The host controller supports 8 command protocols of the SMBus interface (see *System Management Bus (SMBus) Specification, Version 2.0*): Quick Command, Send Byte, Receive Byte, Write Byte/Word, Read Byte/Word, Process Call, Block Read/Write, Block Write–Block Read Process Call, and Host Notify.

The SMBus host controller requires that the various data and command fields be setup for the type of command to be sent. When software sets the START bit, the SMBus Host controller performs the requested transaction, and interrupts the processor (or generates an SMI#) when the transaction is completed. Once a START command has been issued, the values of the “active registers” (Host Control, Host Command, Transmit Slave Address, Data 0, Data 1) should not be changed or read until the interrupt status bit (INTR) has been set (indicating the completion of the command). Any register values needed for computation purposes should be saved prior to issuing of a new command, as the SMBus host controller updates all registers while completing the new command.

The ICH10 supports the *System Management Bus (SMBus) Specification, Version 2.0*. Slave functionality, including the Host Notify protocol, is available on the SMBus pins. The SMLink and SMBus signals can be tied together externally depending on TCO mode used. Refer to [Section 5.14.2](#) for more details.

Using the SMB host controller to send commands to the ICH10's SMB slave port is not supported.

5.20.1.1 Command Protocols

In all of the following commands, the Host Status Register (offset 00h) is used to determine the progress of the command. While the command is in operation, the HOST_BUSY bit is set. If the command completes successfully, the INTR bit will be set in the Host Status Register. If the device does not respond with an acknowledge, and the transaction times out, the DEV_ERR bit is set. If software sets the KILL bit in the Host Control Register while the command is running, the transaction will stop and the FAILED bit will be set.

Quick Command

When programmed for a Quick Command, the Transmit Slave Address Register is sent. The PEC byte is never appended to the Quick Protocol. Software should force the PEC_EN bit to 0 when performing the Quick Command. Software must force the I2C_EN bit to 0 when running this command. See section 5.5.1 of the *System Management Bus (SMBus) Specification, Version 2.0* for the format of the protocol.



Send Byte / Receive Byte

For the Send Byte command, the Transmit Slave Address and Device Command Registers are sent.

For the Receive Byte command, the Transmit Slave Address Register is sent. The data received is stored in the DATA0 register. Software must force the I2C_EN bit to 0 when running this command.

The Receive Byte is similar to a Send Byte, the only difference is the direction of data transfer. See sections 5.5.2 and 5.5.3 of the *System Management Bus (SMBus) Specification*, Version 2.0 for the format of the protocol.

Write Byte/Word

The first byte of a Write Byte/Word access is the command code. The next 1 or 2 bytes are the data to be written. When programmed for a Write Byte/Word command, the Transmit Slave Address, Device Command, and Data0 Registers are sent. In addition, the Data1 Register is sent on a Write Word command. Software must force the I2C_EN bit to 0 when running this command. See section 5.5.4 of the *System Management Bus (SMBus) Specification*, Version 2.0 for the format of the protocol.

Read Byte/Word

Reading data is slightly more complicated than writing data. First the ICH10 must write a command to the slave device. Then it must follow that command with a repeated start condition to denote a read from that device's address. The slave then returns 1 or 2 bytes of data. Software must force the I2C_EN bit to 0 when running this command.

When programmed for the read byte/word command, the Transmit Slave Address and Device Command Registers are sent. Data is received into the DATA0 on the read byte, and the DATA0 and DATA1 registers on the read word. See section 5.5.5 of the *System Management Bus (SMBus) Specification*, Version 2.0 for the format of the protocol.

Process Call

The process call is so named because a command sends data and waits for the slave to return a value dependent on that data. The protocol is simply a Write Word followed by a Read Word, but without a second command or stop condition.

When programmed for the Process Call command, the ICH10 transmits the Transmit Slave Address, Host Command, DATA0 and DATA1 registers. Data received from the device is stored in the DATA0 and DATA1 registers. The Process Call command with I2C_EN set and the PEC_EN bit set produces undefined results. Software must force either I2C_EN or PEC_EN to 0 when running this command. See section 5.5.6 of the *System Management Bus (SMBus) Specification*, Version 2.0 for the format of the protocol.

Note: For process call command, the value written into bit 0 of the Transmit Slave Address Register (SMB I/O register, offset 04h) needs to be 0.

Note: If the I2C_EN bit is set, the protocol sequence changes slightly: the Command Code (bits 18:11 in the bit sequence) are not sent - as a result, the slave will not acknowledge (bit 19 in the sequence).



Block Read/Write

The ICH10 contains a 32-byte buffer for read and write data which can be enabled by setting bit 1 of the Auxiliary Control register at offset 0Dh in I/O space, as opposed to a single byte of buffering. This 32-byte buffer is filled with write data before transmission, and filled with read data on reception. In the ICH10, the interrupt is generated only after a transmission or reception of 32 bytes, or when the entire byte count has been transmitted/received.

The byte count field is transmitted but ignored by the ICH10 as software will end the transfer after all bytes it cares about have been sent or received.

For a Block Write, software must either force the I2C_EN bit or both the PEC_EN and AAC bits to 0 when running this command.

The block write begins with a slave address and a write condition. After the command code the ICH10 issues a byte count describing how many more bytes will follow in the message. If a slave had 20 bytes to send, the first byte would be the number 20 (14h), followed by 20 bytes of data. The byte count may not be 0. A Block Read or Write is allowed to transfer a maximum of 32 data bytes.

When programmed for a block write command, the Transmit Slave Address, Device Command, and Data0 (count) registers are sent. Data is then sent from the Block Data Byte register; the total data sent being the value stored in the Data0 Register. On block read commands, the first byte received is stored in the Data0 register, and the remaining bytes are stored in the Block Data Byte register. See section 5.5.7 of the *System Management Bus (SMBus) Specification, Version 2.0* for the format of the protocol.

Note: For Block Write, if the I2C_EN bit is set, the format of the command changes slightly. The ICH10 will still send the number of bytes (on writes) or receive the number of bytes (on reads) indicated in the DATA0 register. However, it will not send the contents of the DATA0 register as part of the message. Also, the Block Write protocol sequence changes slightly: the Byte Count (bits 27:20 in the bit sequence) are not sent - as a result, the slave will not acknowledge (bit 28 in the sequence).



I²C Read

This command allows the ICH10 to perform block reads to certain I²C devices, such as serial E²PROMs. The SMBus Block Read supports the 7-bit addressing mode only.

However, this does not allow access to devices using the I²C “Combined Format” that has data bytes after the address. Typically these data bytes correspond to an offset (address) within the serial memory chips.

Note: This command is supported independent of the setting of the I2C_EN bit. The I²C Read command with the PEC_EN bit set produces undefined results. Software must force both the PEC_EN and AAC bit to 0 when running this command.

For I²C Read command, the value written into bit 0 of the Transmit Slave Address Register (SMB I/O register, offset 04h) needs to be 0.

The format that is used for the command is shown in [Table 5-48](#).

Table 5-48. I²C Block Read

| Bit | Description |
|-------|-------------------------------------|
| 1 | Start |
| 8:2 | Slave Address — 7 bits |
| 9 | Write |
| 10 | Acknowledge from slave |
| 18:11 | Send DATA1 register |
| 19 | Acknowledge from slave |
| 20 | Repeated Start |
| 27:21 | Slave Address — 7 bits |
| 28 | Read |
| 29 | Acknowledge from slave |
| 37:30 | Data byte 1 from slave — 8 bits |
| 38 | Acknowledge |
| 46:39 | Data byte 2 from slave — 8 bits |
| 47 | Acknowledge |
| – | Data bytes from slave / Acknowledge |
| – | Data byte N from slave — 8 bits |
| – | NOT Acknowledge |
| – | Stop |

The ICH10 will continue reading data from the peripheral until the NAK is received.



Block Write–Block Read Process Call

The block write-block read process call is a two-part message. The call begins with a slave address and a write condition. After the command code the host issues a write byte count (M) that describes how many more bytes will be written in the first part of the message. If a master has 6 bytes to send, the byte count field will have the value 6 (0000 0110b), followed by the 6 bytes of data. The write byte count (M) cannot be 0.

The second part of the message is a block of read data beginning with a repeated start condition followed by the slave address and a Read bit. The next byte is the read byte count (N), which may differ from the write byte count (M). The read byte count (N) cannot be 0.

The combined data payload must not exceed 32 bytes. The byte length restrictions of this process call are summarized as follows:

- $M \geq 1$ byte
- $N \geq 1$ byte
- $M + N \leq 32$ bytes

The read byte count does not include the PEC byte. The PEC is computed on the total message beginning with the first slave address and using the normal PEC computational rules. It is highly recommended that a PEC byte be used with the Block Write-Block Read Process Call. Software must do a read to the command register (offset 2h) to reset the 32 byte buffer pointer prior to reading the block data register.

Note that there is no STOP condition before the repeated START condition, and that a NACK signifies the end of the read transfer.

Note: E32B bit in the Auxiliary Control register must be set when using this protocol.

See section 5.5.8 of the *System Management Bus (SMBus) Specification, Version 2.0* for the format of the protocol.

5.20.2 Bus Arbitration

Several masters may attempt to get on the bus at the same time by driving the SMBDATA line low to signal a start condition. The ICH10 continuously monitors the SMBDATA line. When the ICH10 is attempting to drive the bus to a 1 by letting go of the SMBDATA line, and it samples SMBDATA low, then some other master is driving the bus and the ICH10 will stop transferring data.

If the ICH10 sees that it has lost arbitration, the condition is called a collision. The ICH10 will set the BUS_ERR bit in the Host Status Register, and if enabled, generate an interrupt or SMI#. The processor is responsible for restarting the transaction.

When the ICH10 is a SMBus master, it drives the clock. When the ICH10 is sending address or command as an SMBus master, or data bytes as a master on writes, it drives data relative to the clock it is also driving. It will not start toggling the clock until the start or stop condition meets proper setup and hold time. The ICH10 will also ensure minimum time between SMBus transactions as a master.

Note: The ICH10 supports the same arbitration protocol for both the SMBus and the System Management (SMLINK) interfaces.

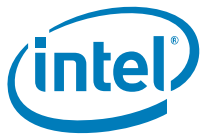

5.20.3 Bus Timing

5.20.3.1 Clock Stretching

Some devices may not be able to handle their clock toggling at the rate that the ICH10 as an SMBus master would like. They have the capability of stretching the low time of the clock. When the ICH10 attempts to release the clock (allowing the clock to go high), the clock will remain low for an extended period of time.

The ICH10 monitors the SMBus clock line after it releases the bus to determine whether to enable the counter for the high time of the clock. While the bus is still low, the high time counter must not be enabled. Similarly, the low period of the clock can be stretched by an SMBus master if it is not ready to send or receive data.

5.20.3.2 Bus Time Out (Intel® ICH10 as SMBus Master)

If there is an error in the transaction, such that an SMBus device does not signal an acknowledge, or holds the clock lower than the allowed time-out time, the transaction will time out. The ICH10 will discard the cycle and set the DEV_ERR bit. The time out minimum is 25 ms (800 RTC clocks). The time-out counter inside the ICH10 will start after the last bit of data is transferred by the ICH10 and it is waiting for a response.

The 25 ms timeout counter will not count under the following conditions:

1. BYTE_DONE_STATUS bit (SMBus I/O Offset 00h, bit 7) is set
2. The SECOND_TO_STS bit (TCO I/O Offset 06h, bit 1) is not set (this indicates that the system has not locked up).



5.20.4 Interrupts / SMI

The ICH10 SMBus controller uses PIRQB# as its interrupt pin. However, the system can alternatively be set up to generate SMI# instead of an interrupt, by setting the SMBUS_SMI_EN bit (Device 31:Function 0:Offset 40h:bit 1).

Table 5-50 and Table 5-51 specify how the various enable bits in the SMBus function control the generation of the interrupt, Host and Slave SMI, and Wake internal signals. The rows in the tables are additive, which means that if more than one row is true for a particular scenario then the Results for all of the activated rows will occur.

Table 5-49. Enable for SMBALERT#

| Event | INTREN (Host Control I/O Register, Offset 02h, Bit 0) | SMB_SMI_EN (Host Configuration Register, D31:F3:Offset 40h, Bit 1) | SMBALERT_DIS (Slave Command I/O Register, Offset 11h, Bit 2) | Result |
|-------------------------------------------------------------------------|-------------------------------------------------------|--------------------------------------------------------------------|--------------------------------------------------------------|--------------------------------------|
| SMBALERT# asserted low (always reported in Host Status Register, Bit 5) | X | X | X | Wake generated |
| | X | 1 | 0 | Slave SMI# generated (SMBUS_SMI_STS) |
| | 1 | 0 | 0 | Interrupt generated |

Table 5-50. Enables for SMBus Slave Write and SMBus Host Events

| Event | INTREN (Host Control I/O Register, Offset 02h, Bit 0) | SMB_SMI_EN (Host Configuration Register, D31:F3:Offset 40h, Bit1) | Event |
|--------------------------------------------------------|-------------------------------------------------------|-------------------------------------------------------------------|------------------------------------------------------------------------------|
| Slave Write to Wake/SMI# Command | X | X | Wake generated when asleep. Slave SMI# generated when awake (SMBUS_SMI_STS). |
| Slave Write to SMLINK_SLAVE_SMI Command | X | X | Slave SMI# generated when in the S0 state (SMBUS_SMI_STS) |
| Any combination of Host Status Register [4:1] asserted | 0 | X | None |
| | 1 | 0 | Interrupt generated |
| | 1 | 1 | Host SMI# generated |

Table 5-51. Enables for the Host Notify Command

| HOST_NOTIFY_INTREN (Slave Control I/O Register, Offset 11h, bit 0) | SMB_SMI_EN (Host Config Register, D31:F3:Off40h, Bit 1) | HOST_NOTIFY_WKEN (Slave Control I/O Register, Offset 11h, bit 1) | Result |
|--------------------------------------------------------------------|---------------------------------------------------------|------------------------------------------------------------------|--------------------------------------|
| 0 | X | 0 | None |
| X | X | 1 | Wake generated |
| 1 | 0 | X | Interrupt generated |
| 1 | 1 | X | Slave SMI# generated (SMBUS_SMI_STS) |

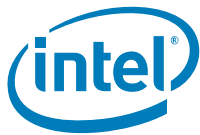

5.20.5 SMBALERT#

SMBALERT# is multiplexed with GPIO[11]. When enable and the signal is asserted, The ICH10 can generate an interrupt, an SMI#, or a wake event from S1–S5.

5.20.6 SMBus CRC Generation and Checking

If the AAC bit is set in the Auxiliary Control register, the ICH10 automatically calculates and drives CRC at the end of the transmitted packet for write cycles, and will check the CRC for read cycles. It will not transmit the contents of the PEC register for CRC. The PEC bit must not be set in the Host Control register if this bit is set, or unspecified behavior will result.

If the read cycle results in a CRC error, the DEV_ERR bit and the CRCE bit in the Auxiliary Status register at offset 0Ch will be set.

5.20.7 SMBus Slave Interface

The ICH10's SMBus Slave interface is accessed via the SMBus. The SMBus slave logic will not generate or handle receiving the PEC byte and will only act as a Legacy Alerting Protocol device. The slave interface allows the ICH10 to decode cycles, and allows an external microcontroller to perform specific actions. Key features and capabilities include:

- Supports decode of three types of messages: Byte Write, Byte Read, and Host Notify.
- Receive Slave Address register: This is the address that the ICH10 decodes. A default value is provided so that the slave interface can be used without the processor having to program this register.
- Receive Slave Data register in the SMBus I/O space that includes the data written by the external microcontroller.
- Registers that the external microcontroller can read to get the state of the ICH10.
- Status bits to indicate that the SMBus slave logic caused an interrupt or SMI# due to the reception of a message that matched the slave address.
 - Bit 0 of the Slave Status Register for the Host Notify command
 - Bit 16 of the SMI Status Register ([Section 13.8.3.13](#)) for all others

Note: The external microcontroller should not attempt to access the Intel ICH10's SMBus slave logic until either:

- 800 milliseconds after both: RTCRST# is high and RSMRST# is high, OR
- The PLTRST# deasserts

If a master leaves the clock and data bits of the SMBus interface at 1 for 50 μ s or more in the middle of a cycle, the ICH10 slave logic's behavior is undefined. This is interpreted as an unexpected idle and should be avoided when performing management activities to the slave logic.

Note: When an external microcontroller accesses the SMBus Slave Interface over the SMBus a translation in the address is needed to accommodate the least significant bit used for read/write control. For example, if the ICH10 slave address (RCV_SLVA) is left at 44h (default), the external micro controller would use an address of 88h/89h (write/read).



5.20.7.1 Format of Slave Write Cycle

The external master performs Byte Write commands to the ICH10 SMBus Slave I/F. The “Command” field (bits 11:18) indicate which register is being accessed. The Data field (bits 20:27) indicate the value that should be written to that register.

Table 5-52 has the values associated with the registers.

Table 5-52. Slave Write Registers

| Register | Function |
|----------|-----------------------------------------------------------------------------------|
| 0 | Command Register. See Table 5-53 below for legal values written to this register. |
| 1–3 | Reserved |
| 4 | Data Message Byte 0 |
| 5 | Data Message Byte 1 |
| 6–7 | Reserved |
| 8 | Reserved |
| 9–FFh | Reserved |

NOTE: The external microcontroller is responsible to make sure that it does not update the contents of the data byte registers until they have been read by the system processor. The ICH10 overwrites the old value with any new value received. A race condition is possible where the new value is being written to the register just at the time it is being read. ICH10 will not attempt to cover this race condition (i.e., unpredictable results in this case).

Table 5-53. Command Types (Sheet 1 of 2)

| Command Type | Description |
|--------------|------------------------------------------------------------------------------------------------------------------------------------------------------------------------------------------------------------------------------------------------------------------------------------------------------------|
| 0 | Reserved |
| 1 | WAKE/SMI#. This command wakes the system if it is not already awake. If system is already awake, an SMI# is generated. NOTE: The SMB_WAK_STS bit will be set by this command, even if the system is already awake. The SMI handler should then clear this bit. |
| 2 | Unconditional Powerdown. This command sets the PWRBTNOR_STS bit, and has the same effect as the Powerbutton Override occurring. |
| 3 | HARD RESET WITHOUT CYCLING: This command causes a hard reset of the system (does not include cycling of the power supply). This is equivalent to a write to the CF9h register with bits 2:1 set to 1, but bit 3 set to 0. |
| 4 | HARD RESET SYSTEM. This command causes a hard reset of the system (including cycling of the power supply). This is equivalent to a write to the CF9h register with bits 3:1 set to 1. |
| 5 | Disable the TCO Messages. This command will disable the Intel ICH10 from sending Heartbeat and Event messages (as described in Section 5.14). Once this command has been executed, Heartbeat and Event message reporting can only be re-enabled by assertion and deassertion of the RSMRST# signal. |
| 6 | WD RELOAD: Reload watchdog timer. |
| 7 | Reserved |

Table 5-53. Command Types (Sheet 2 of 2)

| Command Type | Description |
|--------------|------------------------------------------------------------------------------------------------------------------------------------------------------------------------------------------------------------------------------------------------------------------------------------------------------------------------------------------------------------------------------------------------------------------------------------------------------------------------------------------------------------------------------------------------------------------------------------------------------------------------------------------------------------------------------------------------------------------------------------------------------------------|
| 8 | <p>SMLINK_SLV_SMI. When ICH10 detects this command type while in the S0 state, it sets the SMLINK_SLV_SMI_STS bit (see Section 13.9.5). This command should only be used if the system is in an S0 state. If the message is received during S1–S5 states, the ICH10 acknowledges it, but the SMLINK_SLV_SMI_STS bit does not get set.</p> <p>NOTE: It is possible that the system transitions out of the S0 state at the same time that the SMLINK_SLV_SMI command is received. In this case, the SMLINK_SLV_SMI_STS bit may get set but not serviced before the system goes to sleep. Once the system returns to S0, the SMI associated with this bit would then be generated. Software must be able to handle this scenario.</p> |
| 9-FFh | Reserved. |

5.20.7.2 Format of Read Command

The external master performs Byte Read commands to the ICH10 SMBus Slave interface. The “Command” field (bits 18:11) indicate which register is being accessed. The Data field (bits 30:37) contain the value that should be read from that register.

Table 5-54. Slave Read Cycle Format

| Bit | Description | Driven by | Comment |
|-------|------------------------|--------------------------|---------------------------------------------------------------------------------------------------------------------|
| 1 | Start | External Microcontroller | |
| 2-8 | Slave Address - 7 bits | External Microcontroller | Must match value in Receive Slave Address register |
| 9 | Write | External Microcontroller | Always 0 |
| 10 | ACK | Intel ICH10 | |
| 11-18 | Command code – 8 bits | External Microcontroller | Indicates which register is being accessed. See Table 5-55 below for list of implemented registers. |
| 19 | ACK | Intel ICH10 | |
| 20 | Repeated Start | External Microcontroller | |
| 21-27 | Slave Address - 7 bits | External Microcontroller | Must match value in Receive Slave Address register |
| 28 | Read | External Microcontroller | Always 1 |
| 29 | ACK | Intel ICH10 | |
| 30-37 | Data Byte | Intel ICH10 | Value depends on register being accessed. Table 5-55 below for list of implemented registers. |
| 38 | NOT ACK | External Microcontroller | |
| 39 | Stop | External Microcontroller | |



Table 5-55. Data Values for Slave Read Registers (Sheet 1 of 2)

| Register | Bits | Description |
|----------|-----------------------|-----------------------------------------------------------------------------------------------------------------------------------------------------------------------------------------------------------------------------------------------------------------------------------------------------------------------------------------------------------------------------------------|
| 0 | 7:0 | Reserved for capabilities indication. Should always return 00h. Future chips may return another value to indicate different capabilities. |
| 1 | 2:0 | System Power State 000 = S0 001 = S1 010 = Reserved 011 = S3 100 = S4 101 = S5 110 = Reserved 111 = Reserved |
| | 7:3 | Reserved |
| 2 | 3:0 | Reserved |
| | 7:4 | Reserved |
| 3 | 5:0 | Watchdog Timer current value Note that Watchdog Timer has 10 bits, but this field is only 6 bits. If the current value is greater than 3Fh, ICH10 will always report 3Fh in this field. |
| | 7:6 | Reserved |
| 4 | 0 | 1 = The Intruder Detect (INTRD_DET) bit is set. This indicates that the system cover has probably been opened. |
| | 1 (Consumer Only) | 1 = BTI Temperature Event occurred. This bit will be set if the Intel ICH10's THRM# input signal is at a valid low voltage state. This bit will be clear if the THRM# input signal is at a valid high voltage state. NOTE: This bit interprets the behavior if the THRM# pin as active low. This bit is set independent of the TRM#_POL bit setting. |
| | 1 (Corporate Only) | 1 = BTI Temperature Event occurred. This bit will be set if the Intel ICH10's THRM# input signal is active. Else this bit will read 0. NOTE: The THRM# pin is in core well and accurate reflection of the THRM# pin is dependent on the platform being in S0. |
| | 2 | DOA CPU Status. This bit will be 1 to indicate that the processor is dead |
| | 3 | 1 = SECOND_TO_STS bit set. This bit will be set after the second time-out (SECOND_TO_STS bit) of the Watchdog Timer occurs. |
| | 6:4 | Reserved. Will always be 0, but software should ignore. |
| | 7 | Reflects the value of the GPIO[11]/SMBALERT# pin (and is dependent upon the value of the GPI_INV[11] bit. If the GPI_INV[11] bit is 1, then the value in this bit equals the level of the GPI[11]/SMBALERT# pin (high = 1, low = 0). If the GPI_INV[11] bit is 0, then the value of this bit will equal the inverse of the level of the GPI[11]/SMBALERT# pin (high = 0, low = 1). |
| 5 | 0 | FWH bad bit. This bit will be 1 to indicate that the FWH read returned FFh, which indicates that it is probably blank. |
| | 1 | Reserved |
| | 2 | CPU Power Failure Status: '1' if the CPUPWR_FLR bit in the GEN_PMCON_2 register is set. |
| | 3 | INIT# due to receiving Shutdown message: This event is visible from the reception of the shutdown message until a platform reset is done if the Shutdown Policy Select bit (SPS) is configured to drive INIT#. When the SPS bit is configured to generate PLTRST# based on shutdown, this register bit will always return 0. Events on signal will not create a event message |
| | 4 | Reserved |

Table 5-55. Data Values for Slave Read Registers (Sheet 2 of 2)

| Register | Bits | Description |
|----------|------|---------------------------------------------------------------------------------------------------------------------------------------------------------------------------------|
| | 5 | POWER_OK_BAD: Indicates the failure core power well ramp during boot/resume. This bit will be active if the SLP_S3# pin is de-asserted and PWROK pin is not asserted. |
| | 6 | Thermal Trip: This bit will shadow the state of processor Thermal Trip status bit (CTS) (16.2.1.2, GEN_PMCON_2, bit 3). Events on signal will not create a event message |
| | 7 | Reserved: Default value is "X" Note: Software should not expect a consistent value when this bit is read through SMBUS/SMLINK |
| 6 | 7:0 | Contents of the Message 1 register. Refer to Section 13.9.8 for the description of this register. |
| 7 | 7:0 | Contents of the Message 2 register. Refer to Section 13.9.8 for the description of this register. |
| 8 | 7:0 | Contents of the TCO_WDCNT register. Refer to Section 13.9.9 for the description of this register. |
| 9 | 7:0 | Seconds of the RTC |
| A | 7:0 | Minutes of the RTC |
| B | 7:0 | Hours of the RTC |
| C | 7:0 | "Day of Week" of the RTC |
| D | 7:0 | "Day of Month" of the RTC |
| E | 7:0 | Month of the RTC |
| F | 7:0 | Year of the RTC |
| 10h–FFh | 7:0 | Reserved |

5.20.7.2.1 Behavioral Notes

According to SMBus protocol, Read and Write messages always begin with a Start bit – Address– Write bit sequence. When the ICH10 detects that the address matches the value in the Receive Slave Address register, it will assume that the protocol is always followed and ignore the Write bit (bit 9) and signal an Acknowledge during bit 10. In other words, if a Start –Address–Read occurs (which is invalid for SMBus Read or Write protocol), and the address matches the ICH10's Slave Address, the ICH10 will still grab the cycle.

Also according to SMBus protocol, a Read cycle contains a Repeated Start–Address–Read sequence beginning at bit 20. Once again, if the Address matches the ICH10's Receive Slave Address, it will assume that the protocol is followed, ignore bit 28, and proceed with the Slave Read cycle.

Note: An external microcontroller must not attempt to access the ICH10's SMBus Slave logic until at least 1 second after both RTCRST# and RSMRST# are deasserted (high).

5.20.7.3 Slave Read of RTC Time Bytes

The ICH10 SMBus slave interface allows external SMBus master to read the internal RTC's time byte registers.

The RTC time bytes are internally latched by the ICH10's hardware whenever RTC time is not changing and SMBus is idle. This ensures that the time byte delivered to the slave read is always valid and it does not change when the read is still in progress on the bus. The RTC time will change whenever hardware update is in progress, or there is a software write to the RTC time bytes.



The ICH10 SMBus slave interface only supports Byte Read operation. The external SMBus master will read the RTC time bytes one after another. It is software's responsibility to check and manage the possible time rollover when subsequent time bytes are read.

For example, assuming the RTC time is 11 hours: 59 minutes: 59 seconds. When the external SMBus master reads the hour as 11, then proceeds to read the minute, it is possible that the rollover happens between the reads and the minute is read as 0. This results in 11 hours: 0 minute instead of the correct time of 12 hours: 0 minutes. Unless it is certain that rollover will not occur, software is required to detect the possible time rollover by reading multiple times such that the read time bytes can be adjusted accordingly if needed.

5.20.7.4 Format of Host Notify Command

The ICH10 tracks and responds to the standard Host Notify command as specified in the *System Management Bus (SMBus) Specification, Version 2.0*. The host address for this command is fixed to 0001000b. If the ICH10 already has data for a previously-received host notify command which has not been serviced yet by the host software (as indicated by the HOST_NOTIFY_STS bit), then it will NACK following the host address byte of the protocol. This allows the host to communicate non-acceptance to the master and retain the host notify address and data values for the previous cycle until host software completely services the interrupt.

Note: Host software must always clear the HOST_NOTIFY_STS bit after completing any necessary reads of the address and data registers.

Table 5-56 shows the Host Notify format.

Table 5-56. Host Notify Format

| Bit | Description | Driven By | Comment |
|-------|---------------------------|-----------------|-------------------------------------------------------------------------------------|
| 1 | Start | External Master | |
| 8:2 | SMB Host Address — 7 bits | External Master | Always 0001_000 |
| 9 | Write | External Master | Always 0 |
| 10 | ACK (or NACK) | Intel® ICH10 | ICH10 NACKs if HOST_NOTIFY_STS is 1 |
| 17:11 | Device Address – 7 bits | External Master | Indicates the address of the master; loaded into the Notify Device Address Register |
| 18 | Unused — Always 0 | External Master | 7-bit-only address; this bit is inserted to complete the byte |
| 19 | ACK | ICH10 | |
| 27:20 | Data Byte Low — 8 bits | External Master | Loaded into the Notify Data Low Byte Register |
| 28 | ACK | ICH10 | |
| 36:29 | Data Byte High — 8 bits | External Master | Loaded into the Notify Data High Byte Register |
| 37 | ACK | ICH10 | |
| 38 | Stop | External Master | |

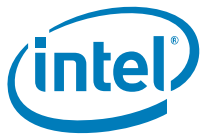

5.21 Intel® High Definition Audio Overview

The ICH10's High Definition Audio (HDA) controller communicates with the external codec(s) over the Intel High Definition Audio serial link. The controller consists of a set of DMA engines that are used to move samples of digitally encoded data between system memory and an external codec(s). The ICH10 implements four output DMA engines and 4 input DMA engines. The output DMA engines move digital data from system memory to a D-A converter in a codec. ICH10 implements a single Serial Data Output signal (HDA_SDOOUT) that is connected to all external codecs. The input DMA engines move digital data from the A-D converter in the codec to system memory. The ICH10 implements four Serial Digital Input signals (HDA_SDI[3:0]) supporting up to four codecs.

Audio software renders outbound and processes inbound data to/from buffers in system memory. The location of individual buffers is described by a Buffer Descriptor List (BDL) that is fetched and processed by the controller. The data in the buffers is arranged in a predefined format. The output DMA engines fetch the digital data from memory and reformat it based on the programmed sample rate, bit/sample and number of channels. The data from the output DMA engines is then combined and serially sent to the external codecs over the Intel High Definition Audio link. The input DMA engines receive data from the codecs over the Intel High Definition Audio link and format the data based on the programmable attributes for that stream. The data is then written to memory in the predefined format for software to process. Each DMA engine moves one stream of data. A single codec can accept or generate multiple streams of data, one for each A-D or D-A converter in the codec. Multiple codecs can accept the same output stream processed by a single DMA engine.

Codec commands and responses are also transported to and from the codecs using DMA engines.

5.22 Intel® Active Management Technology (Intel® AMT) (Corporate Only)

Intel Active Management Technology is a set of advanced manageability features developed as a direct result of IT customer feedback gained through Intel market research. Reducing the Total Cost of Ownership (TCO) through improved asset tracking, remote manageability, and fewer desk-side visits were identified as key IT priorities. Intel AMT extends the capabilities of existing management solutions by making the asset information, remote diagnostics, recovery and contain capabilities always available, or Out of Band (OOB), even when the system is in a low-power "off" state or the OS is hung.

Another feature of Intel AMT is System Defense. System Defense is used to stop the propagation of worms and viruses. Programmable packet filters in the integrated LAN Controller are used to accomplish this. These filters inspect all incoming and all outgoing packets and decide whether to block or pass the packets as configured. There is no indication to the host that a packet has been blocked or accepted.

The logic can be used to accept or block reception to host or transmission to network paths. Additionally, counter logic can be used to count the number or filter matches for a given filter. This feature allows for statistical sampling of connections as well as rate limiting of connections.



5.22.1 Intel® AMT Features

- E-Asset Tag
- OOB HW and SW Inventory Logs
- OOB Alerts
- IDE Redirect
- Serial over LAN for Remote Control
- Remote Diagnostics Execution
- OS Lock-Up Alert
- OS Repair
- Remote BIOS Recovery and Update

5.22.2 Intel® AMT Requirements

Intel AMT is a platform-level solution that utilizes multiple system components including:

- Intel AMT-Ready ICH10 SKU
- Intel Gigabit Ethernet PHY (Intel® 82567 Gigabit Platform LAN Connect device) with Intel Active Management Technology for remote access
- SPI flash memory with 4KB or 8KB sector erase that meets requirements set in [Section 5.23.4](#) (32 Mb minimum for Intel AMT) to store asset information, management software code, and logs
- BIOS to provide asset detection and POST diagnostics (BIOS and Intel AMT can optionally share same flash memory device)
- Familiar ISV software packages to take advantage of Intel AMT's platform management capabilities

5.23 Serial Peripheral Interface (SPI)

The Serial Peripheral Interface (SPI) is a 4-pin interface that provides a lower-cost alternative for system flash versus the Firmware Hub on the LPC bus.

The 4-pin SPI interface consists of clock (CLK), master data out (Master Out Slave In (MOSI)), master data in (Master In Slave Out (MISO)) and an active low chip select (SPI_CS[1:0]#).

The ICH10 supports up to two SPI flash devices using two separate Chip Select pins. Each SPI flash device can be up to 16 MBytes. The ICH10 SPI interface supports 20 MHz and 33 MHz SPI devices.

Communication on the SPI bus is done with a Master – Slave protocol. The Slave is connected to the ICH10 and is implemented as a tri-state bus.

Note: If option 11 LPC is selected BIOS may still be placed on LPC, but all platforms with ICH10 (Corporate Only) require SPI flash connected directly to the ICH's SPI bus with a valid descriptor in order to boot.

Note: When SPI is selected by the Boot BIOS Destination Strap and a SPI device is detected by the ICH10, LPC based BIOS flash is disabled.



5.23.1 SPI Supported Feature Overview

SPI Flash on the ICH10 has two operational modes, descriptor and non-descriptor.

5.23.1.1 Non-Descriptor Mode

Non-descriptor mode is similar to the flash functionality of ICH7. In this mode, SPI Flash can only be used for BIOS. Direct read and writes are not supported. BIOS has read/write access only through register accesses. Through those register accesses BIOS can read and write to the entire flash without security checking. There is also no support for the integrated Gigabit Ethernet, Intel Management Engine, chipset soft straps, as well multiple SPI Flash components.

5.23.1.2 Descriptor Mode

Descriptor Mode enables many new features of the chipset:

- Integrated Gigabit Ethernet and Host processor for Gigabit Ethernet Software
- Intel Active Management Technology
- Intel Quiet System Technology
- Supports two SPI Flash components using two separate chip select pins
- Hardware enforced security restricting master accesses to different regions
- Chipset Soft Strap region provides the ability to use Flash NVM as an alternative to hardware pull-up/pull-down resistors for both ICH and (G)MCH
- Supports the SPI Fast Read instruction and frequencies of 33 MHz
- Uses standardized Flash Instruction Set

5.23.1.2.1 SPI Flash Regions

In Descriptor Mode the Flash is divided into five separate regions:

| Region | Content |
|--------|-------------------------|
| 0 | Flash Descriptor |
| 1 | BIOS |
| 2 | Intel Management Engine |
| 3 | Gigabit Ethernet |
| 4 | Platform Data |

Only three masters can access the four regions: Host processor running BIOS code, Integrated Gigabit Ethernet and Host processor running Gigabit Ethernet Software, and Intel Management Engine. The only required region is Region 0, the Flash Descriptor. Region 0 must be located in the first sector of device 0 (offset 0).

Flash Region Sizes

SPI flash space requirements differ by platform and configuration. The Flash Descriptor requires one 4 KB or larger block. GbE requires two 4 KB or larger blocks. The Platform Data Region is 32 KB. The amount of flash space consumed is dependent on the erase granularity of the flash part and the platform requirements for the Intel ME and BIOS regions. The Intel ME region will contain firmware to support Intel Quiet System Technology, Intel Active Management Technology, ASF 2.0 and Intel Trusted Platform Module.



Table 5-57. Region Size versus Erase Granularity of Flash Components

| Region | Size with 4 KB Blocks | Size with 64 KB Blocks |
|----------------------|-----------------------|------------------------|
| Descriptor | 4 KB | 64 KB |
| GbE | 8 KB | 128 KB |
| Platform Data Region | 32 KB | Not Supported |
| BIOS | Varies by Platform | Varies by Platform |
| Intel ME | Varies by Platform | Varies by Platform |

5.23.1.3 Device Partitioning

The ICH10 SPI Flash controller supports two sets of attributes in SPI flash space. This allows for supporting an asymmetric flash component that has two separate sets of attributes in the upper and lower part of the memory array. An example of this is a flash part that has different erase granularities in two different parts of the memory array. This allows for the usage of two separate flash vendors if using two different flash parts.

Figure 5-16. Flash Partition Boundary

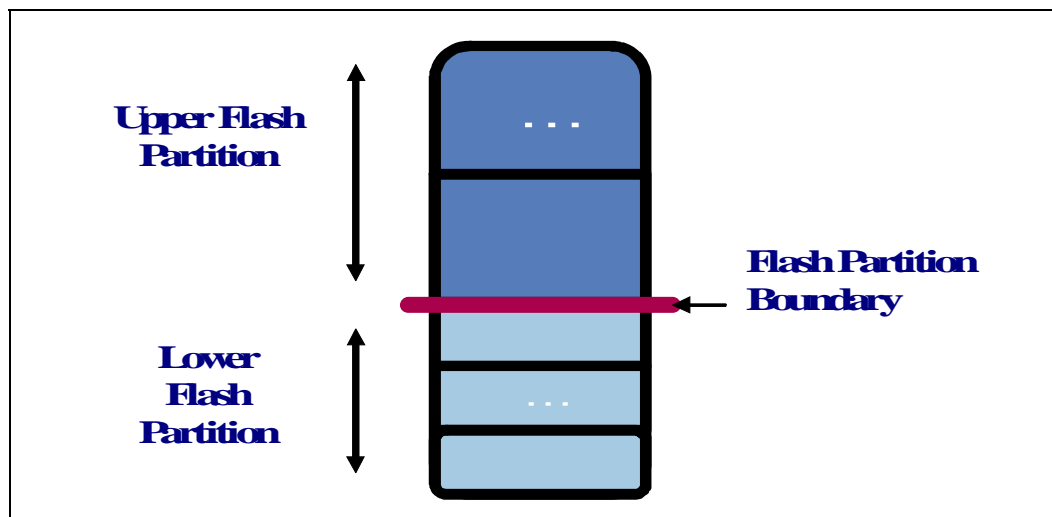

5.23.2 Flash Descriptor

The maximum size of the Flash Descriptor is 4 KB. If the block/sector size of the SPI flash device is greater than 4 KB, the flash descriptor will only use the first 4 KB of the first block. The flash descriptor requires its own block at the bottom of memory (0x00h). The information stored in the Flash Descriptor can only be written during the manufacturing process as its read/write permissions must be set to Read only when the computer leaves the manufacturing floor.

The Flash Descriptor is made up of eleven sections:

Figure 5-17. Flash Descriptor Sections

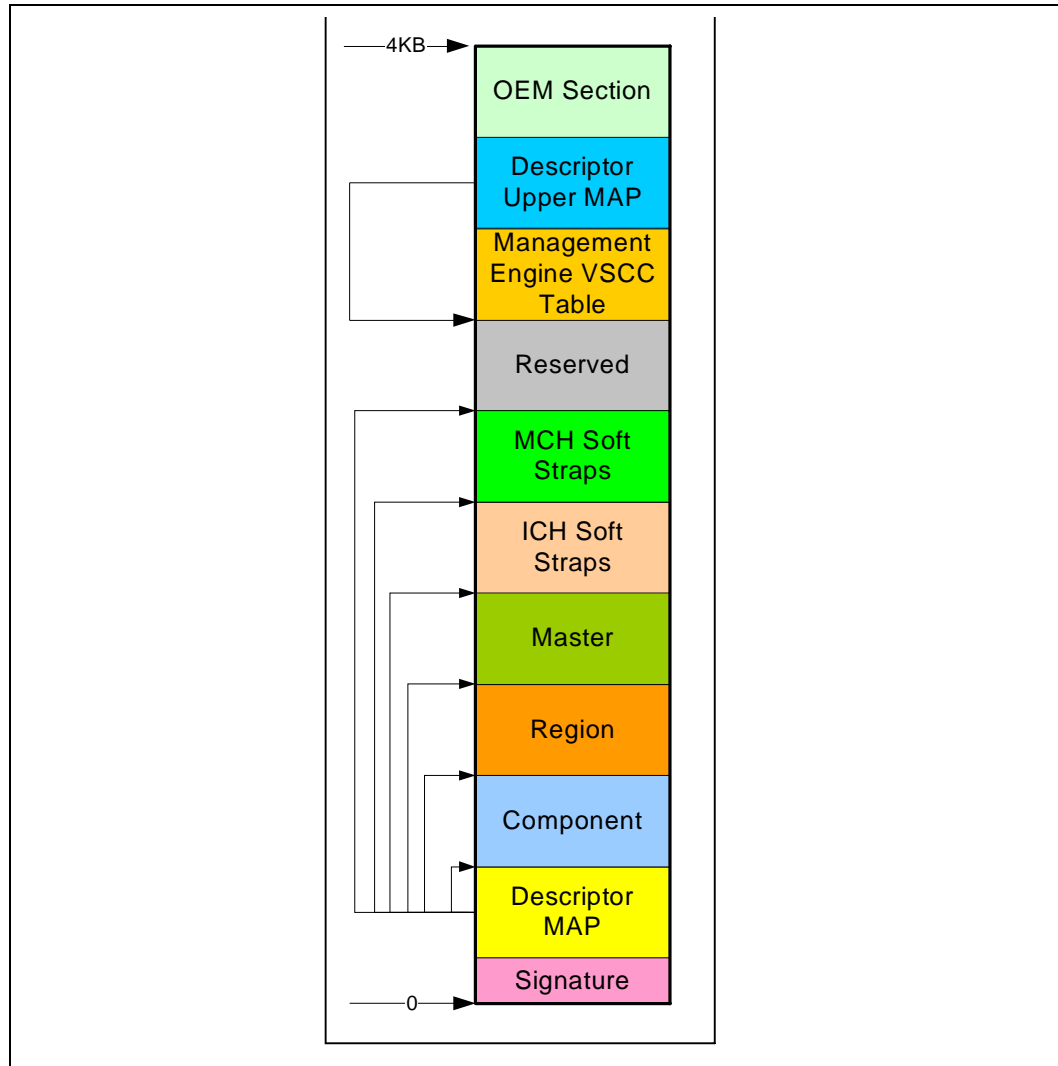

1. The Flash signature selects Descriptor Mode as well as verifies if the flash is programmed and functioning. The data at the bottom of the flash (offset 0) must be 0FF0A55Ah in order to be in Descriptor mode.
2. The Descriptor map has pointers to the other five descriptor sections as well as the size of each.



3. The component section has information about the SPI flash in the system including: the number of components, density of each, invalid instructions (such as chip erase), and frequencies for read, fast read and write/erase instructions.
4. The Region section points to the three other regions as well as the size of each region.
5. The master region contains the security settings for the flash, granting read/write permissions for each region and identifying each master by a requestor ID. See [Section 5.23.2.1](#) for more information.
- 6 & 7. The (G)MCH and ICH chipset soft strap sections contain (G)MCH and ICH configurable parameters.
8. The Reserved region between the top of the (G)MCH strap section and the bottom of the OEM Section is reserved for future chipset usages.
9. The Descriptor Upper MAP determines the length and base address of the Intel Management Engine VSCC Table.
10. The Intel Management Engine VSCC Table holds the JEDEC ID and the VSCC information of the entire SPI Flash supported by the NVM image.
11. OEM Section is 256 Bytes reserved at the top of the Flash Descriptor for use by OEM.

5.23.2.1 Descriptor Master Region

The master region defines read and write access setting for each region of the SPI device. The master region recognizes three masters: BIOS, Gigabit Ethernet, and Intel Management Engine. Each master is only allowed to do direct reads of its primary regions.

Table 5-58. Region Access Control Table

| Master Read/Write Access | | | |
|--------------------------|------------------------------------------------------------|------------------------------------------------------------|-----------------------------------------------------------|
| Region | CPU and BIOS | Intel ME/(G)MCH | GbE Controller |
| Descriptor | N/A | N/A | N/A |
| BIOS | CPU and BIOS can always read from and write to BIOS Region | Read / Write | Read / Write |
| Intel Management Engine | Read / Write | Intel ME can always read from and write to Intel ME Region | Read / Write |
| Gigabit Ethernet | Read / Write | Read / Write | GbE software can always read from and write to GbE region |
| Platform Data Region | N/A | N/A | N/A |



5.23.3 Flash Access

There are two types of flash accesses:

Direct Access:

- Masters are allowed to do direct read only of their primary region
 - Gigabit Ethernet region can only be directly accessed by the Gigabit Ethernet controller. Gigabit Ethernet software must use Program Registers to access the Gigabit Ethernet region.
- Master's Host or Intel Management Engine virtual read address is converted into the SPI Flash Linear Address (FLA) using the Flash Descriptor Region Base/Limit registers

Program Register Access:

- Program Register Accesses are not allowed to cross a 4 KB boundary and can not issue a command that might extend across two components
- Software programs the FLA corresponding to the region desired
 - Software must read the devices Primary Region Base/Limit address to create a FLA.

5.23.3.1 Direct Access Security

- Requester ID of the device must match that of the primary Requester ID in the Master Section
- Calculated Flash Linear Address must fall between primary region base/limit
- Direct Write not allowed
- Direct Read Cache contents are reset to 0s on a read from a different master
 - Supports the same cache flush mechanism in the ICH7, which includes Program Register Writes

5.23.3.2 Register Access Security

- Only primary region masters can access the registers

Note: Processor running Gigabit Ethernet software can access Gigabit Ethernet registers

- Masters are only allowed to read or write those regions they have read/write permission
- Using the Flash Region Access Permissions, one master can give another master read/write permissions to their area
- Using the five Protected Range registers, each master can add separate read/write protection above that granted in the Flash Descriptor for their own accesses
 - Example: BIOS may want to protect different regions of BIOS from being erased
 - Ranges can extend across region boundaries



5.23.4 Serial Flash Device Compatibility Requirements

A variety of serial flash devices exist in the market. For a serial flash device to be compatible with the Intel ICH10 SPI bus, it must meet the minimum requirements detailed in the following sections.

5.23.4.1 Intel® ICH10 SPI Based BIOS Requirements

A serial flash device must meet the following minimum requirements when used explicitly for system BIOS storage.

- Erase size capability of at least one of the following: 64 KB, 8 KB, 4 KB, or 256 bytes.
- Device must support multiple writes to a page without requiring a preceding erase cycle (Refer to [Section 5.23.5](#))
- Serial flash device must ignore the upper address bits such that an address of FFFFFFFh aliases to the top of the flash memory.
- SPI Compatible Mode 0 support (clock phase is 0 and data is latched on the rising edge of the clock).
- If the device receives a command that is not supported or incomplete (less than 8 bits), the device must complete the cycle gracefully without any impact on the flash content.
- An erase command (page, sector, block, chip, etc.) must set all bits inside the designated area (page, sector, block, chip, etc.) to 1 (Fh).
- Status Register bit 0 must be set to 1 when a write, erase or write to status register is in progress and cleared to 0 when a write or erase is NOT in progress.
- Devices requiring the Write Enable command must automatically clear the Write Enable Latch at the end of Data Program instructions.
- Byte write must be supported. The flexibility to perform a write between 1 byte to 64 bytes is recommended.
- Hardware Sequencing requirements are optional in BIOS only platforms.
- SPI flash parts that do not meet Hardware sequencing command set requirements may work in BIOS only platforms via software sequencing.

5.23.4.2 Integrated LAN Firmware SPI Flash Requirements

A serial flash device that will be used for system BIOS and Integrated LAN or Integrated LAN only must meet all the SPI Based BIOS Requirements plus:

- Hardware sequencing
- 4, 8 or 64 KBytes erase capability must be supported.

5.23.4.2.1 SPI Flash Unlocking Requirements for Integrated LAN

BIOS must ensure there is no SPI flash based read/write/erase protection on the GbE region. GbE firmware and drivers for the integrated LAN need to be able to read, write and erase the GbE region at all times.

5.23.4.3 Intel® Management Engine Firmware SPI Flash Requirements

Intel Management Engine Firmware must meet the SPI flash based BIOS Requirements plus:

- Hardware Sequencing.
- Flash part must be uniform 4 KB erasable block throughout the entire device.
- Write protection scheme must meet SPI flash unlocking requirements for Intel Management Engine.



5.23.4.3.1 SPI Flash Unlocking Requirements for Intel Management Engine

Flash devices must be globally unlocked (read, write and erase access on the Intel ME region) from power on by writing 00h to the flash's status register to disable write protection.

If the status register must be unprotected, it must use the enable write status register command 50h or write enable 06h.

Opcode 01h (write to status register) must then be used to write a single byte of 00h into the status register. This must unlock the entire part. If the SPI flash's status register has non-volatile bits that must be written to, bits [5:2] of the flash's status register must be all 0h to indicate that the flash is unlocked.

If there is no need to execute a write enable on the status register, then opcodes 06h and 50h must be ignored.

After global unlock, BIOS has the ability to lock down small sections of the flash as long as they do not involve the Intel ME or GbE region.

5.23.4.4 Hardware Sequencing Requirements

Table 5-59 contains a list of commands and the associated opcodes that a SPI-based serial flash device must support in order to be compatible with hardware sequencing.

Table 5-59. Hardware Sequencing Commands and Opcode Requirements

| Commands | Opcode | Notes |
|---------------------------------|---------------|--------------------------------------------------------------------------------------------------------------------------|
| Write to Status Register | 01h | Writes a byte to SPI flash's status register. Enable Write to Status Register command must be run prior to this command. |
| Program Data | 02h | Single byte or 64 byte write as determined by flash part capabilities and software. |
| Read Data | 03h | |
| Write Disable | 04h | |
| Read Status | 05h | Outputs contents of SPI flash's status register |
| Write Enable | 06h | |
| Fast Read | 0Bh | |
| Enable Write to Status Register | 50h or 60h | Enables a bit in the status register to allow an update to the status register |
| Erase | Program mable | 256B, 4 Kbyte, 8 Kbyte or 64 Kbyte |
| Full Chip Erase | C7h | |
| JEDEC ID | 9Fh | See Section . |

5.23.4.4.1 JEDEC ID

Since each serial flash device may have unique capabilities and commands, the JEDEC ID is the necessary mechanism for identifying the device so the uniqueness of the device can be comprehended by the controller (master). The JEDEC ID uses the opcode 9Fh and a specified implementation and usage model. This JEDEC Standard Manufacturer and Device ID read method is defined in Standard JESD21-C, PRN03-NV.



5.23.5 Multiple Page Write Usage Model

The system BIOS and Intel Active Management Technology firmware usage models require that the serial flash device support multiple writes to a page (minimum of 512 writes) without requiring a preceding erase command. BIOS commonly uses capabilities such as counters that are used for error logging and system boot progress logging. These counters are typically implemented by using byte-writes to 'increment' the bits within a page that have been designated as the counter. The Intel AMT firmware usage model requires the capability for multiple data updates within any given page. These data updates occur via byte-writes without executing a preceding erase to the given page. Both the BIOS and Intel AMT firmware multiple page write usage models apply to sequential and non-sequential data writes.

Note: This usage model requirement is based on any given bit only being written once from a 1-to-0 without requiring the preceding erase. An erase would be required to change bits back to the 1 state.

5.23.5.1 Soft Flash Protection

There are two types of flash protection that are not defined in the flash descriptor supported by ICH10:

1. BIOS Range Write Protection
2. SMI#-Based Global Write Protection

Both mechanisms are logically OR'd together such that if any of the mechanisms indicate that the access should be blocked, then it is blocked. [Table 5-60](#) provides a summary of the mechanisms.

Table 5-60. Flash Protection Mechanism Summary

| Mechanism | Accesses Blocked | Range Specific? | Reset-Override or SMI#-Override? | Equivalent Function on FWH |
|-----------------------------|------------------|-----------------|----------------------------------|------------------------------------------------|
| BIOS Range Write Protection | Writes | Yes | Reset Override | FWH Sector Protection |
| Write Protect | Writes | No | SMI# Override | Same as Write Protect in previous ICHs for FWH |

A blocked command will appear to software to finish, except that the Blocked Access status bit is set in this case.

5.23.5.2 BIOS Range Write Protection

The ICH10 provides a method for blocking writes to specific ranges in the SPI flash when the Protected BIOS Ranges are enabled. This is achieved by checking the Opcode type information (which can be locked down by the initial Boot BIOS) and the address of the requested command against the base and limit fields of a Write Protected BIOS range.

Note: Once BIOS has locked down the Protected BIOS Range registers, this mechanism remains in place until the next system reset.



5.23.5.3 SMI # Based Global Write Protection

The ICH provides a method for blocking writes to the SPI flash when the Write Protected bit is cleared (i.e., protected). This is achieved by checking the Opcode type information (which can be locked down by the initial Boot BIOS) of the requested command.

The Write Protect and Lock Enable bits interact in the same manner for SPI BIOS as they do for the FWH BIOS.

5.23.6 Flash Device Configurations

The ICH10-based platform may use the serial flash in multiple configurations. The following table focuses on the supported configurations involving the ICH10 and Intel Active Management Technology.

| Configuration | System BIOS Storage | Intel® ICH10 Firmware | Minimum Number of SPI Device(s) |
|---------------|---------------------|-----------------------|---------------------------------|
| 1 | SPI | No | 1 |
| 2 | Non-SPI | Yes | 1 |
| 3 | SPI | Yes | 1 |
| 4 | Non-SPI | No | 0 |

Note: When SPI is selected for BIOS and a SPI device is detected by the ICH10, LPC based BIOS flash is disabled.

Note: Firmware includes Intel Active Management Technology, ASF, Intel Quiet System Technology and Gigabit Ethernet.

5.23.7 SPI Flash Device Recommended Pinout

The table below contains the recommended serial flash device pin-out for an 8-pin device. Use of the recommended pin-out on an 8-pin device reduces complexities involved with designing the serial flash device onto a motherboard and allows for support of a common footprint usage model (refer to [Section 5.23.8.1](#)).

Table 5-61. Recommended Pinout for 8-Pin Serial Flash Device

| Pin # | Signal |
|-------|----------------|
| 1 | Chips Select |
| 2 | Data Output |
| 3 | Write Protect |
| 4 | Ground |
| 5 | Data Input |
| 6 | Serial Clock |
| 7 | Hold / Reset |
| 8 | Supply Voltage |

Although an 8-pin device is preferred over a 16-pin device due to footprint compatibility, the following table contains the recommended serial flash device pin-out for a 16-pin SOIC.



5.23.8 Serial Flash Device Package

Table 5-62. Recommended Pinout for 16-Pin Serial Flash Device

| Pin # | Signal | Pin # | Signal |
|-------|-----------------|-------|----------------|
| 1 | Hold / Reset | 9 | Write Protect |
| 2 | Supply Voltage | 10 | Ground |
| 3 | No Connect | 11 | No Connect |
| 4 | No Connect | 12 | No Connect |
| 5 | No Connect | 13 | No Connect |
| 6 | No Connect | 14 | No Connect |
| 7 | Chip Select | 15 | Serial Data In |
| 8 | Serial Data Out | 16 | Serial Clock |

5.23.8.1 Common Footprint Usage Model

To minimize platform motherboard redesign and to enable platform Bill of Material (BOM) selectability, many PC System OEM's design their motherboard with a single common footprint. This common footprint allows population of a soldered down device or a socket that accepts a leadless device. This enables the board manufacturer to support, via selection of the appropriate BOM, either of these solutions on the same system without requiring any board redesign.

The common footprint usage model is desirable during system debug and by flash content developers since the leadless device can be easily removed and reprogrammed without damage to device leads. When the board and flash content is mature for high-volume production, both the socketed leadless solution and the soldered down leaded solution are available through BOM selection.

5.23.8.2 Serial Flash Device Package Recommendations

It is highly recommended that the common footprint usage model be supported. An example of how this can be accomplished is as follows:

- The recommended pinout for 8-pin serial flash devices is used (refer to [Section 5.23.7](#)).
- The 8-pin device is supported in either an 8-contact VDFPN (6x5 mm MLP) package or an 8-contact WSON (5x6 mm) package. These packages can fit into a socket that is land pattern compatible with the wide body SO8 package.
- The 8-pin device is supported in the SO8 (150 mil) and in the wide-body SO8 (200 mil) packages.

The 16-pin device is supported in the SO16 (300 mil) package.



5.24 Intel[®] Quiet System Technology (Intel[®] QST)

The ICH10 implements three PWM and 4 TACH signals for Intel Quiet System Technology (QST).

Note: Intel Quiet System Technology functionality requires a correctly configured system, including an appropriate (G)MCH with Intel ME, Intel ME Firmware, and system BIOS support.

5.24.1 PWM Outputs

This signal is driven as open-drain. An external pull-up resistor is integrated into the fan to provide the rising edge of the PWM output signal. The PWM output is driven low during reset, which represents 0% duty cycle to the fans. After reset de-assertion, the PWM output will continue to be driven low until one of the following occurs:

- The internal PWM control register is programmed to a non-zero value by the Intel QST firmware.
- The watchdog timer expires (enabled and set at 4 seconds by default).
- The polarity of the signal is inverted by the Intel QST firmware.

Note that if a PWM output will be programmed to inverted polarity for a particular fan, then the low voltage driven during reset represents 100% duty cycle to the fan.

5.24.2 TACH Inputs

This signal is driven as an open-collector or open-drain output from the fan. An external pull-up is expected to be implemented on the motherboard to provide the rising edge of the TACH input. This signal has analog hysteresis and digital filtering due to the potentially slow rise and fall times. This signal has a weak internal pull-up resistor to keep the input buffer from floating if the TACH input is not connected to a fan.

5.25 Thermal Sensors

ICH10 integrates two thermal sensors that monitor the temperature within its die. The thermal sensors are used for Intel Quiet System Technology (Intel QST). The Intel QST firmware can internally access the temperature measured by the sensors and use the data as a factor to determine how to control the fans.

The ICH10 thermal sensors also provide the capability to protect the ICH10 under a catastrophic thermal situation. When the sensors are enabled and correctly programmed by the system BIOS, the ICH10 will shut down the system when the ICH10 thermal limit is reached. Refer to the Thermal Memory Mapped Configuration Registers [Section 23.2](#) for more info on the catastrophic settings.



5.26 Feature Capability Mechanism

A set of registers is included in the ICH10 LPC Interface (Device 31, Function 0, offset E0h - EBh) that allows the system software or BIOS to easily determine the features supported by ICH10. These registers can be accessed through LPC PCI configuration space, thus allowing for convenient single point access mechanism for chipset feature detection.

This set of registers consists of:

Capability ID (FDCAP)
Capability Length (FDLEN)
Capability Version and Vendor-Specific Capability ID (FDVER)
Feature Vector (FVECT)

5.27 Integrated Trusted Platform Module (Corporate Only)

The integrated Trusted Platform Module (TPM) implementation consists of firmware, Intel Management Engine resources and dedicated hardware within the ICH and the (G)MCH. The integrated TPM supports all requirements of the TPM Specification Version 1.2, Level 2 Revision 103, as published by the Trusted Computing Group.

Note: Integrated TPM functionality requires a correctly configured system, including an appropriate (G)MCH with Intel Management Engine firmware, ICH10 and SPI Flash.

5.27.1 Integrated TPM Hardware Requirements

The following hardware components are required for TPM 1.2 functionality:

1. SPI Flash Memory: The SPI flash component connected to the ICH (SPI interface) provides non-volatile storage requirement for the integrated TPM. It contains the FW code which is loaded by the Intel Management Engine upon power on.
2. Monotonic Counters: The ICH10 contains four TPM 1.2 compliant monotonic counters that reside in the RTC well which maintains values programmed by the integrated TPM across power cycles. The counters are only incremented by TPM software (host or Intel ME) and are not controlled by the ICH hardware.
3. Physical Presence: Physical presence indication is required in order to enable certain TPM commands. These commands are generally used to bypass owner authorized commands when the authorization data is unavailable or to set the integrated TPM to a non-owner state. The Intel Management Engine Firmware uses the TPM_PP pin on the ICH10 to indicate Physical Presence to the platform when pulled high. In addition, Physical Presence flags can be set to force Physical Presence by firmware.
4. Chipset: An ICH10 and (G)MCH with Intel Management Engine enabled is required for integrated TPM support.



5.27.2 Enabling integrated TPM

The integrated TPM is enabled based on the combination of a functional straps on both the ICH and the (G)MCH and a soft strap bit found in the SPI Descriptor. When the integrated TPM is enabled, Front Side Bus cycles that would otherwise propagate to the LPC bus will be routed by the Config Bus Decoder to the integrated TPM Host Decoder. Either Functional strap or the soft strap bit may be used to disable the integrated TPM.

- **ICH Functional Strap:** The ICH10 enables Integrated TPM when SPI_MOSI is sampled high on the rising edge of CLPWROK and disabled if the SPI_MOSI signal is sampled low. See [Section 2.25.1](#) for details. The SPI_MOSI signal requires an external pull-up resistor to enable the integrated TPM. SPI_MOSI has an integrated pull-down resistor enabled at reset only and does not require an external pull-down resistor to disable integrated TPM.
- **Soft Strap:** The integrated TPM Disable bit (bit 2) in the (G)MCHSTRP0 register (FSMBA + 0h) within the flash descriptor can act as an override to the functional straps on both the ICH and (G)MCH. When set, the integrated TPM will be disabled regardless of the values of the functional straps on the ICH and/or (G)MCH. This bit along with both functional straps must be appropriately configured to enable integrated TPM.
- **(G)MCH Functional Strap:** For (G)MCH functional strap information, consult the appropriate (G)MCH documentation.

§ §

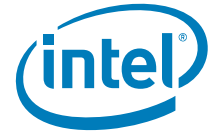

6 Ballout Definition

This chapter contains the Intel® ICH10 ballout information.

6.1 Intel® ICH10 Ballout

This section contains the ICH10 ballout. [Figure 6-1](#) and [Figure 6-2](#) show the ballout from a top of the package view. [Table 6-1](#) is the BGA ball list, sorted alphabetically by signal name.

Note: Notes for [Figure 6-1](#), [Figure 6-2](#), and [Table 6-1](#)

1. § symbol indicates a particular use of a pin is Consumer Only.
2. † symbol indicates a particular use of a pin is Corporate Only.



Figure 6-1. Intel® ICH10 Ballout (Top view–Left Side)

| | 1 | 2 | 3 | 4 | 5 | 6 | 7 | 8 | 9 | 10 | 11 | 12 | 13 | 14 | 15 | |
|----|-----------------------------------------|-------------------|-----------------|-----------|------------------------------|----------------|-----------------|----------------|---------------------------------------------------------|-----------|--------------------|----------------------------------------|---------------------------|------------------|-------------------|----|
| A | Vss | Vcc3_3 | PIRQD# | AD11 | AD4 | V5REF | GNT1# / GPIO51 | GPIO12 | GPIO14 / JTAGDI [†] / OST_BMBUSY# [§] | VccLAN1_1 | GPIO27 | VccLAN3_3 | SLP_S3# | GPIO24 / MEM_LED | SMLINK0 | A |
| B | Vcc3_3 | Vss | PCICLK | AD9 | Vss | AD8 | AD7 | Vss | Vcc3_3 | VccLAN1_1 | Vss | VccLAN3_3 | SLP_S4# | Vss | SMLINK1 | B |
| C | AD24 | AD25 | AD26 | C/BE2# | AD14 | DEVSEL# | GNT2# / GPIO53 | AD1 | AD3 | AD0 | S4_STATE# / GPIO26 | GPIO57 / TPM_PP / JTAGTCK [†] | GPIO72 [†] / TP0 | PLTRST# | STP_PCI# / GPIO15 | C |
| D | AD27 | AD15 | AD21 | | | | | | | | | | | | | D |
| E | PIRQB# | Vss | PAR | | AD16 | TRDY# | AD10 | C/BE3# | AD2 | AD6 | AD18 | AD5 | LAN_RXD2 | LAN_RSTS_YNC | Vss | E |
| F | PIRQC# | PIRQG# / GPIO4 | AD29 | | PERR# | Vss | GNT3# / GPIO55 | AD13 | Vss | STOP# | C/BE0# | Vss | REQ2# / GPIO52 | LAN_TXD1 | LAN_TXD0 | F |
| G | AD30 | PIRQH# / GPIO5 | Vcc3_3 | | AD23 | AD20 | AD17 | REQ3# / GPIO54 | C/BE1# | AD19 | Vcc3_3 | FRAME# | REQ1# / GPIO50 | LAN_TXD2 | LAN_RXD0 | G |
| H | FWH1 / LAD1 | Vss | AD31 | | GNT0# | AD22 | Vcc3_3 | PLOCK# | Vss | Vcc1_5_A | Vcc1_5_A | AD12 | Vss | LAN_RXD1 | VccSus3_3 | H |
| J | FWH3 / LAD3 | Vcc3_3 | LDRQ1# / GPIO23 | | PIRQA# | Vss | AD28 | IRDY# | | | | | | | | J |
| K | GPIO18 | GPIO32 | FWH0 / LAD0 | | SERR# | PIRQE# / GPIO2 | REQ0# | Vcc3_3 | | | | | | | | K |
| L | SATACLKR EQ# / GPIO35 | Vss | RCIN# | | FWH4 / LFRAME# | LDRQ0# | PIRQF# / GPIO3 | Vcc3_3 | | | | | | | | L |
| M | OC7# / GPIO31 | GPIO16 / DPRSLPVR | INIT3_3V# | | CLK14 | Vss | FWH2 / LAD2 | Vss | | | | Vcc1_1 | Vcc1_1 | Vss | Vcc1_1 | M |
| N | OC5# / GPIO29 | OC4# / GPIO43 | OC1# / GPIO40 | | OC6# / GPIO30 | SERIRQ | GPIO0 / BMBUSY# | SPKR | | | | Vcc1_1 | Vss | Vss | Vss | N |
| P | OC11# / GPIO47 | Vss | OC8# / GPIO44 | | OC0# / GPIO59 | Vss | OC2# / GPIO41 | A20GATE | | | | Vss | Vss | Vss | Vss | P |
| R | SUS_STAT# / LPCPD / GPIO61 [†] | PCIRST# | PME# | | SUSCLK / GPIO62 [†] | OC9# / GPIO45 | OC3# / GPIO42 | Vss | | | | Vcc1_1 | Vss | Vss | Vss | R |
| T | Vcc1_5_A | Vss | PWRBTN# | | Vss | CLPWROK | OC10# / GPIO46 | CK_PWRGD | | | | Vss | Vss | Vss | Vss | T |
| U | VccSus3_3 | VccSus3_3 | VccSus3_3 | | VccSus3_3 | VccSus3_3 | VccSus3_3 | VccSus3_3 | | | | Vcc1_1 | Vss | Vss | Vss | U |
| V | USBP11N | USBP11P | Vss | | USBP9P | USBP9N | Vss | VccSus3_3 | | | | Vcc1_1 | Vss | Vss | Vss | V |
| W | Vss | USBP10N | USBP10P | | Vss | Vss | VccSus3_3 | VccSus3_3 | | | | Vcc1_1 | Vcc1_1 | Vss | Vcc1_1 | W |
| Y | USBP8N | USBP8P | Vss | | USBP6P | USBP6N | Vss | VccSus3_3 | | | | | | | | Y |
| AA | Vss | USBP7P | USBP7N | | Vss | Vss | Vcc1_5_A | Vcc1_5_A | | | | | | | | AA |
| AB | USBP5N | USBP5P | Vss | | USBP3P | USBP3N | Vcc1_5_A | Vcc1_5_A | | | | | | | | AB |
| AC | Vss | USBP4P | USBP4N | | Vss | Vss | VccSus1_1 | Vss | VccSusHDA | VccHDA | Vcc1_5_A | Vss | Vcc1_5_A | Vcc1_5_A | Vcc1_5_A | AC |
| AD | USBP2N | USBP2P | Vss | | USBP0P | USBP0N | Vss | VccSus1_5 | Vss | Vcc3_3 | Vcc1_5_A | Vcc1_5_A | Vcc1_5_A | Vss | Vss | AD |
| AE | Vss | USBP1P | USBP1N | | Vss | Vss | SATALED# | Vss | Vss | Vss | Vcc1_5_A | Vss | Vss | Vss | Vss | AE |
| AF | V5REF_Sus | VccSus3_3 | Vss | | GPIO20 | GPIO33 | Vss | SATA5TXN | Vss | SATA4TXN | Vcc1_5_A | SATA3TXN | Vss | SATA2TXP | Vss | AF |
| AG | USBRBIAS# | USBRBIAS | CLK48 | | | | | | | | | | | | | AG |
| AH | HDA_SDIN2 | Vss | HDA_BIT_CLK | HDA_SDIN1 | GPIO34 | Vss | SATA5TXP | Vss | SATA4TXP | Vcc1_5_A | Vcc1_5_A | SATA3TXP | Vss | SATA2TXN | Vss | AH |
| AJ | HDA_RST# | HDA_SDOU_T | HDA_SDIN3 | Vss | Vss | SATARBIAS | SATA5RXN | Vss | SATA4RXN | Vcc1_5_A | SATA3RXN | Vss | SATA2RXN | Vss | SATA1RXN | AJ |
| AK | HDA_SYNC | Vss | HDA_SDIN0 | Vcc3_3 | VccUSBPLL | SATARBIAS# | SATA5RXP | Vss | SATA4RXP | Vcc1_5_A | SATA3RXP | Vss | SATA2RXP | Vss | SATA1RXP | AK |



Figure 6-2. Intel® ICH10 Ballout (Top view–Right Side)

| | 16 | 17 | 18 | 19 | 20 | 21 | 22 | 23 | 24 | 25 | 26 | 27 | 28 | 29 | 30 | |
|----|-------------------------------------|-------------------------------------------|---------------------------------------|----------------|---------------------------|---------------------|---------------------|------------------------|--------------------|---------------------|---------------------|----------------|---------------------|---------------------|---------------------|----|
| A | TP6 | VccSus3_3 | GPIO9 | GPIO13 | DRAMPWR Ok↑ / GPIO8 | RTCX1 | VccRTC | VccCL1_1 | Vcc1_1 | RTCRST# | VccCL1_5 | VccGLAN 3_3 | VccGLANPL L | GLAN_COM PO | Vss | A |
| B | TP7 | Vss | STP_CPU# / GPIO25↑ | Vss | VccSus3_3 | RTCX2 | Vss | VccCL3_3 | Vcc1_1 | Vss | SPI_MISO | Vss | Vss | GLAN_COM PI | VccGLAN1_5 | B |
| C | SMBALERT# / GPIO11 / JTAGTDO↑ | GPIO10 / CPU_MISSI NG / JTAGTMS↑ | TP5 | SST | VccSus3_3 | LAN_RST# | VRMPWRG D | VccCL3_3 | Vcc1_1 | PWROK | SPI_MOSI | CL_VREF 0 | VccGLAN1_5 | VccGLAN1_5 | VccGLAN1_5 | C |
| D | | | | | | | | | | | | | Vss | PERn6 / GLAN_RXN | PERp6 / GLAN_RXP | D |
| E | SMBDATA | VccSus3_3 | Vss | TP4 | WAKE# | LAN100_SL P | Vss | INTVRMEN | Vcc1_1 | SPI_CS0# | PETn6 / GLAN_TXN | | PETp6 / GLAN_TXP | Vss | Vss | E |
| F | GPIO56 | SLP_M# | LINKALERT# / GPIO60 / JTAGRST#↑ | SYS_RESE T# | TP3 | Vss | RSMRST# | SPI_CS1# | Vcc1_1 | GLAN_CLK | Vss | | Vss | PERp5 | PERn5 | F |
| G | Vss | SLP_S5# / GPIO63↑ | GPIO28 | RI# | CL_RST0# | INTRUDER# | CL_CLK0 | SPI_CLK | Vcc1_1 | Vss | PETn5 | | PETp5 | Vss | Vss | G |
| H | SMBCLK | VccSus1_1 | VccSus1_5 | Vss | SRTCST# | CL_DATA0 | Vss | Vcc1_1 | Vcc1_1 | Vss | Vss | | Vss | PERp4 | PERn4 | H |
| J | | | | | | | | Vcc1_1 | Vcc1_5_B | Vcc1_5_B | PETn4 | | PETp4 | Vss | Vss | J |
| K | | | | | | | | Vcc1_5_B | Vcc1_5_B | Vcc1_5_B | Vss | | Vss | PERp3 | PERn3 | K |
| L | | | | | | | | Vss | Vcc1_5_B | Vcc1_5_B | PETn3 | | PETp3 | Vss | Vss | L |
| M | Vss | Vcc1_1 | Vcc1_1 | Vcc1_1 | | | | Vcc1_5_B | Vcc1_5_B | Vcc1_5_B | Vss | | Vss | PERp2 | PERn2 | M |
| N | Vss | Vss | Vss | Vcc1_1 | | | | Vss | Vcc1_5_B | Vcc1_5_B | PETn2 | | PETp2 | Vss | Vss | N |
| P | Vss | Vss | Vss | Vss | | | | Vcc1_5_B | Vcc1_5_B | Vcc1_5_B | Vss | | Vss | PERp1 | PERn1 | P |
| R | Vss | Vss | Vss | Vcc1_1 | | | | Vss | Vcc1_5_B | Vcc1_5_B | PETn1 | | PETp1 | Vss | Vss | R |
| T | Vss | Vss | Vss | Vss | | | | Vcc1_5_B | Vcc1_5_B | Vcc1_5_B | Vcc1_5_B | | Vcc1_5_B | Vss | VccDMIPLL | T |
| U | Vss | Vss | Vss | Vcc1_1 | | | | Vss | Vcc1_5_B | DMI_CLKP | DMI_CLKN | | Vcc1_5_B | Vcc1_5_B | Vcc1_5_B | U |
| V | Vss | Vss | Vss | Vcc1_1 | | | | Vcc1_5_B | Vcc1_5_B | Vcc1_5_B | Vss | | Vss | DMI0TXP | DMI0TXN | V |
| W | Vss | Vcc1_1 | Vcc1_1 | Vcc1_1 | | | | Vss | Vcc1_5_B | Vcc1_5_B | DMI0RXP | | DMI0RXN | Vss | Vss | W |
| Y | | | | | | | | Vcc1_5_B | Vcc1_5_B | Vcc1_5_B | Vss | | Vss | DMI1TXP | DMI1TXN | Y |
| AA | | | | | | | | Vcc1_5_B | Vcc1_5_B | Vcc1_5_B | DMI1RXN | | DMI1RXP | Vss | Vss | AA |
| AB | | | | | | | | Vcc1_5_A | Vcc1_5_B | Vcc1_5_B | Vss | | Vss | DMI2TXP | DMI2TXN | AB |
| AC | Vcc1_5_A | Vcc1_5_A | Vcc1_5_A | Vcc3_3 | Vcc1_5_A | Vcc3_3 | IGNNE# | PECI | Vss | Vcc1_5_B | DMI2RXN | | DMI2RXP | Vss | Vss | AC |
| AD | Vss | Vcc1_5_A | Vss | Vss | SDATAOUT 1 / GPIO48 | SATA5GP | Vss | CPUPWRG D | THRMTRIP# | Vcc1_5_B | Vcc1_5_B | | Vcc1_5_B | DMI3TXN | DMI3TXP | AD |
| AE | Vss | Vcc1_5_A | Vss | Vss | SATA1GP / GPIO19 | SATA2GP / GPIO36 | SATA3GP / GPIO37 | INIT# | DPSLP# | Vss | DMI3RXP | | Vcc1_5_B | Vcc1_5_B | Vcc1_5_B | AE |
| AF | SATA1TXP | Vcc1_5_A | SATA_CLKN | SATA_CLK P | Vss | Vcc3_3 | SATA4GP | Vss | NMI | Vss | DMI3RXN | | DMI_IRCO MP | Vss | DMI_ZCOM P | AF |
| AG | | | | | | | | | | | | | Vss | VccDMI | VccDMI | AG |
| AH | SATA1TXN | Vcc1_5_A | Vcc1_5_A | Vss | Vss | TACH0 / GPIO17 | TACH2 / GPIO6 | SDATAOUT 0 / GPIO39 | Vcc3_3 | MCH_SYNC# | SMI# | INTR | V_CPU_IO | Vss | Vcc3_3 | AH |
| AJ | Vss | SATA0RXP | Vcc1_5_A | SATA0TXP | Vss | PWM0 | PWM1 | Vss | SCLOCK / GPIO22 | GPIO49 | Vss | FERR# | A20M# | STPCLK# | V_CPU_IO | AJ |
| AK | Vss | SATA0RXN | Vcc1_5_A | SATA0TXN | VccSATAPL L | TACH1 / GPIO1 | PWM2 | TACH3 / GPIO7 | SLOAD / GPIO38 | SATA0GP / GPIO21 | THRM# | Vss | DPRSTP# | Vss | Vss | AK |

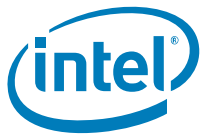

Table 6-1. Intel® ICH10 Ballout by Signal Name

| Ball Name | Ball # |
|-----------|--------|
| A20GATE | P8 |
| A20M# | AJ28 |
| AD0 | C10 |
| AD1 | C8 |
| AD2 | E9 |
| AD3 | C9 |
| AD4 | A5 |
| AD5 | E12 |
| AD6 | E10 |
| AD7 | B7 |
| AD8 | B6 |
| AD9 | B4 |
| AD10 | E7 |
| AD11 | A4 |
| AD12 | H12 |
| AD13 | F8 |
| AD14 | C5 |
| AD15 | D2 |
| AD16 | E5 |
| AD17 | G7 |
| AD18 | E11 |
| AD19 | G10 |
| AD20 | G6 |
| AD21 | D3 |
| AD22 | H6 |
| AD23 | G5 |
| AD24 | C1 |
| AD25 | C2 |
| AD26 | C3 |
| AD27 | D1 |
| AD28 | J7 |
| AD29 | F3 |
| AD30 | G1 |
| AD31 | H3 |
| C/BE0# | F11 |
| C/BE1# | G9 |
| C/BE2# | C4 |
| C/BE3# | E8 |
| CK_PWRGD | T8 |

Table 6-1. Intel® ICH10 Ballout by Signal Name

| Ball Name | Ball # |
|--------------------------------|--------|
| CL_CLK0 | G22 |
| CL_DATA0 | H21 |
| CL_RST0# | G20 |
| CL_VREF0 | C27 |
| CLK14 | M5 |
| CLK48 | AG3 |
| CLPWROK | T6 |
| CPUPWRGD | AD23 |
| DEVSEL# | C6 |
| DMI_CLKN | U26 |
| DMI_CLKP | U25 |
| DMI_IRCOMP | AF28 |
| DMI_ZCOMP | AF30 |
| DMIORXN | W28 |
| DMIORXP | W26 |
| DMIOTXN | V30 |
| DMIOTXP | V29 |
| DMI1RXN | AA26 |
| DMI1RXP | AA28 |
| DMI1TXN | Y30 |
| DMI1TXP | Y29 |
| DMI2RXN | AC26 |
| DMI2RXP | AC28 |
| DMI2TXN | AB30 |
| DMI2TXP | AB29 |
| DMI3RXN | AF26 |
| DMI3RXP | AE26 |
| DMI3TXN | AD29 |
| DMI3TXP | AD30 |
| DRAMPWROK [†] / GPIO8 | A20 |
| FERR# | AJ27 |
| FRAME# | G12 |
| FWH0 / LAD0 | K3 |
| FWH1 / LAD1 | H1 |
| FWH2 / LAD2 | M7 |
| FWH3 / LAD3 | J1 |
| FWH4 / LFRAME# | L5 |
| GLAN_CLK | F25 |

Table 6-1. Intel® ICH10 Ballout by Signal Name

| Ball Name | Ball # |
|----------------------------------------------------------|--------|
| GLAN_COMP1 | B29 |
| GLAN_COMPO | A29 |
| GNT0# | H5 |
| GNT1# / GPIO51 | A7 |
| GNT2# / GPIO53 | C7 |
| GNT3# / GPIO55 | F7 |
| GPIO0 | N7 |
| GPIO10 / CPU_MISSING / JTAGTMS [†] | C17 |
| GPIO12 | A8 |
| GPIO13 | A19 |
| GPIO14 / JTAGTDI [†] / QST_BMBUSY# [§] | A9 |
| GPIO16 / DPRSLPVR | M2 |
| GPIO18 | K1 |
| GPIO20 | AF5 |
| GPIO24 | A14 |
| GPIO27 | A11 |
| GPIO28 | G18 |
| GPIO32 | K2 |
| GPIO33 | AF6 |
| GPIO34 | AH5 |
| GPIO49 | AJ25 |
| GPIO56 | F16 |
| GPIO57 / TPM_PP / JTAGTCK [†] | C12 |
| GPIO72 [†] / TP0 | C13 |
| GPIO9 | A18 |
| HDA_BIT_CLK | AH3 |
| HDA_RST# | AJ1 |
| HDA_SDIN0 | AK3 |
| HDA_SDIN1 | AH4 |
| HDA_SDIN2 | AH1 |
| HDA_SDIN3 | AJ3 |
| HDA_SDOUT | AJ2 |
| HDA_SYNC | AK1 |
| IGNNE# | AC22 |
| INIT# | AE23 |
| INIT3_3V# | M3 |



Table 6-1. Intel® ICH10 Ballout by Signal Name

| Ball Name | Ball # |
|---------------------------------|--------|
| INTR | AH27 |
| INTRUDER# | G21 |
| INTVRMEN | E23 |
| IRDY# | J8 |
| LAN_RST# | C21 |
| LAN_RSTSYNC | E14 |
| LAN_RXD0 | G15 |
| LAN_RXD1 | H14 |
| LAN_RXD2 | E13 |
| LAN_TXD0 | F15 |
| LAN_TXD1 | F14 |
| LAN_TXD2 | G14 |
| LAN100_SLP | E21 |
| LDRQ0# | L6 |
| LDRQ1# / GPIO23 | J3 |
| LINKALERT# / GPIO60 / JTAGRST#† | F18 |
| MCH_SYNC# | AH25 |
| NMI | AF24 |
| OC0# / GPIO59 | P5 |
| OC1# / GPIO40 | N3 |
| OC2# / GPIO41 | P7 |
| OC3# / GPIO42 | R7 |
| OC4# / GPIO43 | N2 |
| OC5# / GPIO29 | N1 |
| OC6# / GPIO30 | N5 |
| OC7# / GPIO31 | M1 |
| OC8# / GPIO44 | P3 |
| OC9# / GPIO45 | R6 |
| OC10# / GPIO46 | T7 |
| OC11# / GPIO47 | P1 |
| PAR | E3 |
| PCICLK | B3 |
| PCIRST# | R2 |
| PECI | AC23 |
| PERn1 | P30 |
| PERn2 | M30 |
| PERn3 | K30 |
| PERn4 | H30 |

Table 6-1. Intel® ICH10 Ballout by Signal Name

| Ball Name | Ball # |
|------------------|--------|
| PERn5 | F30 |
| PERn6 / GLAN_RXN | D29 |
| PERp1 | P29 |
| PERp2 | M29 |
| PERp3 | K29 |
| PERp4 | H29 |
| PERp5 | F29 |
| PERp6 / GLAN_RXP | D30 |
| PERR# | F5 |
| PETn1 | R26 |
| PETn2 | N26 |
| PETn3 | L26 |
| PETn4 | J26 |
| PETn5 | G26 |
| PETn6 / GLAN_TXN | E26 |
| PETp1 | R28 |
| PETp2 | N28 |
| PETp3 | L28 |
| PETp4 | J28 |
| PETp5 | G28 |
| PETp6 / GLAN_TXP | E28 |
| PIRQA# | J5 |
| PIROB# | E1 |
| PIROC# | F1 |
| PIROD# | A3 |
| PIROE# / GPIO2 | K6 |
| PIROF# / GPIO3 | L7 |
| PIROG# / GPIO4 | F2 |
| PIROH# / GPIO5 | G2 |
| PLOCK# | H8 |
| PLTRST# | C14 |
| PME# | R3 |
| PWM0 | AJ21 |
| PWM1 | AJ22 |
| PWM2 | AK22 |
| PWRBTN# | T3 |
| PWROK | C25 |
| RCIN# | L3 |
| REQ0# | K7 |

Table 6-1. Intel® ICH10 Ballout by Signal Name

| Ball Name | Ball # |
|--------------------|--------|
| REQ1# / GPIO50 | G13 |
| REQ2# / GPIO52 | F13 |
| REQ3# / GPIO54 | G8 |
| RI# | G19 |
| RSMRST# | F22 |
| RTCST# | A25 |
| RTCX1 | A21 |
| RTCX2 | B21 |
| S4_STATE# / GPIO26 | C11 |
| SATA_CLKN | AF18 |
| SATA_CLKP | AF19 |
| SATA0GP / GPIO21 | AK25 |
| SATA0RXN | AK17 |
| SATA0RXP | AJ17 |
| SATA0TXN | AK19 |
| SATA0TXP | AJ19 |
| SATA1GP / GPIO19 | AE20 |
| SATA1RXN | AJ15 |
| SATA1RXP | AK15 |
| SATA1TXN | AH16 |
| SATA1TXP | AF16 |
| SATA2GP / GPIO36 | AE21 |
| SATA2RXN | AJ13 |
| SATA2RXP | AK13 |
| SATA2TXN | AH14 |
| SATA2TXP | AF14 |
| SATA3GP / GPIO37 | AE22 |
| SATA3RXN | AJ11 |
| SATA3RXP | AK11 |
| SATA3TXN | AF12 |
| SATA3TXP | AH12 |
| SATA4GP | AF22 |
| SATA4RXN | AJ9 |
| SATA4RXP | AK9 |
| SATA4TXN | AF10 |
| SATA4TXP | AH9 |
| SATA5GP | AD21 |
| SATA5RXN | AJ7 |



Table 6-1. Intel® ICH10 Ballout by Signal Name

| Ball Name | Ball # |
|-------------------------------|--------|
| SATA5RXP | AK7 |
| SATA5TXN | AF8 |
| SATA5TXP | AH7 |
| SATACLKREQ# / GPIO35 | L1 |
| SATALED# | AE7 |
| SATARBIAS | AJ6 |
| SATARBIAS# | AK6 |
| SCLOCK / GPIO22 | AJ24 |
| SDATAOUT0 / GPIO39 | AH23 |
| SDATAOUT1 / GPIO48 | AD20 |
| SERIRQ | N6 |
| SERR# | K5 |
| SLOAD / GPIO38 | AK24 |
| SLP_M# | F17 |
| SLP_S3# | A13 |
| SLP_S4# | B13 |
| SLP_S5# / GPIO63† | G17 |
| SMBALERT# / GPIO11 / JTAGTDO† | C16 |
| SMBCLK | H16 |
| SMBDATA | E16 |
| SMI# | AH26 |
| SMLINK0 | A15 |
| SMLINK1 | B15 |
| SPI_CLK | G23 |
| SPI_CS0# | E25 |
| SPI_CS1# | F23 |
| SPI_MISO | B26 |
| SPI_MOSI | C26 |
| SPKR | N8 |
| SRTCST# | H20 |
| SST | C19 |
| STOP# | F10 |
| STP_CPU# / GPIO25† | B18 |
| STP_PCI# / GPIO15 | C15 |
| STPCLK# | AJ29 |

Table 6-1. Intel® ICH10 Ballout by Signal Name

| Ball Name | Ball # |
|-----------------------------|--------|
| SUS_STAT# / LPCPD / GPIO61† | R1 |
| SUSCLK / GPIO62† | R5 |
| SYS_RESET# | F19 |
| TACH0 / GPIO17 | AH21 |
| TACH1 / GPIO1 | AK21 |
| TACH2 / GPIO6 | AH22 |
| TACH3 / GPIO7 | AK23 |
| THRM# | AK26 |
| THRMTRIP# | AD24 |
| DPRSTP# | AK28 |
| DPSLP# | AE24 |
| TP3 | F20 |
| TP4 | E19 |
| TP5 | C18 |
| TP6 | A16 |
| TP7 | B16 |
| TRDY# | E6 |
| USBP0N | AD6 |
| USBP0P | AD5 |
| USBP10N | W2 |
| USBP10P | W3 |
| USBP11N | V1 |
| USBP11P | V2 |
| USBP1N | AE3 |
| USBP1P | AE2 |
| USBP2N | AD1 |
| USBP2P | AD2 |
| USBP3N | AB6 |
| USBP3P | AB5 |
| USBP4N | AC3 |
| USBP4P | AC2 |
| USBP5N | AB1 |
| USBP5P | AB2 |
| USBP6N | Y6 |
| USBP6P | Y5 |
| USBP7N | AA3 |
| USBP7P | AA2 |
| USBP8N | Y1 |

Table 6-1. Intel® ICH10 Ballout by Signal Name

| Ball Name | Ball # |
|-----------|--------|
| USBP8P | Y2 |
| USBP9N | V6 |
| USBP9P | V5 |
| USBRBIAS | AG2 |
| USBRBIAS# | AG1 |
| V_CPU_IO | AH28 |
| V_CPU_IO | AJ30 |
| V5REF | A6 |
| V5REF_Sus | AF1 |
| Vcc1_1 | A24 |
| Vcc1_1 | B24 |
| Vcc1_1 | C24 |
| Vcc1_1 | E24 |
| Vcc1_1 | F24 |
| Vcc1_1 | G24 |
| Vcc1_1 | H23 |
| Vcc1_1 | H24 |
| Vcc1_1 | J23 |
| Vcc1_1 | M12 |
| Vcc1_1 | M13 |
| Vcc1_1 | M15 |
| Vcc1_1 | M17 |
| Vcc1_1 | M18 |
| Vcc1_1 | M19 |
| Vcc1_1 | N12 |
| Vcc1_1 | N19 |
| Vcc1_1 | R12 |
| Vcc1_1 | R19 |
| Vcc1_1 | U12 |
| Vcc1_1 | U19 |
| Vcc1_1 | V12 |
| Vcc1_1 | V19 |
| Vcc1_1 | W12 |
| Vcc1_1 | W13 |
| Vcc1_1 | W15 |
| Vcc1_1 | W17 |
| Vcc1_1 | W18 |
| Vcc1_1 | W19 |
| Vcc1_5_A | AA7 |



Table 6-1. Intel® ICH10 Ballout by Signal Name

| Ball Name | Ball # |
|-----------|--------|
| Vcc1_5_A | AA8 |
| Vcc1_5_A | AB7 |
| Vcc1_5_A | AB8 |
| Vcc1_5_A | AB23 |
| Vcc1_5_A | AC11 |
| Vcc1_5_A | AC13 |
| Vcc1_5_A | AC14 |
| Vcc1_5_A | AC15 |
| Vcc1_5_A | AC16 |
| Vcc1_5_A | AC17 |
| Vcc1_5_A | AC18 |
| Vcc1_5_A | AC20 |
| Vcc1_5_A | AD11 |
| Vcc1_5_A | AD12 |
| Vcc1_5_A | AD13 |
| Vcc1_5_A | AD17 |
| Vcc1_5_A | AE11 |
| Vcc1_5_A | AE17 |
| Vcc1_5_A | AF11 |
| Vcc1_5_A | AF17 |
| Vcc1_5_A | AH10 |
| Vcc1_5_A | AH11 |
| Vcc1_5_A | AH17 |
| Vcc1_5_A | AH18 |
| Vcc1_5_A | AJ10 |
| Vcc1_5_A | AJ18 |
| Vcc1_5_A | AK10 |
| Vcc1_5_A | AK18 |
| Vcc1_5_A | H10 |
| Vcc1_5_A | H11 |
| Vcc1_5_A | T1 |
| Vcc1_5_B | AA23 |
| Vcc1_5_B | AA24 |
| Vcc1_5_B | AA25 |
| Vcc1_5_B | AB24 |
| Vcc1_5_B | AB25 |
| Vcc1_5_B | AC25 |
| Vcc1_5_B | AD25 |
| Vcc1_5_B | AD26 |

Table 6-1. Intel® ICH10 Ballout by Signal Name

| Ball Name | Ball # |
|-----------|--------|
| Vcc1_5_B | AD28 |
| Vcc1_5_B | AE28 |
| Vcc1_5_B | AE29 |
| Vcc1_5_B | AE30 |
| Vcc1_5_B | J24 |
| Vcc1_5_B | J25 |
| Vcc1_5_B | K23 |
| Vcc1_5_B | K24 |
| Vcc1_5_B | K25 |
| Vcc1_5_B | L24 |
| Vcc1_5_B | L25 |
| Vcc1_5_B | M23 |
| Vcc1_5_B | M24 |
| Vcc1_5_B | M25 |
| Vcc1_5_B | N24 |
| Vcc1_5_B | N25 |
| Vcc1_5_B | P23 |
| Vcc1_5_B | P24 |
| Vcc1_5_B | P25 |
| Vcc1_5_B | R24 |
| Vcc1_5_B | R25 |
| Vcc1_5_B | T23 |
| Vcc1_5_B | T24 |
| Vcc1_5_B | T25 |
| Vcc1_5_B | T26 |
| Vcc1_5_B | T28 |
| Vcc1_5_B | U24 |
| Vcc1_5_B | U28 |
| Vcc1_5_B | U29 |
| Vcc1_5_B | U30 |
| Vcc1_5_B | V23 |
| Vcc1_5_B | V24 |
| Vcc1_5_B | V25 |
| Vcc1_5_B | W24 |
| Vcc1_5_B | W25 |
| Vcc1_5_B | Y23 |
| Vcc1_5_B | Y24 |
| Vcc1_5_B | Y25 |
| Vcc3_3 | AC19 |

Table 6-1. Intel® ICH10 Ballout by Signal Name

| Ball Name | Ball # |
|------------|--------|
| Vcc3_3 | AC21 |
| Vcc3_3 | AD10 |
| Vcc3_3 | AF21 |
| Vcc3_3 | AH24 |
| Vcc3_3 | AH30 |
| Vcc3_3 | AK4 |
| Vcc3_3 | A2 |
| Vcc3_3 | B1 |
| Vcc3_3 | B9 |
| Vcc3_3 | G3 |
| Vcc3_3 | G11 |
| Vcc3_3 | H7 |
| Vcc3_3 | J2 |
| Vcc3_3 | K8 |
| Vcc3_3 | L8 |
| VccCL1_1 | A23 |
| VccCL1_5 | A26 |
| VccCL3_3 | B23 |
| VccCL3_3 | C23 |
| VccDMI | AG29 |
| VccDMI | AG30 |
| VccDMIPLL | T30 |
| VccGLAN1_5 | B30 |
| VccGLAN1_5 | C28 |
| VccGLAN1_5 | C29 |
| VccGLAN1_5 | C30 |
| VccGLAN3_3 | A27 |
| VccGLANPLL | A28 |
| VccHDA | AC10 |
| VccLAN1_1 | A10 |
| VccLAN1_1 | B10 |
| VccLAN3_3 | A12 |
| VccLAN3_3 | B12 |
| VccRTC | A22 |
| VccSATAPLL | AK20 |
| VccSus1_1 | AC7 |
| VccSus1_1 | H17 |
| VccSus1_5 | AD8 |
| VccSus1_5 | H18 |

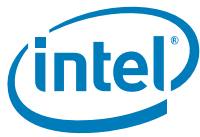

Table 6-1. Intel® ICH10 Ballout by Signal Name

| Ball Name | Ball # |
|-----------|--------|
| VccSus3_3 | AF2 |
| VccSus3_3 | A17 |
| VccSus3_3 | B20 |
| VccSus3_3 | C20 |
| VccSus3_3 | E17 |
| VccSus3_3 | H15 |
| VccSus3_3 | U1 |
| VccSus3_3 | U2 |
| VccSus3_3 | U3 |
| VccSus3_3 | U5 |
| VccSus3_3 | U6 |
| VccSus3_3 | U7 |
| VccSus3_3 | U8 |
| VccSus3_3 | V8 |
| VccSus3_3 | W7 |
| VccSus3_3 | W8 |
| VccSus3_3 | Y8 |
| VccSusHDA | AC9 |
| VccUSBPLL | AK5 |
| VRMPWRGD | C22 |
| Vss | AA1 |
| Vss | AA5 |
| Vss | AA6 |
| Vss | AA29 |
| Vss | AA30 |
| Vss | AB3 |
| Vss | AB26 |
| Vss | AB28 |
| Vss | AC1 |
| Vss | AC5 |
| Vss | AC6 |
| Vss | AC8 |
| Vss | AC12 |
| Vss | AC24 |
| Vss | AC29 |
| Vss | AC30 |
| Vss | AD3 |
| Vss | AD7 |
| Vss | AD9 |

Table 6-1. Intel® ICH10 Ballout by Signal Name

| Ball Name | Ball # |
|-----------|--------|
| Vss | AD14 |
| Vss | AD15 |
| Vss | AD16 |
| Vss | AD18 |
| Vss | AD19 |
| Vss | AD22 |
| Vss | AE1 |
| Vss | AE5 |
| Vss | AE6 |
| Vss | AE8 |
| Vss | AE9 |
| Vss | AE10 |
| Vss | AE12 |
| Vss | AE13 |
| Vss | AE14 |
| Vss | AE15 |
| Vss | AE16 |
| Vss | AE18 |
| Vss | AE19 |
| Vss | AE25 |
| Vss | AF3 |
| Vss | AF7 |
| Vss | AF9 |
| Vss | AF13 |
| Vss | AF15 |
| Vss | AF20 |
| Vss | AF23 |
| Vss | AF25 |
| Vss | AF29 |
| Vss | AG28 |
| Vss | AH2 |
| Vss | AH6 |
| Vss | AH8 |
| Vss | AH13 |
| Vss | AH15 |
| Vss | AH19 |
| Vss | AH20 |
| Vss | AH29 |
| Vss | AJ4 |

Table 6-1. Intel® ICH10 Ballout by Signal Name

| Ball Name | Ball # |
|-----------|--------|
| Vss | AJ5 |
| Vss | AJ8 |
| Vss | AJ12 |
| Vss | AJ14 |
| Vss | AJ16 |
| Vss | AJ20 |
| Vss | AJ23 |
| Vss | AJ26 |
| Vss | AK2 |
| Vss | AK8 |
| Vss | AK12 |
| Vss | AK14 |
| Vss | AK16 |
| Vss | AK27 |
| Vss | AK29 |
| Vss | AK30 |
| Vss | A1 |
| Vss | A30 |
| Vss | B2 |
| Vss | B5 |
| Vss | B8 |
| Vss | B11 |
| Vss | B14 |
| Vss | B17 |
| Vss | B19 |
| Vss | B22 |
| Vss | B25 |
| Vss | B27 |
| Vss | B28 |
| Vss | D28 |
| Vss | E2 |
| Vss | E15 |
| Vss | E18 |
| Vss | E22 |
| Vss | E29 |
| Vss | E30 |
| Vss | F6 |
| Vss | F9 |
| Vss | F12 |



Table 6-1. Intel® ICH10 Ballout by Signal Name

| Ball Name | Ball # |
|-----------|--------|
| Vss | F21 |
| Vss | F26 |
| Vss | F28 |
| Vss | G16 |
| Vss | G25 |
| Vss | G29 |
| Vss | G30 |
| Vss | H2 |
| Vss | H9 |
| Vss | H13 |
| Vss | H19 |
| Vss | H22 |
| Vss | H25 |
| Vss | H26 |
| Vss | H28 |
| Vss | J6 |
| Vss | J29 |
| Vss | J30 |
| Vss | K26 |
| Vss | K28 |
| Vss | L2 |
| Vss | L23 |
| Vss | L29 |
| Vss | L30 |
| Vss | M6 |
| Vss | M8 |
| Vss | M14 |
| Vss | M16 |
| Vss | M26 |
| Vss | M28 |
| Vss | N13 |
| Vss | N14 |
| Vss | N15 |
| Vss | N16 |
| Vss | N17 |
| Vss | N18 |
| Vss | N23 |
| Vss | N29 |
| Vss | N30 |

Table 6-1. Intel® ICH10 Ballout by Signal Name

| Ball Name | Ball # |
|-----------|--------|
| Vss | P2 |
| Vss | P6 |
| Vss | P12 |
| Vss | P13 |
| Vss | P14 |
| Vss | P15 |
| Vss | P16 |
| Vss | P17 |
| Vss | P18 |
| Vss | P19 |
| Vss | P26 |
| Vss | P28 |
| Vss | R8 |
| Vss | R13 |
| Vss | R14 |
| Vss | R15 |
| Vss | R16 |
| Vss | R17 |
| Vss | R18 |
| Vss | R23 |
| Vss | R29 |
| Vss | R30 |
| Vss | T2 |
| Vss | T5 |
| Vss | T12 |
| Vss | T13 |
| Vss | T14 |
| Vss | T15 |
| Vss | T16 |
| Vss | T17 |
| Vss | T18 |
| Vss | T19 |
| Vss | T29 |
| Vss | U13 |
| Vss | U14 |
| Vss | U15 |
| Vss | U16 |
| Vss | U17 |
| Vss | U18 |

Table 6-1. Intel® ICH10 Ballout by Signal Name

| Ball Name | Ball # |
|-----------|--------|
| Vss | U23 |
| Vss | V3 |
| Vss | V7 |
| Vss | V13 |
| Vss | V14 |
| Vss | V15 |
| Vss | V16 |
| Vss | V17 |
| Vss | V18 |
| Vss | V26 |
| Vss | V28 |
| Vss | W1 |
| Vss | W5 |
| Vss | W6 |
| Vss | W14 |
| Vss | W16 |
| Vss | W23 |
| Vss | W29 |
| Vss | W30 |
| Vss | Y3 |
| Vss | Y7 |
| Vss | Y26 |
| Vss | Y28 |
| WAKE# | E20 |





7 Package Information

7.1 Intel® ICH10 Package

The ICH10 package information is shown in Figure 7-1, Figure 7-2, and Figure 7-3.

Note: All dimensions, unless otherwise specified, are in millimeters.

Figure 7-1. Intel® ICH10 Package (Top View)

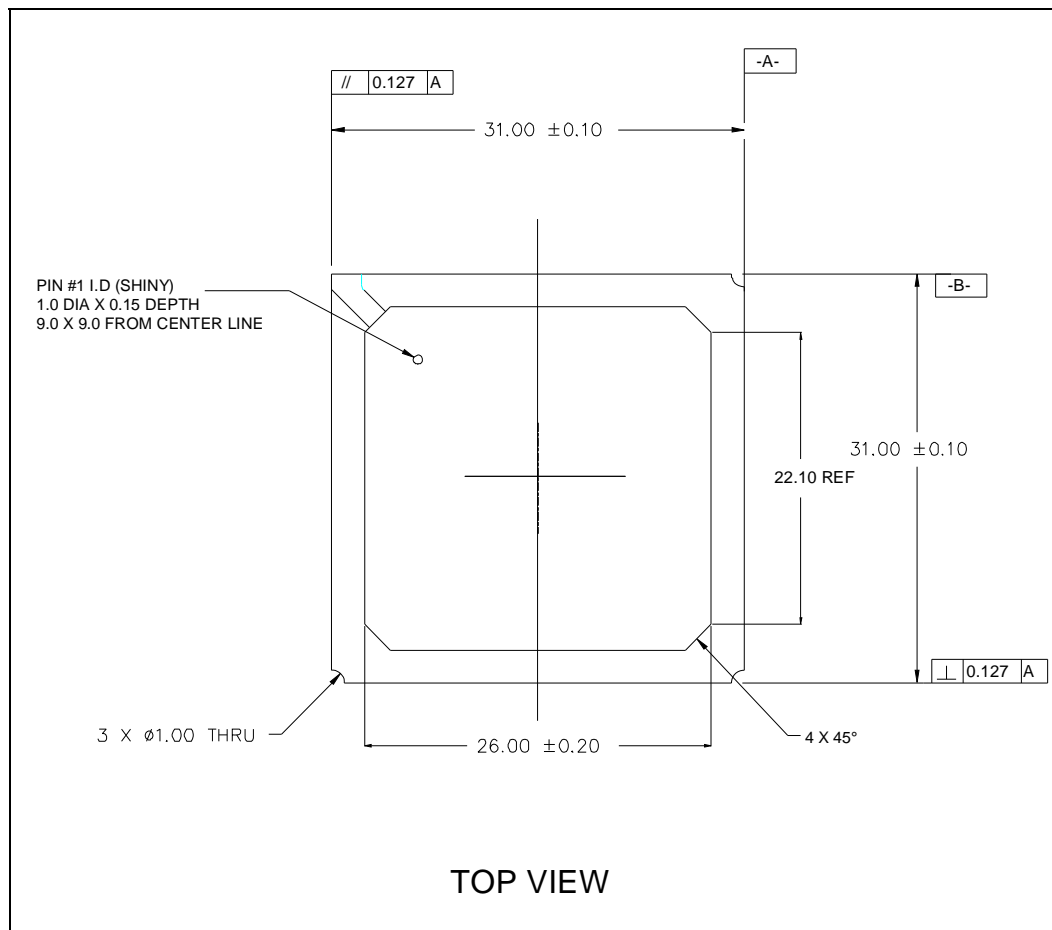

Figure 7-2. Intel® ICH10 Package (Bottom View)

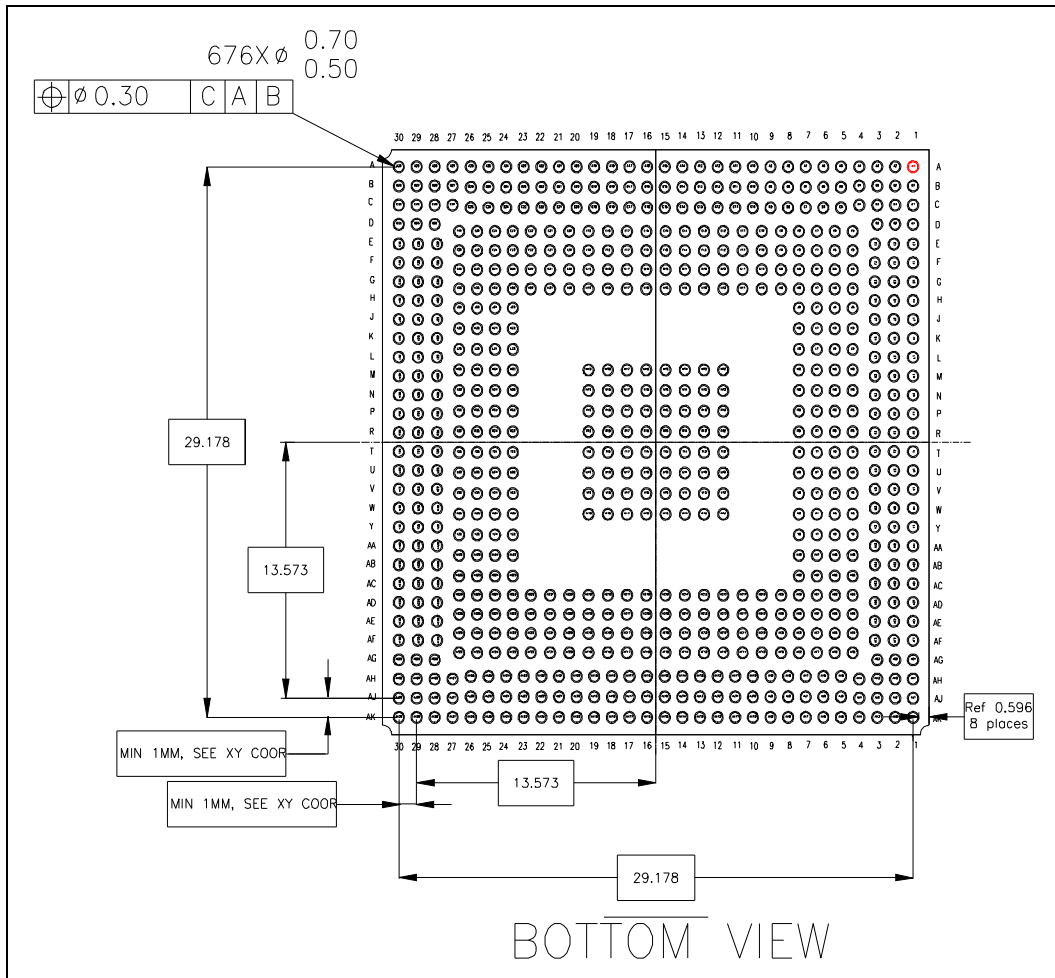
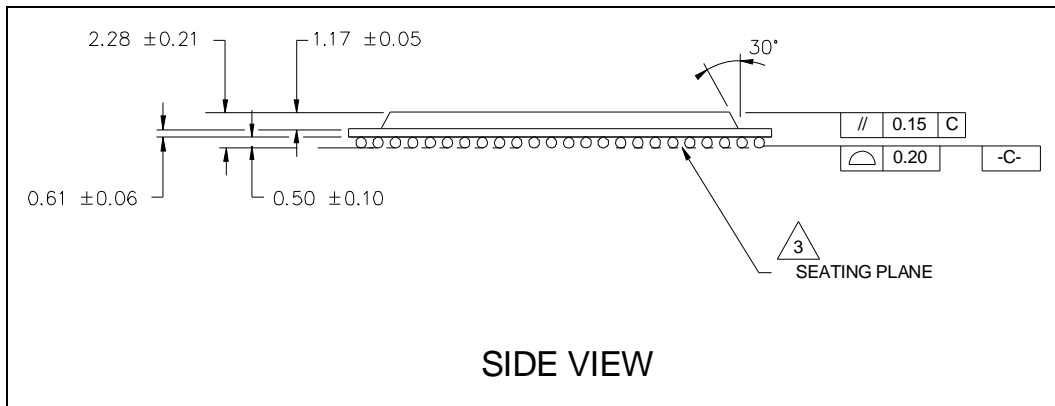

Figure 7-3. Intel® ICH10 Package (Side View)



§ § §



8 Electrical Characteristics

This chapter contains the DC and AC characteristics for the ICH10. AC timing diagrams are included.

8.1 Thermal Specifications

Refer to the *Intel® I/O Controller Hub (ICH10) Thermal Design Guidelines* document for ICH10 thermal information.

8.2 Absolute Maximum Ratings

Table 8-1. Intel® ICH10 Absolute Maximum Ratings

| Parameter | Maximum Limits |
|----------------------------------------------------------------------|------------------------|
| Voltage on any 3.3 V Pin with respect to Ground | -0.5 to Vcc3_3 + 0.5 V |
| Voltage on any 5 V Tolerant Pin with respect to Ground (V5REF = 5 V) | -0.5 to V5REF + 0.5 V |
| 1.1 V Supply Voltage with respect to VSS | -0.5 to 2.1 V |
| 1.25 V Supply Voltage with respect to VSS | -0.5V to 2.1V |
| 1.5 V Supply Voltage with respect to VSS | -0.5 to 2.1 V |
| 3.3 V Supply Voltage with respect to VSS | -0.5 to 4.6 V |
| 5.0 V Supply Voltage with respect to VSS | -0.5 to 5.5 V |
| V_CPU_IO Supply Voltage with respect to VSS | -0.5 to 2.1 V |

8.3 DC Characteristics

Table 8-2. DC Current Characteristics (Consumer Only)¹

| Power Plane | Maximum Power Consumption | | | |
|------------------------|---------------------------|-------|-------|-----|
| | S0 | S3 | S4/S5 | G3 |
| V5REF | 2 mA | N/A | N/A | N/A |
| V5REF_Sus | 2 mA | 1 mA | 1 mA | N/A |
| Vcc3_3 | 308 mA | N/A | N/A | N/A |
| VccSus3_3 | 212 mA | 53 mA | 53 mA | N/A |
| VccHDA ⁶ | 32mA | N/A | N/A | N/A |
| VccSusHDA ₆ | 32 mA | 1 mA | 1 mA | N/A |
| VccGLAN3_3 | 1 mA | N/A | N/A | N/A |
| VccGLAN1_5 | 80 mA | N/A | N/A | N/A |
| VccLAN3_3 ⁵ | 19 mA | 78 mA | 78 mA | N/A |



Table 8-2. DC Current Characteristics (Consumer Only)¹

| Power Plane | Maximum Power Consumption | | | | |
|------------------------|---------------------------|----------------------------|-------------------------------|-------|-----|
| | Symbol | S0 | S3 | S4/S5 | G3 |
| VccLAN1_12, 5 | Powered by Vcc1_1 in S0 | Powered by VccLAN3_3 in S3 | Powered by VccLAN3_3 in S4/S5 | N/A | N/A |
| VccCL3_3 | 19 mA | 73 mA | 73 mA | N/A | N/A |
| VccCL1_5 ² | Powered by Vcc1_5_A in S0 | Powered by VccCL3_3 in S3 | Powered by VccCL3_3 in S4/S5 | N/A | N/A |
| VccCL1_12 | Powered by Vcc1_1 in S0 | Powered by VccCL3_3 in S3 | Powered by VccCL3_3 in S4/S5 | N/A | N/A |
| Vcc1_5_A | 1.644 A | N/A | N/A | N/A | N/A |
| Vcc1_5_B | 646 mA | N/A | N/A | N/A | N/A |
| VccSus1_52 | Powered by Vcc1_5_A in S0 | Powered by VccSus3_3 in S3 | Powered by VccSus3_3 in S4/S5 | N/A | N/A |
| Vcc1_1 | 1.634 A | N/A | N/A | N/A | N/A |
| VccSus1_12 | Powered by Vcc1_1 in S0 | Powered by VccSus3_3 in S3 | Powered by VccSus3_3 in S4/S5 | N/A | N/A |
| VccRTC ^{3, 4} | N/A | N/A | N/A | 6 μA | N/A |
| VccDMI ⁷ | 50 mA | N/A | N/A | N/A | N/A |
| V_CPU_IO | 2 mA | N/A | N/A | N/A | N/A |
| VccGLANPLL | 23 mA | N/A | N/A | N/A | N/A |
| VccUSBPLL | 11 mA | N/A | N/A | N/A | N/A |
| VccDMIPLL ⁷ | 23 mA | N/A | N/A | N/A | N/A |
| VccSATAPLL | 47 mA | N/A | N/A | N/A | N/A |

NOTES:

1. These are estimated DC current numbers.
2. Internal voltage regulators power these wells inside the Intel ICH10 and current for these rails are accounted for in the sourcing voltage rail current requirements.
3. Only the G3 state of this rail is shown to provide an estimate of battery life.
4. Icc (RTC) data is taken with VccRTC at 3.0 V while the system is in a mechanical off (G3) state at room temperature.
5. The current for this rail in S3 and S4/S5 is based on the integrated LAN running at 10/100.
6. The current for this rail was measured with VccHDA and VccSusHDA set to 3.3 V.
7. The current for this rail was measured with VccDMI set to 1.5 V.

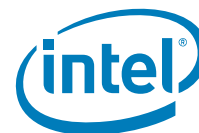

Table 8-3. DC Current Characteristics (Corporate Only)

| Power Plane | Maximum Power Consumption | | | |
|---------------------------|---------------------------|----------------------------|----------------------------|-----------|
| | S0 | S3 | S4/S5 | G3 |
| V5REF | 1 mA | N/A | N/A | N/A |
| V5REF_Sus | 2 mA | 1 mA | 1 mA | N/A |
| Vcc3_3 | 273 mA | N/A | N/A | N/A |
| VccSus3_3 | 212 mA | 95 mA | 95 mA | N/A |
| VccHDA ⁶ | 30 mA | N/A | N/A | N/A |
| VccSusHDA ⁶ | 31 mA | 1 mA | 1 mA | N/A |
| VccHDA ⁸ | 10 mA | N/A | N/A | N/A |
| VccSusHDA ⁸ | 11 mA | 1 mA | 1 mA | N/A |
| VccGLAN3_3 | 1 mA | N/A | N/A | N/A |
| VccGLAN1_5 | 62 mA | N/A | N/A | N/A |
| VccLAN3_3 ⁵ | 17 mA | 77 mA | 77 mA | N/A |
| VccLAN1_1 ^{2, 5} | Powered by Vcc1_1 in S0 | Powered by VccLAN3_3 in S3 | Powered by VccLAN3_3 in S3 | N/A |
| VccCL3_3 | 16 mA | 70 mA | 70 mA | N/A |
| VccCL1_5 ² | Powered by Vcc1_5_A in S0 | Powered by VccCL3_3 in S3 | Powered by VccCL3_3 in S3 | N/A |
| VccCL1_1 ² | Powered by Vcc1_1 in S0 | Powered by VccCL3_3 in S3 | Powered by VccCL3_3 in S3 | N/A |
| Vcc1_5_A | 1.390 A | N/A | N/A | N/A |
| Vcc1_5_B | 591 mA | N/A | N/A | N/A |
| VccSus1_5 ² | Powered by Vcc1_5_A in S0 | Powered by VccSus3_3 in S3 | Powered by VccSus3_3 in S3 | N/A |
| Vcc1_1 | 2.553 A | N/A | N/A | N/A |
| VccSus1_1 ² | Powered by Vcc1_1 in S0 | Powered by VccSus3_3 in S3 | Powered by VccSus3_3 in S3 | N/A |
| VccRTC ^{3, 4} | N/A | N/A | N/A | 6 μ A |
| VccDMI ⁷ | 55 mA | N/A | N/A | N/A |
| V_CPU_IO | 1 mA | N/A | N/A | N/A |
| VccGLANPLL | 23 mA | N/A | N/A | N/A |
| VccUSBPLL | 10 mA | N/A | N/A | N/A |
| VccDMIPLL ⁷ | 22 mA | N/A | N/A | N/A |
| VccSATAPLL | 42 mA | N/A | N/A | N/A |

NOTES:

1. These are estimated DC current numbers.
2. Internal voltage regulators power these wells inside the Intel ICH10 and current for these rails are accounted for in the sourcing voltage rail current requirements.
3. Only the G3 state of this rail is shown to provide an estimate of battery life.
4. Icc (RTC) data is taken with VccRTC at 3.0 V while the system is in a mechanical off (G3) state at room temperature.
5. The current for this rail in S3 and S4/S5 is based on the integrated LAN running at 10/100.
6. The current for this rail was measured with VccHDA and VccSusHDA set to 3.3 V.
7. The current for this rail was measured with VccDMI set to 1.5 V.
8. The current for this rail was measured with VccHDA and VccSusHDA set to 1.5 V.

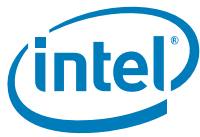

Table 8-4. DC Characteristic Input Signal Association (Sheet 1 of 2)

| Symbol | Associated Signals |
|------------------------------------|------------------------------------------------------------------------------------------------------------------------------------------------------------------------------------------------------------------------------------------------------------------------------------------------------------------------------------------------------------------------------------------------------------------------------------------------------------------------------------------------------------------|
| V_{IH1}/V_{IL1} (5V Tolerant) | PCI Signals: AD[31:0], C/BE[3:0]#, DEVSEL#, FRAME#, IRDY#, PAR, PERR#, PLOCK#, REQ[3:0]#, SERR#, STOP#, TRDY# Interrupt Signals: PIRQ[D:A]#, PIRQ[H:E]# GPIO Signals: GPIO[54, 52, 50, 5:2] |
| V_{IH2}/V_{IL2} | Gigabit LAN Connect Signals: GLAN_RX[p,n] |
| V_{IH3}/V_{IL3} | Clock Signals: CLK48 Power Management Signals: MCH_SYNC#, THRM#, VRMPWRGD, LAN_RST#, CLPWROK SATA Signals: SATAGP[5:4, 1:0]SATAGP[3:2] Interrupt Signals: SERIRQ Processor Signals: RCIN#, A20GATE USB Signals: OC[11:0]# GPIO Signals: GPIO[59, 55, 53, 51, 49:36, 35, 31:29, 22:16, 7:6, 1, 0], GPIO32 Intel® Quiet System Technology Signals: TACH[3:0] Strap Signals: GNT[3:0]#, SPKR, SATALED# (Strap purposes only) |
| V_{IH4}/V_{IL4} | Clock Signals: CLK14, PCICLK LPC/Firmware Hub Signals: LAD[3:0]/FWH[3:0], LDRQ0#, LDRQ1# PCI Signals: PME# SPI Signals: SPI_MISO GPIO Signals: GPIO[33, 23] Strap Signals: SPI_MOSI, GNT0# (Strap purposes only) |
| V_{IH5}/V_{IL5} | SMBus Signals: SMBCLK, SMBDATA, SMBALERT# System Management Signals: SMLINK[1:0], LINKALERT# GPIO Signals: GPIO[60, 11] |
| V_{IH6}/V_{IL6} | LAN Signals: GLAN_CLK, LAN_RXD[2:0] |
| V_{IH7}/V_{IL7} | Processor Signals: FERR#, THRMTRIP# |
| V_{IMIN8}/V_{IMAX8} | PCI Express* Data RX Signals: PER[p,n][6:1] |
| V_{IH9}/V_{IL9} | Real Time Clock Signals: RTCX1 |
| V_{IMIN10}/V_{IMAX10} | SATA Signals: SATA[3:0]RX[P,N], SATA[5:4]RX[P,N] |
| V_{IH11}/V_{IL11} | Intel® High Definition Audio Signals: HDA_SDIN[3:0] Strap Signals: HDA_SDOOUT, HDA_SYNC (Strap purposes only) GPIO Signals: GPIO34 NOTE: See V_{IL_HDA}/V_{IH_HDA} for High Definition Audio Low Voltage Mode |
| $V_{IH12}/V_{IL12}/V_{cross(abs)}$ | Clock Signals: DMI_CLKN, DMI_CLKP, SATA_CLKN, SATA_CLKP |
| V_{IH13}/V_{IL13} | Power Management Signals: PWRBTN#, RI#, SYS_RESET#, WAKE# GPIO Signals: GPIO[60, 57:56, 28:26, 24, 14:12, 10:8], GPIO[25, 15] |
| V_{IH14}/V_{IL14} | Power Management Signals: PWROK, RSMRST# System Management Signals: INTRUDER# Miscellaneous Signals: INTVRMEN, LAN100_SLP, RTCRST#, SRTCST# |



Table 8-4. DC Characteristic Input Signal Association (Sheet 2 of 2)

| Symbol | Associated Signals |
|-----------------------------------------------------|---------------------------------------------------------------------------------------------------------------------------------------------------------------------------------------------------------|
| V_{IH_CL}/V_{IL_CL} | Controller Link: CL_CLK0, CL_DATA0 |
| $V_{DI} / V_{CM} / V_{SE}$ (5 V Tolerant) | USB Signals: USBP[11:0][P,N] (Low-speed and Full-speed) |
| $V_{HSSQ} / V_{HSDSC} / V_{HSCM}$ (5 V Tolerant) | USB Signals: USBP[11:0][P,N] (in High-speed Mode) |
| V_{IH_HDA} / V_{IL_HDA} | Intel® High Definition Audio Signals: HDA_SDIN[3:0] Strap Signals: HDA_SDOUT, HDA_SYNC (Strap purposes only) NOTE: Only applies when running in Low Voltage Mode (1.5 V) |
| V_{IH_SST}/V_{IL_SST} | Intel® Quiet System Technology Signals: SST |
| V_{IH_PECI}/V_{IL_PECI} | Intel® Quiet System Technology Signals: PECI |

- $V_{DI} = |USBP_x[P] - USBP_x[N]|$
- Includes VDI range
- Applies to Low-Speed/High-Speed USB
- PCI Express mVdiff p-p = $2 * |PETp[x] - PETn[x]|$
- GLAN mVdiff p-p = $2 * |GLAN_RXp - GLAN_RXn|$
- SATA Vdiff, RX (VIMAX10/MIN10) is measured at the SATA connector on the receiver side (generally, the motherboard connector), where SATA mVdiff p-p = $2 * |SATA[x]RXP - SATA[x]RXN|$
- VccRTC is the voltage applied to the VccRTC well of the ICH10. When the system is in a G3 state, this is generally supplied by the coin cell battery, but for S5 and greater, this is generally VccSus3_3.
- CL_Vref = 0.27 (VccCL1_5). CL_VREF0 applies to all configurations.
- Applies to Ultra DMA Modes greater than Ultra DMA Mode 4.
- This is an AC Characteristic that represents transient values for these signals.
- Applies to High-Speed USB 2.0.



Table 8-5. DC Input Characteristics (Sheet 1 of 2)

| Symbol | Parameter | Min | Max | Unit | Notes |
|---------------------------|------------------------------------------------|----------------------------|----------------------------|---------------|---------|
| V _{IL1} | Input Low Voltage | -0.5 | 0.3(V _{CC3_3}) | V | |
| V _{IH1} | Input High Voltage | 0.5(V _{CC3_3}) | V _{5REF} + 0.5 | V | |
| V _{IL2} | Minimum Input Voltage | 200 | — | mVdiff p-p | Note 5 |
| V _{IH2} | Maximum Input Voltage | — | 1350 | mVdiff p-p | Note 5 |
| V _{IL3} | Input Low Voltage | -0.5 | 0.8 | V | |
| V _{IH3} | Input High Voltage | 2.0 | 3.3 V + 0.5 | V | Note 12 |
| V _{IL4} | Input Low Voltage | -0.5 | 0.3(3.3 V) | V | Note 12 |
| V _{IH4} | Input High Voltage | 0.5(3.3 V) | 3.3 V + 0.5 | V | Note 12 |
| V _{IL5} | Input Low Voltage | -0.5 | 0.8 | V | |
| V _{IH5} | Input High Voltage | 2.1 | 3.3 V + 0.5 | V | Note 12 |
| V _{IL6} | Input Low Voltage | -0.5 | 0.3(3.3 V) | V | Note 12 |
| V _{IH6} | Input High Voltage | 0.6(3.3 V) | 3.3 V + 0.5 | V | Note 12 |
| V _{IL7} | Input Low Voltage | -0.5 | 0.58(V _{CPU_IO}) | V | |
| V _{IH7} | Input High Voltage | 0.73(V _{CPU_IO}) | V _{CPU_IO} + 0.5 | V | |
| V _{IMIN8} | Minimum Input Voltage | 175 | — | mVdiff p-p | Note 4 |
| V _{IMAX8} | Maximum Input Voltage | — | 1200 | mVdiff p-p | Note 4 |
| V _{IL9} | Input Low Voltage | -0.5 | 0.10 | V | |
| V _{IH9} | Input High Voltage | 0.40 | 1.2 | V | |
| V _{IMIN10-Gen1i} | Minimum Input Voltage - 1.5 Gb/s internal SATA | 325 | — | mVdiff p-p | 6 |
| V _{IMAX10-Gen1i} | Maximum Input Voltage - 1.5 Gb/s internal SATA | — | 600 | mVdiff p-p | 6 |
| V _{IMIN10-Gen1m} | Minimum Input Voltage - 1.5 Gb/s eSATA | 240 | — | mVdiff p-p | 6 |
| V _{IMAX10-Gen1m} | Maximum Input Voltage - 1.5 Gb/s eSATA | — | 600 | mVdiff p-p | 6 |
| V _{IMIN10-Gen2i} | Minimum Input Voltage - 3.0 Gb/s internal SATA | 275 | — | mVdiff p-p | 6 |
| V _{IMAX10-Gen2i} | Maximum Input Voltage - 3.0 Gb/s internal SATA | — | 750 | mVdiff p-p | 6 |
| V _{IMIN10-Gen2m} | Minimum Input Voltage - 3.0 Gb/s eSATA | 240 | — | mVdiff p-p | 6 |



Table 8-5. DC Input Characteristics (Sheet 2 of 2)

| Symbol | Parameter | Min | Max | Unit | Notes |
|--------------------|---------------------------------------------|-------------------|-------------------|---------------|----------|
| $V_{IMAX10-Gen2m}$ | Maximum Input Voltage - 3.0 Gb/s eSATA | — | 750 | mVdiff p-p | 6 |
| V_{IL11} | Input Low Voltage | -0.5 | 0.35(3.3 V) | V | Note 12 |
| V_{IH11} | Input High Voltage | 0.65(3.3 V) | 3.3 V + 0.5 | V | Note 12 |
| V_{IL12} | Input Low Voltage | -0.150 | 0.150 | V | |
| V_{IH12} | Input High Voltage | 0.660 | 0.850 | V | |
| V_{IL13} | Input Low Voltage | -0.5 | 0.8 | V | |
| V_{IH13} | Input High Voltage | 2.0 | 3.3 V + 0.5 | V | Note 12 |
| V_{IL14} | Input Low Voltage | -0.5 | 0.78 | V | |
| V_{IH14} | Input High Voltage | 2.0 | VccRTC + 0.5 | V | Note 7 |
| V_{IL_CL} | Input Low Voltage | -0.3 | (CL_VREF - 0.075) | V | Note 8 |
| V_{IH_CL} | Input High Voltage | (CL_VREF + 0.075) | 1.2 | V | Note 8 |
| V_{IL_CL2} | Input Low Voltage | -0.5 | 0.3(VccCL3_3) | V | |
| V_{IH_CL2} | Input High Voltage | 0.5(VccCL3_3) | VccCL3_3 + 0.5 | V | |
| $V_{cross(abs)}$ | Absolute Crossing Point | 0.250 | 0.550 | V | |
| V_{DI} | Differential Input Sensitivity | 0.2 | — | V | Note 1,3 |
| V_{CM} | Differential Common Mode Range | 0.8 | 2.5 | V | Note 2,3 |
| V_{SE} | Single-Ended Receiver Threshold | 0.8 | 2.0 | V | Note 3 |
| V_{HSSQ} | HS Squelch Detection Threshold | 100 | 150 | mV | Note 11 |
| V_{HSDSC} | HS Disconnect Detection Threshold | 525 | 625 | mV | Note 11 |
| V_{HSCM} | HS Data Signaling Common Mode Voltage Range | -50 | 500 | mV | Note 11 |
| V_{IL_HDA} | Input Low Voltage | — | 0.4(Vcc_HDA) | V | |
| V_{IH_HDA} | Input High Voltage | 0.6(Vcc_HDA) | — | V | |
| V_{IL_SST} | Input Low Voltage | -0.5 | 0.4 | V | |
| V_{IH_SST} | Input High Voltage | 1.1 | Vcc + 0.5 | V | |
| V_{IL_PECI} | Input Low Voltage | -0.5 | 0.275(V_CPU_IO) | V | |
| V_{IH_PECI} | Input High Voltage | 0.725(V_CPU_IO) | V_CPU_IO + 0.5 | V | |

NOTES:

- $V_{DI} = |USBPx[P] - USBPx[N]|$
- Includes VDI range
- Applies to Low-Speed/Full-Speed USB
- PCI Express mVdiff p-p = $2 * |PETp[x] - PETn[x]|$
- GLAN mVdiff p-p = $2 * |GLAN_RXp - GLAN_RXn|$
- SATA Vdiff, RX (VIMAX10/MIN10) is measured at the SATA connector on the receiver side (generally, the motherboard connector), where SATA mVdiff p-p = $2 * |SATA[x]RXP - SATA[x]RXN|$



7. VccRTC is the voltage applied to the VccRTC well of the ICH10. When the system is in a G3 state, this is generally supplied by the coin cell battery, but for S5 and greater, this is generally VccSus3_3.
8. CL_Vref = 0.27 (VccCL1_5). CL_VREF0 applies to all configurations.
9. Applies to Ultra DMA Modes greater than Ultra DMA Mode 4
10. This is an AC Characteristic that represents transient values for these signals
11. Applies to High-Speed USB 2.0.
12. 3.3 V refers to VccSus3_3 for signals in the suspend well and to Vcc3_3 for signals in the core well. See Table 3-2 or Table 3-3 for signal and power well association.

Table 8-6. DC Characteristic Output Signal Association (Sheet 1 of 2)

| Symbol | Associated Signals |
|----------------------------------------|-----------------------------------------------------------------------------------------------------------------------------------------------------------------------------------------------------------------------------------------------------------------------------------------------------------------------------------------------------------------------------------------------------------------------------------------------------------------------|
| V _{OH1} /V _{OL1} | Processor Signals: A20M#, IGNNE#, INIT#, INTR, NMI, SMI#, STPCLK#, CPUPWRGD, DPSLP# Power Management Signals: DPRSTP# |
| V _{OH2} /V _{OL2} | PCI Signals: AD[31:0], C/BE[3:0]#, DEVSEL#, FRAME#, IRDY#, PAR, PERR#, PLOCK#, SERR# ⁽¹⁾ , STOP#, TRDY# Intel® High Definition Audio Signals: HDA_RST#, HDA_SDOUT, HDA_SYNC, HDA_BIT_CLK NOTE: See V _{OH_HDA} /V _{OL_HDA} for High Definition Audio Low Voltage Mode GPIO Signals: GPIO33 |
| V _{OH3} /V _{OL3} | SMBus Signals: SMBCLK ⁽¹⁾ , SMBDATA ⁽¹⁾ System Management Signals: SMLINK[1:0] ⁽¹⁾ , LINKALERT# GPIO Signals: GPIO[60, 11] |
| V _{OH4} /V _{OL4} | Power Management Signals: SLP_S3#, SLP_S4#, SLP_S5#, SLP_M#, SUSCLK, SUS_STAT#/LPCPD#, CK_PWRGD, S4_STATE#, DPRSLPVR SATA Signals: SATACLKREQ#, SATALED#, SLOAD, SDATAOUT[1:0] GPIO Signals: GPIO[49:48, 39:35, 32:31, 26, 21:18, 16, 7:6, 0], GPIO32 Other Signals: SPKR Interrupt Signals: SERIRO |
| V _{OH5} /V _{OL5} | USB Signals: USBP[11:0][P,N] in Low-speed and Full-speed Modes |
| V _{OMIN6} /V _{OMAX6} | PCI Express* Data TX Signals: PET[p,n][6:1] |
| V _{OMIN7} /V _{OMAX7} | SATA Signals: SATA[5:4, 1:0]TX[P,N], SATA[3:2]TX[P,N] |
| V _{OH8} /V _{OL8} | LPC/Firmware Hub Signals: LAD[3:0]/FWH[3:0], LFRAME#/FWH[4], INIT3_3V# Power Management Signal: PLTRST# PCI Signals: PCIRST#, GNT[3:0]#, PME# ⁽¹⁾ Interrupt Signals: PIRQ[D:A], PIRQ[H:E]# ⁽¹⁾ GPIO Signals: GPIO[58, 55:50, 34, 23:22, 17, 5:2, 1] SATA Signals: SCLOCK SPI Signals: SPI_CS0#, SPI_CS1#, SPI_MOSI, SPI_CLK LAN Signals: LAN_RSTSYNC, LAN_TXD[2:0] |



Table 8-6. DC Characteristic Output Signal Association (Sheet 2 of 2)

| Symbol | Associated Signals |
|------------------------------------------------------------------------|-----------------------------------------------------------------------------------------------------------------------------------------------------------------------------------------------|
| V_{OH9}/V_{OL9} | Power Management Signals: STP_CPU#, STP_PCI# GPIO Signals: GPIO[60, 59, 57:56, 47:40, 31:27, 24, 15:12, 10:8], GPIO[25, 15] System Management Signals: LINKALERT#, |
| V_{OMIN10}/V_{OMAX10} | Gigabit Lan Connect Signals: GLAN_TX[p,n] |
| V_{HSOI} V_{HSOH} V_{HSOL} V_{CHIRPJ} V_{CHIRPK} | USB Signals: USBP[11:0][P:N] in High-speed Mode |
| V_{OH_HDA}/V_{OL_HDA} | Intel® High Definition Audio Signals: HDA_RST#, HDA_SDOOUT, HDA_SYNC NOTE: Only applies when running in Low Voltage Mode (1.5 V) |
| $V_{OH_PWM}/$ V_{OL_PWM} | Intel® Quiet System Technology PWM: PWM[2:0] ⁽¹⁾ |
| V_{OH_CL1}/V_{OL_CL1} | Link Controller Signals: CL_CLK0, CL_DATA0 |
| V_{OH_CL2}/V_{OL_CL2} | Link Controller Signals: CL_RST0# |
| V_{OH_SST}/V_{OL_SST} | SST signal: SST |
| $V_{OH_PECI}/$ V_{OL_PECI} | PECI signal: PECI |

NOTE:

1. These signals are open-drain.



Table 8-7. DC Output Characteristics (Sheet 1 of 2)

| Symbol | Parameter | Min | Max | Unit | I_{OL} / I_{OH} | Notes |
|---------------------|------------------------|---------------------|------------|---------------|-------------------|--------------|
| V_{OL1} | Output Low Voltage | — | 0.255 | V | 3 mA | Note 4 |
| V_{OH1} | Output High Voltage | $V_{CPU_IO} - 0.3$ | — | V | -3 mA | |
| V_{OL2} | Output Low Voltage | — | 0.1(3.3 V) | V | 1.5 mA | Note 7 |
| V_{OH2} | Output High Voltage | 0.9(3.3 V) | — | V | -0.5 mA | Note 7 |
| V_{OL3} | Output Low Voltage | — | 0.4 | V | 4 mA | |
| V_{OH3} | Output High Voltage | 3.3 V - 0.5 | — | V | -2 mA | Note 1 |
| V_{OL4} | Output Low Voltage | — | 0.4 | V | 6 mA | |
| V_{OH4} | Output High Voltage | 3.3 V - 0.5 | — | V | -2 mA | Note 7 |
| V_{OL5} | Output Low Voltage | — | 0.4 | V | 5 mA | |
| V_{OH5} | Output High Voltage | 3.3 V - 0.5 | — | V | -2 mA | Note 7 |
| V_{OMIN6} | Minimum Output Voltage | 800 | — | mVdif fp-p | | Note 2 |
| V_{OMAX6} | Maximum Output Voltage | — | 1200 | mVdif fp-p | | Note 2 |
| $V_{OMIN7-Gen1i,m}$ | Minimum Output Voltage | 400 | — | mVdif fp-p | | Note 3 |
| $V_{OMAX7-Gen1i,m}$ | Maximum Output Voltage | — | 600 | mVdif fp-p | | Note 3 |
| $V_{OMIN7-Gen2i,m}$ | Minimum Output Voltage | 400 | — | mVdif fp-p | | Note 3 |
| $V_{OMAX7-Gen2i,m}$ | Maximum Output Voltage | — | 700 | mVdif fp-p | | Note 3 |
| V_{OL8} | Output Low Voltage | — | 0.1(3.3 V) | V | 1.5 mA | Note 7 |
| V_{OH8} | Output High Voltage | 0.9(3.3 V) | — | V | -0.5 mA | Note 1, 7 |
| V_{OL9} | Output Low Voltage | — | 0.4 | V | 6 mA | |
| V_{OH9} | Output High Voltage | 3.3 V - 0.5 | — | V | -0.5 mA | Note 7 |
| V_{OMIN10} | Minimum Output Voltage | 750 | — | mVdif fp-p | | Note 6 |
| V_{OMAX10} | Maximum Output Voltage | — | 1350 | mVdif fp-p | | Note 6 |
| V_{HSOI} | HS Idle Level | -10.0 | 10.0 | mV | | |
| V_{HSOH} | HS Data Signaling High | 360 | 440 | mV | | |
| V_{HSOL} | HS Data Signaling Low | -10.0 | 10.0 | mV | | |
| V_{CHIRPJ} | Chirp J Level | 700 | 1100 | mV | | |
| V_{CHIRPK} | Chirp K Level | -900 | -500 | mV | | |



Table 8-7. DC Output Characteristics (Sheet 2 of 2)

| Symbol | Parameter | Min | Max | Unit | I_{OL} / I_{OH} | Notes |
|----------------|---------------------|-----------------------|---------------------|------|-------------------|--------|
| V_{OL_PWM} | Output Low Voltage | — | 0.4 | V | 5 mA | |
| V_{OH_PWM} | Output High Voltage | — | — | | | Note 1 |
| V_{OL_CL1} | Output Low Voltage | — | 0.15 | V | 1 mA | |
| V_{OH_CL1} | Output High Voltage | $0.485(V_{CCCL1_5})$ | — | V | | |
| V_{OL_CL2} | Output Low Voltage | — | $0.1(V_{CCCL1_5})$ | V | 1.5 mA | |
| V_{OH_CL2} | Output High Voltage | $0.9(V_{CCCL1_5})$ | — | V | -1.5 mA | |
| V_{OL_CL3} | Output Low Voltage | — | 0.4 | V | 6 mA | |
| V_{OH_CL3} | Output High Voltage | $V_{CCCL3_3} - 0.5$ | — | V | -0.5 mA | |
| V_{OL_SST} | Output Low Voltage | — | 0.3 | V | 0.5 mA | |
| V_{OH_SST} | Output High Voltage | 1.1 | — | V | -6 mA | |
| V_{OL_PECI} | Output Low Voltage | — | $0.25(V_{CPU_IO})$ | V | 0.5 mA | |
| V_{OH_PECI} | Output High Voltage | $0.75(V_{CPU_IO})$ | — | | -6 mA | |
| V_{OL_HDA} | Output Low Voltage | — | $0.1(V_{CCHDA})$ | V | 1.5 mA | |
| V_{OH_HDA} | Output High Voltage | $0.9(V_{CCHDA})$ | — | V | -0.5 mA | |

NOTES:

- The SERR#, PIRQ[H:A], SMBDATA, SMBCLK, LINKALERT#, SMLINK[1:0], and PWM[2:0] signal has an open-drain driver and SATALED# has an open-collector driver, and the V_{OH} specification does not apply. This signal must have external pull up resistor.
- PCI Express mVdiff p-p = $2 * |PETp[x] - PETn[x]|$
- SATA Vdiff, tx (V_{OMIN7}/V_{OMAX7}) is measured at the SATA connector on the transmit side (generally, the motherboard connector), where SATA mVdiff p-p = $2 * |SATA[x]TXP - SATA[x]TXN|$
- Maximum Iol for CPUPWRGD is 12 mA for short durations (<500 mS per 1.5 s) and 9 mA for long durations.
- For INIT3_3V only, for low current devices, the following applies: V_{OL5} Max is 0.15 V at an I_{OL5} of 2 mA.
- GLAN mVdiff p-p = $2 * |GLAN_TXp - GLAN_TXn|$
- 3.3 V refers to V_{CCSus3_3} for signals in the suspend well and to V_{CC3_3} for signals in the core well. See Table 3-2 or Table 3-3 for signal and power well association.

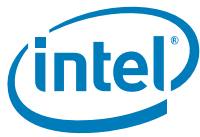

Table 8-8. Other DC Characteristics (Sheet 1 of 2)

| Symbol | Parameter | Min | Nom | Max | Unit | Notes |
|--------------------------------------------------------------------------------|-------------------------------------------------------------------|-------|-------|-------|------|---------------------------------------------|
| V_CPU_IO | Processor I/F | 0.945 | — | 1.3 | V | 1 |
| V5REF | ICH10 Core Well Reference Voltage | 4.75 | 5 | 5.25 | V | 1 |
| CL_VREF | Controller Link Reference Voltage | 0.385 | 0.405 | 0.425 | V | 1, 3 |
| Vcc3_3 | I/O Buffer Voltage | 3.135 | 3.3 | 3.465 | V | 1 |
| Vcc1_5_A, Vcc1_5_B, VccUSBPLL, VccSATAPLL, VccDMIPLL VccGLANPLL | Internal Logic and I/O Buffer Voltage | 1.425 | 1.5 | 1.575 | V | 1 |
| V5REF_Sus | Suspend Well Reference Voltage | 4.75 | 5 | 5.25 | V | 1 |
| VccSus3_3 | Suspend Well I/O Buffer Voltage | 3.135 | 3.3 | 3.465 | V | 1 |
| Vcc1_1 (Consumer Only) | Internal Logic Voltage | 0.998 | 1.1 | 1.155 | V | 1 |
| Vcc1_1 (Corporate Only) | Internal Logic Voltage | 1.045 | 1.1 | 1.155 | V | 1 |
| VccHDA | High Definition Audio Controller Core Voltage | 3.135 | 3.3 | 3.465 | V | 1 |
| VccHDA (low voltage 1.5 V) | High Definition Audio Controller Low Voltage Mode Core Voltage | 1.425 | 1.5 | 1.575 | V | 1 |
| Vcc_DMI | DMI Buffer Voltage | 1.188 | 1.25 | 1.312 | V | |
| Vcc_DMI (ESI Mode Only) | DMI Buffer Voltage | 1.425 | 1.5 | 1.575 | V | |
| VccLAN3_3 | LAN Controller I/O Buffer Voltage | 3.135 | 3.3 | 3.465 | V | 1 |
| VccGLAN1_5 | Gigabit Lan Transmitter and Receiver Voltage | 1.425 | 1.5 | 1.575 | V | 1 |
| VccGLAN3_3 | Gigabit Lan Internal Logic and I/O Buffer Voltage | 3.135 | 3.3 | 3.465 | V | 1 |
| VccCL3_3 | Controller Link Buffer Voltage | 3.135 | — | 3.465 | V | 1 |
| VccRTC (G3-S0) | Battery Voltage | 2 | — | 3.465 | V | 1 |
| VccSusHDA | High Definition Audio Controller Suspend Voltage | 3.135 | 3.3 | 3.465 | V | 1 |
| VccSusHDA (low voltage) | High Definition Audio Controller Low Voltage Mode Suspend Voltage | 1.425 | 1.5 | 1.575 | V | 1 |
| V _{DI} | Differential Input Sensitivity | 0.2 | — | — | V | {(USB _{Px+} , USB _{Px-}) |
| V _{CM} | Differential Common Mode Range | 0.8 | — | 2.5 | V | Includes V _{DI} |
| V _{CRS} | Output Signal Crossover Voltage | 1.3 | — | 2.0 | V | |
| V _{SE} | Single Ended Rcvr Threshold | 0.8 | — | 2.0 | V | |
| I _{LI1} | ATA Input Leakage Current | -200 | — | 200 | μA | (0 V < V _{IN} < 5V) |



Table 8-8. Other DC Characteristics (Sheet 2 of 2)

| Symbol | Parameter | Min | Nom | Max | Unit | Notes |
|------------------|---------------------------------------|----------------------|-----|------|------|------------------------------------------------------------|
| I _{LI2} | PCI_3V Hi-Z State Data Line Leakage | -10 | — | 10 | μA | (0 V < V _{IN} < V _{cc3_3}) |
| I _{LI3} | PCI_5V Hi-Z State Data Line Leakage | -70 | — | 70 | μA | Max V _{IN} = 2.7 V Min V _{IN} = 0.5 V |
| I _{LI4} | Input Leakage Current – Clock signals | -100 | — | +100 | μA | 2 |
| C _{IN} | Input Capacitance – All Other | — | — | 12 | pF | F _C = 1 MHz |
| C _{OUT} | Output Capacitance | — | — | 12 | pF | F _C = 1 MHz |
| C _{I/O} | I/O Capacitance | — | — | 12 | pF | F _C = 1 MHz |
| | | Typical Value | | | | |
| C _L | XTAL1 | 6 | | | pF | |
| C _L | XTAL2 | 6 | | | pF | |

NOTES:

1. The I/O buffer supply voltage is measured at the ICH package pins. The tolerances shown in Table 8-8 are inclusive of all noise from DC up to 20 MHz. In testing, the voltage rails should be measured with a bandwidth limited oscilloscope that has a rolloff of 3 dB/decade above 20 MHz.
2. Includes CLK14, CLK48, GLAN_CLK and PCICLK
3. CL_VREF voltage applies when pin is driven by external circuit.



8.4 AC Characteristics

Table 8-9. Clock Timings (Sheet 1 of 2)

| Sym | Parameter | Min | Max | Unit | Notes | Figure |
|---------------------------------------------------------------------------|--------------------------------------------------|--------|---------|------|-------|--------|
| PCI Clock (PCICLK) | | | | | | |
| t1 | Period | 30 | 33.3 | ns | | 8-1 |
| t2 | High Time | 12 | — | ns | | 8-1 |
| t3 | Low Time | 12 | — | ns | | 8-1 |
| t4 | Rise Time | — | 3 | ns | | 8-1 |
| t5 | Fall Time | — | 3 | ns | | 8-1 |
| 14 MHz Clock (CLK14) | | | | | | |
| t6 | Period | 67 | 70 | ns | | 8-1 |
| t7 | High Time | 20 | — | ns | | 8-1 |
| t8 | Low Time | 20 | — | ns | | 8-1 |
| t41 | Rising Edge Rate | 1.0 | 4.0 | V/ns | 5 | |
| t42 | Falling Edge Rate | 1.0 | 4.0 | V/ns | 5 | |
| 48 MHz Clock (CLK48) | | | | | | |
| f _{clk48} | Operating Frequency | 48.000 | — | MHz | 1 | |
| t9 | Frequency Tolerance | — | 100 | ppm | | |
| t10 | High Time | 7 | — | ns | | 8-1 |
| t11 | Low Time | 7 | — | ns | | 8-1 |
| t12 | Rise Time | — | 1.2 | ns | | 8-1 |
| t13 | Fall Time | — | 1.2 | ns | | 8-1 |
| SMBus Clock (SMBCLK) | | | | | | |
| f _{smb} | Operating Frequency | 10 | 100 | KHz | | |
| t18 | High time | 4.0 | 50 | μs | 2 | 8-10 |
| t19 | Low time | 4.7 | — | μs | | 8-10 |
| t20 | Rise time | — | 1000 | ns | | 8-10 |
| t21 | Fall time | — | 300 | ns | | 8-10 |
| HDA_BIT_CLK (Intel® High Definition Audio) | | | | | | |
| f _{HDA} | Operating Frequency | 24.0 | | MHz | | |
| | Frequency Tolerance | — | 100 | ppm | | |
| t26a | Input Jitter (refer to Clock Chip Specification) | — | 300 | ppm | | |
| t27a | High Time (Measured at 0.75 Vcc) | 18.75 | 22.91 | ns | | 8-1 |
| t28a | Low Time (Measured at 0.35 Vcc) | 18.75 | 22.91 | ns | | 8-1 |
| SATA Clock (SATA_CLKP, SATA_CLKN) / DMI Clock (DMI_CLKP, DMI_CLKN) | | | | | | |
| t36 | Period | 9.997 | 10.0533 | ns | | |



Table 8-9. Clock Timings (Sheet 2 of 2)

| Sym | Parameter | Min | Max | Unit | Notes | Figure |
|------------------------------------------|-------------------------|-----|--------|------|-------|--------|
| tsatasl | Slew rate | 1 | 8 | V/ns | 7 | |
| Suspend Clock (SUSCLK) | | | | | | |
| f _{susclk} | Operating Frequency | 32 | | kHz | 4 | |
| t ₃₉ | High Time | 10 | — | μs | 4 | |
| t _{39a} | Low Time | 10 | — | μs | 4 | |
| Gigabit Internet Clock (GLAN_CLK) | | | | | | |
| t _{glanclk} | Operating Frequency | 5 | 62.5 | MHz | 6 | |
| t _{glanhi} | High Time | 6.4 | — | ns | | |
| t _{glanlo} | Low Time | 6.4 | — | ns | | |
| t _{glansl} | Slew rate | 1.0 | 4 | V/ns | | |
| Intel® Quiet System Technology | | | | | | |
| f _{pwm} | PWM Operating Frequency | 10 | 28,000 | Hz | | |

NOTES:

1. The CLK48 expects a 40/60% duty cycle.
2. The maximum high time (t₁₈ Max) provide a simple ensured method for devices to detect bus idle conditions.
3. BITCLK Rise and Fall times are measured from 10%VDD and 90%VDD.
4. SUSCLK duty cycle can range from 30% minimum to 70% maximum.
5. CLK14 edge rates in a system as measured from 0.8 V to 2.0 V.
6. The active frequency can be 5 MHz, 50 MHz or 62.5 MHz depending on the interface speed. Dynamic changes of the normal operating frequency are not allowed.
7. See *CK505 Clock Synthesizer Specification* for measurement procedure.

Table 8-10. PCI Interface Timing

| Sym | Parameter | Min | Max | Units | Notes | Figure |
|-----------------|--------------------------------------------------------------------------------------------------------------------|-----|-----|-------|-------|--------|
| t ₄₀ | AD[31:0] Valid Delay | 2 | 11 | ns | 1 | 8-2 |
| t ₄₁ | AD[31:0] Setup Time to PCICLK Rising | 7 | — | ns | | 8-3 |
| t ₄₂ | AD[31:0] Hold Time from PCICLK Rising | 0 | — | ns | | 8-3 |
| t ₄₃ | C/BE[3:0]#, FRAME#, TRDY#, IRDY#, STOP#, PAR, PERR#, PLOCK#, DEVSEL# Valid Delay from PCICLK Rising | 2 | 11 | ns | 1 | 8-2 |
| t ₄₄ | C/BE[3:0]#, FRAME#, TRDY#, IRDY#, STOP#, PAR, PERR#, PLOCK#, IDSEL, DEVSEL# Output Enable Delay from PCICLK Rising | 2 | | ns | | 8-6 |
| t ₄₅ | C/BE[3:0]#, FRAME#, TRDY#, IRDY#, STOP#, PERR#, PLOCK#, DEVSEL#, GNT[A:B]# Float Delay from PCICLK Rising | 2 | 28 | ns | | 8-4 |
| t ₄₆ | C/BE[3:0]#, FRAME#, TRDY#, IRDY#, STOP#, SERR#, PERR#, DEVSEL#, Setup Time to PCICLK Rising | 7 | | ns | | 8-3 |

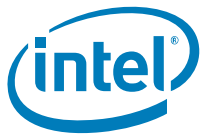

Table 8-10. PCI Interface Timing

| Sym | Parameter | Min | Max | Units | Notes | Figure |
|-----|--------------------------------------------------------------------------------------------------------|-----|-----|-------|-------|--------|
| t47 | C/BE[3:0]#, FRAME#, TRDY#, IRDY#, STOP#, SERR#, PERR#, DEVSEL#, REQ[A:B]# Hold Time from PCLKIN Rising | 0 | — | ns | | 8-3 |
| t48 | PCIRST# Low Pulse Width | 1 | | ms | | 8-5 |
| t49 | GNT[3:0]# Valid Delay from PCICLK Rising | 2 | 12 | ns | | |
| t50 | REQ[3:0]# Setup Time to PCICLK Rising | 12 | — | ns | | |

NOTE:

1. Refer to note 3 of table 4-4 in Section 4.2.2.2 and note 2 of table 4-6 in Section 4.2.3.2 of the *PCI Local Bus Specification*, Revision 2.3 for measurement details.

Table 8-11. Universal Serial Bus Timing

| Sym | Parameter | Min | Max | Units | Notes | Fig |
|-----------------------------------|---------------------------------------------------------------------------------------|-------------|-----------|----------|-----------------------------------------------------------|-----|
| Full-speed Source (Note 7) | | | | | | |
| t100 | USBPx+, USBPx- Driver Rise Time | 4 | 20 | ns | 1, C _L = 50 pF | 8-7 |
| t101 | USBPx+, USBPx- Driver Fall Time | 4 | 20 | ns | 1, C _L = 50 pF | 8-7 |
| t102 | Source Differential Driver Jitter - To Next Transition - For Paired Transitions | -3.5 -4 | 3.5 4 | ns ns | 2, 3 | 8-8 |
| t103 | Source SEO interval of EOP | 160 | 175 | ns | 4 | 8-9 |
| t104 | Source Jitter for Differential Transition to SEO Transition | -2 | 5 | ns | 5 | |
| t105 | Receiver Data Jitter Tolerance - T o Next Transition - For Paired Transitions | -18.5 -9 | 18.5 9 | ns ns | 3 | 8-8 |
| t106 | EOP Width: Must accept as EOP | 82 | — | ns | 4 | 8-9 |
| t107 | Width of SEO interval during differential transition | — | 14 | ns | | |
| Low-speed Source (Note 8) | | | | | | |
| t108 | USBPx+, USBPx – Driver Rise Time | 75 | 300 | ns | 1, 6 C _L = 50 pF C _L = 350 pF | 8-7 |
| t109 | USBPx+, USBPx – Driver Fall Time | 75 | 300 | ns | 1, 6 C _L = 50 pF C _L = 350 pF | 8-7 |
| t110 | Source Differential Driver Jitter To Next Transition For Paired Transitions | -25 -14 | 25 14 | ns ns | 2, 3 | 8-8 |
| t111 | Source SEO interval of EOP | 1.25 | 1.50 | μs | 4 | 8-9 |
| t112 | Source Jitter for Differential Transition to SEO Transition | -40 | 100 | ns | 5 | |



Table 8-11. Universal Serial Bus Timing

| Sym | Parameter | Min | Max | Units | Notes | Fig |
|-----------------------------------|-----------------------------------------------------------------------------------|--------------|------------|----------|-------|-----|
| Full-speed Source (Note 7) | | | | | | |
| t113 | Receiver Data Jitter Tolerance - To Next Transition- For Paired Transitions | -152 -200 | 152 200 | ns ns | 3 | 8-8 |
| t114 | EOP Width: Must accept as EOP | 670 | — | ns | 4 | 8-9 |
| t115 | Width of SE0 interval during differential transition | — | 210 | ns | | |

NOTES:

1. Driver output resistance under steady state drive is spec'd at 28 ohms at minimum and 43 ohms at maximum.
2. Timing difference between the differential data signals.
3. Measured at crossover point of differential data signals.
4. Measured at 50% swing point of data signals.
5. Measured from last crossover point to 50% swing point of data line at leading edge of EOP.
6. Measured from 10% to 90% of the data signal.
7. Full-speed Data Rate has minimum of 11.97 Mb/s and maximum of 12.03 Mb/s.
8. Low-speed Data Rate has a minimum of 1.48 Mb/s and a maximum of 1.52 Mb/s.

Table 8-12. SATA Interface Timings

| Sym | Parameter | Min | Max | Units | Notes | Figure |
|------|-----------------------------------------|--------|--------|-------|-------|--------|
| UI | Gen I Operating Data Period | 666.43 | 670.23 | ps | | |
| UI-2 | Gen II Operating Data Period (3Gb/s) | 333.21 | 335.11 | ps | | |
| t120 | Rise Time | 0.15 | 0.41 | UI | 1 | |
| t121 | Fall Time | 0.15 | 0.41 | UI | 2 | |
| t122 | TX differential skew | — | 20 | ps | | |
| t123 | COMRESET | 310.4 | 329.6 | ns | 3 | |
| t124 | COMWAKE transmit spacing | 103.5 | 109.9 | ns | 3 | |
| t125 | OOB Operating Data period | 646.67 | 686.67 | ns | 4 | |

NOTES:

1. 20% – 80% at transmitter
2. 80% – 20% at transmitter
3. As measured from 100 mV differential crosspoints of last and first edges of burst.
4. Operating data period during Out-Of-Band burst transmissions.



Table 8-13. SMBus Timing

| Sym | Parameter | Min | Max | Units | Notes | Fig |
|------|----------------------------------------------------------------------------------------------|-----|-----|-------|-------|------|
| t130 | Bus Free Time Between Stop and Start Condition | 4.7 | — | μs | | 8-10 |
| t131 | Hold Time after (repeated) Start Condition. After this period, the first clock is generated. | 4.0 | — | μs | | 8-10 |
| t132 | Repeated Start Condition Setup Time | 4.7 | — | μs | | 8-10 |
| t133 | Stop Condition Setup Time | 4.0 | — | μs | | 8-10 |
| t134 | Data Hold Time | 0 | — | ns | 4 | 8-10 |
| t135 | Data Setup Time | 250 | — | ns | | 8-10 |
| t136 | Device Time Out | 25 | 35 | ms | 1 | |
| t137 | Cumulative Clock Low Extend Time (slave device) | — | 25 | ms | 2 | 8-11 |
| t138 | Cumulative Clock Low Extend Time (master device) | — | 10 | ms | 3 | 8-11 |

NOTES:

1. A device will timeout when any clock low exceeds this value.
2. t137 is the cumulative time a slave device is allowed to extend the clock cycles in one message from the initial start to stop. If a slave device exceeds this time, it is expected to release both its clock and data lines and reset itself.
3. t138 is the cumulative time a master device is allowed to extend its clock cycles within each byte of a message as defined from start-to-ack, ack-to-ack or ack-to-stop.
4. t134 has a minimum timing for I²C of 0 ns, while the minimum timing for SMBus is 300 ns.

Table 8-14. Intel® High Definition Audio Timing

| Sym | Parameter | Min | Max | Units | Notes | Fig |
|------|----------------------------------------------------------------------|-----|-----|-------|-------|------|
| t143 | Time duration for which HDA_SDOOUT is valid before HDA_BIT_CLK edge. | 7 | — | ns | | 8-13 |
| t144 | Time duration for which HDA_SDOOUT is valid after HDA_BIT_CLK edge. | 7 | — | ns | | 8-13 |
| t145 | Setup time for HDA_SDIN[3:0] at rising edge of HDA_BIT_CLK | 15 | — | ns | | 8-13 |
| t146 | Hold time for HDA_SDIN[3:0] at rising edge of HDA_BIT_CLK | 0 | — | ns | | 8-13 |



Table 8-15. LPC Timing

| Sym | Parameter | Min | Max | Units | Notes | Fig |
|------|-------------------------------------------------|-----|-----|-------|-------|-----|
| t150 | LAD[3:0] Valid Delay from PCICLK Rising | 2 | 11 | ns | | 8-2 |
| t151 | LAD[3:0] Output Enable Delay from PCICLK Rising | 2 | | ns | | 8-6 |
| t152 | LAD[3:0] Float Delay from PCICLK Rising | — | 28 | ns | | 8-4 |
| t153 | LAD[3:0] Setup Time to PCICLK Rising | 7 | — | ns | | 8-3 |
| t154 | LAD[3:0] Hold Time from PCICLK Rising | 0 | — | ns | | 8-3 |
| t155 | LDRQ[1:0]# Setup Time to PCICLK Rising | 12 | — | ns | | 8-3 |
| t156 | LDRQ[1:0]# Hold Time from PCICLK Rising | 0 | — | ns | | 8-3 |
| t157 | LFRAME# Valid Delay from PCICLK Rising | 2 | 12 | ns | | 8-2 |

Table 8-16. Miscellaneous Timings

| Sym | Parameter | Min | Max | Units | Notes | Fig |
|------|--------------------------------------------|-----|-----|--------|-------|-----|
| t160 | SERIRQ Setup Time to PCICLK Rising | 7 | — | ns | | 8-3 |
| t161 | SERIRQ Hold Time from PCICLK Rising | 0 | — | ns | | 8-3 |
| t162 | RI#, EXTSMI#, GPIO, USB Resume Pulse Width | 2 | — | RTCCLK | | 8-5 |
| t163 | SPKR Valid Delay from OSC Rising | — | 200 | ns | | 8-2 |
| t164 | SERR# Active to NMI Active | — | 200 | ns | | |
| t165 | IGNNE# Inactive from FERR# Inactive | — | 230 | ns | | |

Table 8-17. SPI Timings (20 MHz)

| Sym | Parameter | Min | Max | Units | Notes | Fig |
|------|-----------------------------------------------------------------------------------|------|------|-------|-------|------|
| t180 | Serial Clock Frequency - 20M Hz Operation | 17.2 | 18.4 | MHz | 1 | |
| t182 | SPI Clock Duty cycle at the host | 40% | 60% | | | 8-12 |
| t183 | Tco of SPI_MOSI with respect to serial clock falling edge at the host | -5 | 13 | ns | | 8-12 |
| t184 | Setup of SPI_MISO with respect to serial clock falling edge at the host | 16 | — | ns | | 8-12 |
| t185 | Hold of SPI_MISO with respect to serial clock falling edge at the host | 0 | — | ns | | 8-12 |
| t186 | Setup of SPI_CS[1:0]# assertion with respect to serial clock rising at the host | 30 | — | ns | | 8-12 |
| t187 | Hold of SPI_CS[1:0]# deassertion with respect to serial clock falling at the host | 30 | — | ns | | 8-12 |

NOTE:

- The typical clock frequency driven by the ICH10 is 17.86 MHz.



Table 8-18. SPI Timings (33 MHz)

| Sym | Parameter | Min | Max | Units | Notes | Fig |
|-------|-----------------------------------------------------------------------------------|------|-------|-------|-------|------|
| t180b | Serial Clock Frequency - 33 MHz Operation | 30.3 | 32.19 | MHz | 1 | |
| t182b | SPI Clock Duty cycle at the host | 48% | 52% | | | 8-12 |
| t183b | Tco of SPI_MOSI with respect to serial clock falling edge at the host | -5 | 5 | ns | | 8-12 |
| t184b | Setup of SPI_MISO with respect to serial clock falling edge at the host | 8 | — | ns | | 8-12 |
| t185b | Hold of SPI_MISO with respect to serial clock falling edge at the host | 0 | — | ns | | 8-12 |
| t186b | Setup of SPI_CS[1:0]# assertion with respect to serial clock rising at the host | 30 | — | ns | | 8-12 |
| t187b | Hold of SPI_CS[1:0]# deassertion with respect to serial clock falling at the host | 30 | — | ns | | 8-12 |

NOTE:

- The typical clock frequency driven by the ICH10 is 31.25 MHz.

Table 8-19. SST Timings

| Sym | Parameter | Min | Max | Units | Notes | Fig |
|-------------------------|------------------------------------------------------------------------------------------------------------------------------------------------------------------------------------|----------------|------------|--------------------|-------|-----|
| t _{BIT} | Bit time (overall time evident on SST) Bit time driven by an originator | 0.495 0.495 | 500 250 | μs μs | 1 | - |
| t _{BIT,jitter} | Bit time jitter between adjacent bits in an SST message header or data bytes after timing has been negotiated | — | — | % | | |
| t _{BIT,drift} | Change in bit time across a SST address or SST message bits as driven by the originator. This limit only applies across t _{BIT-A} bit drift and t _{BIT-M} drift. | — | — | % | | |
| t _{H1} | High level time for logic '1' | 0.6 | 0.8 | x t _{BIT} | 2 | |
| t _{H0} | High level time for logic '0' | 0.2 | 0.4 | x t _{BIT} | | |
| t _{SSTR} | Rise time (measured from V _{OL} = 0.3V to V _{IH,min}) | — | 25 + 5 | ns/ node | | |
| t _{SSTF} | Fall time (measured from V _{OH} = 1.1V to V _{IL,max}) | — | 33 | ns/ node | | |

NOTES:

- The originator must drive a more restrictive time to allow for quantized sampling errors by a client yet still attain the minimum time less than 500 μs. t_{BIT} limits apply equally to t_{BIT-A} and t_{BIT-M}. ICH10 is targeted on 1 Mbps which is 1 μs bit time.
- The minimum and maximum bit times are relative to t_{BIT} defined in the Timing Negotiation pulse.
- t_{BIT-A} is the negotiated address bit time and t_{BIT-M} is the negotiated message bit time.



Table 8-20. PECE Timings

| Sym | Parameter | Min | Max | Units | Notes | Fig |
|------------------|------------------------------------------------------------------------------------------------------------------------------------------------------------------------|----------------|------------|--------------------|-------|-----|
| t_{BIT} | Bit time (overall time evident on PECE) Bit time driven by an originator | 0.495 0.495 | 500 250 | μ s μ s | 1 | |
| $t_{BIT,jitter}$ | Bit time jitter between adjacent bits in an PECE message header or data bytes after timing has been negotiated | — | — | % | | |
| $t_{BIT,drift}$ | Change in bit time across a PECE address or PECE message bits as driven by the originator. This limit only applies across t_{BIT-A} bit drift and t_{BIT-M} drift. | — | — | % | | |
| t_{H1} | High level time for logic '1' | 0.6 | 0.8 | x t_{BIT} | 2 | |
| t_{H0} | High level time for logic '0' | 0.2 | 0.4 | x t_{BIT} | | |
| t_{PECEIR} | Rise time (measured from V_{OL} to $V_{IH,min}$, $V_{tt(nom)}$ -5%) | — | 30 + 5 | ns/ node | 3 | |
| t_{PECEIF} | Fall time (measured from V_{OH} to $V_{IL,max}$, $V_{tt(nom)}$ +5%) | — | 30 | ns/ node | 3 | |

NOTES:

- The originator must drive a more restrictive time to allow for quantized sampling errors by a client yet still attain the minimum time less than 500 μ s. t_{BIT} limits apply equally to t_{BIT-A} and t_{BIT-M} . ICH10 is targeted on 2 MHz which is 500 ns bit time.
- The minimum and maximum bit times are relative to t_{BIT} defined in the Timing Negotiation pulse.
- Extended trace lengths may appear as additional nodes.
- t_{BIT-A} is the negotiated address bit time and t_{BIT-M} is the negotiated message bit time.

Table 8-21. Power Sequencing and Reset Signal Timings (Sheet 1 of 2)

| Sym | Parameter | Min | Max | Units | Notes | Fig |
|------|------------------------------------------------|-----|-----|-------|-------|--------------|
| t200 | VccRTC active to RTCRST# inactive | 18 | — | ms | | 8-14 |
| t201 | V5REF_Sus active to VccSus3_3 active | 0 | — | ms | 1 | 8-14 |
| t202 | VccSus3_3 active to VccSus1_1 active | — | — | — | 2 | 8-14 |
| t203 | VccRTC supply active to VccSus supplies active | 0 | — | ms | 3, 9 | 8-14 |
| t204 | VccSus supplies active to RSMRST# inactive | 10 | — | ms | 9 | 8-14 8-15 |
| t209 | V5REF active to Vcc3_3 active | 0 | — | ms | 1 | 8-14 |
| t211 | Vcc1_5 active to V_CPU_IO active | — | — | — | 4 | 8-14 |
| t212 | VRMPWRGD active to PWROK active | 5 | — | ms | | 8-15 8-17 |
| t213 | VccSus supplies active to Vcc supplies active | 0 | — | ms | 9, 10 | 8-14 |

Table 8-21. Power Sequencing and Reset Signal Timings (Sheet 2 of 2)

| Sym | Parameter | Min | Max | Units | Notes | Fig |
|------|----------------------------------------------------------------------------------------------------------------------------|-------|-----|--------|---------|----------------------|
| t214 | Vcc supplies active to PWROK Note: PWROK assertion indicates that PCICLK has been stable for at least 1 ms. | 99 | — | ms | 10 | 8-14 8-15 8-17 |
| t217 | PWROK and VRMPWRGD active to SUS_STAT# inactive and Processor interface signals latched to strap value (Consumer Only) | 33 | 71 | RTCCLK | 5, 6, 8 | 8-15 8-17 |
| t217 | PWROK and VRMPWRGD active to SUS_STAT# inactive and Processor interface signals latched to strap value (Corporate Only) | 33 | — | RTCCLK | 5, 6, 8 | 8-15 8-17 |
| t218 | SUS_STAT# inactive to PLTRST# inactive (Consumer Only) | 2 | — | RTCCLK | 6 | 8-15 8-17 |
| t218 | SUS_STAT# inactive to PLTRST# inactive (Corporate Only) | 60 | — | μs | | 8-15 8-17 |
| t219 | PLTRST# assertion to VccGLANPLL inactive for platforms using ICH10 integrated GbE LAN | 200 | — | μs | 7 | |
| t228 | HDA_RST# active low pulse width | 1 | — | μs | | |
| t229 | HDA_RST# inactive to HDA_BIT_CLK startup delay | 162.8 | — | ns | | |

NOTES:

- V5REF must be powered up before Vcc3_3, or after Vcc3_3 within 0.7 V. Also, V5REF must power down after Vcc3_3, or before Vcc3_3 within 0.7 V.
- The associated 3.3 V and 1.1 V supplies are assumed to power up or down 'together'.
- The VccSus supplies must **never** be active while the VccRTC supply is inactive.
- a) Vcc1_5 must power up before V_CPU_IO or after V_CPU_IO within 0.7 V, b) V_CPU_IO must power down before Vcc1_5 or after Vcc1_5 within 0.7 V.
- INIT# value determined by value of the CPU BISTEnable bit (Chipset Configuration Register Offset 3414h: bit 2).
- These transitions are clocked off the internal RTC. 1 RTC clock is approximately from 28.992 μs to 32.044 μs
- "VccGLANPLL inactive" is defined for this timing to be when VccGLANPLL drops to 1.425 V or less, as measured at the ICH10. This timing applies only to platforms using ICH10 integrated GbE LAN.
- Maximum timing may be exceeded in a Intel Management Engine enabled system.
- VccSus supplies include VccSus3_3, V5REF_Sus, VccSusHDA, VccLAN3_3 (if LAN powered in S3/S4/S5), and VccCL3_3 (if controller link powered in S3/S4/S5).
- Vcc includes Vcc1_5_A, Vcc1_5_B, Vcc3_3, Vcc1_1, VccUSBPLL, VccDMIPLL, VccSATAPLL, V5REF, V_CPU_IO, VccDMI, VccHDA, VccGLANPLL, VccGLAN3_3 and VccGLAN1_5 (if integrated Gigabit LAN enabled), VccLAN3_3 (if LAN only power in S0), and VccCL3_3 (if controller link only powered in S0).



Table 8-22. Power Management Timings (Sheet 1 of 3)

| Sym | Parameter | Min | Max | Units | Notes | Fig |
|--------------|-----------------------------------------------------------------------------------|---------------------------------------|---------|--------|-----------|------------------------------|
| t230 | VccSus active to SLP_S5#, SLP_S4#, SLP_S3#, SUS_STAT#, PLTRST# and PCIRST# active | — | 50 | ns | | 8-15 |
| t231 t232 | RSMRST# inactive to SUSCLK running, SLP_S5# inactive | — | 110 | ms | 6, 22 | 8-15 |
| t233 | SLP_S5# inactive to SLP_S4# inactive | See Note Below | | | 8 | 8-15 |
| t234 | SLP_S4# inactive to SLP_S3# inactive | 1 | Note 16 | RTCCLK | 1 | 8-15 8-17 8-21 8-22 |
| t250 | Processor I/F signals latched prior to STPCLK# active | 0 | — | | 9 | 8-18 8-19 8-20 |
| t251 | Bus Master Idle to DPSLP# active | 3.36 | — | µs | 11 | 8-19 8-20 |
| t252 | DMI message to PMSYNC# assertion | 0 | — | PCICLK | | |
| t253 | DPSLP# active to STP_CPU# active | 1 | 1 | PCICLK | 3 | 8-19 8-20 |
| t254 | STP_CPU# active to processor clock stopped | 0 | — | PCICLK | 3, 10 | 8-19 8-20 |
| t255 | STP_CPU# active to DPRSTP#, DPRSLPVR active | 0 | — | | | 8-20 |
| t265 | Break Event to DPRSTP#, DPRSLPVR inactive (C4 Exit) | 1.5 | 1.8 | µs | 12 | 8-20 |
| t266a | DPRSLPVR, DPRSTP# inactive to STP_CPU# inactive and CPU Vcc ramped | Programmable. See D31:F0:AA, bits 3:2 | | µs | | 8-20 |
| t267 | Break Event to STP_CPU# inactive (C3 Exit) | 6 | Note 14 | PCICLK | 3, 13, 14 | 8-19 |
| t268 | STP_CPU# inactive to processor clock running | 0 | 3 | PCICLK | 3, 10 | 8-19 8-20 |
| t269 | STP_CPU# inactive to DPSLP# inactive | 1 | 1 | PCICLK | 3, 7 | 8-19 8-20 |
| t270 | DPSLP# inactive to STPCLK# inactive | 0 | | µs | | 8-19 8-20 |
| t273 | Break Event to STPCLK# inactive (C2 Exit) | 0 | | ns | | 8-18 |
| t274 | STPCLK# inactive to processor I/F signals unlatched | 8 | 9 | PCICLK | 3, 9 | 8-18 8-19 8-20 |
| t280 | STPCLK# active to DMI Message | 0 | | PCICLK | 2 | 8-16 8-17 |
| t281 | DMI Message to CPUSLP# active | 60 | 63 | PCICLK | 3 | 8-16 |

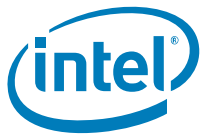

Table 8-22. Power Management Timings (Sheet 2 of 3)

| Sym | Parameter | Min | Max | Units | Notes | Fig |
|------|-------------------------------------------------------------------------|----------------|-------------------|--------|--------|------------------------------|
| t283 | DMI Message to SUS_STAT# active | 2 | | RTCCLK | 1 | 8-17 |
| t284 | SUS_STAT# active to PLTRST#, PCIRST# active | 7 | 17 | RTCCLK | 1 | 8-17 |
| t287 | PLTRST#, PCIRST# active to SLP_S3# active (Consumer Only) | 1 | 2 | RTCCLK | 1 | 8-17 |
| t287 | PLTRST#, PCIRST# active to SLP_S3# active (Corporate Only) | 1 | — | RTCCLK | 1 | 8-17 |
| t289 | SLP_S3# active to PWROK, VRMPWRGD inactive | 0 | | ms | 4 | 8-17 |
| t291 | SLP_S3# active to SLP_S4# active (Consumer Only) | 1 | 2 | RTCCLK | 1 | 8-17 |
| t291 | SLP_S3# active to SLP_S4# active (Corporate Only) | 1 | — | RTCCLK | 1 | 8-17 |
| t294 | PWROK, VRMPWRGD inactive to Vcc supplies inactive (nominal voltage -5%) | 20 | | ns | 23, 25 | 8-17 8-25 |
| t295 | SLP_S4# active to SLP_S5# active (Consumer Only) | 1 | 2 | RTCCLK | 1, 5 | 8-17 |
| t295 | SLP_S4# active to SLP_S5# active (Corporate Only) | 1 | — | RTCCLK | 1, 5 | 8-17 |
| t296 | Wake Event to SLP_S5# inactive | 1 | 10 | RTCCLK | 1 | 8-17 |
| t297 | SLP_S5# inactive to SLP_S4# inactive | 1 | — | RTCCLK | 8 | 8-17 8-21 8-22 8-23 |
| t298 | S4_STATE# inactive to SLP_S3# inactive (Consumer Only) | 1 | Note 16 | RTCCLK | 1 | 8-23 |
| t298 | S4_STATE# inactive to SLP_S3# inactive (Corporate Only) | 1 | — | RTCCLK | 1 | 8-23 |
| t299 | S4 Wake Event to SLP_S4# inactive (S4 Wake) | See Note Below | | | 8 | 8-17 |
| t300 | S3 Wake Event to SLP_S3# inactive (S3 Wake) (Consumer Only) | 0 | small as possible | RTCCLK | 1 | 8-17 |
| t300 | S3 Wake Event to SLP_S3# inactive (S3 Wake) (Corporate Only) | 0 | — | RTCCLK | 1 | 8-17 |
| t301 | S1 Wake Event to STPCLK# inactive | 9 | | PCICLK | | 8-16 |
| t302 | SLP_M# inactive to SLP_S3# inactive | | ±10 | ns | | 8-21 |
| t304 | RSMRST# deassertion to LAN_RST# deassertion | 0 | | ms | 17 | |



Table 8-22. Power Management Timings (Sheet 3 of 3)

| Sym | Parameter | Min | Max | Units | Notes | Fig |
|----------------------|---------------------------------------------------------------|-----|-----|-------|-------|------|
| t305a | LAN Power Rails active to LAN_RST# deassertion | 1 | | ms | 18 | |
| t305b | LAN_RST# assertion to LAN Power Rails inactive | 20 | | ns | 25 | |
| t306 | LANRST# assertion to PWROK assertion | 0 | | ms | | |
| t307 | SLP_S3# active to Vcc supplies inactive (nominal voltage -5%) | 5 | | us | 24 | 8-17 |
| t308a | RSMRST# deassertion to CLPWROK assertion | 0 | | ms | | |
| t308b | Controller Link Power Rails active to CLPWROK assertion | 1 | | ms | | |
| t308c | CLPWROK assertion to PWROK assertion | 0 | | ms | | |
| Other Timings | | | | | | |
| t310 | THRMTRIP# active to SLP_S3#, SLP_S4#, SLP_S5# active | | 175 | ns | | |
| t311 | RSMRST# rising edge transition from 20% to 80% | | 50 | μs | | |
| t312 | RSMRST# falling edge transition | | | | 21 | |
| t313 | SLP_M# active to RSMRST# active | 500 | | μs | | |

NOTES:

- These transitions are clocked off the internal RTC. 1 RTC clock is approximately from 28.992 μs to 32.044 μs.
- The ICH10 STPCLK# assertion will trigger the processor to send a stop grant acknowledge cycle. The timing for this cycle getting to the ICH10 is dependant on the processor and the memory controller.
- These transitions are clocked off the 33 MHz PCICLK. 1 PCICLK is approximately 30 ns.
- The ICH10 has no maximum timing requirement for this transition. It is up to the system designer to determine if the SLP_S3#, SLP_S4# and SLP_S5# signals are used to control the power planes.
- If the transition to S5 is due to Power Button Override, SLP_S3#, SLP_S4# and SLP_S5# are asserted together similar to timing t287 (PCIRST# active to SLP_S3# active).
- If there is no RTC battery in the system, so VccRTC and the VccSus supplies come up together, the delay from RTCRST# and RSMRST# inactive to SUSCLK toggling may be as much as 2.5 s.
- This value is programmable in multiples of 1024 PCI CLKs. Maximum is 8192 PCI CLKs (245.6 μs).
- The Min/Max times depend on the programming of the "SLP_S4# Minimum Assertion Width" and the "SLP_S4# Assertion Stretch Enable bits (D31:F0:A4h bits 5:3)".
- Note that this does not apply for synchronous SMIs.
- This is a clock generator specification
- If the (G)MCH does not have the CPUSLP# signal, then the minimum value can be 16 PCICLK.
- This is non-zero to enforce the minimum assert time for DPRSLPVR. If the minimum assert time for DPRSLPVR has been met, then this is permitted to be 0.
- This is non-zero to enforce the minimum assert time for STP_CPU#. If the minimum assert time for STP_CPU# has been met, then this is permitted to be 0.
- This value should be at most a few clocks greater than the minimum.
- When Intel AMT enabled, S4_STATE# indicates if system is in S4 state or below.
- For t234 and t298, the SLP_M# stretching logic can push the Max value much larger than the Min (e.g., up to 3 seconds). With the installation of the Intel Manageability Engine

firmware, the Max value of t234 and t298 is 99 ms. Without the installation of the firmware, the Max value is 4 RTC clocks.

17. RSMRST# must de-assert at or before LAN_RST# de-assertion.
18. Measured from VccLAN3_3 or VccLAN1_1 power within voltage specification (which ever is later in time) to LAN_RST# = $(V_{ih}+V_{il})/2$. It is acceptable to use an RC circuit sourced from VccLAN3_3 to create LAN_RST#. The rising edge of LAN_RST# needs to be a clean, monotonic edge for frequency content below 10 MHz.
19. If Integrated LAN is supported, LAN_RST# must be de-asserted at or before PWROK assertion.
20. If Integrated LAN is not supported, LAN_RST# should be tied to ground and must never de-assert.
21. RSMRST# falling edge must transition to 0.8 V or less before VccSus3_3 drops to 2.1 V
22. If bit 0 of [Section 13.8.1.3](#) is set to a 1, SLP_S5# will not be de-asserted until a wake event is detected. If bit 0 is set to 0, SLP_S5# will de-assert within the specification listed in the table.
23. t294 is not applied to V5REF. V5REF timings are bounded by power sequencing. t294 applies during S0 to S3/S4/S5 and S0 to G3 transitions.
24. t307 is applicable in S0 to Sx transitions.
25. A Power rail is considered to be inactive when the rail is at its nominal voltage minus 5% or less.

8.5 Timing Diagrams

Figure 8-1. Clock Timing

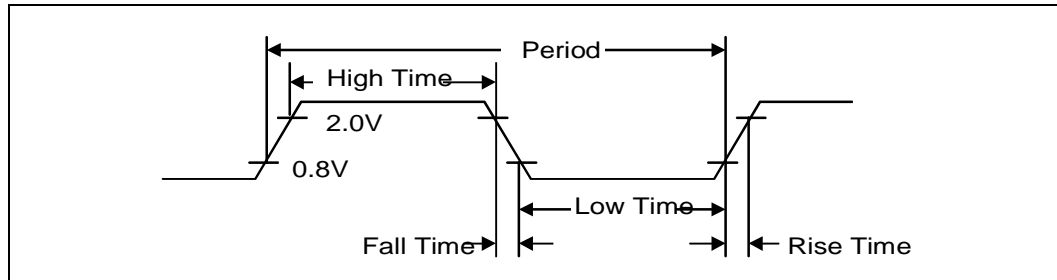
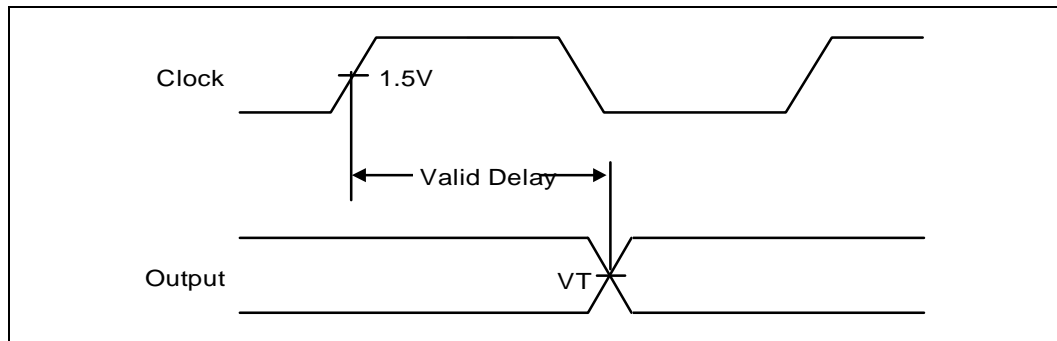

Figure 8-2. Valid Delay from Rising Clock Edge



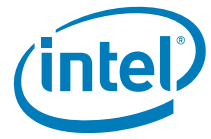

Figure 8-3. Setup and Hold Times

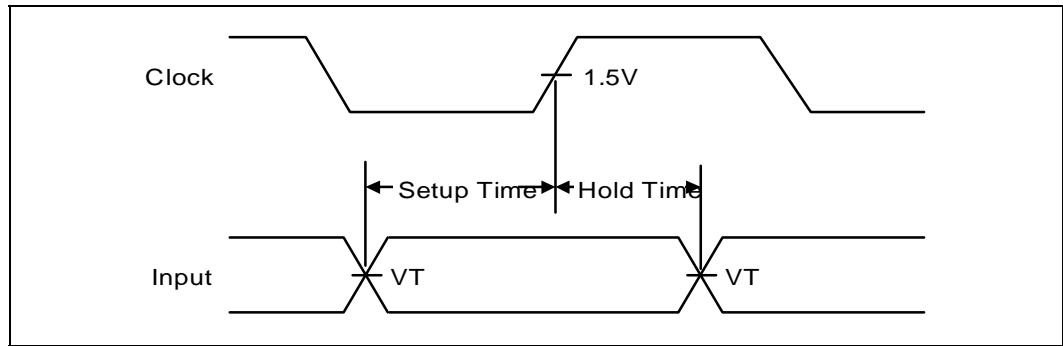

Figure 8-4. Float Delay

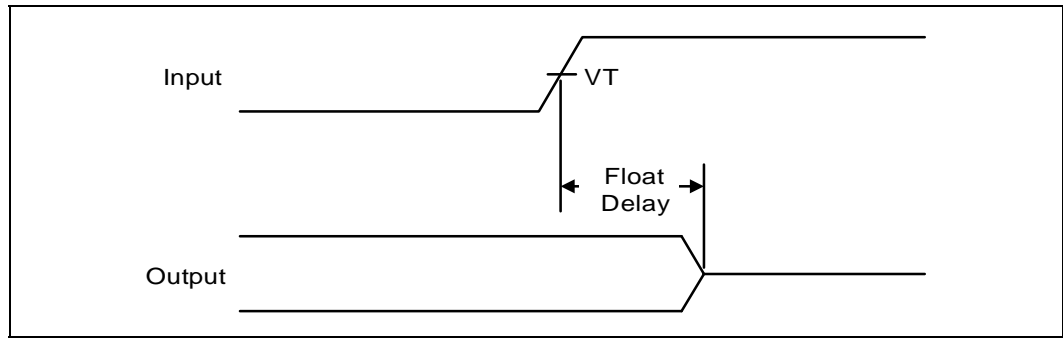

Figure 8-5. Pulse Width

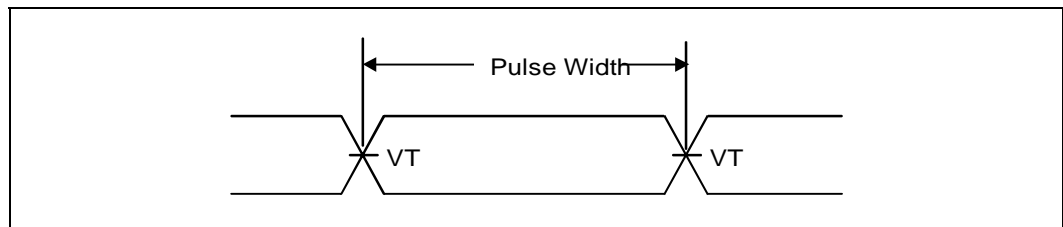

Figure 8-6. Output Enable Delay

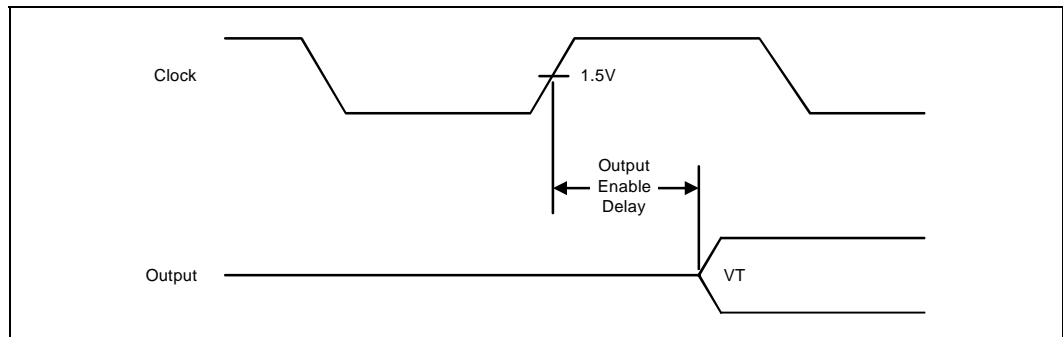

Figure 8-7. USB Rise and Fall Times

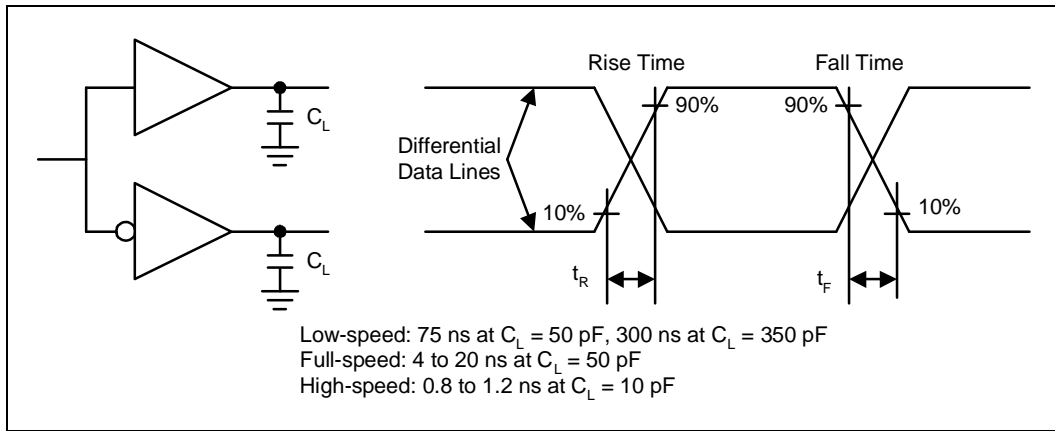

Figure 8-8. USB Jitter

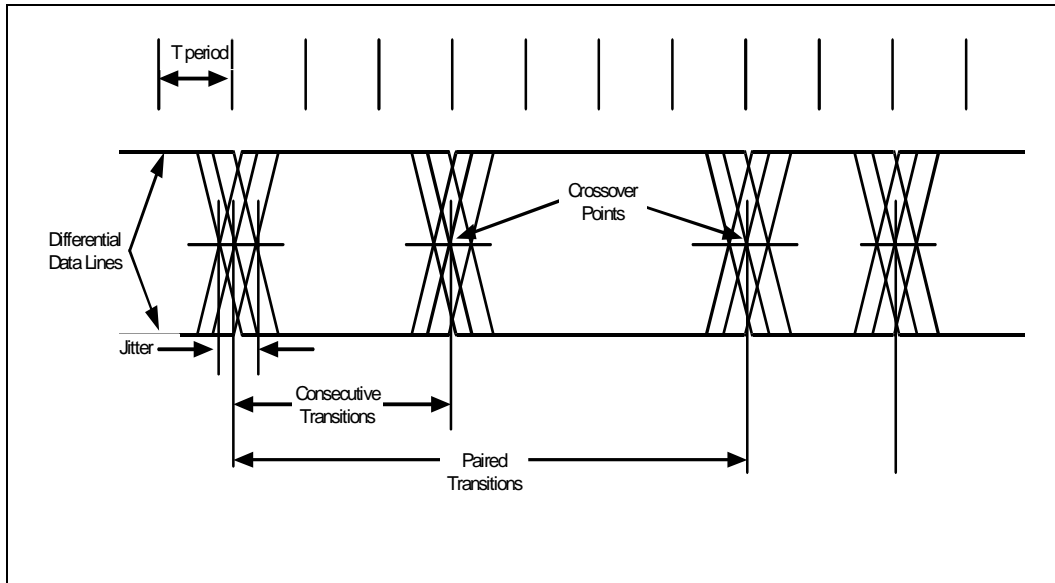
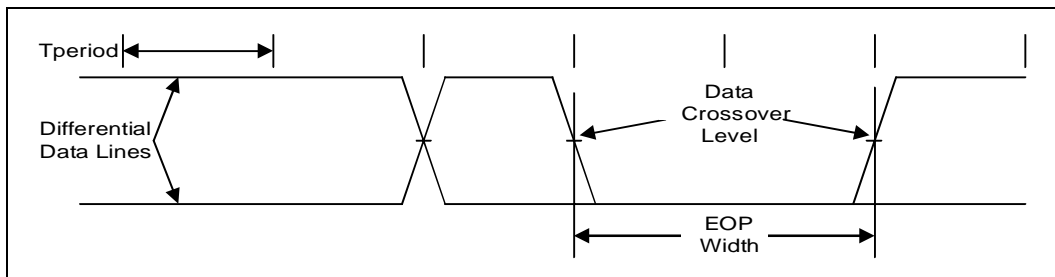

Figure 8-9. USB EOP Width



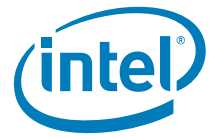

Figure 8-10. SMBus Transaction

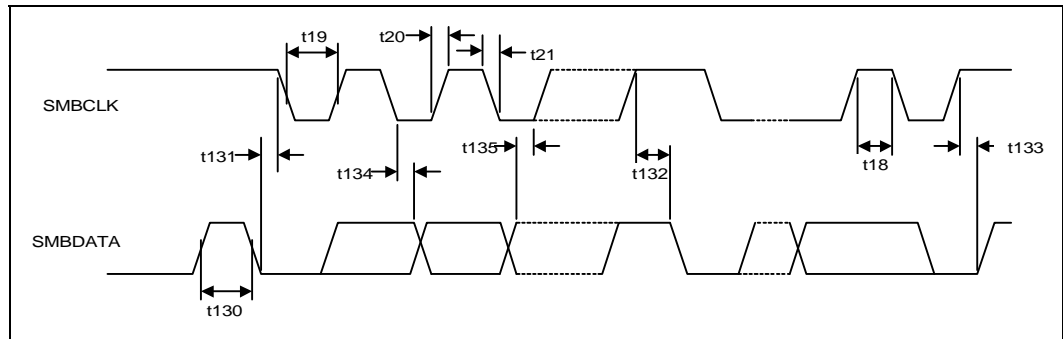

Figure 8-11. SMBus Timeout

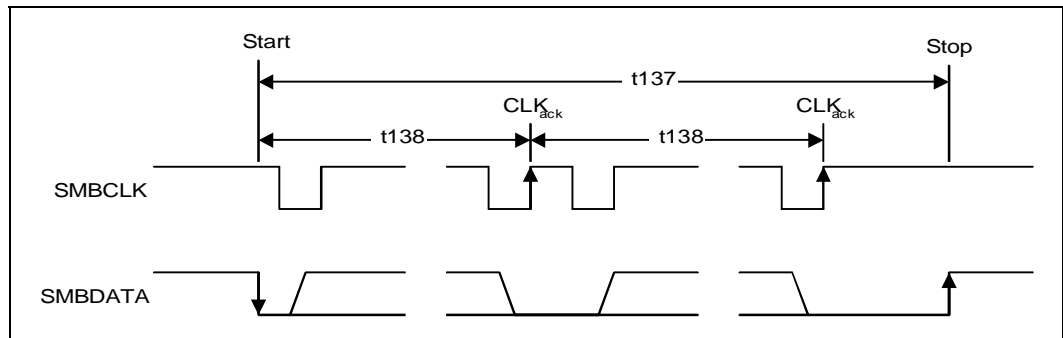

Figure 8-12. SPI Timings

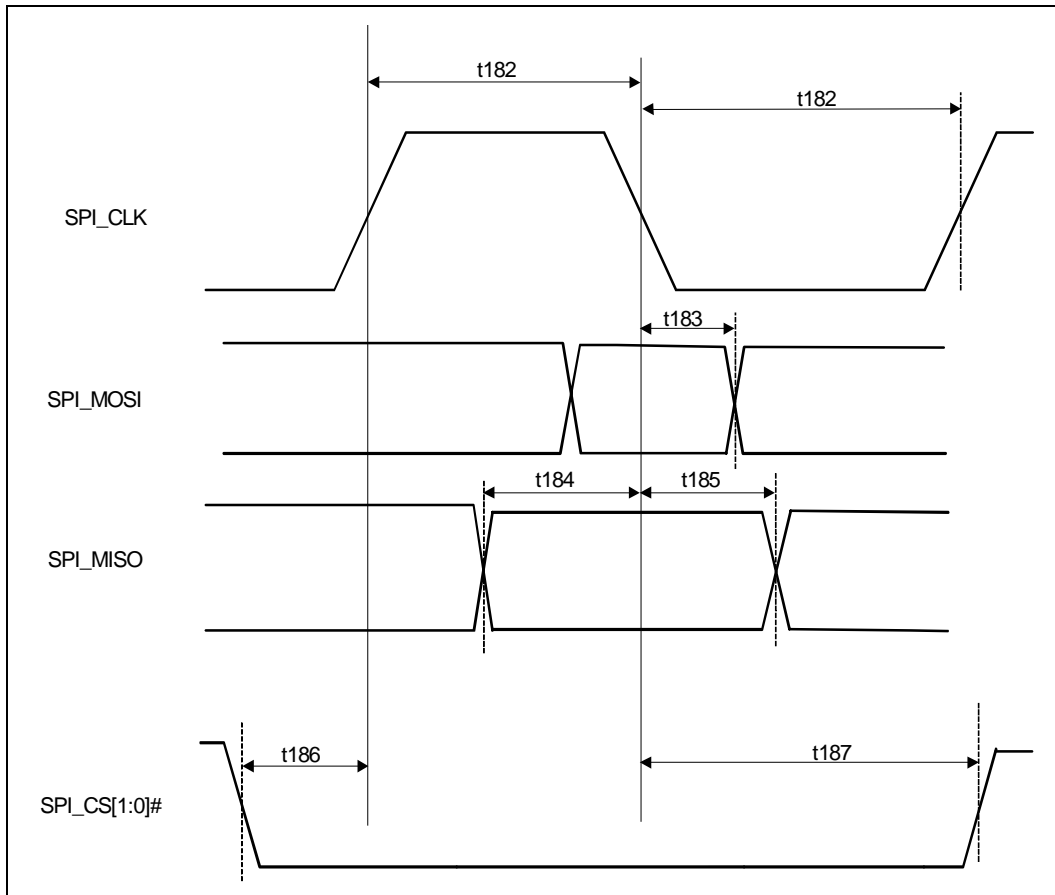

Figure 8-13. Intel® High Definition Audio Input and Output Timings

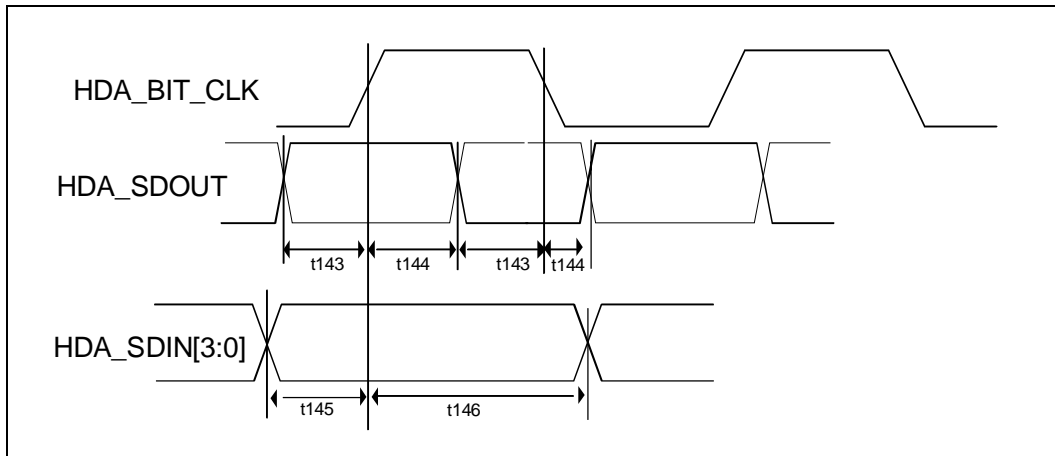
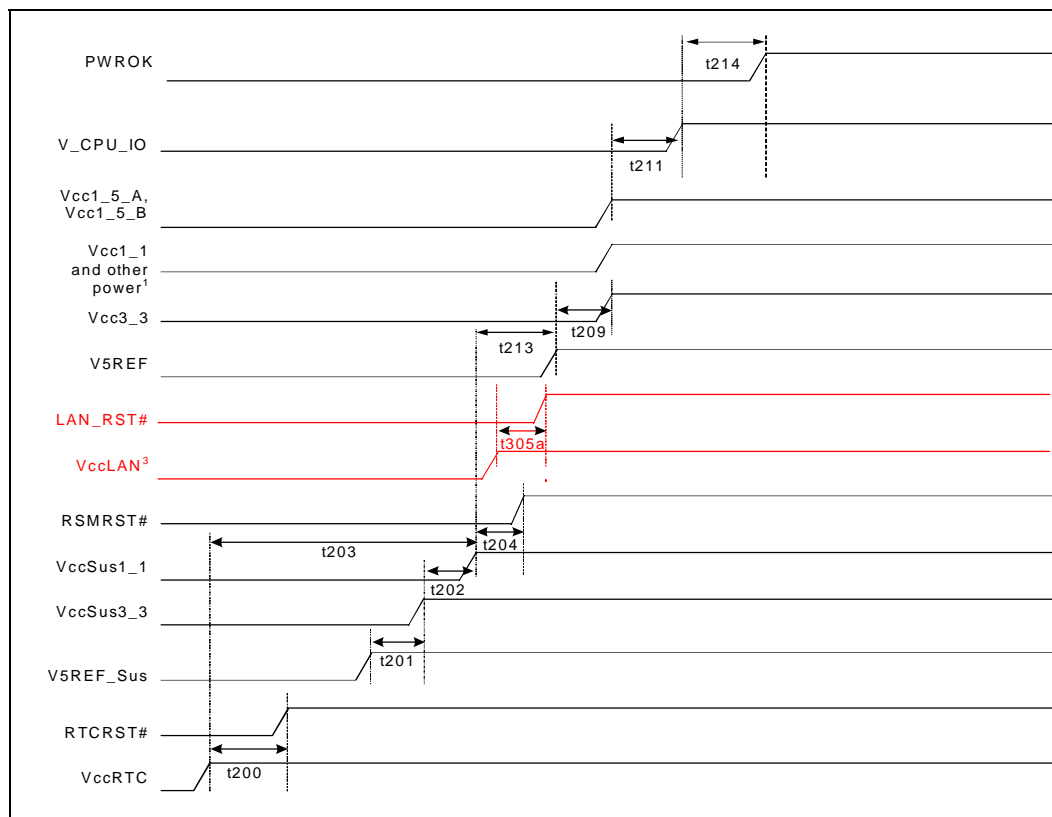



Figure 8-14. Power Sequencing and Reset Signal Timings



NOTES:

1. Other power includes $V_{ccUSBPLL}$, $V_{ccDMIPLL}$, and $V_{ccSATAPLL}$. All of these power signals must independently meet the timings shown in the figure. There are no timing interdependencies between V_{cc1_1} and these other power signals. There are also no timing interdependencies for these power signals, including V_{cc1_1} , to V_{cc3_3} and $V_{cc1_5_A}/V_{cc1_5_B}$.
2. $PWROK$ must not glitch, even if $RSMRST\#$ is low.
3. V_{ccLAN} includes V_{ccLAN3_3} , V_{ccLAN1_1} , and V_{ccCL3_3} .
4. Other power

Figure 8-15. G3 (Mechanical Off) to S0 Timings

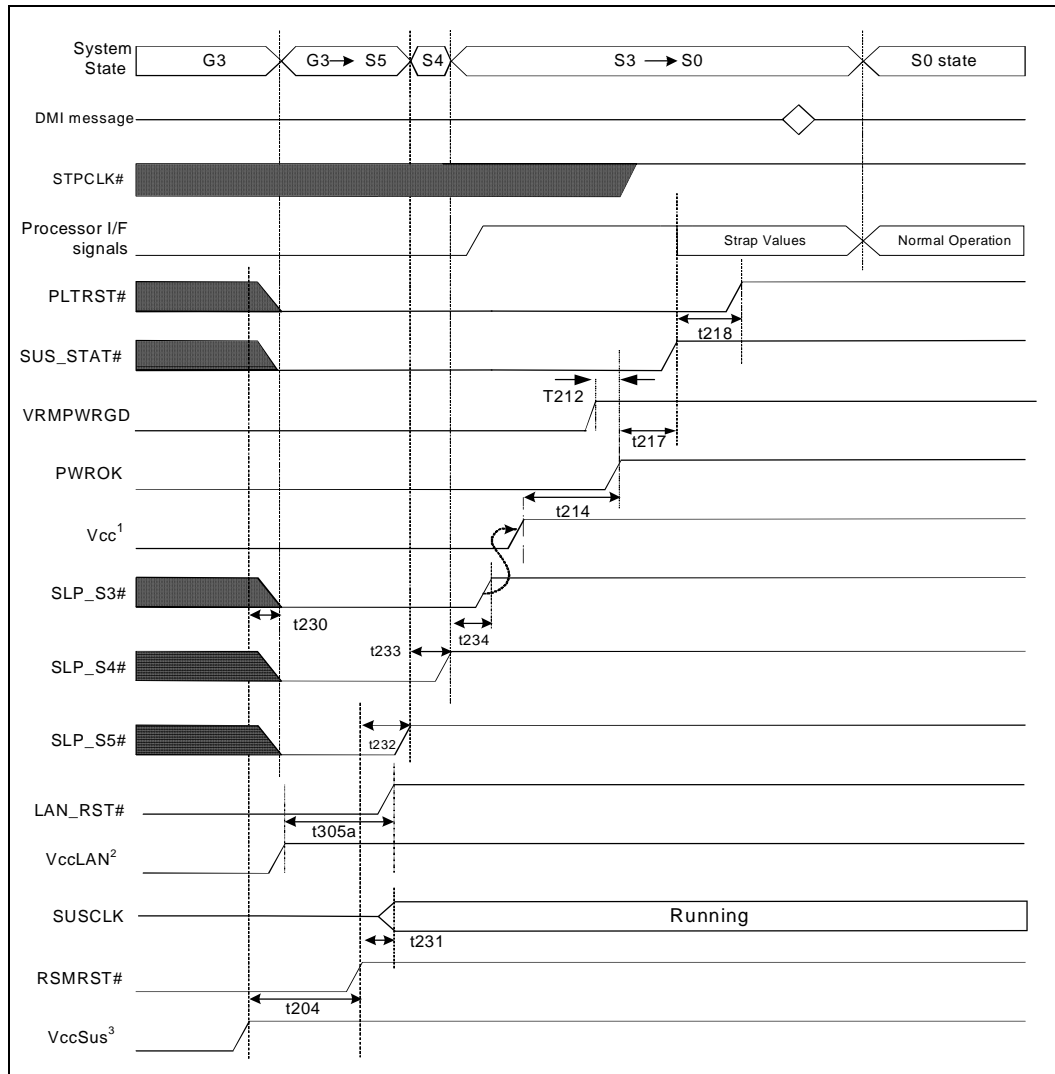

NOTE:

1. Vcc includes Vcc1_5_A, Vcc1_5_B, Vcc3_3, Vcc1_1, VccUSBPLL, VccDMIPLL, VccSATAPLL, V5REF, V_CPU_IO, VccDMI, VccHDA, VccGLANPLL, VccGLAN3_3 and VccGLAN1_5 (if integrated Gigabit LAN enabled), VccLAN3_3 (if LAN only power in S0), and VccCL3_3 (if controller link only powered in S0).
2. VccLAN includes VccLAN3_3, VccLAN1_1, and VccCL3_3.
3. VccSus includes VccSus3_3, V5REF_Sus, VccSusHDA, VccLAN3_3 (if LAN powered in S3/S4/S5), and VccCL3_3 (if controller link powered in S3/S4/S5).

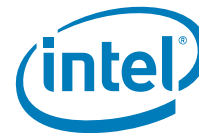

Figure 8-16. S0 to S1 to S0 Timings

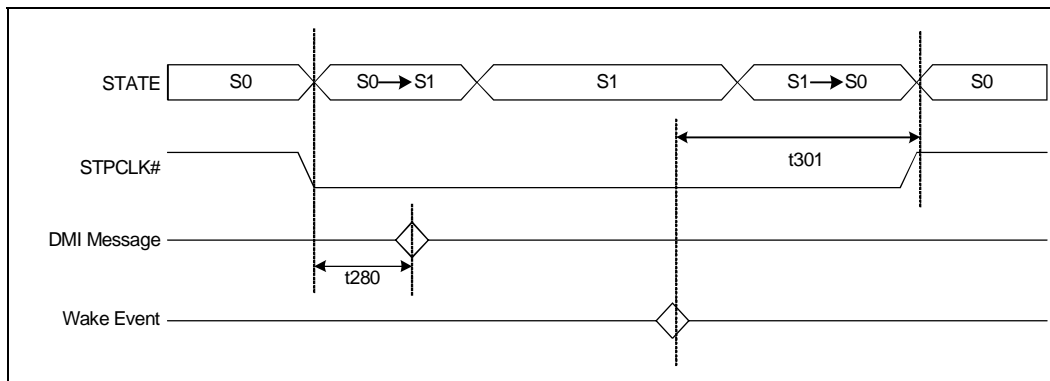
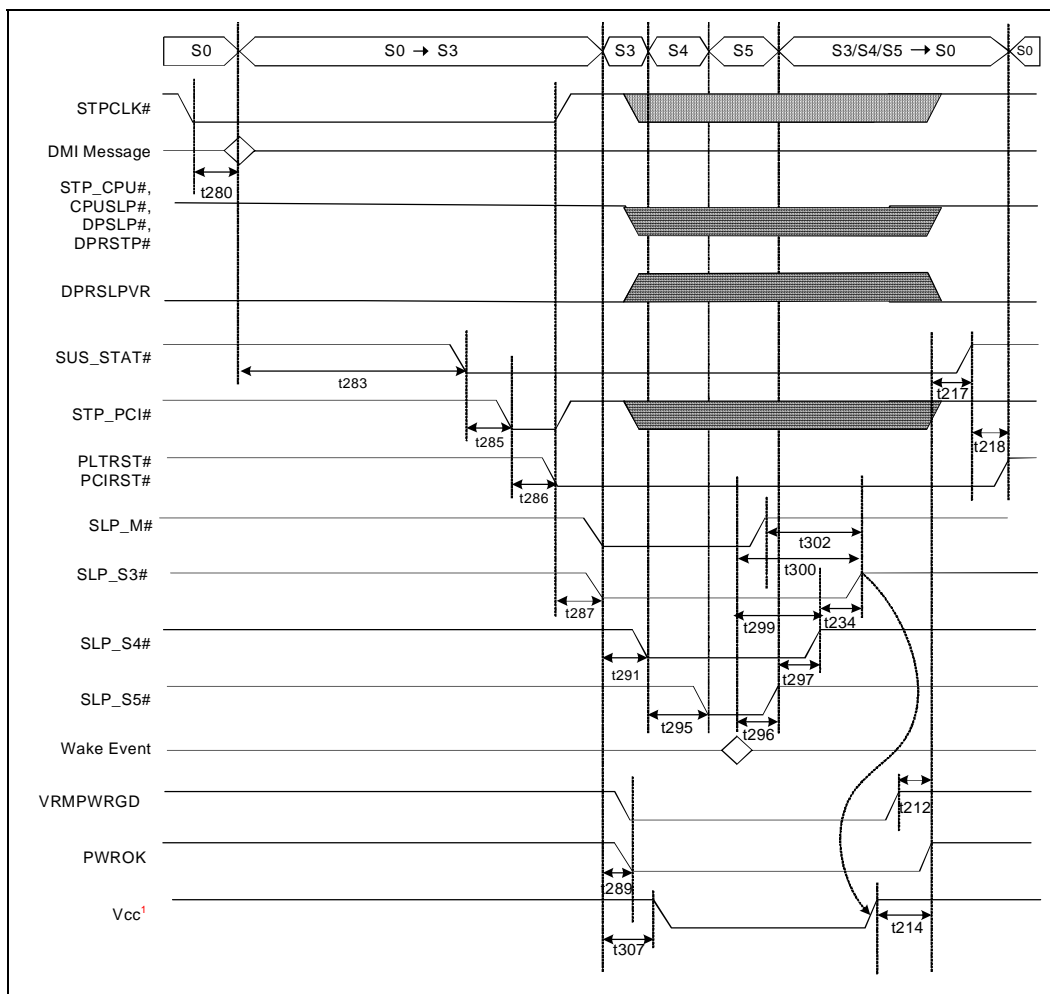

Figure 8-17. S0 to S5 to S0 Timings



NOTE: Vcc includes Vcc1_5_A, Vcc1_5_B, Vcc3_3, Vcc1_1, VccUSBPLL, VccDMIPLL, and VccSATAPLL.

Figure 8-18. C0 to C2 to C0 Timings

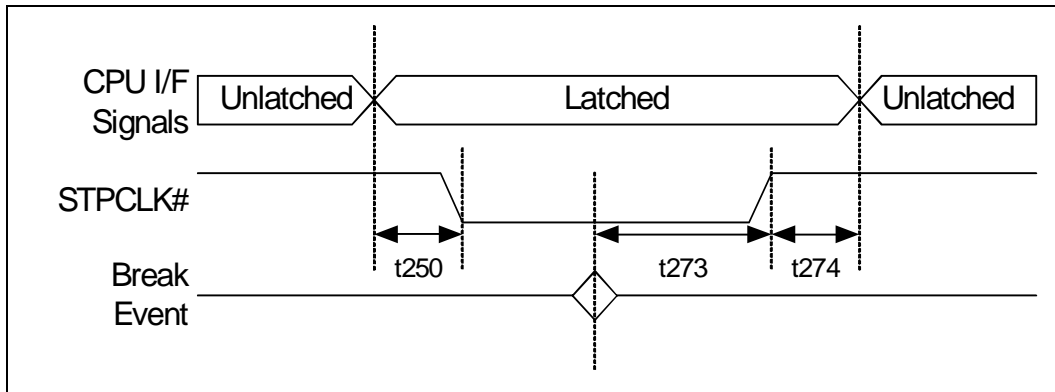
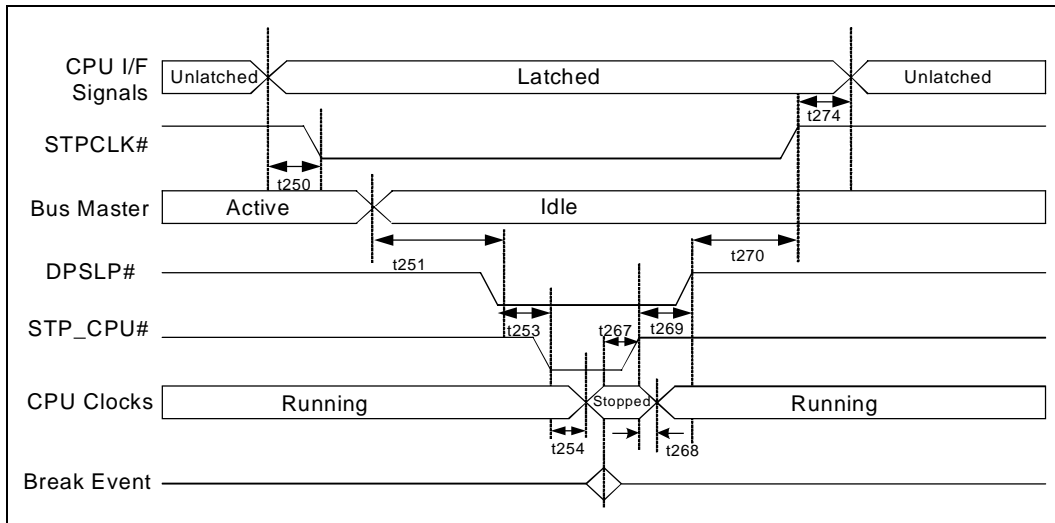

Figure 8-19. C0 to C3 to C0 Timings



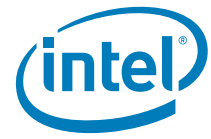

Figure 8-20. C0 to C4 to C0 Timings

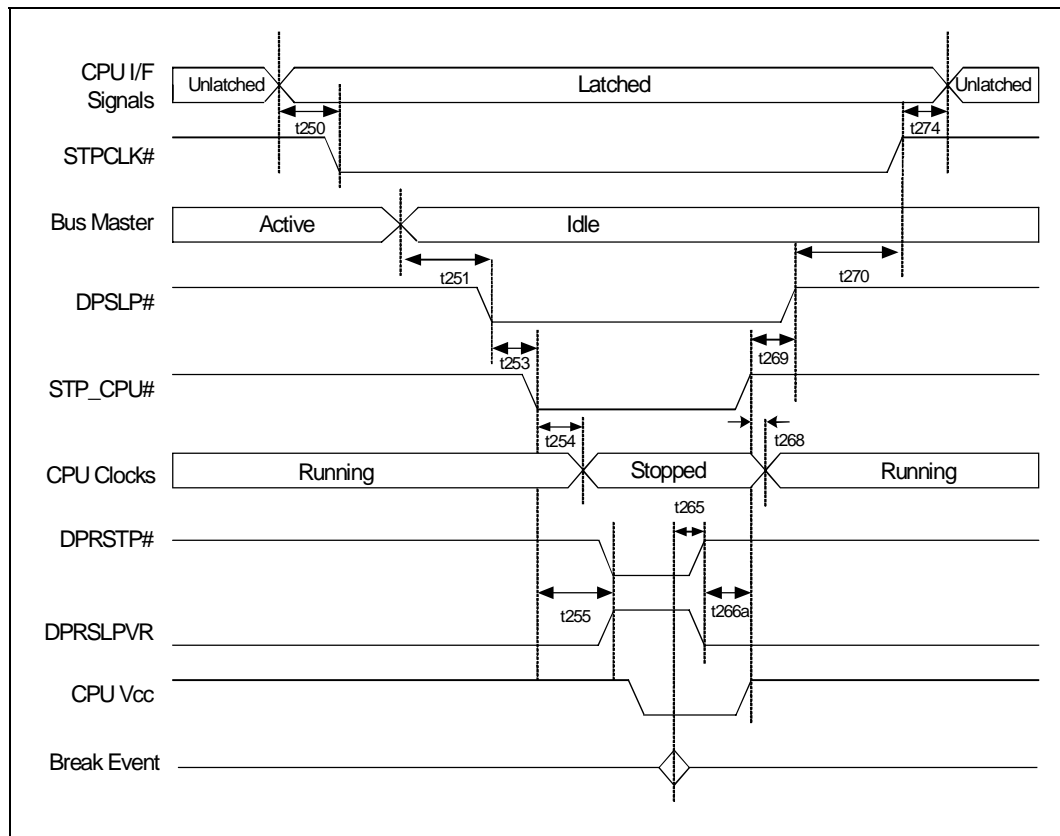
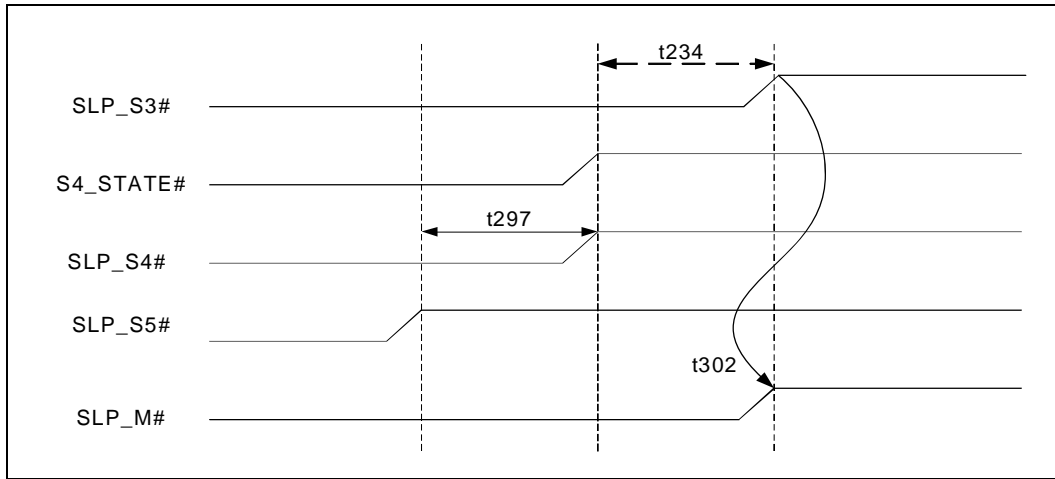

Figure 8-21. Sleep control signal relationship - Host boots and Intel Management Engine off



NOTES:

1. t290 is also applicable when the system transitions from S0 to G3.

Figure 8-22. Sleep control signal relationship - Host and Intel Management Engine boot after G3

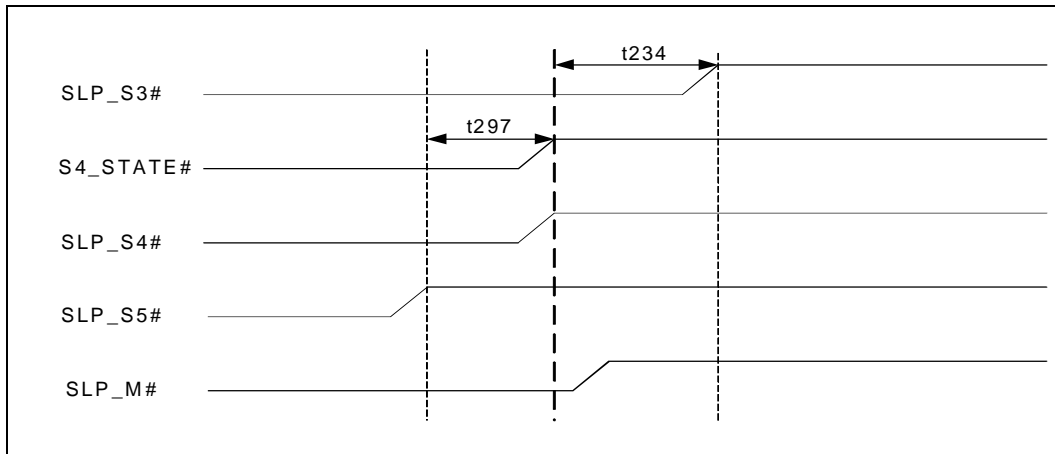

NOTE: When both the host and Intel Management Engine boot after G3, SLP_M# does not have any timing dependency on other sleep control signals. SLP_M# will be de-asserted some time between SLP_S5# de-assertion and SLP_S3# de-assertion.



Figure 8-23. Sleep control signal relationship - Host stays in S5 and Intel Management Engine boots after G3

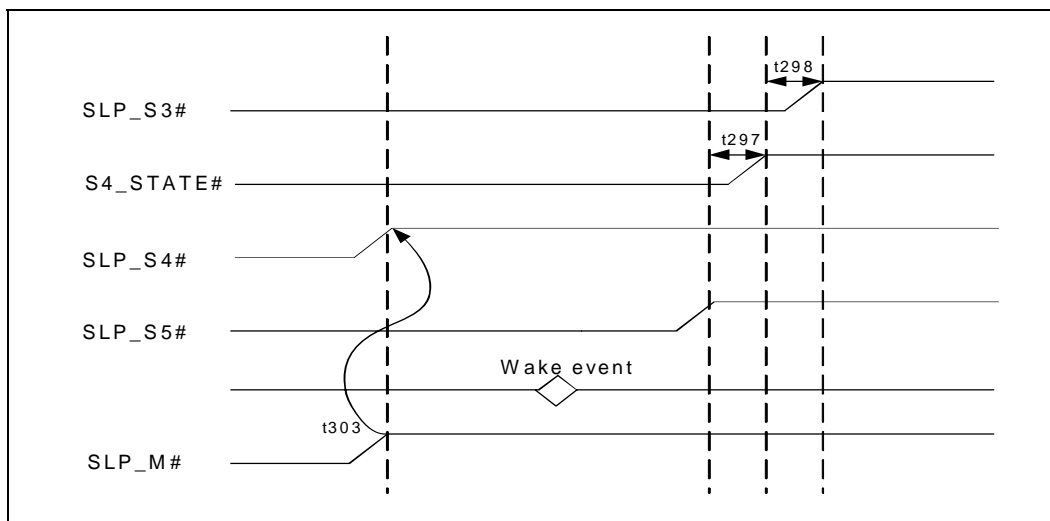
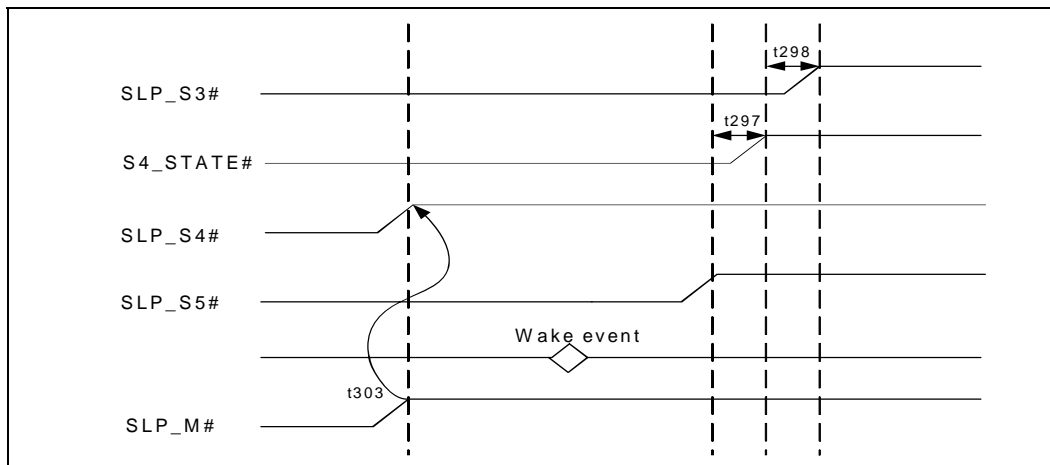
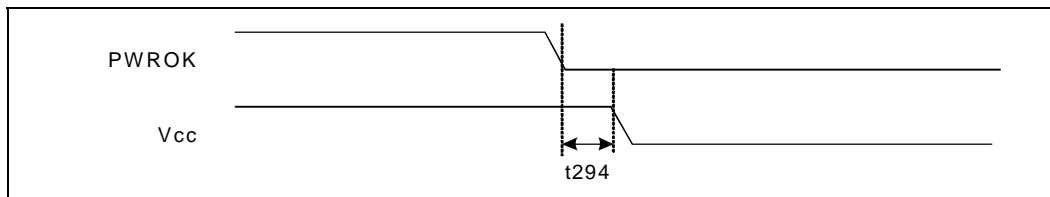

Figure 8-24. S4, S5/M1 to S0/M0



NOTE: Vcc includes Vcc1_5_A, Vcc1_5_B, Vcc3_3, Vcc1_1, VccUSBPLL, VccDMIPLL, and VccSATAPLL.

Figure 8-25. S0 to S3/S4/S5 and G3 Timings



§ §
§ §





9 Register and Memory Mapping

The ICH10 contains registers that are located in the processor's I/O space and memory space and sets of PCI configuration registers that are located in PCI configuration space. This chapter describes the ICH10 I/O and memory maps at the register-set level. Register access is also described. Register-level address maps and Individual register bit descriptions are provided in the following chapters. The following notations and definitions are used in the register/instruction description chapters.

| | |
|-----------------|--------------------------------------------------------------------------------------------------------------------------------------------------------------------------------------------------------------------------------------------------------------------------------------------------------------------------------------------------------------------------------------------------------------------------------------------------------------------------------|
| RO | Read Only. In some cases, if a register is read only, writes to this register location have no effect. However, in other cases, two separate registers are located at the same location where a read accesses one of the registers and a write accesses the other register. See the I/O and memory map tables for details. |
| WO | Write Only. In some cases, if a register is write only, reads to this register location have no effect. However, in other cases, two separate registers are located at the same location where a read accesses one of the registers and a write accesses the other register. See the I/O and memory map tables for details. |
| R/W | Read/Write. A register with this attribute can be read and written. |
| R/WC | Read/Write Clear. A register bit with this attribute can be read and written. However, a write of 1 clears (sets to 0) the corresponding bit and a write of 0 has no effect. |
| R/WO | Read/Write-Once. A register bit with this attribute can be written only once after power up. After the first write, the bit becomes read only. |
| R/WLO | Read/Write, Lock-Once. A register bit with this attribute can be written to the non-locked value multiple times, but to the locked value only once. After the locked value has been written, the bit becomes read only. |
| Reserved | The value of reserved bits must never be changed. For details see Section 9.2 . |
| Default | When ICH10 is reset, it sets its registers to predetermined default states. The default state represents the minimum functionality feature set required to successfully bring up the system. Hence, it does not represent the optimal system configuration. It is the responsibility of the system initialization software to determine configuration, operating parameters, and optional system features that are applicable, and to program the ICH10 registers accordingly. |
| Bold | Register bits that are highlighted in bold text indicate that the bit is implemented in the ICH10. Register bits that are not implemented or are hardwired will remain in plain text. |



9.1 PCI Devices and Functions

The Intel ICH10 incorporates a variety of PCI devices and functions, as shown in [Table 9-1](#). There are seven logical devices for consumer components, and 8 logical devices for Corporate components. The first is the DMI-To-PCI bridge (Device 30). The second device (Device 31) contains most of the standard PCI functions that always existed in the PCI-to-ISA bridges (South Bridges), such as the Intel PIIX4. The third and fourth (Device 29 and Device 26) are the USB and USB2 host controller devices. The fifth (Device 28) is PCI Express device. The sixth (Device 27) is HD Audio controller device. The seventh (Device 25) is the Gigabit Ethernet controller device.

If for some reason, the particular system platform does not want to support any one of the Device Functions, with the exception of D30:F0, they can individually be disabled. The integrated Gigabit Ethernet controller will be disabled if no Platform LAN Connect component is detected (See [Chapter 5.3](#)). When a function is disabled, it does not appear at all to the software. A disabled function will not respond to any register reads or writes, insuring that these devices appear hidden to software.

Table 9-1. PCI Devices and Functions

| Bus:Device:Function | Function Description |
|------------------------------|-----------------------------------------------------|
| Bus 0: Device 30: Function 0 | PCI-to-PCI Bridge |
| Bus 0: Device 31: Function 0 | LPC Controller ¹ |
| Bus 0: Device 31: Function 2 | SATA Controller #1 |
| Bus 0: Device 31: Function 3 | SMBus Controller |
| Bus 0: Device 31: Function 5 | SATA Controller #2 ³ |
| Bus 0: Device 31: Function 6 | Thermal Subsystem |
| Bus 0: Device 29: Function 0 | USB UHCI Controller #1 |
| Bus 0: Device 29: Function 1 | USB UHCI Controller #2 |
| Bus 0: Device 29: Function 2 | USB UHCI Controller #3 |
| Bus 0: Device 29: Function 3 | USB UHCI Controller #6 ² |
| Bus 0: Device 29: Function 7 | USB EHCI Controller #1 |
| Bus 0: Device 26: Function 0 | USB UCHI Controller #4 |
| Bus 0: Device 26: Function 1 | USB UHCI Controller #5 |
| Bus 0: Device 26: Function 2 | USB UHCI Controller #6 ² |
| Bus 0: Device 26: Function 7 | USB EHCI Controller #2 |
| Bus 0: Device 28: Function 0 | PCI Express* Port 1 |
| Bus 0: Device 28: Function 1 | PCI Express Port 2 |
| Bus 0: Device 28: Function 2 | PCI Express Port 3 |
| Bus 0: Device 28: Function 3 | PCI Express Port 4 |
| Bus 0: Device 28: Function 4 | PCI Express Port 5 |
| Bus 0: Device 28: Function 5 | PCI Express Port 6 |
| Bus 0: Device 27: Function 0 | Intel [®] High Definition Audio Controller |
| Bus 0: Device 25: Function 0 | Gigabit Ethernet Controller |

NOTES:

1. The PCI-to-LPC bridge contains registers that control LPC, Power Management, System Management, GPIO, Processor Interface, RTC, Interrupts, Timers, and DMA.



2. The ICH10 can optionally configure the USB ports from a 6-6 configuration into a 8-4 configuration, with 8 ports on D29:F7 EHCI and 4 ports on D26:F7 EHCI. In the 8-4 configuration UHCI #6 will be mapped to D29:F3. In the 6-6 configuration UHCI #6 will be mapped to D26:F2.
3. SATA controller 2 (D31:F5) is only visible in ICH10 desktop components and when D31:F2 CC.SCC=01h.

9.2 PCI Configuration Map

Each PCI function on the ICH10 has a set of PCI configuration registers. The register address map tables for these register sets are included at the beginning of the chapter for the particular function.

Configuration Space registers are accessed through configuration cycles on the PCI bus by the Host bridge using configuration mechanism #1 detailed in the *PCI Local Bus Specification, Revision 2.3*.

Some of the PCI registers contain reserved bits. Software must deal correctly with fields that are reserved. On reads, software must use appropriate masks to extract the defined bits and not rely on reserved bits being any particular value. On writes, software must ensure that the values of reserved bit positions are preserved. That is, the values of reserved bit positions must first be read, merged with the new values for other bit positions and then written back. Note the software does not need to perform read, merge, write operation for the configuration address register.

In addition to reserved bits within a register, the configuration space contains reserved locations. Software should not write to reserved PCI configuration locations in the device-specific region (above address offset 3Fh).

9.3 I/O Map

The I/O map is divided into Fixed and Variable address ranges. Fixed ranges cannot be moved, but in some cases can be disabled. Variable ranges can be moved and can also be disabled.

9.3.1 Fixed I/O Address Ranges

Table 9-2 shows the Fixed I/O decode ranges from the processor perspective. Note that for each I/O range, there may be separate behavior for reads and writes. DMI (Direct Media Interface) cycles that go to target ranges that are marked as "Reserved" will not be decoded by the ICH10, and will be passed to PCI unless the Subtractive Decode Policy bit is set (D31:F0:Offset 42h, bit 0). If a PCI master targets one of the fixed I/O target ranges, it will be positively decoded by the ICH10 in medium speed.

Address ranges that are not listed or marked "Reserved" are **not** decoded by the ICH10 (unless assigned to one of the variable ranges).



Table 9-2. Fixed I/O Ranges Decoded by Intel® ICH10 (Sheet 1 of 2)

| I/O Address | Read Target | Write Target | Internal Unit |
|-------------|--------------------------------|-------------------------------|------------------|
| 00h–08h | DMA Controller | DMA Controller | DMA |
| 09h–0Eh | RESERVED | DMA Controller | DMA |
| 0Fh | DMA Controller | DMA Controller | DMA |
| 10h–18h | DMA Controller | DMA Controller | DMA |
| 19h–1Eh | RESERVED | DMA Controller | DMA |
| 1Fh | DMA Controller | DMA Controller | DMA |
| 20h–21h | Interrupt Controller | Interrupt Controller | Interrupt |
| 24h–25h | Interrupt Controller | Interrupt Controller | Interrupt |
| 28h–29h | Interrupt Controller | Interrupt Controller | Interrupt |
| 2Ch–2Dh | Interrupt Controller | Interrupt Controller | Interrupt |
| 2E–2F | LPC SIO | LPC SIO | Forwarded to LPC |
| 30h–31h | Interrupt Controller | Interrupt Controller | Interrupt |
| 34h–35h | Interrupt Controller | Interrupt Controller | Interrupt |
| 38h–39h | Interrupt Controller | Interrupt Controller | Interrupt |
| 3Ch–3Dh | Interrupt Controller | Interrupt Controller | Interrupt |
| 40h–42h | Timer/Counter | Timer/Counter | PIT (8254) |
| 43h | RESERVED | Timer/Counter | PIT |
| 4E–4F | LPC SIO | LPC SIO | Forwarded to LPC |
| 50h–52h | Timer/Counter | Timer/Counter | PIT |
| 53h | RESERVED | Timer/Counter | PIT |
| 60h | Microcontroller | Microcontroller | Forwarded to LPC |
| 61h | NMI Controller | NMI Controller | Processor I/F |
| 62h | Microcontroller | Microcontroller | Forwarded to LPC |
| 64h | Microcontroller | Microcontroller | Forwarded to LPC |
| 66h | Microcontroller | Microcontroller | Forwarded to LPC |
| 70h | RESERVED | NMI and RTC Controller | RTC |
| 71h | RTC Controller | RTC Controller | RTC |
| 72h | RTC Controller | NMI and RTC Controller | RTC |
| 73h | RTC Controller | RTC Controller | RTC |
| 74h | RTC Controller | NMI and RTC Controller | RTC |
| 75h | RTC Controller | RTC Controller | RTC |
| 76h | RTC Controller | NMI and RTC Controller | RTC |
| 77h | RTC Controller | RTC Controller | RTC |
| 80h | DMA Controller, or LPC, or PCI | DMA Controller and LPC or PCI | DMA |
| 81h–83h | DMA Controller | DMA Controller | DMA |



Table 9-2. Fixed I/O Ranges Decoded by Intel® ICH10 (Sheet 2 of 2)

| I/O Address | Read Target | Write Target | Internal Unit |
|-------------|-----------------------------------|-------------------------------------|-------------------|
| 84h–86h | DMA Controller | DMA Controller and LPC or PCI | DMA |
| 87h | DMA Controller | DMA Controller | DMA |
| 88h | DMA Controller | DMA Controller and LPC or PCI | DMA |
| 89h–8Bh | DMA Controller | DMA Controller | DMA |
| 8Ch–8Eh | DMA Controller | DMA Controller and LPC or PCI | DMA |
| 08Fh | DMA Controller | DMA Controller | DMA |
| 90h–91h | DMA Controller | DMA Controller | DMA |
| 92h | Reset Generator | Reset Generator | Processor I/F |
| 93h–9Fh | DMA Controller | DMA Controller | DMA |
| A0h–A1h | Interrupt Controller | Interrupt Controller | Interrupt |
| A4h–A5h | Interrupt Controller | Interrupt Controller | Interrupt |
| A8h–A9h | Interrupt Controller | Interrupt Controller | Interrupt |
| ACh–ADh | Interrupt Controller | Interrupt Controller | Interrupt |
| B0h–B1h | Interrupt Controller | Interrupt Controller | Interrupt |
| B2h–B3h | Power Management | Power Management | Power Management |
| B4h–B5h | Interrupt Controller | Interrupt Controller | Interrupt |
| B8h–B9h | Interrupt Controller | Interrupt Controller | Interrupt |
| BCh–BDh | Interrupt Controller | Interrupt Controller | Interrupt |
| C0h–D1h | DMA Controller | DMA Controller | DMA |
| D2h–DDh | RESERVED | DMA Controller | DMA |
| DEh–DFh | DMA Controller | DMA Controller | DMA |
| F0h | PCI and Master Abort ¹ | FERR#/IGNNE# / Interrupt Controller | Processor I/F |
| 170h–177h | SATA Controller or PCI | SATA Controller or PCI | Forwarded to SATA |
| 1F0h–1F7h | SATA Controller or PCI | SATA Controller or PCI | Forwarded to SATA |
| 376h | SATA Controller or PCI | SATA Controller or PCI | Forwarded to SATA |
| 3F6h | SATA Controller or PCI | SATA Controller or PCI | Forwarded to SATA |
| 4D0h–4D1h | Interrupt Controller | Interrupt Controller | Interrupt |
| CF9h | Reset Generator | Reset Generator | Processor I/F |

NOTE:

1. A read to this address will subtractively go to PCI, where it will master abort.



9.3.2 Variable I/O Decode Ranges

Table 9-3 shows the Variable I/O Decode Ranges. They are set using Base Address Registers (BARs) or other configuration bits in the various PCI configuration spaces. The PNP software (PCI or ACPI) can use their configuration mechanisms to set and adjust these values.

Warning: The Variable I/O Ranges should not be set to conflict with the Fixed I/O Ranges. Unpredictable results if the configuration software allows conflicts to occur. The ICH10 does not perform any checks for conflicts.

Table 9-3. Variable I/O Decode Ranges

| Range Name | Mappable | Size (Bytes) | Target |
|------------------------|-----------------------------|--------------|------------------|
| ACPI | Anywhere in 64 KB I/O Space | 64 | Power Management |
| IDE Bus Master | Anywhere in 64 KB I/O Space | 16 | IDE Unit |
| Native IDE Command | Anywhere in 64 KB I/O Space | 8 | IDE Unit |
| Native IDE Control | Anywhere in 64 KB I/O Space | 4 | IDE Unit |
| USB UHCI Controller #1 | Anywhere in 64 KB I/O Space | 32 | USB Unit 1 |
| USB UHCI Controller #2 | Anywhere in 64 KB I/O Space | 32 | USB Unit 2 |
| USB UHCI Controller #3 | Anywhere in 64 KB I/O Space | 32 | USB Unit 3 |
| USB UHCI Controller #4 | Anywhere in 64 KB I/O Space | 32 | USB Unit 4 |
| USB UHCI Controller #5 | Anywhere in 64 KB I/O Space | 32 | USB Unit 5 |
| USB UHCI Controller #6 | Anywhere in 64 KB I/O Space | 32 | USB Unit 6 |
| SMBus | Anywhere in 64 KB I/O Space | 32 | SMB Unit |
| TCO | 96 Bytes above ACPI Base | 32 | TCO Unit |
| GPIO | Anywhere in 64 KB I/O Space | 64 | GPIO Unit |
| Parallel Port | 3 Ranges in 64 KB I/O Space | 8 | LPC Peripheral |
| Serial Port 1 | 8 Ranges in 64 KB I/O Space | 8 | LPC Peripheral |
| Serial Port 2 | 8 Ranges in 64 KB I/O Space | 8 | LPC Peripheral |
| Floppy Disk Controller | 2 Ranges in 64 KB I/O Space | 8 | LPC Peripheral |
| LAN | Anywhere in 64 KB I/O Space | 32 | LAN Unit |
| LPC Generic 1 | Anywhere in 64 KB I/O Space | 4 to 256 | LPC Peripheral |
| LPC Generic 2 | Anywhere in 64 KB I/O Space | 4 to 256 | LPC Peripheral |
| LPC Generic 3 | Anywhere in 64 KB I/O Space | 4 to 256 | LPC Peripheral |
| LPC Generic 4 | Anywhere in 64 KB I/O Space | 4 to 256 | LPC Peripheral |
| I/O Trapping Ranges | Anywhere in 64 KB I/O Space | 1 to 256 | Trap on Backbone |

NOTE:

1. Decode range size determined by D31:F0:ADh:bits 5:4



9.4 Memory Map

Table 9-4 shows (from the processor perspective) the memory ranges that the ICH10 decodes. Cycles that arrive from DMI that are not directed to any of the internal memory targets that decode directly from DMI will be driven out on PCI unless the Subtractive Decode Policy bit is set (D31:F0:Offset 42h, bit 0).

PCI cycles generated by external PCI masters will be positively decoded unless they fall in the PCI-to-PCI bridge memory forwarding ranges (those addresses are reserved for PCI peer-to-peer traffic). If the cycle is not in the internal LAN controller's range, it will be forwarded up to DMI. Software must not attempt locks to the ICH10's memory-mapped I/O ranges for EHCI and HPET. If attempted, the lock is not honored which means potential deadlock conditions may occur.

Table 9-4. Memory Decode Ranges from Processor Perspective (Sheet 1 of 2)

| Memory Range | Target | Dependency/Comments |
|------------------------------------------------------------|------------------------------------|------------------------------------------------------------------------------|
| 0000 0000h–000D FFFFh 0010 0000h–TOM (Top of Memory) | Main Memory | TOM registers in Host controller |
| 000E 0000h–000E FFFFh | Firmware Hub | Bit 6 in Firmware Hub Decode Enable register is set |
| 000F 0000h–000F FFFFh | Firmware Hub | Bit 7 in Firmware Hub Decode Enable register is set |
| FEC_ _000h–FEC_ _040h (Corporate Only) | IO(x) APIC inside ICH10 | _ is controlled via APIC Range Select (ASEL) field and APIC Enable (AEN) bit |
| FEC0 _000h–FEC0 _040h (Consumer Only) | IO(x) APIC inside ICH10 | _ is controlled via APIC Range Select (ASEL) field and APIC Enable (AEN) bit |
| FEC1 0000h–FEC1 7FFF | PCI Express* Port 1 | PCI Express* Root Port 1 I/OxAPIC Enable (PAE) set |
| FEC1 8000h–FEC1 8FFFh | PCI Express* Port 2 | PCI Express* Root Port 2 I/OxAPIC Enable (PAE) set |
| FEC2 0000h–FEC2 7FFFh | PCI Express* Port 3 | PCI Express* Root Port 3 I/OxAPIC Enable (PAE) set |
| FEC2 8000h–FEC2 8FFFh | PCI Express* Port 4 | PCI Express* Root Port 4 I/OxAPIC Enable (PAE) set |
| FEC3 0000h–FEC3 7FFFh | PCI Express* Port 5 | PCI Express* Root Port 5 I/OxAPIC Enable (PAE) set |
| FEC3 8000h–FEC3 8FFFh | PCI Express* Port 6 | PCI Express* Root Port 6 I/OxAPIC Enable (PAE) set |
| FED4 0000h–FED4 BFFFh | TPM on LPC | |
| FFC0 0000h–FFC7 FFFFh FF80 0000h–FF87 FFFFh | Firmware Hub (or PCI) ² | Bit 8 in Firmware Hub Decode Enable register is set |
| FFC8 0000h–FFCF FFFFh FF88 0000h–FF8F FFFFh | Firmware Hub (or PCI) ² | Bit 9 in Firmware Hub Decode Enable register is set |
| FFD0 0000h–FFD7 FFFFh FF90 0000h–FF97 FFFFh | Firmware Hub (or PCI) ² | Bit 10 in Firmware Hub Decode Enable register is set |
| FFD8 0000h–FFDF FFFFh FF98 0000h–FF9F FFFFh | Firmware Hub (or PCI) ² | Bit 11 in Firmware Hub Decode Enable register is set |

Table 9-4. Memory Decode Ranges from Processor Perspective (Sheet 2 of 2)

| Memory Range | Target | Dependency/Comments |
|------------------------------------------------|----------------------------------------------------------|----------------------------------------------------------------------------------------------------------------------------|
| FFE0 000h–FFE7 FFFFh FFA0 0000h–FFA7 FFFFh | Firmware Hub (or PCI) ² | Bit 12 in Firmware Hub Decode Enable register is set |
| FFE8 0000h–FFE7 FFFFh FFA8 0000h–FFAF FFFFh | Firmware Hub (or PCI) ³ | Bit 13 in Firmware Hub Decode Enable register is set |
| FFF0 0000h–FFF7 FFFFh FFB0 0000h–FFB7 FFFFh | Firmware Hub (or PCI) ² | Bit 14 in Firmware Hub Decode Enable register is set |
| FFF8 0000h–FFFF FFFFh FFB8 0000h–FFBF FFFFh | Firmware Hub (or PCI) ² | Always enabled. The top two, 64 KB blocks of this range can be swapped, as described in Section 7.4.1 . |
| FF70 0000h–FF7F FFFFh FF30 0000h–FF3F FFFFh | Firmware Hub (or PCI) ² | Bit 3 in Firmware Hub Decode Enable register is set |
| FF60 0000h–FF6F FFFFh FF20 0000h–FF2F FFFFh | Firmware Hub (or PCI) ² | Bit 2 in Firmware Hub Decode Enable register is set |
| FF50 0000h–FF5F FFFFh FF10 0000h–FF1F FFFFh | Firmware Hub (or PCI) ² | Bit 1 in Firmware Hub Decode Enable register is set |
| FF40 0000h–FF4F FFFFh FF00 0000h–FF0F FFFFh | Firmware Hub (or PCI) ² | Bit 0 in Firmware Hub Decode Enable register is set |
| 128 KB anywhere in 4-GB range | Integrated LAN Controller | Enable via BAR in Device 25:Function 0 (Integrated LAN Controller) |
| 1 KB anywhere in 4-GB range | USB EHCI Controller #1 ¹ | Enable via standard PCI mechanism (Device 29, Function 7) |
| 1 KB anywhere in 4-GB range | USB EHCI Controller #2 ¹ | Enable via standard PCI mechanism (Device 26, Function 7) |
| 512 B anywhere in 64-bit addressing space | Intel [®] High Definition Audio Host Controller | Enable via standard PCI mechanism (Device 27, Function 0) |
| FED0 X000h–FED0 X3FFh | High Precision Event Timers ¹ | BIOS determines the “fixed” location which is one of four, 1-KB ranges where X (in the first column) is 0h, 1h, 2h, or 3h. |
| All other | PCI | None |

NOTES:

- Software must not attempt locks to memory mapped I/O ranges for USB EHCI or High Precision Event Timers. If attempted, the lock is not honored, which means potential deadlock conditions may occur.
- PCI is the target when the Boot BIOS Destination selection bits are set to 10b (Chipset Config Registers: Offset 3401 bits 11:10). When PCI selected, the Firmware Hub Decode Enable bits have no effect.

9.4.1 Boot-Block Update Scheme

The ICH10 supports a “top-block swap” mode that has the ICH10 swap the top block in the Firmware Hub (the boot block) with another location. This allows for safe update of the Boot Block (even if a power failure occurs). When the “TOP_SWAP” Enable bit is set, the ICH10 will invert A16 for cycles targeting Firmware Hub space. When this bit is 0, the ICH10 will not invert A16. This bit is automatically set to 0 by RTCRST#, but not by PLTRST#.



The scheme is based on the concept that the top block is reserved as the “boot” block, and the block immediately below the top block is reserved for doing boot-block updates.

The algorithm is:

1. Software copies the top block to the block immediately below the top
2. Software checks that the copied block is correct. This could be done by performing a checksum calculation.
3. Software sets the TOP_SWAP bit. This will invert A16 for cycles going to the Firmware Hub. processor access to FFFF_0000h through FFFF_FFFFh will be directed to FFFE_0000h through FFFE_FFFFh in the Firmware Hub, and processor accesses to FFFE_0000h through FFFE_FFFF will be directed to FFFF_0000h through FFFF_FFFFh.
4. Software erases the top block
5. Software writes the new top block
6. Software checks the new top block
7. Software clears the TOP_SWAP bit
8. Software sets the Top_Swap Lock-Down bit

If a power failure occurs at any point after step 3, the system will be able to boot from the copy of the boot block that is stored in the block below the top. This is because the TOP_SWAP bit is backed in the RTC well.

Note: The top-block swap mode may be forced by an external strapping option (See [Section 2.25.1](#)). When top-block swap mode is forced in this manner, the TOP_SWAP bit cannot be cleared by software. A re-boot with the strap removed will be required to exit a forced top-block swap mode.

Note: Top-block swap mode only affects accesses to the Firmware Hub space, not feature space.

Note: The top-block swap mode has no effect on accesses below FFFE_0000h.



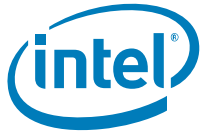

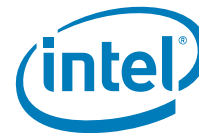

10 Chipset Configuration Registers

This section describes all registers and base functionality that is related to chipset configuration and not a specific interface (such as LPC, PCI, or PCI Express*). It contains the root complex register block, which describes the behavior of the upstream internal link.

This block is mapped into memory space, using the Root Complex Base Address (RCBA) register of the PCI-to-LPC bridge. Accesses in this space must be limited to 32-(DW) bit quantities. Burst accesses are not allowed.

All Chipset Configuration Registers are located in the core well unless otherwise indicated.

10.1 Chipset Configuration Registers (Memory Space)

Note: Address locations that are not shown should be treated as Reserved (see [Section 9.2](#) for details).

Table 10-1. Chipset Configuration Register Memory Map (Memory Space) (Sheet 1 of 4)

| Offset | Mnemonic | Register Name | Default | Type |
|--------------------------------|----------|---------------------------------------|-----------|----------|
| 0000–0003h | VCH | Virtual Channel Capability Header | 10010002h | R/WO |
| 0004–0007h | VCAP1 | Virtual Channel Capability #1 | 00000801h | RO, R/WO |
| 0008–000Bh | VCAP2 | Virtual Channel Capability #2 | 00000001h | RO |
| 000C–000Dh | PVC | Port VC Control | 0000h | RO, R/W |
| 000E–000Fh | PVS | Port VC Status | 0000h | RO |
| 0010–0013h | VOCAP | VC 0 Resource Capability | 00000001h | RO |
| 0014–0017h | VOCTL | VC 0 Resource Control | 800000FFh | R/W, RO |
| 001A–001Bh | VOSTS | VC 0 Resource Status | 0000h | RO |
| 001C–001Fh | V1CAP | VC 1 Resource Capability | 03008011h | R/WO, RO |
| 0020–0023h | V1CTL | VC 1 Resource Control | 00000000h | R/W |
| 0026–0027h | V1STS | VC 1 Resource Status | 0000h | RO |
| 0030–006Fh (Corporate Only) | — | Reserved | — | — |
| 0030–006Fh (Consumer Only) | PAT | Port Arbitration Table | | |
| 0088–008Bh | CIR1 | Chipset Initialization Register 1 | 00000000h | R/WO |
| 00AC–00AFh | REC | Root Error Command | 0000h | R/W |
| 0100–0103h | RCTCL | Root Complex Topology Capability List | 1A010005h | RO |
| 0104–0107h | ESD | Element Self Description | 00000802h | R/WO, RO |
| 0110–0113h | ULD | Upstream Link Descriptor | 00000001h | R/WO, RO |



Table 10-1. Chipset Configuration Register Memory Map (Memory Space) (Sheet 2 of 4)

| Offset | Mnemonic | Register Name | Default | Type |
|------------|----------|------------------------------------------------------|-------------------|----------|
| 0118–011Fh | ULBA | Upstream Link Base Address | 0000000000000000h | R/WO |
| 0120–0123h | RP1D | Root Port 1 Descriptor | 01xx0002h | R/WO, RO |
| 0128–012Fh | RP1BA | Root Port 1 Base Address | 00000000000E0000h | RO |
| 0130–0133h | RP2D | Root Port 2 Descriptor | 02xx0002h | R/WO, RO |
| 0138–013Fh | RP2BA | Root Port 2 Base Address | 00000000000E1000h | RO |
| 0140–0143h | RP3D | Root Port 3 Descriptor | 03xx0002h | R/WO, RO |
| 0148–014Fh | RP3BA | Root Port 3 Base Address | 00000000000E2000h | RO |
| 0150–0153h | RP4D | Root Port 4 Descriptor | 04xx0002h | R/WO, RO |
| 0158–015Fh | RP4BA | Root Port 4 Base Address | 00000000000E3000h | RO |
| 0160–0163h | HDD | Intel® High Definition Audio Descriptor | 15xx0002h | R/WO, RO |
| 0168–016Fh | HDBA | Intel High Definition Audio Base Address | 00000000000D8000h | RO |
| 0170–0173h | RP5D | Root Port 5 Descriptor | 05xx0002h | R/WO, RO |
| 0178–017Fh | RP5A | Root Port 5 Base Address | 00000000000E4000h | RO |
| 0180–0183h | RP6D | Root Port 6 Descriptor | 06xx0002h | R/WO, RO |
| 0188–018Fh | RP6BA | Root Port 6 Base Address | 00000000000E5000h | RO |
| 01A0–01A3h | ILCL | Internal Link Capability List | 00010006h | RO |
| 01A4–01A7h | LCAP | Link Capabilities | 00012841h | RO, R/WO |
| 01A8–01A9h | LCTL | Link Control | 0000h | R/W |
| 01AA–01ABh | LSTS | Link Status | 0041h | RO |
| 01F4–01F7h | CIR2 | Chipset Initialization Register 2 | 00000000h | R/W |
| 01FC–01FDh | CIR3 | Chipset Initialization Register 3 | 0000h | R/W |
| 0220–0223h | BCR | Backbone Configuration | 00000000h | R/W |
| 0224–0227h | RPC | Root Port Configuration | 0000000yh | R/W, RO |
| 0234–0327h | DMIC | DMI Control | 00000000h | R/W, RO |
| 0238–023Bh | RPFN | Root Port Function Number for PCI Express Root Ports | 00543210h | R/WO, RO |
| 0290–0293h | FPSS | Function Level Reset Pending Status Summary | 00000000h | RO |
| 0F20–0F23h | CIR13 | Chipset Initialization Register 13 | B2B477CCh | R/W |
| 1D40–1D47h | CIR5 | Chipset Initialization Register 5 | 0000000000000000h | R/W |
| 1E00–1E03h | TRSR | Trap Status Register | 00000000h | R/WC, RO |
| 1E10–1E17h | TRCR | Trapped Cycle Register | 0000000000000000h | RO |
| 1E18–1E1Fh | TWDR | Trapped Write Data Register | 0000000000000000h | RO |
| 1E80–1E87h | IOTR0 | I/O Trap Register 0 | 0000000000000000h | R/W |
| 1E88–1E8Fh | IOTR1 | I/O Trap Register 1 | 0000000000000000h | R/W |
| 1E90–1E97h | IOTR2 | I/O Trap Register 2 | 0000000000000000h | R/W |



Table 10-1. Chipset Configuration Register Memory Map (Memory Space) (Sheet 3 of 4)

| Offset | Mnemonic | Register Name | Default | Type |
|--------------------------------|----------|------------------------------------|-------------------|------------|
| 1E98-1E9Fh | IOTR3 | I/O Trap Register 3 | 0000000000000000h | R/W |
| 2010-2013h | DMC | DMI Miscellaneous Control register | 00000002h | R/W |
| 2034-2037h | CIR7 | Chipset Initialization Register 7 | B2B477CCh | R/W |
| 3000-3000h | TCTL | TCO Control | 00h | R/W |
| 3100-3103h | D31IP | Device 31 Interrupt Pin | 03243200h | R/W, RO |
| 3104-3107h | D30IP | Device 30 Interrupt Pin | 00000000h | RO |
| 3108-310Bh | D29IP | Device 29 Interrupt Pin | 10004321h | R/W |
| 310C-310Fh | D28IP | Device 28 Interrupt Pin | 00214321h | R/W |
| 3110-3113h | D27IP | Device 27 Interrupt Pin | 00000001h | R/W |
| 3114-3117h | D26IP | Device 26 Interrupt Pin | 30000321h | R/W |
| 3118-311Bh | D25IP | Device 25 Interrupt Pin | 00000001h | R/W |
| 3140-3141h | D31IR | Device 31 Interrupt Route | 3210h | R/W |
| 3142-3143h | D30IR | Device 30 Interrupt Route | 0000h | RO |
| 3144-3145h | D29IR | Device 29 Interrupt Route | 3210h | R/W |
| 3146-3147h | D28IR | Device 28 Interrupt Route | 3210h | R/W |
| 3148-3149h | D27IR | Device 27 Interrupt Route | 3210h | R/W |
| 314C-314Dh | D26IR | Device 26 Interrupt Route | 3210h | R/W |
| 3150-3151h | D25IR | Device 25 Interrupt Route | 3210h | R/W |
| 31FE-31FFh (Corporate Only) | OIC | Other Interrupt Control | 0000h | R/W |
| 31FF-31FFh (Consumer Only) | OIC | Other Interrupt Control | 00h | R/W |
| 3300-3303h | SBEMC3 | Scheduled Break Event C3 | 00000000h | R/W |
| 3304-3307h | SBEMC4 | Schedule Break Event C4 | 00000000h | R/W |
| 3310-3313h (Corporate Only) | PRSTS | Power and Reset Status | | |
| 3400-3403h | RC | RTC Configuration | 00000000h | R/W, R/WLO |
| 3404-3407h | HPTC | High Precision Timer Configuration | 00000000h | R/W |
| 3410-3413h | GCS | General Control and Status | 000000yy0h | R/W, R/WLO |
| 3414-3414h | BUC | Backed Up Control | 00h | R/W |
| 3418-341Bh | FD | Function Disable | 00000000h | R/W |
| 341C-341Fh | CG | Clock Gating | 00000000h | R/W |
| 3420-3420h | PDSW | Function Disable SUS Well | 00h | R/W |
| 3430-3433h | CIR8 | Chipset Initialization Register 8 | 00000000h | R/W |



Table 10-1. Chipset Configuration Register Memory Map (Memory Space) (Sheet 4 of 4)

| Offset | Mnemonic | Register Name | Default | Type |
|------------|----------|------------------------------------|------------|------|
| 350C-350Fh | CIR9 | Chipset Initialization Register 9 | 00000000h | R/W |
| 3524-3525h | PPO | USB Port Power Off | 0000h | R/W |
| 352C-352Fh | CIR10 | Chipset Initialization Register 10 | 0008C008hh | R/W |
| 35F0-35F3h | MAP | USB Remap Control | 00000000h | R/WO |

10.1.1 VCH—Virtual Channel Capability Header Register

Offset Address: 0000-0003h Attribute: R/WO
 Default Value: 10010002h Size: 32-bit

| Bit | Description |
|-------|-----------------------------------------------------------------------------------------------|
| 31:20 | Next Capability Offset (NCO) — R/WO. Indicates the next item in the list. |
| 19:16 | Capability Version (CV) — R/WO. Indicates support as a version 1 capability structure. |
| 15:0 | Capability ID (CID) — R/WO. Indicates this is the Virtual Channel capability item. |

10.1.2 VCAP1—Virtual Channel Capability #1 Register

Offset Address: 0004-0007h Attribute: RO, R/WO
 Default Value: 00000801h Size: 32-bit

| Bit | Description |
|-------|--------------------------------------------------------------------------------------------------------------------------------------------|
| 31:12 | Reserved |
| 11:10 | Port Arbitration Table Entry Size (PATS) — RO. Indicates the size of the port arbitration table is 4 bits (to allow up to 8 ports). |
| 9:8 | Reference Clock (RC) — RO. Fixed at 100 ns. |
| 7 | Reserved |
| 6:4 | Low Priority Extended VC Count (LPEVC) — RO. Indicates that there are no additional VCs of low priority with extended capabilities. |
| 3 | Reserved |
| 2:0 | Extended VC Count (EVC) — R/WO. Indicates that there is one additional VC (VC1) that exists with extended capabilities. |

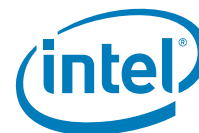

10.1.3 VCAP2—Virtual Channel Capability #2 Register

Offset Address: 0008–000Bh Attribute: RO
 Default Value: 00000001h Size: 32-bit

| Bit | Description |
|-------|-------------------------------------------------------------------------------------------------------------------------|
| 31:24 | VC Arbitration Table Offset (ATO) — RO. Indicates that no table is present for VC arbitration since it is fixed. |
| 23:8 | Reserved |
| 7:0 | VC Arbitration Capability (AC) — RO. Indicates that the VC arbitration is fixed in the root complex. |

10.1.4 PVC—Port Virtual Channel Control Register

Offset Address: 000C–000Dh Attribute: RO, R/W
 Default Value: 0000h Size: 16-bit

| Bit | Description |
|-------|------------------------------------------------------------------------------------------------------------------------------------------------------------------------------------------------------------------|
| 15:04 | Reserved |
| 3:1 | VC Arbitration Select (AS) — R/W. Indicates which VC should be programmed in the VC arbitration table. The root complex takes no action on the setting of this field since there is no arbitration table. |
| 0 | Load VC Arbitration Table (LAT) — RO. Indicates that the table programmed should be loaded into the VC arbitration table. This bit is defined as read/write with always returning 0 on reads. |

10.1.5 PVS—Port Virtual Channel Status Register

Offset Address: 000E–000Fh Attribute: RO
 Default Value: 0000h Size: 16-bit

| Bit | Description |
|------|------------------------------------------------------------------------------------------------------------------------------------------------------------------------------------------------------------------------|
| 15:1 | Reserved |
| 0 | VC Arbitration Table Status (VAS) — RO. Indicates the coherency status of the VC Arbitration table when it is being updated. This field is always 0 in the root complex since there is no VC arbitration table. |

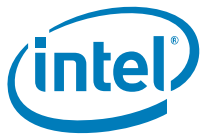

10.1.6 VOCAP—Virtual Channel 0 Resource Capability Register

Offset Address: 0010–0013h Attribute: RO
 Default Value: 00000001h Size: 32-bit

| Bit | Description |
|-------|---------------------------------------------------------------------------------------------------------------------------------------|
| 31:24 | Port Arbitration Table Offset (AT) — RO. This VC implements no port arbitration table since the arbitration is fixed. |
| 23 | Reserved |
| 22:16 | Maximum Time Slots (MTS) — RO. This VC implements fixed arbitration, and therefore this field is not used. |
| 15 | Reject Snoop Transactions (RTS) — RO. This VC must be able to take snoopable transactions. |
| 14 | Advanced Packet Switching (APS) — RO. This VC is capable of all transactions, not just advanced packet switching transactions. |
| 13:8 | Reserved |
| 7:0 | Port Arbitration Capability (PAC) — RO. Indicates that this VC uses fixed port arbitration. |

10.1.7 VOCTL—Virtual Channel 0 Resource Control Register

Offset Address: 0014–0017h Attribute: R/W, RO
 Default Value: 800000FFh Size: 32-bit

| Bit | Description |
|-------|-----------------------------------------------------------------------------------------------------------------------------------------------------------------------------------------------------------------|
| 31 | Virtual Channel Enable (EN) — RO. Always set to 1. VCO is always enabled and cannot be disabled. |
| 30:27 | Reserved |
| 26:24 | Virtual Channel Identifier (ID) — RO. Indicates the ID to use for this virtual channel. |
| 23:20 | Reserved |
| 19:17 | Port Arbitration Select (PAS) — R/W. Indicates which port table is being programmed. The root complex takes no action on this setting since the arbitration is fixed and there is no arbitration table. |
| 16 | Load Port Arbitration Table (LAT) — RO. The root complex does not implement an arbitration table for this virtual channel. |
| 15:8 | Reserved |
| 7:1 | Transaction Class / Virtual Channel Map (TVM) — R/W. Indicates which transaction classes are mapped to this virtual channel. When a bit is set, this transaction class is mapped to the virtual channel. |
| 0 | Reserved |



10.1.8 VOSTS—Virtual Channel 0 Resource Status Register

Offset Address: 001A–001Bh Attribute: RO
 Default Value: 0000h Size: 16-bit

| Bit | Description |
|------|---------------------------------------------------------------------------------------------------------------------------------|
| 15:2 | Reserved |
| 1 | VC Negotiation Pending (NP) — RO. When set, indicates the virtual channel is still being negotiated with ingress ports. |
| 0 | Port Arbitration Tables Status (ATS) — RO. There is no port arbitration table for this VC, so this bit is reserved at 0. |

10.1.9 V1CAP—Virtual Channel 1 Resource Capability Register

Offset Address: 001C–001Fh Attribute: R/WO, RO
 Default Value: 03008011h (Consumer) Size: 32-bit
 00008001h (Corporate)

| Bit | Description |
|---------------------------|-------------------------------------------------------------------------------------------------------------------------------------------------------------------------------|
| 31:24 (Corporate Only) | Port Arbitration Table Offset (AT) — RO. Indicates the location of the port arbitration table in the root complex. A value of 0h indicates the table is not present |
| 31:24 (Consumer Only) | Port Arbitration Table Offset (AT) — RO. Indicates the location of the port arbitration table in the root complex. A value of 3h indicates the table is at offset 30h. |
| 23 | Reserved |
| 22:16 | Maximum Time Slots (MTS) — R/WO. This value is updated by platform BIOS based upon the determination of the number of time slots available in the platform. |
| 15 | Reject Snoop Transactions (RTS) — RO. All snoopable transactions on VC1 are rejected. This VC is for isochronous transfers only. |
| 14 | Advanced Packet Switching (APS) — RO. This VC is capable of all transactions, not just advanced packet switching transactions. |
| 13:8 | Reserved |
| 7:0 (Corporate Only) | Port Arbitration Capability (PAC) — RO. Indicates the port arbitration capability is hardware-fixed. |
| 7:0 (Consumer Only) | Port Arbitration Capability (PAC) — RO. Indicates the port arbitration capability is time-based WRR of 128 phases. |

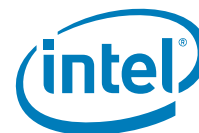

10.1.12 PAT—Port Arbitration Table (Consumer Only)

Offset Address: 0030-006Fh Attribute:
 Default Value: Size: 64-Byte

This a 64-byte register that contains the arbitration table to be loaded into the port arbitration table. Every 4-bits contains an entry for one of the downstream PCI Express* ports or a 0h to indicate idle. The ports are mapped as follows:

- Port 1: Value used is 1h.
- Port 2: Value used is 2h.
- Port 3: Value used is 3h.
- Port 4: Value used is 4h.
- Port 5: Value used is 5h.
- Port 6: Value used is 6h.
- Intel High Definition Audio: Value used is Fh.

10.1.13 CIR1—Chipset Initialization Register 1

Offset Address: 0088–008Bh Attribute: R/WO
 Default Value: 00000000h Size: 32-bit

| Bit | Description |
|-------|-----------------------------------------------------|
| 31:21 | Reserved |
| 20 | CIR1 Field 3 — R/WO. BIOS must set this bit. |
| 19:16 | Reserved |
| 15 | CIR1 Field 2 — R/WO. BIOS must set this bit. |
| 14:13 | Reserved |
| 12 | CIR1 Field 1 — R/WO. BIOS must set this bit. |
| 11:0 | Reserved |

10.1.14 REC—Root Error Command Register

Offset Address: 00AC–00AFh Attribute: R/W
 Default Value: 0000h Size: 32-bit

| Bit | Description |
|------|-----------------------------------------------------------------------------------------------------------------------------------------------------------------------------------------------------------------------------------------------------------------------------------------------------------------------------------------------------------------------------------------------------------------------------------------------------------------------------------------------------------------------------------|
| 31 | Drop Poisoned Downstream Packets (DPDP) — R/W. Determines how downstream packets on DMI are handled that are received with the EP field set, indicating poisoned data: 1: This packet and all subsequent packets with data received on DMI for any VC will have their Unsupported Transaction (UT) field set causing them to master Abort downstream. Packets without data such as memory, IO and config read requests are allowed to proceed. 0: Packets are forwarded downstream without forcing the UT field set. |
| 30:0 | Reserved |



10.1.15 RCTCL—Root Complex Topology Capabilities List Register

Offset Address: 0100–0103h Attribute: RO
 Default Value: 1A010005h Size: 32-bit

| Bit | Description |
|-------|-------------------------------------------------------------------------------------------------------|
| 31:20 | Next Capability (NEXT) — RO. Indicates the next item in the list. |
| 19:16 | Capability Version (CV) — RO. Indicates the version of the capability structure. |
| 15:0 | Capability ID (CID) — RO. Indicates this is a PCI Express* link capability section of an RCRB. |

10.1.16 ESD—Element Self Description Register

Offset Address: 0104–0107h Attribute: R/WO, RO
 Default Value: 00000802h Size: 32-bit

| Bit | Description |
|-------|------------------------------------------------------------------------------------------------------------------------------------------------------------------------------------------------------------------------|
| 31:24 | Port Number (PN) — RO. A value of 0 to indicate the egress port for the Intel ICH10. |
| 23:16 | Component ID (CID) — R/WO. Indicates the component ID assigned to this element by software. This is written once by platform BIOS and is locked until a platform reset. |
| 15:8 | Number of Link Entries (NLE) — RO. Indicates that one link entry (corresponding to DMI), 6 root port entries (for the downstream ports), and the Intel High Definition Audio device are described by this RCRB. |
| 7:4 | Reserved |
| 3:0 | Element Type (ET) — RO. Indicates that the element type is a root complex internal link. |

10.1.17 ULD—Upstream Link Descriptor Register

Offset Address: 0110–0113h Attribute: R/WO, RO
 Default Value: 00000001h Size: 32-bit

| Bit | Description |
|-------|-----------------------------------------------------------------------------------------------------------------------------------------------------------------|
| 31:24 | Target Port Number (PN) — R/WO. This field is programmed by platform BIOS to match the port number of the (G)MCH RCRB that is attached to this RCRB. |
| 23:16 | Target Component ID (TCID) — R/WO. This field is programmed by platform BIOS to match the component ID of the (G)MCH RCRB that is attached to this RCRB. |
| 15:2 | Reserved |
| 1 | Link Type (LT) — RO. Indicates that the link points to the (G)MCH RCRB. |
| 0 | Link Valid (LV) — RO. Indicates that the link entry is valid. |



10.1.18 ULBA—Upstream Link Base Address Register

Offset Address: 0118–011Fh Attribute: R/WO
 Default Value: 0000000000000000h Size: 64-bit

| Bit | Description |
|-------|--------------------------------------------------------------------------------------------------------------------------------------------------------------------------------|
| 63:32 | Base Address Upper (BAU) — R/WO. This field is programmed by platform BIOS to match the upper 32-bits of base address of the (G)MCH RCRB that is attached to this RCRB. |
| 31:0 | Base Address Lower (BAL) — R/WO. This field is programmed by platform BIOS to match the lower 32-bits of base address of the (G)MCH RCRB that is attached to this RCRB. |

10.1.19 RP1D—Root Port 1 Descriptor Register

Offset Address: 0120–0123h Attribute: R/WO, RO
 Default Value: 01xx0002h Size: 32-bit

| Bit | Description |
|-------|---------------------------------------------------------------------------------------------------------------------------------------------------------------------------------------------------------------|
| 31:24 | Target Port Number (PN) — RO. Indicates the target port number is 1h (root port #1). |
| 23:16 | Target Component ID (TCID) — R/WO. This field returns the value of the ESD.CID (offset 0104h, bits 23:16) field programmed by platform BIOS, since the root port is in the same component as the RCRB. |
| 15:2 | Reserved |
| 1 | Link Type (LT) — RO. Indicates that the link points to a root port. |
| 0 | Link Valid (LV) — RO. When FD.PE1D (offset 3418h, bit 16) is set, this link is not valid (returns 0). When FD.PE1D is cleared, this link is valid (returns 1). |

10.1.20 RP1BA—Root Port 1 Base Address Register

Offset Address: 0128–012Fh Attribute: RO
 Default Value: 000000000000E0000h Size: 64-bit

| Bit | Description |
|-------|------------------------------------------------------------------------------|
| 63:28 | Reserved |
| 27:20 | Bus Number (BN) — RO. Indicates the root port captured bus number. |
| 19:15 | Device Number (DN) — RO. Indicates the root port is on device #28. |
| 14:12 | Function Number (FN) — RO. Indicates the root port is on function #0. |
| 11:0 | Reserved |



10.1.21 RP2D—Root Port 2 Descriptor Register

Offset Address: 0130–0133h Attribute: R/WO, RO
 Default Value: 02xx0002h Size: 32-bit

| Bit | Description |
|-------|---------------------------------------------------------------------------------------------------------------------------------------------------------------------------------------------------------------------------------------------------------------------------------------|
| 31:24 | Target Port Number (PN) — RO. Indicates the target port number is 2h (root port #2). |
| 23:16 | Target Component ID (TCID) — R/WO. This field returns the value of the ESD.CID (offset 0104h, bits 23:16) field programmed by platform BIOS, since the root port is in the same component as the RCRB. |
| 15:2 | Reserved |
| 1 | Link Type (LT) — RO. Indicates that the link points to a root port. |
| 0 | Link Valid (LV) — RO. When RPC.PC (offset 0224h, bits 1:0) is '01', '10', or '11', or FD.PE2D (offset 3418h, bit 17) is set, the link for this root port is not valid (return 0). When RPC.PC is '00' and FD.PE2D is cleared, the link for this root port is valid (return 1). |

10.1.22 RP2BA—Root Port 2 Base Address Register

Offset Address: 0138–013Fh Attribute: RO
 Default Value: 00000000000E1000h Size: 64-bit

| Bit | Description |
|-------|------------------------------------------------------------------------------|
| 63:28 | Reserved |
| 27:20 | Bus Number (BN) — RO. Indicates the root port captured bus number. |
| 19:15 | Device Number (DN) — RO. Indicates the root port is on device #28. |
| 14:12 | Function Number (FN) — RO. Indicates the root port is on function #1. |
| 11:0 | Reserved |

10.1.23 RP3D—Root Port 3 Descriptor Register

Offset Address: 0140–0143h Attribute: R/WO, RO
 Default Value: 03xx0002h Size: 32-bit

| Bit | Description |
|-------|----------------------------------------------------------------------------------------------------------------------------------------------------------------------------------------------------------------------------------------------------------------------------------------|
| 31:24 | Target Port Number (PN) — RO. Indicates the target port number is 3h (root port #3). |
| 23:16 | Target Component ID (TCID) — R/WO. This field returns the value of the ESD.CID (offset 0104h, bits 23:16) field programmed by platform BIOS, since the root port is in the same component as the RCRB. |
| 15:2 | Reserved |
| 1 | Link Type (LT) — RO. Indicates that the link points to a root port. |
| 0 | Link Valid (LV) — RO. When RPC.PC (offset 0224h, bits 1:0) is '11', or FD.PE3D (offset 3418h, bit 18) is set, the link for this root port is not valid (return 0). When RPC.PC is '00', '01', or '10', and FD.PE3D is cleared, the link for this root port is valid (return 1). |



10.1.24 RP3BA—Root Port 3 Base Address Register

Offset Address: 0148–014Fh Attribute: RO
 Default Value: 00000000000E2000h Size: 64-bit

| Bit | Description |
|-------|------------------------------------------------------------------------------|
| 63:28 | Reserved |
| 27:20 | Bus Number (BN) — RO. Indicates the root port captured bus number. |
| 19:15 | Device Number (DN) — RO. Indicates the root port is on device #28. |
| 14:12 | Function Number (FN) — RO. Indicates the root port is on function #2. |
| 11:0 | Reserved |

10.1.25 RP4D—Root Port 4 Descriptor Register

Offset Address: 0150–0153h Attribute: R/WO, RO
 Default Value: 04xx0002h Size: 32-bit

| Bit | Description |
|-------|----------------------------------------------------------------------------------------------------------------------------------------------------------------------------------------------------------------------------------------------------------------------------------------|
| 31:24 | Target Port Number (PN) — RO. Indicates the target port number is 4h (root port #4). |
| 23:16 | Target Component ID (TCID) — R/WO. This field returns the value of the ESD.CID (offset 0104h, bits 23:16) field programmed by platform BIOS, since the root port is in the same component as the RCRB. |
| 15:2 | Reserved |
| 1 | Link Type (LT) — RO. Indicates that the link points to a root port. |
| 0 | Link Valid (LV) — RO. When RPC.PC (offset 0224h, bits 1:0) is '10' or '11', or FD.PE4D (offset 3418h, bit 19) is set, the link for this root port is not valid (return 0). When RPC.PC is '00' or '01' and FD.PE4D is cleared, the link for this root port is valid (return 1). |

10.1.26 RP4BA—Root Port 4 Base Address Register

Offset Address: 0158–015Fh Attribute: RO
 Default Value: 00000000000E3000h Size: 64-bit

| Bit | Description |
|-------|------------------------------------------------------------------------------|
| 63:28 | Reserved |
| 27:20 | Bus Number (BN) — RO. Indicates the root port captured bus number. |
| 19:15 | Device Number (DN) — RO. Indicates the root port is on device #28. |
| 14:12 | Function Number (FN) — RO. Indicates the root port is on function #3. |
| 11:0 | Reserved |

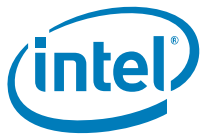

10.1.27 HDD—Intel® High Definition Audio Descriptor Register

Offset Address: 0160–0163h Attribute: R/WO, RO
 Default Value: 0Fxx0002h Size: 32-bit

| Bit | Description |
|-------|----------------------------------------------------------------------------------------------------------------------------------------------------------------------------------------------------------------------------|
| 31:24 | Target Port Number (PN) — RO. Indicates the target port number is 15h (Intel High Definition Audio). |
| 23:16 | Target Component ID (TCID) — R/WO. This field returns the value of the ESD.CID (offset 0104h, bits 23:16) field programmed by platform BIOS, since the root port is in the same component as the RCRB. |
| 15:2 | Reserved |
| 1 | Link Type (LT) — RO. Indicates that the link points to a root port. |
| 0 | Link Valid (LV) — RO. When FD.ZD (offset 3418h, bit 4) is set, the link to Intel High Definition Audio is not valid (return 0). When FD.ZD is cleared, the link to Intel High Definition Audio is valid (return 1). |

10.1.28 HDBA—Intel® High Definition Audio Base Address Register

Offset Address: 0168–016Fh Attribute: RO
 Default Value: 0000000000D8000h Size: 64-bit

| Bit | Description |
|-------|---------------------------------------------------------------------------------------|
| 63:28 | Reserved |
| 27:20 | Bus Number (BN) — RO. Indicates the High Definition Audio captured bus number. |
| 19:15 | Device Number (DN) — RO. Indicates the root port is on device #27. |
| 14:12 | Function Number (FN) — RO. Indicates the root port is on function #0. |
| 11:0 | Reserved |

10.1.29 RP5D—Root Port 5 Descriptor Register

Offset Address: 0170–0173h Attribute: R/WO, RO
 Default Value: 05xx0002h Size: 32-bit

| Bit | Description |
|-------|---------------------------------------------------------------------------------------------------------------------------------------------------------------------------------------------------------------|
| 31:24 | Target Port Number (PN) — RO. Indicates the target port number is 5h (root port #5). |
| 23:16 | Target Component ID (TCID) — R/WO. This field returns the value of the ESD.CID (offset 0104h, bits 23:16) field programmed by platform BIOS, since the root port is in the same component as the RCRB. |
| 15:2 | Reserved |
| 1 | Link Type (LT) — RO. Indicates that the link points to a root port. |
| 0 | Link Valid (LV) — RO. When FD.PE5D (offset 3418h, bit 20) is set, the link for this root port is not valid (return 0). When FD.PE5D is cleared, the link for this root port is valid (return 1). |



10.1.30 RP5BA—Root Port 5 Base Address Register

Offset Address: 0178–017Fh Attribute: RO
 Default Value: 00000000000E4000h Size: 64-bit

| Bit | Description |
|-------|------------------------------------------------------------------------------|
| 63:28 | Reserved |
| 27:20 | Bus Number (BN) — RO. Indicates the root port captured bus number. |
| 19:15 | Device Number (DN) — RO. Indicates the root port is on device #28. |
| 14:12 | Function Number (FN) — RO. Indicates the root port is on function #4. |
| 11:0 | Reserved |

10.1.31 RP6D—Root Port 6 Descriptor Register

Offset Address: 0180–0183h Attribute: R/WO, RO
 Default Value: 06xx0002h Size: 32-bit

| Bit | Description |
|-------|------------------------------------------------------------------------------------------------------------------------------------------------------------------------------------------------------------------------------------------------------------------------|
| 31:24 | Target Port Number (PN) — RO. Indicates the target port number is 6h (root port #6). |
| 23:16 | Target Component ID (TCID) — R/WO. This field returns the value of the ESD.CID (offset 0104h, bits 23:16) field programmed by platform BIOS, since the root port is in the same component as the RCRB. |
| 15:2 | Reserved |
| 1 | Link Type (LT) — RO. Indicates that the link points to a root port. |
| 0 | Link Valid (LV) — RO. When RPC.PC2 (offset 0224h, bits 1:0) is '01' or FD.PE6D (offset 3418h, bit 21) is set, the link for this root port is not valid (return 0). When RPC.PC is '00' and FD.PE6D is cleared, the link for this root port is valid (return 1). |

10.1.32 RP6BA—Root Port 6 Base Address Register

Offset Address: 0188–018Fh Attribute: RO
 Default Value: 00000000000E5000h Size: 64-bit

| Bit | Description |
|-------|------------------------------------------------------------------------------|
| 63:28 | Reserved |
| 27:20 | Bus Number (BN) — RO. Indicates the root port captured bus number. |
| 19:15 | Device Number (DN) — RO. Indicates the root port is on device #28. |
| 14:12 | Function Number (FN) — RO. Indicates the root port is on function #5. |
| 11:0 | Reserved |

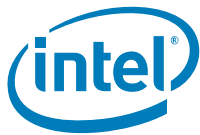

10.1.33 ILCL—Internal Link Capabilities List Register

Offset Address: 01A0–01A3h Attribute: RO
 Default Value: 00010006h Size: 32-bit

| Bit | Description |
|-------|-----------------------------------------------------------------------------------------|
| 31:20 | Next Capability Offset (NEXT) — RO. Indicates this is the last item in the list. |
| 19:16 | Capability Version (CV) — RO. Indicates the version of the capability structure. |
| 15:0 | Capability ID (CID) — RO. Indicates this is capability for DMI. |

10.1.34 LCAP—Link Capabilities Register

Offset Address: 01A4–01A7h Attribute: R/WO, RO
 Default Value: 00012841h Size: 32-bit

| Bit | Description |
|-------|-------------------------------------------------------------------------------------------------------------|
| 31:18 | Reserved |
| 17:15 | Reserved |
| 14:12 | L0s Exit Latency (ELO) — R/WO. This field indicates that exit latency is 128 ns to less than 256 ns. |
| 11:10 | Active State Link PM Support (APMS) — R/WO. Indicates that L0s and L1 are supported on DMI. |
| 9:4 | Maximum Link Width (MLW) — RO. Indicates the maximum link width is 4 ports. |
| 3:0 | Maximum Link Speed (MLS) — RO. Indicates the link speed is 2.5 Gb/s. |

10.1.35 LCTL—Link Control Register

Offset Address: 01A8–01A9h Attribute: R/W
 Default Value: 0000h Size: 16-bit

| Bit | Description |
|------|--------------------------------------------------------------------------------------------------------------------------------------------------------------------------------------------------------------------------------------------------------------------------------------------------------------------------------|
| 15:8 | Reserved |
| 7 | Extended Synch (ES) — R/W. When set, forces extended transmission of FTS ordered sets when exiting L0s prior to entering L0. |
| 6:2 | Reserved |
| 1:0 | Active State Link PM Control (ASPM) — R/W. Indicates whether DMI should enter L0s. 00 = Disabled 01 = L0s entry enabled 10 = Reserved 11 = Reserved Corporate Only: The value of this register is used unless the DMI ASPM Override Enable register is set, in which case the DMI ASPM Override is used. |



10.1.36 LSTS—Link Status Register

Offset Address: 01AA–01ABh Attribute: RO
 Default Value: 0041h Size: 16-bit

| Bit | Description |
|-------|---------------------------------------------------------------------------------|
| 15:10 | Reserved |
| 9:4 | Negotiated Link Width (NLW) — RO. Negotiated link width is x4 (000100b). |
| 3:0 | Link Speed (LS) — RO. Link is 2.5 Gb/s. |

10.1.37 CIR2 — Chipset Initialization Register 2

Offset Address: 01F4–01F7h Attribute: R/W
 Default Value: 00000000h Size: 32-bit

| Bit | Description |
|------|------------------------------------------------------------|
| 31:0 | CIR2 Field 1 — R/W. BIOS shall program to 86000040h |

10.1.38 CIR3 — Chipset Initialization Register 3

Offset Address: 01FC–01FDh Attribute: R/W
 Default Value: 0000h Size: 16-bit

| Bit | Description |
|-------|------------------------------------------------------------------|
| 15:11 | Reserved |
| 10:8 | CIR3 Field 3 — R/W. BIOS must program this field to 110b. |
| 7:4 | Reserved |
| 3 | CIR3 Field 2 — R/W. BIOS must set this bit. |
| 2 | Reserved |
| 1:0 | CIR3 Field 1 — R/W. BIOS must program this field to 11b. |

10.1.39 BCR — Backbone Configuration Register

Offset Address: 0220–0223h Attribute: R/W
 Default Value: 00000000h Size: 32-bit

| Bit | Description |
|------|-----------------------------------------------------------|
| 31:7 | Reserved |
| 6 | BCR Field 2 — R/W. BIOS must set this bit. |
| 5:3 | Reserved |
| 2:0 | BCR Field 1 — R/W. BIOS program this field to 101b |



10.1.40 RPC—Root Port Configuration Register

Offset Address: 0224–0227h Attribute: R/W, RO
 Default Value: 0000000yh (y = 00xxb) Size: 32-bit

| Bit | Description |
|------|-------------------------------------------------------------------------------------------------------------------------------------------------------------------------------------------------------------------------------------------------------------------------------------------------------------------------------------------------------------------------------------------------------------------------------------------------------------------------------------------------------------------------------------------------------------------------------------------------------------------------------------------------------------------------------|
| 31:8 | Reserved |
| 7 | High Priority Port Enable (HPE) — R/W. 0 = The high priority path is not enabled. 1 = The port selected by the HPP field in this register is enabled for high priority. It will be arbitrated above all other VCO (including integrated VCO) devices. |
| 6:4 | High Priority Port (HPP) — R/W. This controls which port is enabled for high priority when the HPE bit in this register is set. 111 = Reserved 110 = Reserved 101 = Port 6 100 = Port 5 011 = Port 4 010 = Port 3 001 = Port 2 000 = Port 1 |
| 3 | Reserved |
| 2 | Port Configuration2 (PC2) — RO. This controls how the PCI bridges are organized in various modes of operation for Ports 5 and 6. Corporate only: This bit is set by the PCIEPCS2[1:0] soft strap. 1 = Reserved 0 = 2 x1s, Port 5 (x1), Port 6 (x1) This bit is in the resume well and is only reset by RSMRST#. |
| 1:0 | Port Configuration (PC) — RO. This controls how the PCI bridges are organized in various modes of operation for Ports 1-4. For the following mappings, if a port is not shown, it is considered a x1 port with no connection. Consumer Only: These bits represent the strap values of HDA_SDOOUT (bit 1) and HDA_SYNC (bit 0) when TP[3] is not pulled low at the rising edge of PWROK. Corporate Only: These bits are set by the PCIEPCS1[1:0] soft strap. 11 = 1 x4, Port 1 (x4) 10 = Reserved 01 = Reserved 00 = 4 x1s, Port 1 (x1), Port 2 (x1), Port 3 (x1) and Port 4 (x1) These bits are in the resume well and are only reset by RSMRST#. |



10.1.41 DMIC—DMI Control Register

Offset Address: 0234–0237h Attribute: R/W
 Default Value: 00000000h Size: 32-bit

| Bit | Description |
|------------------------------|----------------------------------------------------------------------------------------------------------------------------------------------------------------------------------------------------------------------------------------------------------------------------------------------------|
| 31:19 | Reserved |
| 18 Corporate Only | ASPM Control Override Enable (ASPMCOEN) — RW. 1 = DMI will use the values in the ASPM Control Override registers 0 = DMI will use the ASPM Registers in the Link Control register. NOTES: This register allows BIOS to control the DMI ASPM settings instead of the OS. |
| 18 (Consumer Only) | Reserved |
| 17:16 (Corporate Only) | ASPM Control Override (ASPMO) — RW. Provides BIOS control of whether DMI should enter L0s or L1 or both. 00 = Disabled 01 = L0s Entry Enabled 10 = L1 Entry Enabled 11 = L0s and L1 Entry Enabled. |
| 17:16 (Consumer Only) | Reserved |
| 15:2 | Reserved |
| 1:0 | DMI Clock Gate Enable (DMICGEN) — R/W. BIOS must program this field to 11b. |

10.1.42 RPFN—Root Port Function Number and Hide for PCI Express* Root Ports

Offset Address: 0238–023Ch Attribute: R/WO, RO
 Default Value: 00543210h Size: 32-bit

For the PCI Express root ports, the assignment of a function number to a root port is not fixed. BIOS may re-assign the function numbers on a port by port basis. This capability will allow BIOS to disable/hide any root port and still have functions 0 thru N-1 where N is the total number of enabled root ports.

Port numbers will remain fixed to a physical root port.

The existing root port Function Disable registers operate on physical ports (not functions).

Port Configuration (1x4, 4x1, etc.) is not affected by the logical function number assignment and is associated with physical ports.

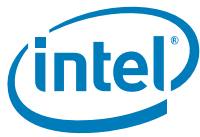

| Bit | Description |
|-------|----------------------------------------------------------------------------------------------------------------------------------------------------------------------------------------------------------------------------------------|
| 31:24 | Reserved |
| 23 | Root Port 6 Config Hide (RP6CH) — RW. This bit is used to hide the root port and any devices behind it from being discovered by the OS. When set to '1' the root port will not claim any downstream configuration transactions. |
| 22:20 | Root Port 6 Function Number (RP6FN) — R/WO. These bits set the function number for PCI Express Root Port 6. This root port function number must be a unique value from the other root port function numbers |
| 19 | Root Port 5 Config Hide (RP5CH) — RW. This bit is used to hide the root port and any devices behind it from being discovered by the OS. When set to '1' the root port will not claim any downstream configuration transactions. |
| 18:16 | Root Port 5 Function Number (RP5FN) — R/WO. These bits set the function number for PCI Express Root Port 5. This root port function number must be a unique value from the other root port function numbers |
| 15 | Root Port 4 Config Hide (RP4CH) — RW. This bit is used to hide the root port and any devices behind it from being discovered by the OS. When set to '1' the root port will not claim any downstream configuration transactions. |
| 14:12 | Root Port 4 Function Number (RP4FN) — R/WO. These bits set the function number for PCI Express Root Port 4. This root port function number must be a unique value from the other root port function numbers |
| 11 | Root Port 3 Config Hide (RP3CH) — RW. This bit is used to hide the root port and any devices behind it from being discovered by the OS. When set to '1' the root port will not claim any downstream configuration transactions. |
| 10:8 | Root Port 3 Function Number (RP3FN) — R/WO. These bits set the function number for PCI Express Root Port 3. This root port function number must be a unique value from the other root port function numbers |
| 7 | Root Port 2 Config Hide (RP2CH) — RW. This bit is used to hide the root port and any devices behind it from being discovered by the OS. When set to '1' the root port will not claim any downstream configuration transactions. |
| 6:4 | Root Port 2 Function Number (RP2FN) — R/WO. These bits set the function number for PCI Express Root Port 2. This root port function number must be a unique value from the other root port function numbers |
| 3 | Root Port 1 Config Hide (RP1CH) — RW. This bit is used to hide the root port and any devices behind it from being discovered by the OS. When set to '1' the root port will not claim any downstream configuration transactions. |
| 2:0 | Root Port 1 Function Number (RP1FN) — R/WO. These bits set the function number for PCI Express Root Port 1. This root port function number must be a unique value from the other root port function numbers |



10.1.43 FLRSTAT—FLR Pending Status Register

Offset Address: 0290–0293h
 Default Value: 00000000h

Attribute: RO
 Size: 32-bit

| Bit | Description |
|-------|-----------------------------------------------------------------------------------------------------------------------------------------|
| 31:24 | Reserved. |
| 23 | FLR Pending Status for D29:F7, EHCI #1 — RO. 0 = Function Level Reset is not pending. 1 = Function Level Reset is pending. |
| 22:20 | Reserved. |
| 19 | FLR Pending Status for D29:F3, UHCI #6 — RO. 0 = Function Level Reset is not pending. 1 = Function Level Reset is pending. |
| 18 | FLR Pending Status for D29:F2, UHCI #3 — RO. 0 = Function Level Reset is not pending. 1 = Function Level Reset is pending. |
| 17 | FLR Pending Status for D29:F1, UHCI #2 — RO. 0 = Function Level Reset is not pending. 1 = Function Level Reset is pending. |
| 16 | FLR Pending Status for D29:F0, UHCI #1 — RO. 0 = Function Level Reset is not pending. 1 = Function Level Reset is pending. |
| 15 | FLR Pending Status for D26:F7, EHCI #2 — RO. 0 = Function Level Reset is not pending. 1 = Function Level Reset is pending. |
| 14:11 | Reserved. |
| 10 | FLR Pending Status for D26:F2, UHCI #6 — RO. 0 = Function Level Reset is not pending. 1 = Function Level Reset is pending. |
| 9 | FLR Pending Status for D26:F1, UHCI #5 — RO. 0 = Function Level Reset is not pending. 1 = Function Level Reset is pending. |
| 8 | FLR Pending Status for D26:F0, UHCI #4 — RO. 0 = Function Level Reset is not pending. 1 = Function Level Reset is pending. |
| 7:0 | Reserved. |



10.1.44 CIR13—Chipset Initialization Register 13

Offset Address: 0F20h–0F23h Attribute: R/W
Default Value: B2B477CCh Size: 32-bit

| Bit | Description |
|-------|--------------------------------------------------------------------|
| 31:20 | Reserved |
| 19:16 | CIR13 Field 1 — R/W. BIOS must program this field to 0101b. |
| 15:0 | Reserved |

10.1.45 CIR5—Chipset Initialization Register 5

Offset Address: 1D40h–1D47h Attribute: R/W
Default Value: 0000000000000000h Size: 64-bit

| Bit | Description |
|------|----------------------------------------------------------------|
| 63:1 | Reserved |
| 0 | CIR5 Field 1 — R/W. BIOS must program this field to 1b. |

10.1.46 TRSR—Trap Status Register

Offset Address: 1E00–1E03h Attribute: R/WC, RO
Default Value: 00000000h Size: 32-bit

| Bit | Description |
|------|------------------------------------------------------------------------------------------------------------------------------------------------------------------------------------------------------------------------------------------------------------------------------------------------------------------------------------------------------------------------------------------------------------------------------------------------------------------------------------------------------------------------------------------------------------------------------------------------------------------------------------------------|
| 31:4 | Reserved |
| 3:0 | Cycle Trap SMI# Status (CTSS) — R/WC. These bits are set by hardware when the corresponding Cycle Trap register is enabled and a matching cycle is received (and trapped). These bits are OR'ed together to create a single status bit in the Power Management register space. Note that the SMI# and trapping must be enabled in order to set these bits. These bits are set before the completion is generated for the trapped cycle, thereby ensuring that the processor can enter the SMI# handler when the instruction completes. Each status bit is cleared by writing a 1 to the corresponding bit location in this register. |



10.1.47 TRCR—Trapped Cycle Register

Offset Address: 1E10–1E17h Attribute: RO
 Default Value: 0000000000000000h Size: 64-bit

This register saves information about the I/O Cycle that was trapped and generated the SMI# for software to read.

| Bit | Description |
|-------|---------------------------------------------------------------------------------------------------------------------------------------------------------------------------------------------------------------|
| 63:25 | Reserved |
| 24 | Read/Write# (RWI) — RO. 0 = Trapped cycle was a write cycle. 1 = Trapped cycle was a read cycle. |
| 23:20 | Reserved |
| 19:16 | Active-high Byte Enables (AHBE) — RO. This is the dword-aligned byte enables associated with the trapped cycle. A 1 in any bit location indicates that the corresponding byte is enabled in the cycle. |
| 15:2 | Trapped I/O Address (TIOA) — RO. This is the dword-aligned address of the trapped cycle. |
| 1:0 | Reserved |

10.1.48 TWDR—Trapped Write Data Register

Offset Address: 1E18–1E1Fh Attribute: RO
 Default Value: 0000000000000000h Size: 64-bit

This register saves the data from I/O write cycles that are trapped for software to read.

| Bit | Description |
|-------|--------------------------------------------------------------------------------------------------------------------|
| 63:32 | Reserved |
| 31:0 | Trapped I/O Data (TIOD) — RO. Dword of I/O write data. This field is undefined after trapping a read cycle. |



10.1.49 IOTRn — I/O Trap Register (0-3)

Offset Address: 1E80–1E87h Register 0 Attribute: R/W
 1E88–1E8Fh Register 1
 1E90–1E97h Register 2
 1E98–1E9Fh Register 3
 Default Value: 0000000000000000h Size: 64-bit

These registers are used to specify the set of I/O cycles to be trapped and to enable this functionality.

| Bit | Description |
|-------|----------------------------------------------------------------------------------------------------------------------------------------------------------------------------------------------------------------------------------------------------------------------------------------------------------------------------------------------------------------------------|
| 63:50 | Reserved |
| 49 | Read/Write Mask (RWM) — R/W. 0 = The cycle must match the type specified in bit 48. 1 = Trapping logic will operate on both read and write cycles. |
| 48 | Read/Write# (RWIO) — R/W. 0 = Write 1 = Read NOTE: The value in this field does not matter if bit 49 is set. |
| 47:40 | Reserved |
| 39:36 | Byte Enable Mask (BEM) — R/W. A 1 in any bit position indicates that any value in the corresponding byte enable bit in a received cycle will be treated as a match. The corresponding bit in the Byte Enables field, below, is ignored. |
| 35:32 | Byte Enables (TBE) — R/W. Active-high dword-aligned byte enables. |
| 31:24 | Reserved |
| 23:18 | Address[7:2] Mask (ADMA) — R/W. A 1 in any bit position indicates that any value in the corresponding address bit in a received cycle will be treated as a match. The corresponding bit in the Address field, below, is ignored. The mask is only provided for the lower 6 bits of the dword address, allowing for traps on address ranges up to 256 bytes in size. |
| 17:16 | Reserved |
| 15:2 | I/O Address[15:2] (I/OAD) — R/W. dword-aligned address |
| 1 | Reserved |
| 0 | Trap and SMI# Enable (TRSE) — R/W. 0 = Trapping and SMI# logic disabled. 1 = The trapping logic specified in this register is enabled. |



10.1.50 DMC—DMI Miscellaneous Control Register

Offset Address: 2010–2013h Attribute: R/W
 Default Value: 00000002h Size: 32-bit

| Bit | Description |
|-------|--------------------------------------------------------------------------------------------------------------------------------------------------------------------------------|
| 31:20 | Reserved |
| 19 | DMI Misc. Control Field 1 — R/W. BIOS shall always program this field as per the BIOS Specification. 0 = Disable DMI Power Savings. 1 = Enable DMI Power Savings. |
| 18:0 | Reserved |

10.1.51 CIR6—Chipset Initialization Register 6

Offset Address: 2024–2027h Attribute: R/W
 Default Value: 0B4030C0h Size: 32-bit

| Bit | Description |
|------|------------------------------------------------------|
| 31:8 | Reserved |
| 7 | CIR6 Field 1 — R/W. BIOS must clear this bit. |
| 6:0 | Reserved |

10.1.52 CIR7—Chipset Initialization Register 7

Offset Address: 2034–2037h Attribute: R/W
 Default Value: B2B477CCh Size: 32-bit

| Bit | Description |
|-------|-------------------------------------------------------------------|
| 31:20 | Reserved |
| 19:16 | CIR7 Field 1 — R/W. BIOS must program this field to 0101b. |
| 15:0 | Reserved |



10.1.53 TCTL—TCO Configuration Register

Offset Address: 3000–3000h Attribute: R/W
Default Value: 00h Size: 8-bit

| Bit | Description |
|-----|------------------------------------------------------------------------------------------------------------------------------------------------------------------------------------------------------------------------------------------------------------------------------------------------------------------------------------------------------------------------------------------------------------------------------------------------------------------------------------------------------------------------------------------------------------------------------------------------------------------------------------------------------------------------------------------------------------------------------------------------------------------------------------------------------------------------------------------------------------------------------------------------------------------------------------------------------|
| 7 | TCO IRQ Enable (IE) — R/W. 0 = TCO IRQ is disabled. 1 = TCO IRQ is enabled, as selected by the TCO_IRQ_SEL field. |
| 6:3 | Reserved |
| 2:0 | TCO IRQ Select (IS) — R/W. Specifies on which IRQ the TCO will internally appear. If not using the APIC, the TCO interrupt must be routed to IRQ9-11, and that interrupt is not sharable with the SERIRQ stream, but is shareable with other PCI interrupts. If using the APIC, the TCO interrupt can also be mapped to IRQ20-23, and can be shared with other interrupt. 000 = IRQ 9 001 = IRQ 10 010 = IRQ 11 011 = Reserved 100 = IRQ 20 (only if APIC enabled) 101 = IRQ 21 (only if APIC enabled) 110 = IRQ 22 (only if APIC enabled) 111 = IRQ 23 (only if APIC enabled) When setting the these bits, the IE bit should be cleared to prevent glitching. When the interrupt is mapped to APIC interrupts 9, 10 or 11, the APIC should be programmed for active-high reception. When the interrupt is mapped to APIC interrupts 20 through 23, the APIC should be programmed for active-low reception. |



10.1.54 D31IP—Device 31 Interrupt Pin Register

Offset Address: 3100–3103h
 Default Value: 03243200h

Attribute: R/W, RO
 Size: 32-bit

| Bit | Description |
|-------|----------------------------------------------------------------------------------------------------------------------------------------------------------------------------------------------------------------------------------|
| 31:28 | Reserved |
| 27:24 | Thermal Throttle Pin (TTIP) — R/W. Indicates which pin the Thermal Throttle controller drives as its interrupt 0h = No interrupt 1h = INTA# 2h = INTB# (Default) 3h = INTC# 4h = INTD# 5h–Fh = Reserved |
| 23:20 | SATA Pin 2 (SIP2) — R/W. Indicates which pin the SATA controller 2 drives as its interrupt. 0h = No interrupt 1h = INTA# 2h = INTB# (Default) 3h = INTC# 4h = INTD# 5h–Fh = Reserved |
| 19:16 | Reserved |
| 15:12 | SMBus Pin (SMIP) — R/W. Indicates which pin the SMBus controller drives as its interrupt. 0h = No interrupt 1h = INTA# 2h = INTB# (Default) 3h = INTC# 4h = INTD# 5h–Fh = Reserved |
| 11:8 | SATA Pin (SIP) — R/W. Indicates which pin the SATA controller drives as its interrupt. 0h = No interrupt 1h = INTA# 2h = INTB# (Default) 3h = INTC# 4h = INTD# 5h–Fh = Reserved |
| 7:4 | Reserved |
| 3:0 | LPC Bridge Pin (LIP) — RO. Currently, the LPC bridge does not generate an interrupt, so this field is read-only and 0. |



10.1.55 D30IP—Device 30 Interrupt Pin Register

Offset Address: 3104–3107h Attribute: RO
Default Value: 00000000h Size: 32-bit

| Bit | Description |
|------|------------------------------------------------------------------------------------------------------------------------|
| 31:4 | Reserved |
| 3:0 | PCI Bridge Pin (PIP) — RO. Currently, the PCI bridge does not generate an interrupt, so this field is read-only and 0. |

10.1.56 D29IP—Device 29 Interrupt Pin Register

Offset Address: 3108–310Bh Attribute: R/W
Default Value: 10004321h Size: 32-bit

| Bit | Description |
|-------|------------------------------------------------------------------------------------------------------------------------------------------------------------------------------------------------------------------------------------------------------------------------------------------------------------------------------------------------------------------------------------|
| 31:28 | EHCI Pin (EIP) — R/W. Indicates which pin the EHCI controller #1 drives as its interrupt. 0h = No interrupt 1h = INTA# (Default) 2h = INTB# 3h = INTC# 4h = INTD# 5h-7h = Reserved |
| 27:16 | Reserved |
| 15:12 | UHCI #6 Pin (U3P) — R/W. Indicates which pin the UHCI controller #6 (Device 29 Function 3) drives as its interrupt, if controller exists 0h = No interrupt 1h = INTA# 2h = INTB# 3h = INTC# 4h = INTD# (Default) 5h-7h = Reserved NOTE: This field should be set to 0h when UHCI Controller #6 Remap bit (RCBA offset 35F0h:bit 0) is set to 0. |
| 11:8 | UHCI #3 Pin (U2P) — R/W. Indicates which pin the UHCI controller #3 (Device 29 Function 2) drives as its interrupt. 0h = No interrupt 1h = INTA# 2h = INTB# 3h = INTC# (Default) 4h = INTD# 5h-7h = Reserved |



| Bit | Description |
|-----|---------------------------------------------------------------------------------------------------------------------------------------------------------------------------------------------------------------------------------------|
| 7:4 | UHCI #2 Pin (U1P) — R/W. Indicates which pin the UHCI controller #2 (Device 29 Function 1) drives as its interrupt. 0h = No interrupt 1h = INTA# 2h = INTB# (Default) 3h = INTC# 4h = INTD# 5h-7h = Reserved |
| 3:0 | UHCI #1 Pin (U0P) — R/W. Indicates which pin the UHCI controller #1 (Device 29 Function 0) drives as its interrupt. 0h = No interrupt 1h = INTA# (Default) 2h = INTB# 3h = INTC# 4h = INTD# 5h-7h = Reserved |

10.1.57 D28IP—Device 28 Interrupt Pin Register

Offset Address: 310C–310Fh

Attribute: R/W

Default Value: 00214321h

Size: 32-bit

| Bit | Description |
|-------|---------------------------------------------------------------------------------------------------------------------------------------------------------------------------------------------------------------------------|
| 31:16 | Reserved |
| 23:20 | PCI Express* #6 Pin (P6IP) — R/W. Indicates which pin the PCI Express* port #6 drives as its interrupt. 0h = No interrupt 1h = INTA# 2h = INTB# (Default) 3h = INTC# 4h = INTD# 5h-7h = Reserved |
| 19:16 | PCI Express #5 Pin (P5IP) — R/W. Indicates which pin the PCI Express port #5 drives as its interrupt. 0h = No interrupt 1h = INTA# (Default) 2h = INTB# 3h = INTC# 4h = INTD# 5h-7h = Reserved |
| 15:12 | PCI Express #4 Pin (P4IP) — R/W. Indicates which pin the PCI Express* port #4 drives as its interrupt. 0h = No interrupt 1h = INTA# 2h = INTB# 3h = INTC# 4h = INTD# (Default) 5h-7h = Reserved |



| Bit | Description |
|------|-------------------------------------------------------------------------------------------------------------------------------------------------------------------------------------------------------------------------|
| 11:8 | PCI Express #3 Pin (P3IP) — R/W. Indicates which pin the PCI Express port #3 drives as its interrupt. 0h = No interrupt 1h = INTA# 2h = INTB# 3h = INTC# (Default) 4h = INTD# 5h-7h = Reserved |
| 7:4 | PCI Express #2 Pin (P2IP) — R/W. Indicates which pin the PCI Express port #2 drives as its interrupt. 0h = No interrupt 1h = INTA# 2h = INTB# (Default) 3h = INTC# 4h = INTD# 5h-7h = Reserved |
| 3:0 | PCI Express #1 Pin (P1IP) — R/W. Indicates which pin the PCI Express port #1 drives as its interrupt. 0h = No interrupt 1h = INTA# (Default) 2h = INTB# 3h = INTC# 4h = INTD# 5h-7h = Reserved |

10.1.58 D27IP—Device 27 Interrupt Pin Register

Offset Address: 3110–3113h Attribute: R/W
 Default Value: 00000001h Size: 32-bit

| Bit | Description |
|------|---------------------------------------------------------------------------------------------------------------------------------------------------------------------------------------------------------------------------------------------------------|
| 31:4 | Reserved |
| 3:0 | Intel® High Definition Audio Pin (ZIP) — R/W. Indicates which pin the Intel High Definition Audio controller drives as its interrupt. 0h = No interrupt 1h = INTA# (Default) 2h = INTB# 3h = INTC# 4h = INTD# 5h-Fh = Reserved |



10.1.59 D26IP—Device 26 Interrupt Pin Register

Offset Address: 3114–3117h
 Default Value: 30000321h

Attribute: R/W
 Size: 32-bit

| Bit | Description |
|-------|------------------------------------------------------------------------------------------------------------------------------------------------------------------------------------------------------------------------------------------------------------------------------------------------------------------------------------------------------------------------------------------------------------------------------------------------------------|
| 31:28 | <p>EHCI #2 Pin (E2IP) — R/W. Indicates which pin the EHCI controller #2 drives as its interrupt:</p> <p>0h = No Interrupt 1h = INTA# 2h = INTB# 3h = INTC# (Default) 4h = INTD# 5h-Fh = Reserved</p> |
| 27:12 | Reserved |
| 11:8 | <p>UHCI #6 Pin (U2P) — R/W. Indicates which pin UHCI controller #6 (Device 26 Function 2) drives as its interrupt, if controller exists.</p> <p>0h = No Interrupt 1h = INTA# 2h = INTB# 3h = INTC# (Default) 4h = INTD# 5h-Fh = Reserved</p> <p>NOTE: This field should be set to 0h when UHCI Controller #6 Remap bit (RCBA offset 35F0h:bit 0) is set to 1.</p> |
| 7:4 | <p>UHCI #5 Pin (U1P) — R/W. Indicates which pin UHCI controller #5 (Device 26 Function 1), drives as its interrupt.</p> <p>0h = No Interrupt 1h = INTA# 2h = INTB# (Default) 3h = INTC# 4h = INTD# 5h-Fh = Reserved</p> |
| 3:0 | <p>UHCI #4 Pin (U0P) — R/W. Indicates which pin UHCI controller #4 (Device 26 Function 0), drives as its interrupt.</p> <p>0h = No Interrupt 1h = INTA# (Default) 2h = INTB# 3h = INTC# 4h = INTD# 5h-Fh = Reserved</p> |



10.1.60 D25IP—Device 25 Interrupt Pin Register

Offset Address: 3118–311Bh Attribute: R/W
Default Value: 00000001h Size: 32-bit

| Bit | Description |
|------|------------------------------------------------------------------------------------------------------------------------------------------------------------------------------------------------------------------------|
| 31:4 | Reserved |
| 3:0 | GBE LAN Pin (LIP) — R/W. Indicates which pin the internal GbE LAN controller drives as its interrupt 0h = No Interrupt 1h = INTA# (Default) 2h = INTB# 3h = INTC# 4h = INTD# 5h-Fh = Reserved |

10.1.61 D31IR—Device 31 Interrupt Route Register

Offset Address: 3140–3141h Attribute: R/W
Default Value: 3210h Size: 16-bit

| Bit | Description |
|-------|-------------------------------------------------------------------------------------------------------------------------------------------------------------------------------------------------------------------------------------------------------------------------------------------|
| 15 | Reserved |
| 14:12 | Interrupt D Pin Route (IDR) — R/W. Indicates which physical pin on the Intel ICH is connected to the INTD# pin reported for device 31 functions. 0h = PIRQA# 1h = PIRQB# 2h = PIRQC# 3h = PIRQD# (Default) 4h = PIRQE# 5h = PIRQF# 6h = PIRQG# 7h = PIRQH# |
| 11 | Reserved |
| 10:8 | Interrupt C Pin Route (ICR) — R/W. Indicates which physical pin on the ICH is connected to the INTC# pin reported for device 31 functions. 0h = PIRQA# 1h = PIRQB# 2h = PIRQC# (Default) 3h = PIRQD# 4h = PIRQE# 5h = PIRQF# 6h = PIRQG# 7h = PIRQH# |
| 7 | Reserved |



| Bit | Description |
|-----|----------------------------------------------------------------------------------------------------------------------------------------------------------------------------------------------------------------------------------------------------------------------------------------------------------------------------------------------------------------------------------------------------------------------------------------------------------|
| 6:4 | <p>Interrupt B Pin Route (IBR) — R/W. Indicates which physical pin on the ICH is connected to the INTB# pin reported for device 31 functions.</p> <p>0h = PIRQA# 1h = PIRQB# (Default) 2h = PIRQC# 3h = PIRQD# 4h = PIRQE# 5h = PIRQF# 6h = PIRQG# 7h = PIRQH#</p> |
| 3 | Reserved |
| 2:0 | <p>Interrupt A Pin Route (IAR) — R/W. Indicates which physical pin on the ICH is connected to the INTA# pin reported for device 31 functions.</p> <p>0h = PIRQA# (Default) 1h = PIRQB# 2h = PIRQC# 3h = PIRQD# 4h = PIRQE# 5h = PIRQF# 6h = PIRQG# 7h = PIRQH#</p> |

10.1.62 D30IR—Device 30 Interrupt Route Register

Offset Address: 3142–3143h Attribute: RO
 Default Value: 0000h Size: 16-bit

| Bit | Description |
|------|---------------------------------------------------|
| 15:0 | Reserved. No interrupts generated from Device 30. |



10.1.63 D29IR—Device 29 Interrupt Route Register

Offset Address: 3144–3145h Attribute: R/W
 Default Value: 3210h Size: 16-bit

| Bit | Description |
|-------|------------------------------------------------------------------------------------------------------------------------------------------------------------------------------------------------------------------------------------------------------------------------------------------------------------------------------------------------------------------------------------------|
| 15 | Reserved |
| 14:12 | <p>Interrupt D Pin Route (IDR) — R/W. Indicates which physical pin on the Intel ICH is connected to the INTD# pin reported for device 29 functions.</p> <p>0h = PIRQA# 1h = PIRQB# 2h = PIRQC# 3h = PIRQD# (Default) 4h = PIRQE# 5h = PIRQF# 6h = PIRQG# 7h = PIRQH#</p> |
| 11 | Reserved |
| 10:8 | <p>Interrupt C Pin Route (ICR) — R/W. Indicates which physical pin on the ICH is connected to the INTC# pin reported for device 29 functions.</p> <p>0h = PIRQA# 1h = PIRQB# 2h = PIRQC# (Default) 3h = PIRQD# 4h = PIRQE# 5h = PIRQF# 6h = PIRQG# 7h = PIRQH#</p> |
| 7 | Reserved |
| 6:4 | <p>Interrupt B Pin Route (IBR) — R/W. Indicates which physical pin on the ICH is connected to the INTB# pin reported for device 29 functions.</p> <p>0h = PIRQA# 1h = PIRQB# (Default) 2h = PIRQC# 3h = PIRQD# 4h = PIRQE# 5h = PIRQF# 6h = PIRQG# 7h = PIRQH#</p> |
| 3 | Reserved |
| 2:0 | <p>Interrupt A Pin Route (IAR) — R/W. Indicates which physical pin on the ICH is connected to the INTA# pin reported for device 29 functions.</p> <p>0h = PIRQA# (Default) 1h = PIRQB# 2h = PIRQC# 3h = PIRQD# 4h = PIRQE# 5h = PIRQF# 6h = PIRQG# 7h = PIRQH#</p> |



10.1.64 D28IR—Device 28 Interrupt Route Register

Offset Address: 3146–3147h
 Default Value: 3210h

Attribute: R/W
 Size: 16-bit

| Bit | Description |
|-------|------------------------------------------------------------------------------------------------------------------------------------------------------------------------------------------------------------------------------------------------------------------------------------------------------------------------------------------------------------------------------------------|
| 15 | Reserved |
| 14:12 | <p>Interrupt D Pin Route (IDR) — R/W. Indicates which physical pin on the Intel ICH is connected to the INTD# pin reported for device 28 functions.</p> <p>0h = PIRQA# 1h = PIRQB# 2h = PIRQC# 3h = PIRQD# (Default) 4h = PIRQE# 5h = PIRQF# 6h = PIRQG# 7h = PIRQH#</p> |
| 11 | Reserved |
| 10:8 | <p>Interrupt C Pin Route (ICR) — R/W. Indicates which physical pin on the ICH is connected to the INTC# pin reported for device 28 functions.</p> <p>0h = PIRQA# 1h = PIRQB# 2h = PIRQC# (Default) 3h = PIRQD# 4h = PIRQE# 5h = PIRQF# 6h = PIRQG# 7h = PIRQH#</p> |
| 7 | Reserved |
| 6:4 | <p>Interrupt B Pin Route (IBR) — R/W. Indicates which physical pin on the ICH is connected to the INTB# pin reported for device 28 functions.</p> <p>0h = PIRQA# 1h = PIRQB# (Default) 2h = PIRQC# 3h = PIRQD# 4h = PIRQE# 5h = PIRQF# 6h = PIRQG# 7h = PIRQH#</p> |
| 3 | Reserved |
| 2:0 | <p>Interrupt A Pin Route (IAR) — R/W. Indicates which physical pin on the ICH is connected to the INTA# pin reported for device 28 functions.</p> <p>0h = PIRQA# (Default) 1h = PIRQB# 2h = PIRQC# 3h = PIRQD# 4h = PIRQE# 5h = PIRQF# 6h = PIRQG# 7h = PIRQH#</p> |



10.1.65 D27IR—Device 27 Interrupt Route Register

Offset Address: 3148–3149h
 Default Value: 3210h

Attribute: R/W
 Size: 16-bit

| Bit | Description |
|-------|------------------------------------------------------------------------------------------------------------------------------------------------------------------------------------------------------------------------------------------------------------------------------------------------------------------------------------------------------------------------------------------|
| 15 | Reserved |
| 14:12 | <p>Interrupt D Pin Route (IDR) — R/W. Indicates which physical pin on the Intel ICH is connected to the INTD# pin reported for device 27 functions.</p> <p>0h = PIRQA# 1h = PIRQB# 2h = PIRQC# 3h = PIRQD# (Default) 4h = PIRQE# 5h = PIRQF# 6h = PIRQG# 7h = PIRQH#</p> |
| 11 | Reserved |
| 10:8 | <p>Interrupt C Pin Route (ICR) — R/W. Indicates which physical pin on the ICH is connected to the INTC# pin reported for device 27 functions.</p> <p>0h = PIRQA# 1h = PIRQB# 2h = PIRQC# (Default) 3h = PIRQD# 4h = PIRQE# 5h = PIRQF# 6h = PIRQG# 7h = PIRQH#</p> |
| 7 | Reserved |
| 6:4 | <p>Interrupt B Pin Route (IBR) — R/W. Indicates which physical pin on the ICH is connected to the INTB# pin reported for device 27 functions.</p> <p>0h = PIRQA# 1h = PIRQB# (Default) 2h = PIRQC# 3h = PIRQD# 4h = PIRQE# 5h = PIRQF# 6h = PIRQG# 7h = PIRQH#</p> |
| 3 | Reserved |
| 2:0 | <p>Interrupt A Pin Route (IAR) — R/W. Indicates which physical pin on the ICH is connected to the INTA# pin reported for device 27 functions.</p> <p>0h = PIRQA# (Default) 1h = PIRQB# 2h = PIRQC# 3h = PIRQD# 4h = PIRQE# 5h = PIRQF# 6h = PIRQG# 7h = PIRQH#</p> |



10.1.66 D26IR—Device 26 Interrupt Route Register

Offset Address: 314C–314Dh
 Default Value: 3210h

Attribute: R/W
 Size: 16-bit

| Bit | Description |
|-------|------------------------------------------------------------------------------------------------------------------------------------------------------------------------------------------------------------------------------------------------------------------------------------------------------------------------------------------------------------------------------------|
| 15 | Reserved |
| 14:12 | <p>Interrupt D Pin Route (IDR) — R/W. Indicates which physical pin on the ICH is connected to the INTD# pin reported for device 26 functions:</p> <p>0h = PIRQA# 1h = PIRQB# 2h = PIRQC# 3h = PIRQD# (Default) 4h = PIRQE# 5h = PIRQF# 6h = PIRQG# 7h = PIRQH#</p> |
| 11 | Reserved |
| 10:8 | <p>Interrupt C Pin Route (ICR) — R/W. Indicates which physical pin on the ICH is connected to the INTC# pin reported for device 26 functions.</p> <p>0h = PIRQA# 1h = PIRQB# 2h = PIRQC# (Default) 3h = PIRQD# 4h = PIRQE# 5h = PIRQF# 6h = PIRQG# 7h = PIRQH#</p> |
| 7 | Reserved |
| 6:4 | <p>Interrupt B Pin Route (IBR) — R/W. Indicates which physical pin on the ICH is connected to the INTB# pin reported for device 26 functions.</p> <p>0h = PIRQA# 1h = PIRQB# (Default) 2h = PIRQC# 3h = PIRQD# 4h = PIRQE# 5h = PIRQF# 6h = PIRQG# 7h = PIRQH#</p> |
| 3 | Reserved |
| 2:0 | <p>Interrupt A Pin Route (IAR) — R/W. Indicates which physical pin on the ICH is connected to the INTA# pin reported for device 26 functions.</p> <p>0h = PIRQA# (Default) 1h = PIRQB# 2h = PIRQC# 3h = PIRQD# 4h = PIRQE# 5h = PIRQF# 6h = PIRQG# 7h = PIRQH#</p> |



10.1.67 D25IR—Device 25 Interrupt Route Register

Offset Address: 3150–3151h
Default Value: 3210h

Attribute: R/W
Size: 16-bit

| Bit | Description |
|-------|---------------------------------------------------------------------------------------------------------------------------------------------------------------------------------------------------------------------------------------------------------------------------------------|
| 15 | Reserved |
| 14:12 | Interrupt D Pin Route (IDR) : — R/W. Indicates which physical pin on the ICH is connected to the INTD# pin reported for device 25 functions: 0h = PIRQA# 1h = PIRQB# 2h = PIRQC# 3h = PIRQD# (Default) 4h = PIRQE# 5h = PIRQF# 6h = PIRQG# 7h = PIRQH# |
| 11 | Reserved |
| 10:8 | Interrupt C Pin Route (ICR) — R/W. Indicates which physical pin on the ICH is connected to the INTC# pin reported for device 25 functions. 0h = PIRQA# 1h = PIRQB# 2h = PIRQC# (Default) 3h = PIRQD# 4h = PIRQE# 5h = PIRQF# 6h = PIRQG# 7h = PIRQH# |
| 7 | Reserved |
| 6:4 | Interrupt B Pin Route (IBR) — R/W. Indicates which physical pin on the ICH is connected to the INTB# pin reported for device 25 functions. 0h = PIRQA# 1h = PIRQB# (Default) 2h = PIRQC# 3h = PIRQD# 4h = PIRQE# 5h = PIRQF# 6h = PIRQG# 7h = PIRQH# |
| 3 | Reserved |
| 2:0 | Interrupt A Pin Route (IAR) — R/W. Indicates which physical pin on the ICH is connected to the INTA# pin reported for device 25 functions. 0h = PIRQA# (Default) 1h = PIRQB# 2h = PIRQC# 3h = PIRQD# 4h = PIRQE# 5h = PIRQF# 6h = PIRQG# 7h = PIRQH# |



10.1.68 OIC—Other Interrupt Control Register (Corporate Only)

Offset Address: 31FE–31FFh Attribute: R/W
 Default Value: 0000h Size: 16-bit

| Bit | Description |
|-------|-------------------------------------------------------------------------------------------------------------------------------------------------------------------------------------------------------------------------------------------------------------------------|
| 15:10 | Reserved |
| 9 | Coprocessor Error Enable (CEN) — R/W. 0 = FERR# will not generate IRQ13 nor IGNNE#. 1 = If FERR# is low, the Intel ICH10 generates IRQ13 internally and holds it until an I/O port F0h write. It will also drive IGNNE# active. |
| 8 | APIC Enable (AEN) — R/W. 0 = The internal IOxAPIC is disabled. 1 = Enables the internal IOxAPIC and its address decode. NOTE: SW should read this register after modifying APIC enable bit prior to access to the IOxAPIC address range. |
| 7:0 | APIC Range Select (ASEL) — R/W. These bits define address bits 19:12 for the IOxAPIC range. The default value of 00h enables compatibility with prior ICH products as an initial value. This value must not be changed unless the IOxAPIC Enable bit is cleared. |

NOTE: FEC10000h – FEC3FFFFh is allocated to PCIe when I/OxApic Enable (PAE) bit is set.

10.1.69 OIC—Other Interrupt Control Register (Consumer Only)

Offset Address: 31FF–31FFh Attribute: R/W
 Default Value: 00h Size: 8-bit

| Bit | Description |
|-----|------------------------------------------------------------------------------------------------------------------------------------------------------------------------------------------------------------------------------------------------------------------------|
| 7:4 | APIC Range Select (ASEL) — R/W. These bits define address bits 15:12 for the IOxAPIC range. The default value of 0h enables compatibility with prior ICH products as an initial value. This value must not be changed unless the IOxAPIC Enable bit is cleared. |
| 3:2 | Reserved |
| 1 | Coprocessor Error Enable (CEN) — R/W. 0 = FERR# will not generate IRQ13 nor IGNNE#. 1 = If FERR# is low, the Intel® ICH10 generates IRQ13 internally and holds it until an I/O port F0h write. It will also drive IGNNE# active. |
| 0 | APIC Enable (AEN) — R/W. 0 = The internal IOxAPIC is disabled. 1 = Enables the internal IOxAPIC and its address decode. NOTE: SW should read this register after modifying APIC enable bit prior to access to the IOxAPIC address range. |

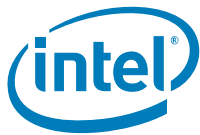

10.1.70 SBEMC3—Scheduled Break Event C3 Exit Latency

Offset Address: 3300–3303h Attribute: R/W
Default Value: 00000000h Size: 32-bit

| Bit | Description |
|-------|----------------------------------------------------------------------------------------------------------------------------------------------|
| 31:23 | Reserved. |
| 22:16 | Present State C3 Future State C3 Exit Latency (C3C3EL) — R/W. Sets exit latency if present and future C-state is C3. |
| 15 | Reserved. |
| 14:8 | Present State C2 Future State C3 Exit Latency (C2C3EL) — R/W. Sets exit latency if present C-state is C2 and future C-state is C3. |
| 7 | Reserved. |
| 6:0 | Present State C0 Future State C3 Exit Latency (C0C3EL) — R/W. Sets exit latency if present C-state is C0 and future C-state is C3. |

10.1.71 SBEMC4—Scheduled Break Event C4 Exit Latency

Offset Address: 3304–3307h Attribute: R/W
Default Value: 00000000h Size: 32-bit

| Bit | Description |
|-------|----------------------------------------------------------------------------------------------------------------------------------------------|
| 31 | Reserved. |
| 30:24 | Present State C4 Future State C4 Exit Latency (C4C4EL) — R/W. Sets exit latency if present and future C-state is C4. |
| 22:16 | Present State C3 Future State C4 Exit Latency (C3C4EL) — R/W. Sets exit latency if present C-state is C3 and future C-state is C4. |
| 15 | Reserved. |
| 14:8 | Present State C2 Future State C4 Exit Latency (C2C4EL) — R/W. Sets exit latency if present C-state is C2 and future C-state is C4. |
| 7 | Reserved. |
| 6:0 | Present State C0 Future State C4 Exit Latency (C0C4EL) — R/W. Sets exit latency if present C-state is C0 and future C-state is C4. |



10.1.72 PRSTS—Power and Reset Status (Corporate Only)

Offset Address: 3310–3313h
 Default Value: TBDh

Attribute: RO, R/WC
 Size: 32-bit

| Bit | Description |
|-------|-------------------------------------------------------------------------------------------------------------------------------------------------------------------------------------------------------------------------------------------------------------------------------------------------------------------------------------------------------------------------------------------------------------------------------------------------------------|
| 31:16 | Reserved |
| 15 | Power Management Watchdog Timer -R/WC. This bit is set when the Power Management watchdog timer causes a global reset. |
| 14:7 | Reserved |
| 6 | Intel® Management Engine Watchdog Timer Status -R/WC. This bit is set when the Intel® Management Engine watchdog timer causes a global reset. |
| 5 | Wake On Lan Override Wake Status (WOL_OVR_WK_STS) — R/WC. This bit gets set when all of the following conditions are met: <ul style="list-style-type: none"> • Integrated LAN Signals a Power Management Event • The system is not in S0 • The “WOL Enable Override” bit is set in configuration space. BIOS can read this status bit to determine this wake source. Software clears this bit by writing a 1 to it. |
| 4 | Reserved |
| 3 | ME Host Power Down (ME_HOST_PWRDN) — R/WC. This bit is set when the Intel ME generates a host reset with power down. |
| 2 | ME Host Reset Warm Status (ME_HRST_WARM_STS) — R/WC. This bit is set when the Intel Management Engine generates a Host reset without power cycling. Software clears this bit by writing a 1 to this bit position. |
| 1 | ME Host Reset Cold Status (ME_HRST_COLD_STS) — R/WC. This bit is set when the Intel Management Engine generates a Host reset with power cycling. Software clears this bit by writing a 1 to this bit position. |
| 0 | ME WAKE STATUS (ME_WAKE_STS) — R/WC. This bit is set when the Intel Management Engine generates a Non-Maskable wake event, and is not affected by any other enable bit. When this bit is set, the Host Power Management logic wakes to S0. |



10.1.73 RC—RTC Configuration Register

Offset Address: 3400–3403h Attribute: R/W, R/WLO
Default Value: 00000000h Size: 32-bit

| Bit | Description |
|------|---------------------------------------------------------------------------------------------------------------------------------------------------------------------------------------------------------------------------------------------------------------|
| 31:5 | Reserved |
| 4 | Upper 128 Byte Lock (UL) — R/WLO. 0 = Bytes not locked. 1 = Bytes 38h-3Fh in the upper 128-byte bank of RTC RAM are locked and cannot be accessed. Writes will be dropped and reads will not return any ensured data. Bit reset on system reset. |
| 3 | Lower 128 Byte Lock (LL) — R/WLO. 0 = Bytes not locked. 1 = Bytes 38h-3Fh in the lower 128-byte bank of RTC RAM are locked and cannot be accessed. Writes will be dropped and reads will not return any ensured data. Bit reset on system reset. |
| 2 | Upper 128 Byte Enable (UE) — R/W. 0 = Bytes locked. 1 = The upper 128-byte bank of RTC RAM can be accessed. |
| 1:0 | Reserved |

10.1.74 HPTC—High Precision Timer Configuration Register

Offset Address: 3404–3407h Attribute: R/W
Default Value: 00000000h Size: 32-bit

| Bit | Description |
|------|-------------------------------------------------------------------------------------------------------------------------------------------------------------------------------------------------------------------------------------------------------------------------------------------------|
| 31:8 | Reserved |
| 7 | Address Enable (AE) — R/W. 0 = Address disabled. 1 = The Intel® ICH10 will decode the High Precision Timer memory address range selected by bits 1:0 below. |
| 6:2 | Reserved |
| 1:0 | Address Select (AS) — R/W. This 2-bit field selects 1 of 4 possible memory address ranges for the High Precision Timer functionality. The encodings are: 00 = FED0_0000h – FED0_03FFh 01 = FED0_1000h – FED0_13FFh 10 = FED0_2000h – FED0_23FFh 11 = FED0_3000h – FED0_33FFh |



10.1.75 GCS—General Control and Status Register

Offset Address: 3410–3413h Attribute: R/W, R/WLO
 Default Value: 00000yy0h (yy = xx0000x0b) Size: 32-bit

| Bit | Description | | | | | | | | |
|------------|--------------------------------------------------------------------------------------------------------------------------------------------------------------------------------------------------------------------------------------------------------------------------------------------------------------------------------------------------------------------------------------------------------------------------------------------------------------------------------------------------------------------------------------------------------------------------------------------------------------------------------------------------------------------------------------------------------------------------------------------------------------------------------------------------------------------------------------------------------------------------------------------------------------------------------------------------------------------------------------------------------------------------------------------------------------------------------------------------------------------------------------------------------------------------------------------------------------------------------------------------------------------------------------------------------------------------------------------------------------------------------------------------------------------------------------------------------------------------------------------------------------------------------------------------------------------------------------------------------------------------------------------|------------|-------------|-----|-----|-----|-----|-----|-----|
| 31:13 | Reserved. | | | | | | | | |
| 12 | <p>Function Level Reset Capability Structure Select (FLRCSSEL) — R/W.</p> <p>0 = Function Level Reset (FLR) will utilize the standard capability structure with unique capability ID assigned by PCISIG.</p> <p>1 = Vendor Specific Capability Structure is selected for FLR.</p> | | | | | | | | |
| 11:10 | <p>Boot BIOS Straps (BBS) — R/W. This field determines the destination of accesses to the BIOS memory range. The default values for these bits represent the strap values of GNT0# (bit 11) at the rising edge of PWROK and SPI_CS1# (bit 10) at the rising edge of CLPWROK.</p> <table border="1"> <thead> <tr> <th>Bits 11:10</th> <th>Description</th> </tr> </thead> <tbody> <tr> <td>0xb</td> <td>SPI</td> </tr> <tr> <td>10b</td> <td>PCI</td> </tr> <tr> <td>11b</td> <td>LPC</td> </tr> </tbody> </table> <p>When PCI is selected, the top 16 MB of memory below 4 GB (FF00_0000h to FFFF_FFFFh) is accepted by the primary side of the PCI P2P bridge and forwarded to the PCI bus. This allows systems with corrupted or unprogrammed flash to boot from a PCI device. The PCI-to-PCI bridge Memory Space Enable bit does not need to be set (nor any other bits) in order for these cycles to go to PCI. Note that BIOS decode range bits and the other BIOS protection bits have no effect when PCI is selected. This functionality is intended for debug/testing only.</p> <p>When SPI or LPC is selected, the range that is decoded is further qualified by other configuration bits described in the respective sections.</p> <p>The value in this field can be overwritten by software as long as the BIOS Interface Lock-Down (bit 0) is not set.</p> <p>NOTE: Booting to PCI is intended for debug/testing only. Boot BIOS Destination Select to LPC/PCI by functional strap or via Boot BIOS Destination Bit will not affect SPI accesses initiated by Intel Management Engine or Integrated GbE LAN.</p> | Bits 11:10 | Description | 0xb | SPI | 10b | PCI | 11b | LPC |
| Bits 11:10 | Description | | | | | | | | |
| 0xb | SPI | | | | | | | | |
| 10b | PCI | | | | | | | | |
| 11b | LPC | | | | | | | | |
| 9 | <p>Server Error Reporting Mode (SERM) — R/W.</p> <p>0 = The Intel® ICH10 is the final target of all errors. The (G)MCH sends a messages to the ICH for the purpose of generating NMI.</p> <p>1 = The (G)MCH is the final target of all errors from PCI Express* and DMI. In this mode, if the ICH10 detects a fatal, non-fatal, or correctable error on DMI or its downstream ports, it sends a message to the (G)MCH. If the ICH10 receives an ERR_* message from the downstream port, it sends that message to the (G)MCH.</p> | | | | | | | | |
| 8:7 | Reserved | | | | | | | | |
| 6 | <p>FERR# MUX Enable (FME) — R/W. This bit enables FERR# to be a processor break event indication.</p> <p>0 = Disabled.</p> <p>1 = The ICH10 examines FERR# during a C2, C3, or C4 state as a break event. See Chapter 5.13.5 for a functional description.</p> | | | | | | | | |



| Bit | Description |
|-----|-----------------------------------------------------------------------------------------------------------------------------------------------------------------------------------------------------------------------------------------------------------------------------------------------------------------------------------------------------------------------------------------------------------------------------------------------------------------------------------------------------------------------------------------------------------------------------------------------------------------------------------------------------------------------------------------------------------------------------------------------------------------------------------------------------------------------------------------------------------------------------------------------------------------|
| 5 | <p>No Reboot (NR) — R/W. This bit is set when the “No Reboot” strap (SPKR pin on ICH10) is sampled high on PWROK. This bit may be set or cleared by software if the strap is sampled low but may not override the strap when it indicates “No Reboot”.</p> <p>0 = System will reboot upon the second timeout of the TCO timer. 1 = The TCO timer will count down and generate the SMI# on the first timeout, but will not reboot on the second timeout.</p> |
| 4 | <p>Alternate Access Mode Enable (AME) — R/W.</p> <p>0 = Disabled. 1 = Alternate access read only registers can be written, and write only registers can be read. Before entering a low power state, several registers from powered down parts may need to be saved. In the majority of cases, this is not an issue, as registers have read and write paths. However, several of the ISA compatible registers are either read only or write only. To get data out of write-only registers, and to restore data into read-only registers, the ICH implements an alternate access mode. For a list of these registers see Section 5.13.9.</p> |
| 3 | <p>Shutdown Policy Select (SPS) — R/W. When cleared (default), the ICH10 will drive INIT# in response to the shutdown Vendor Defined Message (VDM). When set to 1, ICH10 will treat the shutdown VDM similar to receiving a CF9h I/O write with data value 06h, and will drive PLTRST# active.</p> |
| 2 | <p>Reserved Page Route (RPR) — R/W. Determines where to send the reserved page registers. These addresses are sent to PCI or LPC for the purpose of generating POST codes. The I/O addresses modified by this field are: 80h, 84h, 85h, 86h, 88h, 8Ch, 8Dh, and 8Eh.</p> <p>0 = Writes will be forwarded to LPC, shadowed within the ICH, and reads will be returned from the internal shadow 1 = Writes will be forwarded to PCI, shadowed within the ICH, and reads will be returned from the internal shadow.</p> <p>Note, if some writes are done to LPC/PCI to these I/O ranges, and then this bit is flipped, such that writes will now go to the other interface, the reads will not return what was last written. Shadowing is performed on each interface.</p> <p>The aliases for these registers, at 90h, 94h, 95h, 96h, 98h, 9Ch, 9Dh, and 9Eh, are always decoded to LPC.</p> |
| 1 | Reserved |
| 0 | <p>BIOS Interface Lock-Down (BILD) — R/WLO.</p> <p>0 = Disabled. 1 = Prevents BUC.TS (offset 3414, bit 0) and GCS.BBS (offset 3410h, bits 11:10) from being changed. This bit can only be written from 0 to 1 once.</p> |



10.1.76 BUC—Backed Up Control Register

Offset Address: 3414–3414h Attribute: R/W
 Default Value: 0000000xb Size: 8-bit

All bits in this register are in the RTC well and only cleared by RTCRST#

| Bit | Description |
|-----|-----------------------------------------------------------------------------------------------------------------------------------------------------------------------------------------------------------------------------------------------------------------------------------------------------------------------------------------------------------------------------------------------------|
| 7:6 | Reserved |
| 5 | <p>LAN Disable — R/W. 0 = LAN is Enabled 1 = LAN is Disabled.</p> <p>This bit is locked by the Function Disable SUS Well Lockdown register. Once locked this bit can not be changed by software.</p> |
| 4 | <p>Daylight Savings Override (SDO) — R/W. 0 = Daylight Savings is Enabled. 1 = The DSE bit in RTC Register B is set to Read-only with a value of 0 to disable daylight savings.</p> |
| 3 | Reserved |
| 2 | <p>CPU BIST Enable (CBE) — R/W. This bit is in the resume well and is reset by RSMRST#, but not PLTRST# nor CF9h writes. 0 = Disabled. 1 = The INIT# signals will be driven active when CPURST# is active. INIT# and INIT3_3V# will go inactive with the same timings as the other processor interface signals (hold time after CPURST# inactive).</p> |
| 1 | Reserved |
| 0 | <p>Top Swap (TS) — R/W. 0 = Intel® ICH10 will not invert A16. 1 = ICH10 will invert A16 for cycles going to the BIOS space (but not the feature space) in the FWH.</p> <p>If ICH is strapped for Top-Swap (GNT3# is low at rising edge of PWROK), then this bit cannot be cleared by software. The strap jumper should be removed and the system rebooted.</p> |



10.1.77 FD—Function Disable Register

Offset Address: 3418–341Bh Attribute: R/W
Default Value: See bit description Size: 32-bit

The UHCI functions must be disabled from highest function number to lowest within each PCI device (Device 29 or Device 26). For example, if only two UHCIs are wanted on Device 29, software must disable UHCI #3 (UD3 bit set). When disabling UHCIs, the EHCI Structural Parameters Registers must be updated with coherent information in “Number of Companion Controllers” and “N_Ports” fields.

When disabling a function, only the configuration space is disabled. Software must ensure that all functionality within a controller that is not desired (such as memory spaces, I/O spaces, and DMA engines) is disabled prior to disabling the function.

When a function is disabled, software must not attempt to re-enable it. A disabled function can only be re-enabled by a platform reset.

| Bit | Description |
|-------|------------------------------------------------------------------------------------------------------------------------------------------------------------------------------------------------------------------------------------------------------------------------------------------------|
| 31:26 | Reserved |
| 25 | Serial ATA Disable 2 (SAD2) — R/W. Default is 0. 0 = The SATA controller #2 (D31:F5) is enabled. 1 = The SATA controller #2 (D31:F5) is disabled. |
| 24 | Thermal Throttle Disable (TTD) — R/W. Default is 0. 0 = Thermal Throttle is enabled. 1 = Thermal Throttle is disabled. |
| 23:22 | Reserved |
| 21 | PCI Express* 6 Disable (PE6D) — R/W. Default is 0. When disabled, the link for this port is put into the “link down” state. 0 = PCI Express* port #6 is enabled. 1 = PCI Express port #6 is disabled. |
| 20 | PCI Express 5 Disable (PE5D) — R/W. Default is 0. When disabled, the link for this port is put into the link down state. 0 = PCI Express port #5 is enabled. 1 = PCI Express port #5 is disabled. |
| 19 | PCI Express 4 Disable (PE4D) — R/W. Default is 0. When disabled, the link for this port is put into the “link down” state. 0 = PCI Express port #4 is enabled. 1 = PCI Express port #4 is disabled. NOTE: This bit must be set when Port 1 is configured as a x4. |
| 18 | PCI Express 3 Disable (PE3D) — R/W. Default is 0. When disabled, the link for this port is put into the link down state. 0 = PCI Express port #3 is enabled. 1 = PCI Express port #3 is disabled. NOTE: This bit must be set when Port 1 is configured as a x4. |
| 17 | PCI Express 2 Disable (PE2D) — R/W. Default is 0. When disabled, the link for this port is put into the link down state. 0 = PCI Express port #2 is enabled. 1 = PCI Express port #2 is disabled. NOTE: This bit must be set when Port 1 is configured as a x4 or a x2. |



| Bit | Description |
|-------------------------|----------------------------------------------------------------------------------------------------------------------------------------------------------------------------------------------------------------------------------------------------------------------------------------------------------------------------------------------------------------------------------------------------------------------------------------------------------------------------------------------------------------------------------------------------------------------------------------------------------------------------------|
| 16 | PCI Express 1 Disable (PE1D) — R/W. Default is 0. When disabled, the link for this port is put into the link down state. 0 = PCI Express port #1 is enabled. 1 = PCI Express port #1 is disabled. |
| 15 | EHCI #1 Disable (EHCI1D) — R/W. Default is 0. 0 = The EHCI #1 is enabled. 1 = The EHCI #1 is disabled. |
| 14 | LPC Bridge Disable (LBD) — R/W. Default is 0. 0 = The LPC bridge is enabled. 1 = The LPC bridge is disabled. Unlike the other disables in this register, the following additional spaces will no longer be decoded by the LPC bridge: <ul style="list-style-type: none"> · Memory cycles below 16 MB (1000000h) · I/O cycles below 64 KB (10000h) · The Internal I/OxAPIC at FEC0_0000 to FECF_FFFF Memory cycles in the LPC BIOS range below 4 GB will still be decoded when this bit is set, but the aliases at the top of 1 MB (the E and F segment) no longer will be decoded. |
| 13 | EHCI #2 Disable (EHCI2D) — R/W. Default is 0. 0 = The EHCI #2 is enabled. 1 = The EHCI #2 is disabled. Note: When this bit is set, the UHCI #5 function is not available and the UHCI #4 must be disabled by setting bit 11 in this register. |
| 12 | UHCI #5 Disable (U5D) — R/W. Default is 0 0 = The UHCI #5 is enabled. 1 = The UHCI #5 is disabled. When the EHCI #2 Device Disable (EHCI2D) is set, this bit is a don't care |
| 11 | UHCI #4 Disable (U4D) — R/W. Default is 0. 0 = The 4th UHCI (ports 6 and 7) is enabled. 1 = The 4th UHCI (ports 6 and 7) is disabled. Note that UHCI #4 must be disabled when EHCI #2 is disabled with bit 13 in this register. |
| 10 | UHCI #3 Disable (U3D) — R/W. Default is 0. 0 = The 3rd UHCI (ports 4 and 5) is enabled. 1 = The 3rd UHCI (ports 4 and 5) is disabled. |
| 9 | UHCI #2 Disable (U2D) — R/W. Default is 0. 0 = The 2nd UHCI (ports 2 and 3) is enabled. 1 = The 2nd UHCI (ports 2 and 3) is disabled. |
| 8 | UHCI #1 Disable (U1D) — R/W. Default is 0. 0 = The 1st UHCI (ports 0 and 1) is enabled. 1 = The 1st UHCI (ports 0 and 1) is disabled. |
| 7 | UHCI #6 Disable (U6D) — R/W. Default is 0. 0 = The 6th UHCI (ports 10 and 11) is enabled. 1 = The 6th UHCI (ports 10 and 11) is disabled. |
| 6:5 (Corporate Only) | USB Test Devices #1 and #2 — R/W. Default is 0. BIOS must set these bits to 11b. NOTE: These bits only apply to ICH10 Corporate A0, A1, and B0 Samples and are reserved for ICH10 Corporate Production units. |

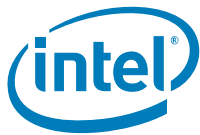

| Bit | Description |
|------------------------|--------------------------------------------------------------------------------------------------------------------------------------------------------------------------------------------------------------------------------------------------------|
| 6:5 (Consumer Only) | Reserved |
| 4 | Intel® High Definition Audio Disable (HDAD) — R/W. Default is 0. 0 = The Intel High Definition Audio controller is enabled. 1 = The Intel High Definition Audio controller is disabled and its PCI configuration space is not accessible. |
| 3 | SMBus Disable (SD) — R/W. Default is 0. 0 = The SMBus controller is enabled. 1 = The SMBus controller is disabled. In ICH5 and previous, this also disabled the I/O space. In ICH10, it only disables the configuration space. |
| 2 | Serial ATA Disable 1 (SAD1) — R/W. Default is 0. 0 = The SATA controller #1 (D31:F2) is enabled. 1 = The SATA controller #1 (D31:F2) is disabled. |
| 1 | Reserved |
| 0 | BIOS must set this bit to 1b. |

10.1.78 CG—Clock Gating

Offset Address: 341C–341Fh
Default Value: 00000000h

Attribute: R/W
Size: 32-bit

| Bit | Description |
|-------|-----------------------------------------------------------------------------------------------------------------------------------------------------------------------------------|
| 31 | Legacy (LPC) Dynamic Clock Gate Enable — R/W. 0 = Legacy Dynamic Clock Gating is Disabled 1 = Legacy Dynamic Clock Gating is Enabled |
| 30 | Reserved |
| 29:28 | USB UHCI Dynamic Clock Gate Enable — R/W. 0 = USB UHCI Dynamic Clock Gating is Disabled 1 = USB UHCI Dynamic Clock Gating is Enabled 0 = Reserved 1 = Reserved |
| 27 | SATA Port 3 Dynamic Clock Gate Enable — R/W. 0 = SATA Port 3 Dynamic Clock Gating is Disabled 1 = SATA Port 3 Dynamic Clock Gating is Enabled |
| 26 | SATA Port 2 Dynamic Clock Gate Enable — R/W. 0 = SATA Port 2 Dynamic Clock Gating is Disabled 1 = SATA Port 2 Dynamic Clock Gating is Enabled |
| 25 | SATA Port 1 Dynamic Clock Gate Enable — R/W. 0 = SATA Port 1 Dynamic Clock Gating is Disabled 1 = SATA Port 1 Dynamic Clock Gating is Enabled |
| 24 | SATA Port 0 Dynamic Clock Gate Enable — R/W. 0 = SATA Port 0 Dynamic Clock Gating is Disabled 1 = SATA Port 0 Dynamic Clock Gating is Enabled |



| Bit | Description |
|------|--------------------------------------------------------------------------------------------------------------------------------------------------------------------------------------------------------------------|
| 23 | LAN Static Clock Gating Enable (LANSCGE) — R/W. 0 = LAN Static Clock Gating is Disabled 1 = LAN Static Clock Gating is Enabled when the LAN Disable bit is set in the Backed Up Control RTC register. |
| 22 | High Definition Audio Dynamic Clock Gate Enable — R/W. 0 = High Definition Audio Dynamic Clock Gating is Disabled 1 = High Definition Audio Dynamic Clock Gating is Enabled |
| 21 | High Definition Audio Static Clock Gate Enable — R/W. 0 = High Definition Audio Static Clock Gating is Disabled 1 = High Definition Audio Static Clock Gating is Enabled |
| 20 | USB EHCI Static Clock Gate Enable — R/W. 0 = USB EHCI Static Clock Gating is Disabled 1 = USB EHCI Static Clock Gating is Enabled |
| 19 | USB EHCI Dynamic Clock Gate Enable — R/W. 0 = USB EHCI Dynamic Clock Gating is Disabled 1 = USB EHCI Dynamic Clock Gating is Enabled |
| 18 | SATA Port 5 Dynamic Clock Gate Enable — R/W. 0 = SATA Port 5 Dynamic Clock Gating is Disabled 1 = SATA Port 5 Dynamic Clock Gating is Enabled |
| 17 | SATA Port 4 Dynamic Clock Gate Enable — R/W. 0 = SATA Port 4 Dynamic Clock Gating is Disabled 1 = SATA Port 4 Dynamic Clock Gating is Enabled |
| 16 | PCI Dynamic Gate Enable — R/W. 0 = PCI Dynamic Gating is Disabled 1 = PCI Dynamic Gating is Enabled |
| 15:6 | Reserved |
| 5 | SMBus Clock Gating Enable (SMBCGEN) — R/W. 0 = SMBus Clock Gating is Disabled. 1 = SMBus Clock Gating is Enabled. |
| 4 | PCI Express* RX Clock Gating Enable (PRXCGEN) — R/W. 0 = AFE RX Clock Gating is Disabled 1 = AFE RX Clock Gating is Enabled whenever all PCIe ports RX are in squelch |
| 3 | DMI and PCI Express* RX Dynamic Clock Gate Enable — R/W. 0 = DMI and PCI Express root port RX Dynamic Clock Gating is Disabled 1 = DMI and PCI Express root port RX Dynamic Clock Gating is Enabled |
| 2 | PCI Express TX Dynamic Clock Gate Enable — R/W. 0 = PCI Express root port TX Dynamic Clock Gating is Disabled 1 = PCI Express root port TX Dynamic Clock Gating is Enabled |
| 1 | DMI TX Dynamic Clock Gate Enable — R/W. 0 = DMI TX Dynamic Clock Gating is Disabled 1 = DMI TX Dynamic Clock Gating is Enabled |
| 0 | PCI Express Root Port Static Clock Gate Enable — R/W. 0 = PCI Express root port Static Clock Gating is Disabled 1 = PCI Express root port Static Clock Gating is Enabled |



10.1.83 CIR10—Chipset Initialization Register 10

Offset Address: 352C–352Fh Attribute: R/W
 Default Value: 0008C008h Size: 32-bit

| Bit | Description |
|-------|------------------------------------------------------------------|
| 32:18 | Reserved |
| 17:16 | CIR10 Field 1 — R/W. BIOS must program this field to 11b. |
| 15:0 | Reserved |

10.1.84 MAP—Remap Control Register

Offset Address: 35F0–35F3h Attribute: R/WO
 Default Value: 00000000h Size: 32-bit

| Bit | Description |
|-------|--------------------------------------------------------------------------------------------------------------------------------------------------------------------------------------------------------------------------------------------------------------------------------------------------------------------------------------------------------------------------------------------|
| 31:01 | Reserved |
| 0 | <p>UHCI Controller # 6 Remap — R/WO</p> <p>1 = UHCI Controller #6 is mapped to Device 29 Function 3 0 = UHCI Controller #6 is mapped to Device 26 Function 2</p> <p>Note: When this bit is set, SW should reprogram the HCSPARAMS register (Section 17.2.1.3) to reflect the correct value for N_CC (bits 15:12) and N_Ports (bits 3:0) in each EHCI controller.</p> |

§ §

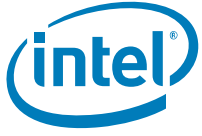

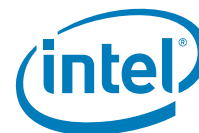

11 PCI-to-PCI Bridge Registers (D30:F0)

The ICH10 PCI bridge resides in PCI Device 30, Function 0 on bus #0. This implements the buffering and control logic between PCI and the backbone. The arbitration for the PCI bus is handled by this PCI device.

11.1 PCI Configuration Registers (D30:F0)

Note: Address locations that are not shown should be treated as Reserved (see [Section 9.2](#) for details).

Table 11-1. PCI Bridge Register Address Map (PCI-PCI—D30:F0) (Sheet 1 of 2)

| Offset | Mnemonic | Register Name | Default | Type |
|---------|---------------------|-----------------------------------------|--------------------------|---------------|
| 00h–01h | VID | Vendor Identification | 8086h | RO |
| 02h–03h | DID | Device Identification | See register description | RO |
| 04h–05h | PCICMD | PCI Command | 0000h | R/W, RO |
| 06h–07h | PSTS | PCI Status | 0010h | R/WC, RO |
| 08h | RID | Revision Identification | See register description | RO |
| 09h–0Bh | CC | Class Code | 060401h | RO |
| 0Dh | PMLT | Primary Master Latency Timer | 00h | RO |
| 0Eh | HEADTYP | Header Type | 01h | RO |
| 18h–1Ah | BNUM | Bus Number | 000000h | RO |
| 1Bh | SMLT | Secondary Master Latency Timer | 00h | R/W |
| 1Ch–1Dh | IOBASE_LIMIT | I/O Base and Limit | 0000h | R/W, RO |
| 1Eh–1Fh | SECSTS | Secondary Status | 0280h | R/WC, RO |
| 20h–23h | MEMBASE_LIMIT | Memory Base and Limit | 00000000h | R/W |
| 24h–27h | PREF_MEM_BASE_LIMIT | Prefetchable Memory Base and Limit | 00010001h | R/W, RO |
| 28h–2Bh | PMBU32 | Prefetchable Memory Upper 32 Bits | 00000000h | R/W |
| 2Ch–2Fh | PMLU32 | Prefetchable Memory Limit Upper 32 Bits | 00000000h | R/W |
| 34h | CAPP | Capability List Pointer | 50h | RO |
| 3Ch–3Dh | INTR | Interrupt Information | 0000h | R/W, RO |
| 3Eh–3Fh | BCTRL | Bridge Control | 0000h | R/WC, RO, R/W |
| 40h–41h | SPDH | Secondary PCI Device Hiding | 0000h | R/W, RO |
| 44h–47h | DTC | Delayed Transaction Control | 00000000h | R/W |
| 48h–4Bh | BPS | Bridge Proprietary Status | 00000000h | R/WC, RO |

| Bit | Description |
|-----|-------------------------------------------------------------------------------------------------------------------------------------------------------------------------------------------------------------------------------------------------------------------------------------------------------------------------------------------------------------------------------------------------------------------------------------------------------------------------------------------------------------------------------------------------------------------------------------------------------------------------------------------------------------------------------------------------------------------------------------------------------------------------------------------------------------------------------------------------------------------------------------------------------------------------------------------------------------------------------------------------------------------------------------------------------------------------------------------------------------------------------------------------------------------------------------------------------------------------------------------------------------------------------------------------------------------------------------------------------------------------------------------------------------------------------------------------------------------------------------------------------------------------------------------------------------------------------------------------------------------------------------------------------------------------------------------------------------------------------------------------------|
| 15 | <p>Detected Parity Error (DPE) — R/WC.</p> <p>0 = Parity error Not detected. 1 = Indicates that the ICH10 detected a parity error on the internal backbone. This bit gets set even if the Parity Error Response bit (D30:F0:04 bit 6) is not set.</p> |
| 14 | <p>Signaled System Error (SSE) — R/WC. Several internal and external sources of the bridge can cause SERR#. The first class of errors is parity errors related to the backbone. The PCI bridge captures generic data parity errors (errors it finds on the backbone) as well as errors returned on backbone cycles where the bridge was the master. If either of these two conditions is met, and the primary side of the bridge is enabled for parity error response, SERR# will be captured as shown below.</p> <div data-bbox="597 632 1269 768" style="border: 1px solid black; padding: 5px; margin-bottom: 10px;"> </div> <p>As with the backbone, the PCI bus captures the same sets of errors. The PCI bridge captures generic data parity errors (errors it finds on PCI) as well as errors returned on PCI cycles where the bridge was the master. If either of these two conditions is met, and the secondary side of the bridge is enabled for parity error response, SERR# will be captured as shown below.</p> <div data-bbox="623 909 1245 1092" style="border: 1px solid black; padding: 5px; margin-bottom: 10px;"> </div> <p>The final class of errors is system bus errors. There are three status bits associated with system bus errors, each with a corresponding enable. The diagram capturing this is shown below.</p> <div data-bbox="607 1178 1261 1446" style="border: 1px solid black; padding: 5px; margin-bottom: 10px;"> </div> <p>After checking for the three above classes of errors, an SERR# is generated, and PSTS.SSE logs the generation of SERR#, if CMD.SEE (D30:F0:04, bit 8) is set, as shown below.</p> <div data-bbox="591 1537 1278 1740" style="border: 1px solid black; padding: 5px;"> </div> |
| 13 | <p>Received Master Abort (RMA) — R/WC.</p> <p>0 = No master abort received. 1 = Set when the bridge receives a master abort status from the backbone.</p> |



11.1.15 PMBU32—Prefetchable Memory Base Upper 32 Bits Register (PCI-PCI—D30:F0)

Offset Address: 28h–2Bh Attribute: R/W
Default Value: 00000000h Size: 32 bits

| Bit | Description |
|------|-------------------------------------------------------------------------------------------------------------|
| 31:0 | Prefetchable Memory Base Upper Portion (PMBU) — R/W. Upper 32-bits of the prefetchable address base. |

11.1.16 PMLU32—Prefetchable Memory Limit Upper 32 Bits Register (PCI-PCI—D30:F0)

Offset Address: 2C–2Fh Attribute: R/W
Default Value: 00000000h Size: 32 bits

| Bit | Description |
|------|---------------------------------------------------------------------------------------------------------------|
| 31:0 | Prefetchable Memory Limit Upper Portion (PMLU) — R/W. Upper 32-bits of the prefetchable address limit. |

11.1.17 CAPP—Capability List Pointer Register (PCI-PCI—D30:F0)

Offset Address: 34h Attribute: RO
Default Value: 50h Size: 8 bits

| Bit | Description |
|-----|--------------------------------------------------------------------------------------------------------------------------------------------------------------|
| 7:0 | Capabilities Pointer (PTR) — RO. This field indicates that the pointer for the first entry in the capabilities list is at 50h in configuration space. |

11.1.18 INTR—Interrupt Information Register (PCI-PCI—D30:F0)

Offset Address: 3Ch–3Dh Attribute: R/W, RO
Default Value: 0000h Size: 16 bits

| Bit | Description |
|------|----------------------------------------------------------------------------------------------------------------------------------------------------------------------------------------------------------------------------------------------------------------------------------------------------------------|
| 15:8 | Interrupt Pin (IPIN) — RO. The PCI bridge does not assert an interrupt. |
| 7:0 | Interrupt Line (ILINE) — R/W. Software written value to indicate which interrupt line (vector) the interrupt is connected to. No hardware action is taken on this register. Since the bridge does not generate an interrupt, BIOS should program this value to FFh as per the PCI bridge specification. |



11.1.19 BCTRL—Bridge Control Register (PCI-PCI—D30:F0)

Offset Address: 3Eh–3Fh
Default Value: 0000h

Attribute: R/WC, RO, R/W
Size: 16 bits

| Bit | Description |
|-------|-------------------------------------------------------------------------------------------------------------------------------------------------------------------------------------------------------------------------------------------------------------------------------------------------------------------------------------------------------------------------------------------------------------------------------------------------------------------------------------------------------------------------------------------------------------------------------------------------------------------------------------------------------------------|
| 15:12 | Reserved |
| 11 | Discard Timer SERR# Enable (DTE) — R/W. This bit controls the generation of SERR# on the primary interface in response to the DTS bit being set: 0 = Do not generate SERR# on a secondary timer discard 1 = Generate SERR# in response to a secondary timer discard |
| 10 | Discard Timer Status (DTS) — R/WC. This bit is set to 1 when the secondary discard timer (see the SDT bit below) expires for a delayed transaction in the hard state. |
| 9 | Secondary Discard Timer (SDT) — R/W. This bit sets the maximum number of PCI clock cycles that the Intel® ICH10 waits for an initiator on PCI to repeat a delayed transaction request. The counter starts once the delayed transaction data is has been returned by the system and is in a buffer in the ICH10 PCI bridge. If the master has not repeated the transaction at least once before the counter expires, the ICH10 PCI bridge discards the transaction from its queue. 0 = The PCI master timeout value is between 2^{15} and 2^{16} PCI clocks 1 = The PCI master timeout value is between 2^{10} and 2^{11} PCI clocks |
| 8 | Primary Discard Timer (PDT) — R/W. This bit is R/W for software compatibility only. |
| 7 | Fast Back to Back Enable (FBE) — RO. Hardwired to 0. The PCI logic will not generate fast back-to-back cycles on the PCI bus. |
| 6 | Secondary Bus Reset (SBR) — R/W. This bit controls PCIRST# assertion on PCI. 0 = Bridge de-asserts PCIRST# 1 = Bridge asserts PCIRST#. When PCIRST# is asserted, the delayed transaction buffers, posting buffers, and the PCI bus are initialized back to reset conditions. The rest of the part and the configuration registers are not affected. |
| 5 | Master Abort Mode (MAM) — R/W. This bit controls the ICH10 PCI bridge's behavior when a master abort occurs: Master Abort on (G)MCH/ICH10 Interconnect (DMI): 0 = Bridge asserts TRDY# on PCI. It drives all 1s for reads, and discards data on writes. 1 = Bridge returns a target abort on PCI. Master Abort PCI (non-locked cycles): 0 = Normal completion status will be returned on the (G)MCH/ICH10 interconnect. 1 = Target abort completion status will be returned on the (G)MCH/ICH10 interconnect. NOTE: All locked reads will return a completer abort completion status on the (G)MCH/ICH10 interconnect. |
| 4 | VGA 16-Bit Decode (V16D) — R/W. This bit enables the ICH10 PCI bridge to provide 16-bits decoding of VGA I/O address precluding the decode of VGA alias addresses every 1 KB. This bit requires the VGAE bit in this register be set. |



| Bit | Description |
|-----|--------------------------------------------------------------------------------------------------------------------------------------------------------------------------------------------------------------------------------------------------------------|
| 2 | Memory Read Multiple Prefetch Disable (MRMPD) — R/W. 0 = MRM commands will fetch multiple cache lines as defined by the prefetch algorithm. 1 = Memory read multiple (MRM) commands will fetch only up to a single, 64-byte aligned cache line. |
| 1 | Memory Read Line Prefetch Disable (MRLPD) — R/W. 0 = MRL commands will fetch multiple cache lines as defined by the prefetch algorithm. 1 = Memory read line (MRL) commands will fetch only up to a single, 64-byte aligned cache line. |
| 0 | Memory Read Prefetch Disable (MRPD) — R/W. 0 = MR commands will fetch up to a 64-byte aligned cache line. 1 = Memory read (MR) commands will fetch only a single DW. |

11.1.22 BPS—Bridge Proprietary Status Register (PCI-PCI—D30:F0)

Offset Address: 48h–4Bh
Default Value: 00000000h

Attribute: R/WC, RO
Size: 32 bits

| Bit | Description |
|-------|----------------------------------------------------------------------------------------------------------------------------------------------------------------------------------------------------------------------------------------------------------------------------------------------------------------------------------------------------------------------------------------------------------------------------------------------------------------------------------------------------------------------------------------------------------------|
| 31:17 | Reserved |
| 16 | PERR# Assertion Detected (PAD) — R/WC. This bit is set by hardware whenever the PERR# pin is asserted on the rising edge of PCI clock. This includes cases in which the chipset is the agent driving PERR#. It remains asserted until cleared by software writing a 1 to this location. When enabled by the PERR#-to-SERR# Enable bit (in the Bridge Policy Configuration register), a 1 in this bit can generate an internal SERR# and be a source for the NMI logic. This bit can be used by software to determine the source of a system problem. |
| 15:7 | Reserved |
| 6:4 | Number of Pending Transactions (NPT) — RO. This field indicates to debug software how many transactions are in the pending queue. Possible values are: 000 = No pending transaction 001 = 1 pending transaction 010 = 2 pending transactions 011 = 3 pending transactions 100 = 4 pending transactions 101 = 5 pending transactions 110 - 111 = Reserved NOTE: This field is not valid if DTC.MDT (offset 44h:bits 7:6) is any value other than '00'. |
| 3:2 | Reserved |
| 1:0 | Number of Active Transactions (NAT) — RO. This field indicates to debug software how many transactions are in the active queue. Possible values are: 00 = No active transactions 01 = 1 active transaction 10 = 2 active transactions 11 = Reserved |



| Bit | Description |
|-----|--------------------------------------------------------------------------------------------------------------------------------------------------------------------------------------------------------------------------------------------------------------------------------------------------|
| 2 | Peer Decode Enable (PDE) — R/W. 0 = The PCI bridge assumes that all memory cycles target main memory, and all I/O cycles are not claimed. 1 = The PCI bridge will perform peer decode on any memory or I/O cycle from PCI that falls outside of the memory and I/O window registers |
| 1 | Reserved |
| 0 | Received Target Abort SERR# Enable (RTAE) — R/W. When set, the PCI bridge will report SERR# when PSTS.RTA (D30:F0:06 bit 12) or SSTS.RTA (D30:F0:1E bit 12) are set, and CMD.SEE (D30:F0:04 bit 8) is set. |

11.1.24 SVCAP—Subsystem Vendor Capability Register (PCI-PCI—D30:F0)

Offset Address: 50h–51h
Default Value: 000Dh

Attribute: RO
Size: 16 bits

| Bit | Description |
|------|-------------------------------------------------------------------------------------------------------------------|
| 15:8 | Next Capability (NEXT) — RO. Value of 00h indicates this is the last item in the list. |
| 7:0 | Capability Identifier (CID) — RO. Value of 0Dh indicates this is a PCI bridge subsystem vendor capability. |

11.1.25 SVID—Subsystem Vendor IDs Register (PCI-PCI—D30:F0)

Offset Address: 54h–57h
Default Value: 00000000h

Attribute: R/WO
Size: 32 bits

| Bit | Description |
|-------|------------------------------------------------------------------------------------------------------------------------------------------------------------------------------------------------------------|
| 31:16 | Subsystem Identifier (SID) — R/WO. This field indicates the subsystem as identified by the vendor. This field is write once and is locked down until a bridge reset occurs (not the PCI bus reset). |
| 15:0 | Subsystem Vendor Identifier (SVID) — R/WO. This field indicates the manufacturer of the subsystem. This field is write once and is locked down until a bridge reset occurs (not the PCI bus reset). |

§ §

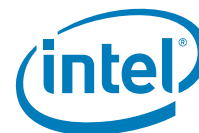

12 Gigabit LAN Configuration Registers

12.1 Gigabit LAN Configuration Registers (Gigabit LAN — D25:F0)

Note: Register address locations that are not shown in Table 12-1 should be treated as Reserved.

Table 12-1. Gigabit LAN Configuration Registers Address Map (Gigabit LAN —D25:F0) (Sheet 1 of 2)

| Offset | Mnemonic | Register Name | Default | Type |
|---------|----------|-----------------------------------------|--------------------------|---------------|
| 00h–01h | VID | Vendor Identification | 8086h | RO |
| 02h–03h | DID | Device Identification | See register description | RO |
| 04h–05h | PCICMD | PCI Command | 0000h | R/W, RO |
| 06h–07h | PCISTS | PCI Status | 0010h | R/WC, RO |
| 08h | RID | Revision Identification | See register description | RO |
| 09h–0Bh | CC | Class Code | 020000h | RO |
| 0Ch | CLS | Cache Line Size | 00h | R/W |
| 0Dh | PLT | Primary Latency Timer | 00h | RO |
| 0Eh | HEADTYP | Header Type | 00h | RO |
| 10h–13h | MBARA | Memory Base Address A | 00000000h | R/W, RO |
| 14h–17h | MBARB | Memory Base Address B | 00000000h | R/W, RO |
| 18h–1Bh | MBARC | Memory Base Address C | 00000001h | R/W, RO |
| 2Ch–2Dh | SID | Subsystem ID | See register description | RO |
| 2Eh–2Fh | SVID | Subsystem Vendor ID | See register description | RO |
| 30h–33h | ERBA | Expansion ROM Base Address | See register description | RO |
| 34h | CAPP | Capabilities List Pointer | C8h | RO |
| 3Ch–3Dh | INTR | Interrupt Information | See register description | R/W, RO |
| 3Eh | MLMG | Maximum Latency/Minimum Grant | 00h | RO |
| C8h–C9h | CLIST1 | Capabilities List 1 | D001h | RO |
| CAh–CBh | PMC | PCI Power Management Capability | See register description | RO |
| CCh–CDh | PMCS | PCI Power Management Control and Status | See register description | R/WC, R/W, RO |



Table 12-1. Gigabit LAN Configuration Registers Address Map (Gigabit LAN —D25:F0) (Sheet 2 of 2)

| Offset | Mnemonic | Register Name | Default | Type |
|---------|----------|--------------------------------------------------|--------------------------|----------|
| CFh | DR | Data Register | See register description | RO |
| D0h–D1h | CLIST2 | Capabilities List 2 | E005h | R/WO, RO |
| D2h–D3h | MCTL | Message Control | 0080h | R/W, RO |
| D4h–D7h | MADDL | Message Address Low | See register description | R/W |
| D8h–DBh | MADDH | Message Address High | See register description | R/W |
| DCh–DDh | MDAT | Message Data | See register description | R/W |
| E0h–E1h | FLRCAP | Function Level Reset Capability | 0009h | RO |
| E2h–E3h | FLRCLV | Function Level Reset Capability Length and Value | See register description | R/WO, RO |
| E4h–E5h | DEVCTRL | Device Control | 0000h | R/W, RO |

12.1.1 VID—Vendor Identification Register (Gigabit LAN—D25:F0)

Address Offset: 00h–01h Attribute: RO
 Default Value: 8086h Size: 16 bits

| Bit | Description |
|------|----------------------------------------------------------------------------------------------------------------------------------------------------------------------------------------------------------------------------------------------|
| 15:0 | Vendor ID — RO. This is a 16-bit value assigned to Intel. The field may be auto-loaded from the NVM at address 0Eh during init time depending on the "Load Vendor/Device ID" bit field in NVM word 0Ah with a default value of 8086h. |

12.1.2 DID—Device Identification Register (Gigabit LAN—D25:F0)

Address Offset: 02h–03h Attribute: RO
 Default Value: See bit description Size: 16 bits

| Bit | Description |
|------|------------------------------------------------------------------------------------------------------------------------------------------------------------------------------------------------------------------------------------------------------|
| 15:0 | Device ID — RO. This is a 16-bit value assigned to the Intel® ICH10 Gigabit LAN controller. The field may be auto-loaded from the NVM word 0Dh during initialization time depending on the "Load Vendor/Device ID" bit field in NVM word 0Ah. |



12.1.3 PCICMD—PCI Command Register (Gigabit LAN—D25:F0)

Address Offset: 04h–05h
Default Value: 0000h

Attribute: R/W, RO
Size: 16 bits

| Bit | Description |
|-------|-----------------------------------------------------------------------------------------------------------------------------------------------------------------------------------------------------------------------------------------------------------------------------------------------------------------------------------------------------------------------------------------------------------------------------------------------------------------------------------------------------------------------------------------------------------------------------------------------|
| 15:11 | Reserved |
| 10 | <p>Interrupt Disable — R/W. This disables pin-based INTx# interrupts on enabled Hot-Plug and power management events. This bit has no effect on MSI operation.</p> <p>0 = Internal INTx# messages are generated if there is an interrupt for Hot-Plug or power management and MSI is not enabled.</p> <p>1 = Internal INTx# messages will not be generated.</p> <p>This bit does not affect interrupt forwarding from devices connected to the root port. Assert_INTx and Deassert_INTx messages will still be forwarded to the internal interrupt controllers if this bit is set.</p> |
| 9 | Fast Back to Back Enable (FBE) — RO. Hardwired to 0. |
| 8 | <p>SERR# Enable (SEE) — R/W.</p> <p>0 = Disable</p> <p>1 = Enables the Gb LAN controller to generate an SERR# message when PSTS.SSE is set.</p> |
| 7 | Wait Cycle Control (WCC) — RO. Hardwired to 0. |
| 6 | <p>Parity Error Response (PER) — R/W.</p> <p>0 = Disable.</p> <p>1 = Indicates that the device is capable of reporting parity errors as a master on the backbone.</p> |
| 5 | Palette Snoop Enable (PSE) — RO. Hardwired to 0. |
| 4 | Postable Memory Write Enable (PMWE) — RO. Hardwired to 0. |
| 3 | Special Cycle Enable (SCE) — RO. Hardwired to 0. |
| 2 | <p>Bus Master Enable (BME) — R/W.</p> <p>0 = Disable. All cycles from the device are master aborted</p> <p>1 = Enable. Allows the root port to forward cycles onto the backbone from a Gigabit LAN* device.</p> |
| 1 | <p>Memory Space Enable (MSE) — R/W.</p> <p>0 = Disable. Memory cycles within the range specified by the memory base and limit registers are master aborted on the backbone.</p> <p>1 = Enable. Allows memory cycles within the range specified by the memory base and limit registers can be forwarded to the Gigabit LAN device.</p> |
| 0 | <p>I/O Space Enable (IOSE) — R/W. This bit controls access to the I/O space registers.</p> <p>0 = Disable. I/O cycles within the range specified by the I/O base and limit registers are master aborted on the backbone.</p> <p>1 = Enable. Allows I/O cycles within the range specified by the I/O base and limit registers can be forwarded to the Gigabit LAN device.</p> |



12.1.4 PCISTS—PCI Status Register (Gigabit LAN—D25:F0)

Address Offset: 06h–07h
Default Value: 0010h

Attribute: R/WC, RO
Size: 16 bits

| Bit | Description |
|------|--------------------------------------------------------------------------------------------------------------------------------------------------------------------------------------------------------------------------------------------------------------------------------------------------------------------------------------------------------------------------------------|
| 15 | Detected Parity Error (DPE) — R/WC. 0 = No parity error detected. 1 = Set when the Gb LAN controller receives a command or data from the backbone with a parity error. This is set even if PCIMD.PER (D25:F0, bit 6) is not set. |
| 14 | Signaled System Error (SSE) — R/WC. 0 = No system error signaled. 1 = Set when the Gb LAN controller signals a system error to the internal SERR# logic. |
| 13 | Received Master Abort (RMA) — R/WC. 0 = Root port has not received a completion with unsupported request status from the backbone. 1 = Set when the Gb LAN controller receives a completion with unsupported request status from the backbone. |
| 12 | Received Target Abort (RTA) — R/WC. 0 = Root port has not received a completion with completer abort from the backbone. 1 = Set when the Gb LAN controller receives a completion with completer abort from the backbone. |
| 11 | Signaled Target Abort (STA) — R/WC. 0 = No target abort received. 1 = Set whenever the Gb LAN controller forwards a target abort received from the downstream device onto the backbone. |
| 10:9 | DEVSEL# Timing Status (DEV_STS) — RO. Hardwired to 0. |
| 8 | Master Data Parity Error Detected (DPED) — R/WC. 0 = No data parity error received. 1 = Set when the Gb LAN Controller receives a completion with a data parity error on the backbone and PCIMD.PER (D25:F0, bit 6) is set. |
| 7 | Fast Back to Back Capable (FB2BC) — RO. Hardwired to 0. |
| 6 | Reserved |
| 5 | 66 MHz Capable — RO. Hardwired to 0. |
| 4 | Capabilities List — RO. Hardwired to 1. Indicates the presence of a capabilities list. |
| 3 | Interrupt Status — RO. Indicates status of Hot-Plug and power management interrupts on the root port that result in INTx# message generation. 0 = Interrupt is deasserted. 1 = Interrupt is asserted. This bit is not set if MSI is enabled. If MSI is not enabled, this bit is set regardless of the state of PCICMD.Interrupt Disable bit (D25:F0:04h:bit 10). |
| 2:0 | Reserved |



12.1.10 MBARA—Memory Base Address Register A (Gigabit LAN—D25:F0)

Address Offset: 10h–13h Attribute: R/W, RO
Default Value: 00000000h Size: 32 bits

The internal CSR registers and memories are accessed as direct memory mapped offsets from the base address register. SW may only access whole DWord at a time.

| Bit | Description |
|-------|------------------------------------------------------------------------------------------------------|
| 31:17 | Base Address (BA) — R/W. Software programs this field with the base address of this region. |
| 16:4 | Memory Size (MSIZE) — R/W. Memory size is 128 KB. |
| 3 | Prefetchable Memory (PM) — RO. The GbE LAN controller does not implement prefetchable memory. |
| 2:1 | Memory Type (MT) — RO. Set to 00b indicating a 32 bit BAR. |
| 0 | Memory / IO Space (MIOS) — RO. Set to '0' indicating a Memory Space BAR. |

12.1.11 MBARB—Memory Base Address Register B (Gigabit LAN—D25:F0)

Address Offset: 14h–17h Attribute: R/W, RO
Default Value: 00000000h Size: 32 bits

The internal registers that are used to access the LAN Space in the External FLASH device. Access to these registers are direct memory mapped offsets from the base address register. Software may only access a DWord at a time.

| Bit | Description |
|-------|-----------------------------------------------------------------------------------------------------|
| 31:12 | Base Address (BA) — R/W. Software programs this field with the base address of this region. |
| 11:4 | Memory Size (MSIZE) — R/W. Memory size is 4 KB. |
| 3 | Prefetchable Memory (PM) — RO. The Gb LAN controller does not implement prefetchable memory. |
| 2:1 | Memory Type (MT) — RO. Set to 00b indicating a 32 bit BAR. |
| 0 | Memory / IO Space (MIOS) — RO. Set to '0' indicating a Memory Space BAR. |

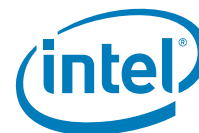

12.1.20 PMC—PCI Power Management Capabilities Register (Gigabit LAN—D25:F0)

Address Offset: CAh–CBh Attribute: RO
 Default Value: See bit descriptions Size: 16 bits
 Function Level Reset: No (Bits 15:11 only)

| Bit | Description | | | | | | | | | | | | |
|--------------------|---------------------------------------------------------------------------------------------------------------------------------------------------------------------------------------------------------------------------------------------------------------------------------------------------------------------------------------------------------------------------------------------------------------------------------------------------------------------------------------------------------------------------------------------------------------------------------------------------------------------------------------------------|-----------|----------|-------|----------|----------------------|-------|--------------------|---------------------|--------|--------------------|-----------------------------|--------|
| 15:11 | <p>PME_Support (PMES) — RO. This five-bit field indicates the power states in which the function may assert PME#. It depend on PM Ena and AUX-PWR bits in word 0Ah in the NVM:</p> <table border="1"> <thead> <tr> <th>Condition</th> <th>Function</th> <th>Value</th> </tr> </thead> <tbody> <tr> <td>PM Ena=0</td> <td>No PME at all states</td> <td>0000b</td> </tr> <tr> <td>PM Ena & AUX-PWR=0</td> <td>PME at D0 and D3hot</td> <td>01001b</td> </tr> <tr> <td>PM Ena & AUX-PWR=1</td> <td>PME at D0, D3hot and D3cold</td> <td>11001b</td> </tr> </tbody> </table> <p>These bits are not reset by Function Level Reset.</p> | Condition | Function | Value | PM Ena=0 | No PME at all states | 0000b | PM Ena & AUX-PWR=0 | PME at D0 and D3hot | 01001b | PM Ena & AUX-PWR=1 | PME at D0, D3hot and D3cold | 11001b |
| Condition | Function | Value | | | | | | | | | | | |
| PM Ena=0 | No PME at all states | 0000b | | | | | | | | | | | |
| PM Ena & AUX-PWR=0 | PME at D0 and D3hot | 01001b | | | | | | | | | | | |
| PM Ena & AUX-PWR=1 | PME at D0, D3hot and D3cold | 11001b | | | | | | | | | | | |
| 10 | D2_Support (D2S) — RO. The D2 state is not supported. | | | | | | | | | | | | |
| 9 | D1_Support (D1S) — RO. The D1 state is not supported. | | | | | | | | | | | | |
| 8:6 | Aux_Current (AC) — RO. Required current defined in the Data Register. | | | | | | | | | | | | |
| 5 | Device Specific Initialization (DSI) — RO. Set to '1'. The GbE LAN Controller requires its device driver to be executed following transition to the D0 un-initialized state. | | | | | | | | | | | | |
| 4 | Reserved | | | | | | | | | | | | |
| 3 | PME Clock (PMEC) — RO. Hardwired to '0'. | | | | | | | | | | | | |
| 2:0 | Version (VS) — RO. Hardwired to 010b to indicate support for <i>Revision 1.1 of the PCI Power Management Specification</i> . | | | | | | | | | | | | |

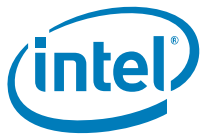

12.1.21 PMCS—PCI Power Management Control and Status Register (Gigabit LAN—D25:F0)

Address Offset: CCh–CDh Attribute: R/WC, R/W, RO
 Default Value: See bit description Size: 16 bits
 Function Level Reset: No (Bit 8 only)

| Bit | Description |
|-------|------------------------------------------------------------------------------------------------------------------------------------------------------------------------------------------------------------------------------------------------------------------------------------------------------------------------------------------------------------------------------------------------------------------------------------------------------------------------------------------------------------------------------------------------------|
| 15 | PME Status (PMES) — R/WC. This bit is set to '1' when the function detects a wake-up event independent of the state of the PMEE bit. Writing a "1" will clear this bit. |
| 14:13 | Data Scale (DSC) — R/W. This field indicates the scaling factor to be used when interpreting the value of the Data register. For the GbE LAN and common functions this field equals 01b (indicating 0.1 watt units) if the PM is enabled in the NVM, and the Data_Select field is set to 0, 3, 4, 7, (or 8 for Function 0). Else it equals 00b. For the manageability functions this field equals 10b (indicating 0.01 watt units) if the PM is enabled in the NVM, and the Data_Select field is set to 0, 3, 4, 7. Else it equals 00b. |
| 12:9 | Data Select (DSL) — R/W. This four-bit field is used to select which data is to be reported through the Data register (offset CFh) and Data_Scale field. These bits are writeable only when the Power Management is enabled via NVM. 0h = D0 Power Consumption 3h = D3 Power Consumption 4h = D0 Power Dissipation 7h = D3 Power Dissipation 8h = Common Power All other values are reserved. |
| 8 | PME Enable (PMEE) — R/W. If Power Management is enabled in the NVM, writing a '1' to this register will enable Wakeup. If Power Management is disabled in the NVM, writing a "1" to this bit has no affect, and will not set the bit to "1". This bit is not reset by Function Level Reset. |
| 7:2 | Reserved - Returns a value of '000000'. |
| 1:0 | Power State (PS) — R/W. This field is used both to determine the current power state of the GbE LAN Controller and to set a new power state. The values are: 00 = D0 state (default) 01 = Ignored 10 = Ignored 11 = D3 state (Power Management must be enables in the NVM or this cycle will be ignored). |

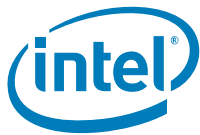

12.1.25 MADDL—Message Address Low Register (Gigabit LAN—D25:F0)

Address Offset: D4h–D7h Attribute: R/W
Default Value: See bit description Size: 32 bits

| Bit | Description |
|------|--------------------------------------------------------------------------------------------------------------------------------------------------------------------------------------------------------------------------------------|
| 31:0 | Message Address Low (MADDL) — R/W. Written by the system to indicate the lower 32 bits of the address to use for the MSI memory write transaction. The lower two bits will always return 0 regardless of the write operation. |

12.1.26 MADDH—Message Address High Register (Gigabit LAN—D25:F0)

Address Offset: D8h–DBh Attribute: R/W
Default Value: See bit description Size: 32 bits

| Bit | Description |
|------|------------------------------------------------------------------------------------------------------------------------------------------------------------|
| 31:0 | Message Address High (MADDH) — R/W. Written by the system to indicate the upper 32 bits of the address to use for the MSI memory write transaction. |

12.1.27 MDAT—Message Data Register (Gigabit LAN—D25:F0)

Address Offset: DCh–DDh Attribute: R/W
Default Value: See bit description Size: 16 bits

| Bit | Description |
|------|-----------------------------------------------------------------------------------------------------------------------------------------------------------------------------------------------------------------|
| 31:0 | Message Data (MDAT) — R/W. Written by the system to indicate the lower 16 bits of the data written in the MSI memory write DWord transaction. The upper 16 bits of the transaction are written as 0000h. |

12.1.28 FLRCAP—Function Level Reset Capability (Gigabit LAN—D25:F0)

Address Offset: E0h–E1h Attribute: RO
Default Value: 0009h Size: 16 bits

| Bit | Description |
|------|------------------------------------------------------------------------------------------------------------------------------------------------------------------------------|
| 15:8 | Next Pointer — RO. This field provides an offset to the next capability item in the capability list. The value of 00h indicates the last item in the list. |
| 7:0 | Capability ID — RO. The value of this field depends on the FLRCSSSEL bit. 13h = If FLRCSSSEL = 0 09h = If FLRCSSSEL = 1, indicating vendor specific capability. |

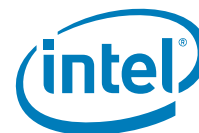

12.1.29 FLRCLV—Function Level Reset Capability Length and Version (Gigabit LAN—D25:F0)

Address Offset: E2h–E3h Attribute: R/WO, RO
 Default Value: See Description. Size: 16 bits
 Function Level Reset: No (Bits 9:8 Only When FLRCSSEL = 0)

When FLRCSSEL = 0, this register is defined as follows:

| Bit | Description |
|-------|---------------------------------------------------------------------------------------------------------------------------------------------------------------------------------------------------------------------|
| 15:10 | Reserved. |
| 9 | Function Level Reset Capability — R/WO. 1 = Support for Function Level Reset. This bit is not reset by Function Level Reset. |
| 8 | TXP Capability — R/WO. 1 = Indicates support for the Transactions Pending (TXP) bit. TXP must be supported if FLR is supported. |
| 7:0 | Capability Length — RO. The value of this field indicates the number of bytes of the vendor specific capability as require by the PCI spec. It has the value of 06h for the Function Level Reset capability. |

When FLRCSSEL = 1, this register is defined as follows:

| Bit | Description |
|-------|---------------------------------------------------------------------------------------------------------------------------------------------------------------------------------------------------------------------|
| 15:12 | Vendor Specific Capability ID — RO. A value of 2h in this field identifies this capability as Function Level Reset. |
| 11:8 | Capability Version — RO. The value of this field indicates the version of the Function Level Reset Capability. Default is 0h. |
| 7:0 | Capability Length — RO. The value of this field indicates the number of bytes of the vendor specific capability as require by the PCI spec. It has the value of 06h for the Function Level Reset capability. |

12.1.30 DEVCTRL—Device Control (Gigabit LAN—D25:F0)

Address Offset: E4-E5h Attribute: R/W, RO
 Default Value: 0000h Size: 16 bits

| Bit | Description |
|------|-------------------------------------------------------------------------------------------------------------------------------------------------------------------------------------------------------------------------------------------------------------------------|
| 15:9 | Reserved. |
| 8 | Transactions Pending (TXP) — R/W. 1 = Indicates the controller has issued Non-Posted requests which have not been completed. 0 = Indicates that completions for all Non-Posted requests have been received. |
| 7:1 | Reserved |
| 0 | Initiate Function Level Reset — RO. This bit is used to initiate an FLT transition. A write of '1' initiates the transition. Since hardware must not respond to any cycles until Function Level Reset completion, the value read by software from this bit is 0. |



12.2.3 LDCR2—LAN Device Control Register 2 (Gigabit LAN Memory Mapped Base Address Register)

Address Offset: MBARA + 18h Attribute: R/W
 Default Value: 01500000h Size: 32 bits

| Bit | Description |
|-------|------------------------------------------------------------------------------------------------------------------------------------------------------------------------------------------------------------------|
| 31:21 | Reserved |
| 20 | LAN PHY Power Down Enable (LPPDE) — R/W. When set, enables the PHY to enter a low-power state when the LAN controller is at the DMoff / D3 or Dr and no WoL. This bit is loaded from word 13h in the NVM. |
| 19 | LDCR2 Field 1 — R/W. This bit is loaded from word 13h in the NVM. |
| 19:0 | Reserved |

12.2.4 LDCR4—LAN Device Control Register 4 (Gigabit LAN Memory Mapped Base Address Register)

Address Offset: MBARA + 20h Attribute: R/W
 Default Value: 1000xxxxh Size: 32 bits

| Bit | Description |
|------|------------------------------|
| 31:0 | BIOS may program this field. |

12.2.5 LDR5—LAN Device Control Register 5 (Gigabit LAN Memory Mapped Base Address Register)

Address Offset: MBARA + F00h Attribute: R/W
 Default Value: 00000000h Size: 32 bits

| Bit | Description |
|------|----------------------------------------------------|
| 31:6 | Reserved |
| 5 | LDCR5 Field 1 — R/W. BIOS may set this bit. |
| 4:0 | Reserved |

12.2.6 LDR1—LAN Device Initialization Register 1 (Gigabit LAN Memory Mapped Base Address Register)

Address Offset: MBARA + 3024h Attribute: R/W
 Default Value: 60006006h Size: 32 bits

| Bit | Description |
|-------|----------------------------------------------------------------|
| 31:17 | Reserved |
| 16 | LDR1 Field 1 — R/W. BIOS must program this field to 1b. |
| 15:0 | Reserved |

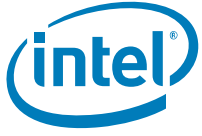

§ §



13 LPC Interface Bridge Registers (D31:F0)

The LPC bridge function of the ICH10 resides in PCI Device 31:Function 0. This function contains many other functional units, such as DMA and Interrupt controllers, Timers, Power Management, System Management, GPIO, RTC, and LPC Configuration Registers.

Registers and functions associated with other functional units (EHCI, UHCI, etc.) are described in their respective sections.

13.1 PCI Configuration Registers (LPC I/F—D31:F0)

Note: Address locations that are not shown should be treated as Reserved.

Table 13-1. LPC Interface PCI Register Address Map (LPC I/F—D31:F0) (Sheet 1 of 2)

| Offset | Mnemonic | Register Name | Default | Type |
|---------|--------------|--------------------------------------|--------------------------|----------|
| 00h–01h | VID | Vendor Identification | 8086h | RO |
| 02h–03h | DID | Device Identification | See register description | RO |
| 04h–05h | PCICMD | PCI Command | 0007h | R/W, RO |
| 06h–07h | PCISTS | PCI Status | 0210h | R/WC, RO |
| 08h | RID | Revision Identification | See register description | RO |
| 09h | PI | Programming Interface | 00h | RO |
| 0Ah | SCC | Sub Class Code | 01h | RO |
| 0Bh | BCC | Base Class Code | 06h | RO |
| 0Dh | PLT | Primary Latency Timer | 00h | RO |
| 0Eh | HEADTYP | Header Type | 80h | RO |
| 2Ch–2Fh | SS | Sub System Identifiers | 00000000h | R/WO |
| 40h–43h | PMBASE | ACPI Base Address | 00000001h | R/W, RO |
| 44h | ACPI_CNTL | ACPI Control | 00h | R/W |
| 48h–4Bh | GPIOBASE | GPIO Base Address | 00000001h | R/W, RO |
| 4C | GC | GPIO Control | 00h | R/W |
| 60h–63h | PIRQ[n]_ROUT | PIRQ[A–D] Routing Control | 80808080h | R/W |
| 64h | SIRQ_CNTL | Serial IRQ Control | 10h | R/W, RO |
| 68h–6Bh | PIRQ[n]_ROUT | PIRQ[E–H] Routing Control | 80808080h | R/W |
| 6Ch–6Dh | LPC_IBDF | IOxAPIC Bus:Device:Function | 00F8h | R/W |
| 70h–71h | H0BDF | HPET 0 Bus:Device:Function(H0BDF) | 00F8h | RW |
| 72h–73h | H1BDF | HPET 1 Bus:Device:Function(H1BDF) | 00F8h | RW |



Table 13-1. LPC Interface PCI Register Address Map (LPC I/F—D31:F0) (Sheet 2 of 2)

| Offset | Mnemonic | Register Name | Default | Type |
|---------|-------------|-----------------------------------------------------------|--------------------|-------------------|
| 74h-75h | H2BDF | HPET 2 Bus: Device: Function(H2BDF) | 00F8h | RW |
| 76h-77h | H3BDF | HPET 3 Bus: Device: Function(H3BDF) | 00F8h | RW |
| 78h-79h | H4BDF | HPET 4 Bus: Device: Function(H4BDF) | 00F8h | RW |
| 7Ah-7Bh | H5BDF | HPET 5 Bus: Device: Function(H5BDF) | 00F8h | RW |
| 7Ch-7Dh | H6BDF | HPET 6 Bus: Device: Function(H6BDF) | 00F8h | RW |
| 7Eh-7Fh | H7BDF | HPET 7 Bus: Device: Function(H7BDF) | 00F8h | RW |
| 80h | LPC_I/O_DEC | I/O Decode Ranges | 0000h | R/W |
| 82h-83h | LPC_EN | LPC I/F Enables | 0000h | R/W |
| 84h-87h | GEN1_DEC | LPC I/F Generic Decode Range 1 | 00000000h | R/W |
| 88h-8Bh | GEN2_DEC | LPC I/F Generic Decode Range 2 | 00000000h | R/W |
| 8Ch-8Eh | GEN3_DEC | LPC I/F Generic Decode Range 3 | 00000000h | R/W |
| 90h-93h | GEN4_DEC | LPC I/F Generic Decode Range 4 | 00000000h | R/W |
| 98h-9Bh | LGMR | LPC Generic Memory Range (Corporate Only) | 00000000h | R/W |
| A0h-CFh | | Power Management (See Section 13.8.1) | | |
| D0h-D3h | FWH_SEL1 | Firmware Hub Select 1 | 00112233h | R/W, RO |
| D4h-D5h | FWH_SEL2 | Firmware Hub Select 2 | 4567h | R/W |
| D8h-D9h | FWH_DEC_EN1 | Firmware Hub Decode Enable 1 | FFCFh | R/W, RO |
| DCh | BIOS_CNTL | BIOS Control | 00h | R/WLO, R/W, RO |
| E0h-E1h | FDCAP | Feature Detection Capability ID | 0009h | RO |
| E2h | FDLEN | Feature Detection Capability Length | 0Ch | RO |
| E3h | FDVER | Feature Detection Version | 10h | RO |
| E4h-EBh | FDVCT | Feature Vector | See Description | RO |
| F0h-F3h | RCBA | Root Complex Base Address | 00000000h | R/W |



13.1.4 PCISTS—PCI Status Register (LPC I/F—D31:F0)

| | | | |
|-----------------|---------|-------------|----------|
| Offset Address: | 06h–07h | Attribute: | RO, R/WC |
| Default Value: | 0210h | Size: | 16-bit |
| Lockable: | No | Power Well: | Core |

Note: For the writable bits, software must write a 1 to clear bits that are set. Writing a 0 to the bit has no effect.

| Bit | Description |
|------|------------------------------------------------------------------------------------------------------------------------------------------------------------------------------------------------------------------------------------------------------------------------------------------------------------------------------------------------------------------------------------------------------------------------|
| 15 | Detected Parity Error (DPE) — R/WC. This bit is set when the LPC bridge detects a parity error on the internal backbone. The bit is set even if the PCICMD.PERE bit (D31:F0:04, bit 6) is 0. 0 = Parity Error Not detected. 1 = Parity Error detected. |
| 14 | Signaled System Error (SSE) — R/WC. This bit is set when the LPC bridge signals a system error to the internal SERR# logic. |
| 13 | Master Abort Status (RMA) — R/WC. 0 = Unsupported request status not received. 1 = The bridge received a completion with unsupported request status from the backbone. |
| 12 | Received Target Abort (RTA) — R/WC. 0 = Completion abort not received. 1 = Completion with completion abort received from the backbone. |
| 11 | Signaled Target Abort (STA) — R/WC. 0 = Target abort Not generated on the backbone. 1 = LPC bridge generated a completion packet with target abort status on the backbone. |
| 10:9 | DEVSEL# Timing Status (DEV_STS) — RO. 01 = Medium Timing. |
| 8 | Data Parity Error Detected (DPED) — R/WC. 0 = All conditions listed below Not met. 1 = Set when all three of the following conditions are met: <ul style="list-style-type: none"> • LPC bridge receives a completion packet from the backbone from a previous request, • Parity error has been detected (D31:F0:06, bit 15) • PCICMD.PERE bit (D31:F0:04, bit 6) is set. |
| 7 | Fast Back to Back Capable (FBC): Reserved – bit has no meaning on the internal backbone. |
| 6 | Reserved. |
| 5 | 66 MHz Capable (66MHZ_CAP) — Reserved – bit has no meaning on the internal backbone. |
| 4 | Capabilities List (CLIST) — RO. Capability list exists on the LPC bridge. |
| 3 | Interrupt Status (IS) — RO. The LPC bridge does not generate interrupts. |
| 2:0 | Reserved. |



13.1.13 ACPI_CNTL—ACPI Control Register (LPC I/F — D31:F0)

| | | | |
|-----------------|-----|-------------|--------------|
| Offset Address: | 44h | Attribute: | R/W |
| Default Value: | 00h | Size: | 8 bit |
| Lockable: | No | Usage: | ACPI, Legacy |
| | | Power Well: | Core |

| Bit | Description | | | | | | | | | | | | | | |
|------|------------------------------------------------------------------------------------------------------------------------------------------------------------------------------------------------------------------------------------------------------------------------------------------------------------------------------------------------------------------------------------------------------------------------------------------------------------------------------------------------------------------------------------------------------------------------------------------------------------------------------------------------------------------------------------------------------------------------------------------------------------------------------------------------------------------------------------------------------------------------------------------------------------------------------------------------------------------------------------------------------------------------------------------------------------|------|---------|------|------|------|-------|------|-------|------|----------|------|----------------------------------------|------|----------------------------------------|
| 7 | <p>ACPI Enable (ACPI_EN) — R/W.</p> <p>0 = Disable.</p> <p>1 = Decode of the I/O range pointed to by the ACPI base register is enabled, and the ACPI power management function is enabled. Note that the APM power management ranges (B2/B3h) are always enabled and are not affected by this bit.</p> | | | | | | | | | | | | | | |
| 6:3 | Reserved | | | | | | | | | | | | | | |
| 2:0 | <p>SCI IRQ Select (SCI_IRQ_SEL) — R/W.</p> <p>Specifies on which IRQ the SCI will internally appear. If not using the APIC, the SCI must be routed to IRQ9–11, and that interrupt is not sharable with the SERIRQ stream, but is shareable with other PCI interrupts. If using the APIC, the SCI can also be mapped to IRQ20–23, and can be shared with other interrupts.</p> <table> <thead> <tr> <th>Bits</th> <th>SCI Map</th> </tr> </thead> <tbody> <tr> <td>000b</td> <td>IRQ9</td> </tr> <tr> <td>001b</td> <td>IRQ10</td> </tr> <tr> <td>010b</td> <td>IRQ11</td> </tr> <tr> <td>011b</td> <td>Reserved</td> </tr> <tr> <td>100b</td> <td>IRQ20 (Only available if APIC enabled)</td> </tr> <tr> <td>101b</td> <td>IRQ21 (Only available if APIC enabled)</td> </tr> </tbody> </table> <p>When the interrupt is mapped to APIC interrupts 9, 10, or 11, the APIC should be programmed for active-high reception. When the interrupt is mapped to APIC interrupts 20 through 23, the APIC should be programmed for active-low reception.</p> | Bits | SCI Map | 000b | IRQ9 | 001b | IRQ10 | 010b | IRQ11 | 011b | Reserved | 100b | IRQ20 (Only available if APIC enabled) | 101b | IRQ21 (Only available if APIC enabled) |
| Bits | SCI Map | | | | | | | | | | | | | | |
| 000b | IRQ9 | | | | | | | | | | | | | | |
| 001b | IRQ10 | | | | | | | | | | | | | | |
| 010b | IRQ11 | | | | | | | | | | | | | | |
| 011b | Reserved | | | | | | | | | | | | | | |
| 100b | IRQ20 (Only available if APIC enabled) | | | | | | | | | | | | | | |
| 101b | IRQ21 (Only available if APIC enabled) | | | | | | | | | | | | | | |

13.1.14 GPIOBASE—GPIO Base Address Register (LPC I/F — D31:F0)

| | | | |
|-----------------|----------|------------|---------|
| Offset Address: | 48h–4Bh | Attribute: | R/W, RO |
| Default Value: | 0000001h | Size: | 32 bit |

| Bit | Description |
|-------|------------------------------------------------------------------------------|
| 31:16 | Reserved. Always 0. |
| 15:7 | Base Address (BA) — RW. Provides the 128 bytes of I/O space for GPIO. |
| 6:1 | Reserved. Always 0 |
| 0 | RO. Hardwired to 1 to indicate I/O space. |



13.1.15 GC—GPIO Control Register (LPC I/F — D31:F0)

Offset Address: 4Ch
Default Value: 00h

Attribute: R/W
Size: 8 bit

| Bit | Description |
|-----|-----------------------------------------------------------------------------------------------------------------------------------------------------------------------------------------------------------------------------------------------------------------------------------------------------------------------------------------------------------------------------------------------------------------------------------------------------------------------------------------------------------------------------------------------------------------------------------------------------------------------------------------------------------------------------------------------------------------------------------------------|
| 7:5 | Reserved. |
| 4 | GPIO Enable (EN) — R/W. This bit enables/disables decode of the I/O range pointed to by the GPIO Base Address register (D31:F0:48h) and enables the GPIO function. 0 = Disable. 1 = Enable. |
| 3:1 | Reserved. |
| 0 | GPIO Lockdown Enable (GLE) — R/W. This bit enables lockdown of the following GPIO registers: <ul style="list-style-type: none">• Offset 00h: GPIO_USE_SEL• Offset 04h: GP_IO_SEL• Offset 0Ch: GP_LVL• Offset 30h: GPIO_USE_SEL2• Offset 34h: GP_IO_SEL2• Offset 38h: GP_LVL2• Offset 40h: GPIO_USE_SEL3 (Corporate Only)• Offset 44h: GP_IO_SEL3 (Corporate Only)• Offset 48h: GP_LVL3 (Corporate Only)• Offset 60h: GP_RST_SEL 0 = Disable. 1 = Enable. When this bit is written from a 1-to-0 an SMI# is generated, if enabled. This ensures that only SMM code can change the above GPIO registers after they are locked down. |



13.1.16 PIRQ[n]_ROUT—PIRQ[A,B,C,D] Routing Control Register (LPC I/F—D31:F0)

Offset Address: PIRQA – 60h, PIRQB – 61h, Attribute: R/W
 PIRQC – 62h, PIRQD – 63h
 Default Value: 80h Size: 8 bit
 Lockable: No Power Well: Core

| Bit | Description | | | | | | | | | | | | | | | | | | | | | | | | | | | | | | | | | | | | |
|-------|--------------------------------------------------------------------------------------------------------------------------------------------------------------------------------------------------------------------------------------------------------------------------------------------------------------------------------------------------------------------------------------------------------------------------------------------------------------------------------------------------------------------------------------------------------------------------------------------------------------------------------------------------------------------------------------------------------------------------------------------------------------------------------------|-------|----------|-------|-----|-------|----------|-------|----------|-------|----------|-------|------|-------|----------|-------|-------|-------|------|-------|-------|-------|------|-------|-------|-------|------|-------|----------|-------|------|-------|-------|-------|------|-------|-------|
| 7 | <p>Interrupt Routing Enable (IRQEN) — R/W.</p> <p>0 = The corresponding PIRQ is routed to one of the ISA-compatible interrupts specified in bits[3:0].</p> <p>1 = The PIRQ is not routed to the 8259.</p> <p>NOTE: BIOS must program this bit to 0 during POST for any of the PIRQs that are being used. The value of this bit may subsequently be changed by the OS when setting up for I/O APIC interrupt delivery mode.</p> | | | | | | | | | | | | | | | | | | | | | | | | | | | | | | | | | | | | |
| 6:4 | Reserved | | | | | | | | | | | | | | | | | | | | | | | | | | | | | | | | | | | | |
| 3:0 | <p>IRQ Routing — R/W. (ISA compatible.)</p> <table border="1"> <thead> <tr> <th>Value</th> <th>IRQ</th> <th>Value</th> <th>IRQ</th> </tr> </thead> <tbody> <tr> <td>0000b</td> <td>Reserved</td> <td>1000b</td> <td>Reserved</td> </tr> <tr> <td>0001b</td> <td>Reserved</td> <td>1001b</td> <td>IRQ9</td> </tr> <tr> <td>0010b</td> <td>Reserved</td> <td>1010b</td> <td>IRQ10</td> </tr> <tr> <td>0011b</td> <td>IRQ3</td> <td>1011b</td> <td>IRQ11</td> </tr> <tr> <td>0100b</td> <td>IRQ4</td> <td>1100b</td> <td>IRQ12</td> </tr> <tr> <td>0101b</td> <td>IRQ5</td> <td>1101b</td> <td>Reserved</td> </tr> <tr> <td>0110b</td> <td>IRQ6</td> <td>1110b</td> <td>IRQ14</td> </tr> <tr> <td>0111b</td> <td>IRQ7</td> <td>1111b</td> <td>IRQ15</td> </tr> </tbody> </table> | Value | IRQ | Value | IRQ | 0000b | Reserved | 1000b | Reserved | 0001b | Reserved | 1001b | IRQ9 | 0010b | Reserved | 1010b | IRQ10 | 0011b | IRQ3 | 1011b | IRQ11 | 0100b | IRQ4 | 1100b | IRQ12 | 0101b | IRQ5 | 1101b | Reserved | 0110b | IRQ6 | 1110b | IRQ14 | 0111b | IRQ7 | 1111b | IRQ15 |
| Value | IRQ | Value | IRQ | | | | | | | | | | | | | | | | | | | | | | | | | | | | | | | | | | |
| 0000b | Reserved | 1000b | Reserved | | | | | | | | | | | | | | | | | | | | | | | | | | | | | | | | | | |
| 0001b | Reserved | 1001b | IRQ9 | | | | | | | | | | | | | | | | | | | | | | | | | | | | | | | | | | |
| 0010b | Reserved | 1010b | IRQ10 | | | | | | | | | | | | | | | | | | | | | | | | | | | | | | | | | | |
| 0011b | IRQ3 | 1011b | IRQ11 | | | | | | | | | | | | | | | | | | | | | | | | | | | | | | | | | | |
| 0100b | IRQ4 | 1100b | IRQ12 | | | | | | | | | | | | | | | | | | | | | | | | | | | | | | | | | | |
| 0101b | IRQ5 | 1101b | Reserved | | | | | | | | | | | | | | | | | | | | | | | | | | | | | | | | | | |
| 0110b | IRQ6 | 1110b | IRQ14 | | | | | | | | | | | | | | | | | | | | | | | | | | | | | | | | | | |
| 0111b | IRQ7 | 1111b | IRQ15 | | | | | | | | | | | | | | | | | | | | | | | | | | | | | | | | | | |



13.1.17 SIROQ_CNTL—Serial IRQ Control Register (LPC I/F—D31:F0)

| | | | |
|-----------------|-----|-------------|---------|
| Offset Address: | 64h | Attribute: | R/W, RO |
| Default Value: | 10h | Size: | 8 bit |
| Lockable: | No | Power Well: | Core |

| Bit | Description |
|-----|--------------------------------------------------------------------------------------------------------------------------------------------------------------------------------------------------------------------------------------------------------------------------------------------------------------------------------------------------------------------------------------------------------------------------------------------------------------------------------------------------------------------------------------------|
| 7 | <p>Serial IRQ Enable (SIRQEN) — R/W.</p> <p>0 = The buffer is input only and internally SERIRQ will be a 1. 1 = Serial IRQs will be recognized. The SERIRQ pin will be configured as SERIRQ.</p> |
| 6 | <p>Serial IRQ Mode Select (SIRQMD) — R/W.</p> <p>0 = The serial IRQ machine will be in quiet mode. 1 = The serial IRQ machine will be in continuous mode.</p> <p>NOTE: For systems using Quiet Mode, this bit should be set to 1 (Continuous Mode) for at least one frame after coming out of reset before switching back to Quiet Mode. Failure to do so will result in the ICH10 not recognizing SERIRQ interrupts.</p> |
| 5:2 | <p>Serial IRQ Frame Size (SIRQSZ) — RO. Fixed field that indicates the size of the SERIRQ frame as 21 frames.</p> |
| 1:0 | <p>Start Frame Pulse Width (SFPW) — R/W. This is the number of PCI clocks that the SERIRQ pin will be driven low by the serial IRQ machine to signal a start frame. In continuous mode, the ICH10 will drive the start frame for the number of clocks specified. In quiet mode, the ICH10 will drive the start frame for the number of clocks specified minus one, as the first clock was driven by the peripheral.</p> <p>00 = 4 clocks 01 = 6 clocks 10 = 8 clocks 11 = Reserved</p> |



13.1.18 PIRQ[n]_ROUT—PIRQ[E,F,G,H] Routing Control Register (LPC I/F—D31:F0)

Offset Address: PIRQE – 68h, PIRQF – 69h, Attribute: R/W
 PIRQG – 6Ah, PIRQH – 6Bh
 Default Value: 80h Size: 8 bit
 Lockable: No Power Well: Core

| Bit | Description | | | | | | | | | | | | | | | | | | | | | | | | | | | | | | | | | | | | |
|-------|--------------------------------------------------------------------------------------------------------------------------------------------------------------------------------------------------------------------------------------------------------------------------------------------------------------------------------------------------------------------------------------------------------------------------------------------------------------------------------------------------------------------------------------------------------------------------------------------------------------------------------------------------------------------------------------------------------------------------------------------------------------------------------------|-------|----------|-------|-----|-------|----------|-------|----------|-------|----------|-------|------|-------|----------|-------|-------|-------|------|-------|-------|-------|------|-------|-------|-------|------|-------|----------|-------|------|-------|-------|-------|------|-------|-------|
| 7 | <p>Interrupt Routing Enable (IRQEN) — R/W.</p> <p>0 = The corresponding PIRQ is routed to one of the ISA-compatible interrupts specified in bits[3:0].</p> <p>1 = The PIRQ is not routed to the 8259.</p> <p>NOTE: BIOS must program this bit to 0 during POST for any of the PIRQs that are being used. The value of this bit may subsequently be changed by the OS when setting up for I/O APIC interrupt delivery mode.</p> | | | | | | | | | | | | | | | | | | | | | | | | | | | | | | | | | | | | |
| 6:4 | Reserved | | | | | | | | | | | | | | | | | | | | | | | | | | | | | | | | | | | | |
| 3:0 | <p>IRQ Routing — R/W. (ISA compatible.)</p> <table border="1"> <thead> <tr> <th>Value</th> <th>IRQ</th> <th>Value</th> <th>IRQ</th> </tr> </thead> <tbody> <tr> <td>0000b</td> <td>Reserved</td> <td>1000b</td> <td>Reserved</td> </tr> <tr> <td>0001b</td> <td>Reserved</td> <td>1001b</td> <td>IRQ9</td> </tr> <tr> <td>0010b</td> <td>Reserved</td> <td>1010b</td> <td>IRQ10</td> </tr> <tr> <td>0011b</td> <td>IRQ3</td> <td>1011b</td> <td>IRQ11</td> </tr> <tr> <td>0100b</td> <td>IRQ4</td> <td>1100b</td> <td>IRQ12</td> </tr> <tr> <td>0101b</td> <td>IRQ5</td> <td>1101b</td> <td>Reserved</td> </tr> <tr> <td>0110b</td> <td>IRQ6</td> <td>1110b</td> <td>IRQ14</td> </tr> <tr> <td>0111b</td> <td>IRQ7</td> <td>1111b</td> <td>IRQ15</td> </tr> </tbody> </table> | Value | IRQ | Value | IRQ | 0000b | Reserved | 1000b | Reserved | 0001b | Reserved | 1001b | IRQ9 | 0010b | Reserved | 1010b | IRQ10 | 0011b | IRQ3 | 1011b | IRQ11 | 0100b | IRQ4 | 1100b | IRQ12 | 0101b | IRQ5 | 1101b | Reserved | 0110b | IRQ6 | 1110b | IRQ14 | 0111b | IRQ7 | 1111b | IRQ15 |
| Value | IRQ | Value | IRQ | | | | | | | | | | | | | | | | | | | | | | | | | | | | | | | | | | |
| 0000b | Reserved | 1000b | Reserved | | | | | | | | | | | | | | | | | | | | | | | | | | | | | | | | | | |
| 0001b | Reserved | 1001b | IRQ9 | | | | | | | | | | | | | | | | | | | | | | | | | | | | | | | | | | |
| 0010b | Reserved | 1010b | IRQ10 | | | | | | | | | | | | | | | | | | | | | | | | | | | | | | | | | | |
| 0011b | IRQ3 | 1011b | IRQ11 | | | | | | | | | | | | | | | | | | | | | | | | | | | | | | | | | | |
| 0100b | IRQ4 | 1100b | IRQ12 | | | | | | | | | | | | | | | | | | | | | | | | | | | | | | | | | | |
| 0101b | IRQ5 | 1101b | Reserved | | | | | | | | | | | | | | | | | | | | | | | | | | | | | | | | | | |
| 0110b | IRQ6 | 1110b | IRQ14 | | | | | | | | | | | | | | | | | | | | | | | | | | | | | | | | | | |
| 0111b | IRQ7 | 1111b | IRQ15 | | | | | | | | | | | | | | | | | | | | | | | | | | | | | | | | | | |



13.1.21 LPC_I/O_DEC—I/O Decode Ranges Register (LPC I/F—D31:F0)

Offset Address: 80h
Default Value: 0000h

Attribute: R/W
Size: 16 bit

| Bit | Description |
|-------|----------------------------------------------------------------------------------------------------------------------------------------------------------------------------------------------------------------------------------------------------------------------------------------------------|
| 15:13 | Reserved |
| 12 | FDD Decode Range — R/W. This bit determines which range to decode for the FDD Port. 0 = 3F0h – 3F5h, 3F7h (Primary) 1 = 370h – 375h, 377h (Secondary) |
| 11:10 | Reserved |
| 9:8 | LPT Decode Range — R/W. This field determines which range to decode for the LPT Port. 00 = 378h – 37Fh and 778h – 77Fh 01 = 278h – 27Fh (port 279h is read only) and 678h – 67Fh 10 = 3BCh – 3BEh and 7BCh – 7BEh 11 = Reserved |
| 7 | Reserved |
| 6:4 | COMB Decode Range — R/W. This field determines which range to decode for the COMB Port. 000 = 3F8h – 3FFh (COM1) 001 = 2F8h – 2FFh (COM2) 010 = 220h – 227h 011 = 228h – 22Fh 100 = 238h – 23Fh 101 = 2E8h – 2EFh (COM4) 110 = 338h – 33Fh 111 = 3E8h – 3EFh (COM3) |
| 3 | Reserved |
| 2:0 | COMA Decode Range — R/W. This field determines which range to decode for the COMA Port. 000 = 3F8h – 3FFh (COM1) 001 = 2F8h – 2FFh (COM2) 010 = 220h – 227h 011 = 228h – 22Fh 100 = 238h – 23Fh 101 = 2E8h – 2EFh (COM4) 110 = 338h – 33Fh 111 = 3E8h – 3EFh (COM3) |



13.1.22 LPC_EN—LPC I/F Enables Register (LPC I/F—D31:F0)

Offset Address: 82h – 83h
 Default Value: 0000h

Attribute: R/W
 Size: 16 bit
 Power Well: Core

| Bit | Description |
|-------|-------------------------------------------------------------------------------------------------------------------------------------------------------------------------------------------------------------------------|
| 15:14 | Reserved |
| 13 | CNF2_LPC_EN — R/W. Microcontroller Enable #2. 0 = Disable. 1 = Enables the decoding of the I/O locations 4Eh and 4Fh to the LPC interface. This range is used for a microcontroller. |
| 12 | CNF1_LPC_EN — R/W. Super I/O Enable. 0 = Disable. 1 = Enables the decoding of the I/O locations 2Eh and 2Fh to the LPC interface. This range is used for Super I/O devices. |
| 11 | MC_LPC_EN — R/W. Microcontroller Enable #1. 0 = Disable. 1 = Enables the decoding of the I/O locations 62h and 66h to the LPC interface. This range is used for a microcontroller. |
| 10 | KBC_LPC_EN — R/W. Keyboard Enable. 0 = Disable. 1 = Enables the decoding of the I/O locations 60h and 64h to the LPC interface. This range is used for a microcontroller. |
| 9 | GAMEH_LPC_EN — R/W. High Gameport Enable 0 = Disable. 1 = Enables the decoding of the I/O locations 208h to 20Fh to the LPC interface. This range is used for a gameport. |
| 8 | GAMEL_LPC_EN — R/W. Low Gameport Enable 0 = Disable. 1 = Enables the decoding of the I/O locations 200h to 207h to the LPC interface. This range is used for a gameport. |
| 7:4 | Reserved |
| 3 | FDD_LPC_EN — R/W. Floppy Drive Enable 0 = Disable. 1 = Enables the decoding of the FDD range to the LPC interface. This range is selected in the LPC_FDD/LPT Decode Range Register (D31:F0:80h, bit 12). |
| 2 | LPT_LPC_EN — R/W. Parallel Port Enable 0 = Disable. 1 = Enables the decoding of the LPT range to the LPC interface. This range is selected in the LPC_FDD/LPT Decode Range Register (D31:F0:80h, bit 9:8). |
| 1 | COMB_LPC_EN — R/W. Com Port B Enable 0 = Disable. 1 = Enables the decoding of the COMB range to the LPC interface. This range is selected in the LPC_COM Decode Range Register (D31:F0:80h, bits 6:4). |
| 0 | COMA_LPC_EN — R/W. Com Port A Enable 0 = Disable. 1 = Enables the decoding of the COMA range to the LPC interface. This range is selected in the LPC_COM Decode Range Register (D31:F0:80h, bits 3:2). |



13.1.25 GEN3_DEC—LPC I/F Generic Decode Range 3 Register (LPC I/F—D31:F0)

Offset Address: 8Ch – 8Eh
Default Value: 00000000h

Attribute: R/W
Size: 32 bit
Power Well: Core

| Bit | Description |
|-------|--------------------------------------------------------------------------------------------------------------------------------------------------------------------------------------------------------------------------------------------------------------------------------------------------------------------------------------------------------------------------------------|
| 31:24 | Reserved |
| 23:18 | Generic I/O Decode Range Address[7:2] Mask — R/W. A 1 in any bit position indicates that any value in the corresponding address bit in a received cycle will be treated as a match. The corresponding bit in the Address field, below, is ignored. The mask is only provided for the lower 6 bits of the DWord address, allowing for decoding blocks up to 256 bytes in size. |
| 17:16 | Reserved |
| 15:2 | Generic I/O Decode Range 3 Base Address (GEN3_BASE) — R/W. NOTE: The ICH Does not provide decode down to the word or byte level. |
| 1 | Reserved |
| 0 | Generic Decode Range 3 Enable (GEN3_EN) — R/W. 0 = Disable. 1 = Enable the GEN3 I/O range to be forwarded to the LPC I/F. |



13.1.29 FWH_SEL2—Firmware Hub Select 2 Register (LPC I/F—D31:F0)

Offset Address: D4h–D5h
Default Value: 4567h

Attribute: R/W
Size: 16 bits

| Bit | Description |
|-------|-----------------------------------------------------------------------------------------------------------------------------------------------------------------------------------------------------------|
| 15:12 | FWH_70_IDSEL — R/W. IDSEL for two, 1-M Firmware Hub memory ranges. The IDSEL programmed in this field addresses the following memory ranges: FF70 0000h – FF7F FFFFh FF30 0000h – FF3F FFFFh |
| 11:8 | FWH_60_IDSEL — R/W. IDSEL for two, 1-M Firmware Hub memory ranges. The IDSEL programmed in this field addresses the following memory ranges: FF60 0000h – FF6F FFFFh FF20 0000h – FF2F FFFFh |
| 7:4 | FWH_50_IDSEL — R/W. IDSEL for two, 1-M Firmware Hub memory ranges. The IDSEL programmed in this field addresses the following memory ranges: FF50 0000h – FF5F FFFFh FF10 0000h – FF1F FFFFh |
| 3:0 | FWH_40_IDSEL — R/W. IDSEL for two, 1-M Firmware Hub memory ranges. The IDSEL programmed in this field addresses the following memory ranges: FF40 0000h – FF4F FFFFh FF00 0000h – FF0F FFFFh |



| Bit | Description |
|-----|----------------------------------------------------------------------------------------------------------------------------------------------------------------------------------------------------------------------------------------------------------------------------------------------------------------------------------------------------------------------------------------|
| 8 | <p>FWH_CO_EN — R/W. This bit enables decoding two 512-KB Firmware Hub memory ranges.</p> <p>0 = Disable. 1 = Enable the following ranges for the Firmware Hub FFC00000h – FFC7FFFFh FF800000h – FF87FFFFh</p> |
| 7 | <p>FWH_Legacy_F_EN — R/W. This enables the decoding of the legacy 64KB range at F0000h – FFFFFh.</p> <p>0 = Disable. 1 = Enable the following legacy ranges for the Firmware Hub F0000h – FFFFFh</p> <p>NOTE: The decode for the BIOS legacy F segment is enabled only by this bit and is not affected by the GEN_PMCON_1.iA64_EN bit.</p> |
| 6 | <p>FWH_Legacy_E_EN — R/W. This enables the decoding of the legacy 64KB range at E0000h – EFFFFh.</p> <p>0 = Disable. 1 = Enable the following legacy ranges for the Firmware Hub E0000h – EFFFFh</p> <p>NOTE: The decode for the BIOS legacy E segment is enabled only by this bit and is not affected by the GEN_PMCON_1.iA64_EN bit.</p> |
| 5:4 | Reserved |
| 3 | <p>FWH_70_EN — R/W. Enables decoding two 1-M Firmware Hub memory ranges.</p> <p>0 = Disable. 1 = Enable the following ranges for the Firmware Hub FF70 0000h – FF7F FFFFh FF30 0000h – FF3F FFFFh</p> |
| 2 | <p>FWH_60_EN — R/W. Enables decoding two 1-M Firmware Hub memory ranges.</p> <p>0 = Disable. 1 = Enable the following ranges for the Firmware Hub FF60 0000h – FF6F FFFFh FF20 0000h – FF2F FFFFh</p> |
| 1 | <p>FWH_50_EN — R/W. Enables decoding two 1-M Firmware Hub memory ranges.</p> <p>0 = Disable. 1 = Enable the following ranges for the Firmware Hub FF50 0000h – FF5F FFFFh FF10 0000h – FF1F FFFFh</p> |
| 0 | <p>FWH_40_EN — R/W. Enables decoding two 1-M Firmware Hub memory ranges.</p> <p>0 = Disable. 1 = Enable the following ranges for the Firmware Hub FF40 0000h – FF4F FFFFh FF00 0000h – FF0F FFFFh</p> |

NOTE: This register effects the BIOS decode regardless of whether the BIOS is resident on LPC or SPI. The concept of Feature Space does not apply to SPI-based flash. The ICH simply decodes these ranges as memory accesses when enabled for the SPI flash interface.



13.1.31 BIOS_CNTL—BIOS Control Register (LPC I/F—D31:F0)

| | | | |
|-----------------|-----|-------------|----------------|
| Offset Address: | DCh | Attribute: | R/WLO, R/W, RO |
| Default Value: | 00h | Size: | 8 bit |
| Lockable: | No | Power Well: | Core |

| Bit | Description | | | | | | | | | | |
|----------|---------------------------------------------------------------------------------------------------------------------------------------------------------------------------------------------------------------------------------------------------------------------------------------------------------------------------------------------------------------------------------------------------------------------------------------------------------------------------------------------------------------------------------------------------------------------------------------------------------------------------------------------------------------------------------------------------------------------------------------------------------------------------------------------------------------------------------------------------------------------------------------------------------------------------------------------------------------------------------------------------------------------------------------------------------------------------------------------|----------|-------------|-----|--------------------------------------------------------------------------------------------------------------------------------------------------------------------------------|-----|---------------------------------------------------------------------------------------------------------------------------------------------------|-----|-----------------------------------------------------------------------------------------------------------------------------------------|-----|---------------------------------------------------------------------------------------------------------|
| 7:5 | Reserved | | | | | | | | | | |
| 4 | Top Swap Status (TSS) — RO. This bit provides a read-only path to view the state of the Top Swap bit that is at offset 3414h, bit 0. | | | | | | | | | | |
| 3:2 | <p>SPI Read Configuration (SRC) — R/W. This 2-bit field controls two policies related to BIOS reads on the SPI interface:</p> <p>Bit 3 = Prefetch Enable Bit 2 = Cache Disable Settings are summarized below:</p> <table border="0"> <thead> <tr> <th>Bits 3:2</th> <th>Description</th> </tr> </thead> <tbody> <tr> <td>00b</td> <td>No prefetching, but caching enabled. 64B demand reads load the read buffer cache with “valid” data, allowing repeated code fetches to the same line to complete quickly</td> </tr> <tr> <td>01b</td> <td>No prefetching and no caching. One-to-one correspondence of host BIOS reads to SPI cycles. This value can be used to invalidate the cache.</td> </tr> <tr> <td>10b</td> <td>Prefetching and Caching enabled. This mode is used for long sequences of short reads to consecutive addresses (i.e., shadowing).</td> </tr> <tr> <td>11b</td> <td>Reserved. This is an invalid configuration, caching must be enabled when prefetching is enabled.</td> </tr> </tbody> </table> | Bits 3:2 | Description | 00b | No prefetching, but caching enabled. 64B demand reads load the read buffer cache with “valid” data, allowing repeated code fetches to the same line to complete quickly | 01b | No prefetching and no caching. One-to-one correspondence of host BIOS reads to SPI cycles. This value can be used to invalidate the cache. | 10b | Prefetching and Caching enabled. This mode is used for long sequences of short reads to consecutive addresses (i.e., shadowing). | 11b | Reserved. This is an invalid configuration, caching must be enabled when prefetching is enabled. |
| Bits 3:2 | Description | | | | | | | | | | |
| 00b | No prefetching, but caching enabled. 64B demand reads load the read buffer cache with “valid” data, allowing repeated code fetches to the same line to complete quickly | | | | | | | | | | |
| 01b | No prefetching and no caching. One-to-one correspondence of host BIOS reads to SPI cycles. This value can be used to invalidate the cache. | | | | | | | | | | |
| 10b | Prefetching and Caching enabled. This mode is used for long sequences of short reads to consecutive addresses (i.e., shadowing). | | | | | | | | | | |
| 11b | Reserved. This is an invalid configuration, caching must be enabled when prefetching is enabled. | | | | | | | | | | |
| 1 | <p>BIOS Lock Enable (BLE) — R/WLO.</p> <p>0 = Setting the BIOSWE will not cause SMIs. 1 = Enables setting the BIOSWE bit to cause SMIs. Once set, this bit can only be cleared by a PLTRST#.</p> | | | | | | | | | | |
| 0 | <p>BIOS Write Enable (BIOSWE) — R/W.</p> <p>0 = Only read cycles result in Firmware Hub I/F cycles. 1 = Access to the BIOS space is enabled for both read and write cycles. When this bit is written from a 0 to a 1 and BIOS Lock Enable (BLE) is also set, an SMI# is generated. This ensures that only SMI code can update BIOS.</p> | | | | | | | | | | |



13.1.35 FDVCT—Feature Vector (LPC I/F—D31:F0)

Offset Address: E4h-EBh
Default Value: See Description

Attribute: RO
Size: 64 bit
Power Well: Core

| Bit | Description |
|-------|-----------------------------------------------------------------------------------------------------------|
| 63:42 | Reserved |
| 41 | Intel® Active Management Technology Release 5.0 Support Capability — RO. 0 = Professional 1 = Basic |
| 40:38 | Reserved |
| 37 | Intel Active Management Technology Capability — RO. 0 = Capable 1 = Disabled |
| 36:6 | Reserved |
| 5 | SATA RAID 0/1/5/10 Capability— RO. 0 = Capable 1 = Disabled |
| 4:0 | Reserved |

13.1.36 RCBA—Root Complex Base Address Register (LPC I/F—D31:F0)

Offset Address: F0-F3h
Default Value: 00000000h

Attribute: R/W
Size: 32 bit

| Bit | Description |
|-------|---------------------------------------------------------------------------------------------------------------------------------------------|
| 31:14 | Base Address (BA) — R/W. Base Address for the root complex register block decode range. This address is aligned on a 16-KB boundary. |
| 13:1 | Reserved |
| 0 | Enable (EN) — R/W. When set, enables the range specified in BA to be claimed as the Root Complex Register Block. |

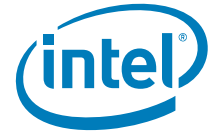

13.2 DMA I/O Registers (LPC I/F—D31:F0)

Table 13-2. DMA Registers (Sheet 1 of 2)

| Port | Alias | Register Name | Default | Type |
|---------|---------|--------------------------------------|-----------|------|
| 00h | 10h | Channel 0 DMA Base & Current Address | Undefined | R/W |
| 01h | 11h | Channel 0 DMA Base & Current Count | Undefined | R/W |
| 02h | 12h | Channel 1 DMA Base & Current Address | Undefined | R/W |
| 03h | 13h | Channel 1 DMA Base & Current Count | Undefined | R/W |
| 04h | 14h | Channel 2 DMA Base & Current Address | Undefined | R/W |
| 05h | 15h | Channel 2 DMA Base & Current Count | Undefined | R/W |
| 06h | 16h | Channel 3 DMA Base & Current Address | Undefined | R/W |
| 07h | 17h | Channel 3 DMA Base & Current Count | Undefined | R/W |
| 08h | 18h | Channel 0–3 DMA Command | Undefined | WO |
| | | Channel 0–3 DMA Status | Undefined | RO |
| 0Ah | 1Ah | Channel 0–3 DMA Write Single Mask | 000001XXb | WO |
| 0Bh | 1Bh | Channel 0–3 DMA Channel Mode | 000000XXb | WO |
| 0Ch | 1Ch | Channel 0–3 DMA Clear Byte Pointer | Undefined | WO |
| 0Dh | 1Dh | Channel 0–3 DMA Master Clear | Undefined | WO |
| 0Eh | 1Eh | Channel 0–3 DMA Clear Mask | Undefined | WO |
| 0Fh | 1Fh | Channel 0–3 DMA Write All Mask | 0Fh | R/W |
| 80h | 90h | Reserved Page | Undefined | R/W |
| 81h | 91h | Channel 2 DMA Memory Low Page | Undefined | R/W |
| 82h | — | Channel 3 DMA Memory Low Page | Undefined | R/W |
| 83h | 93h | Channel 1 DMA Memory Low Page | Undefined | R/W |
| 84h–86h | 94h–96h | Reserved Pages | Undefined | R/W |
| 87h | 97h | Channel 0 DMA Memory Low Page | Undefined | R/W |
| 88h | 98h | Reserved Page | Undefined | R/W |
| 89h | 99h | Channel 6 DMA Memory Low Page | Undefined | R/W |
| 8Ah | 9Ah | Channel 7 DMA Memory Low Page | Undefined | R/W |
| 8Bh | 9Bh | Channel 5 DMA Memory Low Page | Undefined | R/W |
| 8Ch–8Eh | 9Ch–9Eh | Reserved Page | Undefined | R/W |
| 8Fh | 9Fh | Refresh Low Page | Undefined | R/W |
| C0h | C1h | Channel 4 DMA Base & Current Address | Undefined | R/W |
| C2h | C3h | Channel 4 DMA Base & Current Count | Undefined | R/W |
| C4h | C5h | Channel 5 DMA Base & Current Address | Undefined | R/W |
| C6h | C7h | Channel 5 DMA Base & Current Count | Undefined | R/W |
| C8h | C9h | Channel 6 DMA Base & Current Address | Undefined | R/W |
| CAh | CBh | Channel 6 DMA Base & Current Count | Undefined | R/W |
| CCh | CDh | Channel 7 DMA Base & Current Address | Undefined | R/W |



Table 13-2. DMA Registers (Sheet 2 of 2)

| Port | Alias | Register Name | Default | Type |
|------|-------|------------------------------------|-----------|------|
| CEh | CFh | Channel 7 DMA Base & Current Count | Undefined | R/W |
| D0h | D1h | Channel 4–7 DMA Command | Undefined | WO |
| | | Channel 4–7 DMA Status | Undefined | RO |
| D4h | D5h | Channel 4–7 DMA Write Single Mask | 000001XXb | WO |
| D6h | D7h | Channel 4–7 DMA Channel Mode | 000000XXb | WO |
| D8h | D9h | Channel 4–7 DMA Clear Byte Pointer | Undefined | WO |
| DAh | DBh | Channel 4–7 DMA Master Clear | Undefined | WO |
| DCh | DDh | Channel 4–7 DMA Clear Mask | Undefined | WO |
| DEh | DFh | Channel 4–7 DMA Write All Mask | 0Fh | R/W |

13.2.1 DMABASE_CA—DMA Base and Current Address Registers (LPC I/F—D31:F0)

I/O Address: Ch. #0 = 00h; Ch. #1 = 02h Attribute: R/W
 Ch. #2 = 04h; Ch. #3 = 06h Size: 16 bit (per channel),
 Ch. #5 = C4h Ch. #6 = C8h but accessed in two 8-bit
 Ch. #7 = CCh; quantities

Default Value: Undefined
 Lockable: No Power Well: Core

| Bit | Description |
|------|-----------------------------------------------------------------------------------------------------------------------------------------------------------------------------------------------------------------------------------------------------------------------------------------------------------------------------------------------------------------------------------------------------------------------------------------------------------------------------------------------------------------------------------------------------------------------------------------------------------------------------------------------------------------------------------------------------------------------------------------------------------------------------------------------------------------------------------------------------------------------------------------------------------------------------------------------------------------------------------------------------------------------------------------------------------------------------|
| 15:0 | <p>Base and Current Address — R/W. This register determines the address for the transfers to be performed. The address specified points to two separate registers. On writes, the value is stored in the <i>Base Address</i> register and copied to the <i>Current Address</i> register. On reads, the value is returned from the <i>Current Address</i> register. The address increments/decrements in the Current Address register after each transfer, depending on the mode of the transfer. If the channel is in auto-initialize mode, the Current Address register will be reloaded from the Base Address register after a terminal count is generated.</p> <p>For transfers to/from a 16-bit slave (channels 5–7), the address is shifted left one bit location. Bit 15 will be shifted into Bit 16.</p> <p>The register is accessed in 8 bit quantities. The byte is pointed to by the current byte pointer flip/flop. Before accessing an address register, the byte pointer flip/flop should be cleared to ensure that the low byte is accessed first.</p> |



13.2.2 DMABASE_CC—DMA Base and Current Count Registers (LPC I/F—D31:F0)

I/O Address: Ch. #0 = 01h; Ch. #1 = 03h Attribute: R/W
 Ch. #2 = 05h; Ch. #3 = 07h Size: 16-bit (per channel),
 Ch. #5 = C6h; Ch. #6 = CAh but accessed in two 8-bit
 Ch. #7 = CEh; quantities
 Default Value: Undefined
 Lockable: No Power Well: Core

| Bit | Description |
|------|-----------------------------------------------------------------------------------------------------------------------------------------------------------------------------------------------------------------------------------------------------------------------------------------------------------------------------------------------------------------------------------------------------------------------------------------------------------------------------------------------------------------------------------------------------------------------------------------------------------------------------------------------------------------------------------------------------------------------------------------------------------------------------------------------------------------------------------------------------------------------------------------------------------------------------------------------------------------------------------------------------------------------------------------------------------------------------------------------------------------------------------------------------------------------------------------------------------------------------------------------------------------------------------------------------------------------------------------------------------------------|
| 15:0 | <p>Base and Current Count — R/W. This register determines the number of transfers to be performed. The address specified points to two separate registers. On writes, the value is stored in the <i>Base Count</i> register and copied to the <i>Current Count</i> register. On reads, the value is returned from the <i>Current Count</i> register.</p> <p>The actual number of transfers is one more than the number programmed in the Base Count Register (i.e., programming a count of 4h results in 5 transfers). The count is decrements in the Current Count register after each transfer. When the value in the register rolls from 0 to FFFFh, a terminal count is generated. If the channel is in auto-initialize mode, the Current Count register will be reloaded from the Base Count register after a terminal count is generated.</p> <p>For transfers to/from an 8-bit slave (channels 0–3), the count register indicates the number of bytes to be transferred. For transfers to/from a 16-bit slave (channels 5–7), the count register indicates the number of words to be transferred.</p> <p>The register is accessed in 8 bit quantities. The byte is pointed to by the current byte pointer flip/flop. Before accessing a count register, the byte pointer flip/flop should be cleared to ensure that the low byte is accessed first.</p> |

13.2.3 DMAMEM_LP—DMA Memory Low Page Registers (LPC I/F—D31:F0)

I/O Address: Ch. #0 = 87h; Ch. #1 = 83h
 Ch. #2 = 81h; Ch. #3 = 82h
 Ch. #5 = 8Bh; Ch. #6 = 89h
 Ch. #7 = 8Ah; Attribute: R/W
 Default Value: Undefined Size: 8-bit
 Lockable: No Power Well: Core

| Bit | Description |
|-----|----------------------------------------------------------------------------------------------------------------------------------------------------------------------------------------------------------------------------------------------------------------------------------------------------------------------------------------------------------------------------------------------------------------------------------|
| 7:0 | <p>DMA Low Page (ISA Address bits [23:16]) — R/W. This register works in conjunction with the DMA controller's Current Address Register to define the complete 24-bit address for the DMA channel. This register remains static throughout the DMA transfer. Bit 16 of this register is ignored when in 16 bit I/O count by words mode as it is replaced by the bit 15 shifted out from the current address register.</p> |



13.2.4 DMACMD—DMA Command Register (LPC I/F—D31:F0)

I/O Address: Ch. #0–3 = 08h;
Ch. #4–7 = D0h Attribute: WO
Default Value: Undefined Size: 8-bit
Lockable: No Power Well: Core

| Bit | Description |
|-----|--------------------------------------------------------------------------------------------------------------------------------------------------------------------------------------------------------------------------------------------------------------------------------------|
| 7:5 | Reserved. Must be 0. |
| 4 | DMA Group Arbitration Priority — WO. Each channel group is individually assigned either fixed or rotating arbitration priority. At part reset, each group is initialized in fixed priority. 0 = Fixed priority to the channel group 1 = Rotating priority to the group. |
| 3 | Reserved. Must be 0. |
| 2 | DMA Channel Group Enable — WO. Both channel groups are enabled following part reset. 0 = Enable the DMA channel group. 1 = Disable. Disabling channel group 4–7 also disables channel group 0–3, which is cascaded through channel 4. |
| 1:0 | Reserved. Must be 0. |

13.2.5 DMASTA—DMA Status Register (LPC I/F—D31:F0)

I/O Address: Ch. #0–3 = 08h;
Ch. #4–7 = D0h Attribute: RO
Default Value: Undefined Size: 8-bit
Lockable: No Power Well: Core

| Bit | Description |
|-----|-----------------------------------------------------------------------------------------------------------------------------------------------------------------------------------------------------------------------------------------------------------------------------------------------------------------------------------------------------------------------------------------------------------------------------------------------------------------------------------------------------------------------|
| 7:4 | Channel Request Status — RO. When a valid DMA request is pending for a channel, the corresponding bit is set to 1. When a DMA request is not pending for a particular channel, the corresponding bit is set to 0. The source of the DREQ may be hardware or a software request. Note that channel 4 is the cascade channel, so the request status of channel 4 is a logical OR of the request status for channels 0 through 3. 4 = Channel 0 5 = Channel 1 (5) 6 = Channel 2 (6) 7 = Channel 3 (7) |
| 3:0 | Channel Terminal Count Status — RO. When a channel reaches terminal count (TC), its status bit is set to 1. If TC has not been reached, the status bit is set to 0. Channel 4 is programmed for cascade, so the TC bit response for channel 4 is irrelevant. 0 = Channel 0 1 = Channel 1 (5) 2 = Channel 2 (6) 3 = Channel 3 (7) |



13.2.6 DMA_WRSMSK—DMA Write Single Mask Register (LPC I/F—D31:F0)

I/O Address: Ch. #0–3 = 0Ah;
 Ch. #4–7 = D4h
 Default Value: 0000 01xx
 Lockable: No

Attribute: WO
 Size: 8-bit
 Power Well: Core

| Bit | Description |
|-----|-----------------------------------------------------------------------------------------------------------------------------------------------------------------------------------------------------------------------------------------|
| 7:3 | Reserved. Must be 0. |
| 2 | Channel Mask Select — WO. 0 = Enable DREQ for the selected channel. The channel is selected through bits [1:0]. Therefore, only one channel can be masked / unmasked at a time. 1 = Disable DREQ for the selected channel. |
| 1:0 | DMA Channel Select — WO. These bits select the DMA Channel Mode Register to program. 00 = Channel 0 (4) 01 = Channel 1 (5) 10 = Channel 2 (6) 11 = Channel 3 (7) |



13.2.7 DMACH_MODE—DMA Channel Mode Register (LPC I/F—D31:F0)

I/O Address: Ch. #0–3 = 0Bh; Ch. #4–7 = D6h Attribute: WO
 Default Value: 0000 00xx Size: 8-bit
 Lockable: No Power Well: Core

| Bit | Description |
|-----|---------------------------------------------------------------------------------------------------------------------------------------------------------------------------------------------------------------------------------------------------------------------------------------------------------------------------------------------------------------------------------------------|
| 7:6 | DMA Transfer Mode — WO. Each DMA channel can be programmed in one of four different modes: 00 = Demand mode 01 = Single mode 10 = Reserved 11 = Cascade mode |
| 5 | Address Increment/Decrement Select — WO. This bit controls address increment/decrement during DMA transfers. 0 = Address increment. (default after part reset or Master Clear) 1 = Address decrement. |
| 4 | Autoinitialize Enable — WO. 0 = Autoinitialize feature is disabled and DMA transfers terminate on a terminal count. A part reset or Master Clear disables autoinitialization. 1 = DMA restores the Base Address and Count registers to the current registers following a terminal count (TC). |
| 3:2 | DMA Transfer Type — WO. These bits represent the direction of the DMA transfer. When the channel is programmed for cascade mode, (bits[7:6] = 11) the transfer type is irrelevant. 00 = Verify – No I/O or memory strobes generated 01 = Write – Data transferred from the I/O devices to memory 10 = Read – Data transferred from memory to the I/O device 11 = Invalid |
| 1:0 | DMA Channel Select — WO. These bits select the DMA Channel Mode Register that will be written by bits [7:2]. 00 = Channel 0 (4) 01 = Channel 1 (5) 10 = Channel 2 (6) 11 = Channel 3 (7) |



13.2.8 DMA Clear Byte Pointer Register (LPC I/F—D31:F0)

I/O Address: Ch. #0–3 = 0Ch;
 Ch. #4–7 = D8h
 Attribute: WO
 Default Value: xxxx xxxx
 Size: 8-bit
 Lockable: No
 Power Well: Core

| Bit | Description |
|-----|-----------------------------------------------------------------------------------------------------------------------------------------------------------------------------------------------------------------------------------------------------------------------------------------------------------------------------------------------------------------------------------------------------------------------------------------------------------------------------------------------------------------------------------------------------------------------------------------------------------------------------|
| 7:0 | Clear Byte Pointer — WO. No specific pattern. Command enabled with a write to the I/O port address. Writing to this register initializes the byte pointer flip/flop to a known state. It clears the internal latch used to address the upper or lower byte of the 16-bit Address and Word Count Registers. The latch is also cleared by part reset and by the Master Clear command. This command precedes the first access to a 16-bit DMA controller register. The first access to a 16-bit register will then access the significant byte, and the second access automatically accesses the most significant byte. |

13.2.9 DMA Master Clear Register (LPC I/F—D31:F0)

I/O Address: Ch. #0–3 = 0Dh;
 Ch. #4–7 = DAh
 Attribute: WO
 Default Value: xxxx xxxx
 Size: 8-bit

| Bit | Description |
|-----|-----------------------------------------------------------------------------------------------------------------------------------------------------------------------------------------------------------------------------------------------|
| 7:0 | Master Clear — WO. No specific pattern. Enabled with a write to the port. This has the same effect as the hardware Reset. The Command, Status, Request, and Byte Pointer flip/flop registers are cleared and the Mask Register is set. |

13.2.10 DMA_CLMSK—DMA Clear Mask Register (LPC I/F—D31:F0)

I/O Address: Ch. #0–3 = 0Eh;
 Ch. #4–7 = DCh
 Attribute: WO
 Default Value: xxxx xxxx
 Size: 8-bit
 Lockable: No
 Power Well: Core

| Bit | Description |
|-----|-------------------------------------------------------------------------------------------------|
| 7:0 | Clear Mask Register — WO. No specific pattern. Command enabled with a write to the port. |



13.2.11 DMA_WRMSK—DMA Write All Mask Register (LPC I/F—D31:F0)

I/O Address: Ch. #0–3 = 0Fh; Attribute: R/W
 Ch. #4–7 = DEh
 Default Value: 0000 1111 Size: 8-bit
 Lockable: No Power Well: Core

| Bit | Description |
|-----|------------------------------------------------------------------------------------------------------------------------------------------------------------------------------------------------------------------------------------------------------------------------------------------------------------------------------------------------------------------------------------------------------------------------------------------------------------------------------------------------------------------------------------------------------------------------------------------------------------------------------------------------------------------------------------------------------------------------------------------------------------------------------------------------------------------------------------------------------------------------------------------------------------------------------------------------------------------------------------------------------------------------------------------------------------------------------------------------------------------------------------------------------------------|
| 7:4 | Reserved. Must be 0. |
| 3:0 | <p>Channel Mask Bits — R/W. This register permits all four channels to be simultaneously enabled/disabled instead of enabling/disabling each channel individually, as is the case with the Mask Register – Write Single Mask Bit. In addition, this register has a read path to allow the status of the channel mask bits to be read. A channel's mask bit is automatically set to 1 when the Current Byte/Word Count Register reaches terminal count (unless the channel is in auto-initialization mode). Setting the bit(s) to a 1 disables the corresponding DREQ(s). Setting the bit(s) to a 0 enables the corresponding DREQ(s). Bits [3:0] are set to 1 upon part reset or Master Clear. When read, bits [3:0] indicate the DMA channel [3:0] ([7:4]) mask status.</p> <p>Bit 0 = Channel 0 (4)1 = Masked, 0 = Not Masked Bit 1 = Channel 1 (5)1 = Masked, 0 = Not Masked Bit 2 = Channel 2 (6)1 = Masked, 0 = Not Masked Bit 3 = Channel 3 (7)1 = Masked, 0 = Not Masked</p> <p>NOTE: Disabling channel 4 also disables channels 0–3 due to the cascade of channels 0–3 through channel 4.</p> |



13.3 Timer I/O Registers (LPC I/F—D31:F0)

| Port | Aliases | Register Name | Default Value | Type |
|------|---------|--------------------------------------------|---------------|------|
| 40h | 50h | Counter 0 Interval Time Status Byte Format | 0XXXXXXXXb | RO |
| | | Counter 0 Counter Access Port | Undefined | R/W |
| 41h | 51h | Counter 1 Interval Time Status Byte Format | 0XXXXXXXXb | RO |
| | | Counter 1 Counter Access Port | Undefined | R/W |
| 42h | 52h | Counter 2 Interval Time Status Byte Format | 0XXXXXXXXb | RO |
| | | Counter 2 Counter Access Port | Undefined | R/W |
| 43h | 53h | Timer Control Word | Undefined | WO |
| | | Timer Control Word Register | XXXXXXXX0b | WO |
| | | Counter Latch Command | X0h | WO |



RDBK_CMD—Read Back Command (LPC I/F—D31:F0)

The Read Back Command is used to determine the count value, programmed mode, and current states of the OUT pin and Null count flag of the selected counter or counters. Status and/or count may be latched in any or all of the counters by selecting the counter during the register write. The count and status remain latched until read, and further latch commands are ignored until the count is read. Both count and status of the selected counters may be latched simultaneously by setting both bit 5 and bit 4 to 0. If both are latched, the first read operation from that counter returns the latched status. The next one or two reads, depending on whether the counter is programmed for one or two byte counts, returns the latched count. Subsequent reads return an unlatched count.

| Bit | Description |
|-----|-------------------------------------------------------------------------------------------------------------------------------------------------------|
| 7:6 | Read Back Command. Must be 11 to select the Read Back Command |
| 5 | Latch Count of Selected Counters. 0 = Current count value of the selected counters will be latched 1 = Current count will not be latched |
| 4 | Latch Status of Selected Counters. 0 = Status of the selected counters will be latched 1 = Status will not be latched |
| 3 | Counter 2 Select. 1 = Counter 2 count and/or status will be latched |
| 2 | Counter 1 Select. 1 = Counter 1 count and/or status will be latched |
| 1 | Counter 0 Select. 1 = Counter 0 count and/or status will be latched. |
| 0 | Reserved. Must be 0. |

LTCH_CMD—Counter Latch Command (LPC I/F—D31:F0)

The Counter Latch Command latches the current count value. This command is used to insure that the count read from the counter is accurate. The count value is then read from each counter's count register through the Counter Ports Access Ports Register (40h for counter 0, 41h for counter 1, and 42h for counter 2). The count must be read according to the programmed format, i.e., if the counter is programmed for two byte counts, two bytes must be read. The two bytes do not have to be read one right after the other (read, write, or programming operations for other counters may be inserted between the reads). If a counter is latched once and then latched again before the count is read, the second Counter Latch Command is ignored.

| Bit | Description |
|-----|-------------------------------------------------------------------------------------------------------------------------------------------------------------------------------------------------------|
| 7:6 | Counter Selection. These bits select the counter for latching. If "11" is written, then the write is interpreted as a read back command. 00 = Counter 0 01 = Counter 1 10 = Counter 2 |
| 5:4 | Counter Latch Command. 00 = Selects the Counter Latch Command. |
| 3:0 | Reserved. Must be 0. |

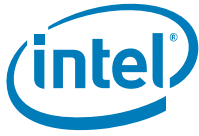

13.3.2 SBYTE_FMT—Interval Timer Status Byte Format Register (LPC I/F—D31:F0)

I/O Address: Counter 0 = 40h,
 Counter 1 = 41h, Attribute: RO
 Counter 2 = 42h Size: 8 bits per counter
 Default Value: Bits[6:0] undefined, Bit 7=0

Each counter's status byte can be read following a Read Back Command. If latch status is chosen (bit 4=0, Read Back Command) as a read back option for a given counter, the next read from the counter's Counter Access Ports Register (40h for counter 0, 41h for counter 1, and 42h for counter 2) returns the status byte. The status byte returns the following:

| Bit | Description |
|-----|------------------------------------------------------------------------------------------------------------------------------------------------------------------------------------------------------------------------------------------------------------------------------------------------------------------------------------------------------------------------------------------------------------------------------------------------------------------------------------------------------------|
| 7 | Counter OUT Pin State — RO. 0 = OUT pin of the counter is also a 0 1 = OUT pin of the counter is also a 1 |
| 6 | Count Register Status — RO. This bit indicates when the last count written to the Count Register (CR) has been loaded into the counting element (CE). The exact time this happens depends on the counter mode, but until the count is loaded into the counting element (CE), the count value will be incorrect. 0 = Count has been transferred from CR to CE and is available for reading. 1 = Null Count. Count has not been transferred from CR to CE and is not yet available for reading. |
| 5:4 | Read/Write Selection Status — RO. These reflect the read/write selection made through bits[5:4] of the control register. The binary codes returned during the status read match the codes used to program the counter read/write selection. 00 = Counter Latch Command 01 = Read/Write Least Significant Byte (LSB) 10 = Read/Write Most Significant Byte (MSB) 11 = Read/Write LSB then MSB |
| 3:1 | Mode Selection Status — RO. These bits return the counter mode programming. The binary code returned matches the code used to program the counter mode, as listed under the bit function above. 000 = Mode 0 — Out signal on end of count (=0) 001 = Mode 1 — Hardware retriggerable one-shot x10 = Mode 2 — Rate generator (divide by n counter) x11 = Mode 3 — Square wave output 100 = Mode 4 — Software triggered strobe 101 = Mode 5 — Hardware triggered strobe |
| 0 | Countdown Type Status — RO. This bit reflects the current countdown type. 0 = Binary countdown 1 = Binary Coded Decimal (BCD) countdown. |



13.3.3 Counter Access Ports Register (LPC I/F—D31:F0)

I/O Address: Counter 0 – 40h,
 Counter 1 – 41h, Attribute: R/W
 Counter 2 – 42h
 Default Value: All bits undefined Size: 8 bit

| Bit | Description |
|-----|--------------------------------------------------------------------------------------------------------------------------------------------------------------------------------------------------------------------------------------------------------------------------------------------------------------------------------------------------------------------------------------------------------------|
| 7:0 | Counter Port — R/W. Each counter port address is used to program the 16-bit Count Register. The order of programming, either LSB only, MSB only, or LSB then MSB, is defined with the Interval Counter Control Register at port 43h. The counter port is also used to read the current count from the Count Register, and return the status of the counter programming following a Read Back Command. |



13.4 8259 Interrupt Controller (PIC) Registers (LPC I/F—D31:F0)

13.4.1 Interrupt Controller I/O MAP (LPC I/F—D31:F0)

The interrupt controller registers are located at 20h and 21h for the master controller (IRQ 0–7), and at A0h and A1h for the slave controller (IRQ 8–13). These registers have multiple functions, depending upon the data written to them. Table 13-3 shows the different register possibilities for each address.

Table 13-3. PIC Registers (LPC I/F—D31:F0)

| Port | Aliases | Register Name | Default Value | Type |
|------|--------------------------------------------|----------------------------------|---------------|------|
| 20h | 24h, 28h, 2Ch, 30h, 34h, 38h, 3Ch | Master PIC ICW1 Init. Cmd Word 1 | Undefined | WO |
| | | Master PIC OCW2 Op Ctrl Word 2 | 001XXXXXb | WO |
| | | Master PIC OCW3 Op Ctrl Word 3 | X01XXX10b | WO |
| 21h | 25h, 29h, 2Dh, 31h, 35h, 39h, 3Dh | Master PIC ICW2 Init. Cmd Word 2 | Undefined | WO |
| | | Master PIC ICW3 Init. Cmd Word 3 | Undefined | WO |
| | | Master PIC ICW4 Init. Cmd Word 4 | 01h | WO |
| | | Master PIC OCW1 Op Ctrl Word 1 | 00h | R/W |
| A0h | A4h, A8h, ACh, B0h, B4h, B8h, BCh | Slave PIC ICW1 Init. Cmd Word 1 | Undefined | WO |
| | | Slave PIC OCW2 Op Ctrl Word 2 | 001XXXXXb | WO |
| | | Slave PIC OCW3 Op Ctrl Word 3 | X01XXX10b | WO |
| A1h | A5h, A9h, ADh, B1h, B5h, B9h, BDh | Slave PIC ICW2 Init. Cmd Word 2 | Undefined | WO |
| | | Slave PIC ICW3 Init. Cmd Word 3 | Undefined | WO |
| | | Slave PIC ICW4 Init. Cmd Word 4 | 01h | WO |
| | | Slave PIC OCW1 Op Ctrl Word 1 | 00h | R/W |
| 4D0h | – | Master PIC Edge/Level Triggered | 00h | R/W |
| 4D1h | – | Slave PIC Edge/Level Triggered | 00h | R/W |

Note: Refer to note addressing active-low interrupt sources in 8259 Interrupt Controllers section (Section 5.8).



13.4.2 ICW1—Initialization Command Word 1 Register (LPC I/F—D31:F0)

Offset Address: Master Controller – 20h Attribute: WO
 Slave Controller – A0h Size: 8 bit /controller
 Default Value: All bits undefined

A write to Initialization Command Word 1 starts the interrupt controller initialization sequence, during which the following occurs:

1. The Interrupt Mask register is cleared.
2. IRQ7 input is assigned priority 7.
3. The slave mode address is set to 7.
4. Special mask mode is cleared and Status Read is set to IRR.

Once this write occurs, the controller expects writes to ICW2, ICW3, and ICW4 to complete the initialization sequence.

| Bit | Description |
|-----|-----------------------------------------------------------------------------------------------------------------------------------------------|
| 7:5 | ICW/OCW Select — WO. These bits are MCS-85 specific, and not needed. 000 = Should be programmed to “000” |
| 4 | ICW/OCW Select — WO. 1 = This bit must be a 1 to select ICW1 and enable the ICW2, ICW3, and ICW4 sequence. |
| 3 | Edge/Level Bank Select (LTIM) — WO. Disabled. Replaced by the edge/level triggered control registers (ELCR, D31:F0:4D0h, D31:F0:4D1h). |
| 2 | ADI — WO. 0 = Ignored for the ICH10. Should be programmed to 0. |
| 1 | Single or Cascade (SNGL) — WO. 0 = Must be programmed to a 0 to indicate two controllers operating in cascade mode. |
| 0 | ICW4 Write Required (IC4) — WO. 1 = This bit must be programmed to a 1 to indicate that ICW4 needs to be programmed. |



13.4.3 ICW2—Initialization Command Word 2 Register (LPC I/F—D31:F0)

Offset Address: Master Controller – 21h Attribute: WO
 Slave Controller – A1h Size: 8 bit /controller
 Default Value: All bits undefined

ICW2 is used to initialize the interrupt controller with the five most significant bits of the interrupt vector address. The value programmed for bits[7:3] is used by the processor to define the base address in the interrupt vector table for the interrupt routines associated with each IRQ on the controller. Typical ISA ICW2 values are 08h for the master controller and 70h for the slave controller.

| Bit | Description | | | | | | | | | | | | | | | | | | | | | | | | | | | |
|------|-------------------------------------------------------------------------------------------------------------------------------------------------------------------------------------------------------------------------------------------------------------------------------------------------------------------------------------------------------------------------------------------------------------------------------------------------------------------------------------------------------------------------------------------------------------------------------------------------------------------------------------------------------------------------------------------------------------------------------------------------------------------------------------------------------------------------------------------------------------------------------------------------------------------------------------------------------------------------------|-----------------|------------------|-----------------|------|------|------|------|------|------|------|------|-------|------|------|-------|------|------|-------|------|------|-------|------|------|-------|------|------|-------|
| 7:3 | Interrupt Vector Base Address — WO. Bits [7:3] define the base address in the interrupt vector table for the interrupt routines associated with each interrupt request level input. | | | | | | | | | | | | | | | | | | | | | | | | | | | |
| 2:0 | <p>Interrupt Request Level — WO. When writing ICW2, these bits should all be 0. During an interrupt acknowledge cycle, these bits are programmed by the interrupt controller with the interrupt to be serviced. This is combined with bits [7:3] to form the interrupt vector driven onto the data bus during the second INTA# cycle. The code is a three bit binary code:</p> <table border="1"> <thead> <tr> <th>Code</th> <th>Master Interrupt</th> <th>Slave Interrupt</th> </tr> </thead> <tbody> <tr> <td>000b</td> <td>IRQ0</td> <td>IRQ8</td> </tr> <tr> <td>001b</td> <td>IRQ1</td> <td>IRQ9</td> </tr> <tr> <td>010b</td> <td>IRQ2</td> <td>IRQ10</td> </tr> <tr> <td>011b</td> <td>IRQ3</td> <td>IRQ11</td> </tr> <tr> <td>100b</td> <td>IRQ4</td> <td>IRQ12</td> </tr> <tr> <td>101b</td> <td>IRQ5</td> <td>IRQ13</td> </tr> <tr> <td>110b</td> <td>IRQ6</td> <td>IRQ14</td> </tr> <tr> <td>111b</td> <td>IRQ7</td> <td>IRQ15</td> </tr> </tbody> </table> | Code | Master Interrupt | Slave Interrupt | 000b | IRQ0 | IRQ8 | 001b | IRQ1 | IRQ9 | 010b | IRQ2 | IRQ10 | 011b | IRQ3 | IRQ11 | 100b | IRQ4 | IRQ12 | 101b | IRQ5 | IRQ13 | 110b | IRQ6 | IRQ14 | 111b | IRQ7 | IRQ15 |
| Code | Master Interrupt | Slave Interrupt | | | | | | | | | | | | | | | | | | | | | | | | | | |
| 000b | IRQ0 | IRQ8 | | | | | | | | | | | | | | | | | | | | | | | | | | |
| 001b | IRQ1 | IRQ9 | | | | | | | | | | | | | | | | | | | | | | | | | | |
| 010b | IRQ2 | IRQ10 | | | | | | | | | | | | | | | | | | | | | | | | | | |
| 011b | IRQ3 | IRQ11 | | | | | | | | | | | | | | | | | | | | | | | | | | |
| 100b | IRQ4 | IRQ12 | | | | | | | | | | | | | | | | | | | | | | | | | | |
| 101b | IRQ5 | IRQ13 | | | | | | | | | | | | | | | | | | | | | | | | | | |
| 110b | IRQ6 | IRQ14 | | | | | | | | | | | | | | | | | | | | | | | | | | |
| 111b | IRQ7 | IRQ15 | | | | | | | | | | | | | | | | | | | | | | | | | | |



13.4.6 ICW4—Initialization Command Word 4 Register (LPC I/F—D31:F0)

Offset Address: Master Controller – 021h Attribute: WO
Slave Controller – 0A1h Size: 8 bits
Default Value: 01h

| Bit | Description |
|-----|------------------------------------------------------------------------------------------------------------------------------------------------------------------------------------------------------|
| 7:5 | 0 = These bits must be programmed to 0. |
| 4 | Special Fully Nested Mode (SFNM) — WO. 0 = Should normally be disabled by writing a 0 to this bit. 1 = Special fully nested mode is programmed. |
| 3 | Buffered Mode (BUF) — WO. 0 = Must be programmed to 0 for the ICH10. This is non-buffered mode. |
| 2 | Master/Slave in Buffered Mode — WO. Not used. 0 = Should always be programmed to 0. |
| 1 | Automatic End of Interrupt (AEOI) — WO. 0 = This bit should normally be programmed to 0. This is the normal end of interrupt. 1 = Automatic End of Interrupt (AEOI) mode is programmed. |
| 0 | Microprocessor Mode — WO. 1 = Must be programmed to 1 to indicate that the controller is operating in an Intel Architecture-based system. |

13.4.7 OCW1—Operational Control Word 1 (Interrupt Mask) Register (LPC I/F—D31:F0)

Offset Address: Master Controller – 021h Attribute: R/W
Slave Controller – 0A1h Size: 8 bits
Default Value: 00h

| Bit | Description |
|-----|-------------------------------------------------------------------------------------------------------------------------------------------------------------------------------------------------------------------------------------------------------------------------------------------------------------------------------------------------------------------------------------------------|
| 7:0 | Interrupt Request Mask — R/W. When a 1 is written to any bit in this register, the corresponding IRQ line is masked. When a 0 is written to any bit in this register, the corresponding IRQ mask bit is cleared, and interrupt requests will again be accepted by the controller. Masking IRQ2 on the master controller will also mask the interrupt requests from the slave controller. |



13.4.8 OCW2—Operational Control Word 2 Register (LPC I/F—D31:F0)

Offset Address: Master Controller – 020h Attribute: WO
 Slave Controller – 0A0h Size: 8 bits
 Default Value: Bit[4:0]=undefined, Bit[7:5]=001

Following a part reset or ICW initialization, the controller enters the fully nested mode of operation. Non-specific EOI without rotation is the default. Both rotation mode and specific EOI mode are disabled following initialization.

| Bit | Description | | | | | | | | | | | | | | | | | | | | |
|------|-------------------------------------------------------------------------------------------------------------------------------------------------------------------------------------------------------------------------------------------------------------------------------------------------------------------------------------------------------------------------------------------------------------------------------------------------------------------------------------------------------------------------------------------------------------------------------------------------------------------------------------------------------------------------------------------------------------------------------------------------------------------------------------------------------------------------------|------|-----------------|------|-----------------|------|--------|------|---------|------|--------|------|---------|------|---------|------|---------|------|---------|------|---------|
| 7:5 | <p>Rotate and EOI Codes (R, SL, EOI) — WO. These three bits control the Rotate and End of Interrupt modes and combinations of the two.</p> <p>000 = Rotate in Auto EOI Mode (Clear) 001 = Non-specific EOI command 010 = No Operation 011 = *Specific EOI Command 100 = Rotate in Auto EOI Mode (Set) 101 = Rotate on Non-Specific EOI Command 110 = *Set Priority Command 111 = *Rotate on Specific EOI Command *L0 – L2 Are Used</p> | | | | | | | | | | | | | | | | | | | | |
| 4:3 | <p>OCW2 Select — WO. When selecting OCW2, bits 4:3 = "00"</p> | | | | | | | | | | | | | | | | | | | | |
| 2:0 | <p>Interrupt Level Select (L2, L1, L0) — WO. L2, L1, and L0 determine the interrupt level acted upon when the SL bit is active. A simple binary code, outlined below, selects the channel for the command to act upon. When the SL bit is inactive, these bits do not have a defined function; programming L2, L1 and L0 to 0 is sufficient in this case.</p> <table border="1"> <thead> <tr> <th>Code</th> <th>Interrupt Level</th> <th>Code</th> <th>Interrupt Level</th> </tr> </thead> <tbody> <tr> <td>000b</td> <td>IRQ0/8</td> <td>000b</td> <td>IRQ4/12</td> </tr> <tr> <td>001b</td> <td>IRQ1/9</td> <td>001b</td> <td>IRQ5/13</td> </tr> <tr> <td>010b</td> <td>IRQ2/10</td> <td>010b</td> <td>IRQ6/14</td> </tr> <tr> <td>011b</td> <td>IRQ3/11</td> <td>011b</td> <td>IRQ7/15</td> </tr> </tbody> </table> | Code | Interrupt Level | Code | Interrupt Level | 000b | IRQ0/8 | 000b | IRQ4/12 | 001b | IRQ1/9 | 001b | IRQ5/13 | 010b | IRQ2/10 | 010b | IRQ6/14 | 011b | IRQ3/11 | 011b | IRQ7/15 |
| Code | Interrupt Level | Code | Interrupt Level | | | | | | | | | | | | | | | | | | |
| 000b | IRQ0/8 | 000b | IRQ4/12 | | | | | | | | | | | | | | | | | | |
| 001b | IRQ1/9 | 001b | IRQ5/13 | | | | | | | | | | | | | | | | | | |
| 010b | IRQ2/10 | 010b | IRQ6/14 | | | | | | | | | | | | | | | | | | |
| 011b | IRQ3/11 | 011b | IRQ7/15 | | | | | | | | | | | | | | | | | | |

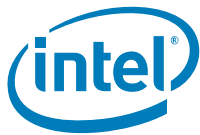

13.4.9 OCW3—Operational Control Word 3 Register (LPC I/F—D31:F0)

Offset Address: Master Controller – 020h Attribute: WO
 Slave Controller – 0A0h Size: 8 bits
 Default Value: Bit[6,0]=0, Bit[7,4:2]=undefined,
 Bit[5,1]=1

| Bit | Description |
|-----|-----------------------------------------------------------------------------------------------------------------------------------------------------------------------------------------------------------------------------------------------------------------------------------------------------------------------------------------------------------------------------------------------------------------------------------------------------------------------------------------------------------------------------------------------------------------------------------------------------------------------------------------------------------------------------------------------------------------------------------------------------------------------------------------------------------------------------------------|
| 7 | Reserved. Must be 0. |
| 6 | Special Mask Mode (SMM) — WO. 1 = The Special Mask Mode can be used by an interrupt service routine to dynamically alter the system priority structure while the routine is executing, through selective enabling/disabling of the other channel's mask bits. Bit 5, the ESMM bit, must be set for this bit to have any meaning. |
| 5 | Enable Special Mask Mode (ESMM) — WO. 0 = Disable. The SMM bit becomes a "don't care". 1 = Enable the SMM bit to set or reset the Special Mask Mode. |
| 4:3 | OCW3 Select — WO. When selecting OCW3, bits 4:3 = 01 |
| 2 | Poll Mode Command — WO. 0 = Disable. Poll Command is not issued. 1 = Enable. The next I/O read to the interrupt controller is treated as an interrupt acknowledge cycle. An encoded byte is driven onto the data bus, representing the highest priority level requesting service. |
| 1:0 | Register Read Command — WO. These bits provide control for reading the In-Service Register (ISR) and the Interrupt Request Register (IRR). When bit 1=0, bit 0 will not affect the register read selection. When bit 1=1, bit 0 selects the register status returned following an OCW3 read. If bit 0=0, the IRR will be read. If bit 0=1, the ISR will be read. Following ICW initialization, the default OCW3 port address read will be "read IRR". To retain the current selection (read ISR or read IRR), always write a 0 to bit 1 when programming this register. The selected register can be read repeatedly without reprogramming OCW3. To select a new status register, OCW3 must be reprogrammed prior to attempting the read. 00 = No Action 01 = No Action 10 = Read IRQ Register 11 = Read IS Register |



13.4.10 ELCR1—Master Controller Edge/Level Triggered Register (LPC I/F—D31:F0)

Offset Address: 4D0h
Default Value: 00h

Attribute: R/W
Size: 8 bits

In edge mode, (bit[x] = 0), the interrupt is recognized by a low to high transition. In level mode (bit[x] = 1), the interrupt is recognized by a high level. The cascade channel, IRQ2, the heart beat timer (IRQ0), and the keyboard controller (IRQ1), cannot be put into level mode.

| Bit | Description |
|-----|---------------------------------------------------|
| 7 | IRQ7 ECL — R/W. 0 = Edge. 1 = Level. |
| 6 | IRQ6 ECL — R/W. 0 = Edge. 1 = Level. |
| 5 | IRQ5 ECL — R/W. 0 = Edge. 1 = Level. |
| 4 | IRQ4 ECL — R/W. 0 = Edge. 1 = Level. |
| 3 | IRQ3 ECL — R/W. 0 = Edge. 1 = Level. |
| 2:0 | Reserved. Must be 0. |



13.4.11 ELCR2—Slave Controller Edge/Level Triggered Register (LPC I/F—D31:F0)

Offset Address: 4D1h
Default Value: 00h

Attribute: R/W
Size: 8 bits

In edge mode, (bit[x] = 0), the interrupt is recognized by a low to high transition. In level mode (bit[x] = 1), the interrupt is recognized by a high level. The real time clock, IRQ8#, and the floating point error interrupt, IRQ13, cannot be programmed for level mode.

| Bit | Description |
|-----|--------------------------------------------------|
| 7 | IRQ15 ECL — R/W. 0 = Edge 1 = Level |
| 6 | IRQ14 ECL — R/W. 0 = Edge 1 = Level |
| 5 | Reserved. Must be 0. |
| 4 | IRQ12 ECL — R/W. 0 = Edge 1 = Level |
| 3 | IRQ11 ECL — R/W. 0 = Edge 1 = Level |
| 2 | IRQ10 ECL — R/W. 0 = Edge 1 = Level |
| 1 | IRQ9 ECL — R/W. 0 = Edge 1 = Level |
| 0 | Reserved. Must be 0. |



13.5 Advanced Programmable Interrupt Controller (APIC)(D31:F0)

13.5.1 APIC Register Map (LPC I/F—D31:F0)

The APIC is accessed via an indirect addressing scheme. Two registers are visible by software for manipulation of most of the APIC registers. These registers are mapped into memory space. The address bits 15:12 (Consumer Only) and 19:12 (Corporate Only) of the address range are programmable through bits 7:4 (Consumer Only) and 7:0 (Corporate Only) of OIC register (Chipset Config Registers: Offset 31FFh for Consumer Family and Offset 31FEh for Corporate family) The registers are shown in Table 13-4.

Table 13-4. APIC Direct Registers (LPC I/F—D31:F0)

| Address | Mnemonic | Register Name | Size | Type |
|------------------------------|----------|---------------|---------|------|
| FEC_ _0000h (Corporate Only) | IND | Index | 8 bits | R/W |
| FECO_0000h (Consumer Only) | IND | Index | 8 bits | R/W |
| FEC_ _0010h (Corporate Only) | DAT | Data | 32 bits | R/W |
| FECO_0010h (Consumer Only) | DAT | Data | 32 bits | R/W |
| FEC_ _0040h (Corporate Only) | EOIR | EOI | 32 bits | WO |
| FECO_0040h (Consumer Only) | EOIR | EOI | 32 bits | WO |

Table 13-5 lists the registers which can be accessed within the APIC via the Index Register. When accessing these registers, accesses must be done one dword at a time. For example, software should never access byte 2 from the Data register before accessing bytes 0 and 1. The hardware will not attempt to recover from a bad programming model in this case.

Table 13-5. APIC Indirect Registers (LPC I/F—D31:F0)

| Index | Mnemonic | Register Name | Size | Type |
|-------|-------------|----------------------|---------|---------|
| 00 | ID | Identification | 32 bits | R/W |
| 01 | VER | Version | 32 bits | RO |
| 02–0F | — | Reserved | — | RO |
| 10–11 | REDIR_TBL0 | Redirection Table 0 | 64 bits | R/W, RO |
| 12–13 | REDIR_TBL1 | Redirection Table 1 | 64 bits | R/W, RO |
| ... | ... | ... | ... | ... |
| 3E–3F | REDIR_TBL23 | Redirection Table 23 | 64 bits | R/W, RO |
| 40–FF | — | Reserved | — | RO |



13.5.2 IND—Index Register (LPC I/F—D31:F0)

Memory Address FEC0_0000h (Consumer Only) Attribute: R/W
FEC_ _0000h (Corporate Only)
Default Value: 00h Size: 8 bits

The Index Register will select which APIC indirect register to be manipulated by software. The selector values for the indirect registers are listed in [Table 13-5](#). Software will program this register to select the desired APIC internal register

| Bit | Description |
|-----|-------------------------------------------------------------------------------------|
| 7:0 | APIC Index — R/W. This is an 8-bit pointer into the I/O APIC register table. |

13.5.3 DAT—Data Register (LPC I/F—D31:F0)

Memory Address FEC0_0000h (Consumer Only) Attribute: R/W
FEC_ _0000h (Corporate Only)
Default Value: 00000000h Size: 32 bits

This is a 32-bit register specifying the data to be read or written to the register pointed to by the Index register. This register can only be accessed in dword quantities.

| Bit | Description |
|-----|------------------------------------------------------------------------------------------------------------------------------------------------------------------------------------------------------------------|
| 7:0 | APIC Data — R/W. This is a 32-bit register for the data to be read or written to the APIC indirect register (Figure 13-5) pointed to by the Index register (Memory Address FEC0_0000h). |



13.5.4 EOIR—EOI Register (LPC I/F—D31:F0)

Memory Address FEC0_0000h (Consumer Only) Attribute: R/W
 FEC_0000h (Corporate Only)
 Default Value: N/A Size: 32 bits

The EOI register is present to provide a mechanism to maintain the level triggered semantics for level-triggered interrupts issued on the parallel bus.

When a write is issued to this register, the I/O APIC will check the lower 8 bits written to this register, and compare it with the vector field for each entry in the I/O Redirection Table. When a match is found, the Remote_IRR bit (Index Offset 10h, bit 14) for that I/O Redirection Entry will be cleared.

Note: If multiple I/O Redirection entries, for any reason, assign the same vector for more than one interrupt input, each of those entries will have the Remote_IRR bit reset to 0. The interrupt which was prematurely reset will not be lost because if its input remained active when the Remote_IRR bit is cleared, the interrupt will be reissued and serviced at a later time. Note: Only bits 7:0 are actually used. Bits 31:8 are ignored by the ICH10.

Note: To provide for future expansion, the processor should always write a value of 0 to Bits 31:8.

| Bit | Description |
|------|-----------------------------------------------------------------------------------------------------------------------------------------------------------------------------------------------------------------------------------------------------------------------------------------------|
| 31:8 | Reserved. To provide for future expansion, the processor should always write a value of 0 to Bits 31:8. |
| 7:0 | Redirection Entry Clear — WO. When a write is issued to this register, the I/O APIC will check this field, and compare it with the vector field for each entry in the I/O Redirection Table. When a match is found, the Remote_IRR bit for that I/O Redirection Entry will be cleared. |



13.5.7 REDIR_TBL—Redirection Table (LPC I/F—D31:F0)

Index Offset: 10h–11h (vector 0) through 3E–3Fh (vector 23)
 Attribute: R/W, RO
 Default Value: Bit 16 = 1. All other bits undefined
 Size: 64 bits each, (accessed as two 32 bit quantities)

The Redirection Table has a dedicated entry for each interrupt input pin. The information in the Redirection Table is used to translate the interrupt manifestation on the corresponding interrupt pin into an APIC message.

The APIC will respond to an edge triggered interrupt as long as the interrupt is held until after the acknowledge cycle has begun. Once the interrupt is detected, a delivery status bit internally to the I/O APIC is set. The state machine will step ahead and wait for an acknowledgment from the APIC unit that the interrupt message was sent. Only then will the I/O APIC be able to recognize a new edge on that interrupt pin. That new edge will only result in a new invocation of the handler if its acceptance by the destination APIC causes the Interrupt Request Register bit to go from 0 to 1. (In other words, if the interrupt was not already pending at the destination.)

| Bit | Description |
|-------|-------------------------------------------------------------------------------------------------------------------------------------------------------------------------------------------------------------------------------------------------------------------------------------------------------------------------------------------------------------------------------------------------------------------------------------------------------------------------------------------------------------------------------------------------------------------------------------------------------------------------------|
| 63:56 | Destination — R/W. If bit 11 of this entry is 0 (Physical), then bits 59:56 specifies an APIC ID. In this case, bits 63:59 should be programmed by software to 0. If bit 11 of this entry is 1 (Logical), then bits 63:56 specify the logical destination address of a set of processors. |
| 55:48 | Extended Destination ID (EDID) — RO. These bits are sent to a local APIC only when in Processor System Bus mode. They become bits 11:4 of the address. |
| 47:17 | Reserved |
| 16 | Mask — R/W. 0 = Not masked: An edge or level on this interrupt pin results in the delivery of the interrupt to the destination. 1 = Masked: Interrupts are not delivered nor held pending. Setting this bit after the interrupt is accepted by a local APIC has no effect on that interrupt. This behavior is identical to the device withdrawing the interrupt before it is posted to the processor. It is software's responsibility to deal with the case where the mask bit is set after the interrupt message has been accepted by a local APIC unit but before the interrupt is dispensed to the processor. |
| 15 | Trigger Mode — R/W. This field indicates the type of signal on the interrupt pin that triggers an interrupt. 0 = Edge triggered. 1 = Level triggered. |
| 14 | Remote IRR — R/W. This bit is used for level triggered interrupts; its meaning is undefined for edge triggered interrupts. 0 = Reset when an EOI message is received from a local APIC. 1 = Set when Local APIC/s accept the level interrupt sent by the I/O APIC. |
| 13 | Interrupt Input Pin Polarity — R/W. This bit specifies the polarity of each interrupt signal connected to the interrupt pins. 0 = Active high. 1 = Active low. |
| 12 | Delivery Status — RO. This field contains the current status of the delivery of this interrupt. Writes to this bit have no effect. 0 = Idle. No activity for this interrupt. 1 = Pending. Interrupt has been injected, but delivery is not complete. |



| Bit | Description |
|------|------------------------------------------------------------------------------------------------------------------------------------------------------------------------------------------------------------------------------------------------------------------------------------------------------------------------------------------------------------|
| 11 | Destination Mode — R/W. This field determines the interpretation of the Destination field. 0 = Physical. Destination APIC ID is identified by bits 59:56. 1 = Logical. Destinations are identified by matching bit 63:56 with the Logical Destination in the Destination Format Register and Logical Destination Register in each Local APIC. |
| 10:8 | Delivery Mode — R/W. This field specifies how the APICs listed in the destination field should act upon reception of this signal. Certain Delivery Modes will only operate as intended when used in conjunction with a specific trigger mode. These encodings are listed in the note below: |
| 7:0 | Vector — R/W. This field contains the interrupt vector for this interrupt. Values range between 10h and FEh. |

NOTE: Delivery Mode encoding:

- 000 = Fixed. Deliver the signal on the INTR signal of all processor cores listed in the destination. Trigger Mode can be edge or level.
- 001 = Lowest Priority. Deliver the signal on the INTR signal of the processor core that is executing at the lowest priority among all the processors listed in the specified destination. Trigger Mode can be edge or level.
- 010 = SMI (System Management Interrupt). Requires the interrupt to be programmed as edge triggered. The vector information is ignored but must be programmed to all 0s for future compatibility: **not supported**
- 011 = Reserved
- 100 = NMI. Deliver the signal on the NMI signal of all processor cores listed in the destination. Vector information is ignored. NMI is treated as an edge triggered interrupt even if it is programmed as level triggered. For proper operation this redirection table entry must be programmed to edge triggered. The NMI delivery mode does not set the RIRR bit. If the redirection table is incorrectly set to level, the loop count will continue counting through the redirection table addresses. Once the count for the NMI pin is reached again, the interrupt will be sent again: **not supported**
- 101 = INIT. Deliver the signal to all processor cores listed in the destination by asserting the INIT signal. All addressed local APICs will assume their INIT state. INIT is always treated as an edge triggered interrupt even if programmed as level triggered. For proper operation this redirection table entry must be programmed to edge triggered. The INIT delivery mode does not set the RIRR bit. If the redirection table is incorrectly set to level, the loop count will continue counting through the redirection table addresses. Once the count for the INIT pin is reached again, the interrupt will be sent again: **not supported**
- 110 = Reserved
- 111 = ExtINT. Deliver the signal to the INTR signal of all processor cores listed in the destination as an interrupt that originated in an externally connected 8259A compatible interrupt controller. The INTA cycle that corresponds to this ExtINT delivery will be routed to the external controller that is expected to supply the vector. Requires the interrupt to be programmed as edge triggered.



13.6 Real Time Clock Registers

13.6.1 I/O Register Address Map

The RTC internal registers and RAM are organized as two banks of 128 bytes each, called the standard and extended banks. The first 14 bytes of the standard bank contain the RTC time and date information along with four registers, A–D, that are used for configuration of the RTC. The extended bank contains a full 128 bytes of battery backed SRAM, and will be accessible even when the RTC module is disabled (via the RTC configuration register). Registers A–D do not physically exist in the RAM.

All data movement between the host processor and the real-time clock is done through registers mapped to the standard I/O space. The register map appears in [Table 13-6](#).

Table 13-6. RTC I/O Registers

| I/O Locations | If U128E bit = 0 | Function |
|---------------|---------------------------|------------------------------------------------|
| 70h and 74h | Also alias to 72h and 76h | Real-Time Clock (Standard RAM) Index Register |
| 71h and 75h | Also alias to 73h and 77h | Real-Time Clock (Standard RAM) Target Register |
| 72h and 76h | | Extended RAM Index Register (if enabled) |
| 73h and 77h | | Extended RAM Target Register (if enabled) |

NOTES:

1. I/O locations 70h and 71h are the standard legacy location for the real-time clock. The map for this bank is shown in [Table 13-7](#). Locations 72h and 73h are for accessing the extended RAM. The extended RAM bank is also accessed using an indexed scheme. I/O address 72h is used as the address pointer and I/O address 73h is used as the data register. Index addresses above 127h are not valid. If the extended RAM is not needed, it may be disabled.
2. Software must preserve the value of bit 7 at I/O addresses 70h and 74h. When writing to this address, software must first read the value, and then write the same value for bit 7 during the sequential address write. Note that port 70h is not directly readable. The only way to read this register is through Alt Access mode. Although RTC Index bits 6:0 are readable from port 74h, bit 7 will always return 0. If the NMI# enable is not changed during normal operation, software can alternatively read this bit once and then retain the value for all subsequent writes to port 70h.



13.6.2 Indexed Registers

The RTC contains two sets of indexed registers that are accessed using the two separate Index and Target registers (70/71h or 72/73h), as shown in [Table 13-7](#).

Table 13-7. RTC (Standard) RAM Bank

| Index | Name |
|---------|-----------------------|
| 00h | Seconds |
| 01h | Seconds Alarm |
| 02h | Minutes |
| 03h | Minutes Alarm |
| 04h | Hours |
| 05h | Hours Alarm |
| 06h | Day of Week |
| 07h | Day of Month |
| 08h | Month |
| 09h | Year |
| 0Ah | Register A |
| 0Bh | Register B |
| 0Ch | Register C |
| 0Dh | Register D |
| 0Eh–7Fh | 114 Bytes of User RAM |



13.6.2.1 RTC_REGA—Register A

| | | | |
|----------------|-----------|-------------|-------|
| RTC Index: | 0A | Attribute: | R/W |
| Default Value: | Undefined | Size: | 8-bit |
| Lockable: | No | Power Well: | RTC |

This register is used for general configuration of the RTC functions. None of the bits are affected by RSMRST# or any other ICH10 reset signal.

| Bit | Description |
|-----|----------------------------------------------------------------------------------------------------------------------------------------------------------------------------------------------------------------------------------------------------------------------------------------------------------------------------------------------------------------------------------------------------------------------------------------------------------------------------------------------------------------------------------------------------------------------------------------------------------------------------------------------------------------------------------------------------------------------------------------------------------------------------------------------------------------------------------|
| 7 | <p>Update In Progress (UIP) — R/W. This bit may be monitored as a status flag.</p> <p>0 = The update cycle will not start for at least 488 μs. The time, calendar, and alarm information in RAM is always available when the UIP bit is 0.</p> <p>1 = The update is soon to occur or is in progress.</p> |
| 6:4 | <p>Division Chain Select (DV[2:0]) — R/W. These three bits control the divider chain for the oscillator, and are not affected by RSMRST# or any other reset signal.</p> <p>010 = Normal Operation</p> <p>11X = Divider Reset</p> <p>101 = Bypass 15 stages (test mode only)</p> <p>100 = Bypass 10 stages (test mode only)</p> <p>011 = Bypass 5 stages (test mode only)</p> <p>001 = Invalid</p> <p>000 = Invalid</p> |
| 3:0 | <p>Rate Select (RS[3:0]) — R/W. Selects one of 13 taps of the 15 stage divider chain. The selected tap can generate a periodic interrupt if the PIE bit is set in Register B. Otherwise this tap will set the PF flag of Register C. If the periodic interrupt is not to be used, these bits should all be set to 0. RS3 corresponds to bit 3.</p> <p>0000 = Interrupt never toggles</p> <p>0001 = 3.90625 ms</p> <p>0010 = 7.8125 ms</p> <p>0011 = 122.070 μs</p> <p>0100 = 244.141 μs</p> <p>0101 = 488.281 μs</p> <p>0110 = 976.5625 μs</p> <p>0111 = 1.953125 ms</p> <p>1000 = 3.90625 ms</p> <p>1001 = 7.8125 ms</p> <p>1010 = 15.625 ms</p> <p>1011 = 31.25 ms</p> <p>1100 = 62.5 ms</p> <p>1101 = 125 ms</p> <p>1110 = 250 ms</p> <p>1111 = 500 ms</p> |



13.6.2.2 RTC_REGB—Register B (General Configuration)

RTC Index: 0Bh Attribute: R/W
 Default Value: U0U00UUU (U: Undefined) Size: 8-bit
 Lockable: No Power Well: RTC

| Bit | Description |
|-----|---------------------------------------------------------------------------------------------------------------------------------------------------------------------------------------------------------------------------------------------------------------------------------------------------------------------------------------------------------------------------------------------------------------------------------------------------------------------------------------------------------------------------------------------------------------|
| 7 | <p>Update Cycle Inhibit (SET) — R/W. Enables/Inhibits the update cycles. This bit is not affected by RSMRST# nor any other reset signal.</p> <p>0 = Update cycle occurs normally once each second. 1 = A current update cycle will abort and subsequent update cycles will not occur until SET is returned to 0. When set is one, the BIOS may initialize time and calendar bytes safely.</p> <p>NOTE: This bit should be set then cleared early in BIOS POST after each powerup directly after coin-cell battery insertion.</p> |
| 6 | <p>Periodic Interrupt Enable (PIE) — R/W. This bit is cleared by RSMRST#, but not on any other reset.</p> <p>0 = Disable. 1 = Enable. Allows an interrupt to occur with a time base set with the RS bits of register A.</p> |
| 5 | <p>Alarm Interrupt Enable (AIE) — R/W. This bit is cleared by RTCRST#, but not on any other reset.</p> <p>0 = Disable. 1 = Enable. Allows an interrupt to occur when the AF is set by an alarm match from the update cycle. An alarm can occur once a second, one an hour, once a day, or one a month.</p> |
| 4 | <p>Update-Ended Interrupt Enable (UIE) — R/W. This bit is cleared by RSMRST#, but not on any other reset.</p> <p>0 = Disable. 1 = Enable. Allows an interrupt to occur when the update cycle ends.</p> |
| 3 | <p>Square Wave Enable (SQWE) — R/W. This bit serves no function in the ICH10. It is left in this register bank to provide compatibility with the Motorola 146818B. The ICH10 has no SQW pin. This bit is cleared by RSMRST#, but not on any other reset.</p> |
| 2 | <p>Data Mode (DM) — R/W. This bit specifies either binary or BCD data representation. This bit is not affected by RSMRST# nor any other reset signal.</p> <p>0 = BCD 1 = Binary</p> |
| 1 | <p>Hour Format (HOURFORM) — R/W. This bit indicates the hour byte format. This bit is not affected by RSMRST# nor any other reset signal.</p> <p>0 = Twelve-hour mode. In twelve-hour mode, the seventh bit represents AM as 0 and PM as one. 1 = Twenty-four hour mode.</p> |
| 0 | <p>Daylight Savings Legacy Software Support (DLSWS) — R/W. Daylight savings functionality is no longer supported. This bit is used to maintain legacy software support and has no associated functionality. If BUC.DSO bit is set, the DLSWS bit continues to be R/W.</p> |



13.6.2.3 RTC_REGC—Register C (Flag Register)

| | | | |
|----------------|-------------------------|-------------|-------|
| RTC Index: | 0Ch | Attribute: | RO |
| Default Value: | 00U00000 (U: Undefined) | Size: | 8-bit |
| Lockable: | No | Power Well: | RTC |

Writes to Register C have no effect.

| Bit | Description |
|-----|--------------------------------------------------------------------------------------------------------------------------------------------------------------------------------------------------------------------------------------------------------------------------------------------------|
| 7 | Interrupt Request Flag (IRQF) — RO. $IRQF = (PF * PIE) + (AF * AIE) + (UF * UFE)$. This bit also causes the RTC Interrupt to be asserted. This bit is cleared upon RSMRST# or a read of Register C. |
| 6 | Periodic Interrupt Flag (PF) — RO. This bit is cleared upon RSMRST# or a read of Register C. 0 = If no taps are specified via the RS bits in Register A, this flag will not be set. 1 = Periodic interrupt Flag will be 1 when the tap specified by the RS bits of register A is 1. |
| 5 | Alarm Flag (AF) — RO. 0 = This bit is cleared upon RTCRST# or a read of Register C. 1 = Alarm Flag will be set after all Alarm values match the current time. |
| 4 | Update-Ended Flag (UF) — RO. 0 = The bit is cleared upon RSMRST# or a read of Register C. 1 = Set immediately following an update cycle for each second. |
| 3:0 | Reserved. Will always report 0. |

13.6.2.4 RTC_REGD—Register D (Flag Register)

| | | | |
|----------------|-------------------------|-------------|-------|
| RTC Index: | 0Dh | Attribute: | R/W |
| Default Value: | 10UUUUUU (U: Undefined) | Size: | 8-bit |
| Lockable: | No | Power Well: | RTC |

| Bit | Description |
|-----|----------------------------------------------------------------------------------------------------------------------------------------------------------------------------------------------------------------------------------------------------------------------------------------------------------------------------------------------------------------------------------------------------------------|
| 7 | Valid RAM and Time Bit (VRT) — R/W. 0 = This bit should always be written as a 0 for write cycle, however it will return a 1 for read cycles. 1 = This bit is hardwired to 1 in the RTC power well. |
| 6 | Reserved. This bit always returns a 0 and should be set to 0 for write cycles. |
| 5:0 | Date Alarm — R/W. These bits store the date of month alarm value. If set to 000000b, then a don't care state is assumed. The host must configure the date alarm for these bits to do anything, yet they can be written at any time. If the date alarm is not enabled, these bits will return 0s to mimic the functionality of the Motorola 146818B. These bits are not affected by any reset assertion. |



13.7 Processor Interface Registers (LPC I/F—D31:F0)

Table 13-8 is the register address map for the processor interface registers.

Table 13-8. Processor Interface PCI Register Address Map (LPC I/F—D31:F0)

| Offset | Mnemonic | Register Name | Default | Type |
|--------|------------|------------------------|---------|---------------|
| 61h | NMI_SC | NMI Status and Control | 00h | R/W, RO |
| 70h | NMI_EN | NMI Enable | 80h | R/W (special) |
| 92h | PORT92 | Fast A20 and Init | 00h | R/W |
| F0h | COPROC_ERR | Coprocessor Error | 00h | WO |
| CF9h | RST_CNT | Reset Control | 00h | R/W |

13.7.1 NMI_SC—NMI Status and Control Register (LPC I/F—D31:F0)

| | | | |
|----------------|-----|-------------|---------|
| I/O Address: | 61h | Attribute: | R/W, RO |
| Default Value: | 00h | Size: | 8-bit |
| Lockable: | No | Power Well: | Core |

| Bit | Description |
|-----|----------------------------------------------------------------------------------------------------------------------------------------------------------------------------------------------------------------------------------------------------------------------------------------------------------------------------------------------------------------------------------------------------------------------------------------------------------------------------------------------------------------------------------------------------------------------------------------------------------------|
| 7 | <p>SERR# NMI Source Status (SERR#_NMI_STS) — RO. 1 = Bit is set if a PCI agent detected a system error and pulses the PCI SERR# line and if bit 2 (PCI_SERR_EN) is cleared. This interrupt source is enabled by setting bit 2 to 0. To reset the interrupt, set bit 2 to 1 and then set it to 0. When writing to port 61h, this bit must be 0.</p> <p>NOTE: This bit is set by any of the ICH10 internal sources of SERR; this includes SERR assertions forwarded from the secondary PCI bus, errors on a PCI Express* port, or other internal functions that generate SERR#.</p> |
| 6 | <p>IOCHK# NMI Source Status (IOCHK#_NMI_STS) — RO. 1 = Bit is set if an LPC agent (via SERIRQ) asserted IOCHK# and if bit 3 (IOCHK#_NMI_EN) is cleared. This interrupt source is enabled by setting bit 3 to 0. To reset the interrupt, set bit 3 to 1 and then set it to 0. When writing to port 61h, this bit must be a 0.</p> |
| 5 | <p>Timer Counter 2 OUT Status (TMR2_OUT_STS) — RO. This bit reflects the current state of the 8254 counter 2 output. Counter 2 must be programmed following any PCI reset for this bit to have a determinate value. When writing to port 61h, this bit must be a 0.</p> |
| 4 | <p>Refresh Cycle Toggle (REF_TOGGLE) — RO. This signal toggles from either 0 to 1 or 1 to 0 at a rate that is equivalent to when refresh cycles would occur. When writing to port 61h, this bit must be a 0.</p> |
| 3 | <p>IOCHK# NMI Enable (IOCHK#_NMI_EN) — R/W. 0 = Enabled. 1 = Disabled and cleared.</p> |
| 2 | <p>PCI SERR# Enable (PCI_SERR_EN) — R/W. 0 = SERR# NMIs are enabled. 1 = SERR# NMIs are disabled and cleared.</p> |



| Bit | Description |
|-----|------------------------------------------------------------------------------------------------------------------------------------------------|
| 1 | Speaker Data Enable (SPKR_DAT_EN) — R/W. 0 = SPKR output is a 0. 1 = SPKR output is equivalent to the Counter 2 OUT signal value. |
| 0 | Timer Counter 2 Enable (TIM_CNT2_EN) — R/W. 0 = Disable 1 = Enable |

13.7.2 NMI_EN—NMI Enable (and Real Time Clock Index) Register (LPC I/F—D31:F0)

| | | | |
|----------------|-----|-------------|---------------|
| I/O Address: | 70h | Attribute: | R/W (special) |
| Default Value: | 80h | Size: | 8-bit |
| Lockable: | No | Power Well: | Core |

Note: The RTC Index field is write-only for normal operation. This field can only be read in Alt-Access Mode. Note, however, that this register is aliased to Port 74h (documented in), and all bits are readable at that address.

| Bits | Description |
|------|------------------------------------------------------------------------------------------------------------------------------------------------------------|
| 7 | NMI Enable (NMI_EN) — R/W (special). 0 = Enable NMI sources. 1 = Disable All NMI sources. |
| 6:0 | Real Time Clock Index Address (RTC_INDX) — R/W (special). This data goes to the RTC to select which register or CMOS RAM address is being accessed. |

13.7.3 PORT92—Fast A20 and Init Register (LPC I/F—D31:F0)

| | | | |
|----------------|-----|-------------|-------|
| I/O Address: | 92h | Attribute: | R/W |
| Default Value: | 00h | Size: | 8-bit |
| Lockable: | No | Power Well: | Core |

| Bit | Description |
|-----|----------------------------------------------------------------------------------------------------------------------------------------------------------------------------------------------------------------------------------|
| 7:2 | Reserved |
| 1 | Alternate A20 Gate (ALT_A20_GATE) — R/W. This bit is Or'd with the A20GATE input signal to generate A20M# to the processor. 0 = A20M# signal can potentially go active. 1 = This bit is set when INIT# goes active. |
| 0 | INIT_NOW — R/W. When this bit transitions from a 0 to a 1, the ICH10 will force INIT# active for 16 PCI clocks. |



13.7.4 COPROC_ERR—Coprocessor Error Register (LPC I/F—D31:F0)

| | | | |
|----------------|-----|-------------|--------|
| I/O Address: | F0h | Attribute: | WO |
| Default Value: | 00h | Size: | 8-bits |
| Lockable: | No | Power Well: | Core |

| Bits | Description |
|------|-----------------------------------------------------------------------------------------------------------------------------------------------------------------------------------------------------------------------------------------------------------------------------------------------------------------------------------------------------|
| 7:0 | Coprocessor Error (COPROC_ERR) — WO. Any value written to this register will cause IGNNE# to go active, if FERR# had generated an internal IRQ13. For FERR# to generate an internal IRQ13, the COPROC_ERR_EN bit (Chipset Config Registers: Offset 31FFh: bit 1 for Consumer Family and Offset 31FEh: bit 9 for Corporate family) must be 1. |

13.7.5 RST_CNT—Reset Control Register (LPC I/F—D31:F0)

| | | | |
|----------------|------|-------------|-------|
| I/O Address: | CF9h | Attribute: | R/W |
| Default Value: | 00h | Size: | 8-bit |
| Lockable: | No | Power Well: | Core |

| Bit | Description |
|-----|-----------------------------------------------------------------------------------------------------------------------------------------------------------------------------------------------------------------------------------------------------------------------------------------------------------------------------------------------------------------------------------------------------------------------------------------------------------------------------------------------------------------------------------------------------------------------------------------------------------------------------------|
| 7:4 | Reserved |
| 3 | Full Reset (FULL_RST) — R/W. This bit is used to determine the states of SLP_S3#, SLP_S4#, and SLP_S5# after a CF9 hard reset (SYS_RST = 1 and RST_CPU is set to 1), after PWROK going low (with RSMRST# high), or after two TCO timeouts. 0 = ICH10 will keep SLP_S3#, SLP_S4# and SLP_S5# high. 1 = ICH10 will drive SLP_S3#, SLP_S4# and SLP_S5# low for 3 – 5 seconds. NOTE: When this bit is set, it also causes the full power cycle (SLP_S3/4/5# assertion) in response to SYSRESET#, PWROK#, and Watchdog timer reset sources. |
| 2 | Reset CPU (RST_CPU) — R/W. When this bit transitions from a 0 to a 1, it initiates a hard or soft reset, as determined by the SYS_RST bit (bit 1 of this register). |
| 1 | System Reset (SYS_RST) — R/W. This bit is used to determine a hard or soft reset to the processor. 0 = When RST_CPU bit goes from 0 to 1, the ICH10 performs a soft reset by activating INIT# for 16 PCI clocks. 1 = When RST_CPU bit goes from 0 to 1, the ICH10 performs a hard reset by activating PLTRST# and SUS_STAT# active for about 5-6 milliseconds. In this case, SLP_S3#, SLP_S4# and SLP_S5# state (assertion or de-assertion) depends on FULL_RST bit setting. The ICH10 main power well is reset when this bit is 1. It also resets the resume well bits (except for those noted throughout the EDS). |
| 0 | Reserved |

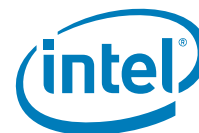

13.8 Power Management Registers (PM—D31:F0)

The power management registers are distributed within the PCI Device 31: Function 0 space, as well as a separate I/O range. Each register is described below. Unless otherwise indicate, bits are in the main (core) power well.

Bits not explicitly defined in each register are assumed to be reserved. When writing to a reserved bit, the value should always be 0. Software should not attempt to use the value read from a reserved bit, as it may not be consistently 1 or 0.

13.8.1 Power Management PCI Configuration Registers (PM—D31:F0)

Table 13-9 shows a small part of the configuration space for PCI Device 31: Function 0. It includes only those registers dedicated for power management. Some of the registers are only used for Legacy Power management schemes.

Table 13-9. Power Management PCI Register Address Map (PM—D31:F0)

| Offset | Mnemonic | Register Name | Default | Type |
|--------|----------------|---------------------------------------------|-----------|----------------|
| A0h | GEN_PMCON_1 | General Power Management Configuration 1 | 0000h | R/W,, R/WO, RO |
| A2h | GEN_PMCON_2 | General Power Management Configuration 2 | 00h | R/W, R/WC |
| A4h | GEN_PMCON_3 | General Power Management Configuration 3 | 00h | R/W, R/WC |
| A6h | GEN_PMCON_LOCK | General Power Management Configuration Lock | 00h | RO, R/WLO |
| A9h | Cx-STATE_CNF | Cx State Configuration | 00h | R/W |
| AAh | C4-TIMING_CNT | C4 Timing Control | 00h | R/W |
| ABh | BM_BREAK_EN | BM_BREAK_EN | 00h | R/W |
| ACh | PMIR | Power Management Initialization | 00000000h | R/W, R/WL |
| B8–BBh | GPI_ROUT | GPI Route Control | 00000000h | R/W |



13.8.1.1 GEN_PMCON_1—General PM Configuration 1 Register (PM—D31:F0)

| | | | |
|-----------------|-------|-------------|---------------|
| Offset Address: | A0h | Attribute: | R/W, RO, R/WO |
| Default Value: | 0000h | Size: | 16-bit |
| Lockable: | No | Usage: | ACPI, Legacy |
| | | Power Well: | Core |

| Bit | Description | | | | | | | | | | | | |
|-----------------------|-----------------------------------------------------------------------------------------------------------------------------------------------------------------------------------------------------------------------------------------------------------------------------------------------------------------------------------------------------------------------------------------------------------------------------------------------------------------------------------|-----------------|-------|--------------|---|---|-------|---|---|---------|---|---|----------|
| 15:13 | Reserved | | | | | | | | | | | | |
| 12 | <p>C4 Disable — R/W. This bit disables the C4 feature.</p> <p>0 = Enables C4 1 = Disables C4.</p> <p>When C4 Disable is 1:</p> <ul style="list-style-type: none"> I/O reads to the LVL4 register will be retried normally, but with no other action All C4 transition attempts are disabled, overriding C4onC3 and Pop-Down transition. | | | | | | | | | | | | |
| 11 | <p>BMBUSY# Select (BMSEL)— R/W. This bit along with GPIO_USE_SEL[0] bit enables selection of BM_BUSY#/GPIO0 function on ICH pin as shown below:</p> <table border="1" style="margin-left: 40px;"> <thead> <tr> <th>GPIO_USE_SEL[0]</th> <th>BMSEL</th> <th>Pin Function</th> </tr> </thead> <tbody> <tr> <td>1</td> <td>X</td> <td>GPIO0</td> </tr> <tr> <td>0</td> <td>0</td> <td>BMBUSY#</td> </tr> <tr> <td>0</td> <td>1</td> <td>Reserved</td> </tr> </tbody> </table> | GPIO_USE_SEL[0] | BMSEL | Pin Function | 1 | X | GPIO0 | 0 | 0 | BMBUSY# | 0 | 1 | Reserved |
| GPIO_USE_SEL[0] | BMSEL | Pin Function | | | | | | | | | | | |
| 1 | X | GPIO0 | | | | | | | | | | | |
| 0 | 0 | BMBUSY# | | | | | | | | | | | |
| 0 | 1 | Reserved | | | | | | | | | | | |
| 10 | <p>BIOS_PCI_EXP_EN — R/W. This bit acts as a global enable for the SCI associated with the PCI Express* ports.</p> <p>0 = The various PCI Express ports and (G)MCH cannot cause the PCI_EXP_STS bit to go active. 1 = The various PCI Express ports and (G)MCH can cause the PCI_EXP_STS bit to go active.</p> | | | | | | | | | | | | |
| 9 | <p>PWRBTN_LVL — RO. This bit indicates the current state of the PWRBTN# signal.</p> <p>0 = Low. 1 = High.</p> | | | | | | | | | | | | |
| 8 | Reserved | | | | | | | | | | | | |
| 7 | <p>Enter C4 When C3 Invoked (C4onC3_EN) — R/W. If this bit is set, then when software does a LVL3 read, the ICH10 transitions to the C4 state.</p> | | | | | | | | | | | | |
| 6 (Corporate Only) | <p>Ignore Stop-Grant - R/W. Software sets this bit to indicate that the ICH must not wait for the Stop Grant (aka REQ_C2) cycle. This bit must be set for iA64 processors and CSI processors.</p> | | | | | | | | | | | | |
| 6 (Consumer Only) | <p>i64_EN. Software sets this bit to indicate that the processor is an IA_64 processor, not an IA_32 processor. This may be used in various state machines where there are behavioral differences.</p> | | | | | | | | | | | | |
| 5 (Corporate Only) | Reserved | | | | | | | | | | | | |



| Bit | Description |
|----------------------|--------------------------------------------------------------------------------------------------------------------------------------------------------------------------------------------------------------------------------------------------------------------------------------------------------------------------------------------------------------------------------------------------------------------------------------------------------|
| 5 (Consumer Only) | <p>CPU SLP# Enable (CPUSLP_EN) — R/W.</p> <p>0 = Disable. 1 = Enables the CPUSLP# signal to go active in the S1 state. This reduces the processor power.</p> <p>NOTE: CPUSLP# will go active on entry to C3 and C4 states even if this bit is not set.</p> |
| 4 | <p>SMI_LOCK — R/WO. When this bit is set, writes to the GLB_SMI_EN bit (PMBASE + 30h, bit 0) will have no effect. Once the SMI_LOCK bit is set, writes of 0 to SMI_LOCK bit will have no effect (i.e., once set, this bit can only be cleared by PLTRST#).</p> |
| 3 | Reserved |
| 2 | <p>PCI CLKRUN# Enable (CLKRUN_EN) — R/W.</p> <p>0 = Disable. ICH10 drives the CLKRUN# signal low. 1 = Enable CLKRUN# logic to control the system PCI clock via the CLKRUN# and STP_PCI# signals.</p> <p>NOTE: When the SLP_EN# bit is set, the ICH10 drives the CLKRUN# signal low regardless of the state of the CLKRUN_EN bit. This ensures that the PCI and LPC clocks continue running during a transition to a sleep state.</p> |
| 1:0 | <p>Periodic SMI # Rate Select (PER_SMI_SEL) — R/W. Set by software to control the rate at which periodic SMI# is generated.</p> <p>00 = 64 seconds 01 = 32 seconds 10 = 16 seconds 11 = 8 seconds</p> |



13.8.1.2 GEN_PMCON_2—General PM Configuration 2 Register (PM—D31:F0)

| | | | |
|-----------------|-----|-------------|--------------|
| Offset Address: | A2h | Attribute: | R/W, R/WC |
| Default Value: | 00h | Size: | 8-bit |
| Lockable: | No | Usage: | ACPI, Legacy |
| | | Power Well: | Resume |

| Bit | Description |
|-----|-----------------------------------------------------------------------------------------------------------------------------------------------------------------------------------------------------------------------------------------------------------------------------------------------------------------------------------------------------------------------------------------------------------------------------------------------------------------------------------------------------------------------------------------------------------------------------------------------------------------------------------------------------------------------------------------------------------------------------------------------------------------------------------------------------------------------------|
| 7 | <p>DRAM Initialization Bit — R/W. This bit does not effect hardware functionality in any way. BIOS is expected to set this bit prior to starting the DRAM initialization sequence and to clear this bit after completing the DRAM initialization sequence. BIOS can detect that a DRAM initialization sequence was interrupted by a reset by reading this bit during the boot sequence.</p> <ul style="list-style-type: none"> If the bit is 1, then the DRAM initialization was interrupted. This bit is reset by the assertion of the RSMRST# pin. |
| 6:5 | <p>CPU PLL Lock Time (CPLT) — R/W. This field indicates the amount of time that the processor needs to lock its PLLs. This is used wherever timing t270 (Chapter 8) applies.</p> <p>00 = min 30.7 μs (Default) 01 = min 61.4 μs 10 = min 122.8 μs 11 = min 42 μs (min) to 48 μs (max)</p> <p>It is the responsibility of the BIOS to program the correct value in this field prior to the first transition to C3 or C4 states.</p> <p>NOTES:</p> <ol style="list-style-type: none"> The DPSLP-TO-(G)MCH Message bits (D31:F0:AAh, bits 1:0) act as an override to these bits. These bits are not cleared by any type of reset except RSMRST# or a CF9h write. |
| 4 | <p>System Reset Status (SRS) — R/WC. Software clears this bit by writing a 1 to it.</p> <p>0 = SYS_RESET# button Not pressed. 1 = ICH10 sets this bit when the SYS_RESET# button is pressed. BIOS is expected to read this bit and clear it, if it is set.</p> <p>NOTES:</p> <ol style="list-style-type: none"> This bit is also reset by RSMRST# and CF9h resets. The SYS_RESET# is implemented in the Main power well. This pin must be properly isolated and masked to prevent incorrectly setting this Suspend well status bit. |
| 3 | <p>CPU Thermal Trip Status (CTS) — R/WC.</p> <p>0 = Software clears this bit by writing a 1 to it. 1 = This bit is set when PLTRST# is inactive and THRMTRIP# goes active while the system is in an S0 or S1 state.</p> <p>NOTES:</p> <ol style="list-style-type: none"> This bit is also reset by RSMRST#, and CF9h resets. It is not reset by the shutdown and reboot associated with the CPUTHRMTRIP# event. The CF9h reset in the description refers to CF9h type core well reset which includes SYS_RST#, PWROK/VRMPWRGD low, SMBus hard reset, TCO Timeout. This type of reset will clear CTS bit. |



| Bit | Description |
|-----|-----------------------------------------------------------------------------------------------------------------------------------------------------------------------------------------------------------------------------------------------------------------------------------------------------------------------------------------------------------------------------------------------------------------------------------------------------------------------------------------------------------------------------------------------------------------------------------------------------------------------------------------------------------------------------------------------------------------------------------|
| 2 | <p>Minimum SLP_S4# Assertion Width Violation Status — R/WC.</p> <p>0 = Software clears this bit by writing a 1 to it. 1 = Hardware sets this bit when the SLP_S4# assertion width is less than the time programmed in the SLP_S4# Minimum Assertion Width field (D31:F0:Offset A4h:bits 5:4). The ICH10 begins the timer when SLP_S4# is asserted during S4/S5 entry, or when the RSMRST# input is deasserted during G3 exit. Note that this bit is functional regardless of the value in the SLP_S4# Assertion Stretch Enable (D31:F0:Offset A4h:bit 3).</p> <p>NOTE: This bit is reset by the assertion of the RSMRST# pin, but can be set in some cases before the default value is readable.</p> |
| 1 | <p>CPU Power Failure (CPUPWR_FLR) — R/W.</p> <p>0 = Software (typically BIOS) clears this bit by writing a 0 to it. 1 = Indicates that the VRMPWRGD signal from the processor's VRM went low while the system was in an S0 or S1 state.</p> <p>NOTE: VRMPWRGD is sampled using the RTC clock. Therefore, low times that are less than one RTC clock period may not be detected by the Intel ICH10.</p> |
| 0 | <p>PWROK Failure (PWROK_FLR) — R/WC.</p> <p>0 = Software clears this bit by writing a 1 to it, or when the system goes into a G3 state. 1 = This bit will be set any time PWROK goes low, when the system was in S0, or S1 state. The bit will be cleared only by software by writing a 1 to this bit or when the system goes to a G3 state.</p> <p>NOTE: See Chapter 5.13.6.3 for more details about the PWROK pin functionality. NOTE: In the case of true PWROK failure, PWROK will go low first before the VRMPWRGD.</p> |



13.8.1.3 GEN_PMCON_3—General PM Configuration 3 Register (PM—D31:F0)

| | | | |
|-----------------|---------------------------------------------|-------------|--------------|
| Offset Address: | A4h | Attribute: | R/W, R/WC |
| Default Value: | 0000h Consumer Only 0200h Corporate Only | Size: | 16-bit |
| Lockable: | No | Usage: | ACPI, Legacy |
| | | Power Well: | RTC, SUS |

| Bit | Description | | | | | | | | | | | | | | | |
|------------------------|----------------------------------------------------------------------------------------------------------------------------------------------------------------------------------------------------------------------------------------------------------------------------------------------------------------------------------------------------------------------------------------------------------------------------------------------------------------------------------------------------------------------------------------------------------------------------------------------------------------------------------------------------------------------------------------------------------------------------------------------------------------------------------------------------------------------------------------------------------------------------------------------------------------------------------------------------------------|--------------|----------|----|----|---|---|----|---|--------------|----|------------------------|--------------|----|------------------------|---|
| 15 (Corporate Only) | <p>PME B0 S5 Disable (PME_BO_S5_DIS)— R/W. When set to '1', this bit blocks wake events from PME_BO_STS in S5, regardless of the state of PME_BO_EN. When cleared (default), wake events from PME_BO_STS are allowed in S5 if PME_BO_EN = '1'.</p> <p>Wakes from power states other than S5 are not affected by this policy bit. The net effect of setting PME_BO_S5_DIS = '1' is described by the truth table below:</p> <p>Y = Wake; N = Don't wake; B0 = PME_BO_EN; OV = WOL Enable Override</p> <table border="1" style="margin-left: 20px;"> <thead> <tr> <th>B0/OV</th> <th>S1/S3/S4</th> <th>S5</th> </tr> </thead> <tbody> <tr> <td>00</td> <td>N</td> <td>N</td> </tr> <tr> <td>01</td> <td>N</td> <td>Y (LAN only)</td> </tr> <tr> <td>11</td> <td>Y (all PME B0 sources)</td> <td>Y (LAN only)</td> </tr> <tr> <td>01</td> <td>Y (all PME B0 sources)</td> <td>N</td> </tr> </tbody> </table> <p>This bit is cleared by the RTCRST# pin.</p> | B0/OV | S1/S3/S4 | S5 | 00 | N | N | 01 | N | Y (LAN only) | 11 | Y (all PME B0 sources) | Y (LAN only) | 01 | Y (all PME B0 sources) | N |
| B0/OV | S1/S3/S4 | S5 | | | | | | | | | | | | | | |
| 00 | N | N | | | | | | | | | | | | | | |
| 01 | N | Y (LAN only) | | | | | | | | | | | | | | |
| 11 | Y (all PME B0 sources) | Y (LAN only) | | | | | | | | | | | | | | |
| 01 | Y (all PME B0 sources) | N | | | | | | | | | | | | | | |
| 15 (Consumer Only) | Reserved | | | | | | | | | | | | | | | |
| 14 (Corporate Only) | <p>MAC Power Down During WOL Disable — R/W.</p> <p>0 = MAC power down WOL is enabled if the hardware and software requirements are met.</p> <p>1 = Integrated MAC remains powered whenever external suspend rails are powered.</p> | | | | | | | | | | | | | | | |
| 13 (Corporate Only) | <p>WOL Enable Override — R/W.</p> <p>0 = WOL policies are determined by PMEBO enable bit and appropriate LAN status bits</p> <p>1 = Enable integrated LAN to wake the system in S5 only regardless of the value in the PME_BO_EN bit in the GPE0_EN register.</p> <p>This bit is cleared by the RTCRST# pin.</p> | | | | | | | | | | | | | | | |
| 12 (Corporate Only) | <p>Disable SLP_S4# Stretching after G3:</p> <p>0 = Enables stretching on SLP_S4# in conjunction with SLP_S4# Assertion Stretch Enable (bit 3) and the Minimum Assertion Width (bits 5:4)</p> <p>1 = Disables stretching on SLP_S4# regardless of the state of the SLP_S4# Assertion Stretch Enable (bit 3).</p> <p>This bit is cleared by the RTCRST# pin.</p> <p>NOTE: This field is RO when the SLP_Sx# Stretching Policy Lock- Down bit is set.</p> | | | | | | | | | | | | | | | |



| Bit | Description |
|---------------------------|------------------------------------------------------------------------------------------------------------------------------------------------------------------------------------------------------------------------------------------------------------------------------------------------------------------------------------------------------------------------------------------------------------------------------------------------------------------------------------------------------------------------------------------------------------------------------------------------------------------------------------------------------------------------------------------------------------------------------------------------------------------------------------------------------------------------------------------------------------------------|
| 11:10 (Corporate Only) | <p>SLP_S3# Minimum Assertion Width: This 2-bit value indicates the minimum assertion width of the SLP_S3# signal to ensure that the Main power supplies have been fully power-cycled.</p> <p>Valid Settings are:</p> <p>00 = 60–100 us 01 = 1–1.2 ms 10 = 50–50.2 ms 11 = 2–2.0002 s</p> <p>This bit is cleared by the RSMRST# pin.</p> <p>NOTE: This field is RO when the SLP_Sx# Stretching Policy Lock-Down bit is set.</p> |
| 14:10 (Consumer Only) | Reserved |
| 9 | <p>General Reset Status (GEN_RST_STS) — R/WC. This bit is set by hardware whenever PLTRST# asserts for any reason other than going into a software-entered sleep state (via PM1CNT.SLP_EN write) or a suspend well power failure (RSMRST# pin assertion). BIOS is expected to consult and then write a '1' to clear this bit during the boot flow before determining what action to take based on PM1_STS.WAK_STS = 1. If GEN_RST_STS = '1', the cold reset boot path should be followed rather than the resume path, regardless of the setting of WAK_STS.</p> <p>This bit is cleared by the RSMRST# pin.</p> |
| 8 | <p>S4_STATE# Pin Disable — R/W.</p> <p>0 = The traditional SLP_S4# signal (without Intel Management Engine Overrides) is driven on the S4_STATE# Pin. GPIO26 defaults to its native functionality, S4_STATE#.</p> <p>1 = The S4_STATE# pin functionality is disabled. The pin is configured as GPIO26, default as an output.</p> <p>NOTE: This bit is cleared by RTCRST#. This bit acts as an override for GPIO_USE_SEL[26].</p> |
| 7:6 | <p>SWSMI_RATE_SEL — R/W. This field indicates when the SWSMI timer will time out.</p> <p>Valid values are:</p> <p>00 = 1.5 ms ± 0.6 ms 01 = 16 ms ± 4 ms 10 = 32 ms ± 4 ms 11 = 64 ms ± 4 ms</p> <p>These bits are not cleared by any type of reset except RTCRST#.</p> |
| 5:4 | <p>SLP_S4# Minimum Assertion Width — R/W. This field indicates the minimum assertion width of the SLP_S4# signal to ensure that the DRAMs have been safely power-cycled.</p> <p>Valid values are:</p> <p>11 = 1 to 2 seconds 10 = 2 to 3 seconds 01 = 3 to 4 seconds 00 = 4 to 5 seconds</p> <p>This value is used in two ways:</p> <ol style="list-style-type: none"> If the SLP_S4# assertion width is ever shorter than this time, a status bit is set for BIOS to read when S0 is entered. If enabled by bit 3 in this register, the hardware will prevent the SLP_S4# signal from deasserting within this minimum time period after asserting. <p>RTCRST# forces this field to the conservative default state (00b).</p> <p>NOTE: This field is RO when the SLP_S4# Stretching Policy Lock-Down bit is set.</p> |



| Bit | Description |
|-----------------------|-----------------------------------------------------------------------------------------------------------------------------------------------------------------------------------------------------------------------------------------------------------------------------------------------------------------------------------------------------------------------------------------------------------------------------------------------------------------------------------------------------------------------------------------------------------------------------------------------------------------------------------------------------------------------------------------------------------------------------------------------------------------------------------------------------------------------------------------------------------------------------------------------------------------------------------------------------------------------------------------------------------------|
| 3 | <p>SLP_S4# Assertion Stretch Enable — R/W.</p> <p>0 = The SLP_S4# minimum assertion time is 1 to 2 RTCCLK. 1 = The SLP_S4# signal minimally assert for the time specified in bits 5:4 of this register.</p> <p>This bit is cleared by RTCRST#.</p> <p>NOTE: This bit is RO when the SLP_S4# Stretching Policy Lock-Down bit is set.</p> |
| 2 | <p>RTC Power Status (RTC_PWR_STS) — R/W. This bit is set when RTCRST# indicates a weak or missing battery. The bit is not cleared by any type of reset. The bit will remain set until the software clears it by writing a 0 back to this bit position.</p> |
| 1 (Corporate Only) | <p>Power Failure (PWR_FLR) — R/W/C. This bit is in the SUS well, and defaults to a '1' based on RSMRST# assertion (not cleared by any type of reset).</p> <p>0 = Indicates that the trickle current has not failed since the last time the bit was cleared. Software clears this bit by writing a 1 to it. 1 = Indicates that the trickle current (from the main battery or trickle supply) was removed or failed.</p> |
| 1 (Consumer Only) | <p>Power Failure (PWR_FLR) — R/W/C. This bit is in the RTC well, and is not cleared by any type of reset except RTCRST#.</p> <p>0 = Indicates that the trickle current has not failed since the last time the bit was cleared. Software clears this bit by writing a 1 to it. 1 = Indicates that the trickle current (from the main battery or trickle supply) was removed or failed.</p> <p>NOTE: Clearing CMOS in an ICH-based platform can be done by using a jumper on RTCRST# or GPI, or using SAFEMODE strap. Implementations should not attempt to clear CMOS by using a jumper to pull VccRTC low.</p> |
| 0 (Corporate Only) | <p>AFTERG3_EN — R/W. This bit determines what state to go to when power is re-applied after a power failure (G3 state).</p> <p>0 = System will return to S0 state (boot) after power is re-applied. 1 = System will return to the S5 state (except if it was in S4, in which case it will return to S4).</p> <p>In the S5 state, the only enabled wake event is the Power Button or any enabled wake event that was preserved through the power failure.</p> <p>This bit is cleared by RTCRST#.</p> |
| 0 (Consumer Only) | <p>AFTERG3_EN — R/W. This bit determines what state to go to when power is re-applied after a power failure (G3 state). This bit is in the RTC well and is only cleared by writes of 06h or 0Eh to CF9h (when the CF9h global reset bit is clear), receiving hard reset command with or without power cycle from SMBus or RTCRST#.</p> <p>0 = System will return to S0 state (boot) after power is re-applied. 1 = System will return to the S5 state (except if it was in S4, in which case it will return to S4). In the S5 state, the only enabled wake event is the Power Button or any enabled wake event that was preserved through the power failure.</p> <p>NOTE: This bit is set any time a Power Button Override occurs (i.e., the power button is pressed for at least 4 consecutive seconds), due to the corresponding bit in the SMBus unconditional power down message, due to an internal thermal sensor catastrophic condition and the assertion of THRMTRIP#.</p> |

NOTE: RSMRST# is sampled using the RTC clock. Therefore, low times that are less than one RTC clock period may not be detected by the ICH10.



13.8.1.4 GEN_PMCON_LOCK- General Power Management Configuration Lock Register

| | | | |
|-----------------|------|------------|-----------|
| Offset Address: | A6h | Attribute: | RO, R/WLO |
| Default Value: | 00h | Size: | 8-bit |
| Lockable: | No | Usage: | ACPI |
| Power Well: | Core | | |

| Bit | Description |
|-----|-----------------------------------------------------------------------------------------------------------------------------------------------------------------------------------------------------------------------------------------------------------------------------------------------------------------------------------------------------------------------------------------------------------------------------------------------------------------------------------------------------------------------------------------------------------------------------------------------------------------------------------|
| 7 | Unlocked C-State Transition — RO. This bit is set by hardware when a processor power state (C-State) transition deeper than C2 occurs and the C-STATE_CONFIG_LOCK bit is not set. This bit is cleared by PLTRST# and is not writable by software. |
| 6:3 | Reserved |
| 2 | SLP_S4# Stretching Policy Lock-Down — R/WLO. When set to 1, this bit locks down the SLP_S4# Minimum Assertion Width, the SLP_S4# Assertion Stretch Enable (Corporate Only), the Disable SLP_S4# Stretching after G3 (Corporate Only) and SLP_S4# Assertion Stretch Enable (Consumer Only) bits in the GEN_PMCON_3 register, making them read-only. This bit becomes locked when a value of 1b is written to it. Writes of 0 to this bit are always ignored. This bit is cleared by platform reset. |
| 1 | ACPI_BASE_LOCK — R/WLO. When set to 1, this bit locks down the ACPI Base Address Register (ABASE) at offset 40h. The Base Address Field becomes read-only. This bit becomes locked when a value of 1b is written to it. Writes of 0 to this bit are always ignored. Once locked by writing 1, the only way to clear this bit is to perform a platform reset. |
| 0 | C-STATE_CONFIG_LOCK — R/WLO. When set to 1, this bit locks down the C-State configuration parameters. The following configuration bits become read-only when this bit is set: <ul style="list-style-type: none"> IA64_EN (GEN_PMCON_1, bit 6) C4_DISABLE (GEN_PMCON_1, bit 12) CPU_PLL_LOCK_TIME (GEN_PMCON_2, bits 6:5) The entire C4 Timing Control Register (C4_TIMING_CNT) This bit becomes locked when a value of 1b is written to it. Writes of 0 to this bit are always ignored. Once locked by writing 1, the only way to clear this bit is to perform a platform reset. |



13.8.1.5 Cx-STATE_CNF—Cx State Configuration Register (PM—D31:F0)

| | | | |
|-----------------|------|------------|--------------|
| Offset Address: | A9h | Attribute: | R/W |
| Default Value: | 00h | Size: | 8-bit |
| Lockable: | No | Usage: | ACPI, Legacy |
| Power Well: | Core | | |

This register is used to enable C-state related modes.

| Bit | Description |
|-----|--------------------------------------------------------------------------------------------------------------------------------------------------------------------------------------------------------------------------------------------------------------------------------------------------------------------------------------------------------------------------------------------------------------------------------------------------------------------------------------------------------------------------------------------------------------------------------------------------------------------------------------------------------------------------------------------------------------------------------------------------------------------------------------------------------|
| 7 | SCRATCHPAD (SP) — R/W. |
| 6:5 | Reserved |
| 4 | <p>Popdown Mode Enable (PDME) — R/W. This bit is used in conjunction with the PUME bit (D31:F0:A9h, bit 3). If PUME is 0, then this bit must also be 0.</p> <p>0 = The ICH10 will not attempt to automatically return to a previous C3 or C4 state. 1 = When this bit is a 1 and ICH10 observes that there are no bus master requests, it can return to a previous C3 or C4 state.</p> <p>NOTE: This bit is separate from the PUME bit to cover cases where latency issues permit POPUP but not POPDOWN.</p> |
| 3 | <p>Popup Mode Enable (PUME) — R/W. When this bit is a 0, the ICH10 behaves like ICH5, in that bus master traffic is a break event, and it will return from C3/C4 to C0 based on a break event. See Chapter 5.13.5 for additional details on this mode.</p> <p>0 = The ICH10 will treat Bus master traffic a break event, and will return from C3/C4 to C0 based on a break event. 1 = When this bit is a 1 and ICH10 observes a bus master request, it will take the system from a C3 or C4 state to a C2 state and auto enable bus masters. This will let snoops and memory access occur.</p> |
| 2 | <p>Report Zero for BM_STS (BM_STS_ZERO_EN) — R/W.</p> <p>0 = The ICH10 sets BM_STS (PMBASE + 00h, bit 4) if there is bus master activity from PCI, PCI Express* and internal bus masters. 1 = When this bit is a 1, ICH10 will not set the BM_STS if there is bus master activity from PCI, PCI Express and internal bus masters.</p> <p>NOTES:</p> <ol style="list-style-type: none"> If the BM_STS bit is already set when the BM_STS_ZERO_EN bit is set, the BM_STS bit will remain set. Software will still need to clear the BM_STS bit. It is expected that if the PUME bit (this register, bit 3) is set, the BM_STS_ZERO_EN bit should also be set. BM_STS will be set by LPC DMA or LPC masters, even if BM_STS_ZERO_EN is set. |
| 1:0 | Reserved |



13.8.1.6 C4-TIMING_CNT—C4 Timing Control Register (PM—D31:F0)

| | | | |
|-----------------|------|------------|--------------|
| Offset Address: | AAh | Attribute: | R/W |
| Default Value: | 00h | Size: | 8-bit |
| Lockable: | No | Usage: | ACPI, Legacy |
| Power Well: | Core | | |

This register is used to enable C-state related modes.

| Bit | Description | | | | | | | | | | | | | | | | | | | | |
|------|----------------------------------------------------------------------------------------------------------------------------------------------------------------------------------------------------------------------------------------------------------------------------------------------------------------------------------------------------------------------------------------------------------------------------------------------------------------------------------------------------------------------------------------------------------------------------------------------------------------------------------------------------------------------------------------------------------------------------------------------------------------------------------------------------------|----------------------|----------------------------|----------------------|---------------------------------------------------------|-----|-------|--------|---------|-----|-------|-------|----------------------------|-----|-------|-------|----------------------------|-----|--|--|----------|
| 7 | Reserved | | | | | | | | | | | | | | | | | | | | |
| 6 | Slow-C4 Exit Enable —When 1, this bit enables the Slow-C4 Exit functionality. | | | | | | | | | | | | | | | | | | | | |
| 5:4 | Reserved | | | | | | | | | | | | | | | | | | | | |
| 3:2 | <p>DPRSPLVR to STPCPU — R/W. This field selects the amount of time that the ICH10 waits for from the deassertion of DPRSLPVR to the deassertion of STP_CPU#. This provides a programmable time for the processor's voltage to stabilize when exiting from a C4 state. This thus changes the value for t266a.</p> <table> <thead> <tr> <th>Bits</th> <th>t266a_{min}</th> <th>t266a_{max}</th> <th>Comment</th> </tr> </thead> <tbody> <tr> <td>00b</td> <td>95 μs</td> <td>101 μs</td> <td>Default</td> </tr> <tr> <td>01b</td> <td>22 μs</td> <td>28 μs</td> <td>Value used for "Fast" VRMs</td> </tr> <tr> <td>10b</td> <td>34 μs</td> <td>40 μs</td> <td>Value used for "Fast" VRMs</td> </tr> <tr> <td>11b</td> <td></td> <td></td> <td>Reserved</td> </tr> </tbody> </table> | Bits | t266a _{min} | t266a _{max} | Comment | 00b | 95 μs | 101 μs | Default | 01b | 22 μs | 28 μs | Value used for "Fast" VRMs | 10b | 34 μs | 40 μs | Value used for "Fast" VRMs | 11b | | | Reserved |
| Bits | t266a _{min} | t266a _{max} | Comment | | | | | | | | | | | | | | | | | | |
| 00b | 95 μs | 101 μs | Default | | | | | | | | | | | | | | | | | | |
| 01b | 22 μs | 28 μs | Value used for "Fast" VRMs | | | | | | | | | | | | | | | | | | |
| 10b | 34 μs | 40 μs | Value used for "Fast" VRMs | | | | | | | | | | | | | | | | | | |
| 11b | | | Reserved | | | | | | | | | | | | | | | | | | |
| 1:0 | <p>DPSLP-TO-MCH Message— R/W. This field selects the DPSLP# deassertion to (G)MCH message time (t270). Normally this value is determined by the CPU_PLL_LOCK_TIME field in the GEN_PMCON_2 register. When this field is non-zero, then the values in this register have higher priority. It is software's responsibility to program these fields in a consistent manner.</p> <table> <thead> <tr> <th>Bits</th> <th>t270</th> </tr> </thead> <tbody> <tr> <td>00b</td> <td>Use value is CPU_PLL_LOCK_TIME field (default is 30 μs)</td> </tr> <tr> <td>01b</td> <td>20 μs</td> </tr> <tr> <td>10b</td> <td>15 μs</td> </tr> <tr> <td>11b</td> <td>10 μs</td> </tr> </tbody> </table> | Bits | t270 | 00b | Use value is CPU_PLL_LOCK_TIME field (default is 30 μs) | 01b | 20 μs | 10b | 15 μs | 11b | 10 μs | | | | | | | | | | |
| Bits | t270 | | | | | | | | | | | | | | | | | | | | |
| 00b | Use value is CPU_PLL_LOCK_TIME field (default is 30 μs) | | | | | | | | | | | | | | | | | | | | |
| 01b | 20 μs | | | | | | | | | | | | | | | | | | | | |
| 10b | 15 μs | | | | | | | | | | | | | | | | | | | | |
| 11b | 10 μs | | | | | | | | | | | | | | | | | | | | |



13.8.1.7 BM_BREAK_EN Register (PM—D31:F0)

| | | | |
|-----------------|------|------------|--------------|
| Offset Address: | ABh | Attribute: | R/W |
| Default Value: | 00h | Size: | 8-bit |
| Lockable: | No | Usage: | ACPI, Legacy |
| Power Well: | Core | | |

| Bit | Description |
|-----|------------------------------------------------------------------------------------------------------------------------------------------------------------------------------------------------------------------------------------------------------------------------------------------------------------------------------------------|
| 7 | STORAGE_BREAK_EN — R/W. 0 = Serial ATA traffic will not act as a break event. 1 = Serial ATA traffic acts as a break event, even if the BM_STS-ZERO_EN and POPUP_EN bits are set. Serial ATA master activity will cause BM_STS to be set and will cause a break from C3/C4. |
| 6 | PCIE_BREAK_EN — R/W. 0 = PCI Express* traffic will not act as a break event. 1 = PCI Express traffic acts as a break event, even if the BM_STS-ZERO_EN and POPUP_EN bits are set. PCI Express master activity will cause BM_STS to be set and will cause a break from C3/C4. |
| 5 | PCI_BREAK_EN — R/W. 0 = PCI traffic will not act as a break event. 1 = PCI traffic acts as a break event, even if the BM_STS-ZERO_EN and POPUP_EN bits are set. PCI master activity will cause BM_STS to be set and will cause a break from C3/C4. |
| 4:3 | Reserved |
| 2 | EHCI_BREAK_EN — R/W. 0 = EHCI traffic will not act as a break event. 1 = EHCI traffic acts as a break event, even if the BM_STS-ZERO_EN and POPUP_EN bits are set. EHCI master activity will cause BM_STS to be set and will cause a break from C3/C4. |
| 1 | UHCI_BREAK_EN — R/W. 0 = UHCI traffic will not act as a break event. 1 = USB traffic from any of the internal UHCIs acts as a break event, even if the BM_STS-ZERO_EN and POPUP_EN bits are set. UHCI master activity will cause BM_STS to be set and will cause a break from C3/C4. |
| 0 | HDA_BREAK_EN — R/W. 0 = Intel® High Definition Audio traffic will not act as a break event. 1 = Intel High Definition Audio traffic acts as a break event, even if the BM_STS-ZERO_EN and POPUP_EN bits are set. Intel High Definition Audio master activity will cause BM_STS to be set and will cause a break from C3/C4. |



13.8.1.8 PMIR—Power Management Initialization Register (PM—D31:F0)

Offset Address: ACh Attribute: R/W
 Default Value: 00000000h Size: 32-bit

| Bit | Description |
|-------|----------------------------------------------------------------------------------------------------------------------------------------------------------------------------------------------------------------------------------------------------------------------------------|
| 31 | CF9h Lockdown (CF9LOCK): When set, this bit locks the bits in this register into their current value. This register is reset by a CF9h reset. |
| 30 | PMIR Field 2 — R/W. BIOS must program this bit to 1b. |
| 29:21 | Reserved |
| 20 | CF9h Global Reset (CF9GR) — R/W. When set, a CF9h write of 6h or Eh will cause a Global reset of both the Host and Intel ME partitions. If this bit is cleared, a CF9h write of 6h or Eh will only reset the host partition. This bit field is not reset by a CF9h reset. |
| 19:15 | Reserved |
| 14 | Intel® AT Host Reset Trigger Enable - R/W. When set this bit enables bits [1:0] in the CIR11 register. |
| 13:10 | Reserved |
| 9:8 | PMIR Field 0 — R/W. BIOS must program these bits to 11b. |
| 7:0 | Reserved |

13.8.1.9 GPIO_ROUT—GPIO Routing Control Register (PM—D31:F0)

Offset Address: B8h – BBh Attribute: R/W
 Default Value: 00000000h Size: 32-bit
 Lockable: No Power Well: Resume

| Bit | Description |
|---------------------------------------|-------------------------------------------------------------------------------------------------------------------------------------------------------------------------------------------------------------------------------------------------------------------------------------------------------------------------------------------------------------------------------------------------------------------------------------------------------------------------------------------------------------|
| 31:30 | GPIO15 Route — R/W. See bits 1:0 for description. |
| Same pattern for GPIO14 through GPIO3 | |
| 5:4 | GPIO2 Route — R/W. See bits 1:0 for description. |
| 3:2 | GPIO1 Route — R/W. See bits 1:0 for description. |
| 1:0 | GPIO0 Route — R/W. GPIO[15:0] can be routed to cause an SMI or SCI when the GPIO[n]_STS bit is set. If the GPIO0 is not set to an input, this field has no effect. If the system is in an S1–S5 state and if the GPE0_EN bit is also set, then the GPIO can cause a Wake event, even if the GPIO is NOT routed to cause an SMI# or SCI. 00 = No effect. 01 = SMI# (if corresponding ALT_GPI_SMI_EN bit is also set) 10 = SCI (if corresponding GPE0_EN bit is also set) 11 = Reserved |

Note: GPIOs that are not implemented will not have the corresponding bits implemented in this register.



13.8.2 APM I/O Decode

Table 13-10 shows the I/O registers associated with APM support. This register space is enabled in the PCI Device 31: Function 0 space (APMDEC_EN), and cannot be moved (fixed I/O location).

Table 13-10. APM Register Map

| Address | Mnemonic | Register Name | Default | Type |
|---------|----------|----------------------------------------|---------|------|
| B2h | APM_CNT | Advanced Power Management Control Port | 00h | R/W |
| B3h | APM_STS | Advanced Power Management Status Port | 00h | R/W |

13.8.2.1 APM_CNT—Advanced Power Management Control Port Register

| | | | |
|----------------|------|------------|-------------|
| I/O Address: | B2h | Attribute: | R/W |
| Default Value: | 00h | Size: | 8-bit |
| Lockable: | No | Usage: | Legacy Only |
| Power Well: | Core | | |

| Bit | Description |
|-----|---------------------------------------------------------------------------------------------------------------------------------------------------------------------------------------|
| 7:0 | Used to pass an APM command between the OS and the SMI handler. Writes to this port not only store data in the APMC register, but also generates an SMI# when the APMC_EN bit is set. |

13.8.2.2 APM_STS—Advanced Power Management Status Port Register

| | | | |
|----------------|------|------------|-------------|
| I/O Address: | B3h | Attribute: | R/W |
| Default Value: | 00h | Size: | 8-bit |
| Lockable: | No | Usage: | Legacy Only |
| Power Well: | Core | | |

| Bit | Description |
|-----|--------------------------------------------------------------------------------------------------------------------------------------------------------------------------------|
| 7:0 | Used to pass data between the OS and the SMI handler. Basically, this is a scratchpad register and is not affected by any other register or function (other than a PCI reset). |



13.8.3 Power Management I/O Registers

Table 13-11 shows the registers associated with ACPI and Legacy power management support. These registers are enabled in the PCI Device 31: Function 0 space (PM_IO_EN), and can be moved to any I/O location (128-byte aligned). The registers are defined to support the ACPI 3.0a specification, and use the same bit names.

Note: All reserved bits and registers will always return 0 when read, and will have no effect when written.

Table 13-11. ACPI and Legacy I/O Register Map

| PMBASE + Offset | Mnemonic | Register Name | ACPI Pointer | Default | Type |
|-----------------|----------------|--------------------------------------|----------------|------------------------------------------------|----------------|
| 00h–01h | PM1_STS | PM1 Status | PM1a_EVT_BLK | 0000h | R/WC |
| 02h–03h | PM1_EN | PM1 Enable | PM1a_EVT_BLK+2 | 0000h | R/W |
| 04h–07h | PM1_CNT | PM1 Control | PM1a_CNT_BLK | 00000000h | R/W, WO |
| 08h–0Bh | PM1_TMR | PM1 Timer | PMTMR_BLK | xx000000h | RO |
| 0Ch–0Fh | — | Reserved | — | — | — |
| 10h–13h | PROC_CNT | Processor Control | P_BLK | 00000000h | R/W, RO, WO |
| 14h | LV2 | Level 2 | P_BLK+4 | 00h | RO |
| 15h | LV3 | Level 3 | P_BLK+5 | 00h | RO |
| 16h | LV4 | Level 4 | P_BLK+6 | 00h | RO |
| 17h–18h | — | Reserved | — | — | — |
| 19h–1Fh | — | Reserved | — | — | — |
| 20–27h | GPE0_STS | General Purpose Event 0 Status | GPE0_BLK | 00000000h | R/WC |
| 28–2Fh | GPE0_EN | General Purpose Event 0 Enables | GPE0_BLK+8 | 00000000h | R/W |
| 30h–33h | SMI_EN | SMI# Control and Enable | | 00000000h (Consumer); 00000020h (Corporate) | R/W, WO, R/WO |
| 34h–37h | SMI_STS | SMI Status | | 00000000h | R/WC, RO |
| 38h–39h | ALT_GP_SMI_EN | Alternate GPI SMI Enable | | 0000h | R/W |
| 3Ah–3Bh | ALT_GP_SMI_STS | Alternate GPI SMI Status | | 0000h | R/WC |
| 3Ch | UPRWC | USB Per-Port Registers Write Control | | 0000h | R/WC, RO, R/WO |
| 3Dh–41h | — | Reserved | — | — | — |
| 42h | GPE_CNTL | General Purpose Event Control | | 00h | RO, R/W |
| 43h | — | Reserved | — | — | — |
| 44h–45h | DEVACT_STS | Device Activity Status | | 0000h | R/WC |
| 46h–4Fh | — | Reserved | | | |
| 50h | PM2_CNT | PM2 Control | PM2a_CNT_BLK | 00h | R/W |
| 51h–53h | — | Reserved | | | |
| 54h–57h | C3_RES | C3-Residency Register | — | 00000000h | RO |
| 58h–5Bh | — | Reserved | | | |
| 5Ch–5Fh | — | Reserved | — | — | — |
| 60h–7Fh | — | Reserved for TCO | — | — | — |



13.8.3.1 PM1_STS—Power Management 1 Status Register

| | | | |
|----------------|---------------------------------------------------------------|------------|----------------|
| I/O Address: | PMBASE + 00h (ACPI PM1a_EVT_BLK) | Attribute: | R/WC |
| Default Value: | 0000h | Size: | 16-bit |
| Lockable: | No | Usage: | ACPI or Legacy |
| Power Well: | Bits 0–7: Core, Bits 8–15: Resume, except Bit 11 in RTC | | |

If bit 10 or 8 in this register is set, and the corresponding _EN bit is set in the PM1_EN register, then the ICH10 will generate a Wake Event. Once back in an S0 state (or if already in an S0 state when the event occurs), the ICH10 will also generate an SCI if the SCI_EN bit is set, or an SMI# if the SCI_EN bit is not set.

Note: Bit 5 does not cause an SMI# or a wake event. Bit 0 does not cause a wake event but can cause an SMI# or SCI.

| Bit | Description |
|-------|-------------------------------------------------------------------------------------------------------------------------------------------------------------------------------------------------------------------------------------------------------------------------------------------------------------------------------------------------------------------------------------------------------------------------------------------------------------------------------------------------------------------------------------------------------------------------------------------------------------------------------------------------------------------------------------------------------------------------------------------------------------------------------------------------------------------------------------------------------------------------------------------------------------------------------------------------------------------------------------------------------------------------------------------|
| 15 | <p>Wake Status (WAK_STS) — R/WC. This bit is not affected by hard resets caused by a CF9 write, but is reset by RSMRST#.</p> <p>0 = Software clears this bit by writing a 1 to it.</p> <p>1 = Set by hardware when the system is in one of the sleep states (via the SLP_EN bit) and an enabled wake event occurs. Upon setting this bit, the ICH10 will transition the system to the ON state.</p> <p>If the AFTERG3_EN bit is not set and a power failure occurs without the SLP_EN bit set, the system will return to an S0 state when power returns, and the WAK_STS bit will not be set.</p> <p>If the AFTERG3_EN bit is set and a power failure occurs without the SLP_EN bit having been set, the system will go into an S5 state when power returns, and a subsequent wake event will cause the WAK_STS bit to be set. Note that any subsequent wake event would have to be caused by either a Power Button press, or an enabled wake event that was preserved through the power failure (enable bit in the RTC well).</p> |
| 14 | <p>PCI Express Wake Status (PCIEXPWAK_STS) — R/WC.</p> <p>0 = Software clears this bit by writing a 1 to it. If the WAKE# pin is still active during the write or the PME message received indication has not been cleared in the root port, then the bit will remain active (i.e. all inputs to this bit are level-sensitive).</p> <p>1 = This bit is set by hardware to indicate that the system woke due to a PCI Express wakeup event. This wakeup event can be caused by the PCI Express WAKE# pin being active or receipt of a PCI Express PME message at a root port. This bit is set only when one of these events causes the system to transition from a non-S0 system power state to the S0 system power state. This bit is set independent of the state of the PCIEXP_WAKE_DIS bit.</p> <p>Note: This bit does not itself cause a wake event or prevent entry to a sleeping state. Thus if the bit is 1 and the system is put into a sleeping state, the system will not automatically wake.</p> |
| 13:12 | Reserved |

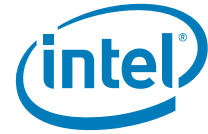

| Bit | Description |
|-----|---------------------------------------------------------------------------------------------------------------------------------------------------------------------------------------------------------------------------------------------------------------------------------------------------------------------------------------------------------------------------------------------------------------------------------------------------------------------------------------------------------------------------------------------------------------------------------------------------------------------------------------------------------------------------------------------------------------------------------------------------------------------------------------------------------------------------------------------------------------------------------------------------------------------------------------------------------------------------------------------------------------------------------------------------------------------------|
| 11 | <p>Power Button Override Status (PWRBTNOR_STS) — R/WC.</p> <p>0 = Software clears this bit by writing a 1 to it.</p> <p>1 = This bit is set any time a Power Button Override occurs (i.e., the power button is pressed for at least 4 consecutive seconds), due to the corresponding bit in the SMBus slave message, Intel ME Initiated Power Button Override, Intel ME Initiated Host Reset with Power down or due to an internal thermal sensor catastrophic condition. The power button override causes an unconditional transition to the S5 state, as well as sets the AFTERG3_EN bit. The BIOS or SCI handler clears this bit by writing a 1 to it. This bit is not affected by hard resets via CF9h writes, and is not reset by RSMRST#. Thus, this bit is preserved through power failures. Note that if this bit is still asserted when the global SCI_EN is set then an SCI will be generated.</p> |
| 10 | <p>RTC Status (RTC_STS) — R/WC. This bit is not affected by hard resets caused by a CF9 write, but is reset by RSMRST#.</p> <p>0 = Software clears this bit by writing a 1 to it.</p> <p>1 = Set by hardware when the RTC generates an alarm (assertion of the IRQ8# signal). Additionally if the RTC_EN bit (PMBASE + 02h, bit 10) is set, the setting of the RTC_STS bit will generate a wake event.</p> |
| 9 | <p>ME_STS — R/WC. This bit is set when the Intel Management Engine generates a Non-Maskable wake event, and is not affected by any other enable bit. When this bit is set, the Host Power Management logic wakes to S0.</p> <p>This bit is only set by hardware and can only be reset by writing a one to this bit position. This bit is not affected by hard resets caused by a CF9 write, but is reset by RSMRST#.</p> |
| 8 | <p>Power Button Status (PWRBTN_STS) — R/WC. This bit is not affected by hard resets caused by a CF9 write.</p> <p>0 = If the PWRBTN# signal is held low for more than 4 seconds, the hardware clears the PWRBTN_STS bit, sets the PWRBTNOR_STS bit, and the system transitions to the S5 state with only PWRBTN# enabled as a wake event.</p> <p>This bit can be cleared by software by writing a one to the bit position.</p> <p>1 = This bit is set by hardware when the PWRBTN# signal is asserted Low, independent of any other enable bit.</p> <p>In the S0 state, while PWRBTN_EN and PWRBTN_STS are both set, an SCI (or SMI# if SCI_EN is not set) will be generated.</p> <p>In any sleeping state S1–S5, while PWRBTN_EN (PMBASE + 02h, bit 8) and PWRBTN_STS are both set, a wake event is generated.</p> <p>NOTE: If the PWRBTN_STS bit is cleared by software while the PWRBTN# signal is still asserted, this will not cause the PWRBTN_STS bit to be set. The PWRBTN# signal must go inactive and active again to set the PWRBTN_STS bit.</p> |
| 7:6 | Reserved |
| 5 | <p>Global Status (GBL_STS) — R/WC.</p> <p>0 = The SCI handler should then clear this bit by writing a 1 to the bit location.</p> <p>1 = Set when an SCI is generated due to BIOS wanting the attention of the SCI handler. BIOS has a corresponding bit, BIOS_RLS, which will cause an SCI and set this bit.</p> |



| Bit | Description |
|-----|--------------------------------------------------------------------------------------------------------------------------------------------------------------------------------------------------------------------------------------------------------------------------------------------------------------------------------------------------------------------------------------------------------------------------------------------------------------------------------------------------------------------------------------------------------------------------------------------------------------------|
| 4 | Bus Master Status (BM_STS) — R/WC. This bit will not cause a wake event, SCI or SMI#. 0 = Software clears this bit by writing a 1 to it. 1 = Set by the ICH10 when a bus master requests access to main memory. Bus master activity is detected by any of the PCI Requests being active, any internal bus master request being active, or REQ-C2 message received while in C3 or C4 state. NOTE: 1. If the BM_STS_ZERO_EN bit is set, then this bit will generally report as a 0. LPC DMA and bus master activity will always set the BM_STS bit, even if the BM_STS_ZERO_EN bit is set. |
| 3:1 | Reserved |
| 0 | Timer Overflow Status (TMROF_STS) — R/WC. 0 = The SCI or SMI# handler clears this bit by writing a 1 to the bit location. 1 = This bit gets set any time bit 22 of the 24-bit timer goes high (bits are numbered from 0 to 23). This will occur every 2.3435 seconds. When the TMROF_EN bit (PMBASE + 02h, bit 0) is set, then the setting of the TMROF_STS bit will additionally generate an SCI or SMI# (depending on the SCI_EN). |



13.8.3.2 PM1_EN—Power Management 1 Enable Register

I/O Address: PMBASE + 02h
 (ACPI PM1a_EVT_BLK + 2) Attribute: R/W
 Default Value: 0000h Size: 16-bit
 Lockable: No Usage: ACPI or Legacy
 Power Well: Bits 0–7: Core,
 Bits 8–9, 11–15: Resume,
 Bit 10: RTC

| Bit | Description | | | | | | | | | | | | |
|----------|-----------------------------------------------------------------------------------------------------------------------------------------------------------------------------------------------------------------------------------------------------------------------------------------------------------------------------------------------------------------------------------------------------------------------------------------------------------|------------------------------|--------|------------------------------|---|---|----------------|---|---|------|---|---|-----|
| 15 | Reserved | | | | | | | | | | | | |
| 14 | <p>PCI Express* Wake Disable (PCIEXPWAK_DIS) — R/W. Modification of this bit has no impact on the value of the PCIEXP_WAKE_STS bit.</p> <p>0 = Inputs to the PCIEXP_WAKE_STS bit in the PM1 Status register enabled to wake the system. 1 = Inputs to the PCIEXP_WAKE_STS bit in the PM1 Status register disabled from waking the system.</p> | | | | | | | | | | | | |
| 13:11 | Reserved | | | | | | | | | | | | |
| 10 | <p>RTC Event Enable (RTC_EN) — R/W. This bit is in the RTC well to allow an RTC event to wake after a power failure. This bit is not cleared by any reset other than RTCRST# or a Power Button Override event.</p> <p>0 = No SCI (or SMI#) or wake event is generated then RTC_STS (PMBASE + 00h, bit 10) goes active. 1 = An SCI (or SMI#) or wake event will occur when this bit is set and the RTC_STS bit goes active.</p> | | | | | | | | | | | | |
| 9 | Reserved. | | | | | | | | | | | | |
| 8 | <p>Power Button Enable (PWRBTN_EN) — R/W. This bit is used to enable the setting of the PWRBTN_STS bit to generate a power management event (SMI#, SCI). PWRBTN_EN has no effect on the PWRBTN_STS bit (PMBASE + 00h, bit 8) being set by the assertion of the power button. The Power Button is always enabled as a Wake event.</p> <p>0 = Disable. 1 = Enable.</p> | | | | | | | | | | | | |
| 7:6 | Reserved. | | | | | | | | | | | | |
| 5 | <p>Global Enable (GBL_EN) — R/W. When both the GBL_EN and the GBL_STS bit (PMBASE + 00h, bit 5) are set, an SCI is raised.</p> <p>0 = Disable. 1 = Enable SCI on GBL_STS going active.</p> | | | | | | | | | | | | |
| 4:1 | Reserved. | | | | | | | | | | | | |
| 0 | <p>Timer Overflow Interrupt Enable (TMROF_EN) — R/W. Works in conjunction with the SCI_EN bit (PMBASE + 04h, bit 0) as described below:</p> <table border="1"> <thead> <tr> <th>TMROF_EN</th> <th>SCI_EN</th> <th>Effect when TMROF_STS is set</th> </tr> </thead> <tbody> <tr> <td>0</td> <td>X</td> <td>No SMI# or SCI</td> </tr> <tr> <td>1</td> <td>0</td> <td>SMI#</td> </tr> <tr> <td>1</td> <td>1</td> <td>SCI</td> </tr> </tbody> </table> | TMROF_EN | SCI_EN | Effect when TMROF_STS is set | 0 | X | No SMI# or SCI | 1 | 0 | SMI# | 1 | 1 | SCI |
| TMROF_EN | SCI_EN | Effect when TMROF_STS is set | | | | | | | | | | | |
| 0 | X | No SMI# or SCI | | | | | | | | | | | |
| 1 | 0 | SMI# | | | | | | | | | | | |
| 1 | 1 | SCI | | | | | | | | | | | |



13.8.3.3 PM1_CNT—Power Management 1 Control

I/O Address: PMBASE + 04h
 (ACPI PM1a_CNT_BLK) Attribute: R/W, WO
 Default Value: 00000000h Size: 32-bit
 Lockable: No Usage: ACPI or Legacy
 Power Well: Bits 0–7: Core,
 Bits 8–12: RTC,
 Bits 13–15: Resume

| Bit | Description | | | | | | | | | | | | | | | | | | |
|-------|----------------------------------------------------------------------------------------------------------------------------------------------------------------------------------------------------------------------------------------------------------------------------------------------------------------------------------------------------------------------------------------------------------------------------------------------------------------------------------------------------------------------------------------------------------------------------------------------------------------------------------------------------------------------------------------------------------------------------------------------------------------------------------------------------------------------------------------------------------------------------------------------------------------------------------------------------------------------------------------------------------------|------|------------------|------|---------------------------------|------|----------------------------------------------------------------------------------------------------------------------------------------------|------|----------|------|----------|------|----------|------|-------------------------------------------------------------|------|---------------------------------------------------------------------------|------|-----------------------------------------------------------------------------|
| 31:14 | Reserved. | | | | | | | | | | | | | | | | | | |
| 13 | Sleep Enable (SLP_EN) — WO. Setting this bit causes the system to sequence into the Sleep state defined by the SLP_TYP field. | | | | | | | | | | | | | | | | | | |
| 12:10 | <p>Sleep Type (SLP_TYP) — R/W. This 3-bit field defines the type of Sleep the system should enter when the SLP_EN bit is set to 1. These bits are only reset by RTCRST#.</p> <table border="0"> <thead> <tr> <th>Code</th> <th>Master Interrupt</th> </tr> </thead> <tbody> <tr> <td>000b</td> <td>ON: Typically maps to S0 state.</td> </tr> <tr> <td>001b</td> <td>Asserts STPCLK#. Puts processor in Stop-Grant state. Optional to assert CPUSLP# to put processor in sleep state: Typically maps to S1 state.</td> </tr> <tr> <td>010b</td> <td>Reserved</td> </tr> <tr> <td>011b</td> <td>Reserved</td> </tr> <tr> <td>100b</td> <td>Reserved</td> </tr> <tr> <td>101b</td> <td>Suspend-To-RAM. Assert SLP_S3#: Typically maps to S3 state.</td> </tr> <tr> <td>110b</td> <td>Suspend-To-Disk. Assert SLP_S3#, and SLP_S4#: Typically maps to S4 state.</td> </tr> <tr> <td>111b</td> <td>Soft Off. Assert SLP_S3#, SLP_S4#, and SLP_S5#: Typically maps to S5 state.</td> </tr> </tbody> </table> | Code | Master Interrupt | 000b | ON: Typically maps to S0 state. | 001b | Asserts STPCLK#. Puts processor in Stop-Grant state. Optional to assert CPUSLP# to put processor in sleep state: Typically maps to S1 state. | 010b | Reserved | 011b | Reserved | 100b | Reserved | 101b | Suspend-To-RAM. Assert SLP_S3#: Typically maps to S3 state. | 110b | Suspend-To-Disk. Assert SLP_S3#, and SLP_S4#: Typically maps to S4 state. | 111b | Soft Off. Assert SLP_S3#, SLP_S4#, and SLP_S5#: Typically maps to S5 state. |
| Code | Master Interrupt | | | | | | | | | | | | | | | | | | |
| 000b | ON: Typically maps to S0 state. | | | | | | | | | | | | | | | | | | |
| 001b | Asserts STPCLK#. Puts processor in Stop-Grant state. Optional to assert CPUSLP# to put processor in sleep state: Typically maps to S1 state. | | | | | | | | | | | | | | | | | | |
| 010b | Reserved | | | | | | | | | | | | | | | | | | |
| 011b | Reserved | | | | | | | | | | | | | | | | | | |
| 100b | Reserved | | | | | | | | | | | | | | | | | | |
| 101b | Suspend-To-RAM. Assert SLP_S3#: Typically maps to S3 state. | | | | | | | | | | | | | | | | | | |
| 110b | Suspend-To-Disk. Assert SLP_S3#, and SLP_S4#: Typically maps to S4 state. | | | | | | | | | | | | | | | | | | |
| 111b | Soft Off. Assert SLP_S3#, SLP_S4#, and SLP_S5#: Typically maps to S5 state. | | | | | | | | | | | | | | | | | | |
| 9:3 | Reserved. | | | | | | | | | | | | | | | | | | |
| 2 | <p>Global Release (GBL_RLS) — WO.</p> <p>0 = This bit always reads as 0. 1 = ACPI software writes a 1 to this bit to raise an event to the BIOS. BIOS software has a corresponding enable and status bits to control its ability to receive ACPI events.</p> | | | | | | | | | | | | | | | | | | |
| 1 | <p>Bus Master Reload (BM_RLD) — R/W. This bit is treated as a scratchpad bit. This bit is reset to 0 by PLTRST#</p> <p>0 = Bus master requests will not cause a break from the C3 state. 1 = Enables Bus Master requests (internal or external) to cause a break from the C3 state.</p> <p>If software fails to set this bit before going to C3 state, ICH10 will still return to a snoopable state from C3 or C4 states due to bus master activity.</p> | | | | | | | | | | | | | | | | | | |
| 0 | <p>SCI Enable (SCI_EN) — R/W. Selects the SCI interrupt or the SMI# interrupt for various events including the bits in the PM1_STS register (bit 10, 8, 0), and bits in GPE0_STS.</p> <p>0 = These events will generate an SMI#. 1 = These events will generate an SCI.</p> | | | | | | | | | | | | | | | | | | |



13.8.3.4 PM1_TMR—Power Management 1 Timer Register

| | | | |
|----------------|----------------------------------|------------|--------|
| I/O Address: | PMBASE + 08h (ACPI PMTMR_BLK) | Attribute: | RO |
| Default Value: | xx000000h | Size: | 32-bit |
| Lockable: | No | Usage: | ACPI |
| Power Well: | Core | | |

| Bit | Description |
|-------|-----------------------------------------------------------------------------------------------------------------------------------------------------------------------------------------------------------------------------------------------------------------------------------------------------------------------------------------------------------------------------------------------------------------------------------------------------------------------------------------------------------------------------------------------------------------------------------------------------------------------------------------------------------------------------|
| 31:24 | Reserved |
| 23:0 | <p>Timer Value (TMR_VAL) — RO. Returns the running count of the PM timer. This counter runs off a 3.579545 MHz clock (14.31818 MHz divided by 4). It is reset to 0 during a PCI reset, and then continues counting as long as the system is in the S0 state. After an S1 state, the counter will not be reset (it will continue counting from the last value in S0 state).</p> <p>Anytime bit 22 of the timer goes HIGH to LOW (bits referenced from 0 to 23), the TMROF_STS bit (PMBASE + 00h, bit 0) is set. The High-to-Low transition will occur every 2.3435 seconds. If the TMROF_EN bit (PMBASE + 02h, bit 0) is set, an SCI interrupt is also generated.</p> |

13.8.3.5 PROC_CNT—Processor Control Register

| | | | |
|----------------|------------------------------|------------|----------------|
| I/O Address: | PMBASE + 10h (ACPI P_BLK) | Attribute: | R/W, RO, WO |
| Default Value: | 00000000h | Size: | 32-bit |
| Lockable: | No (bits 7:5 are write once) | Usage: | ACPI or Legacy |
| Power Well: | Core | | |

| Bit | Description |
|-------|------------------------------------------------------------------------------------------------------------------------------------------------------------------------------------------------------------------------------------------------------------------------------------------|
| 31:18 | Reserved |
| 17 | <p>Throttle Status (THTL_STS) — RO.</p> <p>0 = No clock throttling is occurring (maximum processor performance). 1 = Indicates that the clock state machine is throttling the processor performance. This could be due to the THT_EN bit or the FORCE_THTL bit being set.</p> |
| 16:9 | Reserved |
| 8 | <p>Force Thermal Throttling (FORCE_THTL) — R/W. Software can set this bit to force the thermal throttling function.</p> <p>0 = No forced throttling. 1 = Throttling at the duty cycle specified in THRM_DTY starts immediately, and no SMI# is generated.</p> |



| Bit | Description | | | | | | | | | | | | | | | | | | | | | | | | | | | |
|----------|----------------------------------------------------------------------------------------------------------------------------------------------------------------------------------------------------------------------------------------------------------------------------------------------------------------------------------------------------------------------------------------------------------------------------------------------------------------------------------------------------------------------------------------------------------------------------------------------------------------------------------------------------------------------------------------------------------------------------------------------------------------------------------------------------------------------------------------------------------------------------------------------------------------------------------------------------------------------------------------------------------------------------------------------------------------------------------------------------------------------------------|------------|---------------|------------|------|---------------|-----|------|-------|-----|------|-------|-----|------|-------|-----|------|-----|-----|------|-------|-----|------|-----|-----|------|-------|-----|
| 7:5 | <p>THRM_DTY — WO. This write-once field determines the duty cycle of the throttling when the FORCE_THTL bit is set. The duty cycle indicates the approximate percentage of time the STPCLK# signal is asserted while in the throttle mode. The STPCLK# throttle period is 1024 PCICLKs. Note that the throttling only occurs if the system is in the C0 state. If in the C2, C3, or C4 state, no throttling occurs.</p> <p>Once the THRM_DTY field is written, any subsequent writes will have no effect until PLTRST# goes active.</p> <table border="1"> <thead> <tr> <th>THRM_DTY</th> <th>Throttle Mode</th> <th>PCI Clocks</th> </tr> </thead> <tbody> <tr> <td>000b</td> <td>50% (Default)</td> <td>512</td> </tr> <tr> <td>001b</td> <td>87.5%</td> <td>896</td> </tr> <tr> <td>010b</td> <td>75.0%</td> <td>768</td> </tr> <tr> <td>011b</td> <td>62.5%</td> <td>640</td> </tr> <tr> <td>100b</td> <td>50%</td> <td>512</td> </tr> <tr> <td>101b</td> <td>37.5%</td> <td>384</td> </tr> <tr> <td>110b</td> <td>25%</td> <td>256</td> </tr> <tr> <td>111b</td> <td>12.5%</td> <td>128</td> </tr> </tbody> </table> | THRM_DTY | Throttle Mode | PCI Clocks | 000b | 50% (Default) | 512 | 001b | 87.5% | 896 | 010b | 75.0% | 768 | 011b | 62.5% | 640 | 100b | 50% | 512 | 101b | 37.5% | 384 | 110b | 25% | 256 | 111b | 12.5% | 128 |
| THRM_DTY | Throttle Mode | PCI Clocks | | | | | | | | | | | | | | | | | | | | | | | | | | |
| 000b | 50% (Default) | 512 | | | | | | | | | | | | | | | | | | | | | | | | | | |
| 001b | 87.5% | 896 | | | | | | | | | | | | | | | | | | | | | | | | | | |
| 010b | 75.0% | 768 | | | | | | | | | | | | | | | | | | | | | | | | | | |
| 011b | 62.5% | 640 | | | | | | | | | | | | | | | | | | | | | | | | | | |
| 100b | 50% | 512 | | | | | | | | | | | | | | | | | | | | | | | | | | |
| 101b | 37.5% | 384 | | | | | | | | | | | | | | | | | | | | | | | | | | |
| 110b | 25% | 256 | | | | | | | | | | | | | | | | | | | | | | | | | | |
| 111b | 12.5% | 128 | | | | | | | | | | | | | | | | | | | | | | | | | | |
| 4 | <p>THTL_EN — R/W. When set and the system is in a C0 state, it enables a processor-controlled STPCLK# throttling. The duty cycle is selected in the THTL_DTY field.</p> <p>0 = Disable 1 = Enable</p> | | | | | | | | | | | | | | | | | | | | | | | | | | | |
| 3:1 | <p>THTL_DTY — R/W. This field determines the duty cycle of the throttling when the THTL_EN bit is set. The duty cycle indicates the approximate percentage of time the STPCLK# signal is asserted (low) while in the throttle mode. The STPCLK# throttle period is 1024 PCICLKs.</p> <table border="1"> <thead> <tr> <th>THTL_DTY</th> <th>Throttle Mode</th> <th>PCI Clocks</th> </tr> </thead> <tbody> <tr> <td>000b</td> <td>50% (Default)</td> <td>512</td> </tr> <tr> <td>001b</td> <td>87.5%</td> <td>896</td> </tr> <tr> <td>010b</td> <td>75.0%</td> <td>768</td> </tr> <tr> <td>011b</td> <td>62.5%</td> <td>640</td> </tr> <tr> <td>100b</td> <td>50%</td> <td>512</td> </tr> <tr> <td>101b</td> <td>37.5%</td> <td>384</td> </tr> <tr> <td>110b</td> <td>25%</td> <td>256</td> </tr> <tr> <td>111b</td> <td>12.5%</td> <td>128</td> </tr> </tbody> </table> | THTL_DTY | Throttle Mode | PCI Clocks | 000b | 50% (Default) | 512 | 001b | 87.5% | 896 | 010b | 75.0% | 768 | 011b | 62.5% | 640 | 100b | 50% | 512 | 101b | 37.5% | 384 | 110b | 25% | 256 | 111b | 12.5% | 128 |
| THTL_DTY | Throttle Mode | PCI Clocks | | | | | | | | | | | | | | | | | | | | | | | | | | |
| 000b | 50% (Default) | 512 | | | | | | | | | | | | | | | | | | | | | | | | | | |
| 001b | 87.5% | 896 | | | | | | | | | | | | | | | | | | | | | | | | | | |
| 010b | 75.0% | 768 | | | | | | | | | | | | | | | | | | | | | | | | | | |
| 011b | 62.5% | 640 | | | | | | | | | | | | | | | | | | | | | | | | | | |
| 100b | 50% | 512 | | | | | | | | | | | | | | | | | | | | | | | | | | |
| 101b | 37.5% | 384 | | | | | | | | | | | | | | | | | | | | | | | | | | |
| 110b | 25% | 256 | | | | | | | | | | | | | | | | | | | | | | | | | | |
| 111b | 12.5% | 128 | | | | | | | | | | | | | | | | | | | | | | | | | | |
| 0 | Reserved | | | | | | | | | | | | | | | | | | | | | | | | | | | |



13.8.3.6 LV2 — Level 2 Register

I/O Address: PMBASE + 14h (ACPI P_BLK + 4) Attribute: RO
 Default Value: 00h Size: 8-bit
 Lockable: No Usage: ACPI or Legacy
 Power Well: Core

| Bit | Description |
|-----|-----------------------------------------------------------------------------------------------------------------------------------------------------------------------------------------------------------------------------------------------------------------------------------------------------------------------------------------------|
| 7:0 | Reads to this register return all 0s, writes to this register have no effect. Reads to this register generate a “enter a level 2 power state” (C2) to the clock control logic. This will cause the STPCLK# signal to go active, and stay active until a break event occurs. Throttling (due either to THTL_EN or FORCE_THTL) will be ignored. |

NOTE: This register should not be used by IA-64 processors or systems with more than 1 logical processor, unless appropriate semaphoring software has been put in place to ensure that all threads/processors are ready for the C2 state when the read to this register occurs

13.8.3.7 LV3—Level 3 Register

I/O Address: PMBASE + 15h (ACPI P_BLK + 5) Attribute: RO
 Default Value: 00h Size: 8-bit
 Lockable: No Usage: ACPI or Legacy
 Power Well: Core

| Bit | Description |
|-----|------------------------------------------------------------------------------------------------------------------------------------------------------------------------------------------------------------------------|
| 7:0 | Reads to this register return all 0s, writes to this register have no effect. Reads to this register generate a “enter a C3 power state” to the clock control logic. The C3 state persists until a break event occurs. |

NOTE: If the C4onC3_EN bit is set, reads this register will initiate a LVL4 transition rather than a LVL3 transition. In the event that software attempts to simultaneously read the LVL2 and LVL3 registers (which is invalid), the ICH10 will ignore the LVL3 read, and only perform a C2 transition.

NOTE: This register should not be used by IA-64 processors or systems with more than 1 logical processor, unless appropriate semaphoring software has been put in place to ensure that all threads/processors are ready for the C3 state when the read to this register occurs.

13.8.3.8 LV4—Level 4 Register

I/O Address: PMBASE + 16h (ACPI P_BLK + 6) Attribute: RO
 Default Value: 00h Size: 8-bit
 Lockable: No Usage: ACPI or Legacy
 Power Well: Core

| Bit | Description |
|-----|------------------------------------------------------------------------------------------------------------------------------------------------------------------------------------------------------------------------|
| 7:0 | Reads to this register return all 0s, writes to this register have no effect. Reads to this register generate a “enter a C4 power state” to the clock control logic. The C4 state persists until a break event occurs. |

NOTE: This register should not be used by IA-64 processors or systems with more than 1 logical processor, unless appropriate semaphoring software has been put in place to ensure that all threads/processors are ready for the C4 state when the read to this register occurs.



13.8.3.9 GPE0_STS—General Purpose Event 0 Status Register

| | | | |
|----------------|---------------------------------|------------|---------------------------------|
| I/O Address: | PMBASE + 20h (ACPI GPE0_BLK) | Attribute: | Bits 0:32 R/WC Bits 33:63 RO |
| Default Value: | 0000000000000000h | Size: | 64-bit |
| Lockable: | No | Usage: | ACPI |
| Power Well: | Resume | | |

This register is symmetrical to the General Purpose Event 0 Enable Register. Unless indicated otherwise below, if the corresponding `_EN` bit is set, then when the `_STS` bit get set, the ICH10 will generate a Wake Event. Once back in an S0 state (or if already in an S0 state when the event occurs), the ICH10 will also generate an SCI if the `SCI_EN` bit is set, or an SMI# if the `SCI_EN` bit (PMBASE + 04h, bit 0) is not set. Bits 31:16 are reset by a CF9h write; bits 63:32 and 15:0 are not. All are reset by RSMRST#.

| Bit | Description |
|-------|-----------------------------------------------------------------------------------------------------------------------------------------------------------------------------------------------------------------------------------------------------------------------------------------------------------------------------------------------------------------------------------------------------------------------------------------------------------------------------------------------------------------------------------------------------------------------------------------------------------------------------------------------------------------------------------------------------------------------------------------------------------------------------------------------------------------------------------------------------------------------------------------------------|
| 63:33 | Reserved. |
| 32 | <p>USB6_STS — R/WC.</p> <p>0 = Disable.</p> <p>1 = Set by hardware and can be reset by writing a one to this bit position or a resume well reset. This bit is set when USB UHCI controller #6 needs to cause a wake. Additionally if the <code>USB6_EN</code> bit is set, the setting of the <code>USB6_STS</code> bit will generate a wake event.</p> |
| 31:16 | <p>GPIOn_STS — R/WC.</p> <p>0 = Software clears this bit by writing a 1 to it.</p> <p>1 = These bits are set any time the corresponding GPIO is set up as an input and the corresponding GPIO signal is high (or low if the corresponding <code>GP_INV</code> bit is set). If the corresponding enable bit is set in the <code>GPE0_EN</code> register, then when the <code>GPIO[n]_STS</code> bit is set:</p> <ul style="list-style-type: none"> • If the system is in an S1–S5 state, the event will also wake the system. • If the system is in an S0 state (or upon waking back to an S0 state), a SCI will be caused depending on the <code>GPIO_ROUT</code> bits (D31:F0:B8h, bits 31:30) for the corresponding GPI. <p>NOTE: Mapping is as follows: bit 31 corresponds to <code>GPIO[15]</code>... and bit 16 corresponds to <code>GPIO[0]</code>.</p> |
| 15 | Reserved |
| 14 | <p>USB4_STS — R/WC.</p> <p>0 = Disable.</p> <p>1 = Set by hardware and can be reset by writing a one to this bit position or a resume well reset. This bit is set when USB UHCI controller #4 needs to cause a wake. Additionally if the <code>USB4_EN</code> bit is set, the setting of the <code>USB4_STS</code> bit will generate a wake event.</p> |



| Bit | Description |
|-----|------------------------------------------------------------------------------------------------------------------------------------------------------------------------------------------------------------------------------------------------------------------------------------------------------------------------------------------------------------------------------------------------------------------------------------------------------------------------------------------------------------------------------------------------------------------------------------------------------------------------------------------------------------------------------------------------------------------------------------------------------------------------------------------------------------------------------------------------------------------------------------------------------------------------------------------------------------------------------------------------------------------------------------------------------------------------------------------------------------------------------------------------------------------------------------------------------------|
| 13 | <p>PME_BO_STS — R/WC. This bit will be set to 1 by the ICH10 when any internal device with PCI Power Management capabilities on bus 0 asserts the equivalent of the PME# signal. Additionally, if the PME_BO_EN bit is set, and the system is in an S0 state, then the setting of the PME_BO_STS bit will generate an SCI (or SMI# if SCI_EN is not set). If the PME_BO_STS bit is set, and the system is in an S1–S4 state (or S5 state due to SLP_TYP and SLP_EN), then the setting of the PME_BO_STS bit will generate a wake event, and an SCI (or SMI# if SCI_EN is not set) will be generated. If the system is in an S5 state due to power button override, then the PME_BO_STS bit will not cause a wake event or SCI.</p> <p>The default for this bit is 0. Writing a 1 to this bit position clears this bit.</p> <p>Note: HD audio wake events are reported in this bit. Intel Management Engine “maskable” wake events are also reported in this bit.</p> |
| 12 | <p>USB3_STS — R/WC. 0 = Disable. 1 = Set by hardware and can be reset by writing a one to this bit position or a resume well reset. This bit is set when USB UHCI controller #3 needs to cause a wake. Additionally if the USB3_EN bit is set, the setting of the USB3_STS bit will generate a wake event.</p> |
| 11 | <p>PME_STS — R/WC. 0 = Software clears this bit by writing a 1 to it. 1 = Set by hardware when the PME# signal goes active. Additionally, if the PME_EN bit is set, and the system is in an S0 state, then the setting of the PME_STS bit will generate an SCI or SMI# (if SCI_EN is not set). If the PME_EN bit is set, and the system is in an S1–S4 state (or S5 state due to setting SLP_TYP and SLP_EN), then the setting of the PME_STS bit will generate a wake event, and an SCI will be generated. If the system is in an S5 state due to power button override or a power failure, then PME_STS will not cause a wake event or SCI.</p> |
| 10 | Reserved |
| 9 | <p>PCI_EXP_STS — R/WC. 0 = Software clears this bit by writing a 1 to it. 1 = Set by hardware to indicate that:</p> <ul style="list-style-type: none"> • The PME event message was received on one or more of the PCI Express* ports • An Assert PMEGPE message received from the (G)MCH via DMI <p>NOTES:</p> <ol style="list-style-type: none"> 1. The PCI WAKE# pin has no impact on this bit. 2. If the PCI_EXP_STS bit went active due to an Assert PMEGPE message, then a Deassert PMEGPE message must be received prior to the software write in order for the bit to be cleared. 3. If the bit is not cleared and the corresponding PCI_EXP_EN bit is set, the level-triggered SCI will remain active. 4. A race condition exists where the PCI Express device sends another PME message because the PCI Express device was not serviced within the time when it must resend the message. This may result in a spurious interrupt, and this is comprehended and approved by the <i>PCI Express* Specification, Revision 1.0a</i>. The window for this race condition is approximately 95–105 milliseconds. |
| 8 | <p>RI_STS — R/WC. 0 = Software clears this bit by writing a 1 to it. 1 = Set by hardware when the RI# input signal goes active.</p> |



| Bit | Description |
|-----|-------------------------------------------------------------------------------------------------------------------------------------------------------------------------------------------------------------------------------------------------------------------------------------------------------------------------------------------------------------------------------------------------------------------------------------------------------------------------------------------------------------------------------------------------------------------------------------------------------------------------------------------------------------------------------------------------------------------------------------------------------------------------------------------------------------------------------------------------------------------------------------------------------------------------------------------------------------------------------------------------------------------------------------------------------------------------------------------------------------------------------------------------------------------------------------------------------------------------------------------------------------------------------------------------------------------------------------------------------------------------------------------------------------------------------------------------------------------------------------------------------------------------------------------------|
| 7 | <p>SMBus Wake Status (SMB_WAK_STS) — R/WC. The SMBus controller can independently cause an SMI# or SCI, so this bit does not need to do so (unlike the other bits in this register). Software clears this bit by writing a 1 to it.</p> <p>0 = Wake event Not caused by the ICH10's SMBus logic. 1 = Set by hardware to indicate that the wake event was caused by the ICH10's SMBus logic. This bit will be set by the WAKE/SMI# command type, even if the system is already awake. The SMI handler should then clear this bit.</p> <p>NOTES:</p> <ol style="list-style-type: none"> The SMBus controller will independently cause an SMI# so this bit does not need to do so (unlike the other bits in this register). This bit is set by the SMBus slave command 01h (Wake/SMI#) even when the system is in the S0 state. Therefore, to avoid an instant wake on subsequent transitions to sleep states, software must clear this bit after each reception of the Wake/SMI# command or just prior to entering the sleep state. (Consumer Only) If SMB_WAK_STS is set due to SMBus slave receiving a message, it will be cleared by internal logic when a THRMTRIP# event happens or a Power Button Override event. However, THRMTRIP# or Power Button Override event will not clear SMB_WAK_STS if it is set due to SMBALERT# signal going active. The SMBALERT_STS bit (D31:F3: I/O Offset 00h: Bit 5) should be cleared by software before the SMB_WAK_STS bit is cleared. |
| 6 | <p>TCOSCI_STS — R/WC. Software clears this bit by writing a 1 to it.</p> <p>0 = TOC logic or thermal sensor logic did Not cause SCI. 1 = Set by hardware when the TCO logic or thermal sensor logic causes an SCI.</p> |
| 5 | <p>USB5_STS— R/WC. Software clears this bit by writing a 1 to it.</p> <p>0 = USB UHCI controller 5 does NOT need to cause a wake. 1 = Set by hardware when USB UHCI controller 5 needs to cause a wake. Wake event will be generated if the corresponding USB2_EN bit is set.</p> |
| 4 | <p>USB2_STS — R/WC. Software clears this bit by writing a 1 to it.</p> <p>0 = USB UHCI controller 2 does Not need to cause a wake. 1 = Set by hardware when USB UHCI controller 2 needs to cause a wake. Wake event will be generated if the corresponding USB2_EN bit is set.</p> |
| 3 | <p>USB1_STS — R/WC. Software clears this bit by writing a 1 to it.</p> <p>0 = USB UHCI controller 1 does Not need to cause a wake. 1 = Set by hardware when USB UHCI controller 1 needs to cause a wake. Wake event will be generated if the corresponding USB1_EN bit is set.</p> |
| 2 | <p>SWGPE_STS — R/WC.</p> <p>The SWGPE_CTRL bit (bit 1 of GPE_CTRL reg) acts as a level input to this bit.</p> |
| 1 | <p>HOT_PLUG_STS — R/WC.</p> <p>0 = This bit is cleared by writing a 1 to this bit position. 1 = When a PCI Express* Hot-Plug event occurs. This will cause an SCI if the HOT_PLUG_EN bit is set in the GEPO_EN register.</p> |
| 0 | <p>Thermal Interrupt Status (THRM_STS) — R/WC. Software clears this bit by writing a 1 to it.</p> <p>0 = THRM# signal Not driven active as defined by the THRM_POL bit 1 = Set by hardware anytime the THRM# signal is driven active as defined by the THRM_POL bit. Additionally, if the THRM_EN bit is set, then the setting of the THRM_STS bit will also generate a power management event (SCI or SMI#).</p> |



13.8.3.10 GPE0_EN—General Purpose Event 0 Enables Register

| | | | |
|----------------|---------------------------------------------------------|------------|--------------------------------|
| I/O Address: | PMBASE + 28h (ACPI GPE0_BLK + 8) | Attribute: | Bits 0:32 R/W Bits 33:63 RO |
| Default Value: | 0000000000000000h | Size: | 64-bit |
| Lockable: | No | Usage: | ACPI |
| Power Well: | Bits 0–7, 9, 12, 14–63 Resume, Bits 8, 10–11, 13 RTC | | |

This register is symmetrical to the General Purpose Event 0 Status Register. All the bits in this register should be cleared to 0 based on a Power Button Override or processor Thermal Trip event. The resume well bits are all cleared by RSMRST#. The RTC well bits are cleared by RTCRST#.

| Bit | Description |
|-------|------------------------------------------------------------------------------------------------------------------------------------------------------------------------------------------------------------------------------------------------------------------------------------------------------------------------------------------------------------------------------------------------------------------------|
| 63:33 | Reserved. |
| 32 | USB6_EN — R/W. 0 = Disable. 1 = Enable the setting of the USB4_STS bit to generate a wake event. The USB6_STS bit is set anytime USB UHCI controller #6 signals a wake event. Break events are handled via the USB interrupt. |
| 31:16 | GPI_n_EN — R/W. These bits enable the corresponding GPI[n]_STS bits being set to cause a SCI, and/or wake event. These bits are cleared by RSMRST#. NOTE: Mapping is as follows: bit 31 corresponds to GPIO15... and bit 16 corresponds to GPIO0. |
| 15 | Reserved |
| 14 | USB4_EN — R/W. 0 = Disable. 1 = Enable the setting of the USB4_STS bit to generate a wake event. The USB4_STS bit is set anytime USB UHCI controller #4 signals a wake event. Break events are handled via the USB interrupt. |
| 13 | PME_BO_EN — R/W. 0 = Disable 1 = Enables the setting of the PME_BO_STS bit to generate a wake event and/or an SCI or SMI#. PME_BO_STS can be a wake event from the S1–S4 states, or from S5 (if entered via SLP_TYP and SLP_EN) or power failure, but not Power Button Override. This bit defaults to 0. NOTE: It is only cleared by Software or RTCRST#. It is not cleared by CF9h writes. |
| 12 | USB3_EN — R/W. 0 = Disable. 1 = Enable the setting of the USB3_STS bit to generate a wake event. The USB3_STS bit is set anytime USB UHCI controller #3 signals a wake event. Break events are handled via the USB interrupt. |
| 11 | PME_EN — R/W. 0 = Disable. 1 = Enables the setting of the PME_STS to generate a wake event and/or an SCI. PME# can be a wake event from the S1 – S4 state or from S5 (if entered via SLP_EN, but not power button override). |
| 10 | Reserved |



| Bit | Description |
|-----|------------------------------------------------------------------------------------------------------------------------------------------------------------------------------------------------------------------------------------------------------------------------------------------------------------------------------------------------------------------------------------------------------------------------------|
| 9 | PCI_EXP_EN — R/W. 0 = Disable SCI generation upon PCI_EXP_STS bit being set. 1 = Enables ICH10 to cause an SCI when PCI_EXP_STS bit is set. This is used to allow the PCI Express* ports, including the link to the (G)MCH, to cause an SCI due to wake/PME events. |
| 8 | RI_EN — R/W. The value of this bit will be maintained through a G3 state and is not affected by a hard reset caused by a CF9h write. 0 = Disable. 1 = Enables the setting of the RI_STS to generate a wake event. |
| 7 | Reserved |
| 6 | TCOSCI_EN — R/W. 0 = Disable. 1 = Enables the setting of the TCOSCI_STS to generate an SCI. |
| 5 | USB5_EN — R/W. 0 = Disable. 1 = Enables the setting of the USB5_STS to generate a wake event. |
| 4 | USB2_EN — R/W. 0 = Disable. 1 = Enables the setting of the USB2_STS to generate a wake event. |
| 3 | USB1_EN — R/W. 0 = Disable. 1 = Enables the setting of the USB1_STS to generate a wake event. |
| 2 | SWGPE_EN — R/W. This bit allows software to control the assertion of SWGPE_STS bit. This bit This bit, when set to 1, enables the SW GPE function. If SWGPE_CTRL is written to a 1, hardware will set SWGPE_STS (acts as a level input) If SWGPE_STS, SWGPE_EN, and SCI_EN are all 1s, an SCI will be generated. If SWGPE_STS = 1, SWGPE_EN = 1, SCI_EN = 0, and GBL_SMI_EN = 1 then an SMI# will be generated. |
| 1 | HOT_PLUG_EN — R/W. 0 = Disables SCI generation upon the HOT_PLUG_STS bit being set. 1 = Enables the ICH10 to cause an SCI when the HOT_PLUG_STS bit is set. This is used to allow the PCI Express ports to cause an SCI due to hot-plug events. |
| 0 | THRM_EN — R/W. 0 = Disable. 1 = Active assertion of the THRM# signal (as defined by the THRM_POL bit) will generate a power management event (SCI or SMI) if the THRM_STS bit is also set. |



13.8.3.11 SMI_EN—SMI Control and Enable Register

| | | | |
|----------------|-----------------------|------------|----------------|
| I/O Address: | PMBASE + 30h | Attribute: | R/W, R/WO, WO |
| Default Value: | 00000000h (Consumer) | Size: | 32 bit |
| Default Value: | 00000002h (Corporate) | | |
| Lockable: | No | Usage: | ACPI or Legacy |
| Power Well: | Core | | |

Note: This register is symmetrical to the SMI status register.

| Bit | Description |
|-------|-----------------------------------------------------------------------------------------------------------------------------------------------------------------------------------------------------------------------------------------------------------------------------------------------------------------------------------------------------------------------------------------------------------------------------------------------------------------------------------------|
| 31:28 | Reserved |
| 27 | GPIO_UNLOCK_SMI_EN — R/WO. Setting this bit will cause the Intel ICH10 to generate an SMI# when the GPIO_UNLOCK_SMI_STS bit is set in the SMI_STS register. Once written to '1', this bit can only be cleared by PLTRST#. |
| 26:19 | Reserved |
| 18 | INTEL_USB2_EN — R/W. 0 = Disable 1 = Enables Intel-Specific USB2 SMI logic to cause SMI#. |
| 17 | LEGACY_USB2_EN — R/W. 0 = Disable 1 = Enables legacy USB2 logic to cause SMI#. |
| 16:15 | Reserved |
| 14 | PERIODIC_EN — R/W. 0 = Disable. 1 = Enables the ICH10 to generate an SMI# when the PERIODIC_STS bit (PMBASE + 34h, bit 14) is set in the SMI_STS register (PMBASE + 34h). |
| 13 | TCO_EN — R/W. 0 = Disables TCO logic generating an SMI#. Note that if the NMI2SMI_EN bit is set, SMIs that are caused by re-routed NMIs will not be gated by the TCO_EN bit. Even if the TCO_EN bit is 0, NMIs will still be routed to cause SMIs. 1 = Enables the TCO logic to generate SMI#. NOTE: This bit cannot be written once the TCO_LOCK bit is set. |
| 12 | Reserved |
| 11 | MCSMI_EN Microcontroller SMI Enable (MCSMI_EN) — R/W. 0 = Disable. 1 = Enables ICH10 to trap accesses to the microcontroller range (62h or 66h) and generate an SMI#. Note that "trapped" cycles will be claimed by the ICH10 on PCI, but not forwarded to LPC. |
| 10:8 | Reserved |
| 7 | BIOS Release (BIOS_RLS) — WO. 0 = This bit will always return 0 on reads. Writes of 0 to this bit have no effect. 1 = Enables the generation of an SCI interrupt for ACPI software when a one is written to this bit position by BIOS software. NOTE: GBL_STS being set will cause an SCI, even if the SCI_EN bit is not set. Software must take great care not to set the BIOS_RLS bit (which causes GBL_STS to be set) if the SCI handler is not in place. |



| Bit | Description |
|-----|----------------------------------------------------------------------------------------------------------------------------------------------------------------------------------------------------------------------------------------------------------------------------------------------------------------------------------------------------------------------------------------------------------------------------------------------------------------------------------------------------------------------------------------------------------------------------------------------------------------------------------------------------------------------------------------------------------------------------------------------------------------------------------------------------------------------------------------------------------------------|
| 6 | <p>Software SMI# Timer Enable (SWSMI_TMR_EN) — R/W.</p> <p>0 = Disable. Clearing the SWSMI_TMR_EN bit before the timer expires will reset the timer and the SMI# will not be generated.</p> <p>1 = Starts Software SMI# Timer. When the SWSMI timer expires (the timeout period depends upon the SWSMI_RATE_SEL bit setting), SWSMI_TMR_STS is set and an SMI# is generated. SWSMI_TMR_EN stays set until cleared by software.</p> |
| 5 | <p>APMC_EN — R/W.</p> <p>0 = Disable. Writes to the APM_CNT register will not cause an SMI#.</p> <p>1 = Enables writes to the APM_CNT register to cause an SMI#.</p> |
| 4 | <p>SLP_SMI_EN — R/W.</p> <p>0 = Disables the generation of SMI# on SLP_EN. Note that this bit must be 0 before the software attempts to transition the system into a sleep state by writing a 1 to the SLP_EN bit.</p> <p>1 = A write of 1 to the SLP_EN bit (bit 13 in PM1_CNT register) will generate an SMI#, and the system will not transition to the sleep state based on that write to the SLP_EN bit.</p> |
| 3 | <p>LEGACY_USB_EN — R/W.</p> <p>0 = Disable.</p> <p>1 = Enables legacy USB circuit to cause SMI#.</p> |
| 2 | <p>BIOS_EN — R/W.</p> <p>0 = Disable.</p> <p>1 = Enables the generation of SMI# when ACPI software writes a 1 to the GBL_RLS bit (D31:F0:PMBase + 04h:bit 2). Note that if the BIOS_STS bit (D31:F0:PMBase + 34h:bit 2), which gets set when software writes 1 to GBL_RLS bit, is already a 1 at the time that BIOS_EN becomes 1, an SMI# will be generated when BIOS_EN gets set.</p> |
| 1 | <p>End of SMI (EOS) — R/W (special). This bit controls the arbitration of the SMI signal to the processor. This bit must be set for the ICH10 to assert SMI# low to the processor after SMI# has been asserted previously.</p> <p>0 = Once the ICH10 asserts SMI# low, the EOS bit is automatically cleared.</p> <p>1 = When this bit is set to 1, SMI# signal will be deasserted for 4 PCI clocks before its assertion. In the SMI handler, the processor should clear all pending SMIs (by servicing them and then clearing their respective status bits), set the EOS bit, and exit SMM. This will allow the SMI arbiter to re-assert SMI upon detection of an SMI event and the setting of a SMI status bit.</p> <p>NOTE: ICH10 is able to generate 1st SMI after reset even though EOS bit is not set. Subsequent SMI require EOS bit is set.</p> |
| 0 | <p>GBL_SMI_EN — R/W.</p> <p>0 = No SMI# will be generated by ICH10. This bit is reset by a PCI reset event.</p> <p>1 = Enables the generation of SMI# in the system upon any enabled SMI event.</p> <p>NOTE: When the SMI_LOCK bit is set, this bit cannot be changed.</p> |



13.8.3.12 SMI_STS—SMI Status Register

| | | | |
|----------------|--------------|------------|----------------|
| I/O Address: | PMBASE + 34h | Attribute: | RO, R/WC |
| Default Value: | 00000000h | Size: | 32-bit |
| Lockable: | No | Usage: | ACPI or Legacy |
| Power Well: | Core | | |

Note: If the corresponding `_EN` bit is set when the `_STS` bit is set, the ICH10 will cause an SMI# (except bits 8–10 and 12, which do not need enable bits since they are logic ORs of other registers that have enable bits). The ICH10 uses the same GPE0_EN register (I/O address: PMBase+2Ch) to enable/disable both SMI and ACPI SCI general purpose input events. ACPI OS assumes that it owns the entire GPE0_EN register per ACPI spec. Problems arise when some of the general-purpose inputs are enabled as SMI by BIOS, and some of the general purpose inputs are enabled for SCI. In this case ACPI OS turns off the enabled bit for any GPIx input signals that are not indicated as SCI general-purpose events at boot, and exit from sleeping states. BIOS should define a dummy control method which prevents the ACPI OS from clearing the SMI GPE0_EN bits.

| Bit | Description |
|-------|-----------------------------------------------------------------------------------------------------------------------------------------------------------------------------------------------------------------------------------------------------------------------------------------------------------------------------------------------------------------------------------------------------------------------------------------------------------------------------------------------------------------------------------------------------------------------------------|
| 31:28 | Reserved |
| 27 | GPIO_UNLOCK_SMI_STS — R/WC. This bit will be set if the GPIO registers lockdown logic is requesting an SMI#. Writing a 1 to this bit position clears this bit to 0. |
| 26 | SPI_STS — RO. This bit will be set if the SPI logic is generating an SMI#. This bit is read only because the sticky status and enable bits associated with this function are located in the SPI registers. |
| 25:22 | Reserved |
| 21 | MONITOR_STS — RO. This bit will be set if the Trap/SMI logic has caused the SMI. This will occur when the processor or a bus master accesses an assigned register (or a sequence of accesses). See Section 10.1.43 through Section 10.1.49 for details on the specific cause of the SMI. |
| 20 | PCI_EXP_SMI_STS — RO. PCI Express* SMI event occurred. This could be due to a PCI Express PME event or Hot-Plug event. |
| 19 | Reserved |
| 18 | INTEL_USB2_STS — RO. This non-sticky read-only bit is a logical OR of each of the SMI status bits in the Intel-Specific USB2 SMI Status Register ANDed with the corresponding enable bits. Additionally, the Port Disable Write Enable SMI is reported in this bit; the specific status bit for this event is contained in the USB Per-Port Registers Write Control Register in this I/O space. This bit will not be active if the enable bits are not set. Writes to this bit will have no effect. All integrated USB2 Host Controllers are represented with this bit. |
| 17 | LEGACY_USB2_STS — RO. This non-sticky read-only bit is a logical OR of each of the SMI status bits in the USB2 Legacy Support Register ANDed with the corresponding enable bits. This bit will not be active if the enable bits are not set. Writes to this bit will have no effect. All integrated USB2 Host Controllers are represented with this bit. |

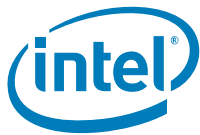

| Bit | Description |
|-----|-----------------------------------------------------------------------------------------------------------------------------------------------------------------------------------------------------------------------------------------------------------------------------------------------------------------------------------------------------------------------------------------------------------------------------------------------------------------------------------------------------------------------------------------------------------------------------------------------------------------------------------------------------------------------------------------------------------------------------------------------------------------------------------------------------------------|
| 16 | <p>SMBus SMI Status (SMBUS_SMI_STS) — R/WC. Software clears this bit by writing a 1 to it.</p> <p>0 = This bit is set from the 64 kHz clock domain used by the SMBus. Software must wait at least 15.63 μs after the initial assertion of this bit before clearing it.</p> <p>1 = Indicates that the SMI# was caused by:</p> <ol style="list-style-type: none"> 1. The SMBus Slave receiving a message that an SMI# should be caused, or 2. The SMBALERT# signal goes active and the SMB_SMI_EN bit is set and the SMBALERT_DIS bit is cleared, or 3. The SMBus Slave receiving a Host Notify message and the HOST_NOTIFY_INTREN and the SMB_SMI_EN bits are set, or 4. The ICH10 detecting the SMLINK_SLAVE_SMI command while in the S0 state. |
| 15 | <p>SERIRQ_SMI_STS — RO.</p> <p>0 = SMI# was not caused by the SERIRQ decoder.</p> <p>1 = Indicates that the SMI# was caused by the SERIRQ decoder.</p> <p>NOTE: This is not a sticky bit</p> |
| 14 | <p>PERIODIC_STS — R/WC. Software clears this bit by writing a 1 to it.</p> <p>0 = Software clears this bit by writing a 1 to it.</p> <p>1 = This bit is set at the rate determined by the PER_SMI_SEL bits. If the PERIODIC_EN bit (PMBASE + 30h, bit 14) is also set, the ICH10 generates an SMI#.</p> |
| 13 | <p>TCO_STS — R/WC. Software clears this bit by writing a 1 to it.</p> <p>0 = SMI# not caused by TCO logic.</p> <p>1 = Indicates the SMI# was caused by the TCO logic. Note that this is not a wake event.</p> |
| 12 | <p>Device Monitor Status (DEVMON_STS) — RO.</p> <p>0 = SMI# not caused by Device Monitor.</p> <p>1 = Set if bit 0 of the DEVACT_STS register (PMBASE + 44h) is set. The bit is not sticky, so writes to this bit will have no effect.</p> |
| 11 | <p>Microcontroller SMI# Status (MCSMI_STS) — R/WC. Software clears this bit by writing a 1 to it.</p> <p>0 = Indicates that there has been no access to the power management microcontroller range (62h or 66h).</p> <p>1 = Set if there has been an access to the power management microcontroller range (62h or 66h) and the Microcontroller Decode Enable #1 bit in the LPC Bridge I/O Enables configuration register is 1 (D31:F0:Offset 82h:bit 11). Note that this implementation assumes that the Microcontroller is on LPC. If this bit is set, and the MCSMI_EN bit is also set, the ICH10 will generate an SMI#.</p> |
| 10 | <p>GPE0_STS — RO. This bit is a logical OR of the bits in the ALT_GP_SMI_STS register that are also set up to cause an SMI# (as indicated by the GPI_ROUT registers) and have the corresponding bit set in the ALT_GP_SMI_EN register. Bits that are not routed to cause an SMI# will have no effect on this bit.</p> <p>0 = SMI# was not generated by a GPI assertion.</p> <p>1 = SMI# was generated by a GPI assertion.</p> |
| 9 | <p>GPE0_STS — RO. This bit is a logical OR of the bits 47:32, 14:10, 8, 6:2 and 0 in the GPE0_STS register (PMBASE + 28h) that also have the corresponding bit set in the GPE0_EN register (PMBASE + 2Ch).</p> <p>0 = SMI# was not generated by a GPE0 event.</p> <p>1 = SMI# was generated by a GPE0 event.</p> |



| Bit | Description |
|-----|-----------------------------------------------------------------------------------------------------------------------------------------------------------------------------------------------------------------------------------------------------------------------------------------------------------------------------------------------------------------------------------------------------------|
| 8 | PM1_STS_REG — RO. This is an ORs of the bits in the ACPI PM1 Status Register (offset PMBASE+00h) that can cause an SMI#. 0 = SMI# was not generated by a PM1_STS event. 1 = SMI# was generated by a PM1_STS event. |
| 7 | Reserved |
| 6 | SWSMI_TMR_STS — R/WC. Software clears this bit by writing a 1 to it. 0 = Software SMI# Timer has Not expired. 1 = Set by the hardware when the Software SMI# Timer expires. |
| 5 | APM_STS — R/WC. Software clears this bit by writing a 1 to it. 0 = No SMI# generated by write access to APM Control register with APMCH_EN bit set. 1 = SMI# was generated by a write access to the APM Control register with the APMC_EN bit set. |
| 4 | SLP_SMI_STS — R/WC. Software clears this bit by writing a 1 to the bit location. 0 = No SMI# caused by write of 1 to SLP_EN bit when SLP_SMI_EN bit is also set. 1 = Indicates an SMI# was caused by a write of 1 to SLP_EN bit when SLP_SMI_EN bit is also set. |
| 3 | LEGACY_USB_STS — RO. This bit is a logical OR of each of the SMI status bits in the USB Legacy Keyboard/Mouse Control Registers ANDed with the corresponding enable bits. This bit will not be active if the enable bits are not set. 0 = SMI# was not generated by USB Legacy event. 1 = SMI# was generated by USB Legacy event. |
| 2 | BIOS_STS — R/WC. 0 = No SMI# generated due to ACPI software requesting attention. 1 = This bit gets set by hardware when a 1 is written by software to the GBL_RLS bit (D31:F0:PMBase + 04h:bit 2). When both the BIOS_EN bit (D31:F0:PMBase + 30h:bit 2) and the BIOS_STS bit are set, an SMI# will be generated. The BIOS_STS bit is cleared when software writes a 1 to its bit position. |
| 1:0 | Reserved |

13.8.3.13 ALT_GP_SMI_EN—Alternate GPI SMI Enable Register

| | | | |
|----------------|-------------|------------|----------------|
| I/O Address: | PMBASE +38h | Attribute: | R/W |
| Default Value: | 0000h | Size: | 16-bit |
| Lockable: | No | Usage: | ACPI or Legacy |
| Power Well: | Resume | | |

| Bit | Description |
|------|-----------------------------------------------------------------------------------------------------------------------------------------------------------------------------------------------------------------------------------------------------------------------------------------------------------------------------------------------------------------------------------------------------------------------------------------------------------------------------------------------------------------------------------------|
| 15:0 | Alternate GPI SMI Enable — R/W. These bits are used to enable the corresponding GPIO to cause an SMI#. For these bits to have any effect, the following must be true. <ul style="list-style-type: none"> The corresponding bit in the ALT_GP_SMI_EN register is set. The corresponding GPI must be routed in the GPI_ROUT register to cause an SMI. The corresponding GPIO must be implemented. NOTE: Mapping is as follows: bit 15 corresponds to GPIO15... bit 0 corresponds to GPIO0. |



13.8.3.14 ALT_GP_SMI_STS—Alternate GPI SMI Status Register

| | | | |
|----------------|--------------|------------|----------------|
| I/O Address: | PMBASE + 3Ah | Attribute: | R/WC |
| Default Value: | 0000h | Size: | 16-bit |
| Lockable: | No | Usage: | ACPI or Legacy |
| Power Well: | Resume | | |

| Bit | Description |
|------|------------------------------------------------------------------------------------------------------------------------------------------------------------------------------------------------------------------------------------------------------------------------------------------------------------------------------------------------------------------------------------------------------------------------------------------------------------------------------------------------------------------------------------------------------------------------------------------------------------------------------------------------------------------------------------------------------------------------|
| 15:0 | <p>Alternate GPI SMI Status — R/WC. These bits report the status of the corresponding GPIOs.</p> <p>0 = Inactive. Software clears this bit by writing a 1 to it.</p> <p>1 = Active</p> <p>These bits are sticky. If the following conditions are true, then an SMI# will be generated and the GPEO_STS bit set:</p> <ul style="list-style-type: none"> • The corresponding bit in the ALT_GPI_SMI_EN register (PMBASE + 38h) is set • The corresponding GPIO must be routed in the GPI_ROUT register to cause an SMI. • The corresponding GPIO must be implemented. <p>All bits are in the resume well. Default for these bits is dependent on the state of the GPIO pins.</p> |

13.8.3.15 UPRWC—USB Per-Port Registers Write Control

| | | | |
|----------------|--------------|------------|-----------------|
| I/O Address: | PMBASE + 3Ch | Attribute: | R/WC, R/W, R/WO |
| Default Value: | 0000h | Size: | 16-bit |
| Lockable: | No | Usage: | ACPI or Legacy |
| Power Well: | Resume | | |

| Bit | Description |
|------|----------------------------------------------------------------------------------------------------------------------------------------------------------------------------------------------------------------------------------------------------------------------------------------------------------------------------------------------------------------------------------------------------------------------------------------------------------|
| 15:9 | Reserved |
| 8 | <p>Write Enable Status — R/WC</p> <p>0 = This bit gets set by hardware when the “Per-Port Registers Write Enable” bit is written from 0-to-1.</p> <p>1 = This bit is cleared by software writing a 1b to this bit location</p> <p>The setting condition takes precedence over the clearing condition in the event that both occur at once.</p> <p>When this bit is 1b and bit 0 is 1b, the INTEL_USB2_STS bit is set in the SMI_STS register.</p> |
| 7:2 | Reserved. |
| 1 | Reserved |
| 0 | <p>Write Enable SMI Enable— R/WO</p> <p>0 = Disable</p> <p>1 = enables the generation of SMI when the Per-Port Registers Write Enable (bit 1) is written from 0 to 1. Once written to 1b, this bit can not be cleared by software.</p> |



13.8.3.16 GPE_CNTL— General Purpose Control Register

| | | | |
|----------------|--------------|------------|----------------|
| I/O Address: | PMBASE + 42h | Attribute: | R/W |
| Default Value: | 00h | Size: | 8-bit |
| Lockable: | No | Usage: | ACPI or Legacy |
| Power Well: | Resume | | |

| Bit | Description |
|-----|---------------------------------------------------------------------------------------------------------------------------------------------------------------------------------------------------------------------------------------------------------------------------------------------------------------------------------------------------------------------------------------------------------------------------------------------------------------------|
| 8:2 | Reserved |
| 1 | SWGPE_CTRL — R/W. This bit allows software to control the assertion of SWGPE_STS bit. This bit is used by hardware as the level input signal for the SWGPE_STS bit in the GPE0_STS register. When SWGPE_CTRL is 1, SWGPE_STS will be set to 1, and writes to SWGPE_STS with a value of 1 to clear SWGPE_STS will result in SWGPE_STS being set back to 1 by hardware. When SWGPE_CTRL is 0, writes to SWGPE_STS with a value of 1 will clear SWGPE_STS to 0. |
| 0 | THRM#_POL — R/W. This bit controls the polarity of the THRM# pin needed to set the THRM_STS bit. 0 = Low value on the THRM# signal will set the THRM_STS bit. 1 = HIGH value on the THRM# signal will set the THRM_STS bit. |

13.8.3.17 DEVACT_STS — Device Activity Status Register

| | | | |
|----------------|--------------|------------|-------------|
| I/O Address: | PMBASE + 44h | Attribute: | R/WC |
| Default Value: | 0000h | Size: | 16-bit |
| Lockable: | No | Usage: | Legacy Only |
| Power Well: | Core | | |

Each bit indicates if an access has occurred to the corresponding device's trap range, or for bits 6:9 if the corresponding PCI interrupt is active. This register is used in conjunction with the Periodic SMI# timer to detect any system activity for legacy power management. The periodic SMI# timer indicates if it is the right time to read the DEVACT_STS register (PMBASE + 44h).

Note: Software clears bits that are set in this register by writing a 1 to the bit position.

| Bit | Description |
|-------|---------------------------------------------------------------------------------------------------------------------------------------------------------------------------------------------------------------------------------------|
| 15:13 | Reserved |
| 12 | KBC_ACT_STS — R/WC. KBC (60/64h). 0 = Indicates that there has been no access to this device's I/O range. 1 = This device's I/O range has been accessed. Clear this bit by writing a 1 to the bit location. |
| 11:10 | Reserved |
| 9 | PIRQDH_ACT_STS — R/WC. PIRQ[D or H]. 0 = The corresponding PCI interrupts have not been active. 1 = At least one of the corresponding PCI interrupts has been active. Clear this bit by writing a 1 to the bit location. |
| 8 | PIRQCG_ACT_STS — R/WC. PIRQ[C or G]. 0 = The corresponding PCI interrupts have not been active. 1 = At least one of the corresponding PCI interrupts has been active. Clear this bit by writing a 1 to the bit location. |



| Bit | Description |
|-----|---------------------------------------------------------------------------------------------------------------------------------------------------------------------------------------------------------------------------------------|
| 7 | PIRQBF_ACT_STS — R/WC. PIRQ[B or F]. 0 = The corresponding PCI interrupts have not been active. 1 = At least one of the corresponding PCI interrupts has been active. Clear this bit by writing a 1 to the bit location. |
| 6 | PIRQAE_ACT_STS — R/WC. PIRQ[A or E]. 0 = The corresponding PCI interrupts have not been active. 1 = At least one of the corresponding PCI interrupts has been active. Clear this bit by writing a 1 to the bit location. |
| 5:0 | Reserved |

13.8.3.18 PM2_CNT—Power Management 2 Control

I/O Address: PMBASE + 50h (ACPI PM2_CNT_BLK) Attribute: R/W
 Default Value: 00h Size: 8-bit
 Lockable: No Usage: ACPI
 Power Well: Core

| Bit | Description |
|-----|-----------------------------------------------------------------------------------------------------------------------------------------------------------------------------------------------------------------------------------------------------------------------------------------------------------------------------------------------------------------------------------------------------------------------------------------------------------------------------------------------------------------------------------------------------------------------------------------------------------------------------------------------------|
| 7:1 | Reserved |
| 0 | Arbiter Disable (ARB_DIS) — R/W This bit is essentially just a scratchpad bit for legacy software compatibility. Software typically sets this bit to 1 prior to entering a C3 or C4 state. When a transition to a C3 or C4 state occurs, ICH10 will automatically prevent any internal or external non-Isoch bus masters from initiating any cycles up to the (G)MCH. This blocking starts immediately upon the ICH10 sending the Go-C3 message to the (G)MCH. The blocking stops when the Ack-C2 message is received. Note that this is not really blocking, in that messages (such as from PCI Express*) are just queued and held pending. |

13.8.3.19 C3_RES— C3 Residency Register

I/O Address: PMBASE + 54h Attribute: RO
 Default Value: 00000000h Size: 32-bit
 Lockable: No Usage: ACPI/Legacy
 Power Well: Core

Software may only write this register during system initialization to set the state of the C3_RESIDENCY_MODE bit. It must not be written while the timer is in use.

| Bit | Description |
|-------|-------------------------------------------------------------------------------------------------------------------------------------------------------------------------------------------------------------------------------------------------------------------------------------------------------------------------------------------------------------------------------------------------------------------------------------------------------------------------------------------------------------------------------------------------------------------------------|
| 31:24 | Reserved |
| 23:0 | C3_RESIDENCY — RO. The value in this field increments at the same rate as the Power Management Timer. This field increments while STP_CPU# is active (i.e., the processor is in a C3 or C4 state). This field will roll over in the same way as the PM Timer, however the most significant bit is NOT sticky. Software is responsible for reading this field before performing the Lvl3/4 transition. Software must also check for rollover if the maximum time in C3/C4 could be exceeded. NOTE: Hardware reset is the only reset of this counter field. |



13.9 System Management TCO Registers (D31:F0)

The TCO logic is accessed via registers mapped to the PCI configuration space (Device 31:Function 0) and the system I/O space. For TCO PCI Configuration registers, see LPC Device 31:Function 0 PCI Configuration registers.

TCO Register I/O Map

The TCO I/O registers reside in a 32-byte range pointed to by a TCOBASE value, which is, PMBASE + 60h in the PCI config space. The following table shows the mapping of the registers within that 32-byte range. Each register is described in the following sections.

Table 13-12. TCO I/O Register Address Map

| TCOBASE + Offset | Mnemonic | Register Name | Default | Type |
|------------------|----------------------------|------------------------------------|---------|------------------|
| 00h–01h | TCO_RLD | TCO Timer Reload and Current Value | 0000h | R/W |
| 02h | TCO_DAT_IN | TCO Data In | 00h | R/W |
| 03h | TCO_DAT_OUT | TCO Data Out | 00h | R/W |
| 04h–05h | TCO1_STS | TCO1 Status | 0000h | R/WC, RO |
| 06h–07h | TCO2_STS | TCO2 Status | 0000h | R/WC |
| 08h–09h | TCO1_CNT | TCO1 Control | 0000h | R/W, R/WLO, R/WC |
| 0Ah–0Bh | TCO2_CNT | TCO2 Control | 0008h | R/W |
| 0Ch–0Dh | TCO_MESSAGE1, TCO_MESSAGE2 | TCO Message 1 and 2 | 00h | R/W |
| 0Eh | TCO_WDCNT | Watchdog Control | 00h | R/W |
| 0Fh | — | Reserved | — | — |
| 10h | SW_IRQ_GEN | Software IRQ Generation | 03h | R/W |
| 11h | — | Reserved | — | — |
| 12h–13h | TCO_TMR | TCO Timer Initial Value | 0004h | R/W |
| 14h–1Fh | — | Reserved | — | — |

13.9.1 TCO_RLD—TCO Timer Reload and Current Value Register

I/O Address: TCOBASE +00h Attribute: R/W
 Default Value: 0000h Size: 16-bit
 Lockable: No Power Well: Core

| Bit | Description |
|-------|--------------------------------------------------------------------------------------------------------------------------------------------------------------------------------------|
| 15:10 | Reserved |
| 9:0 | TCO Timer Value — R/W. Reading this register will return the current count of the TCO timer. Writing any value to this register will reload the timer to prevent the timeout. |



13.9.2 TCO_DAT_IN—TCO Data In Register

I/O Address: TCOBASE +02h Attribute: R/W
Default Value: 00h Size: 8-bit
Lockable: No Power Well: Core

| Bit | Description |
|-----|-----------------------------------------------------------------------------------------------------------------------------------------------------------------------------------------------------------------------------------|
| 7:0 | TCO Data In Value — R/W. This data register field is used for passing commands from the OS to the SMI handler. Writes to this register will cause an SMI and set the SW_TCO_SMI bit in the TCO1_STS register (D31:F0:04h). |

13.9.3 TCO_DAT_OUT—TCO Data Out Register

I/O Address: TCOBASE +03h Attribute: R/W
Default Value: 00h Size: 8-bit
Lockable: No Power Well: Core

| Bit | Description |
|-----|----------------------------------------------------------------------------------------------------------------------------------------------------------------------------------------------------------------------------------------------------------------------------|
| 7:0 | TCO Data Out Value — R/W. This data register field is used for passing commands from the SMI handler to the OS. Writes to this register will set the TCO_INT_STS bit in the TCO_STS register. It will also cause an interrupt, as selected by the TCO_INT_SEL bits. |

13.9.4 TCO1_STS—TCO1 Status Register

I/O Address: TCOBASE +04h Attribute: R/WC, RO
Default Value: 0000h (Consumer Only)
2000h (Corporate Only) Size: 16-bit
Lockable: No Power Well: Core
(Except bit 7, in RTC)

| Bit | Description |
|------------------------|-----------------------------------------------------------------------------------------------------------------------------------------------------------------------------------------------------------------------------------------------------------------|
| 15:14 | Reserved |
| 13 (Corporate Only) | TCO_SLVSEL (TCO Slave Select) - RO. This register bit is Read Only by Host and indicates the value of TCO Slave Select Soft Strap. Refer to the ICH Soft Straps section of the SPI Chapter for details. |
| 13 (Consumer Only) | Reserved |
| 12 | DMISERR_STS — R/WC. 0 = Software clears this bit by writing a 1 to it. 1 = ICH10 received a DMI special cycle message via DMI indicating that it wants to cause an SERR#. The software must read the (G)MCH to determine the reason for the SERR#. |
| 11 | Reserved |
| 10 | DMI_SMI_STS — R/WC. 0 = Software clears this bit by writing a 1 to it. 1 = ICH10 received a DMI special cycle message via DMI indicating that it wants to cause an SMI. The software must read the (G)MCH to determine the reason for the SMI. |



| Bit | Description |
|-----|---------------------------------------------------------------------------------------------------------------------------------------------------------------------------------------------------------------------------------------------------------------------------------------------------------------------------------------------------------------------------------------------------------------------------------------------------------------------------------------------------------------------------------------------------------------------------------------------------------------------------------------------------------------------------------------------------------------------------------------------------------------------------------------------------------------------------------------------------------------------------------------------------------------------------------------------------------------------------------------------------------------------------------------------------------------------------------------------------------------|
| 9 | <p>DMISCI_STS — R/WC.</p> <p>0 = Software clears this bit by writing a 1 to it. 1 = ICH10 received a DMI special cycle message via DMI indicating that it wants to cause an SCI. The software must read the (G)MCH to determine the reason for the SCI.</p> |
| 8 | <p>BIOSWR_STS — R/WC.</p> <p>0 = Software clears this bit by writing a 1 to it. 1 = ICH10 sets this bit and generates and SMI# to indicate an invalid attempt to write to the BIOS. This occurs when either:</p> <ul style="list-style-type: none"> a) The BIOSWP bit is changed from 0 to 1 and the BLD bit is also set, or b) any write is attempted to the BIOS and the BIOSWP bit is also set. <p>NOTE: On write cycles attempted to the 4 MB lower alias to the BIOS space, the BIOSWR_STS will not be set.</p> |
| 7 | <p>NEWCENTURY_STS — R/WC. This bit is in the RTC well.</p> <p>0 = Cleared by writing a 1 to the bit position or by RTCRST# going active. 1 = This bit is set when the Year byte (RTC I/O space, index offset 09h) rolls over from 99 to 00. Setting this bit will cause an SMI# (but not a wake event).</p> <p>NOTE: The NEWCENTURY_STS bit is not valid when the RTC battery is first installed (or when RTC power has not been maintained). Software can determine if RTC power has not been maintained by checking the RTC_PWR_STS bit (D31:F0:A4h, bit 2), or by other means (such as a checksum on RTC RAM). If RTC power is determined to have not been maintained, BIOS should set the time to a valid value and then clear the NEWCENTURY_STS bit.</p> <p>The NEWCENTURY_STS bit may take up to 3 RTC clocks for the bit to be cleared after a 1 is written to the bit to clear it. After writing a 1 to this bit, software should not exit the SMI handler until verifying that the bit has actually been cleared. This will ensure that the SMI is not re-entered.</p> |
| 6:4 | Reserved |
| 3 | <p>TIMEOUT — R/WC.</p> <p>0 = Software clears this bit by writing a 1 to it. 1 = Set by ICH10 to indicate that the SMI was caused by the TCO timer reaching 0.</p> |
| 2 | <p>TCO_INT_STS — R/WC.</p> <p>0 = Software clears this bit by writing a 1 to it. 1 = SMI handler caused the interrupt by writing to the TCO_DAT_OUT register (TCOBASE + 03h).</p> |
| 1 | <p>SW_TCO_SMI — R/WC.</p> <p>0 = Software clears this bit by writing a 1 to it. 1 = Software caused an SMI# by writing to the TCO_DAT_IN register (TCOBASE + 02h).</p> |
| 0 | <p>NMI2SMI_STS — RO.</p> <p>0 = Cleared by clearing the associated NMI status bit. 1 = Set by the ICH10 when an SMI# occurs because an event occurred that would otherwise have caused an NMI (because NMI2SMI_EN is set).</p> |



13.9.5 TCO2_STS—TCO2 Status Register

| | | | |
|----------------|--------------|-------------|----------------------------------|
| I/O Address: | TCOBASE +06h | Attribute: | R/WC |
| Default Value: | 0000h | Size: | 16-bit |
| Lockable: | No | Power Well: | Resume (Except Bit 0, in RTC) |

| Bit | Description |
|-------------------------|------------------------------------------------------------------------------------------------------------------------------------------------------------------------------------------------------------------------------------------------------------------------------------------------------------------------------------------------------------------------------------------------------------------------------------------------------------------------------------------------------------------------------------------------------------------------------------------------------------------------------------------------------------------------------------------------------------------------------------------------------------------------------------|
| 15:8 | Reserved |
| 7:5 (Corporate Only) | Reserved |
| 7 (Consumer Only) | ME Host Reset Warm Status (ME_HRST_WARM_STS) — R/WC. This bit is set when the Intel Management Engine generates a Host reset without power cycling. Software clears this bit by writing a 1 to this bit position. |
| 6 (Consumer Only) | ME Host Reset Cold Status (ME_HRST_COLD_STS) — R/WC. This bit is set when the Intel Management Engine generates a Host reset with power cycling. Software clears this bit by writing a 1 to this bit position. |
| 5 (Consumer Only) | ME WAKE STATUS (ME_WAKE_STS) — R/WC. This bit is set when the Intel Management Engine generates a Non-Maskable wake event, and is not affected by any other enable bit. When this bit is set, the Host Power Management logic wakes to S0. This bit is only set by hardware and can only be reset by writing a one to this bit position. This bit is not affected by hard resets caused by a CF9h write, but is reset by RSMRST. |
| 4 | SMLink Slave SMI Status (SMLINK_SLV_SMI_STS) — R/WC. Allow the software to go directly into pre-determined sleep state. This avoids race conditions. Software clears this bit by writing a 1 to it. 0 = The bit is reset by RSMRST#, but not due to the PCI Reset associated with exit from S3–S5 states. 1 = ICH10 sets this bit to 1 when it receives the SMI message on the SMLink's Slave Interface. |
| 3 | Reserved. |
| 2 | BOOT_STS — R/WC. 0 = Cleared by ICH10 based on RSMRST# or by software writing a 1 to this bit. Note that software should first clear the SECOND_TO_STS bit before writing a 1 to clear the BOOT_STS bit. 1 = Set to 1 when the SECOND_TO_STS bit goes from 0 to 1 and the processor has not fetched the first instruction. If rebooting due to a second TCO timer timeout, and if the BOOT_STS bit is set, the ICH10 will reboot using the 'safe' multiplier (1111). This allows the system to recover from a processor frequency multiplier that is too high, and allows the BIOS to check the BOOT_STS bit at boot. If the bit is set and the frequency multiplier is 1111, then the BIOS knows that the processor has been programmed to an invalid multiplier. |
| 1 | SECOND_TO_STS — R/WC. 0 = Software clears this bit by writing a 1 to it, or by a RSMRST#. 1 = ICH10 sets this bit to 1 to indicate that the TIMEOUT bit had been (or is currently) set and a second timeout occurred before the TCO_RLD register was written. If this bit is set and the NO_REBOOT config bit is 0, then the ICH10 will reboot the system after the second timeout. The reboot is done by asserting PLTRST#. |



| Bit | Description |
|-----|------------------------------------------------------------------------------------------------------------------------------------------------------------------------------------------------------------------------------------------------------------------------------------------------------------------------------------------------------------------------------------------------------------------------------------------------------------------------------------------------------------------------------------------------------------------------------------------------------------------------------------------------------------------------------------------------------------------------------------------------------------------------------------------------------------------------------------------------------------------------------------------------------------------------------------------------------------------------------------------------------------------------------------------------------------------------------------------------------------------------------------------------------------------------------------------------------------------------------------------------------------------------------------------------------------------------------------------------------------------------------------------------------------------------------------------------------------------------------------------|
| 0 | <p>Intruder Detect (INTRD_DET) — R/WC.</p> <p>0 = Software clears this bit by writing a 1 to it, or by RTCRST# assertion. 1 = Set by ICH10 to indicate that an intrusion was detected. This bit is set even if the system is in G3 state.</p> <p>NOTES:</p> <ol style="list-style-type: none"> 1. This bit has a recovery time. After writing a 1 to this bit position (to clear it), the bit may be read back as a 1 for up to 65 microseconds before it is read as a 0. Software must be aware of this recovery time when reading this bit after clearing it. 2. If the INTRUDER# signal is active when the software attempts to clear the INTRD_DET bit, the bit will remain as a 1, and the SMI# will be generated again immediately. The SMI handler can clear the INTRD_SEL bits (TCOBASE + 0Ah, bits 2:1), to avoid further SMIs. However, if the INTRUDER# signal goes inactive and then active again, there will not be further SMIs (because the INTRD_SEL bits would select that no SMI# be generated). 3. If the INTRUDER# signal goes inactive some point after the INTRD_DET bit is written as a 1, then the INTRD_DET signal will go to a 0 when the INTRUDER# input signal goes inactive. Note that this is slightly different than a classic sticky bit, since most sticky bits would remain active indefinitely when the signal goes active and would immediately go inactive when a 1 is written to the |



13.9.6 TCO1_CNT—TCO1 Control Register

I/O Address: TCOBASE +08h Attribute: R/W, R/WLO, R/WC
 Default Value: 0000h Size: 16-bit
 Lockable: No Power Well: Core

| Bit | Description | | | | | | | | | | | | | | | |
|--------|------------------------------------------------------------------------------------------------------------------------------------------------------------------------------------------------------------------------------------------------------------------------------------------------------------------------------------------------------------------------------------------------------------------------------------------------------------------------------------------------------------------------------------------------------------------------------------------------------------------------------------------------------------------------------------------------------------------------------------|---------------------------------------|------------|-------------|----|----|---------------------------------------|----|----|---------------------------------------|----|----|---------------------------------------|----|----|---------------------------------------|
| 15:13 | Reserved | | | | | | | | | | | | | | | |
| 12 | TCO_LOCK — R/WLO. When set to 1, this bit prevents writes from changing the TCO_EN bit (in offset 30h of Power Management I/O space). Once this bit is set to 1, it can not be cleared by software writing a 0 to this bit location. A core-well reset is required to change this bit from 1 to 0. This bit defaults to 0. | | | | | | | | | | | | | | | |
| 11 | TCO Timer Halt (TCO_TMR_HLT) — R/W. 0 = The TCO Timer is enabled to count. 1 = The TCO Timer will halt. It will not count, and thus cannot reach a value that will cause an SMI# or set the SECOND_TO_STS bit. When set, this bit will prevent rebooting and prevent Alert On LAN event messages from being transmitted on the SMLINK (but not Alert On LAN* heartbeat messages). | | | | | | | | | | | | | | | |
| 10 | Reserved | | | | | | | | | | | | | | | |
| 9 | NMI2SMI_EN — R/W. 0 = Normal NMI functionality. 1 = Forces all NMIs to instead cause SMIs. The functionality of this bit is dependent upon the settings of the NMI_EN bit and the GBL_SMI_EN bit as detailed in the following table: <table border="1"> <thead> <tr> <th>NMI_EN</th> <th>GBL_SMI_EN</th> <th>Description</th> </tr> </thead> <tbody> <tr> <td>0b</td> <td>0b</td> <td>No SMI# at all because GBL_SMI_EN = 0</td> </tr> <tr> <td>0b</td> <td>1b</td> <td>SMI# will be caused due to NMI events</td> </tr> <tr> <td>1b</td> <td>0b</td> <td>No SMI# at all because GBL_SMI_EN = 0</td> </tr> <tr> <td>1b</td> <td>1b</td> <td>No SMI# due to NMI because NMI_EN = 1</td> </tr> </tbody> </table> | NMI_EN | GBL_SMI_EN | Description | 0b | 0b | No SMI# at all because GBL_SMI_EN = 0 | 0b | 1b | SMI# will be caused due to NMI events | 1b | 0b | No SMI# at all because GBL_SMI_EN = 0 | 1b | 1b | No SMI# due to NMI because NMI_EN = 1 |
| NMI_EN | GBL_SMI_EN | Description | | | | | | | | | | | | | | |
| 0b | 0b | No SMI# at all because GBL_SMI_EN = 0 | | | | | | | | | | | | | | |
| 0b | 1b | SMI# will be caused due to NMI events | | | | | | | | | | | | | | |
| 1b | 0b | No SMI# at all because GBL_SMI_EN = 0 | | | | | | | | | | | | | | |
| 1b | 1b | No SMI# due to NMI because NMI_EN = 1 | | | | | | | | | | | | | | |
| 8 | NMI_NOW — R/WC. 0 = Software clears this bit by writing a 1 to it. The NMI handler is expected to clear this bit. Another NMI will not be generated until the bit is cleared. 1 = Writing a 1 to this bit causes an NMI. This allows the BIOS or SMI handler to force an entry to the NMI handler. | | | | | | | | | | | | | | | |
| 7:0 | Reserved | | | | | | | | | | | | | | | |



13.9.7 TCO2_CNT—TCO2 Control Register

I/O Address: TCOBASE +0Ah Attribute: R/W
 Default Value: 0008h Size: 16-bit
 Lockable: No Power Well: Resume

| Bit | Description |
|------|----------------------------------------------------------------------------------------------------------------------------------------------------------------------------------------------------------------------------------------------------------------------------------------------------------------------------------------------------------------------------------------------------------------------------------------------------------------------------------------------------------------------------------------------------|
| 15:6 | Reserved |
| 5:4 | <p>OS_POLICY — R/W. OS-based software writes to these bits to select the policy that the BIOS will use after the platform resets due the WDT. The following convention is recommended for the BIOS and OS:</p> <p>00 = Boot normally 01 = Shut down 10 = Don't load OS. Hold in pre-boot state and use LAN to determine next step 11 = Reserved</p> <p>NOTE: These are just scratchpad bits. They should not be reset when the TCO logic resets the platform due to Watchdog Timer.</p> |
| 3 | <p>GPIO11_ALERT_DISABLE — R/W. At reset (via RSMRST# asserted) this bit is set and GPIO[11] alerts are disabled.</p> <p>0 = Enable. 1 = Disable GPIO11/SMBALERT# as an alert source for the heartbeats and the SMBus slave.</p> |
| 2:1 | <p>INTRD_SEL — R/W. This field selects the action to take if the INTRUDER# signal goes active.</p> <p>00 = No interrupt or SMI# 01 = Interrupt (as selected by TCO_INT_SEL). 10 = SMI 11 = Reserved</p> |
| 0 | Reserved |

13.9.8 TCO_MESSAGE1 and TCO_MESSAGE2 Registers

I/O Address: TCOBASE +0Ch (Message 1) Attribute: R/W
 TCOBASE +0Dh (Message 2)
 Default Value: 00h Size: 8-bit
 Lockable: No Power Well: Resume

| Bit | Description |
|-----|-------------------------------------------------------------------------------------------------------------------------------------------------------------------------------------------|
| 7:0 | <p>TCO_MESSAGE[n] — R/W. BIOS can write into these registers to indicate its boot progress. The external microcontroller can read these registers to monitor the boot progress</p> |



13.9.9 TCO_WDCNT—TCO Watchdog Control Register

Offset Address: TCOBASE + 0Eh Attribute: R/W
Default Value: 00h Size: 8 bits
Power Well: Resume

| Bit | Description |
|-----|-----------------------------------------------------------------------------------------------------------------------------------------------------------------------------------------------------------------------------------------------------------------------|
| 7:0 | The BIOS or system management software can write into this register to indicate more details on the boot progress. The register will reset to 00h based on a RSMRST# (but not PLTRST#). The external microcontroller can read this register to monitor boot progress. |

13.9.10 SW_IRQ_GEN—Software IRQ Generation Register

Offset Address: TCOBASE + 10h Attribute: R/W
Default Value: 03h Size: 8 bits
Power Well: Core

| Bit | Description |
|-----|-------------------------------------------------------------------------------------------------------------------------------------------------|
| 7:2 | Reserved |
| 1 | IRQ12_CAUSE — R/W. When software sets this bit to 1, IRQ12 will be asserted. When software sets this bit to 0, IRQ12 will be deasserted. |
| 0 | IRQ1_CAUSE — R/W. When software sets this bit to 1, IRQ1 will be asserted. When software sets this bit to 0, IRQ1 will be deasserted. |

13.9.11 TCO_TMR—TCO Timer Initial Value Register

I/O Address: TCOBASE + 12h Attribute: R/W
Default Value: 0004h Size: 16-bit
Lockable: No Power Well: Core

| Bit | Description |
|-------|------------------------------------------------------------------------------------------------------------------------------------------------------------------------------------------------------------------------------------------------------------------------------------------------------------------------------------------------------------------------------------------------------------------------------|
| 15:10 | Reserved |
| 9:0 | TCO Timer Initial Value — R/W. Value that is loaded into the timer each time the TCO_RLD register is written. Values of 0000h or 0001h will be ignored and should not be attempted. The timer is clocked at approximately 0.6 seconds, and thus allows timeouts ranging from 1.2 second to 613.8 seconds. Note: The timer has an error of ± 1 tick (0.6s). The TCO Timer will only count down in the S0 state. |



13.10 General Purpose I/O Registers (D31:F0)

The control for the general purpose I/O signals is handled through a separate 64-byte I/O space (consumer Only) and 128-byte I/O space (Corporate Only). The base offset for this space is selected by the GPIOBASE register.

Table 13-13. Registers to Control GPIO Address Map

| GPIOBASE + Offset | Mnemonic | Register Name | Default | Access |
|-----------------------------|---------------|----------------------------------|-----------|--------|
| 00h–03h | GPIO_USE_SEL | GPIO Use Select | 197F75FFh | R/W |
| 04h–07h | GP_IO_SEL | GPIO Input/Output Select | E0EA6FFFh | R/W |
| 08h–0Bh | — | Reserved | — | — |
| 0Ch–0Fh | GP_LVL | GPIO Level for Input or Output | E2FEEFFFh | R/W |
| 10h–13h | — | Reserved | — | — |
| 14h–17h | — | Reserved | — | — |
| 18h–1Bh | GPO_BLINK | GPIO Blink Enable | 00040000h | R/W |
| 1Ch–1Fh | GP_SER_BLINK | GP Serial Blink | 00000000h | R/W |
| 20–23h | GP_SB_CMDSTS | GP Serial Blink Command Status | 00080000h | R/W |
| 24–27h | GP_SB_DATA | GP Serial Blink Data | 00000000h | R/W |
| 28–2Bh | — | Reserved | — | — |
| 2C–2Fh | GPI_INV | GPIO Signal Invert | 00000000h | R/W |
| 30h–33h | GPIO_USE_SEL2 | GPIO Use Select 2 | 070300FFh | R/W |
| 34h–37h | GP_IO_SEL2 | GPIO Input/Output Select 2 | 1B55FFF0h | R/W |
| 38h–3Bh | GP_LVL2 | GPIO Level for Input or Output 2 | 1FFEFFF3h | R/W |
| 3Ch–3Fh | — | Reserved | — | — |
| 40h–43h (Corporate Only) | GPIO_USE_SEL3 | GPIO Use Select 3 | | R/W |
| 44h–47h (Corporate Only) | GPIO_SEL3 | GPIO Input/Output Select 3 | | R/W |
| 48h–4Bh (Corporate Only) | GP_LVL3 | GPIO Level for Input or Output 3 | | R/W |
| 4Ch–5Fh (Corporate Only) | — | Reserved | — | — |
| 60h–63h | GP_RST_SEL | GPIO Reset Select | | R/W |
| 64h–7Fh (Corporate Only) | — | Reserved | — | — |



13.10.1 GPIO_USE_SEL—GPIO Use Select Register

| | | | |
|-----------------|----------------|-------------|------------------------------------------------|
| Offset Address: | GPIOBASE + 00h | Attribute: | R/W |
| Default Value: | 197F75FFh | Size: | 32-bit |
| Lockable: | Yes | Power Well: | Core for 0:7, 16:23, Resume for 8:15, 24:31 |

| Bit | Description |
|------|-----------------------------------------------------------------------------------------------------------------------------------------------------------------------------------------------------------------------------------------------------------------------------------------------------------------------------------------------------------------------------------------------------------------------------------------------------------------------------------------------------------------------------------------------------------------------------------------------------------------------------------------------------------------------------------------------------------------------------------------------------------------------------------------------------------------------------------------------------------------------------------------------------------------------------------------------------------------------------------------------------------------------------------------------------------------------------------------------|
| 31:0 | <p>GPIO_USE_SEL[31:0] — R/W. Each bit in this register enables the corresponding GPIO (if it exists) to be used as a GPIO, rather than for the native function.</p> <p>0 = Signal used as native function. 1 = Signal used as a GPIO.</p> <p>NOTES:</p> <ol style="list-style-type: none"> The following bits are always 1 because they are always unMultiplexed: 8, 12, 13, 17, 18, 20, 27 and 28. If GPIO[n] does not exist, then, the n-bit in this register will always read as 0 and writes will have no effect. After a full reset (RSMRST#) all multiplexed signals in the resume and core wells are configured as their default function. After only a PLTRST#, the GPIOs in the core well are configured as their default function. When configured to GPIO mode, the muxing logic will present the inactive state to native logic that uses the pin as an input. All GPIOs are reset to the default state by CF9h reset except GPIO24. Bit 26 may be overridden by bit 8 in the GEN_PMCON_3 Register. |

13.10.2 GP_IO_SEL—GPIO Input/Output Select Register

| | | | |
|-----------------|---------------|-------------|------------------------------------------------|
| Offset Address: | GPIOBASE +04h | Attribute: | R/W |
| Default Value: | E0EA6FFFh | Size: | 32-bit |
| Lockable: | Yes | Power Well: | Core for 0:7, 16:23, Resume for 8:15, 24:31 |

| Bit | Description |
|------|---------------------------------------------------------------------------------------------------------------------------------------------------------------------------------------------------------------------------------------------------------------------------------------------------------------------------------------------------|
| 31:0 | <p>GP_IO_SEL[31:0] — R/W.</p> <p>When configured in native mode (GPIO_USE_SEL[n] is 0), writes to these bits have no effect. The value reported in this register is undefined when programmed as native mode.</p> <p>0 = Output. The corresponding GPIO signal is an output. 1 = Input. The corresponding GPIO signal is an input.</p> |



13.10.3 GP_LVL—GPIO Level for Input or Output Register

| | | | |
|-----------------|----------------|-------------|----------------------------------------------------|
| Offset Address: | GPIOBASE + 0Ch | Attribute: | R/W |
| Default Value: | E2FEEFFFh | Size: | 32-bit |
| Lockable: | Yes | Power Well: | Core for 0: 7, 16: 23, Resume for 8: 15, 24: 31 |

| Bit | Description |
|------|-------------------------------------------------------------------------------------------------------------------------------------------------------------------------------------------------------------------------------------------------------------------------------------------------------------------------------------------------------------------------------------------------------------------------------------------------------------------------------------------------------------------------------------------------------------------------------------------------------------------------------------------|
| 31:0 | <p>GP_LVL[31:0]— R/W.</p> <p>If GPIO[n] is programmed to be an output (via the corresponding bit in the GP_IO_SEL register), then the corresponding GP_LVL[n] bit can be updated by software to drive a high or low value on the output pin. 1 = high, 0 = low.</p> <p>If GPIO[n] is programmed as an input, then the corresponding GP_LVL bit reflects the state of the input signal (1 = high, 0 = low.) and writes will have no effect.</p> <p>When configured in native mode (GPIO_USE_SEL[n] is 0), writes to these bits have no effect. The value reported in this register is undefined when programmed as native mode.</p> |

13.10.4 GPO_BLINK—GPO Blink Enable Register

| | | | |
|-----------------|----------------|-------------|----------------------------------------------------|
| Offset Address: | GPIOBASE + 18h | Attribute: | R/W |
| Default Value: | 00040000h | Size: | 32-bit |
| Lockable: | No | Power Well: | Core for 0: 7, 16: 23, Resume for 8: 15, 24: 31 |

| Bit | Description |
|------|----------------------------------------------------------------------------------------------------------------------------------------------------------------------------------------------------------------------------------------------------------------------------------------------------------------------------------------------------------------------------------------------------------------------------------------------------------------------------------------------------------------------------------------------------------------------------------------------------------------------------------------------------------------------------------------------------------------------------------------------------------------------------------------------------------------------------------------------------------------------------|
| 31:0 | <p>GP_BLINK[31:0] — R/W. The setting of this bit has no effect if the corresponding GPIO signal is programmed as an input.</p> <p>0 = The corresponding GPIO will function normally.</p> <p>1 = If the corresponding GPIO is programmed as an output, the output signal will blink at a rate of approximately once per second. The high and low times have approximately 0.5 seconds each. The GP_LVL bit is not altered when this bit is set.</p> <p>The value of the corresponding GP_LVL bit remains unchanged during the blink process, and does not effect the blink in any way. The GP_LVL bit is not altered when programmed to blink. It will remain at its previous value.</p> <p>These bits correspond to GPIO in the Resume well. These bits revert to the default value based on RSMRST# or a write to the CF9h register (but not just on PLTRST#).</p> |

NOTE: GPIO18 will blink by default immediately after reset. This signal could be connected to an LED to indicate a failed boot (by programming BIOS to clear GP_BLINK18 after successful POST).



13.10.5 GP_SER_BLINK—GP Serial Blink

| | | | |
|-----------------|---------------|-------------|----------------------------------------------------|
| Offset Address: | GPIOBASE +1Ch | Attribute: | R/W |
| Default Value: | 00000000h | Size: | 32-bit |
| Lockable: | No | Power Well: | Core for 0: 7, 16: 23, Resume for 8: 15, 24: 31 |

| Bit | Description |
|------|----------------------------------------------------------------------------------------------------------------------------------------------------------------------------------------------------------------------------------------------------------------------------------------------------------------------------------------------------------------------------------------------------------------------------------------------------------------------------------------------------------------------------------------------------------------------------------------------------------------------------------------------------------------------------------------------------------------------------------------------------------------------------------------------------------------------------------------------------------------------------------------------------------------------------------------------------------------------------------------------|
| 31:0 | <p>GP_SER_BLINK[31:0] — R/W. The setting of this bit has no effect if the corresponding GPIO is programmed as an input or if the corresponding GPIO has the GPO_BLINK bit set.</p> <p>When set to a '0', the corresponding GPIO will function normally.</p> <p>When using serial blink, this bit should be set to a 1 while the corresponding GP_IO_SEL bit is set to 1. Setting the GP_IO_SEL bit to 0 after the GP_SER_BLINK bit ensures ICH will not drive a 1 on the pin as an output. When this corresponding bit is set to a 1 and the pin is configured to output mode, the serial blink capability is enabled. The ICH will serialize messages through an open-drain buffer configuration.</p> <p>The value of the corresponding GP_LVL bit remains unchanged and does not impact the serial blink capability in any way.</p> <p>Writes to this register have no effect when the corresponding pin is configured in native mode and the read value returned is undefined.</p> |



13.10.6 GP_SB_CMDSTS—GP Serial Blink Command Status

Offset Address: GPIOBASE +20h Attribute: R/W, RO
 Default Value: 00000800h Size: 32-bit
 Lockable: No Power Well: Core

| Bit | Description |
|-------|-----------------------------------------------------------------------------------------------------------------------------------------------------------------------------------------------------------------------------------------------------------------------------------------------------------------------------------------------------------------------------------------------------------------------------------------------------------------------------------------------------------------------------------------------------------------------------------------------------------|
| 31:24 | Reserved |
| 23:22 | <p>Data Length Select (DLS) — R/W. This field determines the number of bytes to serialize on GPIO</p> <p>00 = Serialize bits 7:0 of GP_SB_DATA (1 byte) 01 = Serialize bits 15:0 of GP_SB_DATA (2 bytes) 10 = Undefined - Software must not write this value 11 = Serialize bits 31:0 of GP_SB_DATA (4 bytes)</p> <p>Software should not modify the value in this register unless the Busy bit is clear. Writes to this register have no effect when the corresponding pin is configured in native mode and the read value returned is undefined.</p> |
| 21:16 | <p>Data Rate Select (DRS) — R/W. This field selects the number of 120ns time intervals to count between Manchester data transitions. The default of 8h results in a 960ns minimum time between transitions. A value of 0h in this register produces undefined behavior.</p> <p>Software should not modify the value in this register unless the Busy bit is clear.</p> |
| 15:9 | Reserved |
| 8 | <p>Busy — RO. This read-only status bit is the hardware indication that a serialization is in progress. Hardware sets this bit to 1 based on the Go bit being set. Hardware clears this bit when the Go bit is cleared by the hardware.</p> |
| 7:1 | Reserved |
| 0 | <p>Go — R/W. This bit is set to 1 by software to start the serialization process. Hardware clears the bit after the serialized data is sent. Writes of 0 to this register have no effect. Software should not write this bit to 1 unless the Busy status bit is cleared.</p> |

13.10.7 GP_SB_DATA—GP Serial Blink Data

Offset Address: GPIOBASE +24h Attribute: R/W
 Default Value: 00000000h Size: 32-bit
 Lockable: No Power Well: Core

| Bit | Description |
|------|------------------------------------------------------------------------------------------------------------------------------------------------------------------------------------------------------------------------------------------------------------------|
| 31:0 | <p>GP_SB_DATA[31:0] — R/W. This register contains the data serialized out. The number of bits shifted out are selected through the DLS field in the GP_SB_CMDSTS register. This register should not be modified by software when the Busy bit is set.</p> |



13.10.8 GPI_INV—GPIO Signal Invert Register

Offset Address: GPIOBASE +2Ch Attribute: R/W
Default Value: 00000000h Size: 32-bit
Lockable: No Power Well: CPU I/O for 17, Core for 16, 7:0

| Bit | Description |
|------|---------------------------------------------------------------------------------------------------------------------------------------------------------------------------------------------------------------------------------------------------------------------------------------------------------------------------------------------------------------------------------------------------------------------------------------------------------------------------------------------------------------------------------------------------------------------------------------------------------------------------------------------------------------------------------------------------------------------------------------------------------------------------------------------------------------------------------------------------------------------------------------------------------------------------------------------------------------------------------------------------------------------------------------------------------------------------------------------------------------------------------------------------------------------------|
| 31:0 | <p>Input Inversion (GP_INV[n]) — R/W. This bit only has effect if the corresponding GPIO is used as an input and used by the GPE logic, where the polarity matters. When set to '1', then the GPI is inverted as it is sent to the GPE logic that is using it. This bit has no effect on the value that is reported in the GP_LVL register.</p> <p>These bits are used to allow both active-low and active-high inputs to cause SMI# or SCI. Note that in the S0 or S1 state, the input signal must be active for at least two PCI clocks to ensure detection by the ICH10. In the S3, S4 or S5 states the input signal must be active for at least 2 RTC clocks to ensure detection. The setting of these bits has no effect if the corresponding GPIO is programmed as an output. These bits correspond to GPI that are in the resume well, and will be reset to their default values by RSMRST# or by a write to the CF9h register.</p> <p>0 = The corresponding GPI_STS bit is set when the ICH10 detects the state of the input pin to be high. 1 = The corresponding GPI_STS bit is set when the ICH10 detects the state of the input pin to be low.</p> |



13.10.9 GPIO_USE_SEL2—GPIO Use Select 2 Register

| | | | |
|-----------------|----------------------------------------------------|-------------|---------------------------------------------------|
| Offset Address: | GPIOBASE +30h | Attribute: | R/W |
| Default Value: | 070300FFh (Consumer Only) TBDh (Corporate Only) | Size: | 32-bit |
| Lockable: | Yes | Power Well: | Core for 0: 7, 16:23, Resume for 8: 15, 24: 31 |

| Bit | Description |
|---------------------------|----------------------------------------------------------------------------------------------------------------------------------------------------------------------------------------------------------------------------------------------------------------------------------------------------------------------------------------------------------------------------------------------------------------------------------------------------------------------------------------------------------------------------------------------------------------------------------------------------------------------------------------------------------------------------------------------------------------------------------------------------------------------------------------------------------------------------------------------------------------------------------------------------------------------------------------------------------------------------------------------------------------------------------------------------------------------------------------------------------------------------------------------------------------------------------------------------------------------------------------------------|
| 31:0 Corporate Only | <p>GPIO_USE_SEL2[63:32]— R/W. Each bit in this register enables the corresponding GPIO (if it exists) to be used as a GPIO, rather than for the native function.</p> <p>0 = Signal used as native function. 1 = Signal used as a GPIO.</p> <p>NOTES:</p> <ol style="list-style-type: none"> The following bit is always 1 because it is always unMultiplexed: 17. The following bits are unMultiplexed in desktop and are also 1: 0, 1, 2, 24 and 26. If GPIO[n] does not exist, then, the (n-32) bit in this register will always read as 0 and writes will have no effect. The following bits are always 0: 29, 30 and 31. After a full reset RSMRST# all multiplexed signals in the resume and core wells are configured as their default function. After only a PLTRST#, the GPIOs in the core well are configured as their default function. When configured to GPIO mode, the muxing logic will present the inactive state to native logic that uses the pin as an input. Bit 26 is ignored, functionality is configured by bits 9:8 of FLMAPO register. <p>This register corresponds to GPIO[63:32]. Bit 0 corresponds to GPIO32 and bit 28 corresponds to GPIO60.</p> |
| 31:29 Consumer Only | Always 0. No corresponding GPIO. |
| 28:0 Consumer Only | <p>GPIO_USE_SEL2[63:32]— R/W. Each bit in this register enables the corresponding GPIO (if it exists) to be used as a GPIO, rather than for the native function.</p> <p>0 = Signal used as native function. 1 = Signal used as a GPIO.</p> <p>NOTES:</p> <ol style="list-style-type: none"> The following bit is always 1 because it is always unMultiplexed: 17. The following bits are unMultiplexed in desktop and are also 1: 0, 1, 2, 24 and 26. If GPIO[n] does not exist, then, the (n-32) bit in this register will always read as 0 and writes will have no effect. The following bits are always 0: 29, 30 and 31. After a full reset RSMRST# all multiplexed signals in the resume and core wells are configured as their default function. After only a PLTRST#, the GPIOs in the core well are configured as their default function. When configured to GPIO mode, the muxing logic will present the inactive state to native logic that uses the pin as an input. Bit 26 is ignored, functionality is configured by bits 9:8 of FLMAPO register. <p>This register corresponds to GPIO[63:32]. Bit 0 corresponds to GPIO32 and bit 28 corresponds to GPIO60.</p> |



13.10.10 GP_IO_SEL2—GPIO Input/Output Select 2 Register

Offset Address: GPIOBASE +34h Attribute: R/W
 Default Value: 1B55FFF0h (Consumer Only) Size: 32-bit
 TBDh (Corporate Only)
 Lockable: Yes Power Well: Core for 0:7, 16:23,
 Resume for 8:15, 24:31

| Bit | Description |
|------------------------|-----------------------------------------------------------------------------------------------------------------------------------------------------------------------------------------------------------------------------------------------------------------|
| 31:0 Corporate Only | GP_IO_SEL2[63:32] — R/W. 0 = GPIO signal is programmed as an output. 1 = Corresponding GPIO signal (if enabled in the GPIO_USE_SEL2 register) is programmed as an input. This register corresponds to GPIO[63:32]. Bit 0 corresponds to GPIO32. |
| 31:29 Consumer Only | Always 0. No corresponding GPIO. |
| 28:0 Consumer Only | GP_IO_SEL2[63:32] — R/W. 0 = GPIO signal is programmed as an output. 1 = Corresponding GPIO signal (if enabled in the GPIO_USE_SEL2 register) is programmed as an input. This register corresponds to GPIO[63:32]. Bit 0 corresponds to GPIO32. |

13.10.11 GP_LVL2—GPIO Level for Input or Output 2 Register

Offset Address: GPIOBASE +38h Attribute: R/W
 Default Value: 1FFEFFF3h (Consumer Only) Size: 32-bit
 TBDh (Corporate Only)
 Lockable: Yes Power Well: Core for 0:7, 16:23,
 Resume for 8:15, 24:31

| Bit | Description |
|------------------------|----------------------------------------------------------------------------------------------------------------------------------------------------------------------------------------------------------------------------------------------------------------------------------------------------------------------------------------------------------------------------------------------------------------------------------------------------------------------------------------------------------------------------------------------------------------------------------------------------------------------------------------------------------------------------------------------------|
| 31:0 Corporate Only | GP_LVL[63:32] — R/W. If GPIO[n] is programmed to be an output (via the corresponding bit in the GP_IO_SEL register), then the corresponding GP_LVL[n] bit can be updated by software to drive a high or low value on the output pin. 1 = high, 0 = low. If GPIO[n] is programmed as an input, then the corresponding GP_LVL bit reflects the state of the input signal (1 = high, 0 = low.) and writes will have no effect. When configured in native mode (GPIO_USE_SEL[n] is 0), writes to these bits have no effect. The value reported in this register is undefined when programmed as native mode. This register corresponds to GPIO[63:32]. Bit 0 corresponds to GPIO32. |
| 31:29 Consumer Only | Reserved. Read-only 0 |
| 28:0 Consumer Only | GP_LVL[63:32] — R/W. If GPIO[n] is programmed to be an output (via the corresponding bit in the GP_IO_SEL register), then the corresponding GP_LVL[n] bit can be updated by software to drive a high or low value on the output pin. 1 = high, 0 = low. If GPIO[n] is programmed as an input, then the corresponding GP_LVL bit reflects the state of the input signal (1 = high, 0 = low.) and writes will have no effect. When configured in native mode (GPIO_USE_SEL[n] is 0), writes to these bits have no effect. The value reported in this register is undefined when programmed as native mode. This register corresponds to GPIO[63:32]. Bit 0 corresponds to GPIO32. |



13.10.12 GPIO_USE_SEL3—GPIO Use Select 3 Register (Corporate Only)

| | | | |
|-----------------|---------------|-------------|--------------------------------------------------|
| Offset Address: | GPIOBASE +40h | Attribute: | R/W |
| Default Value: | TBDh | Size: | 32-bit |
| Lockable: | Yes | Power Well: | Core for 0: 7, 16:23, Resume for 8: 15, 24:31 |

| Bit | Description |
|------|-----------------------------------------------------------------------------------------------------------------------------------------------------------------------------------------------------------------------------------------------------------------------------------------------------------------------------------------------------------------------------------------------------------------------------------------------------------------------------------------------------------------------------------------------------------------------------------------------------------------------------------------------------------------------------------------------------------------------------------------------------------------------------------------------------------------------------------------------------------------------------------------------------------------------------------------------|
| 31:9 | Always 0. No corresponding GPIO. |
| 8 | <p>GPIO_USE_SEL3[72]— R/W. Each bit in this register enables the corresponding GPIO (if it exists) to be used as a GPIO, rather than for the native function.</p> <p>0 = Signal used as native function. 1 = Signal used as a GPIO.</p> <p>NOTES:</p> <ol style="list-style-type: none"> 1. If GPIO[n] does not exist, then, the (n-32) bit in this register will always read as 0 and writes will have no effect. 2. After a full reset RSMRST# all multiplexed signals in the resume and core wells are configured as their default function. After only a PLTRST#, the GPIOs in the core well are configured as their default function. 3. When configured to GPIO mode, the muxing logic will present the inactive state to native logic that uses the pin as an input. <p>This register corresponds to GPIO[95:64]. Bit 0 corresponds to GPIO64 and bit 32 corresponds to GPIO95.</p> |
| 7:0 | Always 0. No corresponding GPIO. |

13.10.13 GP_IO_SEL3—GPIO Input/Output Select 3 Register (Corporate Only)

| | | | |
|-----------------|---------------|-------------|--------------------------------------------------|
| Offset Address: | GPIOBASE +44h | Attribute: | R/W |
| Default Value: | 00000x00h | Size: | 32-bit |
| Lockable: | Yes | Power Well: | Core for 0: 7, 16:23, Resume for 8: 15, 24:31 |

| Bit | Description |
|------|------------------------------------------------------------------------------------------------------------------------------------------------------------------------------------------------------------------------------------------------------------------------------|
| 31:9 | Always 0. No corresponding GPIO. |
| 8 | <p>GP_IO_SEL3[72] — R/W.</p> <p>0 = GPIO signal is programmed as an output. 1 = Corresponding GPIO signal (if enabled in the GPIO_USE_SEL3 register) is programmed as an input.</p> <p>This register corresponds to GPIO[95:64]. Bit 0 corresponds to GPIO64.</p> |
| 7:0 | Always 0. No corresponding GPIO. |

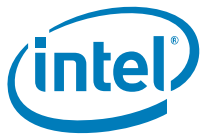

13.10.14 GP_LVL3—GPIO Level for Input or Output 3 Register (Corporate Only)

| | | | |
|-----------------|---------------|-------------|------------------------------------------------|
| Offset Address: | GPIOBASE +48h | Attribute: | R/W |
| Default Value: | 1FFEFF3h | Size: | 32-bit |
| Lockable: | Yes | Power Well: | Core for 0:7, 16:23, Resume for 8:15, 24:31 |

| Bit | Description |
|------|------------------------------------------------------------------------------------------------------------------------------------------------------------------------------------------------------------------------------------------------------------------------------------------------------------------------------------------------------------------------------------------------------------------------------------------------------------------------------------------------------------------------------------------------------------------------------------------------------------------------------------------------------------------------------------------------------------------------|
| 31:9 | Reserved. Read-only 0 |
| 8 | <p>GP_LVL[72] — R/W.</p> <p>If GPIO[n] is programmed to be an output (via the corresponding bit in the GP_IO_SEL register), then the corresponding GP_LVL[n] bit can be updated by software to drive a high or low value on the output pin. 1 = high, 0 = low.</p> <p>If GPIO[n] is programmed as an input, then the corresponding GP_LVL bit reflects the state of the input signal (1 = high, 0 = low.) and writes will have no effect.</p> <p>When configured in native mode (GPIO_USE_SEL[n] is 0), writes to these bits have no effect. The value reported in this register is undefined when programmed as native mode.</p> <p>This register corresponds to GPIO[95:64]. Bit 0 corresponds to GPIO64.</p> |
| 7:0 | Reserved. Read-only 0 |

13.10.15 GP_RST_SEL — GPIO Reset Select

| | | | |
|-----------------|---------------|-------------|------------------------------------------------|
| Offset Address: | GPIOBASE +60h | Attribute: | R/W |
| Default Value: | 00000000h | Size: | 32-bit |
| Lockable: | Yes | Power Well: | Core for 0:7, 16:23, Resume for 8:15, 24:31 |

| Bit | Description |
|-------|------------------------------------------------------------------------------------------------------------------------------------------------------------------------------------------------------------------------------------------------------------------------------------------------------------------------------------------------------------------------------------|
| 31:11 | Reserved |
| 10 | <p>GPIO_RST_SEL[31:00] - R/W.</p> <p>Corresponding registers will be reset by internal suspend well reset.</p> <p>Corresponding registers will be reset by RSMRST# pin only.</p> <p>NOTE: In ICH10, only the reset for GPIO10 is selectable between RSMRST# pin and internal resume well reset. All the GP_RST_SEL registers are only reset-able by RSMRST# pin.</p> |
| 9:0 | Reserved |

§ §



14 SATA Controller Registers (D31:F2)

14.1 PCI Configuration Registers (SATA–D31:F2)

Note: Address locations that are not shown should be treated as Reserved.

All of the SATA registers are in the core well. None of the registers can be locked.

Table 14-1. SATA Controller PCI Register Address Map (SATA–D31:F2) (Sheet 1 of 2)

| Offset | Mnemonic | Register Name | Default | Type |
|---------|---------------|-------------------------------------------------------|--------------------------|--------------------------|
| 00h–01h | VID | Vendor Identification | 8086h | RO |
| 02h–03h | DID | Device Identification | See register description | RO |
| 04h–05h | PCICMD | PCI Command | 0000h | R/W, RO |
| 06h–07h | PCISTS | PCI Status | 02B0h | R/WC, RO |
| 08h | RID | Revision Identification | See register description | RO |
| 09h | PI | Programming Interface | See register description | See register description |
| 0Ah | SCC | Sub Class Code | See register description | See register description |
| 0Bh | BCC | Base Class Code | 01h | RO |
| 0Dh | PMLT | Primary Master Latency Timer | 00h | RO |
| 0Eh | HTYPE | Header Type | 00h | RO |
| 10h–13h | PCMD_BAR | Primary Command Block Base Address | 00000001h | R/W, RO |
| 14h–17h | PCNL_BAR | Primary Control Block Base Address | 00000001h | R/W, RO |
| 18h–1Bh | SCMD_BAR | Secondary Command Block Base Address | 00000001h | R/W, RO |
| 1Ch–1Fh | SCNL_BAR | Secondary Control Block Base Address | 00000001h | R/W, RO |
| 20h–23h | BAR | Legacy Bus Master Base Address | 00000001h | R/W, RO |
| 24h–27h | ABAR / SIDPBA | AHCI Base Address / SATA Index Data Pair Base Address | See register description | See register description |
| 2Ch–2Dh | SVID | Subsystem Vendor Identification | 0000h | R/WO |
| 2Eh–2Fh | SID | Subsystem Identification | 0000h | R/WO |
| 34h | CAP | Capabilities Pointer | 80h | RO |
| 3Ch | INT_LN | Interrupt Line | 00h | R/W |
| 3Dh | INT_PN | Interrupt Pin | See register description | RO |
| 40h–41h | IDE_TIM | Primary IDE Timing Register | 0000h | R/W |

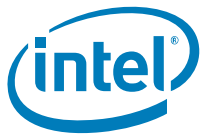

Table 14-1. SATA Controller PCI Register Address Map (SATA–D31:F2) (Sheet 2 of 2)

| Offset | Mnemonic | Register Name | Default | Type |
|---------|----------|--------------------------------------------|--------------------------|---------------|
| 42h–43h | IDE_TIM | Secondary IDE Timing Register | 0000h | R/W |
| 70h–71h | PID | PCI Power Management Capability ID | See register description | RO |
| 72h–73h | PC | PCI Power Management Capabilities | See register description | RO |
| 74h–75h | PMCS | PCI Power Management Control and Status | See register description | R/W, RO, R/WC |
| 80h–81h | MSICI | Message Signaled Interrupt Capability ID | 7005h | RO |
| 82h–83h | MSIMC | Message Signaled Interrupt Message Control | 0000h | RO, R/W |
| 84h–87h | MSIMA | Message Signaled Interrupt Message Address | 00000000h | RO, R/W |
| 88h–89h | MSIMD | Message Signaled Interrupt Message Data | 0000h | R/W |
| 90h | MAP | Address Map | 0000h | R/W |
| 92h–93h | PCS | Port Control and Status | 0000h | R/W, RO |
| 94h–97h | SCGC | SATA Clock Gating Control | 00000000h | R/W |
| 9Ch–9Fh | SCLKGC | SATA Clock General Configuration | 00000000h | R/W, R/WO |
| A8h–ABh | SCAP0 | SATA Capability Register 0 | 0010B012h | RO, R/WO |
| ACh–AFh | SCAP1 | SATA Capability Register 1 | 00000048h | RO |
| B0h–B1h | FLRCID | FLR Capability ID | 0009h | RO |
| B2h–B3h | FLRCLV | FLR Capability Length and Version | See register description | R/WO, RO |
| B4h–B5h | FLRCTRL | FLR Control | 0000h | RO, R/W |
| C0h | ATC | APM Trapping Control | 00h | R/W |
| C4h | ATS | ATM Trapping Status | 00h | R/WC |
| D0h–D3h | SP | Scratch Pad | 00000000h | R/W |
| E0h–E3h | BFCS | BIST FIS Control/Status | 00000000h | R/W, R/WC |
| E4h–E7h | BFTD1 | BIST FIS Transmit Data, DW1 | 00000000h | R/W |
| E8h–EBh | BFTD2 | BIST FIS Transmit Data, DW2 | 00000000h | R/W |

NOTE: The ICH10 SATA controller is not arbitrated as a PCI device, therefore it does not need a master latency timer.



14.1.1 VID—Vendor Identification Register (SATA—D31:F2)

| | | | |
|-----------------|---------|-------------|--------|
| Offset Address: | 00h–01h | Attribute: | RO |
| Default Value: | 8086h | Size: | 16 bit |
| Lockable: | No | Power Well: | Core |

| Bit | Description |
|------|------------------------------------------------------------------------------------|
| 15:0 | Vendor ID — RO. This is a 16-bit value assigned to Intel. Intel VID = 8086h |

14.1.2 DID—Device Identification Register (SATA—D31:F2)

| | | | |
|-----------------|---------------------|-------------|--------|
| Offset Address: | 02h–03h | Attribute: | RO |
| Default Value: | See bit description | Size: | 16 bit |
| Lockable: | No | Power Well: | Core |

| Bit | Description |
|------|-----------------------------------------------------------------------------------------------------------------------------------------------------------------------------------------------------------------------------------|
| 15:0 | Device ID — RO. This is a 16-bit value assigned to the Intel® ICH10 SATA controller. NOTE: The value of this field will change dependent upon the value of the MAP Register. See Section 14.1.30 |

14.1.3 PCICMD—PCI Command Register (SATA—D31:F2)

| | | | |
|-----------------|---------|------------|---------|
| Address Offset: | 04h–05h | Attribute: | RO, R/W |
| Default Value: | 0000h | Size: | 16 bits |

| Bit | Description |
|-------|------------------------------------------------------------------------------------------------------------------------------------------------------------------------------------------------------------------------------------------------------------------------|
| 15:11 | Reserved |
| 10 | Interrupt Disable — R/W. This disables pin-based INTx# interrupts. This bit has no effect on MSI operation. 0 = Internal INTx# messages are generated if there is an interrupt and MSI is not enabled. 1 = Internal INTx# messages will not be generated. |
| 9 | Fast Back to Back Enable (FBE) — RO. Reserved as 0. |
| 8 | SERR# Enable (SERR_EN) — RO. Reserved as 0. |
| 7 | Wait Cycle Control (WCC) — RO. Reserved as 0. |
| 6 | Parity Error Response (PER) — R/W. 0 = Disabled. SATA controller will not generate PERR# when a data parity error is detected. 1 = Enabled. SATA controller will generate PERR# when a data parity error is detected. |
| 5 | VGA Palette Snoop (VPS) — RO. Reserved as 0. |
| 4 | Postable Memory Write Enable (PMWE) — RO. Reserved as 0. |
| 3 | Special Cycle Enable (SCE) — RO. Reserved as 0. |
| 2 | Bus Master Enable (BME) — R/W. This bit controls the ICH10's ability to act as a PCI master for IDE Bus Master transfers. This bit does not impact the generation of completions for split transaction commands. |
| 1 | Memory Space Enable (MSE) — R/W / RO. Controls access to the SATA controller's target memory space (for AHCI). This bit is RO '0' when not in AHCI/RAID modes. |



| Bit | Description |
|-----|--------------------------------------------------------------------------------------------------------------------------------------------------------------------------------------------------------------------------------------------------------------------------------------------------------------------------------------------------------|
| 0 | I/O Space Enable (IOSE) — R/W. This bit controls access to the I/O space registers. 0 = Disables access to the Legacy or Native IDE ports (both Primary and Secondary) as well as the Bus Master I/O registers. 1 = Enable. Note that the Base Address register for the Bus Master registers should be programmed before this bit is set. |

14.1.4 PCISTS — PCI Status Register (SATA–D31:F2)

Address Offset: 06h–07h
Default Value: 02B0h

Attribute: R/WC, RO
Size: 16 bits

Note: For the writable bits, software must write a 1 to clear bits that are set. Writing a 0 to the bit has no effect.

| Bit | Description |
|------|---------------------------------------------------------------------------------------------------------------------------------------------------------------------------------------------------------------------------------------------------------------------------------------------------------------------------------------------------|
| 15 | Detected Parity Error (DPE) — R/WC. 0 = No parity error detected by SATA controller. 1 = SATA controller detects a parity error on its interface. |
| 14 | Signaled System Error (SSE) — RO. Reserved as 0. |
| 13 | Received Master Abort (RMA) — R/WC. 0 = Master abort Not generated. 1 = SATA controller, as a master, generated a master abort. |
| 12 | Reserved as 0 — RO. |
| 11 | Signaled Target Abort (STA) — RO. Reserved as 0. |
| 10:9 | DEVSEL# Timing Status (DEV_STS) — RO. 01 = Hardwired; Controls the device select time for the SATA controller's PCI interface. |
| 8 | Data Parity Error Detected (DPED) — R/WC. For ICH10, this bit can only be set on read completions received from the bus when there is a parity error. 1 = SATA controller, as a master, either detects a parity error or sees the parity error line asserted, and the parity error response bit (bit 6 of the command register) is set. |
| 7 | Fast Back to Back Capable (FB2BC) — RO. Reserved as 1. |
| 6 | User Definable Features (UDF) — RO. Reserved as 0. |
| 5 | 66MHz Capable (66MHZ_CAP) — RO. Reserved as 1. |
| 4 | Capabilities List (CAP_LIST) — RO. This bit indicates the presence of a capabilities list. The minimum requirement for the capabilities list must be PCI power management for the SATA controller. |
| 3 | Interrupt Status (INTS) — RO. Reflects the state of INTx# messages, IRQ14 or IRQ15. 0 = Interrupt is cleared (independent of the state of Interrupt Disable bit in the command register [offset 04h]). 1 = Interrupt is to be asserted |
| 2:0 | Reserved |



14.1.5 RID—Revision Identification Register (SATA—D31:F2)

Offset Address: 08h

Attribute: RO

| Bit | Description |
|-----|-----------------------------------------------------------------------------------------------------------------------------------------------|
| 7:0 | Revision ID — RO. Refer to the <i>Intel® I/O Controller Hub (ICH10) Specification Update</i> for the value of the Revision ID Register |

14.1.6 PI—Programming Interface Register (SATA—D31:F2)

14.1.6.1 When Sub Class Code Register (D31:F2:Offset 0Ah) = 01h

Address Offset: 09h

Attribute: R/W, RO

Default Value: See bit description

Size: 8 bits

| Bit | Description |
|-----|---------------------------------------------------------------------------------------------------------------------------------------------------------------------------------------------------------------------------------------------------------------------------------------------------------------------------------------------------------------------------------------------------------------------------------------------------------------------------------------------------------------------------------------------------------------------------------------------------------------------------------|
| 7 | This read-only bit is a 1 to indicate that the ICH10 supports bus master operation |
| 6:4 | Reserved. Will always return 0. |
| 3 | Secondary Mode Native Capable (SNC) — RO. 0 = Secondary controller only supports legacy mode. 1 = Secondary controller supports both legacy and native modes. When MAP.MV (D31:F2:Offset 90:bits 1:0) is any value other than 00b, this bit reports as a 0. When MAP.MV is 00b, this bit reports as a 1. |
| 2 | Secondary Mode Native Enable (SNE) — R/W. Determines the mode that the secondary channel is operating in. 0 = Secondary controller operating in legacy (compatibility) mode 1 = Secondary controller operating in native PCI mode. When MAP.MV (D31:F2:Offset 90:bits 1:0) is any value other than 00b, this bit is read-only (RO). When MAP.MV is 00b, this bit is read/write (R/W). If this bit is set by software, then the PNE bit (bit 0 of this register) must also be set by software. While in theory these bits can be programmed separately, such a configuration is not supported by hardware. |
| 1 | Primary Mode Native Capable (PNC) — RO. 0 = Primary controller only supports legacy mode. 1 = Primary controller supports both legacy and native modes. When MAP.MV (D31:F2:Offset 90:bits 1:0) is any value other than 00b, this bit reports as a 0. When MAP.MV is 00b, this bit reports as a 1 |
| 0 | Primary Mode Native Enable (PNE) — R/W. Determines the mode that the primary channel is operating in. 0 = Primary controller operating in legacy (compatibility) mode. 1 = Primary controller operating in native PCI mode. If this bit is set by software, then the SNE bit (bit 2 of this register) must also be set by software simultaneously. |



14.1.12 PCNL_BAR—Primary Control Block Base Address Register (SATA–D31:F2)

Address Offset: 14h–17h Attribute: R/W, RO
Default Value: 00000001h Size: 32 bits

| Bit | Description |
|-------|-----------------------------------------------------------------------------------------------------------------|
| 31:16 | Reserved |
| 15:2 | Base Address — R/W. This field provides the base address of the I/O space (4 consecutive I/O locations). |
| 1 | Reserved |
| 0 | Resource Type Indicator (RTE) — RO. Hardwired to 1 to indicate a request for I/O space. |

NOTE: This 4-byte I/O space is used in native mode for the Primary Controller's Command Block.

14.1.13 SCMD_BAR—Secondary Command Block Base Address Register (IDE D31:F1)

Address Offset: 18h–1Bh Attribute: R/W, RO
Default Value: 00000001h Size: 32 bits

| Bit | Description |
|-------|-----------------------------------------------------------------------------------------------------------------|
| 31:16 | Reserved |
| 15:3 | Base Address — R/W. This field provides the base address of the I/O space (8 consecutive I/O locations). |
| 2:1 | Reserved |
| 0 | Resource Type Indicator (RTE) — RO. Hardwired to 1 to indicate a request for I/O space. |

NOTE: This 4-byte I/O space is used in native mode for the Secondary Controller's Command Block.

14.1.14 SCNL_BAR—Secondary Control Block Base Address Register (IDE D31:F1)

Address Offset: 1Ch–1Fh Attribute: R/W, RO
Default Value: 00000001h Size: 32 bits

| Bit | Description |
|-------|-----------------------------------------------------------------------------------------------------------------|
| 31:16 | Reserved |
| 15:2 | Base Address — R/W. This field provides the base address of the I/O space (4 consecutive I/O locations). |
| 1 | Reserved |
| 0 | Resource Type Indicator (RTE) — RO. Hardwired to 1 to indicate a request for I/O space. |

NOTE: This 4-byte I/O space is used in native mode for the Secondary Controller's Command Block.



14.1.15 BAR — Legacy Bus Master Base Address Register (SATA–D31:F2)

Address Offset: 20h–23h Attribute: R/W, RO
 Default Value: 00000001h Size: 32 bits

The Bus Master IDE interface function uses Base Address register 5 to request a 16-byte IO space to provide a software interface to the Bus Master functions. Only 12 bytes are actually used (6 bytes for primary, 6 bytes for secondary). Only bits [15:4] are used to decode the address.

| Bit | Description |
|-------|------------------------------------------------------------------------------------------------------------------------------------------------------------------------------------------------------|
| 31:16 | Reserved |
| 15:5 | Base Address — R/W. This field provides the base address of the I/O space (16 consecutive I/O locations). |
| 4 | Base — R/W / RO. When SCC is 01h, this bit will be R/W resulting in requesting 16B of I/O space. When SCC is not 01h, this bit will be Read Only 0, resulting in requesting 32B of I/O space. |
| 3:1 | Reserved |
| 0 | Resource Type Indicator (RTE) — RO. Hardwired to 1 to indicate a request for I/O space. |

14.1.16 ABAR/SIDPBA1 — AHCI Base Address Register/Serial ATA Index Data Pair Base Address (SATA–D31:F2)

When the programming interface is not IDE (i.e. SCC is not 01h), this register is named ABAR. When the programming interface is IDE, this register becomes SIDPBA.

Note that hardware does not clear those BA bits when switching from IDE component to non-IDE component or vice versa. BIOS is responsible for clearing those bits to 0 since the number of writable bits changes after component switching (as indicated by a change in SCC). In the case, this register will then have to be re-programmed to a proper value.

14.1.16.1 When SCC is not 01h

When the programming interface is not IDE, the register represents a memory BAR allocating space for the AHCI memory registers defined in [Section 14.4](#).

Address Offset: 24-27h Attribute: R/W, RO
 Default Value: 00000000h Size: 32 bits

| Bit | Description |
|-------|------------------------------------------------------------------------------------------------------------|
| 31:11 | Base Address (BA) — R/W. Base address of register memory space (aligned to 1 KB) |
| 10:4 | Reserved |
| 3 | Prefetchable (PF) — RO. Indicates that this range is not pre-fetchable |
| 2:1 | Type (TP) — RO. Indicates that this range can be mapped anywhere in 32-bit address space. |
| 0 | Resource Type Indicator (RTE) — RO. Hardwired to 0 to indicate a request for register memory space. |

NOTE:

- The ABAR register must be set to a value of 0001_0000h or greater.

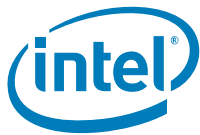

14.1.16.2 When SCC is 01h

When the programming interface is IDE, the register becomes an I/O BAR allocating 16 bytes of I/O space for the I/O-mapped registers defined in Section 14.2. Note that although 16 bytes of locations are allocated, only 8 bytes are used to as SINDX and SDATA registers; with the remaining 8 bytes preserved for future enhancement.

Address Offset: 24h–27h Attribute: R/WO
 Default Value: 00000001h Size: 32 bits

| Bit | Description |
|-------|-------------------------------------------------------------------------------|
| 31:16 | Reserved |
| 15:4 | Base Address (BA) — R/W. Base address of the I/O space. |
| 3:1 | Reserved |
| 0 | Resource Type Indicator (RTE) — RO. Indicates a request for I/O space. |

14.1.17 SVID—Subsystem Vendor Identification Register (SATA–D31:F2)

Address Offset: 2Ch–2Dh Attribute: R/WO
 Default Value: 0000h Size: 16 bits
 Lockable: No Power Well: Core
 Function Level Reset: No

| Bit | Description |
|------|-------------------------------------------------------------------------------------------------------------|
| 15:0 | Subsystem Vendor ID (SVID) — R/WO. Value is written by BIOS. No hardware action taken on this value. |

14.1.18 SID—Subsystem Identification Register (SATA–D31:F2)

Address Offset: 2Eh–2Fh Attribute: R/WO
 Default Value: 0000h Size: 16 bits
 Lockable: No Power Well: Core
 Function Level Reset: No

| Bit | Description |
|------|-----------------------------------------------------------------------------------------------------|
| 15:0 | Subsystem ID (SID) — R/WO. Value is written by BIOS. No hardware action taken on this value. |

14.1.19 CAP—Capabilities Pointer Register (SATA–D31:F2)

Address Offset: 34h Attribute: RO
 Default Value: 80h Size: 8 bits

| Bit | Description |
|-----|----------------------------------------------------------------------------------------------------------------------------------------------------------------------------------------------------------------------|
| 7:0 | Capabilities Pointer (CAP_PTR) — RO. Indicates that the first capability pointer offset is 80h. This value changes to 70h if the Sub Class Code (SCC) (Dev 31:F2:0Ah) is configure as IDE mode (value of 01). |



14.1.20 INT_LN—Interrupt Line Register (SATA–D31:F2)

Address Offset: 3Ch Attribute: R/W
 Default Value: 00h Size: 8 bits
 Function Level Reset: No

| Bit | Description |
|-----|------------------------------------------------------------------------------------------------------------------------------------------------------------------------------------|
| 7:0 | Interrupt Line — R/W. This field is used to communicate to software the interrupt line that the interrupt pin is connected to. Interrupt Line register is not reset by FLR. |

14.1.21 INT_PN—Interrupt Pin Register (SATA–D31:F2)

Address Offset: 3Dh Attribute: RO
 Default Value: See Register Description Size: 8 bits

| Bit | Description |
|-----|----------------------------------------------------------------------------------------------------------------------|
| 7:0 | Interrupt Pin — RO. This reflects the value of D31IP.SIP (Chipset Config Registers: Offset 3100h: bits 11:8). |

14.1.22 IDE_TIM — IDE Timing Register (SATA–D31:F2)

Address Offset: Primary: 40h–41h Attribute: R/W
 Secondary: 42h–43h
 Default Value: 0000h Size: 16 bits

| Bit | Description |
|------|--------------------------------------------------------------------------------------------------------------------------------------------------------------------------------------------------------------------------------------------------------------------------------------------------------------------------------------------------------------------------------------------------------------------------------------------------------------------------------------------------------------------------------------------------------------------------|
| 15 | IDE Decode Enable (IDE) — R/W. Individually enable/disable the Primary or Secondary decode. 0 = Disable. 1 = Enables the Intel [®] ICH10 to decode the associated Command Blocks (1F0–1F7h for primary, 170–177h for secondary) and Control Block (3F6h for primary and 376h for secondary). This bit effects the IDE decode ranges for both legacy and native-Mode decoding. NOTE: This bit affects SATA operation in both combined and non-combined ATA modes. See Section 5.16 for more on ATA modes of operation. |
| 14:0 | Reserved |

14.1.23 PID—PCI Power Management Capability Identification Register (SATA–D31:F2)

Address Offset: 70h–71h Attribute: RO
 Default Value: XX01h Size: 16 bits

| Bits | Description |
|------|-----------------------------------------------------------------------------------------------------------------------------------------------------------------------------------------------|
| 15:8 | Next Capability (NEXT) — RO. B0h — if SCC = 01h (IDE mode) indicating next item is FLR capability pointer. A8h — for all other values of SCC to point to the next capability structure. |
| 7:0 | Capability ID (CID) — RO. Indicates that this pointer is a PCI power management. |



14.1.24 PC—PCI Power Management Capabilities Register (SATA—D31:F2)

Address Offset: 72h–73h Attribute: RO
 Default Value: x003h Size: 16 bits

| Bits | Description |
|-------|--------------------------------------------------------------------------------------------------------------------------------------------------------------------------------------------------------------------------------------------------|
| 15:11 | PME Support (PME_SUP) — RO. 00000 = If SCC = 01h, indicates no PME support in IDE mode. 01000 = If SCC is not 01h, in a non-IDE mode, indicates PME# can be generated from the D3 _{HOT} state in the SATA host controller. |
| 10 | D2 Support (D2_SUP) — RO. Hardwired to 0. The D2 state is not supported |
| 9 | D1 Support (D1_SUP) — RO. Hardwired to 0. The D1 state is not supported |
| 8:6 | Auxiliary Current (AUX_CUR) — RO. PME# from D3 _{COLD} state is not supported, therefore this field is 000b. |
| 5 | Device Specific Initialization (DSI) — RO. Hardwired to 0 to indicate that no device-specific initialization is required. |
| 4 | Reserved |
| 3 | PME Clock (PME_CLK) — RO. Hardwired to 0 to indicate that PCI clock is not required to generate PME#. |
| 2:0 | Version (VER) — RO. Hardwired to 011 to indicates support for Revision 1.2 of the PCI Power Management Specification. |

14.1.25 PMCS—PCI Power Management Control and Status Register (SATA—D31:F2)

Address Offset: 74h–75h Attribute: R/W, R/WC
 Default Value: xx08h Size: 16 bits
 Function Level Reset: No (Bits 8 and 15)

| Bits | Description |
|------|--------------------------------------------------------------------------------------------------------------------------------------------------------------------------------------------------------------------------------------------------------------------------------------------------------------------------------------------------------------------------------------------------------------------|
| 15 | PME Status (PMES) — R/WC. Bit is set when a PME event is to be requested, and if this bit and PMEE is set, a PME# will be generated from the SATA controller Note: Whenever SCC = 01h, hardware will automatically change the attribute of this bit to RO '0'. Software is advised to clear PMEE and PMES together prior to changing SCC thru MAP.SMS. This bit is not reset by Function Level Reset. |
| 14:9 | Reserved |
| 8 | PME Enable (PMEE) — R/W. When set, the SATA controller generates PME# form D3 _{HOT} on a wake event. Note: Whenever SCCSCC = 01h, hardware will automatically change the attribute of this bit to RO '0'. Software is advised to clear PMEE and PMES together prior to changing SCC thru MAP.SMS. This bit is not reset by Function Level Reset. |
| 7:4 | Reserved |



| Bits | Description |
|------|-------------------------------------------------------------------------------------------------------------------------------------------------------------------------------------------------------------------------------------------------------------------------------------------------------------------------------------------------------------------------------------------------------------------------------------------------------------------------------------------------------------------------------------------------------------------------------------------------------------------------------------------------------------------------------------------------------------------------------------------------------------------------------------------------------------------------------------------------------------------------------------------------------|
| 3 | <p>No Soft Reset (NSFRST) — RO. These bits are used to indicate whether devices transitioning from D3_{HOT} state to D0 state will perform an internal reset.</p> <p>0 = Device transitioning from D3_{HOT} state to D0 state perform an internal reset.</p> <p>1 = Device transitioning from D3_{HOT} state to D0 state do not perform an internal reset.</p> <p>Configuration content is preserved. Upon transition from the D3_{HOT} state to D0 state initialized state, no additional operating system intervention is required to preserve configuration context beyond writing to the PowerState bits.</p> <p>Regardless of this bit, the controller transition from D3_{HOT} state to D0 state by a system or bus segment reset will return to the state D0 uninitialized with only PME context preserved if PME is supported and enabled.</p> |
| 2 | Reserved |
| 1:0 | <p>Power State (PS) — R/W. These bits are used both to determine the current power state of the SATA controller and to set a new power state.</p> <p>00 = D0 state</p> <p>11 = D3_{HOT} state</p> <p>When in the D3_{HOT} state, the controller's configuration space is available, but the I/O and memory spaces are not. Additionally, interrupts are blocked.</p> |

14.1.26 MSICI—Message Signaled Interrupt Capability Identification (SATA–D31:F2)

Address Offset: 80h–81h
 Default Value: 7005h

Attribute: RO
 Size: 16 bits

Note: There is no support for MSI when the software is operating in legacy (IDE) mode when AHCI is not enabled. Prior to switching from AHCI to IDE mode, software **must** make sure that MSI is disabled.

| Bits | Description |
|------|-----------------------------------------------------------------------------------------------------------|
| 15:8 | Next Pointer (NEXT) — RO. Indicates the next item in the list is the PCI power management pointer. |
| 7:0 | Capability ID (CID) — RO. Capabilities ID indicates MSI. |



14.1.27 MSIMC—Message Signaled Interrupt Message Control (SATA–D31:F2)

Address Offset: 82h–83h
 Default Value: 0000h

Attribute: R/W, RO
 Size: 16 bits

Note: There is no support for MSI when the software is operating in legacy (IDE) mode when AHCI is not enabled. Prior to switching from AHCI to IDE mode, software **must** make sure that MSI is disabled.

| Bits | Description | | | | | | | | | | | | | | | | | | | | | | | | | | | | | | | | | | | | | | | | |
|---------------|-----------------------------------------------------------------------------------------------------------------------------------------------------------------------------------------------------------------------------------------------------------------------------------------------------------------------------------------------------------------------------------------------------------------------------------------------------------------------------------------------------------------------------------------------------------------------------------------------------------------------------------------------------------------------------------------------------------------------------------------------------------------------------------------------------------------------------------------------------------------------------------------------------------------------------------------------------------------------------------------------------------------------------------------------------------------------------------------------------------------------------------------------------------------------------------------------------------------------------------------------------------------------------------------------------------------------------------------------------------------------------------------------------------------------------------------------------------------------------------------------------------------------------------------------------------------------------------------------------------------------------------------------------------------------------------------------------------------------------------------------------------------------------------------------------------------------------------------------------------------------------------------------------------------------------------------------------------------------------------------------------------------------------------------|----------------------------------------------------------------------------|----------------------------------------------------------------------------|----------------------------------------------------------------------------|--------|--------|--|------------|--------|--------|--------|---------------|----------|-------|-------|-------|-----|----------|----------------------------------------------------------------------------|----------------------------------------------------------------------------|----------------------------------------------------------------------------|-----|----------------------------------|--------|--------|--------|--|------------|--------|--------|--------|---------------|----------|-------|-------|-------|-----|----------|--------------------------------------------------|--------------------------------------------------|--------------------------------------------------|
| 15:8 | Reserved | | | | | | | | | | | | | | | | | | | | | | | | | | | | | | | | | | | | | | | | |
| 7 | <p>64 Bit Address Capable (C64) — RO. Capable of generating a 32-bit message only.</p> | | | | | | | | | | | | | | | | | | | | | | | | | | | | | | | | | | | | | | | | |
| 6:4 | <p>Multiple Message Enable (MME) — R/W. = 000 (and MSIE is set), a single MSI message will be generated for all SATA ports, and bits [15:0] of the message vector will be driven from MD[15:0].</p> <p>For 6 port components:</p> <table border="1"> <thead> <tr> <th>MME</th> <th>Value Driven on MSI Memory Write</th> <th>Bit[2]</th> <th>Bit[1]</th> <th>Bit[0]</th> </tr> </thead> <tbody> <tr> <td></td> <td>Bits[15:3]</td> <td>Bit[2]</td> <td>Bit[1]</td> <td>Bit[0]</td> </tr> <tr> <td>000, 001, 010</td> <td>MD[15:3]</td> <td>MD[2]</td> <td>MD[1]</td> <td>MD[0]</td> </tr> <tr> <td>100</td> <td>MD[15:3]</td> <td>Port 0: 0 Port 1: 0 Port 2: 0 Port 3: 0 Port 4: 1 Port 5: 1</td> <td>Port 0: 0 Port 1: 0 Port 2: 1 Port 3: 1 Port 4: 0 Port 5: 0</td> <td>Port 0: 0 Port 1: 1 Port 2: 0 Port 3: 1 Port 4: 0 Port 5: 1</td> </tr> </tbody> </table> <p>For 4 port components:</p> <table border="1"> <thead> <tr> <th>MME</th> <th>Value Driven on MSI Memory Write</th> <th>Bit[2]</th> <th>Bit[1]</th> <th>Bit[0]</th> </tr> </thead> <tbody> <tr> <td></td> <td>Bits[15:3]</td> <td>Bit[2]</td> <td>Bit[1]</td> <td>Bit[0]</td> </tr> <tr> <td>000, 001, 010</td> <td>MD[15:3]</td> <td>MD[2]</td> <td>MD[1]</td> <td>MD[0]</td> </tr> <tr> <td>100</td> <td>MD[15:3]</td> <td>Port 0: 0 Port 1: 0 Port 4: 1 Port 5: 1</td> <td>Port 0: 0 Port 1: 0 Port 2: 0 Port 3: 0</td> <td>Port 0: 0 Port 1: 1 Port 2: 0 Port 3: 1</td> </tr> </tbody> </table> <p>Values '011b' to '111b' are reserved. If this field is set to one of these reserved values, the results are undefined.</p> <p>NOTE: Note: The CCC interrupt is generated on unimplemented port (AHCI PI register bit equal to 0). If CCC interrupt is disabled, no MSI shall be generated for the port dedicated to the CCC interrupt. When CCC interrupt occurs, MD[2:0] is dependant on CCC_CTL.INT (in addition to MME).</p> | MME | Value Driven on MSI Memory Write | Bit[2] | Bit[1] | Bit[0] | | Bits[15:3] | Bit[2] | Bit[1] | Bit[0] | 000, 001, 010 | MD[15:3] | MD[2] | MD[1] | MD[0] | 100 | MD[15:3] | Port 0: 0 Port 1: 0 Port 2: 0 Port 3: 0 Port 4: 1 Port 5: 1 | Port 0: 0 Port 1: 0 Port 2: 1 Port 3: 1 Port 4: 0 Port 5: 0 | Port 0: 0 Port 1: 1 Port 2: 0 Port 3: 1 Port 4: 0 Port 5: 1 | MME | Value Driven on MSI Memory Write | Bit[2] | Bit[1] | Bit[0] | | Bits[15:3] | Bit[2] | Bit[1] | Bit[0] | 000, 001, 010 | MD[15:3] | MD[2] | MD[1] | MD[0] | 100 | MD[15:3] | Port 0: 0 Port 1: 0 Port 4: 1 Port 5: 1 | Port 0: 0 Port 1: 0 Port 2: 0 Port 3: 0 | Port 0: 0 Port 1: 1 Port 2: 0 Port 3: 1 |
| MME | Value Driven on MSI Memory Write | Bit[2] | Bit[1] | Bit[0] | | | | | | | | | | | | | | | | | | | | | | | | | | | | | | | | | | | | | |
| | Bits[15:3] | Bit[2] | Bit[1] | Bit[0] | | | | | | | | | | | | | | | | | | | | | | | | | | | | | | | | | | | | | |
| 000, 001, 010 | MD[15:3] | MD[2] | MD[1] | MD[0] | | | | | | | | | | | | | | | | | | | | | | | | | | | | | | | | | | | | | |
| 100 | MD[15:3] | Port 0: 0 Port 1: 0 Port 2: 0 Port 3: 0 Port 4: 1 Port 5: 1 | Port 0: 0 Port 1: 0 Port 2: 1 Port 3: 1 Port 4: 0 Port 5: 0 | Port 0: 0 Port 1: 1 Port 2: 0 Port 3: 1 Port 4: 0 Port 5: 1 | | | | | | | | | | | | | | | | | | | | | | | | | | | | | | | | | | | | | |
| MME | Value Driven on MSI Memory Write | Bit[2] | Bit[1] | Bit[0] | | | | | | | | | | | | | | | | | | | | | | | | | | | | | | | | | | | | | |
| | Bits[15:3] | Bit[2] | Bit[1] | Bit[0] | | | | | | | | | | | | | | | | | | | | | | | | | | | | | | | | | | | | | |
| 000, 001, 010 | MD[15:3] | MD[2] | MD[1] | MD[0] | | | | | | | | | | | | | | | | | | | | | | | | | | | | | | | | | | | | | |
| 100 | MD[15:3] | Port 0: 0 Port 1: 0 Port 4: 1 Port 5: 1 | Port 0: 0 Port 1: 0 Port 2: 0 Port 3: 0 | Port 0: 0 Port 1: 1 Port 2: 0 Port 3: 1 | | | | | | | | | | | | | | | | | | | | | | | | | | | | | | | | | | | | | |



| Bits | Description |
|------|--------------------------------------------------------------------------------------------------------------------------------------------------------------------------------------------------------------------------------------------------------------------------------------------------------------------------------------------------------------------------------------------------------------------------------------------------------------------------------------------------------------|
| 3:1 | Multiple Message Capable (MMC) — RO. Indicates the number of interrupt messages supported by the ICH10 SATA controller. 000 = 1 MSI Capable (When SCC bit is set to 01h. MSI is not supported in IDE mode) 100 = 8 MSI Capable |
| 0 | MSI Enable (MSIE) — R/W /RO. If set, MSI is enabled and traditional interrupt pins are not used to generate interrupts. This bit is RW when SC.SCC is not 01h and is read-only 0 when SCC is 01h. Note that CMD.ID bit has no effect on MSI. NOTE: Software must clear this bit to '0' to disable MSI first before changing the number of messages allocated in the MMC field. Software must also make sure this bit is cleared to '0' when operating in legacy mode (when GHC.AE = 0). |

14.1.28 MSIMA— Message Signaled Interrupt Message Address (SATA–D31:F2)

| | | | |
|-----------------|-----------|------------|---------|
| Address Offset: | 84h–87h | Attribute: | R/W |
| Default Value: | 00000000h | Size: | 32 bits |

Note: There is no support for MSI when the software is operating in legacy (IDE) mode when AHCI is not enabled. Prior to switching from AHCI to IDE mode, software **must** make sure that MSI is disabled.

| Bits | Description |
|------|-----------------------------------------------------------------------------------------------------------|
| 31:2 | Address (ADDR) — R/W. Lower 32 bits of the system specified message address, always DWORD aligned. |
| 1:0 | Reserved |

14.1.29 MSIMD—Message Signaled Interrupt Message Data (SATA–D31:F2)

| | | | |
|-----------------|---------|------------|---------|
| Address Offset: | 88h–89h | Attribute: | R/W |
| Default Value: | 0000h | Size: | 16 bits |

Note: There is no support for MSI when the software is operating in legacy (IDE) mode when AHCI is not enabled. Prior to switching from AHCI to IDE mode, software **must** make sure that MSI is disabled.

| Bits | Description |
|------|---------------------------------------------------------------------------------------------------------------------------------------------------------------------------------------------------------------------------------------------------------------------------------------------------------------------------------------------------------------------------------------------------------------------------------------------------|
| 15:0 | Data (DATA) — R/W. This 16-bit field is programmed by system software if MSI is enabled. Its content is driven onto the lower word of the data bus of the MSI memory write transaction. Note that when the MME field is set to '001' or '010', bit [0] and bits [1:0] respectively of the MSI memory write transaction will be driven based on the source of the interrupt rather than from MD[2:0]. See the description of the MME field. |



PxCMD fields. Because an AHCI or RAID aware OS will typically not have knowledge of the PxE bits and because the PxE bits act as master on/off switches for the ports, pre-boot software must insure that these bits are set to '1' prior to booting the OS, regardless as to whether or not a device is currently on the port.

| Bits | Description |
|------|--------------------------------------------------------------------------------------------------------------------------------------------------------------------------------------------------------------------------------------------------------------------------------------------------------------------------------------------------------------------------------------------------------------|
| 15 | OOB Retry Mode (ORM) — RW. 0 = The SATA controller will not retry after an OOB failure 1 = The SATA controller will continue to retry after an OOB failure until successful (infinite retry) |
| 14 | Reserved. |
| 13 | Port 5 Present (P5P) — RO. The status of this bit may change at any time. This bit is cleared when the port is disabled via P5E. This bit is not cleared upon surprise removal of a device. 0 = No device detected. 1 = The presence of a device on Port 5 has been detected. |
| 12 | Port 4 Present (P4P) — RO. The status of this bit may change at any time. This bit is cleared when the port is disabled via P4E. This bit is not cleared upon surprise removal of a device. 0 = No device detected. 1 = The presence of a device on Port 4 has been detected. |
| 11 | Port 3 Present (P3P) — RO. The status of this bit may change at any time. This bit is cleared when the port is disabled via P3E. This bit is not cleared upon surprise removal of a device. 0 = No device detected. 1 = The presence of a device on Port 3 has been detected. |
| 10 | Port 2 Present (P2P) — RO. The status of this bit may change at any time. This bit is cleared when the port is disabled via P2E. This bit is not cleared upon surprise removal of a device. 0 = No device detected. 1 = The presence of a device on Port 2 has been detected. |
| 9 | Port 1 Present (P1P) — RO. The status of this bit may change at any time. This bit is cleared when the port is disabled via P1E. This bit is not cleared upon surprise removal of a device. 0 = No device detected. 1 = The presence of a device on Port 1 has been detected. |
| 8 | Port 0 Present (P0P) — RO. The status of this bit may change at any time. This bit is cleared when the port is disabled via P0E. This bit is not cleared upon surprise removal of a device. 0 = No device detected. 1 = The presence of a device on Port 0 has been detected. |
| 7:6 | Reserved |
| 5 | Port 5 Enabled (P5E) — R/W. 0 = Disabled. The port is in the 'off' state and cannot detect any devices. 1 = Enabled. The port can transition between the on, partial, and slumber states and can detect devices. NOTE: This bit takes precedence over P5CMD.SUD (offset ABAR+298h:bit 1) If MAP.SC is '0', if SCC is '01h' this bit will be read only '0' or if MAP.SPD[5] is '1'. |



| Bits | Description |
|------|-----------------------------------------------------------------------------------------------------------------------------------------------------------------------------------------------------------------------------------------------------------------------------------------------------------------------------------------------------------------------------------------------------------------------------------------------------------|
| 4 | <p>Port 4 Enabled (P4E) — R/W. 0 = Disabled. The port is in the 'off' state and cannot detect any devices. 1 = Enabled. The port can transition between the on, partial, and slumber states and can detect devices. NOTE: This bit takes precedence over P4CMD.SUD (offset ABAR+298h:bit 1) If MAP.SC is '0', if SCC is '01h' this bit will be read only '0' or if MAP.SPD[4] is '1'.</p> |
| 3 | <p>Port 3 Enabled (P3E) — R/W. 0 = Disabled. The port is in the 'off' state and cannot detect any devices. 1 = Enabled. The port can transition between the on, partial, and slumber states and can detect devices. NOTE: This bit takes precedence over P3CMD.SUD (offset ABAR+298h:bit 1). When MAP.SPD[3] is '1' this is reserved and is read-only 0.</p> |
| 2 | <p>Port 2 Enabled (P2E) — R/W. 0 = Disabled. The port is in the 'off' state and cannot detect any devices. 1 = Enabled. The port can transition between the on, partial, and slumber states and can detect devices. NOTE: This bit takes precedence over P2CMD.SUD (offset ABAR+218h:bit 1). When MAP.SPD[2] is '1' this is reserved and is read-only 0.</p> |
| 1 | <p>Port 1 Enabled (P1E) — R/W. 0 = Disabled. The port is in the 'off' state and cannot detect any devices. 1 = Enabled. The port can transition between the on, partial, and slumber states and can detect devices. NOTE: This bit takes precedence over P1CMD.SUD (offset ABAR+198h:bit 1). When MAP.SPD[1] is '1' this is reserved and is read-only 0.</p> |
| 0 | <p>Port 0 Enabled (POE) — R/W. 0 = Disabled. The port is in the 'off' state and cannot detect any devices. 1 = Enabled. The port can transition between the on, partial, and slumber states and can detect devices. NOTE: This bit takes precedence over POCMD.SUD (offset ABAR+118h:bit 1). When MAP.SPD[0] is '1' this is reserved and is read-only 0.</p> |



14.1.32 SCLKCG—SATA Clock Gating Control Register

Address Offset: 94h-97h
 Default Value: 00000000h

Attribute: R/W
 Size: 32 bits

| Bit | Description |
|-------|--------------------------------------------------------------------------------------------------------------------------------------------------------------------------------------------------------------------------------------------------------------------------------------------------------------------------------------------------------------------------------------------------------------------------------------------------------------------------------------------------------------------------------------------------------------------------------------------------------------------------------------------------------------------------------------------------------------------------------|
| 31:30 | Reserved. |
| 29:24 | <p>Port Clock Disable (PCD) — 0 = All clocks to the associated port logic will operate normally. 1 = The backbone clock driven to the associated port logic is gated and will not toggle.</p> <p>Bit 29: Port 5 Bit 28: Port 4 Bit 27: Port 3 Bit 26: Port 2 Bit 25: Port 1 Bit 24: Port 0</p> <p>If a port is not available, software shall set the corresponding bit to 1. Software can also set the corresponding bits to 1 on ports that are disabled.</p> <p>Software cannot set the PCD [port x]='1' if the corresponding PCS.PxE='1' in either Dev31Func2 or Dev31Func5 (dual controller IDE mode).</p> |
| 23:9 | Reserved. |
| 8:0 | SCLKCG Field 1 — R/W. BIOS must program these bits to 193h. |



14.1.33.1 SATACRO—SATA Capability Register 0 (SATA–D31:F2)

Address Offset: A8h–ABh Attribute: RO, R/WO
 Default Value: 0010B012h Size: 32 bits
 Function Level Reset: No (Bits 15:8 only)

Note: This register shall be read-only 0 when SCC is 01h.

| Bit | Description |
|-------|------------------------------------------------------------------------------------------------------------------------------------------|
| 31:24 | Reserved |
| 23:20 | Major Revision (MAJREV) — RO: Major revision number of the SATA Capability Pointer implemented. |
| 19:16 | Minor Revision (MINREV) — RO: Minor revision number of the SATA Capability Pointer implemented. |
| 15:8 | Next Capability Pointer (NEXT) — R/WO: Points to the next capability structure. These bits are not reset by Function Level Reset. |
| 7:0 | Capability ID (CAP) — RO: This value of 12h has been assigned by the PCI SIG to designate the SATA Capability Structure. |

14.1.33.2 SATACR1—SATA Capability Register 1 (SATA–D31:F2)

Address Offset: ACh–AFh Attribute: RO
 Default Value: 00000048h Size: 32 bits

Note: This register shall be read-only 0 when SCC is 01h.

| Bit | Description |
|-------|----------------------------------------------------------------------------------------------------------------------------------------------------------------------------------------------------------------------------------------------------------------------------------------------------------------------------------------------------------------------------------------------------------------------------------------------------------------------------------------------------------------------------------------------------------------------------------------------------------|
| 31:16 | Reserved |
| 15:4 | BAR Offset (BAROFST) — RO: Indicates the offset into the BAR where the Index/Data pair are located (in Dword granularity). The Index and Data I/O registers are located at offset 10h within the I/O space defined by LBAR. A value of 004h indicates offset 10h. 000h = 0h offset 001h = 4h offset 002h = 8h offset 003h = Bh offset 004h = 10h offset ... FFFh = 3FFFh offset (max 16KB) |
| 3:0 | BAR Location (BARLOC) — RO: Indicates the absolute PCI Configuration Register address of the BAR containing the Index/Data pair (in Dword granularity). The Index and Data I/O registers reside within the space defined by LBAR in the SATA controller. A value of 8h indicates offset 20h, which is LBAR. 0000 – 0011b = reserved 0100b = 10h => BAR0 0101b = 14h => BAR1 0110b = 18h => BAR2 0111b = 1Ch => BAR3 1000b = 20h => LBAR 1001b = 24h => BAR5 1010 – 1110b = reserved 1111b = Index/Data pair in PCI Configuration space. This isn't supported in ICH10. |



14.1.36 FLRC—FLR Control (SATA—D31:F2)

Address Offset: B4-B5h Attribute: RO, R/W
 Default Value: 0000h Size: 16 bits

| Bit | Description |
|------|-------------------------------------------------------------------------------------------------------------------------------------------------------------------------------------------------------------------------|
| 15:9 | Reserved. |
| 8 | Transactions Pending (TXP) — RO. 0 = Controller has received all non-posted requests. 1 = Controller has issued non-posted requests which has not been completed. |
| 7:1 | Reserved. |
| 0 | Initiate FLR — R/W. Used to initiate FLR transition. A write of '1' indicates FLR transition. Since hardware must not respond to any cycles till FLR completion the value read by software from this bit is '0'. |

14.1.37 ATC—APM Trapping Control Register (SATA—D31:F2)

Address Offset: C0h Attribute: R/W
 Default Value: 00h Size: 8 bits
 Function Level Reset: No

| Bit | Description |
|-----|------------------------------------------------------------------------------------------------------------------------------------------------------------------------------------------------------------------------------|
| 7:4 | Reserved |
| 3 | Secondary Slave Trap (SST) — R/W. Enables trapping and SMI# assertion on legacy I/O accesses to 170h-177h and 376h. The active device on the secondary interface must be device 1 for the trap and/or SMI# to occur. |
| 2 | Secondary Master Trap (SPT) — R/W. Enables trapping and SMI# assertion on legacy I/O accesses to 170h-177h and 376h. The active device on the secondary interface must be device 0 for the trap and/or SMI# to occur. |
| 1 | Primary Slave Trap (PST) — R/W. Enables trapping and SMI# assertion on legacy I/O accesses to 1F0h-1F7h and 3F6h. The active device on the primary interface must be device 1 for the trap and/or SMI# to occur. |
| 0 | Primary Master Trap (PMT) — R/W. Enables trapping and SMI# assertion on legacy I/O accesses to 1F0h-1F7h and 3F6h. The active device on the primary interface must be device 0 for the trap and/or SMI# to occur. |



14.1.40 BFCS—BIST FIS Control/Status Register (SATA–D31:F2)

Address Offset: E0h–E3h Attribute: R/W, R/WC
 Default Value: 00000000h Size: 32 bits

| Bits | Description |
|-------|--------------------------------------------------------------------------------------------------------------------------------------------------------------------------------------------------------------------------------------------------------------------------------------------------------------------------------------------------------------------------------------------------------------------------------------------------------------------------------------------------------------------------------------------------------------------------------------------------------------------------------------------------------------------------------------------------------------------------------------------------------------------------------------------------------------------------------|
| 31:16 | Reserved |
| 15 | Port 5 BIST FIS Initiate (P5BFI) — R/W. When a rising edge is detected on this bit field, the ICH10 initiates a BIST FIS to the device on Port 5, using the parameters specified in this register and the data specified in BFTD1 and BFTD2. The BIST FIS will only be initiated if a device on Port 5 is present and ready (not partial/slumber state). After a BIST FIS is successfully completed, software must disable and re-enable the port using the PxE bits at offset 92h prior to attempting additional BIST FISs or to return the ICH10 to a normal operational mode. If the BIST FIS fails to complete, as indicated by the BFF bit in the register, then software can clear then set the P5BFI bit to initiate another BIST FIS. This can be retried until the BIST FIS eventually completes successfully |
| 14 | Port 4 BIST FIS Initiate (P4BFI) — R/W. When a rising edge is detected on this bit field, the ICH10 initiates a BIST FIS to the device on Port 4, using the parameters specified in this register and the data specified in BFTD1 and BFTD2. The BIST FIS will only be initiated if a device on Port 4 is present and ready (not partial/slumber state). After a BIST FIS is successfully completed, software must disable and re-enable the port using the PxE bits at offset 92h prior to attempting additional BIST FISs or to return the ICH10 to a normal operational mode. If the BIST FIS fails to complete, as indicated by the BFF bit in the register, then software can clear then set the P4BFI bit to initiate another BIST FIS. This can be retried until the BIST FIS eventually completes successfully |
| 13 | Port 3 BIST FIS Initiate (P3BFI) — R/W. When a rising edge is detected on this bit field, the ICH10 initiates a BIST FIS to the device on Port 3, using the parameters specified in this register and the data specified in BFTD1 and BFTD2. The BIST FIS will only be initiated if a device on Port 3 is present and ready (not partial/slumber state). After a BIST FIS is successfully completed, software must disable and re-enable the port using the PxE bits at offset 92h prior to attempting additional BIST FISs or to return the ICH10 to a normal operational mode. If the BIST FIS fails to complete, as indicated by the BFF bit in the register, then software can clear then set the P3BFI bit to initiate another BIST FIS. This can be retried until the BIST FIS eventually completes successfully |
| 12 | Port 2 BIST FIS Initiate (P2BFI) — R/W. When a rising edge is detected on this bit field, the ICH10 initiates a BIST FIS to the device on Port 2, using the parameters specified in this register and the data specified in BFTD1 and BFTD2. The BIST FIS will only be initiated if a device on Port 2 is present and ready (not partial/slumber state). After a BIST FIS is successfully completed, software must disable and re-enable the port using the PxE bits at offset 92h prior to attempting additional BIST FISes or to return the ICH10 to a normal operational mode. If the BIST FIS fails to complete, as indicated by the BFF bit in the register, then software can clear then set the P2BFI bit to initiate another BIST FIS. This can be retried until the BIST FIS eventually completes successfully |
| 11 | BIST FIS Successful (BFS) — R/WC. 0 = Software clears this bit by writing a 1 to it. 1 = This bit is set any time a BIST FIS transmitted by ICH10 receives an R_OK completion status from the device. NOTE: This bit must be cleared by software prior to initiating a BIST FIS. |



| Bits | Description |
|------|---------------------------------------------------------------------------------------------------------------------------------------------------------------------------------------------------------------------------------------------------------------------------------------------------------------------------------------------------------------------------------------------------------------------------------------------------------------------------------------------------------------------------------------------------------------------------------------------------------------------------------------------------------------------------------------------------------------------------------------------------------------------------------------------------------------------------------------|
| 10 | <p>BIST FIS Failed (BFF) — R/WC. 0 = Software clears this bit by writing a 1 to it. 1 = This bit is set any time a BIST FIS transmitted by ICH10 receives an R_ERR completion status from the device.</p> <p>NOTE: This bit must be cleared by software prior to initiating a BIST FIS.</p> |
| 9 | <p>Port 1 BIST FIS Initiate (P1BFI) — R/W. When a rising edge is detected on this bit field, the ICH10 initiates a BIST FIS to the device on Port 1, using the parameters specified in this register and the data specified in BFTD1 and BFTD2. The BIST FIS will only be initiated if a device on Port 1 is present and ready (not partial/slumber state). After a BIST FIS is successfully completed, software must disable and re-enable the port using the PxE bits at offset 92h prior to attempting additional BIST FISes or to return the ICH10 to a normal operational mode. If the BIST FIS fails to complete, as indicated by the BFF bit in the register, then software can clear then set the P1BFI bit to initiate another BIST FIS. This can be retried until the BIST FIS eventually completes successfully</p> |
| 8 | <p>Port 0 BIST FIS Initiate (POBFI) — R/W. When a rising edge is detected on this bit field, the ICH10 initiates a BIST FIS to the device on Port 0, using the parameters specified in this register and the data specified in BFTD1 and BFTD2. The BIST FIS will only be initiated if a device on Port 0 is present and ready (not partial/slumber state). After a BIST FIS is successfully completed, software must disable and re-enable the port using the PxE bits at offset 92h prior to attempting additional BIST FISes or to return the ICH10 to a normal operational mode. If the BIST FIS fails to complete, as indicated by the BFF bit in the register, then software can clear then set the POBFI bit to initiate another BIST FIS. This can be retried until the BIST FIS eventually completes successfully</p> |
| 7:2 | <p>BIST FIS Parameters (BFP) — R/W. These 6 bits form the contents of the upper 6 bits of the BIST FIS Pattern Definition in any BIST FIS transmitted by the ICH10. This field is not port specific — its contents will be used for any BIST FIS initiated on port 0, port 1, port 2 or port 3. The specific bit definitions are:</p> <ul style="list-style-type: none"> Bit 7: T – Far End Transmit mode Bit 6: A – Align Bypass mode Bit 5: S – Bypass Scrambling Bit 4: L – Far End Retimed Loopback Bit 3: F – Far End Analog Loopback Bit 2: P – Primitive bit for use with Transmit mode |
| 1:0 | Reserved |

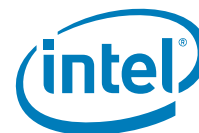

14.1.41 BFTD1—BIST FIS Transmit Data1 Register (SATA–D31:F2)

Address Offset: E4h–E7h Attribute: R/W
 Default Value: 00000000h Size: 32 bits

| Bits | Description |
|------|--------------------------------------------------------------------------------------------------------------------------------------------------------------------------------------------------------------------------------------------------------------------------------------------------------------------------------------------------------------------------------------------------------------------------------------------------------------------------------------------------------------------------------------------------------------------------------|
| 31:0 | BIST FIS Transmit Data 1 — R/W. The data programmed into this register will form the contents of the second dword of any BIST FIS initiated by the ICH10. This register is not port specific — its contents will be used for BIST FIS initiated on any port. Although the 2nd and 3rd DWs of the BIST FIS are only meaningful when the “T” bit of the BIST FIS is set to indicate “Far-End Transmit mode”, this register’s contents will be transmitted as the BIST FIS 2nd DW regardless of whether or not the “T” bit is indicated in the BFCS register (D31:F2:E0h). |

14.1.42 BFTD2—BIST FIS Transmit Data2 Register (SATA–D31:F2)

Address Offset: E8h–EBh Attribute: R/W
 Default Value: 00000000h Size: 32 bits

| Bits | Description |
|------|-------------------------------------------------------------------------------------------------------------------------------------------------------------------------------------------------------------------------------------------------------------------------------------------------------------------------------------------------------------------------------------------------------------------------------------------------------------------------------------------------------------------------------------------------------------------------------|
| 31:0 | BIST FIS Transmit Data 2 — R/W. The data programmed into this register will form the contents of the third dword of any BIST FIS initiated by the ICH10. This register is not port specific — its contents will be used for BIST FIS initiated on any port. Although the 2nd and 3rd DWs of the BIST FIS are only meaningful when the “T” bit of the BIST FIS is set to indicate “Far-End Transmit mode”, this register’s contents will be transmitted as the BIST FIS 3rd DW regardless of whether or not the “T” bit is indicated in the BFCS register (D31:F2:E0h). |



14.2 Bus Master IDE I/O Registers (D31:F2)

The bus master IDE function uses 16 bytes of I/O space, allocated via the BAR register, located in Device 31:Function 2 Configuration space, offset 20h. All bus master IDE I/O space registers can be accessed as byte, word, or dword quantities. Reading reserved bits returns an indeterminate, inconsistent value, and writes to reserved bits have no effect (but should not be attempted). These registers are only used for legacy operation. Software must not use these registers when running AHCI. All I/O registers are reset by Function Level Reset. The description of the I/O registers is shown in Table 14-2.

Table 14-2. Bus Master IDE I/O Register Address Map

| BAR+ Offset | Mnemonic | Register | Default | Type |
|-------------|----------|---------------------------------------------------|-----------|---------------|
| 00 | BMICP | Command Register Primary | 00h | R/W |
| 01 | — | Reserved | — | RO |
| 02 | BMISP | Bus Master IDE Status Register Primary | 00h | R/W, R/WC, RO |
| 03 | — | Reserved | — | RO |
| 04–07 | BMIDP | Bus Master IDE Descriptor Table Pointer Primary | xxxxxxxh | R/W |
| 08 | BMICS | Command Register Secondary | 00h | R/W |
| 09 | — | Reserved | — | RO |
| 0Ah | BMISS | Bus Master IDE Status Register Secondary | 00h | R/W, R/WC, RO |
| 0Bh | — | Reserved | — | RO |
| 0Ch–0Fh | BMIDS | Bus Master IDE Descriptor Table Pointer Secondary | xxxxxxxh | R/W |
| 10h | AIR | AHCI Index Register | 00000000h | R/W, RO |
| 14h | AIDR | AHCI Index Data Register | xxxxxxxh | R/W |

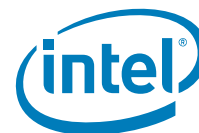

14.2.1 BMIC[P,S]—Bus Master IDE Command Register (D31:F2)

Address Offset: Primary: BAR + 00h Attribute: R/W
 Secondary: BAR + 08h
 Default Value: 00h Size: 8 bits

| Bit | Description |
|-----|--------------------------------------------------------------------------------------------------------------------------------------------------------------------------------------------------------------------------------------------------------------------------------------------------------------------------------------------------------------------------------------------------------------------------------------------------------------------------------------------------------------------------------------------------------------------------------------------------------------------------------------------------------------------------------------------------------------------------------------------------------------------------------------------------------------------------------------------------------------------------------------------------------------------------------------------------------------------------------------------------------------------------------------------------------------------------------------------------------------------------------------------------------------------------------------------------------------------------------------------------------------------------------------------------------------------------------------------------------------------------------------------------------------------------------------------------------------------------------------------------------------------------------------------------------|
| 7:4 | Reserved. Returns 0. |
| 3 | <p>Read / Write Control (R/WC) — R/W. This bit sets the direction of the bus master transfer: This bit must NOT be changed when the bus master function is active.</p> <p>0 = Memory reads 1 = Memory writes</p> |
| 2:1 | Reserved. Returns 0. |
| 0 | <p>Start/Stop Bus Master (START) — R/W.</p> <p>0 = All state information is lost when this bit is cleared. Master mode operation cannot be stopped and then resumed. If this bit is reset while bus master operation is still active (i.e., the Bus Master IDE Active bit (D31:F2:BAR + 02h, bit 0) of the Bus Master IDE Status register for that IDE channel is set) and the drive has not yet finished its data transfer (the Interrupt bit in the Bus Master IDE Status register for that IDE channel is not set), the bus master command is said to be aborted and data transferred from the drive may be discarded instead of being written to system memory.</p> <p>1 = Enables bus master operation of the controller. Bus master operation does not actually start unless the Bus Master Enable bit (D31:F1:04h, bit 2) in PCI configuration space is also set. Bus master operation begins when this bit is detected changing from 0 to 1. The controller will transfer data between the IDE device and memory only when this bit is set. Master operation can be halted by writing a 0 to this bit.</p> <p>NOTE: This bit is intended to be cleared by software after the data transfer is completed, as indicated by either the Bus Master IDE Active bit being cleared or the Interrupt bit of the Bus Master IDE Status register for that IDE channel being set, or both. Hardware does not clear this bit automatically. If this bit is cleared to 0 prior to the DMA data transfer being initiated by the drive in a</p> |



14.2.2 BMIS[P,S]—Bus Master IDE Status Register (D31:F2)

Address Offset: Primary: BAR + 02h Attribute: R/W, R/WC, RO
Secondary: BAR + 0Ah
Default Value: 00h Size: 8 bits

| Bit | Description |
|-----|------------------------------------------------------------------------------------------------------------------------------------------------------------------------------------------------------------------------------------------------------------------------------------------------------------------------------------------------------------------------------------------------------------------------------------------------------------------------------------------------------------------------------------------------------------------------------------------|
| 7 | PRD Interrupt Status (PRDIS) — R/WC. 0 = Software clears this bit by writing a 1 to it. 1 = This bit is set when the host controller execution of a PRD that has its PRD_INT bit set. |
| 6 | Drive 1 DMA Capable — R/W. 0 = Not Capable. 1 = Capable. Set by device dependent code (BIOS or device driver) to indicate that drive 1 for this channel is capable of DMA transfers, and that the controller has been initialized for optimum performance. The Intel® ICH10 does not use this bit. It is intended for systems that do not attach BMIDE to the PCI bus. |
| 5 | Drive 0 DMA Capable — R/W. 0 = Not Capable 1 = Capable. Set by device dependent code (BIOS or device driver) to indicate that drive 0 for this channel is capable of DMA transfers, and that the controller has been initialized for optimum performance. The ICH10 does not use this bit. It is intended for systems that do not attach BMIDE to the PCI bus. |
| 4:3 | Reserved. Returns 0. |
| 2 | Interrupt — R/WC. 0 = Software clears this bit by writing a 1 to it. 1 = Set when a device FIS is received with the 'I' bit set, provided that software has not disabled interrupts via the IEN bit of the Device Control Register (see chapter 5 of the <i>Serial ATA Specification</i> , Revision 1.0a). |
| 1 | Error — R/WC. 0 = Software clears this bit by writing a 1 to it. 1 = This bit is set when the controller encounters a target abort or master abort when transferring data on PCI. |
| 0 | Bus Master IDE Active (ACT) — RO. 0 = This bit is cleared by the ICH10 when the last transfer for a region is performed, where EOT for that region is set in the region descriptor. It is also cleared by the ICH10 when the Start Bus Master bit (D31:F2:BAR+ 00h, bit 0) is cleared in the Command register. When this bit is read as a 0, all data transferred from the drive during the previous bus master command is visible in system memory, unless the bus master command was aborted. 1 = Set by the ICH10 when the Start bit is written to the Command register. |



14.2.3 BMID[P,S]—Bus Master IDE Descriptor Table Pointer Register (D31:F2)

Address Offset: Primary: BAR + 04h–07h Attribute: R/W
 Secondary: BAR + 0Ch–0Fh
 Default Value: All bits undefined Size: 32 bits

| Bit | Description |
|------|------------------------------------------------------------------------------------------------------------------------------------------------------------------------------------------------------------------------------------------------------------------------------|
| 31:2 | Address of Descriptor Table (ADDR) — R/W. The bits in this field correspond to bits [31:2] of the memory location of the Physical Region Descriptor (PRD). The Descriptor Table must be Dword-aligned. The Descriptor Table must not cross a 64-K boundary in memory. |
| 1:0 | Reserved |

14.2.4 AIR—AHCI Index Register (D31:F2)

Address Offset: Primary: BAR + 10h Attribute: R/W
 Default Value: 00000000h Size: 32 bits

This register is available only when SCC is not 01h.

| Bit | Description |
|-------|----------------------------------------------------------------------------------------------------------------------------------------------------------------------------------------------------------------------------------------------------|
| 31:11 | Reserved |
| 10:2 | Index (INDEX) — R/W: This Index register is used to select the Dword offset of the Memory Mapped AHCI register to be accessed. A Dword, Word or Byte access is specified by the active byte enables of the I/O access to the Data register. |
| 1:0 | Reserved |

14.2.5 AIDR—AHCI Index Data Register (D31:F2)

Address Offset: Primary: BAR + 14h Attribute: R/W
 Default Value: All bits undefined Size: 32 bits

This register is available only when SCC is not 01h.

| Bit | Description |
|------|---------------------------------------------------------------------------------------------------------------------------------------------------------------------------------------------------------------------------------------------------------------------------------------------------------------------------------------------------------------------------------------------------------------------------------------------------------------------------------------------------------------------------------------------------------------------------------------------------------------------------------------|
| 31:0 | Data (DATA) — R/W: This Data register is a “window” through which data is read or written to the AHCI memory mapped registers. A read or write to this Data register triggers a corresponding read or write to the memory mapped register pointed to by the Index register. The Index register must be setup prior to the read or write to this Data register. Note that a physical register is not actually implemented as the data is actually stored in the memory mapped registers. Since this is not a physical register, the “default” value is the same as the default value of the register pointed to by Index. |



14.3 Serial ATA Index/Data Pair Superset Registers

All of these I/O registers are in the core well. They are exposed only when SCC is 01h (i.e., IDE programming interface).

These are Index/Data Pair registers that are used to access the SerialATA superset registers (SerialATA Status, SerialATA Control and SerialATA Error). The I/O space for these registers is allocated through SIDPBA. Locations with offset from 08h to 0Fh are reserved for future expansion. Software-write operations to the reserved locations will have no effect while software-read operations to the reserved locations will return 0.

| Offset | Mnemonic | Register |
|---------|----------|------------------|
| 00h–03h | SINDEX | Serial ATA Index |
| 04h–07h | SDATA | Serial ATA Data |
| 08h–0Ch | — | Reserved |
| 0Ch–0Fh | — | Reserved |

14.3.1 SINDEX – Serial ATA Index (D31:F2)

Address Offset: SIDPBA + 00h Attribute: R/W
 Default Value: 00000000h Size: 32 bits

| Bit | Description |
|-------|----------------------------------------------------------------------------------------------------------------------------------------------------------------------------------------------------------------------------------------------------------------------------------------------------------------------------------------------------------------------------------------------------------------------------------------------------------------------------------------------------------------------------------------------------------------------------------------------------|
| 31:16 | Reserved |
| 15:8 | Port Index (PIDX) - R/W: This Index field is used to specify the port of the SATA controller at which the port-specific SSTS, SCTL, and SERR registers are located. 00h = Primary Master (Port 0) 01h = Primary Slave (Port 2) 02h = Secondary Master (Port 1) 03h = Secondary Slave (Port 3) All other values are Reserved. |
| 7:0 | Register Index (RIDX) - R/W: This index field is used to specify one out of three registers currently being indexed into. These three registers are the Serial ATA superset SStatus, SControl and SError memory registers and are port specific, hence for this SATA controller, there are four sets of these registers. Refer to Section 14.4.3.10 , Section 14.4.3.11 , and Section 14.4.3.12 for definitions of the SStatus, SControl, and SError registers. 00h = SSTS 01h = SCTL 02h = SERR All other values are Reserved. |

14.3.2 SDATA – Serial ATA Data (D31:F2)

Address Offset: SIDPBA + 04h Attribute: R/W
 Default Value: 00000000h Size: 32 bits

| Bit | Description |
|------|------------------------------------------------------------------------------------------------------------------------------------------------------------------------------------------------------------------------------------------------------------------------------------------------------------------------------------------------------------------------------------------------------------------------------------------------------------|
| 31:0 | Data (DATA) - R/W: This Data register is a “window” through which data is read or written to from the register pointed to by the Serial ATA Index (SINDEX) register above. Note that a physical register is not actually implemented as the data is actually stored in the memory mapped registers. Since this is not a physical register, the “default” value is the same as the default value of the register pointed to by SINDEX.RIDX field. |



14.3.2.1 PxSSTS—Serial ATA Status Register (D31:F2)

Address Offset: Attribute: RO
 Default Value: 00000000h Size: 32 bits

SDATA when SINDX.RIDX is 00h. This is a 32-bit register that conveys the current state of the interface and host. The ICH10 updates it continuously and asynchronously. When the ICH10 transmits a COMRESET to the device, this register is updated to its reset values.

| Bit | Description | | | | | | | | | | |
|-------|-------------------------------------------------------------------------------------------------------------------------------------------------------------------------------------------------------------------------------------------------------------------------------------------------------------------------------------------------------------------------------------------------------------------------------------------------------------------------------------------------------------------------------------------------------------------------------------------------------------------------------------------------------------------------|-------|-------------|----|----------------------------------------------------------|----|----------------------------------------------------------------|----|------------------------------------------------------------|----|----------------------------------------------------------------------------------------------------|
| 31:12 | Reserved | | | | | | | | | | |
| 11:8 | <p>Interface Power Management (IPM) — RO. Indicates the current interface state:</p> <table border="1"> <thead> <tr> <th>Value</th> <th>Description</th> </tr> </thead> <tbody> <tr> <td>0h</td> <td>Device not present or communication not established</td> </tr> <tr> <td>1h</td> <td>Interface in active state</td> </tr> <tr> <td>2h</td> <td>Interface in PARTIAL power management state</td> </tr> <tr> <td>6h</td> <td>Interface in SLUMBER power management state</td> </tr> </tbody> </table> <p>All other values reserved.</p> | Value | Description | 0h | Device not present or communication not established | 1h | Interface in active state | 2h | Interface in PARTIAL power management state | 6h | Interface in SLUMBER power management state |
| Value | Description | | | | | | | | | | |
| 0h | Device not present or communication not established | | | | | | | | | | |
| 1h | Interface in active state | | | | | | | | | | |
| 2h | Interface in PARTIAL power management state | | | | | | | | | | |
| 6h | Interface in SLUMBER power management state | | | | | | | | | | |
| 7:4 | <p>Current Interface Speed (SPD) — RO. Indicates the negotiated interface communication speed.</p> <table border="1"> <thead> <tr> <th>Value</th> <th>Description</th> </tr> </thead> <tbody> <tr> <td>0h</td> <td>Device not present or communication not established</td> </tr> <tr> <td>1h</td> <td>Generation 1 communication rate negotiated</td> </tr> <tr> <td>2h</td> <td>Generation 2 communication rate negotiated</td> </tr> </tbody> </table> <p>All other values reserved.</p> <p>ICH10 Supports Generation 1 communication rates (1.5 Gb/s) and Gen 2 rates (3.0 Gb/s).</p> | Value | Description | 0h | Device not present or communication not established | 1h | Generation 1 communication rate negotiated | 2h | Generation 2 communication rate negotiated | | |
| Value | Description | | | | | | | | | | |
| 0h | Device not present or communication not established | | | | | | | | | | |
| 1h | Generation 1 communication rate negotiated | | | | | | | | | | |
| 2h | Generation 2 communication rate negotiated | | | | | | | | | | |
| 3:0 | <p>Device Detection (DET) — RO. Indicates the interface device detection and Phy state:</p> <table border="1"> <thead> <tr> <th>Value</th> <th>Description</th> </tr> </thead> <tbody> <tr> <td>0h</td> <td>No device detected and Phy communication not established</td> </tr> <tr> <td>1h</td> <td>Device presence detected but Phy communication not established</td> </tr> <tr> <td>3h</td> <td>Device presence detected and Phy communication established</td> </tr> <tr> <td>4h</td> <td>Phy in offline mode as a result of the interface being disabled or running in a BIST loopback mode</td> </tr> </tbody> </table> <p>All other values reserved.</p> | Value | Description | 0h | No device detected and Phy communication not established | 1h | Device presence detected but Phy communication not established | 3h | Device presence detected and Phy communication established | 4h | Phy in offline mode as a result of the interface being disabled or running in a BIST loopback mode |
| Value | Description | | | | | | | | | | |
| 0h | No device detected and Phy communication not established | | | | | | | | | | |
| 1h | Device presence detected but Phy communication not established | | | | | | | | | | |
| 3h | Device presence detected and Phy communication established | | | | | | | | | | |
| 4h | Phy in offline mode as a result of the interface being disabled or running in a BIST loopback mode | | | | | | | | | | |



14.3.2.3 PxSERR—Serial ATA Error Register (D31:F2)

Address Offset: Attribute: R/WC
 Default Value: 00000000h Size: 32 bits

SDATA when SINDx.RIDX is 02h.

Bits 26:16 of this register contains diagnostic error information for use by diagnostic software in validating correct operation or isolating failure modes. Bits 11:0 contain error information used by host software in determining the appropriate response to the error condition. If one or more of bits 11:8 of this register are set, the controller will stop the current transfer.

| Bit | Description |
|-------|-------------------------------------------------------------------------------------------------------------------------------------------------------------------------------------------------------------------------------------------------------------------------------------------------------------------------------------------------------------------------------------------------------------------|
| 31:27 | Reserved |
| 26 | Exchanged (X) : When set to one this bit indicates that a change in device presence has been detected since the last time this bit was cleared. This bit shall always be set to 1 anytime a COMINIT signal is received. This bit is reflected in the POIS.PCS bit. |
| 25 | Unrecognized FIS Type (F) : Indicates that one or more FISs were received by the Transport layer with good CRC, but had a type field that was not recognized. |
| 24 | Transport state transition error (T) : Indicates that an error has occurred in the transition from one state to another within the Transport layer since the last time this bit was cleared. |
| 23 | Transport state transition error (T) : Indicates that an error has occurred in the transition from one state to another within the Transport layer since the last time this bit was cleared. |
| 22 | Handshake (H) : Indicates that one or more R_ERR handshake response was received in response to frame transmission. Such errors may be the result of a CRC error detected by the recipient, a disparity or 8b/10b decoding error, or other error condition leading to a negative handshake on a transmitted frame. |
| 21 | CRC Error (C) : Indicates that one or more CRC errors occurred with the Link Layer. |
| 20 | Disparity Error (D) : This field is not used by AHCI. |
| 19 | 10b to 8b Decode Error (B) : Indicates that one or more 10b to 8b decoding errors occurred. |
| 18 | Comm Wake (W) : Indicates that a Comm Wake signal was detected by the Phy. |
| 17 | Phy Internal Error (I) : Indicates that the Phy detected some internal error. |
| 16 | PhyRdy Change (N) : When set to 1 this bit indicates that the internal PhyRdy signal changed state since the last time this bit was cleared. In the ICH10, this bit will be set when PhyRdy changes from a 0 -> 1 or a 1 -> 0. The state of this bit is then reflected in the PxIS.PRCs interrupt status bit and an interrupt will be generated if enabled. Software clears this bit by writing a 1 to it. |
| 15:12 | Reserved |
| 11 | Internal Error (E) : The SATA controller failed due to a master or target abort when attempting to access system memory. |
| 10 | Protocol Error (P) : A violation of the Serial ATA protocol was detected. Note: The ICH10 does not set this bit for all protocol violations that may occur on the SATA link. |



| Bit | Description |
|-----|--------------------------------------------------------------------------------------------------------------------------------------------------------------------------------------------------------------------------------------------------------------------------------------------------------------------------------------------|
| 9 | Persistent Communication or Data Integrity Error (C) : A communication error that was not recovered occurred that is expected to be persistent. Persistent communications errors may arise from faulty interconnect with the device, from a device that has been removed or has failed, or a number of other causes. |
| 8 | Transient Data Integrity Error (T) : A data integrity error occurred that was not recovered by the interface. |
| 7:2 | Reserved. |
| 1 | Recovered Communications Error (M) : Communications between the device and host was temporarily lost but was re-established. This can arise from a device temporarily being removed, from a temporary loss of Phy synchronization, or from other causes and may be derived from the PhyNRdy signal between the Phy and Link layers. |
| 0 | Recovered Data Integrity Error (I) : A data integrity error occurred that was recovered by the interface through a retry operation or other recovery action. |

14.4 AHCI Registers (D31:F2)

Note: These registers are AHCI-specific and available when the ICH10 is properly configured. The Serial ATA Status, Control, and Error registers are special exceptions and may be accessed on all ICH10 components if properly configured; see [Section 14.3](#) for details.

The memory mapped registers within the SATA controller exist in non-cacheable memory space. Additionally, locked accesses are not supported. If software attempts to perform locked transactions to the registers, indeterminate results may occur. Register accesses shall have a maximum size of 64-bits; 64-bit access must not cross an 8-byte alignment boundary. All memory registers are reset by Function Level Reset unless specified otherwise.

The registers are broken into two sections – generic host control and port control. The port control registers are the same for all ports, and there are as many registers banks as there are ports.

Table 14-3. AHCI Register Address Map

| ABAR + Offset | Mnemonic | Register |
|---------------|----------|-------------------------------|
| 00–1Fh | GHC | Generic Host Control |
| 20h–FFh | — | Reserved |
| 100h–17Fh | POPCR | Port 0 port control registers |
| 180h–1FFh | P1PCR | Port 1 port control registers |
| 200h–27Fh | P2PCR | Port 2 port control registers |
| 280h–2FFh | P3PCR | Port 3 port control registers |
| 300h–37Fh | P4PCR | Port 4 port control registers |
| 380h–3FFh | P5PCR | Port 5 port control registers |

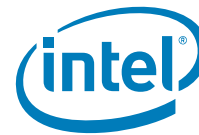

14.4.1 AHCI Generic Host Control Registers (D31:F2)

Table 14-4. Generic Host Controller Register Address Map

| ABAR + Offset | Mnemonic | Register | Default | Type |
|---------------|-----------|---------------------------------------|-----------|---------------|
| 00–03 | CAP | Host Capabilities | FF22FFC2h | R/WO, RO |
| 04–07 | GHC | Global ICH10 Control | 00000000h | R/W, RO |
| 08–0Bh | IS | Interrupt Status | 00000000h | R/WC |
| 0Ch–0Fh | PI | Ports Implemented | 00000000h | R/WO, RO |
| 10h–13h | VS | AHCI Version | 00010200h | RO |
| 14h–17h | CCC_CTL | Command Completion Coalescing Control | 00010121h | R/W, RO |
| 18h–1Bh | CCC_PORTS | Command Completion Coalescing Ports | 00000000h | R/W |
| 1Ch–1Fh | EM_LOC | Enclosure Management Location | 01000002h | RO |
| 20h–23h | EM_CTRL | Enclosure Management Control | 07010000h | R/W, R/WO, RO |
| A0h–A3h | VSP | Vendor Specific | 00000000h | RO, R/WO |

14.4.1.1 CAP—Host Capabilities Register (D31:F2)

Address Offset: ABAR + 00h–03h Attribute: R/WO, RO
 Default Value: FF22FFC2h (Consumer Only) Size: 32 bits
 FF22FF45h (Corporate Only)
 Function Level Reset: No

All bits in this register that are R/WO are reset only by PLTRST#.

| Bit | Description |
|-----|-----------------------------------------------------------------------------------------------------------------------------------------------------------------------------------------------------------------------------------------------------------------------------------------------------------------------------------|
| 31 | Supports 64-bit Addressing (S64A) — RO. Indicates that the SATA controller can access 64-bit data structures. The 32-bit upper bits of the port DMA Descriptor, the PRD Base, and each PRD entry are read/write. |
| 30 | Supports Command Queue Acceleration (SCQA) — RO. Hardwired to 1 to indicate that the SATA controller supports SATA command queuing via the DMA Setup FIS. The Intel® ICH10 handles DMA Setup FISes natively, and can handle auto-activate optimization through that FIS. |
| 29 | Supports SNotification Register (SSNTF): — RO. The ICH10 SATA Controller does not support the SNotification register. |
| 28 | Supports Interlock Switch (SIS) — R/WO. Indicates whether the SATA controller supports interlock switches on its ports for use in Hot Plug operations. This value is loaded by platform BIOS prior to OS initialization. If this bit is set, BIOS must also map the SATAGP pins to the SATA controller through GPIO space. |
| 27 | Supports Staggered Spin-up (SSS) — R/WO. Indicates whether the SATA controller supports staggered spin-up on its ports, for use in balancing power spikes. This value is loaded by platform BIOS prior to OS initialization. 0 = Staggered spin-up not supported. 1 = Staggered spin-up supported. |



| Bit | Description |
|-----------------------|---------------------------------------------------------------------------------------------------------------------------------------------------------------------------------------------------------------------------------------------------------------------------------------------------------------------------------------------------------------|
| 26 | Supports Aggressive Link Power Management (SALP) — R/WO. 0 = Software shall treat the PxCMD.ALPE and PxCMD.ASP bits as reserved. 1 = The SATA controller supports auto-generating link requests to the partial or slumber states when there are no commands to process. |
| 25 | Supports Activity LED (SAL) — RO. Indicates that the SATA controller supports a single output pin (SATALED#) which indicates activity. |
| 24 | Supports Command List Override (SCLO) — R/WO. When set to 1, indicates that the Controller supports the PxCMD.CLO bit and it's associated function. When cleared to 0, the controller is not capable of clearing the BSY and DRQ bits in the Status register in order to issue a software reset if these bits are still set from a previous operation. |
| 23:20 | Interface Speed Support (ISS) — R/WO. Indicates the maximum speed the SATA controller can support on its ports. 2h = 3.0 Gb/s. |
| 19 | Supports Non-Zero DMA Offsets (SNZO) — RO. Reserved, as per the AHCI Revision 1.2 specification |
| 18 | Supports AHCI Mode Only (SAM) — RO. The SATA controller may optionally support AHCI access mechanism only. 0 = SATA controller supports both IDE and AHCI Modes 1 = SATA controller supports AHCI Mode Only |
| 17 | Supports Port Multiplier (PMS) — R/WO. ICH10 does not support port multiplier. NOTE: This bit must be set to 0. Port multiplier is not supported by ICH10. |
| 16 | Reserved |
| 15 | PIO Multiple DRQ Block (PMD) — RO. The SATA controller supports PIO Multiple DRQ Command Block |
| 14 | Slumber State Capable (SSC) — R/WO. The SATA controller supports the slumber state. |
| 13 | Partial State Capable (PSC) — R/WO. The SATA controller supports the partial state. |
| 12:8 | Number of Command Slots (NCS) — RO. Hardwired to 1Fh to indicate support for 32 slots. |
| 7 (Consumer Only) | Command Completion Coalescing Supported (CCCS) — R/WO. 0 = Command Completion Coalescing Not Supported 1 = Command Completion Coalescing Supported |
| 7 (Corporate Only) | Command Completion Coalescing Supported (CCCS) — RO. Command Completion Coalescing is not supported. Reads to this bit return 0. |
| 6 | Enclosure Management Supported (EMS) — R/WO. 0 = Enclosure Management Not Supported 1 = Enclosure Management Supported |
| 5 | Supports External SATA (SXS) — R/WO. 0 = External SATA is not supported on any ports 1 = External SATA is supported on one or more ports When set, SW can examine each SATA port's Command Register (PxCMD) to determine which port is routed externally. |
| 4:0 | Number of Ports (NPS) — RO. Hardwired to 5h to indicate support for 6 ports. Note that the number of ports indicated in this field may be more than the number of ports indicated in the PI (ABAR + 0Ch) register. |



14.4.1.2 GHC—Global ICH10 Control Register (D31:F2)

Address Offset: ABAR + 04h–07h Attribute: R/W, RO
 Default Value: 00000000h Size: 32 bits

| Bit | Description |
|------|--------------------------------------------------------------------------------------------------------------------------------------------------------------------------------------------------------------------------------------------------------------------------------------------------------------------------------------------------------------------------------------------------------------------------------------------------------------------------------------------------------------------------------------------------------------------------------------------------------------------------------------------------------------------------------------------------------------------------------------------------------------------------------------------------------------------------------------------------------------------------------------------------------------------------------------------------------------------------------------------------------------------------------------------------------------------------------------------------------------------------------------------------------------------------------------------------------------------------------------------------------------------------------------------------------------------------------------------------------------------------|
| 31 | <p>AHCI Enable (AE) — R/W. When set, indicates that an AHCI driver is loaded and the controller will be talked to via AHCI mechanisms. This can be used by an ICH10 that supports both legacy mechanisms (such as SFF-8038i) and AHCI to know when the controller will not be talked to as legacy.</p> <p>0 = Software will communicate with the ICH10 using legacy mechanisms. 1 = Software will communicate with the ICH10 using AHCI. The ICH10 will not have to allow command processing via both AHCI and legacy mechanisms.</p> <p>Software shall set this bit to 1 before accessing other AHCI registers.</p> |
| 30:3 | Reserved |
| 2 | <p>MSI Revert to Single Message (MRSM) — RO: When set to 1 by hardware, indicates that the host controller requested more than one MSI vector but has reverted to using the first vector only. When this bit is cleared to '0', the Controller has not reverted to single MSI mode (i.e. hardware is already in single MSI mode, software has allocated the number of messages requested, or hardware is sharing interrupt vectors if MC.MME < MC.MMC).</p> <p>"MC.MSIE = '1' (MSI is enabled) "MC.MMC > 0 (multiple messages requested) "MC.MME > 0 (more than one message allocated) "MC.MME! = MC.MMC (messages allocated not equal to number requested)</p> <p>When this bit is set to 1, single MSI mode operation is in use and software is responsible for clearing bits in the IS register to clear interrupts.</p> <p>This bit shall be cleared to 0 by hardware when any of the four conditions stated is false. This bit is also cleared to 0 when MC.MSIE = 1 and MC.MME = 0h. In this case, the hardware has been programmed to use single MSI mode, and is not "reverting" to that mode.</p> <p>For ICH10, the Controller shall always revert to single MSI mode when the number of vectors allocated by the host is less than the number requested. This bit is ignored when GHC.HR = 1.</p> |
| 1 | <p>Interrupt Enable (IE) — R/W. This global bit enables interrupts from the ICH10.</p> <p>0 = All interrupt sources from all ports are disabled. 1 = Interrupts are allowed from the AHCI controller.</p> |
| 0 | <p>Controller Reset (HR) — R/W. Resets ICH10 AHCI controller.</p> <p>0 = No effect 1 = When set by SW, this bit causes an internal reset of the ICH10 AHCI controller. All state machines that relate to data transfers and queuing return to an idle condition, and all ports are re-initialized via COMRESET.</p> <p>NOTE: For further details, consult section 12.3.3 of the <i>Serial ATA Advanced Host Controller Interface</i> specification.</p> |

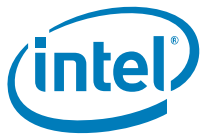

14.4.1.3 IS—Interrupt Status Register (D31:F2)

Address Offset: ABAR + 08h–0Bh Attribute: R/WC
Default Value: 00000000h Size: 32 bits

This register indicates which of the ports within the controller have an interrupt pending and require service.

| Bit | Description |
|------|------------------------------------------------------------------------------------------------------------------------------------------------------------------------------------------------------------------------------|
| 31:7 | Reserved. Returns 0. |
| 6 | Coalescing Interrupt Pending Status (CIPS) — R/WC. 0 = No interrupt pending. 1 = A command completion coalescing interrupt has been generated. |
| 5 | Interrupt Pending Status Port[5] (IPS[5]) — R/WC. 0 = No interrupt pending. 1 = Port 5 has an interrupt pending. Software can use this information to determine which ports require service after an interrupt. |
| 4 | Interrupt Pending Status Port[4] (IPS[4]) — R/WC. 0 = No interrupt pending. 1 = Port 4 has an interrupt pending. Software can use this information to determine which ports require service after an interrupt. |
| 3 | Interrupt Pending Status Port[3] (IPS[3]) — R/WC. 0 = No interrupt pending. 1 = Port 3 has an interrupt pending. Software can use this information to determine which ports require service after an interrupt. |
| 2 | Interrupt Pending Status Port[2] (IPS[2]) — R/WC. 0 = No interrupt pending. 1 = Port 2 has an interrupt pending. Software can use this information to determine which ports require service after an interrupt. |
| 1 | Interrupt Pending Status Port[1] (IPS[1]) — R/WC. 0 = No interrupt pending. 1 = Port 1 has an interrupt pending. Software can use this information to determine which ports require service after an interrupt. |
| 0 | Interrupt Pending Status Port[0] (IPS[0]) — R/WC. 0 = No interrupt pending. 1 = Port 0 has an interrupt pending. Software can use this information to determine which ports require service after an interrupt. |



14.4.1.4 PI—Ports Implemented Register (D31:F2)

Address Offset: ABAR + 0Ch–0Fh Attribute: R/WO, RO
 Default Value: 00000000h Size: 32 bits
 Function Level Reset: No

This register indicates which ports are exposed to the ICH10. It is loaded by platform BIOS. It indicates which ports that the device supports are available for software to use. For ports that are not available, software must not read or write to registers within that port.

| Bit | Description |
|------|--------------------------------------------------------------------------------------------------------------------------------------------------------------------------------|
| 31:6 | Reserved. Returns 0. |
| 5 | Ports Implemented Port 5 (PI5) — R/WO. 0 = The port is not implemented. 1 = The port is implemented. This bit is read-only '0' if MAP.SC = '0' or SCC = '01h'. |
| 4 | Ports Implemented Port 4 (PI4) — R/WO. 0 = The port is not implemented. 1 = The port is implemented. This bit is read-only '0' if MAP.SC = '0' or SCC = '01h'. |
| 3 | Ports Implemented Port 3 (PI3) — R/WO. 0 = The port is not implemented. 1 = The port is implemented. |
| 2 | Ports Implemented Port 2 (PI2) — R/WO. 0 = The port is not implemented. 1 = The port is implemented. |
| 1 | Ports Implemented Port 1 (PI1) — R/WO. 0 = The port is not implemented. 1 = The port is implemented. |
| 0 | Ports Implemented Port 0 (PI0) — R/WO. 0 = The port is not implemented. 1 = The port is implemented. |



14.4.1.5 VS—AHCI Version (D31:F2)

Address Offset: ABAR + 10h–13h Attribute: RO
 Default Value: 00010200h Size: 32 bits

This register indicates the major and minor version of the AHCI specification. It is BCD encoded. The upper two bytes represent the major version number, and the lower two bytes represent the minor version number. Example: Version 3.12 would be represented as 00030102h. The current version of the specification is 1.20 (00010200h).

| Bit | Description |
|-------|----------------------------------------------------------------------------|
| 31:16 | Major Version Number (MJR) — RO. Indicates the major version is 1 |
| 15:0 | Minor Version Number (MNR) — RO. Indicates the minor version is 20. |

14.4.1.6 CCC_CTL—Command Completion Coalescing Control Register (D31:F2)

Address Offset: ABAR + 14h–17h Attribute: R/W, RO
 Default Value: 00010131h Size: 32 bits

This register is used to configure the command coalescing feature. This register is reserved if command coalescing is not supported (CAP_CCCS = '0').

| Bit | Description |
|-------|------------------------------------------------------------------------------------------------------------------------------------------------------------------------------------------------------------------------------------------------------------------------------------------------------------------------------------------------------------------------------------------------------------------------------------------------------------------------------------------------------------------------------------------------------------------------------------------------------------------------------------------------------------------------------------------|
| 31:16 | Timeout Value (TV) — R/W. The timeout value is specified in 10 microsecond intervals. hbaCCC_Timer is loaded with this timeout value. hbaCCC_Timer is only decremented when commands are outstanding on the selected ports. The Controller will signal a CCC interrupt when hbaCCC_Timer has decremented to '0'. The hbaCCC_Timer is reset to the timeout value on the assertion of each CCC interrupt. A timeout value of 0 is invalid. |
| 15:8 | Command Completions (CC) — R/W. Specifies the number of command completions that are necessary to cause a CCC interrupt. The Controller has an internal command completion counter, hbaCCC_CommandsComplete. hbaCCC_CommandsComplete is incremented by one each time a selected port has a command completion. When hbaCCC_CommandsComplete is equal to the command completions value, a CCC interrupt is signaled. The internal command completion counter is reset to '0' on the assertion of each CCC interrupt. |
| 7:3 | Interrupt (INT) — RO. Specifies the interrupt used by the CCC feature. This interrupt must be marked as unused in the AHCI Ports Implemented memory register by the corresponding bit being set to '0'. Thus, the CCC_interrupt corresponds to the interrupt for an unimplemented port on the controller. When a CCC interrupt occurs, the IS[INT] bit shall be asserted to '1' regardless of whether PIRQ interrupt or MSI is used. Note that in MSI, CC interrupt may share an interrupt vector with other ports. For example, if the number of message allocated is 4, then CCC interrupt share interrupt vector 3 along with port 3, 4, and 5 but IS[6] shall get set. |
| 2:1 | Reserved |
| 0 | Enable (EN) — R/W. 0 = The command completion coalescing feature is disabled and no CCC interrupts are generated 1 = The command completion coalescing feature is enabled and CCC interrupts may be generated based on timeout or command completion conditions. Software shall only change the contents of the TV and CC fields when EN is cleared to '0'. On transition of this bit from '0' to '1', any updated values for the TV and CC fields shall take effect. |



14.4.1.7 CCC_Ports—Command Completion Coalescing Ports Register (D31:F2)

Address Offset: ABAR + 18h–1Bh Attribute: R/W
 Default Value: 00000000h Size: 32 bits

This register is used to specify the ports that are coalesced as part of the CCC feature when CCC_CTL.EN = '1'. This register is reserved if command coalescing is not supported (CAP_CCCS = '0').

| Bit | Description |
|------|----------------------------------------------------------------------------------------------------------------------------------------------------------------------------------------------------------------------------------------------------------------------------------------------------------------------------------------------------------------------------------------------------------------------------------------------------------------------------------------------------------------------------------------------------------------------------|
| 31:0 | <p>Ports (PRT) — R/W.</p> <p>0 = The port is not part of the command completion coalescing feature. 1 = The corresponding port is part of the command completion coalescing feature. Bits set to '1' in this register must also have the corresponding bit set to '1' in the Ports Implemented register.</p> <p>Bits set to '1' in this register must also have the corresponding bit set to '1' in the Ports Implemented register. An updated value for this field shall take effect within one timer increment (1 millisecond).</p> |

14.4.1.8 EM_LOC—Enclosure Management Location Register (D31:F2)

Address Offset: ABAR + 1Ch–1Fh Attribute: RO
 Default Value: 01000002h Size: 32 bits

This register identifies the location and size of the enclosure management message buffer. This register is reserved if enclosure management is not supported (i.e., CAP.EMS = 0).

| Bit | Description |
|-------|-----------------------------------------------------------------------------------------------------------------------------------------------------------------------------------------------------------|
| 31:16 | <p>Offset (OFST) — RO. The offset of the message buffer in Dwords from the beginning of the ABAR.</p> |
| 15:0 | <p>Buffer Size (SZ) — RO. Specifies the size of the transmit message buffer area in Dwords. The ICH10 SATA controller only supports transmit buffer. A value of '0' is invalid.</p> |



14.4.1.9 EM_CTRL—Enclosure Management Control Register (D31:F2)

Address Offset: ABAR + 20h–23h Attribute: R/W, R/WO, RO
 Default Value: 07010000h Size: 32 bits

This register is used to control and obtain status for the enclosure management interface. This register includes information on the attributes of the implementation, enclosure management messages supported, the status of the interface, whether any message are pending, and is used to initiate sending messages. This register is reserved if enclosure management is not supported (CAP_EMS = '0').

| Bit | Description |
|-------|---------------------------------------------------------------------------------------------------------------------------------------------------------------------------------------------------------------------------------------------------------------------------------------------------------------------------------------------------------------------------------------------------------------------|
| 31:27 | Reserved |
| 26 | Activity LED Hardware Driven (ATTR.ALHD) — R/WO. 1 = The SATA controller drives the activity LED for the LED message type in hardware and does not utilize software for this LED. The host controller does not begin transmitting the hardware based activity signal until after software has written CTL.TM=1 after a reset condition. |
| 25 | Transmit Only (ATTR.XMT) — RO. 0 = The SATA controller supports transmitting and receiving messages. 1 = The SATA controller only supports transmitting messages and does not support receiving messages. |
| 24 | Single Message Buffer (ATTR.SMB) — RO. 0 = There are separate receive and transmit buffers such that unsolicited messages could be supported. 1 = The SATA controller has one message buffer that is shared for messages to transmit and messages received. Unsolicited receive messages are not supported and it is software's responsibility to manage access to this buffer. |
| 23:20 | Reserved |
| 19 | SGPIO Enclosure Management Messages (SUPP.SGPIO): — RO. 1 = The SATA controller supports the SGPIO register interface message type. |
| 18 | SES-2 Enclosure Management Messages (SUPP.SES2): — RO. 1 = The SATA controller supports the SES-2 message type. |
| 17 | SAF-TE Enclosure Management Messages (SUPP.SAFTE): — RO. 1 = The SATA controller supports the SAF-TE message type. |
| 16 | LED Message Types (SUPP.LED): — RO. 1 = The SATA controller supports the LED message type. |
| 15:10 | Reserved |
| 9 | Reset (RST): — R/W. 0 = A write of '0' to this bit by software will have no effect. 1 = When set by software, The SATA controller shall reset all enclosure management message logic and take all appropriate reset actions to ensure messages can be transmitted / received after the reset. After the SATA controller completes the reset operation, the SATA controller shall set the value to '0'. |
| 8 | Transmit Message (CTL.TM): — R/W. 0 = A write of '0' to this bit by software will have no effect. 1 = When set by software, The SATA controller shall transmit the message contained in the message buffer. When the message is completely sent, the SATA controller shall set the value to '0'. Software shall not change the contents of the message buffer while CTL.TM is set to '1'. |
| 7:1 | Reserved |
| 0 | Message Received (STS.MR): — RO. Message Received is not supported in ICH10. |



14.4.2 Vendor Specific Registers (D31:F2)

14.4.2.1 VSP—Vendor Specific (D31:F2)

Address Offset: ABAR + A0h–A3h Attribute: RO, RWO
 Default Value: 00000000h Size: 32 bits

| Bit | Description |
|------|----------------------------------------------------------------------------------------------------------------------------------------------------------------------------------|
| 31:1 | Reserved |
| 0 | Supports Low Power Device Detection (SLPD) — RWO Indicates whether SATA power management and device hot (un)pulg is supported. 0 = Not supported. 1 = Supported. |

14.4.3 Port Registers (D31:F2)

Ports not available will result in the corresponding Port DMA register space being reserved. The controller shall ignore writes to the reserved space on write cycles and shall return '0' on read cycle accesses to the reserved location.

Table 14-5. Port [5:0] DMA Register Address Map (Sheet 1 of 3)

| ABAR + Offset | Mnemonic | Register |
|---------------|----------|------------------------------------------------|
| 100h–103h | POCLB | Port 0 Command List Base Address |
| 104h–107h | POCLBU | Port 0 Command List Base Address Upper 32-Bits |
| 108h–10Bh | POFB | Port 0 FIS Base Address |
| 10Ch–10Fh | POFBU | Port 0 FIS Base Address Upper 32-Bits |
| 110h–113h | POIS | Port 0 Interrupt Status |
| 114h–117h | POIE | Port 0 Interrupt Enable |
| 118h–11Bh | POCMD | Port 0 Command |
| 11Ch–11Fh | — | Reserved |
| 120h–123h | POTFD | Port 0 Task File Data |
| 124h–127h | POSIG | Port 0 Signature |
| 128h–12Bh | POSSTS | Port 0 Serial ATA Status |
| 12Ch–12Fh | POSCTL | Port 0 Serial ATA Control |
| 130h–133h | POSERR | Port 0 Serial ATA Error |
| 134h–137h | POSACT | Port 0 Serial ATA Active |
| 138h–13Bh | POCI | Port 0 Command Issue |
| 13Ch–17Fh | — | Reserved |
| 180h–183h | P1CLB | Port 1 Command List Base Address |
| 184h–187h | P1CLBU | Port 1 Command List Base Address Upper 32-Bits |
| 188h–18Bh | P1FB | Port 1 FIS Base Address |
| 18Ch–18Fh | P1FBU | Port 1 FIS Base Address Upper 32-Bits |
| 190h–193h | P1IS | Port 1 Interrupt Status |
| 194h–197h | P1IE | Port 1 Interrupt Enable |
| 198h–19Bh | P1CMD | Port 1 Command |
| 19Ch–19Fh | — | Reserved |
| 1A0h–1A3h | P1TFD | Port 1 Task File Data |
| 1A4h–1A7h | P1SIG | Port 1 Signature |

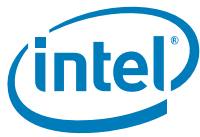

Table 14-5. Port [5:0] DMA Register Address Map (Sheet 2 of 3)

| ABAR + Offset | Mnemonic | Register |
|---------------|----------|------------------------------------------------|
| 1A8h–1ABh | P1SSTS | Port 1 Serial ATA Status |
| 1ACh–1AFh | P1SCTL | Port 1 Serial ATA Control |
| 1B0h–1B3h | P1SERR | Port 1 Serial ATA Error |
| 1B4h–1B7h | P1SACT | Port 1 Serial ATA Active |
| 1B8h–1BBh | P1CI | Port 1 Command Issue |
| 1BCh–1FFh | — | Reserved |
| 200h–203h | P2CLB | Port 2 Command List Base Address |
| 204h–207h | P2CLBU | Port 2 Command List Base Address Upper 32-Bits |
| 208h–20Bh | P2FB | Port 2 FIS Base Address |
| 20Ch–20Fh | P2FBU | Port 2 FIS Base Address Upper 32-Bits |
| 210h–213h | P2IS | Port 2 Interrupt Status |
| 214h–217h | P2IE | Port 2 Interrupt Enable |
| 218h–21Bh | P2CMD | Port 2 Command |
| 21Ch–21Fh | — | Reserved |
| 220h–223h | P2TFD | Port 2 Task File Data |
| 224h–227h | P2SIG | Port 2 Signature |
| 228h–22Bh | P2SSTS | Port 2 Serial ATA Status |
| 22Ch–22Fh | P2SCTL | Port 2 Serial ATA Control |
| 230h–233h | P2SERR | Port 2 Serial ATA Error |
| 234h–237h | P2SACT | Port 2 Serial ATA Active |
| 238h–23Bh | P2CI | Port 2 Command Issue |
| 23Ch–27Fh | — | Reserved |
| 280h–283h | P3CLB | Port 3 Command List Base Address |
| 284h–287h | P3CLBU | Port 3 Command List Base Address Upper 32-Bits |
| 288h–28Bh | P3FB | Port 3 FIS Base Address |
| 28Ch–28Fh | P3FBU | Port 3 FIS Base Address Upper 32-Bits |
| 290h–293h | P3IS | Port 3 Interrupt Status |
| 294h–297h | P3IE | Port 3 Interrupt Enable |
| 298h–29Bh | P3CMD | Port 3 Command |
| 29Ch–29Fh | — | Reserved |
| 2A0h–2A3h | P3TFD | Port 3 Task File Data |
| 2A4h–2A7h | P3SIG | Port 3 Signature |
| 2A8h–2ABh | P3SSTS | Port 3 Serial ATA Status |
| 2ACh–2AFh | P3SCTL | Port 3 Serial ATA Control |
| 2B0h–2B3h | P3SERR | Port 3 Serial ATA Error |
| 2B4h–2B7h | P3SACT | Port 3 Serial ATA Active |
| 2B8h–2BBh | P3CI | Port 3 Command Issue |
| 2BCh–2FFh | — | Reserved |
| 300h–303h | P4CLB | Port 4 Command List Base Address |
| 304h–307h | P4CLBU | Port 4 Command List Base Address Upper 32-Bits |
| 308h–30Bh | P4FB | Port 4 FIS Base Address |
| 30Ch–30Fh | P4FBU | Port 4 FIS Base Address Upper 32-Bits |
| 310h–313h | P4IS | Port 4 Interrupt Status |
| 314h–317h | P4IE | Port 4 Interrupt Enable |
| 318h–31Bh | P4CMD | Port 4 Command |
| 31Ch–31Fh | — | Reserved |
| 320h–323h | P4TFD | Port 4 Task File Data |



Table 14-5. Port [5:0] DMA Register Address Map (Sheet 3 of 3)

| ABAR + Offset | Mnemonic | Register |
|---------------|----------|------------------------------------------------|
| 324h–327h | P4SIG | Port 4 Signature |
| 328h–32Bh | P4SSTS | Port 4 Serial ATA Status |
| 32Ch–32Fh | P4SCTL | Port 4 Serial ATA Control |
| 330h–333h | P4SERR | Port 4 Serial ATA Error |
| 334h–337h | P4SACT | Port 4 Serial ATA Active |
| 338h–33Bh | P4CI | Port 4 Command Issue |
| 33Ch–37Fh | — | Reserved |
| 380h–383h | P5CLB | Port 5 Command List Base Address |
| 384h–387h | P5CLBU | Port 5 Command List Base Address Upper 32-Bits |
| 388h–38Bh | P5FB | Port 5 FIS Base Address |
| 38Ch–38Fh | P5FBU | Port 5 FIS Base Address Upper 32-Bits |
| 390h–393h | P5IS | Port 5 Interrupt Status |
| 394h–397h | P5IE | Port 5 Interrupt Enable |
| 398h–39Bh | P5CMD | Port 5 Command |
| 39Ch–39Fh | — | Reserved |
| 3A0h–3A3h | P5TFD | Port 5 Task File Data |
| 3A4h–3A7h | P5SIG | Port 5 Signature |
| 3A8h–3ABh | P5SSTS | Port 5 Serial ATA Status |
| 3ACh–3AFh | P5SCTL | Port 5 Serial ATA Control |
| 3B0h–3B3h | P5SERR | Port 5 Serial ATA Error |
| 3B4h–3B7h | P5SACT | Port 5 Serial ATA Active |
| 3B8h–3BBh | P5CI | Port 5 Command Issue |
| 3BCh–3FFh | — | Reserved |

14.4.3.1 PxCLB—Port [5:0] Command List Base Address Register (D31:F2)

Address Offset: Port 0: ABAR + 100h Attribute: R/W
 Port 1: ABAR + 180h
 Port 2: ABAR + 200h
 Port 3: ABAR + 280h
 Port 4: ABAR + 300h
 Port 5: ABAR + 380h

Default Value: Undefined Size: 32 bits

| Bit | Description |
|-------|--------------------------------------------------------------------------------------------------------------------------------------------------------------------------------------------------------------------------------------------------------------------------------------------------------------------------------------------------------------------------------|
| 31:10 | Command List Base Address (CLB) — R/W. Indicates the 32-bit base for the command list for this port. This base is used when fetching commands to execute. The structure pointed to by this address range is 1 KB in length. This address must be 1-KB aligned as indicated by bits 31:10 being read/write. Note that these bits are not reset on a Controller reset. |
| 9:0 | Reserved |



14.4.3.2 PxCLBU—Port [5:0] Command List Base Address Upper 32-Bits Register (D31:F2)

Address Offset: Port 0: ABAR + 104h Attribute: R/W
Port 1: ABAR + 184h
Port 2: ABAR + 204h
Port 3: ABAR + 284h
Port 4: ABAR + 304h
Port 5: ABAR + 384h
Default Value: Undefined Size: 32 bits

| Bit | Description |
|------|-----------------------------------------------------------------------------------------------------------------------------------------------------------------------------------------------------------------------------------------------------|
| 31:0 | Command List Base Address Upper (CLBU) — R/W. Indicates the upper 32-bits for the command list base address for this port. This base is used when fetching commands to execute. Note that these bits are not reset on a Controller reset. |

14.4.3.3 PxFB—Port [5:0] FIS Base Address Register (D31:F2)

Address Offset: Port 0: ABAR + 108h Attribute: R/W
Port 1: ABAR + 188h
Port 2: ABAR + 208h
Port 3: ABAR + 288h
Port 4: ABAR + 308h
Port 5: ABAR + 388h
Default Value: Undefined Size: 32 bits

| Bit | Description |
|------|----------------------------------------------------------------------------------------------------------------------------------------------------------------------------------------------------------------------------------------------------------------------------------------------------------|
| 31:8 | FIS Base Address (FB) — R/W. Indicates the 32-bit base for received FISes. The structure pointed to by this address range is 256 bytes in length. This address must be 256-byte aligned, as indicated by bits 31:3 being read/write. Note that these bits are not reset on a Controller reset. |
| 7:0 | Reserved |

14.4.3.4 PxFBU—Port [5:0] FIS Base Address Upper 32-Bits Register (D31:F2)

Address Offset: Port 0: ABAR + 10Ch Attribute: R/W
Port 1: ABAR + 18Ch
Port 2: ABAR + 20Ch
Port 3: ABAR + 28Ch
Port 4: ABAR + 30Ch
Port 5: ABAR + 38Ch
Default Value: Undefined Size: 32 bits

| Bit | Description |
|------|----------------------------------------------------------------------------------------------------------------------------------------------------------------------------------------|
| 31:0 | Command List Base Address Upper (CLBU) — R/W. Indicates the upper 32-bits for the received FIS base for this port. Note that these bits are not reset on a Controller reset. |



14.4.3.5 PxlS—Port [5:0] Interrupt Status Register (D31:F2)

Address Offset: Port 0: ABAR + 110h Attribute: R/WC, RO
 Port 1: ABAR + 190h
 Port 2: ABAR + 210h
 Port 3: ABAR + 290h
 Port 4: ABAR + 310h
 Port 5: ABAR + 390h
 Default Value: 00000000h Size: 32 bits

| Bit | Description |
|------|-------------------------------------------------------------------------------------------------------------------------------------------------------------------------------------------------------------------------------------------------------------------------------------------------------------------------------------------------------------------------------------------------------------------------------------------------------------------------------------------------------------------------------------------------------------------------------------------------------------|
| 31 | Cold Port Detect Status (CPDS) — RO. Cold presence detect is not supported. |
| 30 | Task File Error Status (TFES) — R/WC. This bit is set whenever the status register is updated by the device and the error bit (PxTFD.bit 0) is set. |
| 29 | Host Bus Fatal Error Status (HBFS) — R/WC. Indicates that the Intel® ICH10 encountered an error that it cannot recover from due to a bad software pointer. In PCI, such an indication would be a target or master abort. |
| 28 | Host Bus Data Error Status (HBDS) — R/WC. Indicates that the ICH10 encountered a data error (uncorrectable ECC / parity) when reading from or writing to system memory. |
| 27 | Interface Fatal Error Status (IFS) — R/WC. Indicates that the ICH10 encountered an error on the SATA interface which caused the transfer to stop. |
| 26 | Interface Non-fatal Error Status (INFS) — R/WC. Indicates that the ICH10 encountered an error on the SATA interface but was able to continue operation. |
| 25 | Reserved |
| 24 | Overflow Status (OFS) — R/WC. Indicates that the ICH10 received more bytes from a device than was specified in the PRD table for the command. |
| 23 | Incorrect Port Multiplier Status (IPMS) — R/WC. Indicates that the ICH10 received a FIS from a device whose Port Multiplier field did not match what was expected. NOTE: Port Multiplier not supported by ICH10. |
| 22 | PhyRdy Change Status (PRCS) — RO. When set to one indicates the internal PhyRdy signal changed state. This bit reflects the state of PxSERR.DIAG.N. Unlike most of the other bits in the register, this bit is RO and is only cleared when PxSERR.DIAG.N is cleared. Note that the internal PhyRdy signal also transitions when the port interface enters partial or slumber power management states. Partial and slumber must be disabled when Surprise Removal Notification is desired, otherwise the power management state transitions will appear as false insertion and removal events. |
| 21:8 | Reserved |
| 7 | Device Interlock Status (DIS) — R/WC. When set, indicates that a platform interlock switch has been opened or closed, which may lead to a change in the connection state of the device. This bit is only valid in systems that support an interlock switch (CAP.SIS [ABAR+00:bit 28] set). For systems that do not support an interlock switch, this bit will always be 0. |
| 6 | Port Connect Change Status (PCS) — RO. This bit reflects the state of PxSERR.DIAG.X. (ABAR+130h/1D0h/230h/2D0h, bit 26) Unlike other bits in this register, this bit is only cleared when PxSERR.DIAG.X is cleared. 0 = No change in Current Connect Status. 1 = Change in Current Connect Status. |
| 5 | Descriptor Processed (DPS) — R/WC. A PRD with the I bit set has transferred all its data. |



| Bit | Description |
|-----|----------------------------------------------------------------------------------------------------------------------------------------------------------------------------------------------------------------------------------------------------------------------------------------------------------------------------------------------------------------------------------------------------------------------------------------------------------------------------------------------------------------------------------------------|
| 4 | Unknown FIS Interrupt (UFS) — RO. When set to '1' indicates that an unknown FIS was received and has been copied into system memory. This bit is cleared to '0' by software clearing the PxSERR.DIAG.F bit to '0'. Note that this bit does not directly reflect the PxSERR.DIAG.F bit. PxSERR.DIAG.F is set immediately when an unknown FIS is detected, whereas this bit is set when the FIS is posted to memory. Software should wait to act on an unknown FIS until this bit is set to '1' or the two bits may become out of sync. |
| 3 | Set Device Bits Interrupt (SDBS) — R/WC. A Set Device Bits FIS has been received with the I bit set and has been copied into system memory. |
| 2 | DMA Setup FIS Interrupt (DSS) — R/WC. A DMA Setup FIS has been received with the I bit set and has been copied into system memory. |
| 1 | PIO Setup FIS Interrupt (PSS) — R/WC. A PIO Setup FIS has been received with the I bit set, it has been copied into system memory, and the data related to that FIS has been transferred. |
| 0 | Device to Host Register FIS Interrupt (DHRS) — R/WC. A D2H Register FIS has been received with the I bit set, and has been copied into system memory. |

14.4.3.6 PxIE—Port [5:0] Interrupt Enable Register (D31:F2)

Address Offset: Port 0: ABAR + 114h Attribute: R/W, RO
 Port 1: ABAR + 194h
 Port 2: ABAR + 214h
 Port 3: ABAR + 294h
 Port 4: ABAR + 314h
 Port 5: ABAR + 394h

Default Value: 00000000h Size: 32 bits

This register enables and disables the reporting of the corresponding interrupt to system software. When a bit is set ('1') and the corresponding interrupt condition is active, then an interrupt is generated. Interrupt sources that are disabled ('0') are still reflected in the status registers.

| Bit | Description |
|-----|---------------------------------------------------------------------------------------------------------------------------------------------------------------------------------------------------------|
| 31 | Cold Presence Detect Enable (CPDE) — RO. Cold Presence Detect is not supported. |
| 30 | Task File Error Enable (TFEE) — R/W. When set, and GHC.IE and PxTFD.STS.ERR (due to a reception of the error register from a received FIS) are set, the Intel® ICH10 will generate an interrupt. |
| 29 | Host Bus Fatal Error Enable (HBFE) — R/W. When set, and GHC.IE and PxS.HBFS are set, the ICH10 will generate an interrupt. |
| 28 | Host Bus Data Error Enable (HBDE) — R/W. When set, and GHC.IE and PxS.HBDS are set, the ICH10 will generate an interrupt. |
| 27 | Host Bus Data Error Enable (HBDE) — R/W. When set, GHC.IE is set, and PxIS.HBDS is set, the ICH10 will generate an interrupt. |
| 26 | Interface Non-fatal Error Enable (INFE) — R/W. When set, GHC.IE is set, and PxIS.INFS is set, the ICH10 will generate an interrupt. |
| 25 | Reserved |
| 24 | Overflow Error Enable (OFE) — R/W. When set, and GHC.IE and PxS.OFS are set, the ICH10 will generate an interrupt. |



| Bit | Description |
|------|-------------------------------------------------------------------------------------------------------------------------------------------------------------------------------------------------------------------------|
| 23 | Incorrect Port Multiplier Enable (IPME) — R/W. When set, and GHC.IE and PxIS.IPMS are set, the ICH10 will generate an interrupt. NOTE: Should be written as 0. Port Multiplier not supported by ICH10. |
| 22 | PhyRdy Change Interrupt Enable (PRCE) — R/W. When set, and GHC.IE is set, and PxIS.PRCS is set, the ICH10 shall generate an interrupt. |
| 21:8 | Reserved |
| 7 | Device Interlock Enable (DIE) — R/W. When set, and PxIS.DIS is set, the ICH10 will generate an interrupt. For systems that do not support an interlock switch, this bit shall be a read-only 0. |
| 6 | Port Change Interrupt Enable (PCE) — R/W. When set, and GHC.IE and PxS.PCS are set, the ICH10 will generate an interrupt. |
| 5 | Descriptor Processed Interrupt Enable (DPE) — R/W. When set, and GHC.IE and PxS.DPS are set, the ICH10 will generate an interrupt |
| 4 | Unknown FIS Interrupt Enable (UFIE) — R/W. When set, and GHC.IE is set and an unknown FIS is received, the ICH10 will generate this interrupt. |
| 3 | Set Device Bits FIS Interrupt Enable (SDBE) — R/W. When set, and GHC.IE and PxS.SDBS are set, the ICH10 will generate an interrupt. |
| 2 | DMA Setup FIS Interrupt Enable (DSE) — R/W. When set, and GHC.IE and PxS.DSS are set, the ICH10 will generate an interrupt. |
| 1 | PIO Setup FIS Interrupt Enable (PSE) — R/W. When set, and GHC.IE and PxS.PSS are set, the ICH10 will generate an interrupt. |
| 0 | Device to Host Register FIS Interrupt Enable (DHRE) — R/W. When set, and GHC.IE and PxS.DHRS are set, the ICH10 will generate an interrupt. |



14.4.3.7 PxCMD—Port [5:0] Command Register (D31:F2)

Address Offset: Port 0: ABAR + 118h Attribute: R/W, RO, R/WO
 Port 1: ABAR + 198h
 Port 2: ABAR + 218h
 Port 3: ABAR + 298h
 Port 4: ABAR + 318h
 Port 5: ABAR + 398h

Default Value: 0000w00wh Size: 32 bits
 where w = 00?0b (for?, see bit description)

Function Level Reset: No (Bit 21, 19 and 18 only)

| Bit | Description | | | | | | | | | | | | | | |
|-------|------------------------------------------------------------------------------------------------------------------------------------------------------------------------------------------------------------------------------------------------------------------------------------------------------------------------------------------------------------------------------------------------------------------------------------------------------------------------------------------------------------------------------------------------------------------------------------------------------------------------------------------------------------------------------------------------------------------------------------------------------------------------------------------------------------------------------------------------------------------------------------------------------------------------------------------------------------------------------------------------------------------------------------------------------------------------------------------------------------------------------------------------------------------------------------------------------------------------------------------------------------------------------------------------------------------------------------------------------------------------------------------------------------------------------------------------------------------------------------------------------------------------------------------------------------------------------------------------------------------------------------------------------------------------------------------------------------------------------------------------------------------------------------------------------------------------------------------------------------------------------------------------------------------------------------------------------------------------------------------------------------------------------------------|-------|------------|-------|----------|----|----------------------------------------------------------------------------------------------------------------------------------------------------------------------------------------------------|-------|----------|----|----------------------------------------------------------------------------------------------------------------------------------------------------------------------------------------------|----|--------------------------------------------------------------------------------------------|----|---------------------------------------------------------------------------------------------------------------------------------------------------------------------------------------------|
| 31:28 | <p>Interface Communication Control (ICC) — R/W. This is a four bit field which can be used to control reset and power states of the interface. Writes to this field will cause actions on the interface, either as primitives or an OOB sequence, and the resulting status of the interface will be reported in the PxSSTS register (Address offset Port 0:ABAR+124h, Port 1: ABAR+1A4h, Port 2: ABAR+224h, Port 3: ABAR+2A4h, Port 4: ABAR+224h, Port 5: ABAR+2A4h).</p> <table border="1"> <thead> <tr> <th>Value</th> <th>Definition</th> </tr> </thead> <tbody> <tr> <td>Fh–7h</td> <td>Reserved</td> </tr> <tr> <td>6h</td> <td>Slumber: This will cause the Intel® ICH10 to request a transition of the interface to the slumber state. The SATA device may reject the request and the interface will remain in its current state</td> </tr> <tr> <td>5h–3h</td> <td>Reserved</td> </tr> <tr> <td>2h</td> <td>Partial: This will cause the ICH10 to request a transition of the interface to the partial state. The SATA device may reject the request and the interface will remain in its current state.</td> </tr> <tr> <td>1h</td> <td>Active: This will cause the ICH10 to request a transition of the interface into the active</td> </tr> <tr> <td>0h</td> <td>No-Op / Idle: When software reads this value, it indicates the ICH10 is not in the process of changing the interface state or sending a device reset, and a new link command may be issued.</td> </tr> </tbody> </table> <p>When system software writes a non-reserved value other than No-Op (0h), the ICH10 will perform the action and update this field back to Idle (0h). If software writes to this field to change the state to a state the link is already in (e.g. interface is in the active state and a request is made to go to the active state), the ICH10 will take no action and return this field to Idle. NOTE: When the ALPE bit (bit 26) is set, then this register should not be set to 02h or 06h.</p> | Value | Definition | Fh–7h | Reserved | 6h | Slumber: This will cause the Intel® ICH10 to request a transition of the interface to the slumber state. The SATA device may reject the request and the interface will remain in its current state | 5h–3h | Reserved | 2h | Partial: This will cause the ICH10 to request a transition of the interface to the partial state. The SATA device may reject the request and the interface will remain in its current state. | 1h | Active: This will cause the ICH10 to request a transition of the interface into the active | 0h | No-Op / Idle: When software reads this value, it indicates the ICH10 is not in the process of changing the interface state or sending a device reset, and a new link command may be issued. |
| Value | Definition | | | | | | | | | | | | | | |
| Fh–7h | Reserved | | | | | | | | | | | | | | |
| 6h | Slumber: This will cause the Intel® ICH10 to request a transition of the interface to the slumber state. The SATA device may reject the request and the interface will remain in its current state | | | | | | | | | | | | | | |
| 5h–3h | Reserved | | | | | | | | | | | | | | |
| 2h | Partial: This will cause the ICH10 to request a transition of the interface to the partial state. The SATA device may reject the request and the interface will remain in its current state. | | | | | | | | | | | | | | |
| 1h | Active: This will cause the ICH10 to request a transition of the interface into the active | | | | | | | | | | | | | | |
| 0h | No-Op / Idle: When software reads this value, it indicates the ICH10 is not in the process of changing the interface state or sending a device reset, and a new link command may be issued. | | | | | | | | | | | | | | |
| 27 | <p>Aggressive Slumber / Partial (ASP) — R/W. When set, and the ALPE bit (bit 26) is set, the ICH10 shall aggressively enter the slumber state when it clears the PxCI register and the PxSACT register is cleared. When cleared, and the ALPE bit is set, the ICH10 will aggressively enter the partial state when it clears the PxCI register and the PxSACT register is cleared. If CAP.SALP is cleared to '0', software shall treat this bit as reserved.</p> | | | | | | | | | | | | | | |
| 26 | <p>Aggressive Link Power Management Enable (ALPE) — R/W. When set, the ICH10 will aggressively enter a lower link power state (partial or slumber) based upon the setting of the ASP bit (bit 27).</p> | | | | | | | | | | | | | | |



| Bit | Description |
|-------|------------------------------------------------------------------------------------------------------------------------------------------------------------------------------------------------------------------------------------------------------------------------------------------------------------------------------------------------------------------------------------------------------------------------------------------------------------------------------------------------------------------------------------------------------------------------------------------------------------------------------------------------------------------------------------------------------------------------------------------------------------------------------------------------------------------------------------------------------|
| 25 | Drive LED on ATAPI Enable (DLAE) — R/W. When set, the ICH10 will drive the LED pin active for ATAPI commands (PxCLB[CHz.A] set) in addition to ATA commands. When cleared, the ICH10 will only drive the LED pin active for ATA commands. See Section 5.16.9 for details on the activity LED. |
| 24 | Device is ATAPI (ATAPI) — R/W. When set, the connected device is an ATAPI device. This bit is used by the ICH10 to control whether or not to generate the desktop LED when commands are active. See Section 5.16.9 for details on the activity LED. |
| 23:22 | Reserved |
| 21 | External SATA Port (ESP) — R/WO. 0 = This port supports internal SATA devices only. 1 = This port will be used with an external SATA device and hot plug is supported. When set, CAP.SXS must also be set. This bit is not reset by Function Level Reset. |
| 20 | Reserved |
| 19 | Interlock Switch Attached to Port (ISP) — R/WO. When interlock switches are supported in the platform (CAP.SIS [ABAR+00h:bit 28] set), this indicates whether this particular port has an interlock switch attached. This bit can be used by system software to enable such features as aggressive power management, as disconnects can always be detected regardless of PHY state with an interlock switch. When this bit is set, it is expected that HPCP (bit 18) in this register is also set. The ICH10 takes no action on the state of this bit – it is for system software only. For example, if this bit is cleared, and an interlock switch toggles, the ICH10 still treats it as a proper interlock switch event. Note that these bits are not reset on a Controller reset. This bit is not reset by Function Level Reset. |
| 18 | Hot Plug Capable Port (HPCP) — R/WO. 0 = Port is not capable of Hot-Plug. 1 = Port is Hot-Plug capable. This indicates whether the platform exposes this port to a device which can be Hot-Plugged. SATA by definition is hot-pluggable, but not all platforms are constructed to allow the device to be removed (it may be screwed into the chassis, for example). This bit can be used by system software to indicate a feature such as “eject device” to the end-user. The ICH10 takes no action on the state of this bit - it is for system software only. For example, if this bit is cleared, and a Hot-Plug event occurs, the ICH10 still treats it as a proper Hot-Plug event. Note that these bits are not reset on a Controller reset. This bit is not reset by Function Level Reset. |
| 17 | Port Multiplier Attached (PMA) — RO / R/W. When this bit is set, a port multiplier is attached to the ICH10 for this port. When cleared, a port multiplier is not attached to this port. This bit is RO 0 when CAP.PMS (offset ABAR+00h:bit 17) = 0 and R/W when CAP.PMS = 1. This bit may only be set when Px.CMD.ST is cleared. |
| 16 | Port Multiplier FIS Based Switching Enable (PMFSE) — RO. The ICH10 does not support FIS-based switching. NOTE: FIS Port Multiplier not supported by ICH10. |
| 15 | Controller Running (CR) — RO. When this bit is set, the DMA engines for a port are running. See section 5.2.2 of the <i>Serial ATA AHCI Specification</i> for details on when this bit is set and cleared by the ICH10. |



| Bit | Description |
|------|-------------------------------------------------------------------------------------------------------------------------------------------------------------------------------------------------------------------------------------------------------------------------------------------------------------------------------------------------------------------------------------------------------------------------------------------------------------------------------------------------------------------------------------------------------------------------------------------------------------------------------------------------------------------------------------------------------------------------------------------------------------------------|
| 14 | FIS Receive Running (FR) — RO. When set, the FIS Receive DMA engine for the port is running. See section 12.2.2 of the <i>Serial ATA AHCI Specification</i> for details on when this bit is set and cleared by the ICH10. |
| 13 | Interlock Switch State (ISS) — RO. For systems that support interlock switches (via CAP.SIS [ABAR+00h:bit 28]), if an interlock switch exists on this port (via ISP in this register), this bit indicates the current state of the interlock switch. A 0 indicates the switch is closed, and a 1 indicates the switch is opened. For systems that do not support interlock switches, or if an interlock switch is not attached to this port, this bit reports 0. |
| 12:8 | Current Command Slot (CCS) — RO. Indicates the current command slot the ICH10 is processing. This field is valid when the ST bit is set in this register, and is constantly updated by the ICH10. This field can be updated as soon as the ICH10 recognizes an active command slot, or at some point soon after when it begins processing the command. This field is used by software to determine the current command issue location of the ICH10. In queued mode, software shall not use this field, as its value does not represent the current command being executed. Software shall only use PxCI and PxSACT when running queued commands. |
| 7:5 | Reserved |
| 4 | FIS Receive Enable (FRE) — R/W. When set, the ICH10 may post received FISes into the FIS receive area pointed to by PxFB (ABAR+108h/188h/208h/288h) and PxFBU (ABAR+10Ch/18Ch/20Ch/28Ch). When cleared, received FISes are not accepted by the ICH10, except for the first D2H (device-to-host) register FIS after the initialization sequence. System software must not set this bit until PxFB (PxFBU) have been programmed with a valid pointer to the FIS receive area, and if software wishes to move the base, this bit must first be cleared, and software must wait for the FR bit (bit 14) in this register to be cleared. |
| 3 | Command List Override (CLO) — R/W. Setting this bit to '1' causes PxTFD.STS.BSY and PxTFD.STS.DRQ to be cleared to '0'. This allows a software reset to be transmitted to the device regardless of whether the BSY and DRQ bits are still set in the PxTFD.STS register. The Controller sets this bit to '0' when PxTFD.STS.BSY and PxTFD.STS.DRQ have been cleared to '0'. A write to this register with a value of '0' shall have no effect. This bit shall only be set to '1' immediately prior to setting the PxCMD.ST bit to '1' from a previous value of '0'. Setting this bit to '1' at any other time is not supported and will result in indeterminate behavior. Software must wait for CLO to be cleared to '0' before setting PxCMD.ST to '1'. |



| Bit | Description |
|-----|--------------------------------------------------------------------------------------------------------------------------------------------------------------------------------------------------------------------------------------------------------------------------------------------------------------------------------------------------------------------------------------------------------------------------------------------------------------------------------------------------------------------------------------------------------------------------------------|
| 2 | Power On Device (POD) — RO. Cold presence detect not supported. Defaults to 1. |
| 1 | <p>Spin-Up Device (SUD) — R/W / RO</p> <p>This bit is R/W and defaults to 0 for systems that support staggered spin-up (R/W when CAP.SSS (ABAR+00h:bit 27) is 1). Bit is RO 1 for systems that do not support staggered spin-up (when CAP.SSS is 0).</p> <p>0 = No action. 1 = On an edge detect from 0 to 1, the ICH10 starts a COMRESET initialization sequence to the device.</p> <p>Clearing this bit to '0' does not cause any OOB signal to be sent on the interface. When this bit is cleared to '0' and PxSCTL.DET=0h, the Controller will enter listen mode.</p> |
| 0 | <p>Start (ST) — R/W. When set, the ICH10 may process the command list. When cleared, the ICH10 may not process the command list. Whenever this bit is changed from a 0 to a 1, the ICH10 starts processing the command list at entry 0. Whenever this bit is changed from a 1 to a 0, the PxCI register is cleared by the ICH10 upon the ICH10 putting the controller into an idle state.</p> <p>Refer to section 12.2.1 of the Serial ATA AHCI Specification for important restrictions on when ST can be set to 1.</p> |

14.4.3.8 PxTFD—Port [5:0] Task File Data Register (D31:F2)

| | | | |
|-----------------|----------------------------------------------------------------------------------------------------------------------------------------|------------|---------|
| Address Offset: | Port 0: ABAR + 120h Port 1: ABAR + 1A0h Port 2: ABAR + 220h Port 3: ABAR + 2A0h Port 4: ABAR + 320h Port 5: ABAR + 3A0h | Attribute: | RO |
| Default Value: | 0000007Fh | Size: | 32 bits |

This is a 32-bit register that copies specific fields of the task file when FISes are received. The FISes that contain this information are:

D2H Register FIS
PIO Setup FIS
Set Device Bits FIS

| Bit | Description | | | | | | | | | | | | | | | | | | |
|-------|----------------------------------------------------------------------------------------------------------------------------------------------------------------------------------------------------------------------------------------------------------------------------------------------------------------------------------------------------------------------------------------------------------------------------------------------------------------------------------------------------------------------------------------------------------------------------------------------------------------------------------------------------|----------------------------------------|-------|------------|---|-----|---------------------------------|-----|-----|----------------|---|-----|----------------------------------------|-----|-----|----------------|---|-----|----------------------------------------|
| 31:16 | Reserved | | | | | | | | | | | | | | | | | | |
| 15:8 | Error (ERR) — RO. Contains the latest copy of the task file error register. | | | | | | | | | | | | | | | | | | |
| 7:0 | <p>Status (STS) — RO. Contains the latest copy of the task file status register. Fields of note in this register that affect AHCI.</p> <table border="1"> <thead> <tr> <th>Bit</th> <th>Field</th> <th>Definition</th> </tr> </thead> <tbody> <tr> <td>7</td> <td>BSY</td> <td>Indicates the interface is busy</td> </tr> <tr> <td>6:4</td> <td>N/A</td> <td>Not applicable</td> </tr> <tr> <td>3</td> <td>DRQ</td> <td>Indicates a data transfer is requested</td> </tr> <tr> <td>2:1</td> <td>N/A</td> <td>Not applicable</td> </tr> <tr> <td>0</td> <td>ERR</td> <td>Indicates an error during the transfer</td> </tr> </tbody> </table> | Bit | Field | Definition | 7 | BSY | Indicates the interface is busy | 6:4 | N/A | Not applicable | 3 | DRQ | Indicates a data transfer is requested | 2:1 | N/A | Not applicable | 0 | ERR | Indicates an error during the transfer |
| Bit | Field | Definition | | | | | | | | | | | | | | | | | |
| 7 | BSY | Indicates the interface is busy | | | | | | | | | | | | | | | | | |
| 6:4 | N/A | Not applicable | | | | | | | | | | | | | | | | | |
| 3 | DRQ | Indicates a data transfer is requested | | | | | | | | | | | | | | | | | |
| 2:1 | N/A | Not applicable | | | | | | | | | | | | | | | | | |
| 0 | ERR | Indicates an error during the transfer | | | | | | | | | | | | | | | | | |



14.4.3.9 PxSIG—Port [5:0] Signature Register (D31:F2)

Address Offset: Port 0: ABAR + 124h Attribute: RO
Port 1: ABAR + 1A4h
Port 2: ABAR + 224h
Port 3: ABAR + 2A4h
Port 4: ABAR + 324h
Port 5: ABAR + 3A4h
Default Value: FFFFFFFFh Size: 32 bits

This is a 32-bit register which contains the initial signature of an attached device when the first D2H Register FIS is received from that device. It is updated once after a reset sequence.

| Bit | Description |
|--------------------------------|----------------------------------------------------------------------------------------------------------------------------------------|
| 31:0 | Signature (SIG) — RO. Contains the signature received from a device on the first D2H register FIS. The bit order is as follows: |
| | Bit Field |
| | 31:24 LBA High Register |
| | 23:16 LBA Mid Register |
| | 15:8 LBA Low Register |
| 7:0 Sector Count Register | |



14.4.3.10 PxSSTS—Port [5:0] Serial ATA Status Register (D31:F2)

| | | | |
|-----------------|----------------------------------------------------------------------------------------------------------------------------------------|------------|---------|
| Address Offset: | Port 0: ABAR + 128h Port 1: ABAR + 1A8h Port 2: ABAR + 228h Port 3: ABAR + 2A8h Port 4: ABAR + 328h Port 5: ABAR + 3A8h | Attribute: | RO |
| Default Value: | 00000000h | Size: | 32 bits |

This is a 32-bit register that conveys the current state of the interface and host. The ICH10 updates it continuously and asynchronously. When the ICH10 transmits a COMRESET to the device, this register is updated to its reset values.

| Bit | Description | | | | | | | | | | |
|-------|--------------------------------------------------------------------------------------------------------------------------------------------------------------------------------------------------------------------------------------------------------------------------------------------------------------------------------------------------------------------------------------------------------------------------------------------------------------------------------------------------------------------------------------------------------------------------------------------------------------------------------------------------------------|-------|-------------|----|----------------------------------------------------------|----|----------------------------------------------------------------|----|------------------------------------------------------------|----|----------------------------------------------------------------------------------------------------|
| 31:12 | Reserved | | | | | | | | | | |
| 11:8 | <p>Interface Power Management (IPM) — RO. Indicates the current interface state:</p> <table> <thead> <tr> <th>Value</th> <th>Description</th> </tr> </thead> <tbody> <tr> <td>0h</td> <td>Device not present or communication not established</td> </tr> <tr> <td>1h</td> <td>Interface in active state</td> </tr> <tr> <td>2h</td> <td>Interface in PARTIAL power management state</td> </tr> <tr> <td>6h</td> <td>Interface in SLUMBER power management state</td> </tr> </tbody> </table> <p>All other values reserved.</p> | Value | Description | 0h | Device not present or communication not established | 1h | Interface in active state | 2h | Interface in PARTIAL power management state | 6h | Interface in SLUMBER power management state |
| Value | Description | | | | | | | | | | |
| 0h | Device not present or communication not established | | | | | | | | | | |
| 1h | Interface in active state | | | | | | | | | | |
| 2h | Interface in PARTIAL power management state | | | | | | | | | | |
| 6h | Interface in SLUMBER power management state | | | | | | | | | | |
| 7:4 | <p>Current Interface Speed (SPD) — RO. Indicates the negotiated interface communication speed.</p> <table> <thead> <tr> <th>Value</th> <th>Description</th> </tr> </thead> <tbody> <tr> <td>0h</td> <td>Device not present or communication not established</td> </tr> <tr> <td>1h</td> <td>Generation 1 communication rate negotiated</td> </tr> <tr> <td>2h</td> <td>Generation 2 communication rate negotiated</td> </tr> </tbody> </table> <p>All other values reserved. ICH10 Supports Generation 1 communication rates (1.5 Gb/s) and Gen 2 rates (3.0 Gb/s).</p> | Value | Description | 0h | Device not present or communication not established | 1h | Generation 1 communication rate negotiated | 2h | Generation 2 communication rate negotiated | | |
| Value | Description | | | | | | | | | | |
| 0h | Device not present or communication not established | | | | | | | | | | |
| 1h | Generation 1 communication rate negotiated | | | | | | | | | | |
| 2h | Generation 2 communication rate negotiated | | | | | | | | | | |
| 3:0 | <p>Device Detection (DET) — RO. Indicates the interface device detection and Phy state:</p> <table> <thead> <tr> <th>Value</th> <th>Description</th> </tr> </thead> <tbody> <tr> <td>0h</td> <td>No device detected and Phy communication not established</td> </tr> <tr> <td>1h</td> <td>Device presence detected but Phy communication not established</td> </tr> <tr> <td>3h</td> <td>Device presence detected and Phy communication established</td> </tr> <tr> <td>4h</td> <td>Phy in offline mode as a result of the interface being disabled or running in a BIST loopback mode</td> </tr> </tbody> </table> <p>All other values reserved.</p> | Value | Description | 0h | No device detected and Phy communication not established | 1h | Device presence detected but Phy communication not established | 3h | Device presence detected and Phy communication established | 4h | Phy in offline mode as a result of the interface being disabled or running in a BIST loopback mode |
| Value | Description | | | | | | | | | | |
| 0h | No device detected and Phy communication not established | | | | | | | | | | |
| 1h | Device presence detected but Phy communication not established | | | | | | | | | | |
| 3h | Device presence detected and Phy communication established | | | | | | | | | | |
| 4h | Phy in offline mode as a result of the interface being disabled or running in a BIST loopback mode | | | | | | | | | | |



14.4.3.11 PxSCTL — Port [5:0] Serial ATA Control Register (D31:F2)

Address Offset: Port 0: ABAR + 12Ch Attribute: R/W, RO
 Port 1: ABAR + 1ACh
 Port 2: ABAR + 22Ch
 Port 3: ABAR + 2ACh
 Port 4: ABAR + 32Ch
 Port 5: ABAR + 3ACh
 Default Value: 00000004h Size: 32 bits

This is a 32-bit read-write register by which software controls SATA capabilities. Writes to the SControl register result in an action being taken by the ICH10 or the interface. Reads from the register return the last value written to it.

| Bit | Description | | | | | | | | | | |
|-------|--------------------------------------------------------------------------------------------------------------------------------------------------------------------------------------------------------------------------------------------------------------------------------------------------------------------------------------------------------------------------------------------------------------------------------------------------------------------------------------------------------------------------------------------------------------------------------------------------------------------------------------|-------|-------------|----|-----------------------------------|----|------------------------------------------------------------|----|------------------------------------------------------------|----|---------------------------------------------------------|
| 31:20 | Reserved | | | | | | | | | | |
| 19:16 | Port Multiplier Port (PMP) — R/W. This field is not used by AHCI | | | | | | | | | | |
| 15:12 | Select Power Management (SPM) — R/W. This field is not used by AHCI | | | | | | | | | | |
| 11:8 | <p>Interface Power Management Transitions Allowed (IPM) — R/W. Indicates which power states the ICH10 is allowed to transition to:</p> <table border="1"> <thead> <tr> <th>Value</th> <th>Description</th> </tr> </thead> <tbody> <tr> <td>0h</td> <td>No interface restrictions</td> </tr> <tr> <td>1h</td> <td>Transitions to the PARTIAL state disabled</td> </tr> <tr> <td>2h</td> <td>Transitions to the SLUMBER state disabled</td> </tr> <tr> <td>3h</td> <td>Transitions to both PARTIAL and SLUMBER states disabled</td> </tr> </tbody> </table> <p>All other values reserved</p> | Value | Description | 0h | No interface restrictions | 1h | Transitions to the PARTIAL state disabled | 2h | Transitions to the SLUMBER state disabled | 3h | Transitions to both PARTIAL and SLUMBER states disabled |
| Value | Description | | | | | | | | | | |
| 0h | No interface restrictions | | | | | | | | | | |
| 1h | Transitions to the PARTIAL state disabled | | | | | | | | | | |
| 2h | Transitions to the SLUMBER state disabled | | | | | | | | | | |
| 3h | Transitions to both PARTIAL and SLUMBER states disabled | | | | | | | | | | |
| 7:4 | <p>Speed Allowed (SPD) — R/W. Indicates the highest allowable speed of the interface. This speed is limited by the CAP.ISS (ABAR+00h:bit 23:20) field.</p> <table border="1"> <thead> <tr> <th>Value</th> <th>Description</th> </tr> </thead> <tbody> <tr> <td>0h</td> <td>No speed negotiation restrictions</td> </tr> <tr> <td>1h</td> <td>Limit speed negotiation to Generation 1 communication rate</td> </tr> <tr> <td>2h</td> <td>Limit speed negotiation to Generation 2 communication rate</td> </tr> </tbody> </table> <p>ICH10 Supports Generation 1 communication rates (1.5 Gb/s) and Gen 2 rates (3.0 Gb/s).</p> | Value | Description | 0h | No speed negotiation restrictions | 1h | Limit speed negotiation to Generation 1 communication rate | 2h | Limit speed negotiation to Generation 2 communication rate | | |
| Value | Description | | | | | | | | | | |
| 0h | No speed negotiation restrictions | | | | | | | | | | |
| 1h | Limit speed negotiation to Generation 1 communication rate | | | | | | | | | | |
| 2h | Limit speed negotiation to Generation 2 communication rate | | | | | | | | | | |

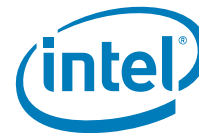

| Bit | Description | | | | | | | | |
|-------|---------------------------------------------------------------------------------------------------------------------------------------------------------------------------------------------------------------------------------------------------------------------------------------------------------------------------------------------------------------------------------------------------------------------------------------------------------------------------------------------------------------------------------------------------------------------------------------------------------------------------------------------------------------------------------------------------------------------------------------------------------------------------------------------------------------------------------------------------------------------------------------------------------------------------------------------------------------------------------------------------------------------------------------------------------------------------------------------------------------------------------------------------------------------------------------------------------------------------|-------|-------------|----|--------------------------------------------------------|----|----------------------------------------------------------------------------------------------------------------------------------------------------------------------------------------------------------------|----|--------------------------------------------------------------|
| 3:0 | <p>Device Detection Initialization (DET) — R/W. Controls the ICH10's device detection and interface initialization.</p> <table border="1"> <thead> <tr> <th>Value</th> <th>Description</th> </tr> </thead> <tbody> <tr> <td>0h</td> <td>No device detection or initialization action requested</td> </tr> <tr> <td>1h</td> <td>Perform interface communication initialization sequence to establish communication. This is functionally equivalent to a hard reset and results in the interface being reset and communications re-initialized</td> </tr> <tr> <td>4h</td> <td>Disable the Serial ATA interface and put Phy in offline mode</td> </tr> </tbody> </table> <p>All other values reserved.</p> <p>When this field is written to a 1h, the ICH10 initiates COMRESET and starts the initialization process. When the initialization is complete, this field shall remain 1h until set to another value by software.</p> <p>This field may only be changed to 1h or 4h when PxCMD.ST is 0. Changing this field while the ICH10 is running results in undefined behavior.</p> <p>Note: It is permissible to implement any of the Serial ATA defined behaviors for transmission of COMRESET when DET=1h.</p> | Value | Description | 0h | No device detection or initialization action requested | 1h | Perform interface communication initialization sequence to establish communication. This is functionally equivalent to a hard reset and results in the interface being reset and communications re-initialized | 4h | Disable the Serial ATA interface and put Phy in offline mode |
| Value | Description | | | | | | | | |
| 0h | No device detection or initialization action requested | | | | | | | | |
| 1h | Perform interface communication initialization sequence to establish communication. This is functionally equivalent to a hard reset and results in the interface being reset and communications re-initialized | | | | | | | | |
| 4h | Disable the Serial ATA interface and put Phy in offline mode | | | | | | | | |

14.4.3.12 PxSERR—Port [5:0] Serial ATA Error Register (D31:F2)

Address Offset: Port 0: ABAR + 130h Attribute: R/WC
 Port 1: ABAR + 1B0h
 Port 2: ABAR + 230h
 Port 3: ABAR + 2B0h
 Port 4: ABAR + 330h
 Port 5: ABAR + 3B0h

Default Value: 00000000h Size: 32 bits

Bits 26:16 of this register contains diagnostic error information for use by diagnostic software in validating correct operation or isolating failure modes. Bits 11:0 contain error information used by host software in determining the appropriate response to the error condition. If one or more of bits 11:8 of this register are set, the controller will stop the current transfer.

| Bit | Description |
|-------|---------------------------------------------------------------------------------------------------------------------------------------------------------------------------------------------------------------------------------------------------------------------------------|
| 31:27 | Reserved |
| 26 | Exchanged (X) — R/WC. When set to one this bit indicates that a change in device presence has been detected since the last time this bit was cleared. This bit shall always be set to 1 anytime a COMINIT signal is received. This bit is reflected in the POIS.PCS bit. |
| 25 | Unrecognized FIS Type (F) — R/WC. Indicates that one or more FISs were received by the Transport layer with good CRC, but had a type field that was not recognized. |
| 24 | Transport state transition error (T) — R/WC. Indicates that an error has occurred in the transition from one state to another within the Transport layer since the last time this bit was cleared. |
| 23 | Transport state transition error (T) — R/WC. Indicates that an error has occurred in the transition from one state to another within the Transport layer since the last time this bit was cleared. |



| Bit | Description |
|-------|-------------------------------------------------------------------------------------------------------------------------------------------------------------------------------------------------------------------------------------------------------------------------------------------------------------------------------------------------------------------------------------------------------------------------|
| 22 | Handshake (H) — R/WC. Indicates that one or more R_ERR handshake response was received in response to frame transmission. Such errors may be the result of a CRC error detected by the recipient, a disparity or 8b/10b decoding error, or other error condition leading to a negative handshake on a transmitted frame. |
| 21 | CRC Error (C) — R/WC. Indicates that one or more CRC errors occurred with the Link Layer. |
| 20 | Disparity Error (D) — R/WC. This field is not used by AHCI. |
| 19 | 10b to 8b Decode Error (B) — R/WC. Indicates that one or more 10b to 8b decoding errors occurred. |
| 18 | Comm Wake (W) — R/WC. Indicates that a Comm Wake signal was detected by the Phy. |
| 17 | Phy Internal Error (I) — R/WC. Indicates that the Phy detected some internal error. |
| 16 | PhyRdy Change (N) — R/WC. When set to 1 this bit indicates that the internal PhyRdy signal changed state since the last time this bit was cleared. In the ICH10, this bit will be set when PhyRdy changes from a 0 -> 1 or a 1 -> 0. The state of this bit is then reflected in the PxIS.PRCs interrupt status bit and an interrupt will be generated if enabled. Software clears this bit by writing a 1 to it. |
| 15:12 | Reserved |
| 11 | Internal Error (E) — R/WC. The SATA controller failed due to a master or target abort when attempting to access system memory. |
| 10 | Protocol Error (P) — R/WC. A violation of the Serial ATA protocol was detected. Note: The ICH10 does not set this bit for all protocol violations that may occur on the SATA link. |
| 9 | Persistent Communication or Data Integrity Error (C) — R/WC. A communication error that was not recovered occurred that is expected to be persistent. Persistent communications errors may arise from faulty interconnect with the device, from a device that has been removed or has failed, or a number of other causes. |
| 8 | Transient Data Integrity Error (T) — R/WC. A data integrity error occurred that was not recovered by the interface. |
| 7:2 | Reserved. |
| 1 | Recovered Communications Error (M) — R/WC. Communications between the device and host was temporarily lost but was re-established. This can arise from a device temporarily being removed, from a temporary loss of Phy synchronization, or from other causes and may be derived from the PhyNRdy signal between the Phy and Link layers. |
| 0 | Recovered Data Integrity Error (I) — R/WC. A data integrity error occurred that was recovered by the interface through a retry operation or other recovery action. |



14.4.3.13 PxSACT—Port [5:0] Serial ATA Active (D31:F2)

Address Offset: Port 0: ABAR + 134h Attribute: R/W
 Port 1: ABAR + 1B4h
 Port 2: ABAR + 234h
 Port 3: ABAR + 2B4h
 Port 4: ABAR + 334h
 Port 5: ABAR + 3B4h
 Default Value: 00000000h Size: 32 bits

| Bit | Description |
|------|-----------------------------------------------------------------------------------------------------------------------------------------------------------------------------------------------------------------------------------------------------------------------------------------------------------------------------------------------------------------------|
| 31:0 | <p>Device Status (DS) — R/W. System software sets this bit for SATA queuing operations prior to setting the PxCI.CI bit in the same command slot entry. This field is cleared via the Set Device Bits FIS.</p> <p>This field is also cleared when PxCMD.ST (ABAR+118h/198h/218h/298h:bit 0) is cleared by software, and as a result of a COMRESET or SRST.</p> |

14.4.3.14 PxCI—Port [5:0] Command Issue Register (D31:F2)

Address Offset: Port 0: ABAR + 138h Attribute: R/W
 Port 1: ABAR + 1B8h
 Port 2: ABAR + 238h
 Port 3: ABAR + 2B8h
 Port 4: ABAR + 338h
 Port 5: ABAR + 3B8h
 Default Value: 00000000h Size: 32 bits

| Bit | Description |
|------|----------------------------------------------------------------------------------------------------------------------------------------------------------------------------------------------------------------------------------------------------------------------------------------------------------------------------------------------------------------------------------------------------------------------------------------------------------------------------------------------------------------------------------------------------------|
| 31:0 | <p>Commands Issued (CI) — R/W. This field is set by software to indicate to the ICH10 that a command has been built-in system memory for a command slot and may be sent to the device. When the ICH10 receives a FIS which clears the BSY and DRQ bits for the command, it clears the corresponding bit in this register for that command slot. Bits in this field shall only be set to '1' by software when PxCMD.ST is set to '1'.</p> <p>This field is also cleared when PxCMD.ST (ABAR+118h/198h/218h/298h:bit 0) is cleared by software.</p> |

§ §

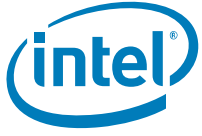

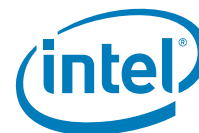

15 SATA Controller Registers (D31:F5)

15.1 PCI Configuration Registers (SATA–D31:F5)

Note: Address locations that are not shown should be treated as Reserved.

All of the SATA registers are in the core well. None of the registers can be locked.

Table 15-1. SATA Controller PCI Register Address Map (SATA–D31:F5) (Sheet 1 of 2)

| Offset | Mnemonic | Register Name | Default | Type |
|---------|----------|-------------------------------------------|--------------------------|--------------------------|
| 00h–01h | VID | Vendor Identification | 8086h | RO |
| 02h–03h | DID | Device Identification | See register description | RO |
| 04h–05h | PCICMD | PCI Command | 0000h | R/W, RO |
| 06h–07h | PCISTS | PCI Status | 02B0h | R/WC, RO |
| 08h | RID | Revision Identification | See register description | RO |
| 09h | PI | Programming Interface | See register description | See register description |
| 0Ah | SCC | Sub Class Code | See register description | See register description |
| 0Bh | BCC | Base Class Code | 01h | RO |
| 0Dh | PMLT | Primary Master Latency Timer | 00h | RO |
| 10h–13h | PCMD_BAR | Primary Command Block Base Address | 00000001h | R/W, RO |
| 14h–17h | PCNL_BAR | Primary Control Block Base Address | 00000001h | R/W, RO |
| 18h–1Bh | SCMD_BAR | Secondary Command Block Base Address | 00000001h | R/W, RO |
| 1Ch–1Fh | SCNL_BAR | Secondary Control Block Base Address | 00000001h | R/W, RO |
| 20h–23h | BAR | Legacy Bus Master Base Address | 00000001h | R/W, RO |
| 24h–27h | SIDPBA | Serial ATA Index / Data Pair Base Address | 00000000h | See register description |
| 2Ch–2Dh | SVID | Subsystem Vendor Identification | 0000h | R/WO |
| 2Eh–2Fh | SID | Subsystem Identification | 0000h | R/WO |
| 34h | CAP | Capabilities Pointer | 80h | RO |
| 3Ch | INT_LN | Interrupt Line | 00h | R/W |
| 3Dh | INT_PN | Interrupt Pin | See register description | RO |



Table 15-1. SATA Controller PCI Register Address Map (SATA–D31:F5) (Sheet 2 of 2)

| Offset | Mnemonic | Register Name | Default | Type |
|-------------------------|----------|--------------------------------------------|--------------------------|---------------|
| 40h–41h | IDE_TIM | Primary IDE Timing Register | 0000h | R/W |
| 42h–43h | IDE_TIM | Secondary IDE Timing Registers | 0000h | R/W |
| 70h–71h | PID | PCI Power Management Capability ID | See register description | RO |
| 72h–73h | PC | PCI Power Management Capabilities | 4003h | RO |
| 74h–75h | PMCS | PCI Power Management Control and Status | 0008h | R/W, RO, R/WC |
| 80h–81h (Consumer Only) | MSICI | Message Signaled Interrupt Capability ID | 7005h | RO |
| 82h–83h (Consumer Only) | MSIMC | Message Signaled Interrupt Message Control | 0000h | RO, R/W |
| 84h–87h (Consumer Only) | MSIMA | Message Signaled Interrupt Message Address | 00000000h | RO, R/W |
| 88h–89h (Consumer Only) | MSIMD | Message Signaled Interrupt Message Data | 0000h | R/W |
| 90h | MAP | Address Map | 00h | R/W |
| 92h–93h | PCS | Port Control and Status | 0000h | R/W, RO, R/WC |
| A8h–ABh | SCAP0 | SATA Capability Register 0 | 0010B012h | RO |
| ACH–AFh | SCAP1 | SATA Capability Register 1 | 00000048h | RO |
| B0h–B1h | FLRCID | FLR Capability ID | 0009h | RO |
| B2h–B3h | FLRCLV | FLR Capability Length and Value | 2006h | RO |
| B4h–B5h | FLRCTRL | FLR Control | 0000h | R/W, RO |
| C0h | ATC | APM Trapping Control | 00h | R/W |
| C4h | ATS | ATM Trapping Status | 00h | R/WC |

NOTE: The ICH10 SATA controller is not arbitrated as a PCI device, therefore it does not need a master latency timer.

15.1.1 VID—Vendor Identification Register (SATA–D31:F5)

| | | | |
|-----------------|---------|-------------|--------|
| Offset Address: | 00h–01h | Attribute: | RO |
| Default Value: | 8086h | Size: | 16 bit |
| Lockable: | No | Power Well: | Core |

| Bit | Description |
|------|------------------------------------------------------------------------------------|
| 15:0 | Vendor ID — RO. This is a 16-bit value assigned to Intel. Intel VID = 8086h |



15.1.2 DID—Device Identification Register (SATA—D31:F5)

| | | | |
|-----------------|---------------------|-------------|--------|
| Offset Address: | 02h–03h | Attribute: | RO |
| Default Value: | See bit description | Size: | 16 bit |
| Lockable: | No | Power Well: | Core |

| Bit | Description |
|------|-----------------------------------------------------------------------------------------------------------------------------------------------------------------------------------------------------------------------------------|
| 15:0 | Device ID — RO. This is a 16-bit value assigned to the Intel® ICH10 SATA controller. NOTE: The value of this field will change dependent upon the value of the MAP Register. See Section 15.1.29 |

15.1.3 PCICMD—PCI Command Register (SATA—D31:F5)

| | | | |
|-----------------|---------|------------|---------|
| Address Offset: | 04h–05h | Attribute: | RO, R/W |
| Default Value: | 0000h | Size: | 16 bits |

| Bit | Description |
|-------|--------------------------------------------------------------------------------------------------------------------------------------------------------------------------------------------------------------------------------------------------------------------------------------------------------------------------------------------------------|
| 15:11 | Reserved |
| 10 | Interrupt Disable — R/W. This disables pin-based INTx# interrupts. This bit has no effect on MSI operation. 0 = Internal INTx# messages are generated if there is an interrupt and MSI is not enabled. 1 = Internal INTx# messages will not be generated. |
| 9 | Fast Back to Back Enable (FBE) — RO. Reserved as 0. |
| 8 | SERR# Enable (SERR_EN) — RO. Reserved as 0. |
| 7 | Wait Cycle Control (WCC) — RO. Reserved as 0. |
| 6 | Parity Error Response (PER) — R/W. 0 = Disabled. SATA controller will not generate PERR# when a data parity error is detected. 1 = Enabled. SATA controller will generate PERR# when a data parity error is detected. |
| 5 | VGA Palette Snoop (VPS) — RO. Reserved as 0. |
| 4 | Postable Memory Write Enable (PMWE) — RO. Reserved as 0. |
| 3 | Special Cycle Enable (SCE) — RO. Reserved as 0. |
| 2 | Bus Master Enable (BME) — R/W. This bit controls the ICH10's ability to act as a PCI master for IDE Bus Master transfers. This bit does not impact the generation of completions for split transaction commands. |
| 1 | Memory Space Enable (MSE) — RO. This controller does not support AHCI, therefore no memory space is required. |
| 0 | I/O Space Enable (IOSE) — R/W. This bit controls access to the I/O space registers. 0 = Disables access to the Legacy or Native IDE ports (both Primary and Secondary) as well as the Bus Master I/O registers. 1 = Enable. Note that the Base Address register for the Bus Master registers should be programmed before this bit is set. |



15.1.4 PCISTS — PCI Status Register (SATA–D31:F5)

Address Offset: 06h–07h Attribute: R/WC, RO
 Default Value: 02B0h Size: 16 bits

Note: For the writable bits, software must write a 1 to clear bits that are set. Writing a 0 to the bit has no effect.

| Bit | Description |
|------|--------------------------------------------------------------------------------------------------------------------------------------------------------------------------------------------------------------------------------------------------------------------------------------------------------------------------------------------------|
| 15 | Detected Parity Error (DPE) — R/WC. 0 = No parity error detected by SATA controller. 1 = SATA controller detects a parity error on its interface. |
| 14 | Signaled System Error (SSE) — RO. Reserved as 0. |
| 13 | Received Master Abort (RMA) — R/WC. 0 = Master abort Not generated. 1 = SATA controller, as a master, generated a master abort. |
| 12 | Reserved |
| 11 | Signaled Target Abort (STA) — RO. Reserved as 0. |
| 10:9 | DEVSEL# Timing Status (DEV_STS) — RO. 01 = Hardwired; Controls the device select time for the SATA controller's PCI interface. |
| 8 | Data Parity Error Detected (DPED) — R/WC. For ICH10, this bit can only be set on read completions received from SiBUS where there is a parity error. 1 = SATA controller, as a master, either detects a parity error or sees the parity error line asserted, and the parity error response bit (bit 6 of the command register) is set. |
| 7 | Fast Back to Back Capable (FB2BC) — RO. Reserved as 1. |
| 6 | User Definable Features (UDF) — RO. Reserved as 0. |
| 5 | 66MHz Capable (66MHZ_CAP) — RO. Reserved as 1. |
| 4 | Capabilities List (CAP_LIST) — RO. This bit indicates the presence of a capabilities list. The minimum requirement for the capabilities list must be PCI power management for the SATA controller. |
| 3 | Interrupt Status (INTS) — RO. Reflects the state of INTx# messages, IRQ14 or IRQ15. 0 = Interrupt is cleared (independent of the state of Interrupt Disable bit in the command register [offset 04h]). 1 = Interrupt is to be asserted |
| 2:0 | Reserved |

15.1.5 RID—Revision Identification Register (SATA–D31:F5)

Offset Address: 08h Attribute: RO
 Default Value: See bit description Size: 8 bits

| Bit | Description |
|-----|------------------------------------------------------------------------------------------------------------------------------------------------------|
| 7:0 | Revision ID — RO. Refer to the <i>Intel® I/O Controller Hub (ICH10) Family Specification Update</i> for the value of the Revision ID Register |



15.1.9 PMLT—Primary Master Latency Timer Register (SATA–D31:F5)

Address Offset: 0Dh Attribute: RO
 Default Value: 00h Size: 8 bits

| Bit | Description |
|-----|------------------------------------------------------------------------------------------------------------------------------------------------------------------------------------------------------|
| 7:0 | Master Latency Timer Count (MLTC) — RO. 00h = Hardwired. The SATA controller is implemented internally, and is not arbitrated as a PCI device, so it does not need a Master Latency Timer. |

15.1.10 PCMD_BAR—Primary Command Block Base Address Register (SATA–D31:F5)

Address Offset: 10h–13h Attribute: R/W, RO
 Default Value: 00000001h Size: 32 bits

| Bit | Description |
|-------|-----------------------------------------------------------------------------------------------------------------|
| 31:16 | Reserved |
| 15:3 | Base Address — R/W. This field provides the base address of the I/O space (8 consecutive I/O locations). |
| 2:1 | Reserved |
| 0 | Resource Type Indicator (RTE) — RO. Hardwired to 1 to indicate a request for I/O space. |

NOTE: This 8-byte I/O space is used in native mode for the Primary Controller's Command Block.

15.1.11 PCNL_BAR—Primary Control Block Base Address Register (SATA–D31:F5)

Address Offset: 14h–17h Attribute: R/W, RO
 Default Value: 00000001h Size: 32 bits

| Bit | Description |
|-------|-----------------------------------------------------------------------------------------------------------------|
| 31:16 | Reserved |
| 15:2 | Base Address — R/W. This field provides the base address of the I/O space (4 consecutive I/O locations). |
| 1 | Reserved |
| 0 | Resource Type Indicator (RTE) — RO. Hardwired to 1 to indicate a request for I/O space. |

NOTE: This 4-byte I/O space is used in native mode for the Primary Controller's Command Block.



15.1.12 SCMD_BAR—Secondary Command Block Base Address Register (IDE D31:F1)

Address Offset: 18h–1Bh Attribute: R/W, RO
 Default Value: 00000001h Size: 32 bits

| Bit | Description |
|-------|-----------------------------------------------------------------------------------------------------------------|
| 31:16 | Reserved |
| 15:3 | Base Address — R/W. This field provides the base address of the I/O space (8 consecutive I/O locations). |
| 2:1 | Reserved |
| 0 | Resource Type Indicator (RTE) — RO. Hardwired to 1 to indicate a request for I/O space. |

NOTE: This 8-byte I/O space is used in native mode for the Secondary Controller's Command Block.

15.1.13 SCNL_BAR—Secondary Control Block Base Address Register (IDE D31:F1)

Address Offset: 1Ch–1Fh Attribute: R/W, RO
 Default Value: 00000001h Size: 32 bits

| Bit | Description |
|-------|-----------------------------------------------------------------------------------------------------------------|
| 31:16 | Reserved |
| 15:2 | Base Address — R/W. This field provides the base address of the I/O space (4 consecutive I/O locations). |
| 1 | Reserved |
| 0 | Resource Type Indicator (RTE) — RO. Hardwired to 1 to indicate a request for I/O space. |

NOTE: This 4-byte I/O space is used in native mode for the Secondary Controller's Command Block.



15.1.14 BAR — Legacy Bus Master Base Address Register (SATA–D31:F5)

Address Offset: 20h–23h Attribute: R/W, RO
Default Value: 00000001h Size: 32 bits

The Bus Master IDE interface function uses Base Address register 5 to request a 16-byte IO space to provide a software interface to the Bus Master functions. Only 12 bytes are actually used (6 bytes for primary, 6 bytes for secondary). Only bits [15:4] are used to decode the address.

| Bit | Description |
|-------|-----------------------------------------------------------------------------------------------------------------------|
| 31:16 | Reserved |
| 15:5 | Base Address — R/W. This field provides the base address of the I/O space (16 consecutive I/O locations). |
| 4 | Base Address 4 (BA4) — R/W. When SCC is 01h, this bit will be R/W resulting in requesting 16B of I/O space. |
| 3:1 | Reserved |
| 0 | Resource Type Indicator (RTE) — RO. Hardwired to 1 to indicate a request for I/O space. |

15.1.15 SIDPBA — SATA Index/Data Pair Base Address Register (SATA–D31:F5)

Address Offset: 24h–27h Attribute: R/W, RO
Default Value: 00000000h Size: 32 bits

When SCC is 01h

When the programming interface is IDE, the register represents an I/O BAR allocating 16B of I/O space for the I/O mapped registers defined in [Section 15.3](#). Note that although 16B of locations are allocated, some maybe reserved.

| Bit | Description |
|-------|------------------------------------------------------------------------------------------------|
| 31:16 | Reserved |
| 15:4 | Base Address (BA) — R/W. Base address of register I/O space |
| 3:1 | Reserved |
| 0 | Resource Type Indicator (RTE) — RO. Hardwired to 1 to indicate a request for I/O space. |



15.1.21 IDE_TIM — IDE Timing Register (SATA–D31:F5)

Address Offset: Primary: 40h–41h Attribute: R/W
 Secondary: 42h–43h
 Default Value: 0000h Size: 16 bits

| Bit | Description |
|------|-------------------------------------------------------------------------------------------------------------------------------------------------------------------------------------------------------------------------------------------------------------------------------------------------------------------------------------------------------------------------------------------------------------------------------------------------------------------------------------------------------------------------------------------------------------------------------------------------------------|
| 15 | <p>IDE Decode Enable (IDE) — R/W. Individually enable/disable the Primary or Secondary decode. 0 = Disable. 1 = Enables the Intel® ICH10 to decode the associated Command Blocks (1F0–1F7h for primary, 170–177h for secondary) and Control Block (3F6h for primary and 376h for secondary). This bit effects the IDE decode ranges for both legacy and native-Mode decoding.</p> <p>NOTE: This bit affects SATA operation in both combined and non-combined ATA modes. See Section 5.16 for more on ATA modes of operation.</p> |
| 14:0 | Reserved |

15.1.22 PID—PCI Power Management Capability Identification Register (SATA–D31:F5)

Address Offset: 70h–71h Attribute: RO
 Default Value: B001h Size: 16 bits

| Bits | Description |
|------|---------------------------------------------------------------------------------------------------------------------------------------------|
| 15:8 | Next Capability (NEXT) — RO. When SCC is 01h, this field will be B0h indicating the next item is FLR Capability Pointer in the list. |
| 7:0 | Capability ID (CID) — RO. Indicates that this pointer is a PCI power management. |

15.1.23 PC—PCI Power Management Capabilities Register (SATA–D31:F5)

Address Offset: 72h–73h Attribute: RO
 Default Value: 4003h Size: 16 bits

| Bits | Description |
|-------|--------------------------------------------------------------------------------------------------------------------------------|
| 15:11 | PME Support (PME_SUP) — RO. By default with SCC = 01h, the default value of 00000 indicates no PME support in IDE mode. |
| 10 | D2 Support (D2_SUP) — RO. Hardwired to 0. The D2 state is not supported |
| 9 | D1 Support (D1_SUP) — RO. Hardwired to 0. The D1 state is not supported |
| 8:6 | Auxiliary Current (AUX_CUR) — RO. PME# from D3 _{COLD} state is not supported, therefore this field is 000b. |
| 5 | Device Specific Initialization (DSI) — RO. Hardwired to 0 to indicate that no device-specific initialization is required. |
| 4 | Reserved |
| 3 | PME Clock (PME_CLK) — RO. Hardwired to 0 to indicate that PCI clock is not required to generate PME#. |
| 2:0 | Version (VER) — RO. Hardwired to 011 to indicates support for Revision 1.2 of the PCI Power Management Specification. |



15.1.24 PMCS—PCI Power Management Control and Status Register (SATA–D31:F5)

Address Offset: 74h–75h Attribute: RO, R/W, R/WC
 Default Value: 0008h Size: 16 bits
 Function Level Reset: No (Bits 8 and 15 only)

| Bits | Description |
|------|-------------------------------------------------------------------------------------------------------------------------------------------------------------------------------------------------------------------------------------------------------------------------------------------------------------------------------------------------------------------------------------------------------------------------------------------------------------------------------------------------------------------------------------------------------------------------------------------------------------------------------------------------------------------------------------------------------------------------------------------------------------------------------------------------------------------------------------------------------------------------------------|
| 15 | PME Status (PMES) — R/WC. Bit is set when a PME event is to be requested, and if this bit and PMEE is set, a PME# will be generated from the SATA controller. Note: When SCC=01h this bit will be RO '0'. Software is advised to clear PMEE together with PMES prior to changing SCC through MAP.SMS. This bit is not reset by Function Level Reset. |
| 14:9 | Reserved |
| 8 | PME Enable (PMEE) — R/W. When SCC is not 01h, this bit R/W. When set, the SATA controller generates PME# form D3 _{HOT} on a wake event. Note: When SCC=01h this bit will be RO '0'. Software is advised to clear PMEE together with PMES prior to changing SCC through MAP.SMS. This bit is not reset by Function Level Reset. |
| 7:4 | Reserved |
| 3 | No Soft Reset (NSFRST) — RO. These bits are used to indicate whether devices transitioning from D3 _{HOT} state to D0 state will perform an internal reset. 0 = Device transitioning from D3 _{HOT} state to D0 state perform an internal reset. 1 = Device transitioning from D3 _{HOT} state to D0 state do not perform an internal reset. Configuration content is preserved. Upon transition from the D3 _{HOT} state to D0 state initialized state, no additional operating system intervention is required to preserve configuration context beyond writing to the PowerState bits. Regardless of this bit, the controller transition from D3 _{HOT} state to D0 state by a system or bus segment reset will return to the state D0 uninitialized with only PME context preserved if PME is supported and enabled. |
| 2 | Reserved |
| 1:0 | Power State (PS) — R/W. These bits are used both to determine the current power state of the SATA controller and to set a new power state. 00 = D0 state 11 = D3 _{HOT} state When in the D3 _{HOT} state, the controller's configuration space is available, but the I/O and memory spaces are not. Additionally, interrupts are blocked. |

15.1.25 MID—Message Signal Interrupt Identifier (SATA–D31:F5) (Consumer Only)

Address Offset: 80h–81h Attribute: RO
 Default Value: 7005h Size: 16 bits

| Bits | Description |
|------|-----------------------------------------------------------------------------------------------------------|
| 15:8 | Next Pointer (NEXT) — RO. Indicates the next item in the list is the PCI Power Management Pointer. |
| 7:0 | Capability ID (CID) — RO. Capability ID indicates Message Signal Interrupt. |

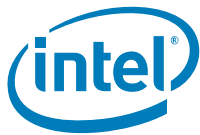

15.1.26 MC—Message Signal Interrupt Message Control (SATA–D31:F5) (Consumer Only)

Address Offset: 82h-83h Attribute: R/W, RO
 Default Value: 0000h Size: 16 bits

| Bits | Description |
|------|-------------------------------------------------------------------------------------------------------------------------------------------------------------------------------------------------------------------------------------------------------------------------------------------------------------------------------------------------------------------------------------------------------------------------------------------------------|
| 15:8 | Reserved. |
| 7 | 64 Bit Address Capable (C64) — RO. Capable of generating a 32-bit message only. |
| 6:4 | Multiple Message Enable (MME) — RO. This controller supports a single interrupt message. This bit is RO '0'. |
| 3:1 | Multiple Message Capable (MMC) — RO. System software reads this field to determine the number of requested vectors. This controller supports a single interrupt message, this field is RO '0'. |
| 0 | MSI Enable (MSIE) — R/W. If set, MSI is enabled and traditional interrupt pins are not used to generate interrupts. Note: CMD.ID bit does not effect MSI. Software must clear this bit to 0 to disable MSI before changing the number of messages allocated in the MMC field. Software must also make sure this bit is cleared to '0' when operating in legacy IDE mode. This bit is R/W when SCC is not 01h and is RO '0' when SCC is 01h. |

15.1.27 MA—Message Signal Interrupt Message Address (SATA–D31:F5) (Consumer Only)

Address Offset: 84h Attribute: R/W, RO
 Default Value: 00000000h Size: 32 bits

| Bits | Description |
|------|-----------------------------------------------------------------------------------------------------------|
| 31:2 | Address (ADDR) — R/W. Lower 32 bits of the system specified message address, always DWORD aligned. |
| 1:0 | Reserved. |

15.1.28 MD—Message Signal Interrupt Message Data (SATA–D31:F5) (Consumer Only)

Address Offset: 88h Attribute: R/W
 Default Value: 0000h Size: 16 bits

| Bits | Description |
|------|-------------------------------------------------------------------------------------------------------------------------------------------------------------------------------------------------------------------------------------------------------------------------------------------------------------------------------------------------------------------------------------------|
| 15:0 | Data (DATA) — R/W. This 16-bit field is programmed by system software if MSI is enabled. Its content is driven onto the lower word of the data bus of the MSI memory write transaction. Note: When MC.MME field is set to a value other than '000', some bits of the MSI memory write transaction will be driven based on the source of the interrupt rather than from MD[2:0]. |



15.1.29 MAP—Address Map Register (SATA–D31:F5) 16

Address Offset: 90h Attribute: R/W, R/WO, RO
 Default Value: 00h Size: bits
 Function Level Reset: No (Bits 9:8 only)

| Bits | Description |
|-------|----------------------------------------------------------------------------------------------------------------------------------------------------------------------------------------------|
| 15:10 | Reserved. |
| 9:8 | Reserved |
| 7:6 | SATA Mode Select (SMS) — R/W. Software programs these bits to control the mode in which the SATA Controller should operate. 00b = IDE Mode All other combinations are reserved. |
| 5:2 | Reserved. |
| 1:0 | Map Value (MV) — Reserved. |



15.1.31 SATACRO— SATA Capability Register 0 (SATA–D31:F5)

Address Offset: A8h-ABh Attribute: RO, RWO
 Default Value: 0010B012h Size: 32 bits
 Function Level Reset: No (Bits 15:8 only)

Note: When SCC is 01h this register is read-only 0.

| Bit | Description |
|-------|------------------------------------------------------------------------------------------------------------------------------|
| 31:24 | Reserved. |
| 23:20 | Major Revision (MAJREV) — RO. Major revision number of the SATA Capability Pointer implemented. |
| 19:16 | Minor Revision (MINREV) — RO. Minor revision number of the SATA Capability Pointer implemented. |
| 15:8 | Next Capability Pointer (NEXT) — RWO. Points to the next capability structure. |
| 7:0 | Capability ID (CAP) — RO. The value of 12h has been assigned by the PCI SIG to designate the SATA capability pointer. |

15.1.32 SATACR1— SATA Capability Register 1 (SATA–D31:F5)

Address Offset: ACh-AFh Attribute: RO
 Default Value: 00000048h Size: 32 bits

When SCC is 01h this register is read-only 0.

| Bit | Description |
|-------|-----------------------------------------------------------------------------------------------------------------------------------------------------------------------------------------------------------------------------------------------------------------------------------------------------------------------------------------|
| 31:16 | Reserved. |
| 15:4 | BAR Offset (BAROFST) — RO. Indicates the offset into the BAR where the index/Data pair are located (in DWord granularity). The index and Data I/O registers are located at offset 10h within the I/O space defined by LBAR (BAR4). A value of 004h indicates offset 10h. |
| 3:0 | BAR Location (BARLOC) — RO. Indicates the absolute PCI Configuration Register address of the BAR containing the Index/Data pair (in DWord granularity). The Index and Data I/O registers reside within the space defined by LBAR (BAR4) in the SATA controller. a value of 8h indicates and offset of 20h, which is LBAR (BAR4). |

15.1.33 FLRCID— FLR Capability ID (SATA–D31:F5)

Address Offset: B0h-B1h Attribute: RO
 Default Value: 0009h Size: 16 bits

| Bit | Description |
|------|-----------------------------------------------------------------------------------------------------------------------------------------------------------------------------------------------------|
| 15:8 | Next Capability Pointer — RO. A value of 00h indicates the final item in the Capability List. |
| 7:0 | Capability ID — RO. The value of this field depends on the FLRCSSEL bit. If FLRCSSEL = 0, this field is 13h If FLRCSSEL = 1, this field is 09h, indicating vendor specific capability. |



15.1.34 FLRCLV— FLR Capability Length and Value (SATA–D31:F5)

Address Offset: B2h-B3h Attribute: RO, RWO
Default Value: 2006h Size: 16 bits
Function Level Reset: No (Bits 9:8 only)

When FLRCSSEL = '0', this register is defined as follows.

| Bit | Description |
|-------|------------------------------------------------------------------------------------------------------------------------------------------------------------------------------------|
| 15:10 | Reserved. |
| 9 | FLR Capability — RWO. This field indicates support for Function Level Reset. |
| 8 | TXP Capability — RWO. This field indicates support for the Transactions Pending (TXP) bit. TXP must be supported if FLR is supported. |
| 7:0 | Capability Length — RO. This field indicates the number of bytes of the Vendor Specific capability as required by the PCI spec. It has the value of 06h for FLR Capability. |

When FLRCSSEL = '1', this register is defined as follows.

| Bit | Description |
|-------|------------------------------------------------------------------------------------------------------------------------------------------------------------------------------------|
| 15:12 | Vendor Specific Capability ID — RO. A value of 02h identifies this capability as a Function Level Reset. |
| 11:8 | Capability Version — RO. This field indicates the version of the FLR capability. |
| 7:0 | Capability Length — RO. This field indicates the number of bytes of the Vendor Specific capability as required by the PCI spec. It has the value of 06h for FLR Capability. |

15.1.35 FLRCTRL— FLR Control (SATA–D31:F5)

Address Offset: B4h-B5h Attribute: R/W, RO
Default Value: 0000h Size: 16 bits

| Bit | Description |
|------|------------------------------------------------------------------------------------------------------------------------------------------------------------------------------------------------------------|
| 15:9 | Reserved. |
| 8 | Transactions Pending (TXP) — RO. 0 = Completions for all Non-Posted requests have been received by the controller. 1 = Controller has issued Non-Posted request which has not been completed. |
| 7:1 | Reserved. |
| 0 | Initiate FLR — R/W. Used to initiate FLR transition. A write of '1' indicates FLR transition. |



15.2 Bus Master IDE I/O Registers (D31:F5)

The bus master IDE function uses 16 bytes of I/O space, allocated via the BAR register, located in Device 31:Function 2 Configuration space, offset 20h. All bus master IDE I/O space registers can be accessed as byte, word, or dword quantities. Reading reserved bits returns an indeterminate, inconsistent value, and writes to reserved bits have no effect (but should not be attempted). These registers are only used for legacy operation. Software must not use these registers when running AHCI. The description of the I/O registers is shown in [Table 15-2](#).

Table 15-2. Bus Master IDE I/O Register Address Map

| BAR+ Offset | Mnemonic | Register | Default | Type |
|-------------|----------|---------------------------------------------------|-----------|------------------|
| 00 | BMICP | Command Register Primary | 00h | R/W |
| 01 | — | Reserved | — | RO |
| 02 | BMISP | Bus Master IDE Status Register Primary | 00h | R/W, R/WC, RO |
| 03 | — | Reserved | — | RO |
| 04–07 | BMIDP | Bus Master IDE Descriptor Table Pointer Primary | xxxxxxxxh | R/W |
| 08 | BMICS | Command Register Secondary | 00h | R/W |
| 09 | — | Reserved | — | RO |
| 0Ah | BMISS | Bus Master IDE Status Register Secondary | 00h | R/W, R/WC, RO |
| 0Bh | — | Reserved | — | RO |
| 0Ch–0Fh | BMIDS | Bus Master IDE Descriptor Table Pointer Secondary | xxxxxxxxh | R/W |



15.2.1 BMIC[P,S]—Bus Master IDE Command Register (D31:F5)

Address Offset: Primary: BAR + 00h Attribute: R/W
 Secondary: BAR + 08h
 Default Value: 00h Size: 8 bits

| Bit | Description |
|-----|----------------------------------------------------------------------------------------------------------------------------------------------------------------------------------------------------------------------------------------------------------------------------------------------------------------------------------------------------------------------------------------------------------------------------------------------------------------------------------------------------------------------------------------------------------------------------------------------------------------------------------------------------------------------------------------------------------------------------------------------------------------------------------------------------------------------------------------------------------------------------------------------------------------------------------------------------------------------------------------------------------------------------------------------------------------------------------------------------------------------------------------------------------------------------------------------------------------------------------------------------------------------------------------------------------------------------------------------------------------------------------------------------------------------------------------------------------------------------------------------------------------------------------------------------------------------------------------------------------------------------------------------------------------------------------------------------------------------------------------------------|
| 7:4 | Reserved. |
| 3 | <p>Read / Write Control (R/WC) — R/W. This bit sets the direction of the bus master transfer: This bit must NOT be changed when the bus master function is active.</p> <p>0 = Memory reads 1 = Memory writes</p> |
| 2:1 | Reserved. |
| 0 | <p>Start/Stop Bus Master (START) — R/W.</p> <p>0 = All state information is lost when this bit is cleared. Master mode operation cannot be stopped and then resumed. If this bit is reset while bus master operation is still active (i.e., the Bus Master IDE Active bit (D31:F5:BAR + 02h, bit 0) of the Bus Master IDE Status register for that IDE channel is set) and the drive has not yet finished its data transfer (the Interrupt bit in the Bus Master IDE Status register for that IDE channel is not set), the bus master command is said to be aborted and data transferred from the drive may be discarded instead of being written to system memory.</p> <p>1 = Enables bus master operation of the controller. Bus master operation does not actually start unless the Bus Master Enable bit (D31:F1:04h, bit 2) in PCI configuration space is also set. Bus master operation begins when this bit is detected changing from 0 to 1. The controller will transfer data between the IDE device and memory only when this bit is set. Master operation can be halted by writing a 0 to this bit.</p> <p>NOTE: This bit is intended to be cleared by software after the data transfer is completed, as indicated by either the Bus Master IDE Active bit being cleared or the Interrupt bit of the Bus Master IDE Status register for that IDE channel being set, or both. Hardware does not clear this bit automatically. If this bit is cleared to 0 prior to the DMA data transfer being initiated by the drive in a device to memory data transfer, then the ICH10 will not send DMAT to terminate the data transfer. SW intervention (e.g. sending SRST) is required to reset the interface in this condition.</p> |



15.2.2 BMIS[P,S]—Bus Master IDE Status Register (D31:F5)

Address Offset: Primary: BAR + 02h Attribute: R/W, R/WC, RO
 Secondary: BAR + 0Ah
 Default Value: 00h Size: 8 bits

| Bit | Description |
|-----|------------------------------------------------------------------------------------------------------------------------------------------------------------------------------------------------------------------------------------------------------------------------------------------------------------------------------------------------------------------------------------------------------------------------------------------------------------------------------------------------------------------------------------------------------------------------------------------|
| 7 | PRD Interrupt Status (PRDIS) — R/WC. 0 = Software clears this bit by writing a 1 to it. 1 = This bit is set when the host controller execution of a PRD that has its PRD_INT bit set. |
| 6 | Reserved. |
| 5 | Drive 0 DMA Capable — R/W. 0 = Not Capable 1 = Capable. Set by device dependent code (BIOS or device driver) to indicate that drive 0 for this channel is capable of DMA transfers, and that the controller has been initialized for optimum performance. The ICH10 does not use this bit. It is intended for systems that do not attach BMIDE to the PCI bus. |
| 4:3 | Reserved. |
| 2 | Interrupt — R/WC. 0 = Software clears this bit by writing a 1 to it. 1 = Set when a device FIS is received with the 'I' bit set, provided that software has not disabled interrupts via the IEN bit of the Device Control Register (see chapter 5 of the <i>Serial ATA Specification</i> , Revision 1.0a). |
| 1 | Error — R/WC. 0 = Software clears this bit by writing a 1 to it. 1 = This bit is set when the controller encounters a target abort or master abort when transferring data on PCI. |
| 0 | Bus Master IDE Active (ACT) — RO. 0 = This bit is cleared by the ICH10 when the last transfer for a region is performed, where EOT for that region is set in the region descriptor. It is also cleared by the ICH10 when the Start Bus Master bit (D31:F5:BAR+ 00h, bit 0) is cleared in the Command register. When this bit is read as a 0, all data transferred from the drive during the previous bus master command is visible in system memory, unless the bus master command was aborted. 1 = Set by the ICH10 when the Start bit is written to the Command register. |

15.2.3 BMID[P,S]—Bus Master IDE Descriptor Table Pointer Register (D31:F5)

Address Offset: Primary: BAR + 04h–07h Attribute: R/W
 Secondary: BAR + 0Ch–0Fh
 Default Value: All bits undefined Size: 32 bits

| Bit | Description |
|------|------------------------------------------------------------------------------------------------------------------------------------------------------------------------------------------------------------------------------------------------------------------------------|
| 31:2 | Address of Descriptor Table (ADDR) — R/W. The bits in this field correspond to bits [31:2] of the memory location of the Physical Region Descriptor (PRD). The Descriptor Table must be dword-aligned. The Descriptor Table must not cross a 64-K boundary in memory. |
| 1:0 | Reserved |



15.3 Serial ATA Index/Data Pair Superset Registers

All of these I/O registers are in the core well. They are exposed only when SCC is 01h (i.e. IDE programming interface) and the controller is not in combined mode. These are Index/Data Pair registers that are used to access the SerialATA superset registers (SerialATA Status, SerialATA Control and SerialATA Error). The I/O space for these registers is allocated through SIDPBA. Locations with offset from 08h to 0Fh are reserved for future expansion. Software-write operations to the reserved locations shall have no effect while software-read operations to the reserved locations shall return 0.

15.3.1 SINDX—SATA Index Register (D31:F5)

Address Offset: SIDPBA + 00h Attribute: R/W
 Default Value: 00000000h Size: 32 bits

Note: These are Index/Data Pair Registers that are used to access the SSTS, SCTL, and SERR. The I/O space for these registers is allocated through SIDPBA.

| Bit | Description |
|-------|----------------------------------------------------------------------------------------------------------------------------------------------------------------------------------------------------------------------------------------------------------------------------------|
| 31:16 | Reserved |
| 15:8 | Port Index (PIDX) — R/W: This Index field is used to specify the port of the SATA controller at which the port-specific SSTS, SCTL, and SERR registers are located. 00h = Primary Master (Port 4) 02h = Secondary Master (Port 5) All other values are Reserved. |
| 7:0 | Register Index (RIDX) — R/W: This Index field is used to specify one out of three registers currently being indexed into. 00h = SSTS 01h = SCTL 02h = SERR All other values are Reserved |

15.3.2 SDATA—SATA Index Data Register (D31:F5)

Address Offset: SIDPBA + 04h Attribute: R/W
 Default Value: All bits undefined Size: 32 bits

Note: These are Index/Data Pair Registers that are used to access the SSTS, SCTL, and SERR. The I/O space for these registers is allocated through SIDPBA.

| Bit | Description |
|------|----------------------------------------------------------------------------------------------------------------------------------------------------------------------------------------------------------------------------------------------------------------------------------------------------------------------------------------------------------------------------------------------------------------------------------------------------------------------------------------------------------------------------------------------------------------------------------------------------------------------------------|
| 31:0 | Data (DATA) — R/W: This Data register is a “window” through which data is read or written to the memory mapped registers. A read or write to this Data register triggers a corresponding read or write to the memory mapped register pointed to by the Index register. The Index register must be setup prior to the read or write to this Data register. Note that a physical register is not actually implemented as the data is actually stored in the memory mapped registers. Since this is not a physical register, the “default” value is the same as the default value of the register pointed to by Index. |



15.3.2.1 PxSSTS—Serial ATA Status Register (D31:F5)

Address Offset: Attribute: RO
 Default Value: 00000000h Size: 32 bits

SDATA when SINDX.RIDX is 00h. This is a 32-bit register that conveys the current state of the interface and host. The ICH10 updates it continuously and asynchronously. When the ICH10 transmits a COMRESET to the device, this register is updated to its reset values.

| Bit | Description | | | | | | | | | | |
|-------|-------------------------------------------------------------------------------------------------------------------------------------------------------------------------------------------------------------------------------------------------------------------------------------------------------------------------------------------------------------------------------------------------------------------------------------------------------------------------------------------------------------------------------------------------------------------------------------------------------------------------------------------------------------------------------------------------------------------------------------------------------------------------------------------------------------------------------------------------------------------------------------------------|-------|-------------|----|----------------------------------------------------------|----|----------------------------------------------------------------|----|------------------------------------------------------------|----|----------------------------------------------------------------------------------------------------|
| 31:12 | Reserved | | | | | | | | | | |
| 11:8 | <p>Interface Power Management (IPM) — RO. Indicates the current interface state:</p> <table border="1" style="width: 100%; border-collapse: collapse;"> <thead> <tr> <th style="text-align: center;">Value</th> <th style="text-align: center;">Description</th> </tr> </thead> <tbody> <tr> <td style="text-align: center;">0h</td> <td>Device not present or communication not established</td> </tr> <tr> <td style="text-align: center;">1h</td> <td>Interface in active state</td> </tr> <tr> <td style="text-align: center;">2h</td> <td>Interface in PARTIAL power management state</td> </tr> <tr> <td style="text-align: center;">6h</td> <td>Interface in SLUMBER power management state</td> </tr> </tbody> </table> <p>All other values reserved.</p> | Value | Description | 0h | Device not present or communication not established | 1h | Interface in active state | 2h | Interface in PARTIAL power management state | 6h | Interface in SLUMBER power management state |
| Value | Description | | | | | | | | | | |
| 0h | Device not present or communication not established | | | | | | | | | | |
| 1h | Interface in active state | | | | | | | | | | |
| 2h | Interface in PARTIAL power management state | | | | | | | | | | |
| 6h | Interface in SLUMBER power management state | | | | | | | | | | |
| 7:4 | <p>Current Interface Speed (SPD) — RO. Indicates the negotiated interface communication speed.</p> <table border="1" style="width: 100%; border-collapse: collapse;"> <thead> <tr> <th style="text-align: center;">Value</th> <th style="text-align: center;">Description</th> </tr> </thead> <tbody> <tr> <td style="text-align: center;">0h</td> <td>Device not present or communication not established</td> </tr> <tr> <td style="text-align: center;">1h</td> <td>Generation 1 communication rate negotiated</td> </tr> <tr> <td style="text-align: center;">2h</td> <td>Generation 2 communication rate negotiated</td> </tr> </tbody> </table> <p>All other values reserved.</p> <p>ICH10 Supports Generation 1 communication rates (1.5 Gb/s) and Gen 2 rates (3.0 Gb/s).</p> | Value | Description | 0h | Device not present or communication not established | 1h | Generation 1 communication rate negotiated | 2h | Generation 2 communication rate negotiated | | |
| Value | Description | | | | | | | | | | |
| 0h | Device not present or communication not established | | | | | | | | | | |
| 1h | Generation 1 communication rate negotiated | | | | | | | | | | |
| 2h | Generation 2 communication rate negotiated | | | | | | | | | | |
| 3:0 | <p>Device Detection (DET) — RO. Indicates the interface device detection and Phy state:</p> <table border="1" style="width: 100%; border-collapse: collapse;"> <thead> <tr> <th style="text-align: center;">Value</th> <th style="text-align: center;">Description</th> </tr> </thead> <tbody> <tr> <td style="text-align: center;">0h</td> <td>No device detected and Phy communication not established</td> </tr> <tr> <td style="text-align: center;">1h</td> <td>Device presence detected but Phy communication not established</td> </tr> <tr> <td style="text-align: center;">3h</td> <td>Device presence detected and Phy communication established</td> </tr> <tr> <td style="text-align: center;">4h</td> <td>Phy in offline mode as a result of the interface being disabled or running in a BIST loopback mode</td> </tr> </tbody> </table> <p>All other values reserved.</p> | Value | Description | 0h | No device detected and Phy communication not established | 1h | Device presence detected but Phy communication not established | 3h | Device presence detected and Phy communication established | 4h | Phy in offline mode as a result of the interface being disabled or running in a BIST loopback mode |
| Value | Description | | | | | | | | | | |
| 0h | No device detected and Phy communication not established | | | | | | | | | | |
| 1h | Device presence detected but Phy communication not established | | | | | | | | | | |
| 3h | Device presence detected and Phy communication established | | | | | | | | | | |
| 4h | Phy in offline mode as a result of the interface being disabled or running in a BIST loopback mode | | | | | | | | | | |



15.3.2.3 PxSERR—Serial ATA Error Register (D31:F5)

Address Offset: Attribute: R/WC
 Default Value: 00000000h Size: 32 bits

SDATA when SINDx.RIDX is 02h.

Bits 26:16 of this register contains diagnostic error information for use by diagnostic software in validating correct operation or isolating failure modes. Bits 11:0 contain error information used by host software in determining the appropriate response to the error condition. If one or more of bits 11:8 of this register are set, the controller will stop the current transfer.

| Bit | Description |
|-------|-------------------------------------------------------------------------------------------------------------------------------------------------------------------------------------------------------------------------------------------------------------------------------------------------------------------------------------------------------------------------------------------------------------------------|
| 31:27 | Reserved |
| 26 | Exchanged (X) — R/WC. When set to one this bit indicates that a change in device presence has been detected since the last time this bit was cleared. This bit shall always be set to 1 anytime a COMINIT signal is received. This bit is reflected in the POIS.PCS bit. |
| 25 | Unrecognized FIS Type (F) — R/WC. Indicates that one or more FISs were received by the Transport layer with good CRC, but had a type field that was not recognized. |
| 24 | Transport state transition error (T) — R/WC. Indicates that an error has occurred in the transition from one state to another within the Transport layer since the last time this bit was cleared. |
| 23 | Transport state transition error (T) — R/WC. Indicates that an error has occurred in the transition from one state to another within the Transport layer since the last time this bit was cleared. |
| 22 | Handshake (H) — R/WC. Indicates that one or more R_ERR handshake response was received in response to frame transmission. Such errors may be the result of a CRC error detected by the recipient, a disparity or 8b/10b decoding error, or other error condition leading to a negative handshake on a transmitted frame. |
| 21 | CRC Error (C) — R/WC. Indicates that one or more CRC errors occurred with the Link Layer. |
| 20 | Disparity Error (D) — R/WC. This field is not used by AHCI. |
| 19 | 10b to 8b Decode Error (B) — R/WC. Indicates that one or more 10b to 8b decoding errors occurred. |
| 18 | Comm Wake (W) — R/WC. Indicates that a Comm Wake signal was detected by the Phy. |
| 17 | Phy Internal Error (I) — R/WC. Indicates that the Phy detected some internal error. |
| 16 | PhyRdy Change (N) — R/WC. When set to 1 this bit indicates that the internal PhyRdy signal changed state since the last time this bit was cleared. In the ICH10, this bit will be set when PhyRdy changes from a 0 -> 1 or a 1 -> 0. The state of this bit is then reflected in the PxIS.PRCs interrupt status bit and an interrupt will be generated if enabled. Software clears this bit by writing a 1 to it. |
| 15:12 | Reserved |
| 11 | Internal Error (E) — R/WC. The SATA controller failed due to a master or target abort when attempting to access system memory. |
| 10 | Protocol Error (P) — R/WC. A violation of the Serial ATA protocol was detected. Note: The ICH10 does not set this bit for all protocol violations that may occur on the SATA link. |



| Bit | Description |
|-----|--------------------------------------------------------------------------------------------------------------------------------------------------------------------------------------------------------------------------------------------------------------------------------------------------------------------------------------------------|
| 9 | Persistent Communication or Data Integrity Error (C) — R/WC. A communication error that was not recovered occurred that is expected to be persistent. Persistent communications errors may arise from faulty interconnect with the device, from a device that has been removed or has failed, or a number of other causes. |
| 8 | Transient Data Integrity Error (T) — R/WC. A data integrity error occurred that was not recovered by the interface. |
| 7:2 | Reserved. |
| 1 | Recovered Communications Error (M) — R/WC. Communications between the device and host was temporarily lost but was re-established. This can arise from a device temporarily being removed, from a temporary loss of Phy synchronization, or from other causes and may be derived from the PhyNRdy signal between the Phy and Link layers. |
| 0 | Recovered Data Integrity Error (I) — R/WC. A data integrity error occurred that was recovered by the interface through a retry operation or other recovery action. |

§ §





16 UHCI Controllers Registers

16.1 PCI Configuration Registers (USB—D29:F0/F1/F2/F3, D26:F0/F1/F2)

Note: The USB functions may be hidden based on the value of the corresponding bits in the Function Disable Register (see Chipset Configuration Registers). UHCIs must be disabled from highest number to lowest within their specific PCI device.

Table 16-1. UHCI Controller PCI Configuration Map

| UHCI | PCI Device:Function | Notes |
|---------|---------------------|------------------------------------------------------|
| UHCI #1 | D29:F0 | |
| UHCI #2 | D29:F1 | |
| UHCI #3 | D29:F2 | |
| UHCI #4 | D26:F0 | |
| UHCI #5 | D26:F1 | |
| UHCI #6 | D26:F2 or D29:F3 | D26:F2 can be configured as D29:F3 during BIOS post. |

Note: Register address locations that are not shown in [Table 16-2](#) should be treated as Reserved (see [Section 9.2](#) for details).

Table 16-2. UHCI Controller PCI Register Address Map (USB—D29:F0/F1/F2/F3, D26:F0/F1/F2)

| Offset | Mnemonic | Register Name | UHCI #1-6 Default | Type |
|--------|----------|---------------------------------|--------------------------|----------|
| 00–01h | VID | Vendor Identification | 8086h | RO |
| 02–03h | DID | Device Identification | See register description | RO |
| 04–05h | PCICMD | PCI Command | 0000h | R/W, RO |
| 06–07h | PCISTS | PCI Status | 0290h | R/WC, RO |
| 08h | RID | Revision Identification | See register description | RO |
| 09h | PI | Programming Interface | 00h | RO |
| 0Ah | SCC | Sub Class Code | 03h | RO |
| 0Bh | BCC | Base Class Code | 0Ch | RO |
| 0Dh | MLT | Master Latency Timer | 00h | RO |
| 0Eh | HEADTYP | Header Type | See register description | RO |
| 20–23h | BASE | Base Address | 00000001h | R/W, RO |
| 2C–2Dh | SVID | Subsystem Vendor Identification | 0000h | R/WO |
| 2E–2Fh | SID | Subsystem Identification | 0000h | R/WO |
| 34h | CAP_PTR | Capabilities Pointer | 50h | R/WO |



Table 16-2. UHCI Controller PCI Register Address Map (USB—D29:F0/F1/F2/F3, D26:F0/F1/F2)

| Offset | Mnemonic | Register Name | UHCI #1-6 Default | Type |
|--------|------------|-----------------------------------|--------------------------|-----------------|
| 3Ch | INT_LN | Interrupt Line | 00h | R/W |
| 3Dh | INT_PN | Interrupt Pin | See register description | RO |
| 50h | FLRCID | FLR Capability ID | 09h | RO |
| 51h | FLRNCP | FLR Next Capability Pointer | 00h | RO |
| 52–53h | FLRCLV | FLR Capability Length and Version | 2006h | RO |
| 54h | FLRCTRL | FLR Control | 00h | R/W |
| 55h | FLRSTAT | FLR Status | 00h | RO |
| 60h | USB_RELNUM | Serial Bus Release Number | 10h | RO |
| C0–C1h | USB_LEGKEY | USB Legacy Keyboard/Mouse Control | 2000h | R/W, RO R/WC |
| C4h | USB_RES | USB Resume Enable | 00h | R/W |
| C8h | CWP | Core Well Policy | 00h | R/W |
| CAh | UCR1 | UHCI Configuration Register 1 | 01h | R/W |

NOTE: Refer to the *Intel® I/O Controller Hub 10 (ICH10) Family Specification Update* for the value of the Revision ID Register.

16.1.1 VID—Vendor Identification Register (USB—D29:F0/F1/F2/F3, D26:F0/F1/F2)

Address Offset: 00h–01h Attribute: RO
Default Value: 8086h Size: 16 bits

| Bit | Description |
|------|----------------------------------------------------------|
| 15:0 | Vendor ID — RO. This is a 16-bit value assigned to Intel |

16.1.2 DID—Device Identification Register (USB—D29:F0/F1/F2/F3, D26:F0/F1/F2)

Address Offset: 02h–03h Attribute: RO
Default Value: See bit description Size: 16 bits

| Bit | Description |
|------|-----------------------------------------------------------------------------------------------------------------------------------------------------------------------------------------------------------|
| 15:0 | Device ID — RO. This is a 16-bit value assigned to the Intel® ICH10 USB universal host controllers. Refer to the <i>Intel® I/O Controller Hub (ICH10) Family</i> for the value of the Device ID Register. |



16.1.3 PCI CMD—PCI Command Register (USB—D29:F0/F1/F2/ F3, D26:F0/F1/F2)

Address Offset: 04h–05h
Default Value: 0000h

Attribute: R/W, RO
Size: 16 bits

| Bit | Description |
|-------|-------------------------------------------------------------------------------------------------------------------------------------------------------------------------------------------------------------------------------------------------------------------------------------|
| 15:11 | Reserved |
| 10 | Interrupt Disable — R/W. 0 = Enable. The function is able to generate its interrupt to the interrupt controller. 1 = Disable. The function is not capable of generating interrupts. The corresponding Interrupt Status bit is not affected by the interrupt enable. |
| 9 | Fast Back to Back Enable (FBE) — RO. Hardwired to 0. |
| 8 | SERR# Enable — RO. Reserved as 0. |
| 7 | Wait Cycle Control (WCC) — RO. Hardwired to 0. |
| 6 | Parity Error Response (PER) — RO. Hardwired to 0. |
| 5 | VGA Palette Snoop (VPS) — RO. Hardwired to 0. |
| 4 | Postable Memory Write Enable (PMWE) — RO. Hardwired to 0. |
| 3 | Special Cycle Enable (SCE) — RO. Hardwired to 0. |
| 2 | Bus Master Enable (BME) — R/W. 0 = Disable 1 = Enable. ICH10 can act as a master on the PCI bus for USB transfers. |
| 1 | Memory Space Enable (MSE) — RO. Hardwired to 0. |
| 0 | I/O Space Enable (IOSE) — R/W. This bit controls access to the I/O space registers. 0 = Disable 1 = Enable accesses to the USB I/O registers. The Base Address register for USB should be programmed before this bit is set. |



16.1.6 PI—Programming Interface Register (USB—D29:F0/F1/F2/F3, D26:F0/F1/F2)

Address Offset: 09h Attribute: RO
 Default Value: 00h Size: 8 bits

| Bit | Description |
|-----|------------------------------------------------------------------------------------------------|
| 7:0 | Programming Interface — RO. 00h = No specific register level programming interface defined. |

16.1.7 SCC—Sub Class Code Register (USB—D29:F0/F1/F2/F3, D26:F0/F1/F2)

Address Offset: 0Ah Attribute: RO
 Default Value: 03h Size: 8 bits

| Bit | Description |
|-----|----------------------------------------------------------|
| 7:0 | Sub Class Code (SCC) — RO. 03h = USB host controller. |

16.1.8 BCC—Base Class Code Register (USB—D29:F0/F1/F2/F3, D26:F0/F1/F2)

Address Offset: 0Bh Attribute: RO
 Default Value: 0Ch Size: 8 bits

| Bit | Description |
|-----|-------------------------------------------------------------|
| 7:0 | Base Class Code (BCC) — RO. 0Ch = Serial Bus controller. |

16.1.9 MLT—Master Latency Timer Register (USB—D29:F0/F1/F2/F3, D26:F0/F1/F2)

Address Offset: 0Dh Attribute: RO
 Default Value: 00h Size: 8 bits

| Bit | Description |
|-----|--------------------------------------------------------------------------------------------------------------------------------------------------------------------------------------------|
| 7:0 | Master Latency Timer (MLT) — RO. The USB controller is implemented internal to the ICH10 and not arbitrated as a PCI device. Therefore the device does not require a Master Latency Timer. |



16.1.13 SID — Subsystem Identification Register (USB—D29:F0/F1/F2/F3, D26:F0/F1/F2)

Address Offset: 2Eh–2Fh Attribute: R/WO
 Default Value: 0000h Size: 16 bits
 Lockable: No Power Well: Core
 Function Level Reset: No

| Bit | Description |
|------|------------------------------------------------------------------------------------------------------------------------------------------------------------------------------------------------------------------------------------------------------------------------------------------------------------------------------------------------------------------------------------------------------------------------------------------------------------------------------------------------------------------------|
| 15:0 | <p>Subsystem ID (SID) — R/WO. BIOS sets the value in this register to identify the Subsystem ID. The SID register, in combination with the SVID register (D29:F0/F1/F2/F3, D26:F0/F1/F2:2C), enables the operating system to distinguish each subsystem from other(s). The value read in this register is the same as what was written to the IDE_SID register.</p> <p>NOTE: The software can write to this register only once per core well reset. Writes should be done as a single, 16-bit cycle.</p> |

16.1.14 CAP_PTR—Capabilities Pointer (USB—D29:F0/F1/F2/F3, D26:F0/F1/F2)

Address Offset: 34h Attribute: R/WO
 Default Value: 50h Size: 8 bits
 Function Level Reset: No

| Bit | Description |
|-----|--------------------------------------------------------------------------------------------------------------------------------------------------|
| 7:0 | <p>Capability Pointer (CAP_PTR) — R/WO. This register points to the next capability in the Function Level Reset capability structure.</p> |

16.1.15 INT_LN—Interrupt Line Register (USB—D29:F0/F1/F2/F3, D26:F0/F1/F2)

Address Offset: 3Ch Attribute: R/W
 Default Value: 00h Size: 8 bits
 Function Level Reset: No

| Bit | Description |
|-----|-----------------------------------------------------------------------------------------------------------------------------------------------------------------------------|
| 7:0 | <p>Interrupt Line (INT_LN) — RO. This data is not used by the ICH10. It is to communicate to software the interrupt line that the interrupt pin is connected to.</p> |



16.1.16 INT_PN—Interrupt Pin Register (USB—D29:F0/F1/F2/F3, D26:F0/F1/F2)

Address Offset: 3Dh Attribute: RO
 Default Value: See Description Size: 8 bits

| Bit | Description |
|-----|------------------------------------------------------------------------------------------------------------------------------------------------------------------------------------------------------------------------------------------------------------------------------------------------------------------------------------------------------------------------------------------------------------------------------------------------------------------------------------------------------------------------------------------------------------------------------------------------------------------------------------------------------------------------------------------------------------------------------------------------------------------------------------------------------------------------------------------------------------------------------------------------------------------------------------------------------------------------------------------------------------------------------|
| 7:0 | <p>Interrupt Line (INT_LN) — RO. This value tells the software which interrupt pin each USB host controller uses. The upper 4 bits are hardwired to 0000b; the lower 4 bits are determine by the Interrupt Pin default values that are programmed in the memory-mapped configuration space as follows:</p> <p>UHCI #1 - D29IP.U0P (Chipset Config Registers: Offset 3108: bits 3:0) UHCI #2 - D29IP.U1P (Chipset Config Registers: Offset 3108: bits 7:4) UHCI #3 - D29IP.U2P (Chipset Config Registers: Offset 3108: bits 11:8) UHCI #4 - D26IP.U0P (Chipset Config Registers: Offset 3114: bits 3:0) UHCI #5 - D26IP.U1P (Chipset Config Registers: Offset 3114: bits 7:4) UHCI #6 - D26IP.U2P (Chipset Config Registers: Offset 3114: bits 11:8) or UHCI #6 - D29IP.U3P (Chipset Config Registers: Offset 3108: bits 15:12)</p> <p>NOTE: This does not determine the mapping to the PIRQ pins.</p> |

16.1.17 FLRCID—Function Level Reset Capability ID (USB—D29:F0/F1/F2/F3, D26:F0/F1/F2)

Address Offset: 50h Attribute: RO
 Default Value: 09h Size: 8 bits

| Bit | Description |
|-----|----------------------------------------------------------------------------------------------------------------------------------|
| 7:0 | <p>Capability ID — RO.</p> <p>13h = If FLRCSSEL = 0 09h (Vendor Specific Capability) = If FLRCSSEL = 1</p> |

16.1.18 FLRNCP—Function Level Reset Next Capability Pointer (USB—D29:F0/F1/F2/F3, D26:F0/F1/F2)

Address Offset: 51h Attribute: RO
 Default Value: 00h Size: 8 bits

| Bit | Description |
|-----|------------------------------------------------------------------|
| 7:0 | A value of 00h indicates that this is the last capability field. |

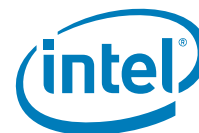

| Bit | Description |
|-----|-------------------------------------------------------------------------------------------------------------------------------------------------------------------------------------------------------------------------------------------------------------------------------------------------------------------------------------------------------------------------------------------------------------------------------------------------------------------------------------------------------------------------------------------------------------------------------------------------|
| 12 | <p>SMI Caused by USB Interrupt (SMIBYUSB) — RO. This bit indicates if an interrupt event occurred from this controller. The interrupt from the controller is taken before the enable in bit 13 has any effect to create this read-only bit. Note that even if the corresponding enable bit is not set in Bit 4, this bit may still be active. It is up to the SMM code to use the enable bit to determine the exact cause of the SMI#.</p> <p>0 = Software should clear the interrupts via the USB controllers. Writing a 1 to this bit will have no effect. 1 = Event Occurred.</p> |
| 11 | <p>SMI Caused by Port 64 Write (TRAPBY64W) — R/WC. This bit indicates if the event occurred. Note that even if the corresponding enable bit is not set in bit 3, this bit will still be active. It is up to the SMM code to use the enable bit to determine the exact cause of the SMI#. Note that the A20Gate Pass-Through Logic allows specific port 64h writes to complete without setting this bit.</p> <p>0 = Software clears this bit by writing a 1 to the bit location in any of the controllers. 1 = Event Occurred.</p> |
| 10 | <p>SMI Caused by Port 64 Read (TRAPBY64R) — R/WC. This bit indicates if the event occurred. Note that even if the corresponding enable bit is not set in bit 2, this bit will still be active. It is up to the SMM code to use the enable bit to determine the exact cause of the SMI#.</p> <p>0 = Software clears this bit by writing a 1 to the bit location in any of the controllers. 1 = Event Occurred.</p> |
| 9 | <p>SMI Caused by Port 60 Write (TRAPBY60W) — R/WC. This bit indicates if the event occurred. Note that even if the corresponding enable bit is not set in bit 1, this bit will still be active. It is up to the SMM code to use the enable bit to determine the exact cause of the SMI#. Note that the A20Gate Pass-Through Logic allows specific port 64h writes to complete without setting this bit.</p> <p>0 = Software clears this bit by writing a 1 to the bit location in any of the controllers. 1 = Event Occurred.</p> |
| 8 | <p>SMI Caused by Port 60 Read (TRAPBY60R) — R/WC. This bit indicates if the event occurred. Note that even if the corresponding enable bit is not set in the bit 0, then this bit will still be active. It is up to the SMM code to use the enable bit to determine the exact cause of the SMI#.</p> <p>0 = Software clears this bit by writing a 1 to the bit location in any of the controllers. 1 = Event Occurred.</p> |
| 7 | <p>SMI at End of Pass-Through Enable (SMIATENDPS) — R/W. This bit enables SMI at the end of a pass-through. This can occur if an SMI is generated in the middle of a pass-through, and needs to be serviced later.</p> <p>0 = Disable 1 = Enable</p> |
| 6 | <p>Pass Through State (PSTATE) — RO.</p> <p>0 = If software needs to reset this bit, it should set bit 5 in all of the host controllers to 0. 1 = Indicates that the state machine is in the middle of an A20GATE pass-through sequence.</p> |
| 5 | <p>A20Gate Pass-Through Enable (A20PASSEN) — R/W.</p> <p>0 = Disable. 1 = Enable. Allows A20GATE sequence Pass-Through function. A specific cycle sequence involving writes to port 60h and 64h does not result in the setting of the SMI status bits.</p> |
| 4 | <p>SMI on USB IRQ Enable (USBSMIEN) — R/W.</p> <p>0 = Disable 1 = Enable. USB interrupt will cause an SMI event.</p> |



16.2 USB I/O Registers

Some of the read/write register bits that deal with changing the state of the USB hub ports function such that on read back they reflect the current state of the port, and not necessarily the state of the last write to the register. This allows the software to poll the state of the port and wait until it is in the proper state before proceeding. A host controller reset, global reset, or port reset will immediately terminate a transfer on the affected ports and disable the port. This affects the USBCMD register, bit 4 and the PORTSC registers, bits [12,6,2]. See individual bit descriptions for more detail.

Table 16-3. USB I/O Registers

| BASE + Offset | Mnemonic | Register Name | Default | Type |
|---------------|-----------|-------------------------|-----------|----------------------------|
| 00–01h | USBCMD | USB Command | 0000h | R/W |
| 02–03h | USBSTS | USB Status | 0020h | R/WC |
| 04–05h | USBINTR | USB Interrupt Enable | 0000h | R/W |
| 06–07h | FRNUM | Frame Number | 0000h | R/W (see Note 1) |
| 08–0Bh | FRBASEADD | Frame List Base Address | Undefined | R/W |
| 0Ch | SOFMOD | Start of Frame Modify | 40h | R/W |
| 0D–0Fh | — | Reserved | — | — |
| 10–11h | PORTSC0 | Port 0 Status/Control | 0080h | R/WC, RO, R/W (see Note 1) |
| 12–13h | PORTSC1 | Port 1 Status/Control | 0080h | R/WC, RO, R/W (see Note 1) |

NOTE:

1. These registers are WORD writable only. Byte writes to these registers have unpredictable effects.



16.2.1 USBCMD—USB Command Register

I/O Offset: Base + (00h–01h) Attribute: R/W
 Default Value: 0000h Size: 16 bits

The Command Register indicates the command to be executed by the serial bus host controller. Writing to the register causes a command to be executed. The table following the bit description provides additional information on the operation of the Run/Stop and Debug bits.

| Bit | Description |
|------|----------------------------------------------------------------------------------------------------------------------------------------------------------------------------------------------------------------------------------------------------------------------------------------------------------------------------------------------------------------------------------------------------------------------------------------------------------------------------------------------------------------------------------------------------------------------------------------------------------------------------------------------------------------------------------------------------------------------------|
| 15:7 | Reserved |
| 8 | <p>Loop Back Test Mode — R/W. 0 = Disable loop back test mode. 1 = ICH10 is in loop back test mode. When both ports are connected together, a write to one port will be seen on the other port and the data will be stored in I/O offset 18h.</p> |
| 7 | <p>Max Packet (MAXP) — R/W. This bit selects the maximum packet size that can be used for full speed bandwidth reclamation at the end of a frame. This value is used by the host controller to determine whether it should initiate another transaction based on the time remaining in the SOF counter. Use of reclamation packets larger than the programmed size will cause a Babble error if executed during the critical window at frame end. The Babble error results in the offending endpoint being stalled. Software is responsible for ensuring that any packet which could be executed under bandwidth reclamation be within this size limit. 0 = 32 bytes 1 = 64 bytes</p> |
| 6 | <p>Configure Flag (CF) — R/W. This bit has no effect on the hardware. It is provided only as a semaphore service for software. 0 = Indicates that software has not completed host controller configuration. 1 = HCD software sets this bit as the last action in its process of configuring the host controller.</p> |
| 5 | <p>Software Debug (SWDBG) — R/W. The SWDBG bit must only be manipulated when the controller is in the stopped state. This can be determined by checking the HCHalted bit in the USBSTS register. 0 = Normal Mode. 1 = Debug mode. In SW Debug mode, the host controller clears the Run/Stop bit after the completion of each USB transaction. The next transaction is executed when software sets the Run/Stop bit back to 1.</p> |
| 4 | <p>Force Global Resume (FGR) — R/W. 0 = Software resets this bit to 0 after 20 ms has elapsed to stop sending the Global Resume signal. At that time all USB devices should be ready for bus activity. The 1 to 0 transition causes the port to send a low speed EOP signal. This bit will remain a 1 until the EOP has completed. 1 = Host controller sends the Global Resume signal on the USB, and sets this bit to 1 when a resume event (connect, disconnect, or K-state) is detected while in global suspend mode.</p> |



| Bit | Description |
|-----|-----------------------------------------------------------------------------------------------------------------------------------------------------------------------------------------------------------------------------------------------------------------------------------------------------------------------------------------------------------------------------------------------------------------------------------------------------------------------------------------------------------------------------------------------------------------------------------------------------------------------------------------------------------------------------------------------------------------------------------------------------------------------------------------------------------------------------------------------------------------------------------------------------------------------------------------------------------------------------------------------------------------------------------------------------------------------------------------------------------------------------------------------------------------------------------------------------------------------------------------------------------------------------------------------------------------------------|
| 3 | <p>Enter Global Suspend Mode (EGSM) — R/W.</p> <p>0 = Software resets this bit to 0 to come out of Global Suspend mode. Software writes this bit to 0 at the same time that Force Global Resume (bit 4) is written to 0 or after writing bit 4 to 0.</p> <p>1 = Host controller enters the Global Suspend mode. No USB transactions occur during this time. The Host controller is able to receive resume signals from USB and interrupt the system. Software must ensure that the Run/Stop bit (bit 0) is cleared prior to setting this bit.</p> |
| 2 | <p>Global Reset (GRESET) — R/W.</p> <p>0 = This bit is reset by the software after a minimum of 10 ms has elapsed as specified in Chapter 7 of the USB Specification.</p> <p>1 = Global Reset. The host controller sends the global reset signal on the USB and then resets all its logic, including the internal hub registers. The hub registers are reset to their power on state. Chip Hardware Reset has the same effect as Global Reset (bit 2), except that the host controller does not send the Global Reset on USB.</p> |
| 1 | <p>Host Controller Reset (HCRESET) — R/W. The effects of HCRESET on Hub registers are slightly different from Chip Hardware Reset and Global USB Reset. The HCRESET affects bits [8,3:0] of the Port Status and Control Register (PORTSC) of each port. HCRESET resets the state machines of the host controller including the Connect/Disconnect state machine (one for each port). When the Connect/Disconnect state machine is reset, the output that signals connect/disconnect are negated to 0, effectively signaling a disconnect, even if a device is attached to the port. This virtual disconnect causes the port to be disabled. This disconnect and disabling of the port causes bit 1 (connect status change) and bit 3 (port enable/disable change) of the PORTSC to get set. The disconnect also causes bit 8 of PORTSC to reset. About 64 bit times after HCRESET goes to 0, the connect and low-speed detect will take place, and bits 0 and 8 of the PORTSC will change accordingly.</p> <p>0 = Reset by the host controller when the reset process is complete.</p> <p>1 = Reset. When this bit is set, the host controller module resets its internal timers, counters, state machines, etc. to their initial value. Any transaction currently in progress on USB is immediately terminated.</p> |
| 0 | <p>Run/Stop (RS) — R/W. When set to 1, the ICH10 proceeds with execution of the schedule. The ICH10 continues execution as long as this bit is set. When this bit is cleared, the ICH10 completes the current transaction on the USB and then halts. The HC Halted bit in the status register indicates when the host controller has finished the transaction and has entered the stopped state. The host controller clears this bit when the following fatal errors occur: consistency check failure, or memory access errors.</p> <p>0 = Stop</p> <p>1 = Run</p> <p>NOTE: This bit should only be cleared if there are no active Transaction Descriptors in the executable schedule or software will reset the host controller prior to setting this bit again.</p> |

Table 16-4. Run/Stop, Debug Bit Interaction SWDBG (Bit 5), Run/Stop (Bit 0) Operation

| SWDBG (Bit 5) | Run/Stop (Bit 0) | Description |
|---------------|------------------|----------------------------------------------------------------------------------------------------------------------------------------------------------------------------------------------------------------------------------------------------------------------------------------------------------------------------------------------------------------|
| 0 | 0 | If executing a command, the host controller completes the command and then stops. The 1.0 ms frame counter is reset and command list execution resumes from start of frame using the frame list pointer selected by the current value in the FRNUM register. (While Run/Stop=0, the FRNUM register (BASE + 06h) can be reprogrammed). |
| 0 | 1 | Execution of the command list resumes from Start Of Frame using the frame list pointer selected by the current value in the FRNUM register. The host controller remains running until the Run/Stop bit is cleared (by software or hardware). |
| 1 | 0 | If executing a command, the host controller completes the command and then stops and the 1.0 ms frame counter is frozen at its current value. All status are preserved. The host controller begins execution of the command list from where it left off when the Run/Stop bit is set. |
| 1 | 1 | Execution of the command list resumes from where the previous execution stopped. The Run/Stop bit is set to 0 by the host controller when a TD is being fetched. This causes the host controller to stop again after the execution of the TD (single step). When the host controller has completed execution, the HC Halted bit in the Status Register is set. |

When the USB host controller is in Software Debug Mode (USBCMD Register bit 5=1), the single stepping software debug operation is as follows:

To Enter Software Debug Mode:

1. HCD puts host controller in Stop state by setting the Run/Stop bit to 0.
2. HCD puts host controller in Debug Mode by setting the SWDBG bit to 1.
3. HCD sets up the correct command list and Start Of Frame value for starting point in the Frame List Single Step Loop.
4. HCD sets Run/Stop bit to 1.
5. Host controller executes next active TD, sets Run/Stop bit to 0, and stops.
6. HCD reads the USBCMD register to check if the single step execution is completed (HCHalted=1).
7. HCD checks results of TD execution. Go to step 4 to execute next TD or step 8 to end Software Debug mode.
8. HCD ends Software Debug mode by setting SWDBG bit to 0.
9. HCD sets up normal command list and Frame List table.
10. HCD sets Run/Stop bit to 1 to resume normal schedule execution.

In Software Debug mode, when the Run/Stop bit is set, the host controller starts. When a valid TD is found, the Run/Stop bit is reset. When the TD is finished, the HCHalted bit in the USBSTS register (bit 5) is set.

The SW Debug mode skips over inactive TDs and only halts after an active TD has been executed. When the last active TD in a frame has been executed, the host controller waits until the next SOF is sent and then fetches the first TD of the next frame before halting.



This HCHalted bit can also be used outside of Software Debug mode to indicate when the host controller has detected the Run/Stop bit and has completed the current transaction. Outside of the Software Debug mode, setting the Run/Stop bit to 0 always resets the SOF counter so that when the Run/Stop bit is set the host controller starts over again from the frame list location pointed to by the Frame List Index (see FRNUM Register description) rather than continuing where it stopped.

16.2.2 USBSTS—USB Status Register

I/O Offset: Base + (02h–03h) Attribute: R/WC
 Default Value: 0020h Size: 16 bits

This register indicates pending interrupts and various states of the host controller. The status resulting from a transaction on the serial bus is not indicated in this register.

| Bit | Description |
|------|------------------------------------------------------------------------------------------------------------------------------------------------------------------------------------------------------------------------------------------------------------------------------------------------------------------------------------------------------------------------------------------------------------------------------------------------------------------------------------------------------------------------------------------------------------------------------------------------------------------------------------------------------------|
| 15:6 | Reserved |
| 5 | HCHalted — R/WC. 0 = Software clears this bit by writing a 1 to it. 1 = The host controller has stopped executing as a result of the Run/Stop bit being set to 0, either by software or by the host controller hardware (debug mode or an internal error). Default. |
| 4 | Host Controller Process Error — R/WC. 0 = Software clears this bit by writing a 1 to it. 1 = The host controller has detected a fatal error. This indicates that the host controller suffered a consistency check failure while processing a Transfer Descriptor. An example of a consistency check failure would be finding an invalid PID field while processing the packet header portion of the TD. When this error occurs, the host controller clears the Run/Stop bit in the Command register (D29:F0/F1/F2/F3, D26:F0/F1/F2:BASE + 00h, bit 0) to prevent further schedule execution. A hardware interrupt is generated to the system. |
| 3 | Host System Error — R/WC. 0 = Software clears this bit by writing a 1 to it. 1 = A serious error occurred during a host system access involving the host controller module. In a PCI system, conditions that set this bit to 1 include PCI Parity error, PCI Master Abort, and PCI Target Abort. When this error occurs, the host controller clears the Run/Stop bit in the Command register to prevent further execution of the scheduled TDs. A hardware interrupt is generated to the system. |
| 2 | Resume Detect (RSM_DET) — R/WC. 0 = Software clears this bit by writing a 1 to it. 1 = The host controller received a “RESUME” signal from a USB device. This is only valid if the Host controller is in a global suspend state (Command register, D29:F0/F1/F2/F3, D26:F0/F1/F2:BASE + 00h, bit 3 = 1). |
| 1 | USB Error Interrupt — R/WC. 0 = Software clears this bit by writing a 1 to it. 1 = Completion of a USB transaction resulted in an error condition (e.g., error counter underflow). If the TD on which the error interrupt occurred also had its IOC bit (D29:F0/F1/F2/F3, D26:F0/F1/F2:BASE + 04h, bit 2) set, both this bit and Bit 0 are set. |
| 0 | USB Interrupt (USBINT) — R/WC. 0 = Software clears this bit by writing a 1 to it. 1 = The host controller sets this bit when the cause of an interrupt is a completion of a USB transaction whose Transfer Descriptor had its IOC bit set. Also set when a short packet is detected (actual length field in TD is less than maximum length field in TD), and short packet detection is enabled in that TD. |

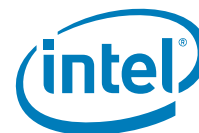

16.2.3 USBINTR—USB Interrupt Enable Register

I/O Offset: Base + (04h–05h) Attribute: R/W
 Default Value: 0000h Size: 16 bits

This register enables and disables reporting of the corresponding interrupt to the software. When a bit is set and the corresponding interrupt is active, an interrupt is generated to the host. Fatal errors (host controller processor error, (D29:F0/F1/F2, D26:F0/F1:BASE + 02h, bit 4, USBSTS Register) cannot be disabled by the host controller. Interrupt sources that are disabled in this register still appear in the Status Register to allow the software to poll for events.

| Bit | Description |
|------|-----------------------------------------------------------------------------------|
| 15:5 | Reserved |
| 4 | Scratchpad (SP) — R/W. |
| 3 | Short Packet Interrupt Enable — R/W. 0 = Disabled. 1 = Enabled. |
| 2 | Interrupt on Complete Enable (IOC) — R/W. 0 = Disabled. 1 = Enabled. |
| 1 | Resume Interrupt Enable — R/W. 0 = Disabled. 1 = Enabled. |
| 0 | Timeout/CRC Interrupt Enable — R/W. 0 = Disabled. 1 = Enabled. |

16.2.4 FRNUM—Frame Number Register

I/O Offset: Base + (06–07h) Attribute: R/W (Writes must be Word Writes)
 Default Value: 0000h Size: 16 bits

Bits [10:0] of this register contain the current frame number that is included in the frame SOF packet. This register reflects the count value of the internal frame number counter. Bits [9:0] are used to select a particular entry in the Frame List during scheduled execution. This register is updated at the end of each frame time.

This register must be written as a word. Byte writes are not supported. This register cannot be written unless the host controller is in the STOPPED state as indicated by the HCHalted bit (D29:F0/F1/F2/F3, D26:F0/F1/F2:BASE + 02h, bit 5). A write to this register while the Run/Stop bit is set (D29:F0/F1/F2/F3, D26:F0/F1/F2:BASE + 00h, bit 0) is ignored.

| Bit | Description |
|-------|-------------------------------------------------------------------------------------------------------------------------------------------------------------------------------------------------------------------------------------------------------------------------------------------------------------------------------|
| 15:11 | Reserved |
| 10:0 | Frame List Current Index/Frame Number — R/W. This field provides the frame number in the SOF Frame. The value in this register increments at the end of each time frame (approximately every 1 ms). In addition, bits [9:0] are used for the Frame List current index and correspond to memory address signals [11:2]. |



16.2.5 FRBASEADD—Frame List Base Address Register

I/O Offset: Base + (08h–0Bh) Attribute: R/W
 Default Value: Undefined Size: 32 bits

This 32-bit register contains the beginning address of the Frame List in the system memory. HCD loads this register prior to starting the schedule execution by the host controller. When written, only the upper 20 bits are used. The lower 12 bits are written as 0s (4 KB alignment). The contents of this register are combined with the frame number counter to enable the host controller to step through the Frame List in sequence. The two least significant bits are always 00. This requires dword-alignment for all list entries. This configuration supports 1024 Frame List entries.

| Bit | Description |
|-------|---------------------------------------------------------------------------------------------------|
| 31:12 | Base Address — R/W. These bits correspond to memory address signals [31:12], respectively. |
| 11:0 | Reserved |

16.2.6 SOFMOD—Start of Frame Modify Register

I/O Offset: Base + (0Ch) Attribute: R/W
 Default Value: 40h Size: 8 bits

This 1-byte register is used to modify the value used in the generation of SOF timing on the USB. Only the 7 least significant bits are used. When a new value is written into these 7 bits, the SOF timing of the next frame will be adjusted. This feature can be used to adjust out any offset from the clock source that generates the clock that drives the SOF counter. This register can also be used to maintain real time synchronization with the rest of the system so that all devices have the same sense of real time. Using this register, the frame length can be adjusted across the full range required by the USB specification. Its initial programmed value is system dependent based on the accuracy of hardware USB clock and is initialized by system BIOS. It may be reprogrammed by USB system software at any time. Its value will take effect from the beginning of the next frame. This register is reset upon a host controller reset or global reset. Software must maintain a copy of its value for reprogramming if necessary.

| Bit | Description | | | | | | | | | | | | | | | | | | | | |
|---------------------------------------------|----------------------------------------------------------------------------------------------------------------------------------------------------------------------------------------------------------------------------------------------------------------------------------------------------------------------------------------------------------------------------------------------------------------------------------------------------------------------------------------------------------------------------------------------------------------------------------------------------------------------------------------------------------------------------------------------------------------------------------------------------------------------------------------------------------------------------------------------------------------------------------------------------------------------------------------------------------------------------------------------------------------------------------------------|---------------------------------------------|-----------------------------------------------|-------|---|-------|---|---|---|-------|----|-------|----|-------|----|---|---|-------|-----|-------|-----|
| 7 | Reserved | | | | | | | | | | | | | | | | | | | | |
| 6:0 | <p>SOF Timing Value — R/W. Guidelines for the modification of frame time are contained in Chapter 7 of the USB Specification. The SOF cycle time (number of SOF counter clock periods to generate a SOF frame length) is equal to 11936 + value in this field. The default value is decimal 64 which gives a SOF cycle time of 12000. For a 12 MHz SOF counter clock input, this produces a 1 ms Frame period. The following table indicates what SOF Timing Value to program into this field for a certain frame period.</p> <table border="1"> <thead> <tr> <th>Frame Length (# 12 MHz Clocks) (decimal)</th> <th>SOF Timing Value (this register) (decimal)</th> </tr> </thead> <tbody> <tr><td>11936</td><td>0</td></tr> <tr><td>11937</td><td>1</td></tr> <tr><td>—</td><td>—</td></tr> <tr><td>11999</td><td>63</td></tr> <tr><td>12000</td><td>64</td></tr> <tr><td>12001</td><td>65</td></tr> <tr><td>—</td><td>—</td></tr> <tr><td>12062</td><td>126</td></tr> <tr><td>12063</td><td>127</td></tr> </tbody> </table> | Frame Length (# 12 MHz Clocks) (decimal) | SOF Timing Value (this register) (decimal) | 11936 | 0 | 11937 | 1 | — | — | 11999 | 63 | 12000 | 64 | 12001 | 65 | — | — | 12062 | 126 | 12063 | 127 |
| Frame Length (# 12 MHz Clocks) (decimal) | SOF Timing Value (this register) (decimal) | | | | | | | | | | | | | | | | | | | | |
| 11936 | 0 | | | | | | | | | | | | | | | | | | | | |
| 11937 | 1 | | | | | | | | | | | | | | | | | | | | |
| — | — | | | | | | | | | | | | | | | | | | | | |
| 11999 | 63 | | | | | | | | | | | | | | | | | | | | |
| 12000 | 64 | | | | | | | | | | | | | | | | | | | | |
| 12001 | 65 | | | | | | | | | | | | | | | | | | | | |
| — | — | | | | | | | | | | | | | | | | | | | | |
| 12062 | 126 | | | | | | | | | | | | | | | | | | | | |
| 12063 | 127 | | | | | | | | | | | | | | | | | | | | |

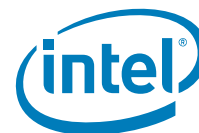

16.2.7 PORTSC[0,1]—Port Status and Control Register

I/O Offset: Port 0/2/4/6/8/10: Base + (10h–11h) Attribute: R/WC, RO,
 Port 1/3/5/7/9/11: Base + (12h–13h) R/W (Word writes only)
 Default Value: 0080h Size: 16 bits

Note: For UHCI #1 (D29:F0), this applies to ICH10 USB ports 0 and 1; for UHCI #2 (D29:F1), this applies to ICH10 USB ports 2 and 3; for UHCI #3 (D29:F2), this applies to ICH10 USB ports 4 and 5, for UHCI #4 (D26:F0), this applies to ICH10 USB ports 6 and 7, for UHCI #5 (D26:F1), this applies to ICH10 USB ports 8 and 9 and for UHCI #6 (D26:F2 or D29:F3), this applies to ICH10 USB ports 10 and 11.

After a power-up reset, global reset, or host controller reset, the initial conditions of a port are: no device connected, Port disabled, and the bus line status is 00 (single-ended 0).

Port Reset and Enable Sequence

When software wishes to reset a USB device it will assert the Port Reset bit in the Port Status and Control register. The minimum reset signaling time is 10 mS and is enforced by software. To complete the reset sequence, software clears the port reset bit. The Intel UHCI controller must re-detect the port connect after reset signaling is complete before the controller will allow the port enable bit to be set by software. This time is approximately 5.3 μs. Software has several possible options to meet the timing requirement and a partial list is enumerated below:

- Iterate a short wait, setting the port enable bit and reading it back to see if the enable bit is set.
- Poll the connect status bit and wait for the hardware to recognize the connect prior to enabling the port.
- Wait longer than the hardware detect time after clearing the port reset and prior to enabling the port.

| Bit | Description | | | | | | | | |
|-------------|----------------------------------------------------------------------------------------------------------------------------------------------------------------------------------------------------------------------------------------------------------------------------------------------------------------------------------------------------------------------------------------------------------------------------------------------------------------------------------------------------------------------------------------------------------------------------------------------------------------------------------------------------------------------------------------------------------------------------------------------------------------------------------------------------------------------------------------------------------------------------------------------------------------------------------------------------------------------------------------------------------------------------------------------------------------------------------------------------------------------------------------------------------------------------------------------------------------------------------------------------------------------------------------------------------------------------------------------------------------------------------------------------------------|-------------|-----------|-----|---------|------|--------|------|---------|
| 15:13 | Reserved. | | | | | | | | |
| 12 | <p>Suspend — R/W. This bit should not be written to a 1 if global suspend is active (bit 3=1 in the USBCMD register). Bit 2 and bit 12 of this register define the hub states as follows:</p> <table border="1"> <thead> <tr> <th>Bits [12,2]</th> <th>Hub State</th> </tr> </thead> <tbody> <tr> <td>X,0</td> <td>Disable</td> </tr> <tr> <td>0, 1</td> <td>Enable</td> </tr> <tr> <td>1, 1</td> <td>Suspend</td> </tr> </tbody> </table> <p>When in suspend state, downstream propagation of data is blocked on this port, except for single-ended 0 resets (global reset and port reset). The blocking occurs at the end of the current transaction, if a transaction was in progress when this bit was written to 1. In the suspend state, the port is sensitive to resume detection. Note that the bit status does not change until the port is suspended and that there may be a delay in suspending a port if there is a transaction currently in progress on the USB. 1 = Port in suspend state. 0 = Port not in suspend state.</p> <p>NOTE: Normally, if a transaction is in progress when this bit is set, the port will be suspended when the current transaction completes. However, in the case of a specific error condition (out transaction with babble), the ICH10 may issue a start-of-frame, and then suspend the port.</p> | Bits [12,2] | Hub State | X,0 | Disable | 0, 1 | Enable | 1, 1 | Suspend |
| Bits [12,2] | Hub State | | | | | | | | |
| X,0 | Disable | | | | | | | | |
| 0, 1 | Enable | | | | | | | | |
| 1, 1 | Suspend | | | | | | | | |
| 11 | <p>Overcurrent Indicator — R/WC. Set by hardware.</p> <p>0 = Software clears this bit by writing a 1 to it. 1 = Overcurrent pin has gone from inactive to active on this port.</p> | | | | | | | | |



| Bit | Description |
|-----|--------------------------------------------------------------------------------------------------------------------------------------------------------------------------------------------------------------------------------------------------------------------------------------------------------------------------------------------------------------------------------------------------------------------------------------------------------------------------------------------------------------------------------------------------------------------------------------------------------------------------------------------------------------------------------------------------------------------------------------------------------------------------------------------------------------------------|
| 10 | Overcurrent Active — RO. This bit is set and cleared by hardware. 0 = Indicates that the overcurrent pin is inactive (high). 1 = Indicates that the overcurrent pin is active (low). |
| 9 | Port Reset — R/W. 0 = Port is not in Reset. 1 = Port is in Reset. When set, the port is disabled and sends the USB Reset signaling. |
| 8 | Low Speed Device Attached (LS) — RO. 0 = Full speed device is attached. 1 = Low speed device is attached to this port. |
| 7 | Reserved — RO. Always read as 1. |
| 6 | Resume Detect (RSM_DET) — R/W. Software sets this bit to a 1 to drive resume signaling. The host controller sets this bit to a 1 if a J-to-K transition is detected for at least 32 microseconds while the port is in the Suspend state. The ICH10 will then reflect the K-state back onto the bus as long as the bit remains a 1, and the port is still in the suspend state (bit 12,2 are '11'). Writing a 0 (from 1) causes the port to send a low speed EOP. This bit will remain a 1 until the EOP has completed. 0 = No resume (K-state) detected/driven on port. 1 = Resume detected/driven on port. |
| 5:4 | Line Status — RO. These bits reflect the D+ (bit 4) and D- (bit 5) signals lines' logical levels. These bits are used for fault detect and recovery as well as for USB diagnostics. This field is updated at EOF2 time (See Chapter 11 of the USB Specification). |
| 3 | Port Enable/Disable Change — R/WC. For the root hub, this bit gets set only when a port is disabled due to disconnect on that port or due to the appropriate conditions existing at the EOF2 point (See Chapter 11 of the USB Specification). 0 = No change. Software clears this bit by writing a 1 to the bit location. 1 = Port enabled/disabled status has changed. |
| 2 | Port Enabled/Disabled (PORT_EN) — R/W. Ports can be enabled by host software only. Ports can be disabled by either a fault condition (disconnect event or other fault condition) or by host software. Note that the bit status does not change until the port state actually changes and that there may be a delay in disabling or enabling a port if there is a transaction currently in progress on the USB. 0 = Disable 1 = Enable |
| 1 | Connect Status Change — R/WC. This bit indicates that a change has occurred in the port's Current Connect Status (see bit 0). The hub device sets this bit for any changes to the port device connect status, even if system software has not cleared a connect status change. If, for example, the insertion status changes twice before system software has cleared the changed condition, hub hardware will be setting" an already-set bit (i.e., the bit will remain set). However, the hub transfers the change bit only once when the host controller requests a data transfer to the Status Change endpoint. System software is responsible for determining state change history in such a case. 0 = No change. Software clears this bit by writing a 1 to it. 1 = Change in Current Connect Status. |
| 0 | Current Connect Status — RO. This value reflects the current state of the port, and may not correspond directly to the event that caused the Connect Status Change bit (Bit 1) to be set. 0 = No device is present. 1 = Device is present on port. |

§ §



17 EHCI Controller Registers (D29:F7, D26:F7)

17.1 USB EHCI Configuration Registers (USB EHCI—D29:F7, D26:F7)

Note: Register address locations that are not shown in Table 17-1 should be treated as Reserved (see Section 9.2 for details).

Table 17-1. USB EHCI PCI Register Address Map (USB EHCI—D29:F7, D26:F7) (Sheet 1 of 2)

| Offset | Mnemonic | Register Name | Default Value | Type |
|---------|--------------|------------------------------------------|--------------------------|---------------|
| 00h–01h | VID | Vendor Identification | 8086h | RO |
| 02h–03h | DID | Device Identification | See register description | RO |
| 04h–05h | PCICMD | PCI Command | 0000h | R/W, RO |
| 06h–07h | PCISTS | PCI Status | 0290h | R/WC, RO |
| 08h | RID | Revision Identification | See register description | RO |
| 09h | PI | Programming Interface | 20h | RO |
| 0Ah | SCC | Sub Class Code | 03h | RO |
| 0Bh | BCC | Base Class Code | 0Ch | RO |
| 0Dh | PMLT | Primary Master Latency Timer | 00h | RO |
| 10h–13h | MEM_BASE | Memory Base Address | 00000000h | R/W, RO |
| 2Ch–2Dh | SVID | USB EHCI Subsystem Vendor Identification | XXXXh | R/W |
| 2Eh–2Fh | SID | USB EHCI Subsystem Identification | XXXXh | R/W |
| 34h | CAP_PTR | Capabilities Pointer | 50h | RO |
| 3Ch | INT_LN | Interrupt Line | 00h | R/W |
| 3Dh | INT_PN | Interrupt Pin | See register description | RO |
| 50h | PWR_CAPID | PCI Power Management Capability ID | 01h | RO |
| 51h | NXT_PTR1 | Next Item Pointer | 58h | R/W |
| 52h–53h | PWR_CAP | Power Management Capabilities | C9C2h | R/W |
| 54h–55h | PWR_CNTL_STS | Power Management Control/Status | 0000h | R/W, R/WC, RO |
| 58h | DEBUG_CAPID | Debug Port Capability ID | 0Ah | RO |
| 59h | NXT_PTR2 | Next Item Pointer #2 | 98h | RO |
| 5Ah–5Bh | DEBUG_BASE | Debug Port Base Offset | 20A0h | RO |
| 60h | USB_RELNUM | USB Release Number | 20h | RO |



Table 17-1. USB EHCI PCI Register Address Map (USB EHCI—D29:F7, D26:F7) (Sheet 2 of 2)

| Offset | Mnemonic | Register Name | Default Value | Type |
|---------|-------------|-------------------------------------------------|---------------|---------------|
| 61h | FL_ADJ | Frame Length Adjustment | 20h | R/W |
| 62h–63h | PWAKE_CAP | Port Wake Capabilities | 01FFh | R/W |
| 64h–67h | — | Reserved | — | — |
| 68h–6Bh | LEG_EXT_CAP | USB EHCI Legacy Support Extended Capability | 00000001h | R/W, RO |
| 6Ch–6Fh | LEG_EXT_CS | USB EHCI Legacy Extended Support Control/Status | 00000000h | R/W, R/WC, RO |
| 70h–73h | SPECIAL_SMI | Intel Specific USB 2.0 SMI | 00000000h | R/W, R/WC |
| 74h–7Fh | — | Reserved | — | — |
| 80h | ACCESS_CNTL | Access Control | 00h | R/W |
| 84h | EHCIIR1 | EHCI Initialization Register 1 | 01h | R/W, RWL |
| 98h | FLR_CID | FLR Capability ID | 09h | RO |
| 99h | FLR_NEXT | FLR Next Capability Pointer | 00h | RO |
| 9Ah–9Bh | FLR_CLV | FLR Capability Length and Version | 2006h | RO, R/WO |
| 9Ch | FLR_CTRL | FLR Control | 00h | R/W |
| 9Dh | FLR_STAT | FLR Status | 00h | RO |
| FCh | EHCIIR2 | EHCI Initialization Register 2 | 20001706h | R/W |

Note: All configuration registers in this section are in the core well and reset by a core well reset and the D3-to-DO warm reset, except as noted.

17.1.1 VID—Vendor Identification Register (USB EHCI—D29:F7, D26:F7)

Offset Address: 00h–01h Attribute: RO
 Default Value: 8086h Size: 16 bits

| Bit | Description |
|------|------------------------------------------------------------------|
| 15:0 | Vendor ID — RO. This is a 16-bit value assigned to Intel. |

17.1.2 DID—Device Identification Register (USB EHCI—D29:F7, D26:F7)

Offset Address: 02h–03h Attribute: RO
 Default Value: See bit description Size: 16 bits

| Bit | Description |
|------|----------------------------------------------------------------------------------------------------------------------------------------------------------------------------------------------------------------------------|
| 15:0 | Device ID — RO. This is a 16-bit value assigned to the Intel® ICH10 USB EHCI controller. Refer to the <i>Intel® I/O Controller Hub (ICH10) Family Specification Update</i> for the value of the Device ID Register. |



17.1.3 PCI CMD—PCI Command Register (USB EHCI—D29:F7, D26:F7)

Address Offset: 04h–05h
Default Value: 0000h

Attribute: R/W, RO
Size: 16 bits

| Bit | Description |
|-------|-------------------------------------------------------------------------------------------------------------------------------------------------------------------------------------------------------------------------------------------------------------------------------------------------------------------------------------------------------------------------------------------------------------------------------------------------------------------------------------------------------------------------------------------------------------------------------------------------------------------------------------------------------------------------------------------------------------------------|
| 15:11 | Reserved |
| 10 | <p>Interrupt Disable — R/W.</p> <p>0 = The function is capable of generating interrupts. 1 = The function can not generate its interrupt to the interrupt controller.</p> <p>Note that the corresponding Interrupt Status bit (D29:F7, D26:F7:06h, bit 3) is not affected by the interrupt enable.</p> |
| 9 | Fast Back to Back Enable (FBE) — RO. Hardwired to 0. |
| 8 | <p>SERR# Enable (SERR_EN) — R/W</p> <p>0 = Disables EHC's capability to generate an SERR#. 1 = The Enhanced Host Controller (EHC) is capable of generating (internally) SERR# in the following cases:</p> <ul style="list-style-type: none"> When it receives a completion status other than "successful" for one of its DMA -initiated memory reads on DMI (and subsequently on its internal interface). When it detects an address or command parity error and the Parity Error Response bit is set. When it detects a data parity error (when the data is going into the EHC) and the Parity Error Response bit is set. |
| 7 | Wait Cycle Control (WCC) — RO. Hardwired to 0. |
| 6 | <p>Parity Error Response (PER) — R/W.</p> <p>0 = The EHC is not checking for correct parity (on its internal interface). 1 = The EHC is checking for correct parity (on its internal interface) and halt operation when bad parity is detected during the data phase.</p> <p>NOTE: If the EHC detects bad parity on the address or command phases when the bit is set to 1, the host controller does not take the cycle. It halts the host controller (if currently not halted) and sets the Host System Error bit in the USBSTS register. This applies to both requests and completions from the system interface.</p> <p>This bit must be set in order for the parity errors to generate SERR#.</p> |
| 5 | VGA Palette Snoop (VPS) — RO. Hardwired to 0. |
| 4 | Postable Memory Write Enable (PMWE) — RO. Hardwired to 0. |
| 3 | Special Cycle Enable (SCE) — RO. Hardwired to 0. |
| 2 | <p>Bus Master Enable (BME) — R/W.</p> <p>0 = Disables this functionality. 1 = Enables the ICH10 to act as a master on the PCI bus for USB transfers.</p> |
| 1 | <p>Memory Space Enable (MSE) — R/W. This bit controls access to the USB 2.0 Memory Space registers.</p> <p>0 = Disables this functionality. 1 = Enables accesses to the USB 2.0 registers. The Base Address register (D29:F7, D26:F7:10h) for USB 2.0 should be programmed before this bit is set.</p> |
| 0 | I/O Space Enable (IOSE) — RO. Hardwired to 0. |

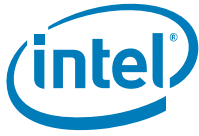

17.1.4 PCISTS—PCI Status Register (USB EHCI—D29:F7, D26:F7)

Address Offset: 06h–07h
 Default Value: 0290h

Attribute: R/WC, RO
 Size: 16 bits

Note: For the writable bits, software must write a 1 to clear bits that are set. Writing a 0 to the bit has no effect.

| Bit | Description |
|------|--------------------------------------------------------------------------------------------------------------------------------------------------------------------------------------------------------------------------------------------------------------------------------------------------------------------------------------------------------------------------|
| 15 | Detected Parity Error (DPE) — R/WC. 0 = No parity error detected. 1 = This bit is set by the ICH10 when a parity error is seen by the EHCI controller, regardless of the setting of bit 6 or bit 8 in the Command register or any other conditions. |
| 14 | Signaled System Error (SSE) — R/WC. 0 = No SERR# signaled by ICH10. 1 = This bit is set by the ICH10 when it signals SERR# (internally). The SER_EN bit (bit 8 of the Command Register) must be 1 for this bit to be set. |
| 13 | Received Master Abort (RMA) — R/WC. 0 = No master abort received by EHC on a memory access. 1 = This bit is set when EHC, as a master, receives a master abort status on a memory access. This is treated as a Host Error and halts the DMA engines. This event can optionally generate an SERR# by setting the SERR# Enable bit. |
| 12 | Received Target Abort (RTA) — R/WC. 0 = No target abort received by EHC on memory access. 1 = This bit is set when EHC, as a master, receives a target abort status on a memory access. This is treated as a Host Error and halts the DMA engines. This event can optionally generate an SERR# by setting the SERR# Enable bit (D29:F7, D26:F7:04h, bit 8). |
| 11 | Signaled Target Abort (STA) — RO. This bit is used to indicate when the EHCI function responds to a cycle with a target abort. There is no reason for this to happen, so this bit is hardwired to 0. |
| 10:9 | DEVSEL# Timing Status (DEVT_STS) — RO. This 2-bit field defines the timing for DEVSEL# assertion. |
| 8 | Master Data Parity Error Detected (DPED) — R/WC. 0 = No data parity error detected on USB2.0 read completion packet. 1 = This bit is set by the ICH10 when a data parity error is detected on a USB 2.0 read completion packet on the internal interface to the EHCI host controller and bit 6 of the Command register is set to 1. |
| 7 | Fast Back to Back Capable (FB2BC) — RO. Hardwired to 1. |
| 6 | User Definable Features (UDF) — RO. Hardwired to 0. |
| 5 | 66 MHz Capable (66 MHz _CAP) — RO. Hardwired to 0. |
| 4 | Capabilities List (CAP_LIST) — RO. Hardwired to 1 indicating that offset 34h contains a valid capabilities pointer. |
| 3 | Interrupt Status — RO. This bit reflects the state of this function’s interrupt at the input of the enable/disable logic. 0 = This bit will be 0 when the interrupt is deasserted. 1 = This bit is a 1 when the interrupt is asserted. The value reported in this bit is independent of the value in the Interrupt Enable bit. |
| 2:0 | Reserved |



17.1.5 RID—Revision Identification Register (USB EHCI—D29:F7, D26:F7)

Offset Address: 08h Attribute: RO
Default Value: See bit description Size: 8 bits

| Bit | Description |
|-----|------------------------------------------------------------------------------------------------------------------------------------------------------|
| 7:0 | Revision ID — RO. Refer to the <i>Intel® I/O Controller Hub (ICH10) Family Specification Update</i> for the value of the Revision ID Register |

17.1.6 PI—Programming Interface Register (USB EHCI—D29:F7, D26:F7)

Address Offset: 09h Attribute: RO
Default Value: 20h Size: 8 bits

| Bit | Description |
|-----|-----------------------------------------------------------------------------------------------------------------------------------|
| 7:0 | Programming Interface — RO. A value of 20h indicates that this USB 2.0 host controller conforms to the EHCI Specification. |

17.1.7 SCC—Sub Class Code Register (USB EHCI—D29:F7, D26:F7)

Address Offset: 0Ah Attribute: RO
Default Value: 03h Size: 8 bits

| Bit | Description |
|-----|----------------------------------------------------------------------------------|
| 7:0 | Sub Class Code (SCC) — RO. 03h = Universal serial bus host controller. |

17.1.8 BCC—Base Class Code Register (USB EHCI—D29:F7, D26:F7)

Address Offset: 0Bh Attribute: RO
Default Value: 0Ch Size: 8 bits

| Bit | Description |
|-----|--------------------------------------------------------------------|
| 7:0 | Base Class Code (BCC) — RO. 0Ch = Serial bus controller. |



17.1.18 PWR_CAP—Power Management Capabilities Register (USB EHCI—D29:F7, D26:F7)

Address Offset: 52h–53h Attribute: R/W, RO
 Default Value: C9C2h Size: 16 bits

| Bit | Description |
|-------|-------------------------------------------------------------------------------------------------------------------------------------------------------------------------------------------------------------------------------------------------------------------------------------------------------|
| 15:11 | PME Support (PME_SUP) — R/W. This 5-bit field indicates the power states in which the function may assert PME#. The Intel® ICH10 EHC does not support the D1 or D2 states. For all other states, the ICH10 EHC is capable of generating PME#. Software should never need to modify this field. |
| 10 | D2 Support (D2_SUP) — RO. 0 = D2 State is not supported |
| 9 | D1 Support (D1_SUP) — RO. 0 = D1 State is not supported |
| 8:6 | Auxiliary Current (AUX_CUR) — R/W. The ICH10 EHC reports 375 mA maximum suspend well current required when in the D3 _{COLD} state. |
| 5 | Device Specific Initialization (DSI) — RO. The ICH10 reports 0, indicating that no device-specific initialization is required. |
| 4 | Reserved |
| 3 | PME Clock (PME_CLK) — RO. The ICH10 reports 0, indicating that no PCI clock is required to generate PME#. |
| 2:0 | Version (VER) — RO. The ICH10 reports 010b, indicating that it complies with Revision 1.1 of the PCI Power Management Specification. |

NOTES:

- Normally, this register is read-only to report capabilities to the power management software. To report different power management capabilities, depending on the system in which the ICH10 is used, bits 15:11 and 8:6 in this register are writable when the WRT_RDONLY bit (D29:F7, D26:F7:80h, bit 0) is set. The value written to this register does not affect the hardware other than changing the value returned during a read.
- Reset: core well, but not D3-to-D0 warm reset.



17.1.19 PWR_CNTL_STS—Power Management Control/Status Register (USB EHCI—D29:F7, D26:F7)

Address Offset: 54h–55h Attribute: R/W, R/WC, RO
 Default Value: 0000h Size: 16 bits
 Function Level Reset: No (Bits 8 and 15 only)

| Bit | Description |
|-------|------------------------------------------------------------------------------------------------------------------------------------------------------------------------------------------------------------------------------------------------------------------------------------------------------------------------------------------------------------------------------------------------------------------------------------------------------------------------------------------------------------------------------------------------------------------------------------------------------------------------------------------------------------------------------------------------------------------------------------------------------------------------------------------------------------------------------------------------------------------------------------------------------------------------------------------------------------|
| 15 | <p>PME Status — R/WC. 0 = Writing a 1 to this bit will clear it and cause the internal PME to deassert (if enabled). 1 = This bit is set when the ICH10 EHC would normally assert the PME# signal independent of the state of the PME_En bit.</p> <p>NOTE: This bit must be explicitly cleared by the operating system each time the operating system is loaded. This bit is not reset by Function Level Reset.</p> |
| 14:13 | Data Scale — RO. Hardwired to 00b indicating it does not support the associated Data register. |
| 12:9 | Data Select — RO. Hardwired to 0000b indicating it does not support the associated Data register. |
| 8 | <p>PME Enable — R/W. 0 = Disable. 1 = Enables Intel® ICH10 EHC to generate an internal PME signal when PME_Status is 1.</p> <p>NOTE: This bit must be explicitly cleared by the operating system each time it is initially loaded. This bit is not reset by Function Level Reset.</p> |
| 7:2 | Reserved |
| 1:0 | <p>Power State — R/W. This 2-bit field is used both to determine the current power state of EHC function and to set a new power state. The definition of the field values are: 00 = D0 state 11 = D3_{HOT} state</p> <p>If software attempts to write a value of 10b or 01b in to this field, the write operation must complete normally; however, the data is discarded and no state change occurs. When in the D3_{HOT} state, the ICH10 must not accept accesses to the EHC memory range; but the configuration space must still be accessible. When not in the D0 state, the generation of the interrupt output is blocked. Specifically, the PIRQH is not asserted by the ICH10 when not in the D0 state.</p> <p>When software changes this value from the D3_{HOT} state to the D0 state, an internal warm (soft) reset is generated, and software must re-initialize the function.</p> |

NOTE: Reset (bits 15, 8): suspend well, and not D3-to-D0 warm reset nor core well reset.



17.1.25 PWAKE_CAP—Port Wake Capability Register (USB EHCI—D29:F7, D26:F7)

Address Offset: 62–63h Attribute: R/W
 Default Value: 01FFh Size: 16 bits
 Function Level Reset: No

This register is in the suspend power well. The intended use of this register is to establish a policy about which ports are to be used for wake events. Bit positions 1–8(D29) or 1–6(D26) in the mask correspond to a physical port implemented on the current EHCI controller. A 1 in a bit position indicates that a device connected below the port can be enabled as a wake-up device and the port may be enabled for disconnect/connect or overcurrent events as wake-up events. This is an information-only mask register. The bits in this register **do not** affect the actual operation of the EHCI host controller. The system-specific policy can be established by BIOS initializing this register to a system-specific value. System software uses the information in this register when enabling devices and ports for remote wake-up.

These bits are not reset by a D3-to-D0 warm rest or a core well reset.

| Bit | Description |
|--------------------------|------------------------------------------------------------------------------------------------------------------------------------------------------------------------------------------------------------------------------------------------------------------------------|
| 15:9 (D29) 15:7 (D26) | Reserved. |
| 8:1 (D29) 6:1 (D26) | Port Wake Up Capability Mask — R/W. Bit positions 1 through 8 (Device 29) or 1 through 6 (Device 26) correspond to a physical port implemented on this host controller. For example, bit position 1 corresponds to port 1, bit position 2 corresponds to port 2, etc. |
| 0 | Port Wake Implemented — R/W. A 1 in this bit indicates that this register is implemented to software. |



17.1.26 LEG_EXT_CAP—USB EHCI Legacy Support Extended Capability Register (USB EHCI—D29:F7, D26:F7)

Address Offset: 68–6Bh Attribute: R/W, RO
 Default Value: 00000001h Size: 32 bits
 Power Well: Suspend
 Function Level Reset: No

Note: These bits are not reset by a D3-to-D0 warm rest or a core well reset.

| Bit | Description |
|-------|-------------------------------------------------------------------------------------------------------------------------------------------------------------------------------------------------------------------------------|
| 31:25 | Reserved — RO. Hardwired to 00h |
| 24 | HC OS Owned Semaphore — R/W. System software sets this bit to request ownership of the EHCI controller. Ownership is obtained when this bit reads as 1 and the HC BIOS Owned Semaphore bit reads as clear. |
| 23:17 | Reserved — RO. Hardwired to 00h |
| 16 | HC BIOS Owned Semaphore — R/W. The BIOS sets this bit to establish ownership of the EHCI controller. System BIOS will clear this bit in response to a request for ownership of the EHCI controller by system software. |
| 15:8 | Next EHCI Capability Pointer — RO. Hardwired to 00h to indicate that there are no EHCI Extended Capability structures in this device. |
| 7:0 | Capability ID — RO. Hardwired to 01h to indicate that this EHCI Extended Capability is the Legacy Support Capability. |

17.1.27 LEG_EXT_CS—USB EHCI Legacy Support Extended Control / Status Register (USB EHCI—D29:F7, D26:F7)

Address Offset: 6C–6Fh Attribute: R/W, R/WC, RO
 Default Value: 00000000h Size: 32 bits
 Power Well: Suspend
 Function Level Reset: No

Note: These bits are not reset by a D3-to-D0 warm rest or a core well reset.

| Bit | Description |
|-------|-------------------------------------------------------------------------------------------------------------------------------------------------------------------------------------------------------------------------------------------------------------------------------------------------|
| 31 | SMI on BAR — R/WC. Software clears this bit by writing a 1 to it. 0 = Base Address Register (BAR) not written. 1 = This bit is set to 1 when the Base Address Register (BAR) is written. |
| 30 | SMI on PCI Command — R/WC. Software clears this bit by writing a 1 to it. 0 = PCI Command (PCICMD) Register Not written. 1 = This bit is set to 1 when the PCI Command (PCICMD) Register is written. |
| 29 | SMI on OS Ownership Change — R/WC. Software clears this bit by writing a 1 to it. 0 = No HC OS Owned Semaphore bit change. 1 = This bit is set to 1 when the HC OS Owned Semaphore bit in the LEG_EXT_CAP register (D29:F7, D26:F7:68h, bit 24) transitions from 1 to 0 or 0 to 1. |
| 28:22 | Reserved. |



| Bit | Description |
|------|--------------------------------------------------------------------------------------------------------------------------------------------------------------------------------------------------------------------------------------------------------------------------------------------------------------------|
| 21 | <p>SMI on Async Advance — RO. This bit is a shadow bit of the Interrupt on Async Advance bit (D29:F7, D26:F7:CAPLENGTH + 24h, bit 5) in the USB2.0_STS register.</p> <p>NOTE: To clear this bit system software must write a 1 to the Interrupt on Async Advance bit in the USB2.0_STS register.</p> |
| 20 | <p>SMI on Host System Error — RO. This bit is a shadow bit of Host System Error bit in the USB2.0_STS register (D29:F7, D26:F7:CAPLENGTH + 24h, bit 4).</p> <p>NOTE: To clear this bit system software must write a 1 to the Host System Error bit in the USB2.0_STS register.</p> |
| 19 | <p>SMI on Frame List Rollover — RO. This bit is a shadow bit of Frame List Rollover bit (D29:F7, D26:F7:CAPLENGTH + 24h, bit 3) in the USB2.0_STS register.</p> <p>NOTE: To clear this bit system software must write a 1 to the Frame List Rollover bit in the USB2.0_STS register.</p> |
| 18 | <p>SMI on Port Change Detect — RO. This bit is a shadow bit of Port Change Detect bit (D29:F7, D26:F7:CAPLENGTH + 24h, bit 2) in the USB2.0_STS register.</p> <p>NOTE: To clear this bit system software must write a 1 to the Port Change Detect bit in the USB2.0_STS register.</p> |
| 17 | <p>SMI on USB Error — RO. This bit is a shadow bit of USB Error Interrupt (USBERRINT) bit (D29:F7, D26:F7:CAPLENGTH + 24h, bit 1) in the USB2.0_STS register.</p> <p>NOTE: To clear this bit system software must write a 1 to the USB Error Interrupt bit in the USB2.0_STS register.</p> |
| 16 | <p>SMI on USB Complete — RO. This bit is a shadow bit of USB Interrupt (USBINT) bit (D29:F7, D26:F7:CAPLENGTH + 24h, bit 0) in the USB2.0_STS register.</p> <p>NOTE: To clear this bit system software must write a 1 to the USB Interrupt bit in the USB2.0_STS register.</p> |
| 15 | <p>SMI on BAR Enable — R/W.</p> <p>0 = Disable. 1 = Enable. When this bit is 1 and SMI on BAR (D29:F7, D26:F7:6Ch, bit 31) is 1, then the host controller will issue an SMI.</p> |
| 14 | <p>SMI on PCI Command Enable — R/W.</p> <p>0 = Disable. 1 = Enable. When this bit is 1 and SMI on PCI Command (D29:F7, D26:F7:6Ch, bit 30) is 1, then the host controller will issue an SMI.</p> |
| 13 | <p>SMI on OS Ownership Enable — R/W.</p> <p>0 = Disable. 1 = Enable. When this bit is a 1 AND the OS Ownership Change bit (D29:F7, D26:F7:6Ch, bit 29) is 1, the host controller will issue an SMI.</p> |
| 12:6 | Reserved. |
| 5 | <p>SMI on Async Advance Enable — R/W.</p> <p>0 = Disable. 1 = Enable. When this bit is a 1, and the SMI on Async Advance bit (D29:F7, D26:F7:6Ch, bit 21) is a 1, the host controller will issue an SMI immediately.</p> |
| 4 | <p>SMI on Host System Error Enable — R/W.</p> <p>0 = Disable. 1 = Enable. When this bit is a 1, and the SMI on Host System Error (D29:F7, D26:F7:6Ch, bit 20) is a 1, the host controller will issue an SMI.</p> |

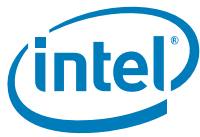

| Bit | Description |
|-----|-------------------------------------------------------------------------------------------------------------------------------------------------------------------------------------------------------------------------|
| 3 | SMI on Frame List Rollover Enable — R/W. 0 = Disable. 1 = Enable. When this bit is a 1, and the SMI on Frame List Rollover bit (D29:F7, D26:F7:6Ch, bit 19) is a 1, the host controller will issue an SMI. |
| 2 | SMI on Port Change Enable — R/W. 0 = Disable. 1 = Enable. When this bit is a 1, and the SMI on Port Change Detect bit (D29:F7, D26:F7:6Ch, bit 18) is a 1, the host controller will issue an SMI. |
| 1 | SMI on USB Error Enable — R/W. 0 = Disable. 1 = Enable. When this bit is a 1, and the SMI on USB Error bit (D29:F7, D26:F7:6Ch, bit 17) is a 1, the host controller will issue an SMI immediately. |
| 0 | SMI on USB Complete Enable — R/W. 0 = Disable. 1 = Enable. When this bit is a 1, and the SMI on USB Complete bit (D29:F7, D26:F7:6Ch, bit 16) is a 1, the host controller will issue an SMI immediately. |

17.1.28 SPECIAL_SMI—Intel Specific USB 2.0 SMI Register (USB EHCI—D29:F7, D26:F7)

Address Offset: 70h–73h Attribute: R/W, R/WC
 Default Value: 00000000h Size: 32 bits
 Power Well: Suspend
 Function Level Reset: No

Note: These bits are not reset by a D3-to-D0 warm rest or a core well reset.

| Bit | Description |
|----------------------------------|-----------------------------------------------------------------------------------------------------------------------------------------------------------------------------------------------------------------------------------------------------------------------------------------------------------------------|
| 31:30 (D29) 31:28 (D26) | Reserved. |
| 29:22 (D29) 27:22 (D26) | SMI on PortOwner — R/WC. Software clears these bits by writing a 1 to it. 0 = No Port Owner bit change. 1 = Bits 29:22, 27:22 correspond to the Port Owner bits for ports 1 (22) through 6 (27) or 8 (29). These bits are set to 1 when the associated Port Owner bits transition from 0 to 1 or 1 to 0. |
| 21 | SMI on PMCSR — R/WC. Software clears these bits by writing a 1 to it. 0 = Power State bits Not modified. 1 = Software modified the Power State bits in the Power Management Control/Status (PMCSR) register (D29:F7, D26:F7:54h). |
| 20 | SMI on Async — R/WC. Software clears these bits by writing a 1 to it. 0 = No Async Schedule Enable bit change 1 = Async Schedule Enable bit transitioned from 1 to 0 or 0 to 1. |
| 19 | SMI on Periodic — R/WC. Software clears this bit by writing a 1 it. 0 = No Periodic Schedule Enable bit change. 1 = Periodic Schedule Enable bit transitions from 1 to 0 or 0 to 1. |



| Bit | Description |
|-------|-------------------------------------------------------------------------------------------------------------------------------------------------------------------------------------------------------------------------------------------------------------|
| 18 | SMI on CF — R/WC. Software clears this bit by writing a 1 it. 0 = No Configure Flag (CF) change. 1 = Configure Flag (CF) transitions from 1 to 0 or 0 to 1. |
| 17 | SMI on HCHalted — R/WC. Software clears this bit by writing a 1 it. 0 = HCHalted did Not transition to 1 (as a result of the Run/Stop bit being cleared). 1 = HCHalted transitions to 1 (as a result of the Run/Stop bit being cleared). |
| 16 | SMI on HCRreset — R/WC. Software clears this bit by writing a 1 it. 0 = HCRESET did Not transitioned to 1. 1 = HCRESET transitioned to 1. |
| 15:14 | Reserved. |
| 13:6 | SMI on PortOwner Enable — R/W. 0 = Disable. 1 = Enable. When any of these bits are 1 and the corresponding SMI on PortOwner bits are 1, then the host controller will issue an SMI. Unused ports should have their corresponding bits cleared. |
| 5 | SMI on PMSCR Enable — R/W. 0 = Disable. 1 = Enable. When this bit is 1 and SMI on PMSCR is 1, then the host controller will issue an SMI. |
| 4 | SMI on Async Enable — R/W. 0 = Disable. 1 = Enable. When this bit is 1 and SMI on Async is 1, then the host controller will issue an SMI |
| 3 | SMI on Periodic Enable — R/W. 0 = Disable. 1 = Enable. When this bit is 1 and SMI on Periodic is 1, then the host controller will issue an SMI. |
| 2 | SMI on CF Enable — R/W. 0 = Disable. 1 = Enable. When this bit is 1 and SMI on CF is 1, then the host controller will issue an SMI. |
| 1 | SMI on HCHalted Enable — R/W. 0 = Disable. 1 = Enable. When this bit is a 1 and SMI on HCHalted is 1, then the host controller will issue an SMI. |
| 0 | SMI on HCRreset Enable — R/W. 0 = Disable. 1 = Enable. When this bit is a 1 and SMI on HCRreset is 1, then host controller will issue an SMI. |



17.1.34 FLR_CTRL—Function Level Reset Control Register (USB EHCI—D29:F7, D26:F7)

Address Offset: 9Ch Attribute: R/W
Default Value: 00h Size: 8 bits
Function Level Reset: No

| Bit | Description |
|-----|----------------------------------------------------------------------------------------------------------------------------------------------------------------------------------------------------------------------------------------------|
| 7:1 | Reserved |
| 0 | Initiate FLR — R/W. This bit is used to initiate FLR transition. A write of '1' initiates FLR transition. Since hardware must not respond to any cycles until FLR completion, the value read by software from this bit is always '0'. |

17.1.35 FLR_STS—Function Level Reset Status Register (USB EHCI—D29:F7, D26:F7)

Address Offset: 9Dh Attribute: RO
Default Value: 00h Size: 8 bits
Function Level Reset: No

| Bit | Description |
|-----|--------------------------------------------------------------------------------------------------------------------------------------------------------------------------------------------|
| 7:1 | Reserved |
| 0 | Transactions Pending (TXP) — RO. 0 = Completions for all non-posted requests have been received. 1 = Controller has issued non-posted requests which have not been completed. |

17.1.36 EHCIIR2—EHCI Initialization Register 2 (USB EHCI—D29:F7, D26:F7)

Address Offset: FCh Attribute: R/W
Default Value: 20001706h Size: 32 bits

| Bit | Description |
|-------|---------------------------------------------------------------|
| 31:30 | Reserved |
| 29 | EHCIIR2 Field 2 — R/W. BIOS must set this bit |
| 28:18 | Reserved |
| 17 | EHCIIR2 Field 1 — R/W. BIOS must set this bit |
| 16:4 | Reserved |
| 3:2 | EHCIIR2 Field 3 — R/W. BIOS must set this field to 10b |
| 1:0 | Reserved |



17.2 Memory-Mapped I/O Registers

The EHCI memory-mapped I/O space is composed of two sets of registers: Capability Registers and Operational Registers.

Note: The ICH10 EHCI controller will not accept memory transactions (neither reads nor writes) as a target that are locked transactions. The locked transactions should not be forwarded to PCI as the address space is known to be allocated to USB.

Note: When the EHCI function is in the D3 PCI power state, accesses to the USB 2.0 memory range are ignored and result a master abort. Similarly, if the Memory Space Enable (MSE) bit (D29:F7, D26:F7:04h, bit 1) is not set in the Command register in configuration space, the memory range will not be decoded by the ICH10 enhanced host controller (EHC). If the MSE bit is not set, then the ICH10 must default to allowing any memory accesses for the range specified in the BAR to go to PCI. This is because the range may not be valid and, therefore, the cycle must be made available to any other targets that may be currently using that range.

17.2.1 Host Controller Capability Registers

These registers specify the limits, restrictions and capabilities of the host controller implementation. Within the host controller capability registers, only the structural parameters register is writable. These registers are implemented in the suspend well and is only reset by the standard suspend-well hardware reset, not by HCRESET or the D3-to-D0 reset.

Note: Note that the EHCI controller does not support as a target memory transactions that are locked transactions. Attempting to access the EHCI controller Memory-Mapped I/O space using locked memory transactions will result in undefined behavior.

Note: Note that when the USB2 function is in the D3 PCI power state, accesses to the USB2 memory range are ignored and will result in a master abort. Similarly, if the Memory Space Enable (MSE) bit is not set in the Command register in configuration space, the memory range will not be decoded by the Enhanced Host Controller (EHC). If the MSE bit is not set, then the EHC will not claim any memory accesses for the range specified in the BAR.

Table 17-2. Enhanced Host Controller Capability Registers

| MEM_BASE + Offset | Mnemonic | Register | Default | Type |
|-------------------|-----------|------------------------------------------|-----------------------------------------|-------------------|
| 00h | CAPLENGTH | Capabilities Registers Length | 20h | RO |
| 02h–03h | HCVERSION | Host Controller Interface Version Number | 0100h | RO |
| 04h–07h | HCSPARAMS | Host Controller Structural Parameters | 00103206h (D29:F7) 00102205 (D26:F7) | R/W (special), RO |
| 08h–0Bh | HCCPARAMS | Host Controller Capability Parameters | 00006871h | RO |

NOTE: “Read/Write Special” means that the register is normally read-only, but may be written when the WRT_RDONLY bit is set. Because these registers are expected to be programmed by BIOS during initialization, their contents must not get modified by HCRESET or D3-to-D0 internal reset.



17.2.1.1 CAPLENGTH—Capability Registers Length Register

Offset: MEM_BASE + 00h Attribute: RO
Default Value: 20h Size: 8 bits

| Bit | Description |
|-----|-----------------------------------------------------------------------------------------------------------------------------------------------------------------------------------------------------------------------------------------------------------------------------------------------|
| 7:0 | Capability Register Length Value — RO. This register is used as an offset to add to the Memory Base Register (D29:F7, D26:F7:10h) to find the beginning of the Operational Register Space. This field is hardwired to 20h indicating that the Operation Registers begin at offset 20h. |

17.2.1.2 HCIVERSION—Host Controller Interface Version Number Register

Offset: MEM_BASE + 02h–03h Attribute: RO
Default Value: 0100h Size: 16 bits

| Bit | Description |
|------|----------------------------------------------------------------------------------------------------------------------------------------------------------------------------------------------|
| 15:0 | Host Controller Interface Version Number — RO. This is a two-byte register containing a BCD encoding of the version number of interface that this host controller interface conforms. |

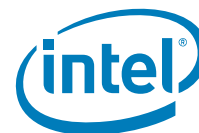

17.2.1.3 HCSPARAMS—Host Controller Structural Parameters

Offset: MEM_BASE + 04h–07h Attribute: R/W, RO
 Default Value: 00103206h (D29:F7) Size: 32 bits
 00103206h (D26:F7)
 Function Level Reset: No

Note: This register is reset by a suspend well reset and not a D3-to-D0 reset or HCRESET.

| Bit | Description |
|-------|---------------------------------------------------------------------------------------------------------------------------------------------------------------------------------------------------------------------------------------------------------------------------------------------------------------------------------------------------------------------------------------------------------------------------------------------------------------------------------------------------------------------------------------------------------------------------------------------------------------------------------------------------------------------------------------------------------------------------------------------------------------------------------------------------------------------------------------------------------------------------------------------------------------------------------------------------------------------------------------------------------------------------------------------|
| 31:24 | Reserved. |
| 23:20 | Debug Port Number (DP_N) — RO. Hardwired to 1h indicating that the Debug Port is on the lowest numbered port on the EHCI. |
| 19:16 | Reserved |
| 15:12 | Number of Companion Controllers (N_CC) — R/W. This field indicates the number of companion controllers associated with this USB EHCI host controller. A 0 in this field indicates there are no companion host controllers. Port-ownership hand-off is not supported. Only high-speed devices are supported on the host controller root ports. A value of 1 or more in this field indicates there are companion USB UHCI host controller(s). Port-ownership hand-offs are supported. High, Full- and Low-speed devices are supported on the host controller root ports. The ICH10 allows the default value of 3h (D29) or 3h (D26) to be over-written by BIOS. When removing classic controllers, they must be disabled in the following order: Function 3, Function 2, Function 1, and Function 0, which correspond to ports 11:10, 5:4, 3:2, and 1:0, respectively for Device 29. For Device 26 the following order is Function 2, Function 1 then Function 0, which correspond to ports 11:10, 9:8 and 7:6, respectively. |
| 11:8 | Number of Ports per Companion Controller (N_PCC) — RO. Hardwired to 2h. This field indicates the number of ports supported per companion host controller. It is used to indicate the port routing configuration to system software. |
| 7:4 | Reserved. These bits are reserved and default to 0. |
| 3:0 | N_PORTS — R/W. This field specifies the number of physical downstream ports implemented on this host controller. The value of this field determines how many port registers are addressable in the Operational Register Space. Valid values are in the range of 1h to Fh. The ICH10 reports 6h for D29 and 6h for D26 by default. However, software may write a value less than the default for some platform configurations. A 0 in this field is undefined. |

NOTE: This register is writable when the WRT_RDONLY bit is set.



17.2.1.4 HCCPARAMS—Host Controller Capability Parameters Register

Offset: MEM_BASE + 08h–0Bh Attribute: RO
 Default Value: 00006871h Size: 32 bits

| Bit | Description |
|-------|---------------------------------------------------------------------------------------------------------------------------------------------------------------------------------------------------------------------------------------------------------------------------------------------------------------------------------------------------------------------------------------------------------------------------------------------------------------------------------------------------------------------------------------------------------------------------------------------------------------------------------------------------------------------------------------------------|
| 31:18 | Reserved |
| 17 | Asynchronous Schedule Update Capability (ASUC) — R/W. There is no functionality associated with this bit. |
| 16 | Periodic Schedule Update Capability (PSUC) — RO. This field is hardwired to 0b to indicate that the EHC hardware supports the Periodic Schedule Update Event Flag in the USB2.0_CMD register. |
| 15:8 | EHCI Extended Capabilities Pointer (EECP) — RO. This field is hardwired to 68h, indicating that the EHCI capabilities list exists and begins at offset 68h in the PCI configuration space. |
| 7:4 | Isochronous Scheduling Threshold — RO. This field indicates, relative to the current position of the executing host controller, where software can reliably update the isochronous schedule. When bit 7 is 0, the value of the least significant 3 bits indicates the number of micro-frames a host controller hold a set of isochronous data structures (one or more) before flushing the state. When bit 7 is a 1, then host software assumes the host controller may cache an isochronous data structure for an entire frame. Refer to the EHCI specification for details on how software uses this information for scheduling isochronous transfers. This field is hardwired to 7h. |
| 3 | Reserved. |
| 2 | Asynchronous Schedule Park Capability — RO. This bit is hardwired to 0 indicating that the host controller does not support this optional feature |
| 1 | Programmable Frame List Flag — RO. 0 = System software must use a frame list length of 1024 elements with this host controller. The USB2.0_CMD register (D29:F7, D26:F7:CAPLENGTH + 20h, bits 3:2) <i>Frame List Size</i> field is a read-only register and must be set to 0. 1 = System software can specify and use a smaller frame list and configure the host controller via the USB2.0_CMD register <i>Frame List Size</i> field. The frame list must always be aligned on a 4K page boundary. This requirement ensures that the frame list is always physically contiguous. |
| 0 | 64-bit Addressing Capability — RO. This field documents the addressing range capability of this implementation. The value of this field determines whether software should use the 32-bit or 64-bit data structures. Values for this field have the following interpretation: 0 = Data structures using 32-bit address memory pointers 1 = Data structures using 64-bit address memory pointers This bit is hardwired to 1. NOTE: ICH10 supports 64 bit addressing only. |



17.2.2 Host Controller Operational Registers

This section defines the enhanced host controller operational registers. These registers are located after the capabilities registers. The operational register base must be dword-aligned and is calculated by adding the value in the first capabilities register (CAPLENGTH) to the base address of the enhanced host controller register address space (MEM_BASE). Since CAPLENGTH is always 20h, [Table 17-3](#) already accounts for this offset. All registers are 32 bits in length.

Table 17-3. Enhanced Host Controller Operational Register Address Map

| MEM_BASE + Offset | Mnemonic | Register Name | Default | Special Notes | Type |
|--------------------|-----------------|-----------------------------------|-----------|---------------|--------------------------|
| 20h–23h | USB2.0_CMD | USB 2.0 Command | 00080000h | | R/W, RO |
| 24h–27h | USB2.0_STS | USB 2.0 Status | 00001000h | | R/WC, RO |
| 28h–2Bh | USB2.0_INTR | USB 2.0 Interrupt Enable | 00000000h | | R/W |
| 2Ch–2Fh | FRINDEX | USB 2.0 Frame Index | 00000000h | | R/W, |
| 30h–33h | CTRLDSSEGMENT | Control Data Structure Segment | 00000000h | | R/W, RO |
| 34h–37h | PERODICLISTBASE | Period Frame List Base Address | 00000000h | | R/W |
| 38h–3Bh | ASYNCLISTADDR | Current Asynchronous List Address | 00000000h | | R/W |
| 3Ch–5Fh | — | Reserved | 0h | | RO |
| 60h–63h | CONFIGFLAG | Configure Flag | 00000000h | Suspend | R/W |
| 64h–67h | PORT0SC | Port 0 Status and Control | 00003000h | Suspend | R/W, R/WC, RO |
| 68h–6Bh | PORT1SC | Port 1 Status and Control | 00003000h | Suspend | R/W, R/WC, RO |
| 6Ch–6Fh | PORT2SC | Port 2 Status and Control | 00003000h | Suspend | R/W, R/WC, RO |
| 70h–73h | PORT3SC | Port 3 Status and Control | 00003000h | Suspend | R/W, R/WC, RO |
| 74h–77h | PORT4SC | Port 4 Status and Control | 00003000h | Suspend | R/W, R/WC, RO |
| 78h–7Bh | PORT5SC | Port 5 Status and Control | 00003000h | Suspend | R/W, R/WC, RO |
| 74h–77h (D29 Only) | PORT6SC | Port 6 Status and Control | 00003000h | Suspend | R/W, R/WC, RO |
| 78h–7Bh (D29 Only) | PORT7SC | Port 7 Status and Control | 00003000h | Suspend | R/W, R/WC, RO |
| 7Ch–9Fh | — | Reserved | Undefined | | RO |
| A0h–B3h | — | Debug Port Registers | Undefined | | See register description |
| B4h–3FFh | — | Reserved | Undefined | | RO |

Note: Software must read and write these registers using only dword accesses. These registers are divided into two sets. The first set at offsets MEM_BASE + 00:3Bh are implemented in the core power well. Unless otherwise noted, the core well registers are reset by the assertion of any of the following:

- Core well hardware reset
- HRESET
- D3-to-D0 reset



The second set at offsets MEM_BASE + 60h to the end of the implemented register space are implemented in the Suspend power well. Unless otherwise noted, the suspend well registers are reset by the assertion of either of the following:

- Suspend well hardware reset
- HCRESET

17.2.2.1 USB2.0_CMD—USB 2.0 Command Register

Offset: MEM_BASE + 20–23h Attribute: R/W, RO
 Default Value: 00080000h Size: 32 bits

| Bit | Description | | | | | | | | | | | | | | | | | | |
|-------|-------------------------------------------------------------------------------------------------------------------------------------------------------------------------------------------------------------------------------------------------------------------------------------------------------------------------------------------------------------------------------------------------------------------------------------------------------------------------------------------------------------------------------------------------------------------------------------------------------------------------------------------------------------------------------------------------------------------------------------------------------------------------------------------------------------------------------------------------------------------|-------|----------------------------|-----|----------|-----|---------------|-----|----------------|-----|----------------|-----|-------------------------------------------|-----|------------------------|-----|------------------------|-----|------------------------|
| 31:24 | Reserved. | | | | | | | | | | | | | | | | | | |
| 23:16 | <p>Interrupt Threshold Control — R/W. System software uses this field to select the maximum rate at which the host controller will issue interrupts. The only valid values are defined below. If software writes an invalid value to this register, the results are undefined.</p> <table border="1"> <thead> <tr> <th>Value</th> <th>Maximum Interrupt Interval</th> </tr> </thead> <tbody> <tr> <td>00h</td> <td>Reserved</td> </tr> <tr> <td>01h</td> <td>1 micro-frame</td> </tr> <tr> <td>02h</td> <td>2 micro-frames</td> </tr> <tr> <td>04h</td> <td>4 micro-frames</td> </tr> <tr> <td>08h</td> <td>8 micro-frames (default, equates to 1 ms)</td> </tr> <tr> <td>10h</td> <td>16 micro-frames (2 ms)</td> </tr> <tr> <td>20h</td> <td>32 micro-frames (4 ms)</td> </tr> <tr> <td>40h</td> <td>64 micro-frames (8 ms)</td> </tr> </tbody> </table> | Value | Maximum Interrupt Interval | 00h | Reserved | 01h | 1 micro-frame | 02h | 2 micro-frames | 04h | 4 micro-frames | 08h | 8 micro-frames (default, equates to 1 ms) | 10h | 16 micro-frames (2 ms) | 20h | 32 micro-frames (4 ms) | 40h | 64 micro-frames (8 ms) |
| Value | Maximum Interrupt Interval | | | | | | | | | | | | | | | | | | |
| 00h | Reserved | | | | | | | | | | | | | | | | | | |
| 01h | 1 micro-frame | | | | | | | | | | | | | | | | | | |
| 02h | 2 micro-frames | | | | | | | | | | | | | | | | | | |
| 04h | 4 micro-frames | | | | | | | | | | | | | | | | | | |
| 08h | 8 micro-frames (default, equates to 1 ms) | | | | | | | | | | | | | | | | | | |
| 10h | 16 micro-frames (2 ms) | | | | | | | | | | | | | | | | | | |
| 20h | 32 micro-frames (4 ms) | | | | | | | | | | | | | | | | | | |
| 40h | 64 micro-frames (8 ms) | | | | | | | | | | | | | | | | | | |
| 15:14 | Reserved. | | | | | | | | | | | | | | | | | | |
| 13 | Asynch Schedule Update (ASC) — R/W. There is no functionality associated with this bit. | | | | | | | | | | | | | | | | | | |
| 12 | <p>Periodic Schedule Prefetch Enable — R/W. This bit is used by software to enable the host controller to prefetch the periodic schedule even in C0.</p> <p>0 = Prefetch based pause enabled only when not in C0. 1 = Prefetch based pause enable in C0.</p> <p>Once software has written a 1b to this bit to enable periodic schedule prefetching, it must disable prefetching by writing a 0b to this bit whenever periodic schedule updates are about to begin. Software should continue to dynamically disable and re-enable the prefetcher surrounding any updates to the periodic scheduler (i.e. until the host controller has been reset via a HCRESET).</p> | | | | | | | | | | | | | | | | | | |
| 11:8 | Unimplemented Asynchronous Park Mode Bits — RO. Hardwired to 000b indicating the host controller does not support this optional feature. | | | | | | | | | | | | | | | | | | |
| 7 | Light Host Controller Reset — RO. Hardwired to 0. The ICH10 does not implement this optional reset. | | | | | | | | | | | | | | | | | | |



| Bit | Description |
|-----|--------------------------------------------------------------------------------------------------------------------------------------------------------------------------------------------------------------------------------------------------------------------------------------------------------------------------------------------------------------------------------------------------------------------------------------------------------------------------------------------------------------------------------------------------------------------------------------------------------------------------------------------------------------------------------------------------------------------------------------------------------------------------------------------------------------------------------------------------------------------------------------------------------------------------------------------------------------------------------------------------------------------------------------------------------------------------------------------------------------------------------------------------------------------------------------------------------------------------------------------------------------------------------------------------------------------------------------------------------------------------------------------------------------------------------------------------------------------------------------------------------|
| 6 | <p>Interrupt on Async Advance Doorbell — R/W. This bit is used as a doorbell by software to tell the host controller to issue an interrupt the next time it advances asynchronous schedule.</p> <p>0 = The host controller sets this bit to a 0 after it has set the Interrupt on Async Advance status bit (D29:F7, D26:F7:CAPLENGTH + 24h, bit 5) in the USB2.0_STS register to a 1.</p> <p>1 = Software must write a 1 to this bit to ring the doorbell. When the host controller has evicted all appropriate cached schedule state, it sets the Interrupt on Async Advance status bit in the USB2.0_STS register. If the <i>Interrupt on Async Advance Enable</i> bit in the USB2.0_INTR register (D29:F7, D26:F7:CAPLENGTH + 28h, bit 5) is a 1 then the host controller will assert an interrupt at the next interrupt threshold. See the EHCI specification for operational details.</p> <p>NOTE: Software should not write a 1 to this bit when the asynchronous schedule is inactive. Doing so will yield undefined results.</p> |
| 5 | <p>Asynchronous Schedule Enable — R/W. This bit controls whether the host controller skips processing the Asynchronous Schedule.</p> <p>0 = Do not process the Asynchronous Schedule</p> <p>1 = Use the ASYNCLISTADDR register to access the Asynchronous Schedule.</p> |
| 4 | <p>Periodic Schedule Enable — R/W. This bit controls whether the host controller skips processing the Periodic Schedule.</p> <p>0 = Do not process the Periodic Schedule</p> <p>1 = Use the PERIODICLISTBASE register to access the Periodic Schedule.</p> |
| 3:2 | <p>Frame List Size — RO. The ICH10 hardwires this field to 00b because it only supports the 1024-element frame list size.</p> |
| 1 | <p>Host Controller Reset (HCRESET) — R/W. This control bit used by software to reset the host controller. The effects of this on root hub registers are similar to a Chip Hardware Reset (i.e., RSMRST# assertion and PWROK deassertion on the ICH10). When software writes a 1 to this bit, the host controller resets its internal pipelines, timers, counters, state machines, etc. to their initial value. Any transaction currently in progress on USB is immediately terminated. A USB reset is not driven on downstream ports.</p> <p>NOTE: PCI configuration registers and Host controller capability registers are not effected by this reset.</p> <p>All operational registers, including port registers and port state machines are set to their initial values. Port ownership reverts to the companion host controller(s), with the side effects described in the EHCI spec. Software must re-initialize the host controller in order to return the host controller to an operational state.</p> <p>This bit is set to 0 by the host controller when the reset process is complete. Software cannot terminate the reset process early by writing a 0 to this register.</p> <p>Software should not set this bit to a 1 when the HCHalted bit (D29:F7, D26:F7:CAPLENGTH + 24h, bit 12) in the USB2.0_STS register is a 0. Attempting to reset an actively running host controller will result in undefined behavior. This reset me be used to leave EHCI port test modes.</p> |



| Bit | Description | | | | | | | | | | | | | | | |
|----------|----------------------------------------------------------------------------------------------------------------------------------------------------------------------------------------------------------------------------------------------------------------------------------------------------------------------------------------------------------------------------------------------------------------------------------------------------------------------------------------------------------------------------------------------------------------------------------------------------------------------------------------------------------------------------------------------------------------------------------------------------------------------------------------------------------------------------------------------------------------------------------------------------------------------------------------------------------------------------------------------------------------------------------------------------------------------------------------------------------------------------------------------------------------------------------------------------------------------------------------------------------------------------------------------------------------------------------------------------------------------------------------------------------------------|-----------------------------------------------|--------|----------------|----|----|---------------------------|----|----|--------|----|----|---------|----|----|-----------------------------------------------|
| 0 | <p>Run/Stop (RS) — R/W. 0 = Stop (default) 1 = Run. When set to a 1, the Host controller proceeds with execution of the schedule. The Host controller continues execution as long as this bit is set. When this bit is set to 0, the Host controller completes the current transaction on the USB and then halts. The HCHalted bit in the USB2.0_STS register indicates when the Host controller has finished the transaction and has entered the stopped state.</p> <p>Software should not write a 1 to this field unless the host controller is in the Halted state (i.e., HCHalted in the USBSTS register is a 1). The Halted bit is cleared immediately when the Run bit is set.</p> <p>The following table explains how the different combinations of Run and Halted should be interpreted:</p> <table border="1" data-bbox="472 684 1013 873"> <thead> <tr> <th>Run/Stop</th> <th>Halted</th> <th>Interpretation</th> </tr> </thead> <tbody> <tr> <td>0b</td> <td>0b</td> <td>In the process of halting</td> </tr> <tr> <td>0b</td> <td>1b</td> <td>Halted</td> </tr> <tr> <td>1b</td> <td>0b</td> <td>Running</td> </tr> <tr> <td>1b</td> <td>1b</td> <td>Invalid - the HCHalted bit clears immediately</td> </tr> </tbody> </table> <p>Memory read cycles initiated by the EHC that receive any status other than Successful will result in this bit being cleared.</p> | Run/Stop | Halted | Interpretation | 0b | 0b | In the process of halting | 0b | 1b | Halted | 1b | 0b | Running | 1b | 1b | Invalid - the HCHalted bit clears immediately |
| Run/Stop | Halted | Interpretation | | | | | | | | | | | | | | |
| 0b | 0b | In the process of halting | | | | | | | | | | | | | | |
| 0b | 1b | Halted | | | | | | | | | | | | | | |
| 1b | 0b | Running | | | | | | | | | | | | | | |
| 1b | 1b | Invalid - the HCHalted bit clears immediately | | | | | | | | | | | | | | |

NOTE: The Command Register indicates the command to be executed by the serial bus host controller. Writing to the register causes a command to be executed.

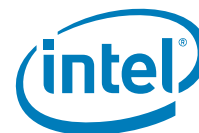

17.2.2.2 USB2.0_STS—USB 2.0 Status Register

Offset: MEM_BASE + 24h–27h Attribute: R/WC, RO
 Default Value: 00001000h Size: 32 bits

This register indicates pending interrupts and various states of the Host controller. The status resulting from a transaction on the serial bus is not indicated in this register. See the Interrupts description in section 4 of the EHCI specification for additional information concerning USB 2.0 interrupt conditions.

Note: For the writable bits, software must write a 1 to clear bits that are set. Writing a 0 has no effect.

| Bit | Description |
|-------|--------------------------------------------------------------------------------------------------------------------------------------------------------------------------------------------------------------------------------------------------------------------------------------------------------------------------------------------------------------------------------------------------------------------------------------------------------------------------------------------------------------------------------------------------------------------------------------------------------------------------------------------------------------------------------------------------|
| 31:16 | Reserved. |
| 15 | <p>Asynchronous Schedule Status —RO. This bit reports the current real status of the Asynchronous Schedule.</p> <p>0 = Status of the Asynchronous Schedule is disabled. (Default) 1 = Status of the Asynchronous Schedule is enabled.</p> <p>NOTE: The Host controller is not required to <i>immediately</i> disable or enable the Asynchronous Schedule when software transitions the <i>Asynchronous Schedule Enable</i> bit (D29:F7, D26:F7:CAPLENGTH + 20h, bit 5) in the USB2.0_CMD register. When this bit and the <i>Asynchronous Schedule Enable</i> bit are the same value, the Asynchronous Schedule is either enabled (1) or disabled (0).</p> |
| 14 | <p>Periodic Schedule Status —RO. This bit reports the current real status of the Periodic Schedule.</p> <p>0 = Status of the Periodic Schedule is disabled. (Default) 1 = Status of the Periodic Schedule is enabled.</p> <p>NOTE: The Host controller is not required to <i>immediately</i> disable or enable the Periodic Schedule when software transitions the <i>Periodic Schedule Enable</i> bit (D29:F7, D26:F7:CAPLENGTH + 20h, bit 4) in the USB2.0_CMD register. When this bit and the <i>Periodic Schedule Enable</i> bit are the same value, the Periodic Schedule is either enabled (1) or disabled (0).</p> |
| 13 | <p>Reclamation —RO. This read-only status bit is used to detect an empty asynchronous schedule. The operational model and valid transitions for this bit are described in Section 4 of the EHCI Specification.</p> |
| 12 | <p>HCHalted —RO.</p> <p>0 = This bit is a 0 when the Run/Stop bit is a 1. 1 = The Host controller sets this bit to 1 after it has stopped executing as a result of the Run/Stop bit being set to 0, either by software or by the Host controller hardware (e.g., internal error). (Default)</p> |
| 11:6 | Reserved |
| 5 | <p>Interrupt on Async Advance — R/WC. System software can force the host controller to issue an interrupt the next time the host controller advances the asynchronous schedule by writing a 1 to the <i>Interrupt on Async Advance Doorbell</i> bit (D29:F7, D26:F7:CAPLENGTH + 20h, bit 6) in the USB2.0_CMD register. This bit indicates the assertion of that interrupt source.</p> |



| Bit | Description |
|-----|------------------------------------------------------------------------------------------------------------------------------------------------------------------------------------------------------------------------------------------------------------------------------------------------------------------------------------------------------------------------------------------------------------------------------------------------------------------------------------------------------------------------------------------------------------------------------------------------------------------------------------------------------------------------------------------------------------------------------------------------------------------------------------------------------------------------------------------------------------------------------------------------------------------------------------------------------------------------|
| 4 | <p>Host System Error — R/WC.</p> <p>0 = No serious error occurred during a host system access involving the Host controller module</p> <p>1 = The Host controller sets this bit to 1 when a serious error occurs during a host system access involving the Host controller module. A hardware interrupt is generated to the system. Memory read cycles initiated by the EHC that receive any status other than Successful will result in this bit being set.</p> <p>When this error occurs, the Host controller clears the Run/Stop bit in the USB2.0_CMDregister (D29:F7, D26:F7:CAPLENGTH + 20h, bit 0) to prevent further execution of the scheduled TDs. A hardware interrupt is generated to the system (if enabled in the Interrupt Enable Register).</p> |
| 3 | <p>Frame List Rollover — R/WC.</p> <p>0 = No <i>Frame List Index</i> rollover from its maximum value to 0.</p> <p>1 = The Host controller sets this bit to a 1 when the <i>Frame List Index</i> (see Section) rolls over from its maximum value to 0. Since the ICH10 only supports the 1024-entry Frame List Size, the <i>Frame List Index</i> rolls over every time FRNUM13 toggles.</p> |
| 2 | <p>Port Change Detect — R/WC. This bit is allowed to be maintained in the Auxiliary power well. Alternatively, it is also acceptable that on a D3 to D0 transition of the EHCI HC device, this bit is loaded with the OR of all of the PORTSC change bits (including: Force port resume, overcurrent change, enable/disable change and connect status change). Regardless of the implementation, when this bit is readable (i.e., in the D0 state), it must provide a valid view of the Port Status registers.</p> <p>0 = No change bit transition from a 0 to 1 or No Force Port Resume bit transition from 0 to 1 as a result of a J-K transition detected on a suspended port.</p> <p>1 = The Host controller sets this bit to 1 when any port for which the <i>Port Owner</i> bit is set to 0 has a change bit transition from a 0 to 1 or a Force Port Resume bit transition from 0 to 1 as a result of a J-K transition detected on a suspended port.</p> |
| 1 | <p>USB Error Interrupt (USBERRINT) — R/WC.</p> <p>0 = No error condition.</p> <p>1 = The Host controller sets this bit to 1 when completion of a USB transaction results in an error condition (e.g., error counter underflow). If the TD on which the error interrupt occurred also had its IOC bit set, both this bit and Bit 0 are set. See the EHCI specification for a list of the USB errors that will result in this interrupt being asserted.</p> |
| 0 | <p>USB Interrupt (USBINT) — R/WC.</p> <p>0 = No completion of a USB transaction whose Transfer Descriptor had its IOC bit set. No short packet is detected.</p> <p>1 = The Host controller sets this bit to 1 when the cause of an interrupt is a completion of a USB transaction whose Transfer Descriptor had its IOC bit set. The Host controller also sets this bit to 1 when a short packet is detected (actual number of bytes received was less than the expected number of bytes).</p> |



17.2.2.3 USB2.0_INTR—USB 2.0 Interrupt Enable Register

Offset: MEM_BASE + 28h–2Bh Attribute: R/W
 Default Value: 00000000h Size: 32 bits

This register enables and disables reporting of the corresponding interrupt to the software. When a bit is set and the corresponding interrupt is active, an interrupt is generated to the host. Interrupt sources that are disabled in this register still appear in the USB2.0_STS Register to allow the software to poll for events. Each interrupt enable bit description indicates whether it is dependent on the interrupt threshold mechanism (see Section 4 of the EHCI specification), or not.

| Bit | Description |
|------|--------------------------------------------------------------------------------------------------------------------------------------------------------------------------------------------------------------------------------------------------------------------------------------------------------------------------------------------------------------------------------------------|
| 31:6 | Reserved. |
| 5 | Interrupt on Async Advance Enable — R/W. 0 = Disable. 1 = Enable. When this bit is a 1, and the Interrupt on Async Advance bit (D29:F7, D26:F7:CAPLENGTH + 24h, bit 5) in the USB2.0_STS register is a 1, the host controller will issue an interrupt at the next interrupt threshold. The interrupt is acknowledged by software clearing the Interrupt on Async Advance bit. |
| 4 | Host System Error Enable — R/W. 0 = Disable. 1 = Enable. When this bit is a 1, and the Host System Error Status bit (D29:F7, D26:F7:CAPLENGTH + 24h, bit 4) in the USB2.0_STS register is a 1, the host controller will issue an interrupt. The interrupt is acknowledged by software clearing the Host System Error bit. |
| 3 | Frame List Rollover Enable — R/W. 0 = Disable. 1 = Enable. When this bit is a 1, and the Frame List Rollover bit (D29:F7, D26:F7:CAPLENGTH + 24h, bit 3) in the USB2.0_STS register is a 1, the host controller will issue an interrupt. The interrupt is acknowledged by software clearing the Frame List Rollover bit. |
| 2 | Port Change Interrupt Enable — R/W. 0 = Disable. 1 = Enable. When this bit is a 1, and the Port Change Detect bit (D29:F7, D26:F7:CAPLENGTH + 24h, bit 2) in the USB2.0_STS register is a 1, the host controller will issue an interrupt. The interrupt is acknowledged by software clearing the Port Change Detect bit. |
| 1 | USB Error Interrupt Enable — R/W. 0 = Disable. 1 = Enable. When this bit is a 1, and the USBERRINT bit (D29:F7, D26:F7:CAPLENGTH + 24h, bit 1) in the USB2.0_STS register is a 1, the host controller will issue an interrupt at the next interrupt threshold. The interrupt is acknowledged by software by clearing the USBERRINT bit in the USB2.0_STS register. |
| 0 | USB Interrupt Enable — R/W. 0 = Disable. 1 = Enable. When this bit is a 1, and the USBINT bit (D29:F7, D26:F7:CAPLENGTH + 24h, bit 0) in the USB2.0_STS register is a 1, the host controller will issue an interrupt at the next interrupt threshold. The interrupt is acknowledged by software by clearing the USBINT bit in the USB2.0_STS register. |



17.2.2.4 FRINDEX—Frame Index Register

| | | | |
|----------------|--------------------|------------|---------|
| Offset: | MEM_BASE + 2Ch–2Fh | Attribute: | R/W |
| Default Value: | 00000000h | Size: | 32 bits |

The SOF frame number value for the bus SOF token is derived or alternatively managed from this register. Refer to Section 4 of the EHCI specification for a detailed explanation of the SOF value management requirements on the host controller. The value of FRINDEX must be within 125 μs (1 micro-frame) ahead of the SOF token value. The SOF value may be implemented as an 11-bit shadow register. For this discussion, this shadow register is 11 bits and is named SOFV. SOFV updates every 8 micro-frames (1 millisecond). An example implementation to achieve this behavior is to increment SOFV each time the FRINDEX[2:0] increments from 0 to 1.

Software must use the value of FRINDEX to derive the current micro-frame number, both for high-speed isochronous scheduling purposes and to provide the **get** micro-frame number function required to client drivers. Therefore, the value of FRINDEX and the value of SOFV must be kept consistent if chip is reset or software writes to FRINDEX. Writes to FRINDEX must also **write-through** FRINDEX[13:3] to SOFV[10:0]. In order to keep the update as simple as possible, software should never write a FRINDEX value where the three least significant bits are 111b or 000b.

Note: This register is used by the host controller to index into the periodic frame list. The register updates every 125 microseconds (once each micro-frame). Bits [12:3] are used to select a particular entry in the Periodic Frame List during periodic schedule execution. The number of bits used for the index is fixed at 10 for the ICH10 since it only supports 1024-entry frame lists. This register must be written as a dword. Word and byte writes produce undefined results. This register cannot be written unless the Host controller is in the Halted state as indicated by the *HCHalted* bit (D29:F7, D26:F7:CAPLENGTH + 24h, bit 12). A write to this register while the Run/Stop bit (D29:F7, D26:F7:CAPLENGTH + 20h, bit 0) is set to a 1 (USB2.0_CMD register) produces undefined results. Writes to this register also effect the SOF value. See Section 4 of the EHCI specification for details.

| Bit | Description |
|-------|-----------------------------------------------------------------------------------------------------------------------------------------------------------------------------------------------------------------------------------------------------------------------------------------------------------------------------------|
| 31:14 | Reserved |
| 13:0 | Frame List Current Index/Frame Number — R/W. The value in this register increments at the end of each time frame (e.g., micro-frame). Bits [12:3] are used for the Frame List current index. This means that each location of the frame list is accessed 8 times (frames or micro-frames) before moving to the next index. |



17.2.2.5 CTRLDSSEGMENT—Control Data Structure Segment Register

Offset: MEM_BASE + 30h–33h Attribute: R/W, RO
 Default Value: 00000000h Size: 32 bits

This 32-bit register corresponds to the most significant address bits [63:32] for all EHCI data structures. Since the ICH10 hardwires the 64-bit Addressing Capability field in HCCPARAMS to 1, then this register is used with the link pointers to construct 64-bit addresses to EHCI control data structures. This register is concatenated with the link pointer from either the PERIODICLISTBASE, ASYNCLISTADDR, or any control data structure link field to construct a 64-bit address. This register allows the host software to locate all control data structures within the same 4 GB memory segment.

| Bit | Description |
|-------|--------------------------------------------------------------------------------------------------------------------------------------------|
| 31:12 | Upper Address[63:44] — RO. Hardwired to 0s. The ICH10 EHC is only capable of generating addresses up to 16 terabytes (44 bits of address). |
| 11:0 | Upper Address[43:32] — R/W. This 12-bit field corresponds to address bits 43:32 when forming a control data structure address. |

17.2.2.6 PERIODICLISTBASE—Periodic Frame List Base Address Register

Offset: MEM_BASE + 34h–37h Attribute: R/W
 Default Value: 00000000h Size: 32 bits

This 32-bit register contains the beginning address of the Periodic Frame List in the system memory. Since the ICH10 host controller operates in 64-bit mode (as indicated by the 1 in the 64-bit Addressing Capability field in the HCCSPARAMS register) (offset 08h, bit 0), then the most significant 32 bits of every control data structure address comes from the CTRLDSSEGMENT register. HCD loads this register prior to starting the schedule execution by the host controller. The memory structure referenced by this physical memory pointer is assumed to be 4-Kbyte aligned. The contents of this register are combined with the Frame Index Register (FRINDEX) to enable the Host controller to step through the Periodic Frame List in sequence.

| Bit | Description |
|-------|---------------------------------------------------------------------------------------------------------|
| 31:12 | Base Address (Low) — R/W. These bits correspond to memory address signals [31:12], respectively. |
| 11:0 | Reserved. |



17.2.2.7 ASYNCLISTADDR—Current Asynchronous List Address Register

Offset: MEM_BASE + 38h–3Bh Attribute: R/W
Default Value: 00000000h Size: 32 bits

This 32-bit register contains the address of the next asynchronous queue head to be executed. Since the ICH10 host controller operates in 64-bit mode (as indicated by a 1 in 64-bit Addressing Capability field in the HCCPARAMS register) (offset 08h, bit 0), then the most significant 32 bits of every control data structure address comes from the CTRLDSSEGMENT register (offset 08h). Bits [4:0] of this register cannot be modified by system software and will always return 0s when read. The memory structure referenced by this physical memory pointer is assumed to be 32-byte aligned.

| Bit | Description |
|------|-------------------------------------------------------------------------------------------------------------------------------------------------------------|
| 31:5 | Link Pointer Low (LPL) — R/W. These bits correspond to memory address signals [31:5], respectively. This field may only reference a Queue Head (QH). |
| 4:0 | Reserved. |

17.2.2.8 CONFIGFLAG—Configure Flag Register

Offset: MEM_BASE + 60h–63h Attribute: R/W
Default Value: 00000000h Size: 32 bits

This register is in the suspend power well. It is only reset by hardware when the suspend power is initially applied or in response to a host controller reset.

| Bit | Description |
|------|-----------------------------------------------------------------------------------------------------------------------------------------------------------------------------------------------------------------------------------------------------------------------------------------------------------------------------------------------------------------------------------------------------------------------------------------------------------------------------------|
| 31:1 | Reserved. |
| 0 | Configure Flag (CF) — R/W. Host software sets this bit as the last action in its process of configuring the Host controller. This bit controls the default port-routing control logic. Bit values and side-effects are listed below. See Chapter 4 of the EHCI specification for operation details. 0 = Port routing control logic default-routes each port to the UHCIs (default). 1 = Port routing control logic default-routes all ports to this host controller. |



17.2.2.9 PORTSC—Port N Status and Control Register

| | |
|----------------|-------------------------------------------------------------------------------------------------------------------------------------------------------------------------------------------------------------------------------------------------------------------------------------------|
| Offset: | Port 0, Port 6: MEM_BASE + 64h–67h Port 1, Port 7: MEM_BASE + 68–6Bh Port 2, Port 8: MEM_BASE + 6C–6Fh Port 3, Port 9: MEM_BASE + 70–73h Port 4: Port 10: MEM_BASE + 74–77h Port 5: Port 11: MEM_BASE + 78–7Bh Port 6: MEM_BASE + 7Ch–7Bh Port 7: MEM_BASE + 80h–83h |
| Attribute: | R/W, R/WC, RO |
| Default Value: | 00003000h |
| Size: | 32 bits |

A host controller must implement one or more port registers. Software uses the N_Port information from the Structural Parameters Register to determine how many ports need to be serviced. All ports have the structure defined below. Software must not write to unreported Port Status and Control Registers.

This register is in the suspend power well. It is only reset by hardware when the suspend power is initially applied or in response to a host controller reset. The initial conditions of a port are:

- No device connected
- Port disabled.

When a device is attached, the port state transitions to the attached state and system software will process this as with any status change notification. Refer to Section 4 of the EHCI specification for operational requirements for how change events interact with port suspend mode.

| Bit | Description |
|-------|----------------------------------------------------------------------------------------------------------------------------------------------------------------------------------------------------------------------------------------------------------------------------------------------------------------------------------------------------------------|
| 31:23 | Reserved. |
| 22 | Wake on Overcurrent Enable (WKOC_E) — R/W. 0 = Disable. (Default) 1 = Enable. Writing this bit to a 1 enables the setting of the PME Status bit in the Power Management Control/Status Register (offset 54, bit 15) when the overcurrent Active bit (bit 4 of this register) is set. |
| 21 | Wake on Disconnect Enable (WKDSCNNT_E) — R/W. 0 = Disable. (Default) 1 = Enable. Writing this bit to a 1 enables the setting of the PME Status bit in the Power Management Control/Status Register (offset 54, bit 15) when the Current Connect Status changes from connected to disconnected (i.e., bit 0 of this register changes from 1 to 0). |
| 20 | Wake on Connect Enable (WKCNTNT_E) — R/W. 0 = Disable. (Default) 1 = Enable. Writing this bit to a 1 enables the setting of the PME Status bit in the Power Management Control/Status Register (offset 54, bit 15) when the Current Connect Status changes from disconnected to connected (i.e., bit 0 of this register changes from 0 to 1). |



| Bit | Description | | | | | | | | | | | | | | |
|-------|-------------------------------------------------------------------------------------------------------------------------------------------------------------------------------------------------------------------------------------------------------------------------------------------------------------------------------------------------------------------------------------------------------------------------------------------------------------------------------------------------------------------------------------------------------------------------------------------------------------------------------------------------------------------------------------------------------------------------------------------------------------------------------------------------------------------------------------------------|-------|----------------------------|-------|---------------------------------|-------|--------------|-------|--------------|-------|--------------|-------|-------------|-------|--------------|
| 19:16 | <p>Port Test Control — R/W. When this field is 0s, the port is NOT operating in a test mode. A non-zero value indicates that it is operating in test mode and the specific test mode is indicated by the specific value. The encoding of the test mode bits are (0110b – 1111b are reserved):</p> <table border="1"> <thead> <tr> <th>Value</th> <th>Maximum Interrupt Interval</th> </tr> </thead> <tbody> <tr> <td>0000b</td> <td>Test mode not enabled (default)</td> </tr> <tr> <td>0001b</td> <td>Test J_STATE</td> </tr> <tr> <td>0010b</td> <td>Test K_STATE</td> </tr> <tr> <td>0011b</td> <td>Test SE0_NAK</td> </tr> <tr> <td>0100b</td> <td>Test Packet</td> </tr> <tr> <td>0101b</td> <td>FORCE_ENABLE</td> </tr> </tbody> </table> <p>Refer to USB Specification Revision 2.0, Chapter 7 for details on each test mode.</p> | Value | Maximum Interrupt Interval | 0000b | Test mode not enabled (default) | 0001b | Test J_STATE | 0010b | Test K_STATE | 0011b | Test SE0_NAK | 0100b | Test Packet | 0101b | FORCE_ENABLE |
| Value | Maximum Interrupt Interval | | | | | | | | | | | | | | |
| 0000b | Test mode not enabled (default) | | | | | | | | | | | | | | |
| 0001b | Test J_STATE | | | | | | | | | | | | | | |
| 0010b | Test K_STATE | | | | | | | | | | | | | | |
| 0011b | Test SE0_NAK | | | | | | | | | | | | | | |
| 0100b | Test Packet | | | | | | | | | | | | | | |
| 0101b | FORCE_ENABLE | | | | | | | | | | | | | | |
| 15:14 | Reserved. | | | | | | | | | | | | | | |
| 13 | <p>Port Owner — R/W. This bit unconditionally goes to a 0 when the Configured Flag bit in the USB2.0_CMD register makes a 0 to 1 transition.</p> <p>System software uses this field to release ownership of the port to a selected host controller (in the event that the attached device is not a high-speed device). Software writes a 1 to this bit when the attached device is not a high-speed device. A 1 in this bit means that a companion host controller owns and controls the port. See Chapter 4 of the EHCI Specification for operational details.</p> | | | | | | | | | | | | | | |
| 12 | <p>Port Power (PP) — RO. Read-only with a value of 1. This indicates that the port does have power.</p> | | | | | | | | | | | | | | |
| 11:10 | <p>Line Status— RO. These bits reflect the current logical levels of the D+ (bit 11) and D– (bit 10) signal lines. These bits are used for detection of low-speed USB devices prior to the port reset and enable sequence. This field is valid only when the port enable bit is 0 and the current connect status bit is set to a 1.</p> <p>00 = SE0 10 = J-state 01 = K-state 11 = Undefined</p> | | | | | | | | | | | | | | |
| 9 | Reserved. | | | | | | | | | | | | | | |

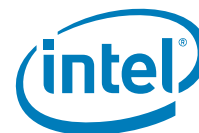

| Bit | Description | | | | | | | | | | | | |
|--------------|--------------------------------------------------------------------------------------------------------------------------------------------------------------------------------------------------------------------------------------------------------------------------------------------------------------------------------------------------------------------------------------------------------------------------------------------------------------------------------------------------------------------------------------------------------------------------------------------------------------------------------------------------------------------------------------------------------------------------------------------------------------------------------------------------------------------------------------------------------------------------------------------------------------------------------------------------------------------------------------------------------------------------------------------------------------------------------------------------------------------------------------------------------------------------------------------------------------------------------------------------------------------------------------------------------------------------------------------------------------------------------------------------------------------------------------------------------------------------------------------------------------------------------------------------------------------------------------------------------------------------------------------------------------------------------------------|--------------|---------|------------|---|---|----------|---|---|---------|---|---|---------|
| 8 | <p>Port Reset — R/W. When software writes a 1 to this bit (from a 0), the bus reset sequence as defined in the USB Specification, Revision 2.0 is started. Software writes a 0 to this bit to terminate the bus reset sequence. Software must keep this bit at a 1 long enough to ensure the reset sequence completes as specified in the <i>USB Specification, Revision 2.0</i>.</p> <p>1 = Port is in Reset. 0 = Port is not in Reset.</p> <p>NOTE: When software writes a 0 to this bit, there may be a delay before the bit status changes to a 0. The bit status will not read as a 0 until after the reset has completed. If the port is in high-speed mode after reset is complete, the host controller will automatically enable this port (e.g., set the <i>Port Enable</i> bit to a 1). A host controller must terminate the reset and stabilize the state of the port within 2 milliseconds of software transitioning this bit from 0 to 1.</p> <p>For example: if the port detects that the attached device is high-speed during reset, then the host controller must have the port in the enabled state within 2 ms of software writing this bit to a 0. The <i>HCHalted</i> bit (D29:F7, D26:F7:CAPLENGTH + 24h, bit 12) in the <i>USB2.0_STS</i> register should be a 0 before software attempts to use this bit. The host controller may hold <i>Port Reset</i> asserted to a 1 when the <i>HCHalted</i> bit is a 1. This bit is 0 if <i>Port Power</i> is 0</p> <p>NOTE: System software should not attempt to reset a port if the <i>HCHalted</i> bit in the <i>USB2.0_STS</i> register is a 1. Doing so will result in undefined behavior.</p> | | | | | | | | | | | | |
| 7 | <p>Suspend — R/W.</p> <p>0 = Port not in suspend state. (Default) 1 = Port in suspend state.</p> <p>Port Enabled Bit and Suspend bit of this register define the port states as follows:</p> <table border="1" data-bbox="487 1113 974 1270"> <thead> <tr> <th>Port Enabled</th> <th>Suspend</th> <th>Port State</th> </tr> </thead> <tbody> <tr> <td>0</td> <td>X</td> <td>Disabled</td> </tr> <tr> <td>1</td> <td>0</td> <td>Enabled</td> </tr> <tr> <td>1</td> <td>1</td> <td>Suspend</td> </tr> </tbody> </table> <p>When in suspend state, downstream propagation of data is blocked on this port, except for port reset. Note that the bit status does not change until the port is suspended and that there may be a delay in suspending a port depending on the activity on the port. The host controller will unconditionally set this bit to a 0 when software sets the <i>Force Port Resume</i> bit to a 0 (from a 1). A write of 0 to this bit is ignored by the host controller.</p> <p>If host software sets this bit to a 1 when the port is not enabled (i.e., <i>Port enabled</i> bit is a 0) the results are undefined.</p> | Port Enabled | Suspend | Port State | 0 | X | Disabled | 1 | 0 | Enabled | 1 | 1 | Suspend |
| Port Enabled | Suspend | Port State | | | | | | | | | | | |
| 0 | X | Disabled | | | | | | | | | | | |
| 1 | 0 | Enabled | | | | | | | | | | | |
| 1 | 1 | Suspend | | | | | | | | | | | |



| Bit | Description |
|-----|-------------------------------------------------------------------------------------------------------------------------------------------------------------------------------------------------------------------------------------------------------------------------------------------------------------------------------------------------------------------------------------------------------------------------------------------------------------------------------------------------------------------------------------------------------------------------------------------------------------------------------------------------------------------------------------------------------------------------------------------------------------------------------------------------------------------------------------------------------------------------------------------------------------------------------------------------------------------------------------------------------------------------------------------------------------------------------------------------------------------------------------------------------------------------------------------------------------------------------|
| 6 | <p>Force Port Resume — R/W.</p> <p>0 = No resume (K-state) detected/driven on port. (Default) 1 = Resume detected/driven on port. Software sets this bit to a 1 to drive resume signaling. The Host controller sets this bit to a 1 if a J-to-K transition is detected while the port is in the Suspend state. When this bit transitions to a 1 because a J-to-K transition is detected, the Port Change Detect bit (D29:F7, D26:F7:CAPLENGTH + 24h, bit 2) in the USB2.0_STS register is also set to a 1. If software sets this bit to a 1, the host controller must not set the Port Change Detect bit.</p> <p>NOTE: When the EHCI controller owns the port, the resume sequence follows the defined sequence documented in the USB Specification, Revision 2.0. The resume signaling (Full-speed 'K') is driven on the port as long as this bit remains a 1. Software must appropriately time the Resume and set this bit to a 0 when the appropriate amount of time has elapsed. Writing a 0 (from 1) causes the port to return to high-speed mode (forcing the bus below the port into a high-speed idle). This bit will remain a 1 until the port has switched to the high-speed idle.</p> |
| 5 | <p>Overcurrent Change — R/WC. The functionality of this bit is not dependent upon the port owner. Software clears this bit by writing a 1 to it.</p> <p>0 = No change. (Default) 1 = There is a change to Overcurrent Active.</p> |
| 4 | <p>Overcurrent Active — RO.</p> <p>0 = This port does not have an overcurrent condition. (Default) 1 = This port currently has an overcurrent condition. This bit will automatically transition from 1 to 0 when the over current condition is removed. The ICH10 automatically disables the port when the overcurrent active bit is 1.</p> |
| 3 | <p>Port Enable/Disable Change — R/WC. For the root hub, this bit gets set to a 1 only when a port is disabled due to the appropriate conditions existing at the EOF2 point (See Chapter 11 of the USB Specification for the definition of a port error). This bit is not set due to the Disabled-to-Enabled transition, nor due to a disconnect. Software clears this bit by writing a 1 to it.</p> <p>0 = No change in status. (Default). 1 = Port enabled/disabled status has changed.</p> |
| 2 | <p>Port Enabled/Disabled — R/W. Ports can only be enabled by the host controller as a part of the reset and enable. Software cannot enable a port by writing a 1 to this bit. Ports can be disabled by either a fault condition (disconnect event or other fault condition) or by host software. Note that the bit status does not change until the port state actually changes. There may be a delay in disabling or enabling a port due to other host controller and bus events.</p> <p>0 = Disable 1 = Enable (Default)</p> |
| 1 | <p>Connect Status Change — R/WC. This bit indicates a change has occurred in the port's Current Connect Status. Software sets this bit to 0 by writing a 1 to it.</p> <p>0 = No change (Default). 1 = Change in Current Connect Status. The host controller sets this bit for all changes to the port device connect status, even if system software has not cleared an existing connect status change. For example, the insertion status changes twice before system software has cleared the changed condition, hub hardware will be "setting" an already-set bit (i.e., the bit will remain set).</p> |
| 0 | <p>Current Connect Status — RO. This value reflects the current state of the port, and may not correspond directly to the event that caused the Connect Status Change bit (Bit 1) to be set.</p> <p>0 = No device is present. (Default) 1 = Device is present on port.</p> |



17.2.3 USB 2.0-Based Debug Port Register

The Debug port's registers are located in the same memory area, defined by the Base Address Register (MEM_BASE), as the standard EHCI registers. The base offset for the debug port registers (A0h) is declared in the Debug Port Base Offset Capability Register at Configuration offset 5Ah (D29:F7, D26:F7: offset 5Ah). The specific EHCI port that supports this debug capability (Port 0 for D29:F7 and Port 6 for D26:F7) is indicated by a 4-bit field (bits 20–23) in the HCSPARAMS register of the EHCI controller. The address map of the Debug Port registers is shown in Table 17-4.

Table 17-4. Debug Port Register Address Map

| MEM_BASE + Offset | Mnemonic | Register Name | Default | Type |
|-------------------|--------------|-------------------------|-----------------------|---------------|
| A0–A3h | CNTL_STS | Control/Status | 00000000h | R/W, R/WC, RO |
| A4–A7h | USBPID | USB PIDs | 00000000h | R/W, RO |
| A8–AFh | DATABUF[7:0] | Data Buffer (Bytes 7:0) | 00000000 00000000h | R/W |
| B0–B3h | CONFIG | Configuration | 00007F01h | R/W |

NOTES:

1. All of these registers are implemented in the core well and reset by PLTRST#, EHC HCRESET, and a EHC D3-to-D0 transition.
2. The hardware associated with this register provides no checks to ensure that software programs the interface correctly. How the hardware behaves when programmed improperly is undefined.



17.2.3.1 CNTL_STS—Control/Status Register

Offset: MEM_BASE + A0h Attribute: R/W, R/WC, RO
 Default Value: 00000000h Size: 32 bits

| Bit | Description |
|-------|-------------------------------------------------------------------------------------------------------------------------------------------------------------------------------------------------------------------------------------------------------------------------------------------------------------------------------------------------------------------------------------------------------------------------------------------------------------------------------------------------------------------------------------------------------|
| 31 | Reserved |
| 30 | OWNER_CNT — R/W. 0 = Ownership of the debug port is NOT forced to the EHCI controller (Default) 1 = Ownership of the debug port is forced to the EHCI controller (i.e. immediately taken away from the companion Classic USB Host controller) If the port was already owned by the EHCI controller, then setting this bit has no effect. This bit overrides all of the ownership-related bits in the standard EHCI registers. |
| 29 | Reserved |
| 28 | ENABLED_CNT — R/W. 0 = Software can clear this by writing a 0 to it. The hardware clears this bit for the same conditions where the Port Enable/Disable Change bit (in the PORTSC register) is set. (Default) 1 = Debug port is enabled for operation. Software can directly set this bit if the port is already enabled in the associated PORTSC register (this is enforced by the hardware). |
| 27:17 | Reserved |
| 16 | DONE_STS — R/WC. Software can clear this by writing a 1 to it. 0 = Request Not complete 1 = Set by hardware to indicate that the request is complete. |
| 15:12 | LINK_ID_STS — RO. This field identifies the link interface. 0h = Hardwired. Indicates that it is a USB Debug Port. |
| 11 | Reserved. |
| 10 | IN_USE_CNT — R/W. Set by software to indicate that the port is in use. Cleared by software to indicate that the port is free and may be used by other software. This bit is cleared after reset. (This bit has no affect on hardware.) |
| 9:7 | EXCEPTION_STS — RO. This field indicates the exception when the ERROR_GOOD#_STS bit is set. This field should be ignored if the ERROR_GOOD#_STS bit is 0. 000 = No Error. (Default) Note: This should not be seen since this field should only be checked if there is an error. 001 = Transaction error: Indicates the USB 2.0 transaction had an error (CRC, bad PID, timeout, etc.) 010 = Hardware error. Request was attempted (or in progress) when port was suspended or reset. All Other combinations are reserved |
| 6 | ERROR_GOOD#_STS — RO. 0 = Hardware clears this bit to 0 after the proper completion of a read or write. (Default) 1 = Error has occurred. Details on the nature of the error are provided in the Exception field. |

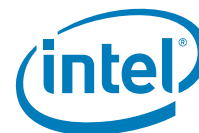

| Bit | Description |
|-----|--------------------------------------------------------------------------------------------------------------------------------------------------------------------------------------------------------------------------------------------------------------------------------------------------------------------------------------------------------------------------------------------------------------------------------------------------------------------------------------------------------------------------------------------------------------------------------------------------------------------------------------------------------------------------------------------------------------------------------------------------------------------------------------------------------------------------------------------------------------------------------------------------------------------------------------------------------------------------------------------------------------------------------------|
| 5 | <p>GO_CNT — R/W. 0 = Hardware clears this bit when hardware sets the DONE_STS bit. (Default) 1 = Causes hardware to perform a read or write request.</p> <p>NOTE: Writing a 1 to this bit when it is already set may result in undefined behavior.</p> |
| 4 | <p>WRITE_READ#_CNT — R/W. Software clears this bit to indicate that the current request is a read. Software sets this bit to indicate that the current request is a write. 0 = Read (Default) 1 = Write</p> |
| 3:0 | <p>DATA_LEN_CNT — R/W. This field is used to indicate the size of the data to be transferred. default = 0h.</p> <p>For write operations, this field is set by software to indicate to the hardware how many bytes of data in Data Buffer are to be transferred to the console. A value of 0h indicates that a zero-length packet should be sent. A value of 1–8 indicates 1–8 bytes are to be transferred. Values 9–Fh are invalid and how hardware behaves if used is undefined.</p> <p>For read operations, this field is set by hardware to indicate to software how many bytes in Data Buffer are valid in response to a read operation. A value of 0h indicates that a zero length packet was returned and the state of Data Buffer is not defined. A value of 1–8 indicates 1–8 bytes were received. Hardware is not allowed to return values 9–Fh.</p> <p>The transferring of data always starts with byte 0 in the data area and moves toward byte 7 until the transfer size is reached.</p> |

NOTES:

1. Software should do Read-Modify-Write operations to this register to preserve the contents of bits not being modified. This include Reserved bits.
2. To preserve the usage of RESERVED bits in the future, software should always write the same value read from the bit until it is defined. Reserved bits will always return 0 when read.



17.2.3.2 USBPID—USB PIDs Register

Offset: MEM_BASE + A4h–A7h Attribute: R/W, RO
 Default Value: 00000000h Size: 32 bits

This Dword register is used to communicate PID information between the USB debug driver and the USB debug port. The debug port uses some of these fields to generate USB packets, and uses other fields to return PID information to the USB debug driver.

| Bit | Description |
|-------|------------------------------------------------------------------------------------------------------------------------------------------------------------------------------------------------------------------------------------------------------------------------------------------------------------------------------------------------------------------------------------------------------------------------------------------------------------------------------------------------|
| 31:24 | Reserved. |
| 23:16 | RECEIVED_PID_STS[23:16] — RO. Hardware updates this field with the received PID for transactions in either direction. When the controller is writing data, this field is updated with the handshake PID that is received from the device. When the host controller is reading data, this field is updated with the data packet PID (if the device sent data), or the handshake PID (if the device NAKs the request). This field is valid when the hardware clears the GO_DONE#_CNT bit. |
| 15:8 | SEND_PID_CNT[15:8] — R/W. Hardware sends this PID to begin the data packet when sending data to USB (i.e., WRITE_READ#_CNT is asserted). Software typically sets this field to either DATA0 or DATA1 PID values. |
| 7:0 | TOKEN_PID_CNT[7:0] — R/W. Hardware sends this PID as the Token PID for each USB transaction. Software typically sets this field to either IN, OUT, or SETUP PID values. |

17.2.3.3 DATABUF[7:0]—Data Buffer Bytes[7:0] Register

Offset: MEM_BASE + A8h–AFh Attribute: R/W
 Default Value: 0000000000000000h Size: 64 bits

This register can be accessed as 8 separate 8-bit registers or 2 separate 32-bit register.

| Bit | Description |
|------|---------------------------------------------------------------------------------------------------------------------------------------------------------------------------------------------------------------------------------------------------------------------------------------------------------------------------------------------------------------------------------------------------------------------------------------------------------------------------------------------------------------------------------------------------------------------------------------------------|
| 63:0 | DATABUFFER[63:0] — R/W. This field is the 8 bytes of the data buffer. Bits 7:0 correspond to least significant byte (byte 0). Bits 63:56 correspond to the most significant byte (byte 7). The bytes in the Data Buffer must be written with data before software initiates a write request. For a read request, the Data Buffer contains valid data when DONE_STS bit (offset A0, bit 16) is cleared by the hardware, ERROR_GOOD#_STS (offset A0, bit 6) is cleared by the hardware, and the DATA_LENGTH_CNT field (offset A0, bits 3:0) indicates the number of bytes that are valid. |

17.2.3.4 CONFIG—Configuration Register

Offset: MEM_BASE + B0–B3h Attribute: R/W
 Default Value: 00007F01h Size: 32 bits

| Bit | Description |
|-------|-------------------------------------------------------------------------------------------------------------------------------------------------------|
| 31:15 | Reserved |
| 14:8 | USB_ADDRESS_CNF — R/W. This 7-bit field identifies the USB device address used by the controller for all Token PID generation. (Default = 7Fh) |
| 7:4 | Reserved |
| 3:0 | USB_ENDPOINT_CNF — R/W. This 4-bit field identifies the endpoint used by the controller for all Token PID generation. (Default = 1h) |





18 Intel® High Definition Audio Controller Registers (D27:F0)

The Intel High Definition Audio controller resides in PCI Device 27, Function 0 on bus 0. This function contains a set of DMA engines that are used to move samples of digitally encoded data between system memory and external codecs.

Note: All registers in this function (including memory-mapped registers) must be addressable in byte, word, and D-word quantities. The software must always make register accesses on natural boundaries (i.e. D-word accesses must be on D-word boundaries; word accesses on word boundaries, etc.) In addition, the memory-mapped register space must not be accessed with the LOCK semantic exclusive-access mechanism. If software attempts exclusive-access mechanisms to the Intel High Definition Audio memory-mapped space, the results are undefined.

Note: Users interested in providing feedback on the Intel High Definition Audio specification or planning to implement the Intel High Definition Audio specification into a future product will need to execute the *Intel® High Definition Audio Specification Developer's Agreement*. For more information, contact nextgenaudio@intel.com.

18.1 Intel® High Definition Audio PCI Configuration Space (Intel® High Definition Audio— D27:F0)

Note: Address locations that are not shown should be treated as Reserved.

Table 18-1. Intel® High Definition Audio PCI Register Address Map (Intel® High Definition Audio D27:F0) (Sheet 1 of 2)

| Offset | Mnemonic | Register Name | Default | Access |
|---------|----------|----------------------------------------------------------|--------------------------|----------|
| 00h–01h | VID | Vendor Identification | 8086h | RO |
| 02h–03h | DID | Device Identification | See register description | RO |
| 04h–05h | PCICMD | PCI Command | 0000h | R/W, RO |
| 06h–07h | PCISTS | PCI Status | 0010h | R/WC, RO |
| 08h | RID | Revision Identification | See register description | RO |
| 09h | PI | Programming Interface | 00h | RO |
| 0Ah | SCC | Sub Class Code | 03h | RO |
| 0Bh | BCC | Base Class Code | 04h | RO |
| 0Ch | CLS | Cache Line Size | 00h | R/W |
| 0Dh | LT | Latency Timer | 00h | RO |
| 0Eh | HEADTYP | Header Type | 00h | RO |
| 10h–13h | HDBARL | Intel® High Definition Audio Lower Base Address (Memory) | 00000004h | R/W, RO |
| 14h–17h | HDBARU | Intel High Definition Audio Upper Base Address (Memory) | 00000000h | R/W |
| 2Ch–2Dh | SVID | Subsystem Vendor Identification | 0000h | R/WO |

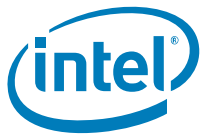
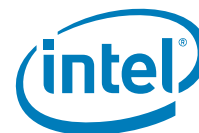

Table 18-1. Intel® High Definition Audio PCI Register Address Map (Intel® High Definition Audio D27:F0) (Sheet 2 of 2)

| | | | | |
|-----------|---------|----------------------------------------------------------|--------------------------|---------------|
| 2Eh–2Fh | SID | Subsystem Identification | 0000h | R/WO |
| 34h | CAPPTR | Capability List Pointer | 50h | RO |
| 3Ch | INTLN | Interrupt Line | 00h | R/W |
| 3Dh | INTPN | Interrupt Pin | See Register Description | RO |
| 40h | HDCTL | Intel High Definition Audio Control | 01h | R/W, RO |
| 44h | TCSEL | Traffic Class Select | 00h | R/W |
| 50h–51h | PID | PCI Power Management Capability ID | 6001h | R/WO, RO |
| 52h–53h | PC | Power Management Capabilities | C842h | RO |
| 54h–57h | PCS | Power Management Control and Status | 00000000h | R/W, RO, R/WC |
| 60h–61h | MID | MSI Capability ID | 7005h | RO |
| 62h–63h | MMC | MSI Message Control | 0080h | R/W, RO |
| 64h–67h | MMLA | MSI Message Lower Address | 00000000h | R/W, RO |
| 68h–6Bh | MMUA | SMI Message Upper Address | 00000000h | R/W |
| 6Ch–6Dh | MMD | MSI Message Data | 0000h | R/W |
| 70h–71h | PXID | PCI Express* Capability Identifiers | 0010h | RO |
| 72h–73h | PXC | PCI Express Capabilities | 0091h | RO |
| 74h–77h | DEVCAP | Device Capabilities | 10000000h | RO, R/WO |
| 78h–79h | DEVC | Device Control | 0800h | R/W, RO |
| 7Ah–7Bh | DEVS | Device Status | 0010h | RO |
| 100h–103h | VCCAP | Virtual Channel Enhanced Capability Header | 13010002h | R/WO |
| 104h–107h | PVCCAP1 | Port VC Capability Register 1 | 00000001h | RO |
| 108h–10Bh | PVCCAP2 | Port VC Capability Register 2 | 00000000h | RO |
| 10Ch–10D | PVCCTL | Port VC Control | 0000h | RO |
| 10Eh–10Fh | PVCSTS | Port VC Status | 0000h | RO |
| 110h–113h | VC0CAP | VC0 Resource Capability | 00000000h | RO |
| 114h–117h | VC0CTL | VC0 Resource Control | 800000FFh | R/W, RO |
| 11Ah–11Bh | VC0STS | VC0 Resource Status | 0000h | RO |
| 11Ch–11Fh | VCiCAP | VCi Resource Capability | 00000000h | RO |
| 120h–123h | VCiCTL | VCi Resource Control | 00000000h | R/W, RO |
| 126h–127h | VCiSTS | VCi Resource Status | 0000h | RO |
| 130h–133h | RCCAP | Root Complex Link Declaration Enhanced Capability Header | 00010005h | RO |
| 134h–137h | ESD | Element Self Description | 0F000100h | RO |
| 140h–143h | L1DESC | Link 1 Description | 00000001h | RO |
| 148h–14Bh | L1ADDL | Link 1 Lower Address | See Register Description | RO |
| 14Ch–14Fh | L1ADDU | Link 1 Upper Address | 00000000h | RO |



18.1.1 VID—Vendor Identification Register (Intel® High Definition Audio Controller—D27:F0)

Offset: 00h-01h Attribute: RO
Default Value: 8086h Size: 16 bits

| Bit | Description |
|------|------------------------------------------------------------------------------------|
| 15:0 | Vendor ID — RO. This is a 16-bit value assigned to Intel. Intel VID = 8086h |

18.1.2 DID—Device Identification Register (Intel® High Definition Audio Controller—D27:F0)

Offset Address: 02h-03h Attribute: RO
Default Value: See bit description Size: 16 bits

| Bit | Description |
|------|-----------------------------------------------------------------------------------------------------------------------------------------------------------------------------------------------------------------------------------------------|
| 15:0 | Device ID — RO. This is a 16-bit value assigned to the Intel® ICH10 Intel High Definition Audio controller. Refer to the <i>Intel® I/O Controller Hub (ICH10) Family Specification Update</i> for the value of the Device ID Register. |

18.1.3 PCICMD—PCI Command Register (Intel® High Definition Audio Controller—D27:F0)

Offset Address: 04h-05h Attribute: R/W, RO
Default Value: 0000h Size: 16 bits

| Bit | Description |
|-------|-------------------------------------------------------------------------------------------------------------------------------------------------------------------------------------------------------------------------------------|
| 15:11 | Reserved |
| 10 | Interrupt Disable (ID) — R/W. 0= The INTx# signals may be asserted. 1= The Intel® High Definition Audio controller's INTx# signal will be de-asserted. Note: that this bit does not affect the generation of MSI's. |
| 9 | Fast Back to Back Enable (FBE) — RO. Not implemented. Hardwired to 0. |
| 8 | SERR# Enable (SERR_EN) — R/W. SERR# is not generated by the ICH10 Intel High Definition Audio Controller. |
| 7 | Wait Cycle Control (WCC) — RO. Not implemented. Hardwired to 0. |
| 6 | Parity Error Response (PER) — R/W. Not implemented. |
| 5 | VGA Palette Snoop (VPS). Not implemented. Hardwired to 0. |
| 4 | Memory Write and Invalidate Enable (MWIE) — RO. Not implemented. Hardwired to 0. |
| 3 | Special Cycle Enable (SCE). Not implemented. Hardwired to 0. |



| Bit | Description |
|-----|---------------------------------------------------------------------------------------------------------------------------------------------------------------------------------------------------------------------------------------------------------------|
| 2 | Bus Master Enable (BME) — R/W. Controls standard PCI Express* bus mastering capabilities for Memory and I/O, reads and writes. Note that this bit also controls MSI generation since MSI's are essentially Memory writes. 0 = Disable 1 = Enable |
| 1 | Memory Space Enable (MSE) — R/W. Enables memory space addresses to the Intel High Definition Audio controller. 0 = Disable 1 = Enable |
| 0 | I/O Space Enable (IOSE)—RO. Hardwired to 0 since the Intel High Definition Audio controller does not implement I/O space. |

18.1.4 PCISTS—PCI Status Register (Intel® High Definition Audio Controller—D27:F0)

Offset Address: 06h-07h
Default Value: 0010h

Attribute: RO, R/WC
Size: 16 bits

| Bit | Description |
|------|-----------------------------------------------------------------------------------------------------------------------------------------------------------------------------------------------------------------------------------------------------------------------------------------------------------------------------------------------------------------|
| 15 | Detected Parity Error (DPE) — RO. Not implemented. Hardwired to 0. |
| 14 | SERR# Status (SERRS) — RO. Not implemented. Hardwired to 0. |
| 13 | Received Master Abort (RMA) — R/WC. Software clears this bit by writing a 1 to it. 0 = No master abort received. 1 = The Intel® High Definition Audio controller sets this bit when, as a bus master, it receives a master abort. When set, the Intel High Definition Audio controller clears the run bit for the channel that received the abort. |
| 12 | Received Target Abort (RTA) — RO. Not implemented. Hardwired to 0. |
| 11 | Signaled Target Abort (STA) — RO. Not implemented. Hardwired to 0. |
| 10:9 | DEVSEL# Timing Status (DEV_STS) — RO. Does not apply. Hardwired to 0. |
| 8 | Data Parity Error Detected (DPED) — RO. Not implemented. Hardwired to 0. |
| 7 | Fast Back to Back Capable (FB2BC) — RO. Does not apply. Hardwired to 0. |
| 6 | Reserved. |
| 5 | 66 MHz Capable (66MHZ_CAP) — RO. Does not apply. Hardwired to 0. |
| 4 | Capabilities List (CAP_LIST) — RO. Hardwired to 1. Indicates that the controller contains a capabilities pointer list. The first item is pointed to by looking at configuration offset 34h. |
| 3 | Interrupt Status (IS) — RO. 0 = This bit is 0 after the interrupt is cleared. 1 = This bit is 1 when the INTx# is asserted. Note that this bit is not set by an MSI. |
| 2:0 | Reserved. |



18.1.5 RID—Revision Identification Register (Intel® High Definition Audio Controller—D27:F0)

Offset: 08h Attribute: RO
Default Value: See bit description Size: 8 Bits

| Bit | Description |
|-----|------------------------------------------------------------------------------------------------------------------------------------------------------|
| 7:0 | Revision ID — RO. Refer to the <i>Intel® I/O Controller Hub (ICH10) Family Specification Update</i> for the value of the Revision ID Register |

18.1.6 PI—Programming Interface Register (Intel® High Definition Audio Controller—D27:F0)

Offset: 09h Attribute: RO
Default Value: 00h Size: 8 bits

| Bit | Description |
|-----|------------------------------------|
| 7:0 | Programming Interface — RO. |

18.1.7 SCC—Sub Class Code Register (Intel® High Definition Audio Controller—D27:F0)

Address Offset: 0Ah Attribute: RO
Default Value: 03h Size: 8 bits

| Bit | Description |
|-----|---------------------------------------------------------|
| 7:0 | Sub Class Code (SCC) — RO. 03h = Audio Device |

18.1.8 BCC—Base Class Code Register (Intel® High Definition Audio Controller—D27:F0)

Address Offset: 0Bh Attribute: RO
Default Value: 04h Size: 8 bits

| Bit | Description |
|-----|---------------------------------------------------------------|
| 7:0 | Base Class Code (BCC) — RO. 04h = Multimedia device |

18.1.9 CLS—Cache Line Size Register (Intel® High Definition Audio Controller—D27:F0)

Address Offset: 0Ch Attribute: R/W
Default Value: 00h Size: 8 bits

| Bit | Description |
|-----|------------------------------------------------------------------------------------------------------|
| 7:0 | Cache Line Size — R/W. Implemented as R/W register, but has no functional impact to the ICH10 |



18.1.10 LT—Latency Timer Register (Intel® High Definition Audio Controller—D27:F0)

Address Offset: 0Dh Attribute: RO
Default Value: 00h Size: 8 bits

| Bit | Description |
|-----|-------------------------------------|
| 7:0 | Latency Timer — RO. Hardwired to 00 |

18.1.11 HEADTYP—Header Type Register (Intel® High Definition Audio Controller—D27:F0)

Address Offset: 0Eh Attribute: RO
Default Value: 00h Size: 8 bits

| Bit | Description |
|-----|------------------------------------|
| 7:0 | Header Type — RO. Hardwired to 00. |

18.1.12 HDBARL—Intel® High Definition Audio Lower Base Address Register (Intel® High Definition Audio—D27:F0)

Address Offset: 10h-13h Attribute: R/W, RO
Default Value: 00000004h Size: 32 bits

| Bit | Description |
|-------|-----------------------------------------------------------------------------------------------------------------------------------------------------------------------------------------------------|
| 31:14 | Lower Base Address (LBA) — R/W. Base address for the Intel® High Definition Audio controller's memory mapped configuration registers. 16 Kbytes are requested by hardwiring bits 13:4 to 0s. |
| 13:4 | Reserved. |
| 3 | Prefetchable (PREF) — RO. Hardwired to 0 to indicate that this BAR is NOT prefetchable |
| 2:1 | Address Range (ADDRNG) — RO. Hardwired to 10b, indicating that this BAR can be located anywhere in 64-bit address space. |
| 0 | Space Type (SPTYP) — RO. Hardwired to 0. Indicates this BAR is located in memory space. |

18.1.13 HDBARU—Intel® High Definition Audio Upper Base Address Register (Intel® High Definition Audio Controller—D27:F0)

Address Offset: 14h-17h Attribute: R/W
Default Value: 00000000h Size: 32 bits

| Bit | Description |
|------|-------------------------------------------------------------------------------------------------------------------------------------------------------------------|
| 31:0 | Upper Base Address (UBA) — R/W. Upper 32 bits of the Base address for the Intel® High Definition Audio controller's memory mapped configuration registers. |



18.1.14 SVID—Subsystem Vendor Identification Register (Intel® High Definition Audio Controller—D27:F0)

| | | | |
|-----------------------|---------|------------|---------|
| Address Offset: | 2Ch–2Dh | Attribute: | R/WO |
| Default Value: | 0000h | Size: | 16 bits |
| Function Level Reset: | No | | |

The SVID register, in combination with the Subsystem ID register (D27:F0:2Eh), enable the operating environment to distinguish one audio subsystem from the other(s).

This register is implemented as write-once register. Once a value is written to it, the value can be read back. Any subsequent writes will have no effect.

This register is not affected by the D3_{HOT} to D0 transition.

| Bit | Description |
|------|------------------------------------|
| 15:0 | Subsystem Vendor ID — R/WO. |

18.1.15 SID—Subsystem Identification Register (Intel® High Definition Audio Controller—D27:F0)

| | | | |
|-----------------------|---------|------------|---------|
| Address Offset: | 2Eh–2Fh | Attribute: | R/WO |
| Default Value: | 0000h | Size: | 16 bits |
| Function Level Reset: | No | | |

The SID register, in combination with the Subsystem Vendor ID register (D27:F0:2Ch) make it possible for the operating environment to distinguish one audio subsystem from the other(s).

This register is implemented as write-once register. Once a value is written to it, the value can be read back. Any subsequent writes will have no effect.

This register is not affected by the D3_{HOT} to D0 transition.

| Bit | Description |
|------|-----------------------------|
| 15:0 | Subsystem ID — R/WO. |

18.1.16 CAPPTR—Capabilities Pointer Register (Intel® High Definition Audio Controller—D27:F0)

| | | | |
|-----------------|-----|------------|--------|
| Address Offset: | 34h | Attribute: | RO |
| Default Value: | 50h | Size: | 8 bits |

This register indicates the offset for the capability pointer.

| Bit | Description |
|-----|-------------------------------------------------------------------------------------------------------------------------------------------------------|
| 7:0 | Capabilities Pointer (CAP_PTR) — RO. This field indicates that the first capability pointer offset is offset 50h (Power Management Capability) |



18.1.20 TCSEL—Traffic Class Select Register (Intel® High Definition Audio Controller—D27:F0)

| | | | |
|-----------------------|-----|------------|--------|
| Address Offset: | 44h | Attribute: | R/W |
| Default Value: | 00h | Size: | 8 bits |
| Function Level Reset: | No | | |

This register assigned the value to be placed in the TC field. CORB and RIRB data will always be assigned TC0.

| Bit | Description |
|-----|----------------------------------------------------------------------------------------------------------------------------------------------------------------------------------------------------------------------------------------------------------------------------------------------------------------------------------------------------------------------------------------------------------------------------------------------------------------------------------------------------------------------------------------------------------|
| 7:3 | Reserved. |
| 2:0 | <p>Intel® High Definition Audio Traffic Class Assignment (TCSEL)— R/W.</p> <p>This register assigns the value to be placed in the Traffic Class field for input data, output data, and buffer descriptor transactions.</p> <p>000 = TC0 001 = TC1 010 = TC2 011 = TC3 100 = TC4 101 = TC5 110 = TC6 111 = TC7</p> <p>NOTE: These bits are not reset on D3_{HOT} to D0 transition; however, they are reset by PLTRST#.</p> |

18.1.21 PID—PCI Power Management Capability ID Register (Intel® High Definition Audio Controller—D27:F0)

| | | | |
|-----------------------|--------------------|------------|----------|
| Address Offset: | 50h-51h | Attribute: | R/WO, RO |
| Default Value: | 6001h | Size: | 16 bits |
| Function Level Reset: | No (Bits 7:0 only) | | |

| Bit | Description |
|------|-----------------------------------------------------------------------------------------------------------------------------------------------------------------|
| 15:8 | Next Capability (Next) — R/WO. Points to the next capability structure (MSI). |
| 7:0 | Cap ID (CAP) — RO. Hardwired to 01h. Indicates that this pointer is a PCI power management capability. These bits are not reset by Function Level Reset. |



18.1.22 PC—Power Management Capabilities Register (Intel® High Definition Audio Controller—D27:F0)

Address Offset: 52h-53h Attribute: RO
Default Value: C842h Size: 16 bits

| Bit | Description |
|-------|---------------------------------------------------------------------------------------------------------------------------------------|
| 15:11 | PME Support — RO. Hardwired to 11001b. Indicates PME# can be generated from D3 and D0 states. |
| 10 | D2 Support — RO. Hardwired to 0. Indicates that D2 state is not supported. |
| 9 | D1 Support —RO. Hardwired to 0. Indicates that D1 state is not supported. |
| 8:6 | Aux Current — RO. Hardwired to 001b. Reports 55 mA maximum suspend well current required when in the D3 _{COLD} state. |
| 5 | Device Specific Initialization (DSI) — RO. Hardwired to 0. Indicates that no device specific initialization is required. |
| 4 | Reserved |
| 3 | PME Clock (PMEC) — RO. Does not apply. Hardwired to 0. |
| 2:0 | Version — RO. Hardwired to 010b. Indicates support for version 1.1 of the PCI Power Management Specification. |



18.1.23 PCS—Power Management Control and Status Register (Intel® High Definition Audio Controller—D27:F0)

Address Offset: 54h-57h Attribute: RO, R/W, R/WC
 Default Value: 00000000h Size: 32 bits
 Function Level Reset: No

| Bit | Description |
|-------|-----------------------------------------------------------------------------------------------------------------------------------------------------------------------------------------------------------------------------------------------------------------------------------------------------------------------------------------------------------------------------------------------------------------------------------------------------------------------------------------------------------------------------------------------------------------------------------------------------------------------------------------------------------------------------------------------------------------------------------------------------------------------------------------------------------------------------------------------------------------------------------------------------------------------------------------------|
| 31:24 | Data — RO. Does not apply. Hardwired to 0. |
| 23 | Bus Power/Clock Control Enable — RO. Does not apply. Hardwired to 0. |
| 22 | B2/B3 Support — RO. Does not apply. Hardwired to 0. |
| 21:16 | Reserved. |
| 15 | <p>PME Status (PMES) — R/WC. 0 = Software clears the bit by writing a 1 to it. 1 = This bit is set when the Intel® High Definition Audio controller would normally assert the PME# signal independent of the state of the PME_EN bit (bit 8 in this register).</p> <p>This bit is in the resume well and is cleared by a power-on reset. Software must not make assumptions about the reset state of this bit and must set it appropriately.</p> |
| 14:9 | Reserved |
| 8 | <p>PME Enable (PMEE) — R/W. 0 = Disable 1 = When set and if corresponding PMES also set, the Intel High Definition Audio controller sets the PME_BO_STS bit in the GPE0_STS register (PMBASE +28h).</p> <p>This bit in the resume well and is cleared on a power-on reset. Software must not make assumptions about the reset state of this bit and must set it appropriately.</p> |
| 7:2 | Reserved |
| 1:0 | <p>Power State (PS) — R/W. This field is used both to determine the current power state of the Intel High Definition Audio controller and to set a new power state. 00 = D0 state 11 = D3_{HOT} state Others = reserved</p> <p>NOTES:</p> <ol style="list-style-type: none"> 1. If software attempts to write a value of 01b or 10b in to this field, the write operation must complete normally; however, the data is discarded and no state change occurs. 2. When in the D3_{HOT} states, the Intel High Definition Audio controller's configuration space is available, but the IO and memory space are not. Additionally, interrupts are blocked. 3. When software changes this value from D3_{HOT} state to the D0 state, an internal warm (soft) reset is generated, and software must re-initialize the function. |



18.1.24 MID—MSI Capability ID Register (Intel® High Definition Audio Controller—D27:F0)

Address Offset: 60h-61h Attribute: RO
Default Value: 7005h Size: 16 bits

| Bit | Description |
|------|--------------------------------------------------------------------------------------------------------|
| 15:8 | Next Capability (Next) — RO. Hardwired to 70h. Points to the PCI Express* capability structure. |
| 7:0 | Cap ID (CAP) — RO. Hardwired to 05h. Indicates that this pointer is a MSI capability |

18.1.25 MMC—MSI Message Control Register (Intel® High Definition Audio Controller—D27:F0)

Address Offset: 62h-63h Attribute: RO, R/W
Default Value: 0080h Size: 16 bits

| Bit | Description |
|------|---------------------------------------------------------------------------------------------------------------------------------------------------------------------|
| 15:8 | Reserved |
| 7 | 64b Address Capability (64ADD) — RO. Hardwired to 1. Indicates the ability to generate a 64-bit message address |
| 6:4 | Multiple Message Enable (MME) — RO. Normally this is a R/W register. However since only 1 message is supported, these bits are hardwired to 000 = 1 message. |
| 3:1 | Multiple Message Capable (MMC) — RO. Hardwired to 0 indicating request for 1 message. |
| 0 | MSI Enable (ME) — R/W. 0 = an MSI may not be generated 1 = an MSI will be generated instead of an INTx signal. |

18.1.26 MMLA—MSI Message Lower Address Register (Intel® High Definition Audio Controller—D27:F0)

Address Offset: 64h-67h Attribute: RO, R/W
Default Value: 00000000h Size: 32 bits

| Bit | Description |
|------|-------------------------------------------------------------------------------|
| 31:2 | Message Lower Address (MLA) — R/W. Lower address used for MSI message. |
| 1:0 | Reserved. |

18.1.27 MMUA—MSI Message Upper Address Register (Intel® High Definition Audio Controller—D27:F0)

Address Offset: 68h-6Bh Attribute: R/W
Default Value: 00000000h Size: 32 bits

| Bit | Description |
|------|------------------------------------------------------------------------------------------|
| 31:0 | Message Upper Address (MUA) — R/W. Upper 32-bits of address used for MSI message. |



18.1.31 DEVCAP—Device Capabilities Register (Intel® High Definition Audio Controller—D27:F0)

Address Offset: 74h-77h Attribute: R/WO, RO
Default Value: 10000000h Size: 32 bits
Function Level Reset: No

| Bit | Description |
|-------|------------------------------------------------------------------------------------------------------------------------------------------|
| 31:29 | Reserved |
| 28 | Function Level Reset (FLR) — R/WO. A 1 indicates that the ICH10 HD Audio Controller supports the Function Level Reset Capability. |
| 27:26 | Captured Slot Power Limit Scale (SPLS) — RO. Hardwired to 0. |
| 25:18 | Captured Slot Power Limit Value (SPLV) — RO. Hardwired to 0. |
| 17:15 | Reserved |
| 14 | Power Indicator Present — RO. Hardwired to 0. |
| 13 | Attention Indicator Present — RO. Hardwired to 0. |
| 12 | Attention Button Present — RO. Hardwired to 0. |
| 11:9 | Endpoint L1 Acceptable Latency — R/WO. |
| 8:6 | Endpoint LOs Acceptable Latency — R/WO. |
| 5 | Extended Tag Field Support — RO. Hardwired to 0. Indicates 5-bit tag field support |
| 4:3 | Phantom Functions Supported — RO. Hardwired to 0. Indicates that phantom functions not supported |
| 2:0 | Max Payload Size Supported — RO. Hardwired to 0. Indicates 128-B maximum payload size capability |



18.1.32 DEVC—Device Control Register (Intel® High Definition Audio Controller—D27:F0)

Address Offset: 78h-79h Attribute: R/W, RO
 Default Value: 0800h Size: 16 bits
 Function Level Reset: No (Bit 11 Only)

| Bit | Description |
|-------|------------------------------------------------------------------------------------------------------------------------------------------------------------------------------------------------------------------------------------------------------------------------------------------------------------------------------------------------------------------------------------------------------------------------------------------------------------------------------------------------------------------------------------------------------------------------------------------------------------------------------------------------------------|
| 15 | Initiate FLR (IF) — R/W. This bit is used to initiate FLR transition. 1 = A write of 1 initiates FLR transition. Since hardware does not respond to any cycles until FLR completion, the read value by software from this bit is 0. |
| 14:12 | Max Read Request Size — RO. Hardwired to 0 enabling 128B maximum read request size. |
| 11 | No Snoop Enable (NSNPEN) — R/W. 0 = The Intel® High Definition Audio controller will not set the No Snoop bit. In this case, isochronous transfers will not use VC1 (VCi) even if it is enabled since VC1 is never snooped. Isochronous transfers will use VC0. 1 = The Intel High Definition Audio controller is permitted to set the No Snoop bit in the Requester Attributes of a bus master transaction. In this case, VC0 or VC1 may be used for isochronous transfers. NOTE: This bit is not reset on D3 _{HOT} to D0 transition; however, it is reset by PLTRST#. This bit is not reset by Function Level Reset. |
| 10 | Auxiliary Power Enable — RO. Hardwired to 0, indicating that Intel High Definition Audio device does not draw AUX power |
| 9 | Phantom Function Enable — RO. Hardwired to 0 disabling phantom functions. |
| 8 | Extended Tag Field Enable — RO. Hardwired to 0 enabling 5-bit tag. |
| 7:5 | Max Payload Size — RO. Hardwired to 0 indicating 128B. |
| 4 | Enable Relaxed Ordering — RO. Hardwired to 0 disabling relaxed ordering. |
| 3 | Unsupported Request Reporting Enable — R/W. Not implemented. |
| 2 | Fatal Error Reporting Enable — R/W. Not implemented. |
| 1 | Non-Fatal Error Reporting Enable — R/W. Not implemented. |
| 0 | Correctable Error Reporting Enable — R/W. Not implemented. |



18.1.33 DEVS—Device Status Register (Intel® High Definition Audio Controller—D27:F0)

Address Offset: 7Ah-7Bh Attribute: RO
Default Value: 0010h Size: 16 bits

| Bit | Description |
|------|------------------------------------------------------------------------------------------------------------------------------------------------------------------------------------------------------------------------------------------------|
| 15:6 | Reserved |
| 5 | Transactions Pending — RO. 0 = Indicates that completions for all non-posted requests have been received 1 = Indicates that Intel® High Definition Audio controller has issued non-posted requests which have not been completed. |
| 4 | AUX Power Detected — RO. Hardwired to 1 indicating the device is connected to resume power |
| 3 | Unsupported Request Detected — RO. Not implemented. Hardwired to 0. |
| 2 | Fatal Error Detected — RO. Not implemented. Hardwired to 0. |
| 1 | Non-Fatal Error Detected — RO. Not implemented. Hardwired to 0. |
| 0 | Correctable Error Detected — RO. Not implemented. Hardwired to 0. |

18.1.34 VCCAP—Virtual Channel Enhanced Capability Header (Intel® High Definition Audio Controller—D27:F0)

Address Offset: 100h-103h Attribute: R/WO
Default Value: 13010002h Size: 32 bits

| Bit | Description |
|-------|---------------------------------------------------------------------------------------------------------------------------------------------------------------------------------------------------------------------------------------------------------------------------------------------|
| 31:20 | Next Capability Offset — R/WO. Points to the next capability header. 130h = Root Complex Link Declaration Enhanced Capability Header 000h = Root Complex Link Declaration Enhanced Capability Header is not supported. |
| 19:16 | Capability Version — R/WO. 0h = PCI Express Virtual channel capability and the Root Complex Topology Capability structure are not supported. 1h = PCI Express Virtual channel capability and the Root Complex Topology Capability structure are supported. |
| 15:0 | PCI Express* Extended Capability — R/WO. 0000h = PCI Express Virtual channel capability and the Root Complex Topology Capability structure are not supported. 0002h = PCI Express Virtual channel capability and the Root Complex Topology Capability structure are supported. |



18.1.35 PVCCAP1—Port VC Capability Register 1 (Intel® High Definition Audio Controller—D27:F0)

Address Offset: 104h-107h Attribute: RO
 Default Value: 00000001h Size: 32 bits

| Bit | Description |
|-------|------------------------------------------------------------------------------------------------------------------------------------------------------------------|
| 31:12 | Reserved. |
| 11:10 | Port Arbitration Table Entry Size — RO. Hardwired to 0 since this is an endpoint device. |
| 9:8 | Reference Clock — RO. Hardwired to 0 since this is an endpoint device. |
| 7 | Reserved. |
| 6:4 | Low Priority Extended VC Count — RO. Hardwired to 0. Indicates that only VC0 belongs to the low priority VC group |
| 3 | Reserved. |
| 2:0 | Extended VC Count — RO. Hardwired to 001b. Indicates that 1 extended VC (in addition to VC0) is supported by the Intel® High Definition Audio controller. |

18.1.36 PVCCAP2 — Port VC Capability Register 2 (Intel® High Definition Audio Controller—D27:F0)

Address Offset: 108h-10Bh Attribute: RO
 Default Value: 00000000h Size: 32 bits

| Bit | Description |
|-------|-----------------------------------------------------------------------------------------------------------------------------------------------------------------------------------------------------------------|
| 31:24 | VC Arbitration Table Offset — RO. Hardwired to 0 indicating that a VC arbitration table is not present. |
| 23:8 | Reserved. |
| 7:0 | VC Arbitration Capability — RO. Hardwired to 0. These bits are not applicable since the Intel® High Definition Audio controller reports a 0 in the Low Priority Extended VC Count bits in the PVCCAP1 register. |

18.1.37 PVCCTL — Port VC Control Register (Intel® High Definition Audio Controller—D27:F0)

Address Offset: 10Ch-10Dh Attribute: RO
 Default Value: 0000h Size: 16 bits

| Bit | Description |
|------|--------------------------------------------------------------------------------------------------------------------------------------------------------------------------------------------------------------------------------------------------|
| 15:4 | Reserved. |
| 3:1 | VC Arbitration Select — RO. Hardwired to 0. Normally these bits are R/W. However, these bits are not applicable since the Intel® High Definition Audio controller reports a 0 in the Low Priority Extended VC Count bits in the PVCCAP1 register |
| 0 | Load VC Arbitration Table — RO. Hardwired to 0 since an arbitration table is not present. |

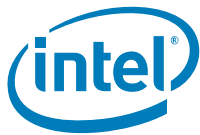

18.1.38 PVCSTS—Port VC Status Register (Intel® High Definition Audio Controller—D27:F0)

Address Offset: 10Eh-10Fh Attribute: RO
Default Value: 0000h Size: 16 bits

| Bit | Description |
|------|---------------------------------------------------------------------------------------------|
| 15:1 | Reserved. |
| 0 | VC Arbitration Table Status — RO. Hardwired to 0 since an arbitration table is not present. |

18.1.39 VCOCAP—VCO Resource Capability Register (Intel® High Definition Audio Controller—D27:F0)

Address Offset: 110h-113h Attribute: RO
Default Value: 00000000h Size: 32 bits

| Bit | Description |
|-------|-------------------------------------------------------------------------------------------------------|
| 31:24 | Port Arbitration Table Offset — RO. Hardwired to 0 since this field is not valid for endpoint devices |
| 23 | Reserved. |
| 22:16 | Maximum Time Slots — RO. Hardwired to 0 since this field is not valid for endpoint devices |
| 15 | Reject Snoop Transactions — RO. Hardwired to 0 since this field is not valid for endpoint devices. |
| 14 | Advanced Packet Switching — RO. Hardwired to 0 since this field is not valid for endpoint devices |
| 13:8 | Reserved. |
| 7:0 | Port Arbitration Capability — RO. Hardwired to 0 since this field is not valid for endpoint devices |



18.1.40 VCOCTL—VC0 Resource Control Register (Intel® High Definition Audio Controller—D27:F0)

Address Offset: 114h-117h Attribute: R/W, RO
 Default Value: 80000FFh Size: 32 bits
 Function Level Reset: No

| Bit | Description |
|-------|------------------------------------------------------------------------------------------------------------------------------|
| 31 | VC0 Enable — RO. Hardwired to 1 for VC0. |
| 30:27 | Reserved. |
| 26:24 | VC0 ID — RO. Hardwired to 0 since the first VC is always assigned as VC0. |
| 23:20 | Reserved. |
| 19:17 | Port Arbitration Select — RO. Hardwired to 0 since this field is not valid for endpoint devices. |
| 16 | Load Port Arbitration Table — RO. Hardwired to 0 since this field is not valid for endpoint devices. |
| 15:8 | Reserved. |
| 7:0 | TC/VC0 Map — R/W, RO. Bit 0 is hardwired to 1 since TC0 is always mapped VC0. Bits [7:1] are implemented as R/W bits. |

18.1.41 VCOSTS—VC0 Resource Status Register (Intel® High Definition Audio Controller—D27:F0)

Address Offset: 11Ah-11Bh Attribute: RO
 Default Value: 0000h Size: 16 bits

| Bit | Description |
|------|-----------------------------------------------------------------------------------------------------------------------------------|
| 15:2 | Reserved. |
| 1 | VC0 Negotiation Pending — RO. Hardwired to 0 since this bit does not apply to the integrated Intel® High Definition Audio device. |
| 0 | Port Arbitration Table Status — RO. Hardwired to 0 since this field is not valid for endpoint devices. |



18.1.42 VCiCAP—VCi Resource Capability Register (Intel® High Definition Audio Controller—D27:F0)

Address Offset: 11Ch-11Fh Attribute: RO
 Default Value: 00000000h Size: 32 bits

| Bit | Description |
|-------|--------------------------------------------------------------------------------------------------------|
| 31:24 | Port Arbitration Table Offset — RO. Hardwired to 0 since this field is not valid for endpoint devices. |
| 23 | Reserved. |
| 22:16 | Maximum Time Slots — RO. Hardwired to 0 since this field is not valid for endpoint devices. |
| 15 | Reject Snoop Transactions — RO. Hardwired to 0 since this field is not valid for endpoint devices. |
| 14 | Advanced Packet Switching — RO. Hardwired to 0 since this field is not valid for endpoint devices. |
| 13:8 | Reserved |
| 7:0 | Port Arbitration Capability — RO. Hardwired to 0 since this field is not valid for endpoint devices. |

18.1.43 VCiCTL—VCi Resource Control Register (Intel® High Definition Audio Controller—D27:F0)

Address Offset: 120h-123h Attribute: R/W, RO
 Default Value: 00000000h Size: 32 bits
 Function Level Reset: No

| Bit | Description |
|-------|-----------------------------------------------------------------------------------------------------------------------------------------------------------------------------------------------------------------------------------------------------------------------------------------------------|
| 31 | VCi Enable — R/W. 0 = VCi is disabled 1 = VCi is enabled NOTE: This bit is not reset on D3 _{HOT} to D0 transition; however, it is reset by PLTRST#. |
| 30:27 | Reserved. |
| 26:24 | VCi ID — R/W. This field assigns a VC ID to the VCi resource. This field is not used by the ICH10 hardware, but it is R/W to avoid confusing software. |
| 23:20 | Reserved. |
| 19:17 | Port Arbitration Select — RO. Hardwired to 0 since this field is not valid for endpoint devices. |
| 16 | Load Port Arbitration Table — RO. Hardwired to 0 since this field is not valid for endpoint devices. |
| 15:8 | Reserved. |
| 7:0 | TC/VCi Map — R/W, RO. This field indicates the TCs that are mapped to the VCi resource. Bit 0 is hardwired to 0 indicating that it cannot be mapped to VCi. Bits [7:1] are implemented as R/W bits. This field is not used by the ICH10 hardware, but it is R/W to avoid confusing software. |



18.1.44 VCISTS—VCi Resource Status Register (Intel® High Definition Audio Controller—D27:F0)

Address Offset: 126h-127h Attribute: RO
 Default Value: 0000h Size: 16 bits

| Bit | Description |
|------|--------------------------------------------------------------------------------------------------------|
| 15:2 | Reserved. |
| 1 | VCi Negotiation Pending — RO. Does not apply. Hardwired to 0. |
| 0 | Port Arbitration Table Status — RO. Hardwired to 0 since this field is not valid for endpoint devices. |

18.1.45 RCCAP—Root Complex Link Declaration Enhanced Capability Header Register (Intel® High Definition Audio Controller—D27:F0)

Address Offset: 130h Attribute: RO
 Default Value: 00010005h Size: 32 bits

| Bit | Description |
|-------|--------------------------------------------------------------------------------------------|
| 31:20 | Next Capability Offset — RO. Hardwired to 0 indicating this is the last capability. |
| 19:16 | Capability Version — RO. Hardwired to 1h. |
| 15:0 | PCI Express* Extended Capability ID — RO. Hardwired to 0005h. |

18.1.46 ESD—Element Self Description Register (Intel® High Definition Audio Controller—D27:F0)

Address Offset: 134h-137h Attribute: RO
 Default Value: 0F000100h Size: 32 bits

| Bit | Description |
|-------|---------------------------------------------------------------------------------------------------------------------------------------------------------------------|
| 31:24 | Port Number — RO. Hardwired to 0Fh indicating that the Intel® High Definition Audio controller is assigned as Port #15d. |
| 23:16 | Component ID — RO. This field returns the value of the ESD.CID field of the chip configuration section. ESD.CID is programmed by BIOS. |
| 15:8 | Number of Link Entries — RO. The Intel High Definition Audio only connects to one device, the ICH10 egress port. Therefore this field reports a value of 1h. |
| 7:4 | Reserved. |
| 3:0 | Element Type (ELTYP) — RO. The Intel High Definition Audio controller is an integrated Root Complex Device. Therefore, the field reports a value of 0h. |



18.1.47 L1DESC—Link 1 Description Register (Intel® High Definition Audio Controller—D27:F0)

Address Offset: 140h-143h Attribute: RO
Default Value: 00000001h Size: 32 bits

| Bit | Description |
|-------|------------------------------------------------------------------------------------------------------------------------------------------------------|
| 31:24 | Target Port Number — RO. The Intel High Definition Audio controller targets the Intel® ICH10's Port 0. |
| 23:16 | Target Component ID — RO. This field returns the value of the ESD.CID field of the chip configuration section. ESD.CID is programmed by BIOS. |
| 15:2 | Reserved. |
| 1 | Link Type — RO. Hardwired to 0 indicating Type 0. |
| 0 | Link Valid — RO. Hardwired to 1. |

18.1.48 L1ADDL—Link 1 Lower Address Register (Intel® High Definition Audio Controller—D27:F0)

Address Offset: 148h-14Bh Attribute: RO
Default Value: See Register Description Size: 32 bits

| Bit | Description |
|-------|------------------------------------------------------------------------------------------------------------------|
| 31:14 | Link 1 Lower Address — RO. Hardwired to match the RCBA register value in the PCI-LPC bridge (D31:F0:F0h). |
| 13:0 | Reserved. |

18.1.49 L1ADDU—Link 1 Upper Address Register (Intel® High Definition Audio Controller—D27:F0)

Address Offset: 14Ch-14Fh Attribute: RO
Default Value: 00000000h Size: 32 bits

| Bit | Description |
|------|-----------------------------------------------------------|
| 31:0 | Link 1 Upper Address — RO. Hardwired to 00000000h. |



18.2 Intel® High Definition Audio Memory Mapped Configuration Registers (Intel® High Definition Audio— D27:F0)

The base memory location for these memory mapped configuration registers is specified in the HDBAR register (D27:F0:offset 10h and D27:F0:offset 14h). The individual registers are then accessible at HDBAR + Offset as indicated in [Table 18.2](#).

These memory mapped registers must be accessed in byte, word, or dword quantities.

Table 18-2. Intel® High Definition Audio PCI Register Address Map (Intel® High Definition Audio D27:F0) (Sheet 1 of 4)

| HDBAR + Offset | Mnemonic | Register Name | Default | Access |
|----------------|------------|----------------------------------|-----------|---------|
| 00h–01h | GCAP | Global Capabilities | 4401h | RO |
| 02h | VMIN | Minor Version | 00h | RO |
| 03h | VMAJ | Major Version | 01h | RO |
| 04h–05h | OUTPAY | Output Payload Capability | 003Ch | RO |
| 06h–07h | INPAY | Input Payload Capability | 001Dh | RO |
| 08h–0Bh | GCTL | Global Control | 00000000h | R/W |
| 0Ch–0Dh | WAKEEN | Wake Enable | 0000h | R/W |
| 0Eh–0Fh | STATESTS | State Change Status | 0000h | R/WC |
| 10h–11h | GSTS | Global Status | 0000h | R/WC |
| 12h–13h | Rsv | Reserved | 0000h | RO |
| 18h–19h | OUTSTRMPAY | Output Stream Payload Capability | 0030h | RO |
| 1Ah–1Bh | INSTRMPAY | Input Stream Payload Capability | 0018h | RO |
| 1Ch–1Fh | Rsv | Reserved | 00000000h | RO |
| 20h–23h | INTCTL | Interrupt Control | 00000000h | R/W |
| 24h–27h | INTSTS | Interrupt Status | 00000000h | RO |
| 30h–33h | WALCLK | Wall Clock Counter | 00000000h | RO |
| 34h–37h | SSYNC | Stream Synchronization | 00000000h | R/W |
| 40h–43h | CORBLOWER | CORB Lower Base Address | 00000000h | R/W, RO |
| 44h–47h | CORBUPPER | CORB Upper Base Address | 00000000h | R/W |
| 48h–49h | CORBWP | CORB Write Pointer | 0000h | R/W |
| 4Ah–4Bh | CORBRP | CORB Read Pointer | 0000h | R/W, RO |
| 4Ch | CORBCTL | CORB Control | 00h | R/W |
| 4Dh | CORBST | CORB Status | 00h | R/WC |
| 4Eh | CORBSIZE | CORB Size | 42h | RO |
| 50h–53h | RIRBLLOWER | RIRB Lower Base Address | 00000000h | R/W, RO |
| 54h–57h | RIRBUPPER | RIRB Upper Base Address | 00000000h | R/W |
| 58h–59h | RIRBWP | RIRB Write Pointer | 0000h | R/W, RO |
| 5Ah–5Bh | RINTCNT | Response Interrupt Count | 0000h | R/W |
| 5Ch | RIRBCTL | RIRB Control | 00h | R/W |



Table 18-2. Intel® High Definition Audio PCI Register Address Map (Intel® High Definition Audio D27:F0) (Sheet 2 of 4)

| HDBAR + Offset | Mnemonic | Register Name | Default | Access |
|----------------|-----------|---------------------------------------------------------|-----------|-----------|
| 5Dh | RIRBSTS | RIRB Status | 00h | R/WC |
| 5Eh | RIRBSIZE | RIRB Size | 42h | RO |
| 60h–63h | IC | Immediate Command | 00000000h | R/W |
| 64h–67h | IR | Immediate Response | 00000000h | RO |
| 68h–69h | IRS | Immediate Command Status | 0000h | R/W, R/WC |
| 70h–73h | DPLBASE | DMA Position Lower Base Address | 00000000h | R/W, RO |
| 74h–77h | DPUBASE | DMA Position Upper Base Address | 00000000h | R/W |
| 80–82h | ISD0CTL | Input Stream Descriptor 0 (ISD0) Control | 040000h | R/W, RO |
| 83h | ISD0STS | ISD0 Status | 00h | R/WC, RO |
| 84h–87h | ISD0LPIB | ISD0 Link Position in Buffer | 00000000h | RO |
| 88h–8Bh | ISD0CBL | ISD0 Cyclic Buffer Length | 00000000h | R/W |
| 8Ch–8Dh | ISD0LVI | ISD0 Last Valid Index | 0000h | R/W |
| 8Eh–8Fh | ISD0FIFOW | ISD0 FIFO Watermark | 0004h | R/W |
| 90h–91h | ISD0FIFOS | ISD0 FIFO Size | 0077h | RO |
| 92h–93h | ISD0FMT | ISD0 Format | 0000h | R/W |
| 98h–9Bh | ISD0BDPL | ISD0 Buffer Descriptor List Pointer-Lower Base Address | 00000000h | R/W, RO |
| 9Ch–9Fh | ISD0BDPU | ISD0 Buffer Description List Pointer-Upper Base Address | 00000000h | R/W |
| A0h–A2h | ISD1CTL | Input Stream Descriptor 1 (ISD01) Control | 040000h | R/W, RO |
| A3h | ISD1STS | ISD1 Status | 00h | R/WC, RO |
| A4h–A7h | ISD1LPIB | ISD1 Link Position in Buffer | 00000000h | RO |
| A8h–ABh | ISD1CBL | ISD1 Cyclic Buffer Length | 00000000h | R/W |
| ACH–ADh | ISD1LVI | ISD1 Last Valid Index | 0000h | R/W |
| A Eh–AFh | ISD1FIFOW | ISD1 FIFO Watermark | 0004h | R/W |
| B0h–B1h | ISD1FIFOS | ISD1 FIFO Size | 0077h | RO |
| B2h–B3h | ISD1FMT | ISD1 Format | 0000h | R/W |
| B8h–BBh | ISD1BDPL | ISD1 Buffer Descriptor List Pointer-Lower Base Address | 00000000h | R/W, RO |
| BCh–BFh | ISD1BDPU | ISD1 Buffer Description List Pointer-Upper Base Address | 00000000h | R/W |
| C0h–C2h | ISD2CTL | Input Stream Descriptor 2 (ISD2) Control | 040000h | R/W, RO |
| C3h | ISD2STS | ISD2 Status | 00h | R/WC, RO |
| C4h–C7h | ISD2LPIB | ISD2 Link Position in Buffer | 00000000h | RO |
| C8h–CBh | ISD2CBL | ISD2 Cyclic Buffer Length | 00000000h | R/W |

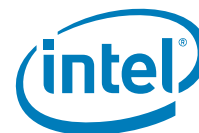

Table 18-2. Intel® High Definition Audio PCI Register Address Map (Intel® High Definition Audio D27:F0) (Sheet 3 of 4)

| HDBAR + Offset | Mnemonic | Register Name | Default | Access |
|----------------|-----------|---------------------------------------------------------|-----------|----------|
| CCh–CDh | ISD2LVI | ISD2 Last Valid Index | 0000h | R/W |
| CEh–CFh | ISD1FIFOW | ISD1 FIFO Watermark | 0004h | R/W |
| D0h–D1h | ISD2FIFOS | ISD2 FIFO Size | 0077h | RO |
| D2h–D3h | ISD2FMT | ISD2 Format | 0000h | R/W |
| D8h–DBh | ISD2BDPL | ISD2 Buffer Descriptor List Pointer-Lower Base Address | 00000000h | R/W, RO |
| DCh–DFh | ISD2BDPU | ISD2 Buffer Description List Pointer-Upper Base Address | 00000000h | R/W |
| E0h–E2h | ISD3CTL | Input Stream Descriptor 3 (ISD3) Control | 040000h | R/W, RO |
| E3h | ISD3STS | ISD3 Status | 00h | R/WC, RO |
| E4h–E7h | ISD3LPIB | ISD3 Link Position in Buffer | 00000000h | RO |
| E8h–EBh | ISD3CBL | ISD3 Cyclic Buffer Length | 00000000h | R/W |
| ECh–EDh | ISD3LVI | ISD3 Last Valid Index | 0000h | R/W |
| EEh–EFh | ISD3FIFOW | ISD3 FIFO Watermark | 0004h | R/W |
| F0h–F1h | ISD3FIFOS | ISD3 FIFO Size | 0077h | RO |
| F2h–F3h | ISD3FMT | ISD3 Format | 0000h | R/W |
| F8h–FBh | ISD3BDPL | ISD3 Buffer Descriptor List Pointer-Lower Base Address | 00000000h | R/W, RO |
| FCh–FFh | ISD3BDPU | ISD3 Buffer Description List Pointer-Upper Base Address | 00000000h | R/W |
| 100h–102h | OSD0CTL | Output Stream Descriptor 0 (OSD0) Control | 040000h | R/W, RO |
| 103h | OSD0STS | OSD0 Status | 00h | R/WC, RO |
| 104h–107h | OSD0LPIB | OSD0 Link Position in Buffer | 00000000h | RO |
| 108h–10Bh | OSD0CBL | OSD0 Cyclic Buffer Length | 00000000h | R/W |
| 10Ch–10Dh | OSD0LVI | OSD0 Last Valid Index | 0000h | R/W |
| 10Eh–10Fh | OSD0FIFOW | OSD0 FIFO Watermark | 0004h | R/W |
| 110h–111h | OSD0FIFOS | OSD0 FIFO Size | 00BFh | R/W |
| 112–113h | OSD0FMT | OSD0 Format | 0000h | R/W |
| 118h–11Bh | OSD0BDPL | OSD0 Buffer Descriptor List Pointer-Lower Base Address | 00000000h | R/W, RO |
| 11Ch–11Fh | OSD0BDPU | OSD0 Buffer Description List Pointer-Upper Base Address | 00000000h | R/W |
| 120h–122h | OSD1CTL | Output Stream Descriptor 1 (OSD1) Control | 040000h | R/W, RO |
| 123h | OSD1STS | OSD1 Status | 00h | R/WC, RO |
| 124h–127h | OSD1LPIB | OSD1 Link Position in Buffer | 00000000h | RO |
| 128h–12Bh | OSD1CBL | OSD1 Cyclic Buffer Length | 00000000h | R/W |



Table 18-2. Intel® High Definition Audio PCI Register Address Map (Intel® High Definition Audio D27:F0) (Sheet 4 of 4)

| HDBAR + Offset | Mnemonic | Register Name | Default | Access |
|----------------|-----------|---------------------------------------------------------|-----------|----------|
| 12Ch–12Dh | OSD1LVI | OSD1 Last Valid Index | 0000h | R/W |
| 12Eh–12Fh | OSD1FIFOW | OSD1 FIFO Watermark | 0004h | R/W |
| 130h–131h | OSD1FIFOS | OSD1 FIFO Size | 00BFh | R/W |
| 132h–133h | OSD1FMT | OSD1 Format | 0000h | R/W |
| 138h–13Bh | OSD1BDPL | OSD1 Buffer Descriptor List Pointer-Lower Base Address | 00000000h | R/W, RO |
| 13Ch–13Fh | OSD1BDPU | OSD1 Buffer Description List Pointer-Upper Base Address | 00000000h | R/W |
| 140h–142h | OSD2CTL | Output Stream Descriptor 2 (OSD2) Control | 040000h | R/W, RO |
| 143h | OSD2STS | OSD2 Status | 00h | R/WC, RO |
| 144h–147h | OSD2LPIB | OSD2 Link Position in Buffer | 00000000h | RO |
| 148h–14Bh | OSD2CBL | OSD2 Cyclic Buffer Length | 00000000h | R/W |
| 14Ch–14Dh | OSD2LVI | OSD2 Last Valid Index | 0000h | R/W |
| 14Eh–14Fh | OSD2FIFOW | OSD2 FIFO Watermark | 0004h | R/W |
| 150h–151h | OSD2FIFOS | OSD2 FIFO Size | 00BFh | R/W |
| 152h–153h | OSD2FMT | OSD2 Format | 0000h | R/W |
| 158h–15Bh | OSD2BDPL | OSD2 Buffer Descriptor List Pointer-Lower Base Address | 00000000h | R/W, RO |
| 15Ch–15Fh | OSD2BDPU | OSD2 Buffer Description List Pointer-Upper Base Address | 00000000h | R/W |
| 160h–162h | OSD3CTL | Output Stream Descriptor 3 (OSD3) Control | 040000h | R/W, RO |
| 163h | OSD3STS | OSD3 Status | 00h | R/WC, RO |
| 164h–167h | OSD3LPIB | OSD3 Link Position in Buffer | 00000000h | RO |
| 168h–16Bh | OSD3CBL | OSD3 Cyclic Buffer Length | 00000000h | R/W |
| 16Ch–16Dh | OSD3LVI | OSD3 Last Valid Index | 0000h | R/W |
| 16Eh–16Fh | OSD3FIFOW | OSD3 FIFO Watermark | 0004h | R/W |
| 170h–171h | OSD3FIFOS | OSD3 FIFO Size | 00BFh | R/W |
| 172h–173h | OSD3FMT | OSD3 Format | 0000h | R/W |
| 178h–17Bh | OSD3BDPL | OSD3 Buffer Descriptor List Pointer-Lower Base Address | 00000000h | R/W, RO |
| 17Ch–17Fh | OSD3BDPU | OSD3 Buffer Description List Pointer-Upper Base Address | 00000000h | R/W |



18.2.1 GCAP—Global Capabilities Register (Intel® High Definition Audio Controller—D27:F0)

Memory Address: HDBAR + 00h Attribute: RO
 Default Value: 4401h Size: 16 bits

| Bit | Description |
|-------|----------------------------------------------------------------------------------------------------------------------------------------------------------------------------------------------------------------------------|
| 15:12 | Number of Output Stream Supported — RO. Hardwired to 0100b indicating that the ICH10 Intel® High Definition Audio controller supports 4 output streams. |
| 11:8 | Number of Input Stream Supported — RO. Hardwired to 0100b indicating that the ICH10 Intel High Definition Audio controller supports 4 input streams. |
| 7:3 | Number of Bidirectional Stream Supported — RO. Hardwired to 0 indicating that the ICH10 Intel High Definition Audio controller supports 0 bidirectional stream. |
| 2 | Reserved. |
| 1 | Number of Serial Data Out Signals — RO. Hardwired to 0 indicating that the ICH10 Intel High Definition Audio controller supports 1 serial data output signal. |
| 0 | 64-bit Address Supported — RO. Hardwired to 1b indicating that the ICH10 Intel High Definition Audio controller supports 64-bit addressing for BDL addresses, data buffer addressees, and command buffer addresses. |

18.2.2 VMIN—Minor Version Register (Intel® High Definition Audio Controller—D27:F0)

Memory Address: HDBAR + 02h Attribute: RO
 Default Value: 00h Size: 8 bits

| Bit | Description |
|-----|------------------------------------------------------------------------------------------------------------------------------------------------------------------|
| 7:0 | Minor Version — RO. Hardwired to 0 indicating that the Intel® ICH10 supports minor revision number 00h of the Intel® High Definition Audio specification. |

18.2.3 VMAJ—Major Version Register (Intel® High Definition Audio Controller—D27:F0)

Memory Address: HDBAR + 03h Attribute: RO
 Default Value: 01h Size: 8 bits

| Bit | Description |
|-----|------------------------------------------------------------------------------------------------------------------------------------------------------------------|
| 7:0 | Major Version — RO. Hardwired to 01h indicating that the Intel® ICH10 supports major revision number 1 of the Intel® High Definition Audio specification. |



18.2.4 OUTPAY—Output Payload Capability Register (Intel® High Definition Audio Controller—D27:F0)

Memory Address: HDBAR + 04h Attribute: RO
Default Value: 003Ch Size: 16 bits

| Bit | Description |
|------|-----------------------------------------------------------------------------------------------------------------------------------------------------------------------------------------------------------------------------------------------------------------------------------------------------------------------------------------------------------------------------------------------------------------------------------------------------------------------------------------------------------------------------------------------------------------------------------|
| 15:7 | Reserved. |
| 6:0 | Output Payload Capability — RO. Hardwired to 3Ch indicating 60 word payload. This field indicates the total output payload available on the link. This does not include bandwidth used for command and control. This measurement is in 16-bit word quantities per 48 MHz frame. The default link clock of 24.000 MHz (the data is double pumped) provides 1000 bits per frame, or 62.5 words in total. 40 bits are used for command and control, leaving 60 words available for data payload. 00h = 0 word 01h = 1 word payload. FFh = 256 word payload. |

18.2.5 INPAY—Input Payload Capability Register (Intel® High Definition Audio Controller—D27:F0)

Memory Address: HDBAR + 06h Attribute: RO
Default Value: 001Dh Size: 16 bits

| Bit | Description |
|------|--------------------------------------------------------------------------------------------------------------------------------------------------------------------------------------------------------------------------------------------------------------------------------------------------------------------------------------------------------------------------------------------------------------------------------------------------------------------------------------------------------------------------------|
| 15:7 | Reserved. |
| 6:0 | Input Payload Capability — RO. Hardwired to 1Dh indicating 29 word payload. This field indicates the total output payload available on the link. This does not include bandwidth used for response. This measurement is in 16-bit word quantities per 48 MHz frame. The default link clock of 24.000 MHz provides 500 bits per frame, or 31.25 words in total. 36 bits are used for response, leaving 29 words available for data payload. 00h = 0 word 01h = 1 word payload. FFh = 256 word payload. |



18.2.6 GCTL—Global Control Register (Intel® High Definition Audio Controller—D27:F0)

Memory Address: HDBAR + 08h
Default Value: 0000000h

Attribute: R/W
Size: 32 bits

| Bit | Description |
|------|---------------------------------------------------------------------------------------------------------------------------------------------------------------------------------------------------------------------------------------------------------------------------------------------------------------------------------------------------------------------------------------------------------------------------------------------------------------------------------------------------------------------------------------------------------------------------------------------------------------------------------------------------------------------------------------------------------------------------------------------------------------------------------------------------------------------------------------------------------------------------------------------------------------------------------------------------------------------------------------------------------------------------------------------------------------------------------------------------------------------------------------------------------------------------------------------------------------------------------------------------------------------------------------------------------------------------------------------------------------------------------------------------------------------------------------------------------------------------------------------------------------------------------------------------------------------------------------------------------------------------------------------------------------------------------------------------------------------------------------------------------------------------------------------------------------------------------------------------------------------------------------------------------------------------------------------------------------------------------------------------------------------------------------------------------------------------------------------------------------------------------------------------------------------------------------------------------------------------------------------------------------------------------------------------------------------------------------------------------------|
| 31:9 | Reserved. |
| 8 | <p>Accept Unsolicited Response Enable — R/W.</p> <p>0 = Unsolicited responses from the codecs are not accepted. 1 = Unsolicited response from the codecs are accepted by the controller and placed into the Response Input Ring Buffer.</p> |
| 7:2 | Reserved. |
| 1 | <p>Flush Control — R/W. Writing a 1 to this bit initiates a flush. When the flush completion is received by the controller, hardware sets the Flush Status bit and clears this Flush Control bit. Before a flush cycle is initiated, the DMA Position Buffer must be programmed with a valid memory address by software, but the DMA Position Buffer bit 0 needs not be set to enable the position reporting mechanism. Also, all streams must be stopped (the associated RUN bit must be 0).</p> <p>When the flush is initiated, the controller will flush the pipelines to memory to ensure that the hardware is ready to transition to a D3 state. Setting this bit is not a critical step in the power state transition if the content of the FIFOs is not critical.</p> |
| 0 | <p>Controller Reset # — R/W.</p> <p>0 = Writing a 0 causes the Intel High Definition Audio controller to be reset. All state machines, FIFOs and non-resume well memory mapped configuration registers (not PCI configuration registers) in the controller will be reset. The Intel High Definition Audio link RESET# signal will be asserted, and all other link signals will be driven to their default values. After the hardware has completed sequencing into the reset state, it will report a 0 in this bit. Software must read a 0 from this bit to verify the controller is in reset.</p> <p>1 = Writing a 1 causes the controller to exit its reset state and deassert the Intel High Definition Audio link RESET# signal. Software is responsible for setting/clearing this bit such that the minimum Intel High Definition Audio link RESET# signal assertion pulse width specification is met. When the controller hardware is ready to begin operation, it will report a 1 in this bit. Software must read a 1 from this bit before accessing any controller registers. This bit defaults to a 0 after Hardware reset, therefore, software needs to write a 1 to this bit to begin operation.</p> <p>NOTES:</p> <ol style="list-style-type: none"> 1. The CORB/RIRB RUN bits and all stream RUN bits must be verified cleared to 0 before writing a 0 to this bit in order to assure a clean re-start. 2. When setting or clearing this bit, software must ensure that minimum link timing requirements (minimum RESET# assertion time, etc.) are met. 3. When this bit is 0 indicating that the controller is in reset, writes to all Intel High Definition Audio memory mapped registers are ignored as if the device is not present. The only exception is this register itself. The Global Control register is write-able as a DWord, Word, or Byte even when CRST# (this bit) is 0 if the byte enable for the byte containing the CRST# bit (Byte Enable 0) is active. If Byte Enable 0 is not active, writes to the Global Control register will be ignored when CRST# is 0. When CRST# is 0, reads to Intel High Definition Audio memory mapped registers will return their default value except for registers that are not reset with PLTRST# or on a D3_{HOT} to D0 transition. |



18.2.7 WAKEEN—Wake Enable Register (Intel® High Definition Audio Controller—D27:F0)

Memory Address: HDBAR + 0Ch Attribute: R/W
Default Value: 0000h Size: 16 bits
Function Level Reset: No

| Bit | Description |
|------|----------------------------------------------------------------------------------------------------------------------------------------------------------------------------------------------------------------------------------------------------------------------------------------------------------------------------------------------------------------------------------------------------------------------------------------------------------------------------------------------------------------------------------------|
| 15:4 | Reserved. |
| 3:0 | <p>SDIN Wake Enable Flags — R/W. These bits control which SDI signal(s) may generate a wake event. A 1b in the bit mask indicates that the associated SDIN signal is enabled to generate a wake.</p> <p>Bit 0 is used for SDI[0] Bit 1 is used for SDI[1] Bit 2 is used for SDI[2] Bit 3 is used for SDI[3]</p> <p>NOTE: These bits are in the resume well and only cleared on a power on reset. Software must not make assumptions about the reset state of these bits and must set them appropriately.</p> |

18.2.8 STATESTS—State Change Status Register (Intel® High Definition Audio Controller—D27:F0)

Memory Address: HDBAR + 0Eh Attribute: R/WC
Default Value: 0000h Size: 16 bits
Function Level Reset: No

| Bit | Description |
|------|----------------------------------------------------------------------------------------------------------------------------------------------------------------------------------------------------------------------------------------------------------------------------------------------------------------------------------------------------------------------------------------------------------------------------------------------------------------|
| 15:4 | Reserved. |
| 3:0 | <p>SDIN State Change Status Flags — R/WC. Flag bits that indicate which SDI signal(s) received a state change event. The bits are cleared by writing 1s to them.</p> <p>Bit 0 = SDI[0] Bit 1 = SDI[1] Bit 2 = SDI[2] Bit 3 = SDI[3]</p> <p>NOTE: These bits are in the resume well and only cleared on a power on reset. Software must not make assumptions about the reset state of these bits and must set them appropriately.</p> |



18.2.9 GSTS—Global Status Register (Intel® High Definition Audio Controller—D27:F0)

Memory Address: HDBAR + 10h Attribute: R/WC
 Default Value: 0000h Size: 16 bits

| Bit | Description |
|------|----------------------------------------------------------------------------------------------------------------------------------------------------------------------------------------------------------------------------------------------------------------------------------------------|
| 15:4 | Reserved. |
| 3 | Reserved |
| 2 | Reserved |
| 1 | Flush Status — R/WC. This bit is set to 1 by hardware to indicate that the flush cycle initiated when the Flush Control bit (HDBAR + 08h, bit 1) was set has completed. Software must write a 1 to clear this bit before the next time the Flush Control bit is set to clear the bit. |
| 0 | Reserved. |

18.2.10 OUTSTRMPAY—Output Stream Payload Capability (Intel® High Definition Audio Controller—D27:F0)

Memory Address: HDBAR + 18h Attribute: RO
 Default Value: 0030h Size: 16 bits

| Bit | Description |
|-------|-------------------------------------------------------------------------------------------------------------------------------------------------------------------------------------------------------------------------------------------------------------------------------------------------------------------------------------------------------------------------------------------------------------------------------------------------------------------------------------------------------------------------------------------------------------------------------------------------------------------------------------------------------------------------------------------------------------------------------------------------------------------------------------------------------------------------------------------------------------------------------------------------------------------------------------------------------------------------------------------------------------------------------------------|
| 15:14 | Output FIFO Padding Type (OPADTYPE) — RO: Indicates how the controller pads the samples in the controller's buffer (FIFO). Controllers may not pad at all or may pad to byte or memory container sizes. 0h = Controller pads all samples to bytes 1h = Reserved 2h = Controller pads to memory container size 3h = Controller does not pad and uses samples directly |
| 13:0 | Output Stream Payload Capability (OUTSTRMPAY) — RO: Indicates maximum number of words per frame for any single output stream. This measurement is in 16 bit word quantities per 48 kHz frame. 48 Words (96B) is the maximum supported, therefore a value of 30h is reported in this register. The value does not specify the number of words actually transmitted in the frame, but is the size of the data in the controller buffer (FIFO) after the samples are padded as specified by OPADTYPE. Thus to compute the supported streams, each sample is padded according to OPADTYPE and then multiplied by the number of channels and samples per frame. If this computed value is larger than OUTSTRMPAY then that stream is not supported. The value specified is not affected by striping. Software must ensure that a format which would cause more Words per frame than indicated is not programmed into the Output Stream Descriptor Register. The value may be larger than the OUTPAY register value in some cases. |



18.2.11 INSTRMPAY—Input Stream Payload Capability (Intel® High Definition Audio Controller—D27:F0)

Memory Address: HDBAR + 1Ah Attribute: RO
Default Value: 0018h Size: 16 bits

| Bit | Description |
|-------|----------------------------------------------------------------------------------------------------------------------------------------------------------------------------------------------------------------------------------------------------------------------------------------------------------------------------------------------------------------------------------------------------------------------------------------------------------------------------------------------------------------------------------------------------------------------------------------------------------------------------------------------------------------------------------------------------------------------------------------------------------------------------------------------------------------------------------------------------------------------------------------------------------------------------------------------------------------------------------------------------------------------------------------------------------------------------------------------------------------------------------------------------------------------------------------------------------------------------------|
| 15:14 | <p>Input FIFO Padding Type (IPADTYPE)— RO. Indicates how the controller pads the samples in the controller's buffer (FIFO). Controllers may not pad at all or may pad to byte or memory container sizes.</p> <p>0h = Controller pads all samples to bytes 1h = Reserved 2h = Controller pads to memory container size 3h = Controller does not pad and uses samples directly</p> |
| 13:0 | <p>Input Stream Payload Capability (INSTRMPAY)— RO. Indicates the maximum number of Words per frame for any single input stream. This measurement is in 16-bit Word quantities per 48-kHz frame. 24 Words (48B) is the maximum supported, therefore a value of 18h is reported in this register.</p> <p>The value does not specify the number of words actually transmitted in the frame, but is the size of the data as it will be placed into the controller's buffer (FIFO). Thus samples will be padded according to IPADTYPE before being stored into controller buffer. To compute the supported streams, each sample is padded according to IPADTYPE and then multiplied by the number of channels and samples per frame. If this computed value is larger than INSTRMPAY then that stream is not supported. As the inbound stream tag is not stored with the samples it is not included in the word count.</p> <p>The value may be larger than INPAY register value in some cases, although values less than INPAY may also be invalid due to overhead. Software must ensure that a format which would cause more Words per frame than indicated is not programmed into the Input Stream Descriptor Register.</p> |



18.2.12 INTCTL—Interrupt Control Register (Intel® High Definition Audio Controller—D27:F0)

Memory Address: HDBAR + 20h Attribute: R/W
 Default Value: 00000000h Size: 32 bits

| Bit | Description |
|------|----------------------------------------------------------------------------------------------------------------------------------------------------------------------------------------------------------------------------------------------------------------------------------------------------------------------------------------------------------------------------------------------------------------------------------------------------------------------------------------------------------------------------------------------------------------------------------------------------------------------------------------------------------------------------------------------------------------------------------------------------------------------------------------------------------------------------------------------------------------------------------------------------------------------------------------------|
| 31 | <p>Global Interrupt Enable (GIE) — R/W. Global bit to enable device interrupt generation.</p> <p>1 = When set to 1, the Intel® High Definition Audio function is enabled to generate an interrupt. This control is in addition to any bits in the bus specific address space, such as the Interrupt Enable bit in the PCI configuration space.</p> <p>NOTE: This bit is not affected by the D3_{HOT} to D0 transition.</p> |
| 30 | <p>Controller Interrupt Enable (CIE) — R/W. Enables the general interrupt for controller functions.</p> <p>1 = When set to 1, the controller generates an interrupt when the corresponding status bit gets set due to a Response Interrupt, a Response Buffer Overrun, and State Change events.</p> <p>NOTE: This bit is not affected by the D3_{HOT} to D0 transition.</p> |
| 29:8 | Reserved |
| 7:0 | <p>Stream Interrupt Enable (SIE) — R/W. When set to 1, the individual streams are enabled to generate an interrupt when the corresponding status bits get set. A stream interrupt will be caused as a result of a buffer with IOC = 1 in the BDL entry being completed, or as a result of a FIFO error (underrun or overrun) occurring. Control over the generation of each of these sources is in the associated Stream Descriptor. The streams are numbered and the SIE bits assigned sequentially, based on their order in the register set.</p> <p>Bit 0 = input stream 1 Bit 1 = input stream 2 Bit 2 = input stream 3 Bit 3 = input stream 4 Bit 4 = output stream 1 Bit 5 = output stream 2 Bit 6 = output stream 3 Bit 7 = output stream 4</p> |



18.2.13 INTSTS—Interrupt Status Register (Intel® High Definition Audio Controller—D27:F0)

Memory Address: HDBAR + 24h
Default Value: 00000000h

Attribute: RO
Size: 32 bits

| Bit | Description |
|------|---------------------------------------------------------------------------------------------------------------------------------------------------------------------------------------------------------------------------------------------------------------------------------------------------------------------------------------------------------------------------------------------------------------------------------------------------------------------------------------------------------------------------------------------------------------------------------------------------------------------------------------------------------------|
| 31 | Global Interrupt Status (GIS) — RO. This bit is an OR of all the interrupt status bits in this register. NOTE: This bit is not affected by the D3 _{HOT} to D0 transition. |
| 30 | Controller Interrupt Status (CIS) — RO. Status of general controller interrupt. 1 = Interrupt condition occurred due to a Response Interrupt, a Response Buffer Overrun Interrupt, or a SDIN State Change event. The exact cause can be determined by interrogating other registers. This bit is an OR of all of the stated interrupt status bits for this register. NOTES: 1. This bit is set regardless of the state of the corresponding interrupt enable bit, but a hardware interrupt will not be generated unless the corresponding enable bit is set. 2. This bit is not affected by the D3 _{HOT} to D0 transition. |
| 29:8 | Reserved |
| 7:0 | Stream Interrupt Status (SIS) — RO. 1 = Interrupt condition occurred on the corresponding stream. This bit is an OR of all of the stream's interrupt status bits. NOTE: These bits are set regardless of the state of the corresponding interrupt enable bits. The streams are numbered and the SIE bits assigned sequentially, based on their order in the register set. Bit 0 = input stream 1 Bit 1 = input stream 2 Bit 2 = input stream 3 Bit 3 = input stream 4 Bit 4 = output stream 1 Bit 5 = output stream 2 Bit 6 = output stream 3 Bit 7 = output stream 4 |

18.2.14 WALCLK—Wall Clock Counter Register (Intel® High Definition Audio Controller—D27:F0)

Memory Address: HDBAR + 30h
Default Value: 00000000h

Attribute: RO
Size: 32 bits

| Bit | Description |
|------|--------------------------------------------------------------------------------------------------------------------------------------------------------------------------------------------------------------------------------------------------------------------------------------------------------------------------------------------------------------------------------------------------------|
| 31:0 | Wall Clock Counter — RO. 32 bit counter that is incremented on each link Bit Clock period and rolls over from FFFF FFFFh to 0000 0000h. This counter will roll over to 0 with a period of approximately 179 seconds. This counter is enabled while the Bit Clock bit is set to 1. Software uses this counter to synchronize between multiple controllers. Will be reset on controller reset. |

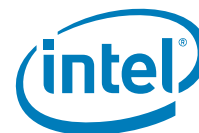

18.2.15 SSYNC—Stream Synchronization Register (Intel® High Definition Audio Controller—D27:F0)

Memory Address: HDBAR + 34h
Default Value: 00000000h

Attribute: R/W
Size: 32 bits

| Bit | Description |
|------|------------------------------------------------------------------------------------------------------------------------------------------------------------------------------------------------------------------------------------------------------------------------------------------------------------------------------------------------------------------------------------------------------------------------------------------------------------------------------------------------------------------------------------------------------------------------------------------------------------------------------------------------------------------------------------------------------------------------------------------------------------------------------------------------------------------------------------------------------------------------------------------------------------------------------------------------------------------------------------------------------------------------------------------------------------------------------------------------------------------------------------------------------------------------------------------------------------------------------------------------------------|
| 31:8 | Reserved |
| 7:0 | <p>Stream Synchronization (SSYNC) — R/W. When set to 1, these bits block data from being sent on or received from the link. Each bit controls the associated stream descriptor (i.e. bit 0 corresponds to the first stream descriptor, etc.)</p> <p>To synchronously start a set of DMA engines, these bits are first set to 1. The RUN bits for the associated stream descriptors are then set to 1 to start the DMA engines. When all streams are ready (FIFORDY = 1), the associated SSYNC bits can all be set to 0 at the same time, and transmission or reception of bits to or from the link will begin together at the start of the next full link frame.</p> <p>To synchronously stop the streams, first these bits are set, and then the individual RUN bits in the stream descriptor are cleared by software.</p> <p>If synchronization is not desired, these bits may be left as 0, and the stream will simply begin running normally when the stream's RUN bit is set.</p> <p>The streams are numbered and the SIE bits assigned sequentially, based on their order in the register set.</p> <p>Bit 0 = input stream 1 Bit 1 = input stream 2 Bit 2 = input stream 3 Bit 3 = input stream 4 Bit 4 = output stream 1</p> |

18.2.16 CORBLBASE—CORB Lower Base Address Register (Intel® High Definition Audio Controller—D27:F0)

Memory Address: HDBAR + 40h
Default Value: 00000000h

Attribute: R/W, RO
Size: 32 bits

| Bit | Description |
|------|--------------------------------------------------------------------------------------------------------------------------------------------------------------------------------------------------------------------------------------------------------------------------|
| 31:7 | CORB Lower Base Address — R/W. Lower address of the Command Output Ring Buffer, allowing the CORB base address to be assigned on any 128-B boundary. This register field must not be written when the DMA engine is running or the DMA transfer may be corrupted. |
| 6:0 | CORB Lower Base Unimplemented Bits — RO. Hardwired to 0. This required the CORB to be allocated with 128B granularity to allow for cache line fetch optimizations. |



18.2.17 CORBUBASE—CORB Upper Base Address Register (Intel® High Definition Audio Controller—D27:F0)

Memory Address: HDBAR + 44h Attribute: R/W
 Default Value: 00000000h Size: 32 bits

| Bit | Description |
|------|--------------------------------------------------------------------------------------------------------------------------------------------------------------------------------------------------------------------|
| 31:0 | CORB Upper Base Address — R/W. Upper 32 bits of the address of the Command Output Ring buffer. This register field must not be written when the DMA engine is running or the DMA transfer may be corrupted. |

18.2.18 CORBWP—CORB Write Pointer Register (Intel® High Definition Audio Controller—D27:F0)

Memory Address: HDBAR + 48h Attribute: R/W
 Default Value: 0000h Size: 16 bits

| Bit | Description |
|------|---------------------------------------------------------------------------------------------------------------------------------------------------------------------------------------------------------------------------------------------------------------------------------------------------------------------------------------|
| 15:8 | Reserved. |
| 7:0 | CORB Write Pointer — R/W. Software writes the last valid CORB entry offset into this field in dword granularity. The DMA engine fetches commands from the CORB until the Read pointer matches the Write pointer. Supports 256 CORB entries (256x4B = 1 KB). This register field may be written when the DMA engine is running. |

18.2.19 CORBRP—CORB Read Pointer Register (Intel® High Definition Audio Controller—D27:F0)

Memory Address: HDBAR + 4Ah Attribute: R/W, RO
 Default Value: 0000h Size: 16 bits

| Bit | Description |
|------|------------------------------------------------------------------------------------------------------------------------------------------------------------------------------------------------------------------------------------------------------------------------------------------------------------------------------------------------------------------------------------------------------------------------------------------------------------------------------------------------------------------------------------------------------------------------------------------------------------------------------|
| 15 | CORB Read Pointer Reset — R/W. Software writes a 1 to this bit to reset the CORB Read Pointer to 0 and clear any residual prefetched commands in the CORB hardware buffer within the Intel® High Definition Audio controller. The hardware will physically update this bit to 1 when the CORB Pointer reset is complete. Software must read a 1 to verify that the reset completed correctly. Software must clear this bit back to 0 and read back the 0 to verify that the clear completed correctly. The CORB DMA engine must be stopped prior to resetting the Read Pointer or else DMA transfer may be corrupted. |
| 14:8 | Reserved. |
| 7:0 | CORB Read Pointer (CORBRP) — RO. Software reads this field to determine how many commands it can write to the CORB without over-running. The value read indicates the CORB Read Pointer offset in Dword granularity. The offset entry read from this field has been successfully fetched by the DMA controller and may be over-written by software. Supports 256 CORB entries (256 x 4B=1KB). This field may be read while the DMA engine is running. |



18.2.20 CORBCTL—CORB Control Register (Intel® High Definition Audio Controller—D27:F0)

Memory Address: HDBAR + 4Ch Attribute: R/W
Default Value: 00h Size: 8 bits

| Bit | Description |
|-----|--------------------------------------------------------------------------------------------------------------------------------------------------------------------------------------------------------------------------------------------------------------------------------------------------------------------------------------------------|
| 7:2 | Reserved. |
| 1 | <p>Enable CORB DMA Engine — R/W.</p> <p>0 = DMA stop 1 = DMA run</p> <p>After software writes a 0 to this bit, the hardware may not stop immediately. The hardware will physically update the bit to 0 when the DMA engine is truly stopped. Software must read a 0 from this bit to verify that the DMA engine is truly stopped.</p> |
| 0 | <p>CORB Memory Error Interrupt Enable — R/W.</p> <p>If this bit is set the controller will generate an interrupt if the CMEI status bit (HDBAR + 4Dh: bit 0) is set.</p> |

18.2.21 CORBST—CORB Status Register (Intel® High Definition Audio Controller—D27:F0)

Memory Address: HDBAR + 4Dh Attribute: R/W
Default Value: 00h Size: 8 bits

| Bit | Description |
|-----|---------------------------------------------------------------------------------------------------------------------------------------------------------------------------------------------------------------------------------------------------------------------------------------------------------------------------------------------------------------------------------------------------------------------------------------------------------------------------------------------------------------------------------|
| 7:1 | Reserved. |
| 0 | <p>CORB Memory Error Indication (CMEI) — R/WC.</p> <p>1 = Controller detected an error in the path way between the controller and memory. This may be an ECC bit error or any other type of detectable data error which renders the command data fetched invalid.</p> <p>Software can clear this bit by writing a 1 to it. However, this type of error leaves the audio subsystem in an un-viable state and typically required a controller reset by writing a 0 to the Controller Reset # bit (HDBAR + 08h: bit 0).</p> |

18.2.22 CORBSIZE—CORB Size Register Intel® High Definition Audio Controller—D27:F0)

Memory Address: HDBAR + 4Eh Attribute: RO
Default Value: 42h Size: 8 bits

| Bit | Description |
|-----|--------------------------------------------------------------------------------------------------------------------------------------|
| 7:4 | CORB Size Capability — RO. Hardwired to 0100b indicating that the ICH10 only supports a CORB size of 256 CORB entries (1024B) |
| 3:2 | Reserved. |
| 1:0 | CORB Size — RO. Hardwired to 10b which sets the CORB size to 256 entries (1024B) |



18.2.23 RIRBLBASE—RIRB Lower Base Address Register (Intel® High Definition Audio Controller—D27:F0)

Memory Address: HDBAR + 50h Attribute: R/W, RO
 Default Value: 00000000h Size: 32 bits

| Bit | Description |
|------|--------------------------------------------------------------------------------------------------------------------------------------------------------------------------------------------------------------------------------------------------------------------------|
| 31:7 | CORB Lower Base Address — R/W. Lower address of the Response Input Ring Buffer, allowing the RIRB base address to be assigned on any 128-B boundary. This register field must not be written when the DMA engine is running or the DMA transfer may be corrupted. |
| 6:0 | RIRB Lower Base Unimplemented Bits — RO. Hardwired to 0. This required the RIRB to be allocated with 128-B granularity to allow for cache line fetch optimizations. |

18.2.24 RIRBUBASE—RIRB Upper Base Address Register (Intel® High Definition Audio Controller—D27:F0)

Memory Address: HDBAR + 54h Attribute: R/W
 Default Value: 00000000h Size: 32 bits

| Bit | Description |
|------|--------------------------------------------------------------------------------------------------------------------------------------------------------------------------------------------------------------------|
| 31:0 | RIRB Upper Base Address — R/W. Upper 32 bits of the address of the Response Input Ring Buffer. This register field must not be written when the DMA engine is running or the DMA transfer may be corrupted. |

18.2.25 RIRBWP—RIRB Write Pointer Register (Intel® High Definition Audio Controller—D27:F0)

Memory Address: HDBAR + 58h Attribute: R/W, RO
 Default Value: 0000h Size: 16 bits

| Bit | Description |
|------|------------------------------------------------------------------------------------------------------------------------------------------------------------------------------------------------------------------------------------------------------------------------------------------------------------------------------------------------------------------------------------------------------------------------------------------------------|
| 15 | RIRB Write Pointer Reset — R/W. Software writes a 1 to this bit to reset the RIRB Write Pointer to 0. The RIRB DMA engine must be stopped prior to resetting the Write Pointer or else DMA transfer may be corrupted. This bit is always read as 0. |
| 14:8 | Reserved. |
| 7:0 | RIRB Write Pointer (RIRBWP) — RO. Indicates the last valid RIRB entry written by the DMA controller. Software reads this field to determine how many responses it can read from the RIRB. The value read indicates the RIRB Write Pointer offset in 2 dword RIRB entry units (since each RIRB entry is 2 dwords long). Supports up to 256 RIRB entries (256 x 8 B = 2 KB). This register field may be written when the DMA engine is running. |



18.2.26 RINTCNT—Response Interrupt Count Register (Intel® High Definition Audio Controller—D27:F0)

Memory Address: HDBAR + 5Ah Attribute: R/W
Default Value: 0000h Size: 16 bits

| Bit | Description |
|------|-------------------------------------------------------------------------------------------------------------------------------------------------------------------------------------------------------------------------------------------------------------------------------------------------------------------------------------------------------------------------------------------------------------------------------------------------------------------------------------------------------------------------------------------------------------------------------------------------------------------------------------------|
| 15:8 | Reserved. |
| 7:0 | <p>N Response Interrupt Count — R/W. 0000 0001b = 1 response sent to RIRB 1111 1111b = 255 responses sent to RIRB 0000 0000b = 256 responses sent to RIRB</p> <p>The DMA engine should be stopped when changing this field or else an interrupt may be lost.</p> <p>Note that each response occupies 2 dwords in the RIRB. This is compared to the total number of responses that have been returned, as opposed to the number of frames in which there were responses. If more than one codecs responds in one frame, then the count is increased by the number of responses received in the frame.</p> |

18.2.27 RIRBCTL—RIRB Control Register (Intel® High Definition Audio Controller—D27:F0)

Memory Address: HDBAR + 5Ch Attribute: R/W
Default Value: 00h Size: 8 bits

| Bit | Description |
|-----|-----------------------------------------------------------------------------------------------------------------------------------------------------------------------------------------------------------------------------------------------------------------------------------------------------------------------------------------------|
| 7:3 | Reserved. |
| 2 | <p>Response Overrun Interrupt Control — R/W. If this bit is set, the hardware will generate an interrupt when the Response Overrun Interrupt Status bit (HDBAR + 5Dh: bit 2) is set.</p> |
| 1 | <p>Enable RIRB DMA Engine — R/W. 0 = DMA stop 1 = DMA run</p> <p>After software writes a 0 to this bit, the hardware may not stop immediately. The hardware will physically update the bit to 0 when the DMA engine is truly stopped. Software must read a 0 from this bit to verify that the DMA engine is truly stopped.</p> |
| 0 | <p>Response Interrupt Control — R/W. 0 = Disable Interrupt 1 = Generate an interrupt after N number of responses are sent to the RIRB buffer OR when an empty Response slot is encountered on all SDI[x] inputs (whichever occurs first). The N counter is reset when the interrupt is generated.</p> |



18.2.28 RIRBSTS—RIRB Status Register (Intel® High Definition Audio Controller—D27:F0)

Memory Address: HDBAR + 5Dh Attribute: R/WC
 Default Value: 00h Size: 8 bits

| Bit | Description |
|-----|--------------------------------------------------------------------------------------------------------------------------------------------------------------------------------------------------------------------------------------------------------------------------------------------------------------------------------------------------------------------------------------------------------------------------------------------------------------------------------------------------------------------------------------------------------------------------------------|
| 7:3 | Reserved. |
| 2 | <p>Response Overrun Interrupt Status — R/WC. 1 = Software sets this bit to 1 when the RIRB DMA engine is not able to write the incoming responses to memory before additional incoming responses overrun the internal FIFO. When the overrun occurs, the hardware will drop the responses which overrun the buffer. An interrupt may be generated if the Response Overrun Interrupt Control bit is set. Note that this status bit is set even if an interrupt is not enabled for this event. Software clears this bit by writing a 1 to it.</p> |
| 1 | Reserved. |
| 0 | <p>Response Interrupt — R/WC. 1 = Hardware sets this bit to 1 when an interrupt has been generated after N number of Responses are sent to the RIRB buffer OR when an empty Response slot is encountered on all SDI[x] inputs (whichever occurs first). Note that this status bit is set even if an interrupt is not enabled for this event. Software clears this bit by writing a 1 to it.</p> |

18.2.29 RIRBSIZE—RIRB Size Register (Intel® High Definition Audio Controller—D27:F0)

Memory Address: HDBAR + 5Eh Attribute: RO
 Default Value: 42h Size: 8 bits

| Bit | Description |
|-----|--------------------------------------------------------------------------------------------------------------------------------------|
| 7:4 | RIRB Size Capability — RO. Hardwired to 0100b indicating that the ICH10 only supports a RIRB size of 256 RIRB entries (2048B) |
| 3:2 | Reserved. |
| 1:0 | RIRB Size — RO. Hardwired to 10b which sets the CORB size to 256 entries (2048B) |

18.2.30 IC—Immediate Command Register (Intel® High Definition Audio Controller—D27:F0)

Memory Address: HDBAR + 60h Attribute: R/W
 Default Value: 00000000h Size: 32 bits

| Bit | Description |
|------|----------------------------------------------------------------------------------------------------------------------------------------------------------------------------------------------------------------------------------------------------------------------------------------------------------|
| 31:0 | <p>Immediate Command Write — R/W. The command to be sent to the codec via the Immediate Command mechanism is written to this register. The command stored in this register is sent out over the link during the next available frame after a 1 is written to the ICB bit (HDBAR + 68h: bit 0)</p> |



18.2.31 IR—Immediate Response Register (Intel® High Definition Audio Controller—D27:F0)

Memory Address: HDBAR + 64h Attribute: RO
 Default Value: 00000000h Size: 32 bits

| Bit | Description |
|------|---------------------------------------------------------------------------------------------------------------------------------------------------------------------------------------------------------------------------------------------------------------------------------------------------------------------------------------------------------------------------------------------|
| 31:0 | <p>Immediate Response Read (IRR) — RO. This register contains the response received from a codec resulting from a command sent via the Immediate Command mechanism.</p> <p>If multiple codecs responded in the same time, there is no assurance as to which response will be latched. Therefore, broadcast-type commands must not be issued via the Immediate Command mechanism.</p> |

18.2.32 IRS—Immediate Command Status Register (Intel® High Definition Audio Controller—D27:F0)

Memory Address: HDBAR + 68h Attribute: R/W, R/WC
 Default Value: 0000h Size: 16 bits

| Bit | Description |
|------|-----------------------------------------------------------------------------------------------------------------------------------------------------------------------------------------------------------------------------------------------------------------------------------------------------------------------------------------------------------------------------------------------------------------------------------------------------------------------------------------------------------------------------------------------------------------------------------------------------------------------------------------------------------------------------------------------------|
| 15:2 | Reserved. |
| 1 | <p>Immediate Result Valid (IRV) — R/WC.</p> <p>1 = Set to 1 by hardware when a new response is latched into the Immediate Response register (HDBAR + 64). This is a status flag indicating that software may read the response from the Immediate Response register.</p> <p>Software must clear this bit by writing a 1 to it before issuing a new command so that the software may determine when a new response has arrived.</p> |
| 0 | <p>Immediate Command Busy (ICB) — R/W. When this bit is read as 0, it indicates that a new command may be issued using the Immediate Command mechanism. When this bit transitions from a 0 to a 1 (via software writing a 1), the controller issues the command currently stored in the Immediate Command register to the codec over the link. When the corresponding response is latched into the Immediate Response register, the controller hardware sets the IRV flag and clears the ICB bit back to 0.</p> <p>NOTE: An Immediate Command must not be issued while the CORB/RIRB mechanism is operating, otherwise the responses conflict. This must be enforced by software.</p> |



18.2.33 DPLBASE—DMA Position Lower Base Address Register (Intel® High Definition Audio Controller—D27:F0)

Memory Address: HDBAR + 70h Attribute: R/W, RO
Default Value: 00000000h Size: 32 bits

| Bit | Description |
|------|-------------------------------------------------------------------------------------------------------------------------------------------------------------------------------------------------------------------------------------------------------------------------------------------------------------------------------------------------------------------|
| 31:7 | DMA Position Lower Base Address — R/W. Lower 32 bits of the DMA Position Buffer Base Address. This register field must not be written when any DMA engine is running or the DMA transfer may be corrupted. This same address is used by the Flush Control and must be programmed with a valid value before the Flush Control bit (HDBAR+08h:bit 1) is set. |
| 6:1 | DMA Position Lower Base Unimplemented bits — RO. Hardwired to 0 to force the 128-byte buffer alignment for cache line write optimizations. |
| 0 | DMA Position Buffer Enable — R/W. 1 = Controller will write the DMA positions of each of the DMA engines to the buffer in the main memory periodically (typically once per frame). Software can use this value to know what data in memory is valid data. |

18.2.34 DPUBASE—DMA Position Upper Base Address Register (Intel® High Definition Audio Controller—D27:F0)

Memory Address: HDBAR + 74h Attribute: R/W
Default Value: 00000000h Size: 32 bits

| Bit | Description |
|------|-------------------------------------------------------------------------------------------------------------------------------------------------------------------------------------------------------------------|
| 31:0 | DMA Position Upper Base Address — R/W. Upper 32 bits of the DMA Position Buffer Base Address. This register field must not be written when any DMA engine is running or the DMA transfer may be corrupted. |



18.2.35 SDCTL—Stream Descriptor Control Register (Intel® High Definition Audio Controller—D27:F0)

Memory Address: Input Stream[0]: HDBAR + 80h Attribute: R/W, RO
 Input Stream[1]: HDBAR + A0h
 Input Stream[2]: HDBAR + C0h
 Input Stream[3]: HDBAR + E0h
 Output Stream[0]: HDBAR + 100h
 Output Stream[1]: HDBAR + 120h
 Output Stream[2]: HDBAR + 140h
 Output Stream[3]: HDBAR + 160h
 Default Value: 040000h Size: 24 bits

| Bit | Description |
|-------|------------------------------------------------------------------------------------------------------------------------------------------------------------------------------------------------------------------------------------------------------------------------------------------------------------------------------------------------------------------------------------------------------------------------------------------------------------------------------------------------------------------------------------------------------------------------------------------------------------------------------------------------------------------------------------------------------------------------------------------------|
| 23:20 | <p>Stream Number — R/W. This value reflect the Tag associated with the data being transferred on the link.</p> <p>When data controlled by this descriptor is sent out over the link, it will have its stream number encoded on the SYNC signal.</p> <p>When an input stream is detected on any of the SDI signals that match this value, the data samples are loaded into FIFO associated with this descriptor.</p> <p>Note that while a single SDI input may contain data from more than one stream number, two different SDI inputs may not be configured with the same stream number.</p> <p>0000 = Reserved 0001 = Stream 1 1110 = Stream 14 1111 = Stream 15</p> |
| 19 | <p>Bidirectional Direction Control — RO. This bit is only meaningful for bidirectional streams; therefore, this bit is hardwired to 0.</p> |
| 18 | <p>Traffic Priority — RO. Hardwired to 1 indicating that all streams will use VC1 if it is enabled through the PCI Express* registers.</p> |
| 17:16 | <p>Stripe Control — RO. This bit is only meaningful for input streams; therefore, this bit is hardwired to 0.</p> |
| 15:5 | Reserved |
| 4 | <p>Descriptor Error Interrupt Enable — R/W.</p> <p>0 = Disable 1 = An interrupt is generated when the Descriptor Error Status bit is set.</p> |
| 3 | <p>FIFO Error Interrupt Enable — R/W. This bit controls whether the occurrence of a FIFO error (overrun for input or underrun for output) will cause an interrupt or not. If this bit is not set, bit 3 in the Status register will be set, but the interrupt will not occur. Either way, the samples will be dropped.</p> |
| 2 | <p>Interrupt on Completion Enable — R/W. This bit controls whether or not an interrupt occurs when a buffer completes with the IOC bit set in its descriptor. If this bit is not set, bit 2 in the Status register will be set, but the interrupt will not occur.</p> |



| Bit | Description |
|-----|-----------------------------------------------------------------------------------------------------------------------------------------------------------------------------------------------------------------------------------------------------------------------------------------------------------------------------------------------------------------------------------------------------------------------------------------------------------------------------------------------------------------------------------------------------------------------------------------------------------------------------------------------------------------------------------------------------------------------|
| 1 | <p>Stream Run (RUN) — R/W.</p> <p>0 = DMA engine associated with this input stream will be disabled. The hardware will report a 0 in this bit when the DMA engine is actually stopped. Software must read a 0 from this bit before modifying related control registers or restarting the DMA engine.</p> <p>1 = DMA engine associated with this input stream will be enabled to transfer data from the FIFO to the main memory. The SSYNC bit must also be cleared in order for the DMA engine to run. For output streams, the cadence generator is reset whenever the RUN bit is set.</p> |
| 0 | <p>Stream Reset (SRST) — R/W.</p> <p>0 = Writing a 0 causes the corresponding stream to exit reset. When the stream hardware is ready to begin operation, it will report a 0 in this bit. Software must read a 0 from this bit before accessing any of the stream registers.</p> <p>1 = Writing a 1 causes the corresponding stream to be reset. The Stream Descriptor registers (except the SRST bit itself) and FIFO's for the corresponding stream are reset. After the stream hardware has completed sequencing into the reset state, it will report a 1 in this bit. Software must read a 1 from this bit to verify that the stream is in reset. The RUN bit must be cleared before SRST is asserted.</p> |



18.2.37 SDLPIB—Stream Descriptor Link Position in Buffer Register (Intel® High Definition Audio Controller—D27:F0)

Memory Address: Input Stream[0]: HDBAR + 84h Attribute: RO
 Input Stream[1]: HDBAR + A4h
 Input Stream[2]: HDBAR + C4h
 Input Stream[3]: HDBAR + E4h
 Output Stream[0]: HDBAR + 104h
 Output Stream[1]: HDBAR + 124h
 Output Stream[2]: HDBAR + 144h
 Output Stream[3]: HDBAR + 164h

Default Value: 00000000h Size: 32 bits

| Bit | Description |
|------|----------------------------------------------------------------------------------------------------------------------------------------------------------------------------------------------------------------|
| 31:0 | Link Position in Buffer — RO. Indicates the number of bytes that have been received off the link. This register will count from 0 to the value in the Cyclic Buffer Length register and then wrap to 0. |

18.2.38 SDCBL—Stream Descriptor Cyclic Buffer Length Register (Intel® High Definition Audio Controller—D27:F0)

Memory Address: Input Stream[0]: HDBAR + 88h Attribute: R/W
 Input Stream[1]: HDBAR + A8h
 Input Stream[2]: HDBAR + C8h
 Input Stream[3]: HDBAR + E8h
 Output Stream[0]: HDBAR + 108h
 Output Stream[1]: HDBAR + 128h
 Output Stream[2]: HDBAR + 148h
 Output Stream[3]: HDBAR + 168h

Default Value: 00000000h Size: 32 bits

| Bit | Description |
|------|-----------------------------------------------------------------------------------------------------------------------------------------------------------------------------------------------------------------------------------------------------------------------------------------------------------------------------------------------------------------------------------------------------------------------------------------------------------------------------------------------------------------------------------------------------------------------|
| 31:0 | Cyclic Buffer Length — R/W. Indicates the number of bytes in the complete cyclic buffer. This register represents an integer number of samples. Link Position in Buffer will be reset when it reaches this value. Software may only write to this register after Global Reset, Controller Reset, or Stream Reset has occurred. This value should be only modified when the RUN bit is 0. Once the RUN bit has been set to enable the engine, software must not write to this register until after the next reset is asserted, or transfer may be corrupted. |



18.2.39 SDLVI—Stream Descriptor Last Valid Index Register (Intel® High Definition Audio Controller—D27:F0)

Memory Address: Input Stream[0]: HDBAR + 8Ch Attribute: R/W
 Input Stream[1]: HDBAR + ACh
 Input Stream[2]: HDBAR + CCh
 Input Stream[3]: HDBAR + ECh
 Output Stream[0]: HDBAR + 10Ch
 Output Stream[1]: HDBAR + 12Ch
 Output Stream[2]: HDBAR + 14Ch
 Output Stream[3]: HDBAR + 16Ch

Default Value: 0000h Size: 16 bits

| Bit | Description |
|------|---------------------------------------------------------------------------------------------------------------------------------------------------------------------------------------------------------------------------------------------------------------------------------------------------------------------------------------------------------------------------------------------------------------------------------------------------------------------------------------------|
| 15:8 | Reserved. |
| 7:0 | <p>Last Valid Index — R/W. The value written to this register indicates the index for the last valid Buffer Descriptor in BDL. After the controller has processed this descriptor, it will wrap back to the first descriptor in the list and continue processing.</p> <p>This field must be at least 1, i.e. there must be at least 2 valid entries in the buffer descriptor list before DMA operations can begin.</p> <p>This value should only modified when the RUN bit is 0.</p> |

18.2.40 SDFIFOW—Stream Descriptor FIFO Watermark Register (Intel® High Definition Audio Controller—D27:F0)

Memory Address: Input Stream[0]: HDBAR + 8Eh Attribute: R/W
 Input Stream[1]: HDBAR + AEh
 Input Stream[2]: HDBAR + CEh
 Input Stream[3]: HDBAR + EEh
 Output Stream[0]: HDBAR + 10Eh
 Output Stream[1]: HDBAR + 12Eh
 Output Stream[2]: HDBAR + 14Eh
 Output Stream[3]: HDBAR + 16Eh

Default Value: 0004h Size: 16 bits

| Bit | Description |
|------|-------------------------------------------------------------------------------------------------------------------------------------------------------------------------------------------------------------------------------------------------------------------------------------------------------------------------------------------------------------------------------------------------------------------------------------------------------------------------------------------------------------------------------------------------------|
| 15:3 | Reserved. |
| 2:0 | <p>FIFO Watermark (FIFOW) — R/W. Indicates the minimum number of bytes accumulated/free in the FIFO before the controller will start a fetch/eviction of data.</p> <p>010 = 8B 011 = 16B 100 = 32B (Default) 101 = 64B Others = Unsupported</p> <p>NOTE: When the bit field is programmed to an unsupported size, the hardware sets itself to the default value.</p> <p>Software must read the bit field to test if the value is supported after setting the bit field.</p> |

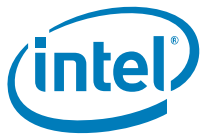

18.2.41 SDFIFOS—Stream Descriptor FIFO Size Register (Intel® High Definition Audio Controller—D27:F0)

Memory Address: Input Stream[0]: HDBAR + 90h Attribute: Input: RO
 Input Stream[1]: HDBAR + B0h Output: R/W
 Input Stream[2]: HDBAR + D0h
 Input Stream[3]: HDBAR + F0h
 Output Stream[0]: HDBAR + 110h
 Output Stream[1]: HDBAR + 130h
 Output Stream[2]: HDBAR + 150h
 Output Stream[3]: HDBAR + 170h

Default Value: Input Stream: 0077h Size: 16 bits
 Output Stream: See Description.

| Bit | Description | | | | | | | | | | | | | | | | | | | | | | | | |
|-------------|-------------------------------------------------------------------------------------------------------------------------------------------------------------------------------------------------------------------------------------------------------------------------------------------------------------------------------------------------------------------------------------------------------------------------------------------------------------------------------------------------------------------------------------------------------------------------------------------------------------------------------------------------------------------------------------------------------------------------------------------------------------------------------------------------------------------------------------------------------------------------------------------------------------------------------------------------------------------------------------------------------------------------------------------------------------------------------------------------------------------------------------------------------------------------------------------------------------------------------------------------------------------------------------------------------------------------------------------------------------------------------------------------------------------------------------------------------------------------------------------------------------------------------------------------------------------------------------------------------------------------------------------------------------------------------------------------------------------------------------------------------------------------------------------------------------------------------------------------------------------------------------------------------------------------------------------------------------------------------------------------------------------------------------------------------------------------------------------------------------------------------------------------------------------------------------------------------------------------------------------------------------------------------------------------------------------------------------|-------|----------------|-----------|-----------------------------------------|-----------|-----------------------------------------|-----------|-----------------------------------------|------------|-----------------------------------------|------------|-------------------------------------------|------------|---------------------------------------|-------------|---------------------------------|-------------|-----------------------------|-------|---------------|------------|-----------------------------|------------|--------------------------|
| 15:10 | Reserved. | | | | | | | | | | | | | | | | | | | | | | | | |
| 9:0 | <p>FIFO Size — RO (Input stream), R/W (Output stream). Indicates the maximum number of bytes that could be fetched by the controller at one time. This is the maximum number of bytes that may have been DMA'd into memory but not yet transmitted on the link, and is also the maximum possible value that the PICB count will increase by at one time.</p> <p>The value in this field is different for input and output streams. It is also dependent on the Bits per Samples setting for the corresponding stream. Following are the values read/written from/to this register for input and output streams, and for non-padded and padded bit formats:</p> <p><i>Output Stream R/W value:</i></p> <table border="0"> <thead> <tr> <th>Value</th> <th>Output Streams</th> </tr> </thead> <tbody> <tr> <td>0Fh = 16B</td> <td>8, 16, 20, 24, or 32 bit Output Streams</td> </tr> <tr> <td>1Fh = 32B</td> <td>8, 16, 20, 24, or 32 bit Output Streams</td> </tr> <tr> <td>3Fh = 64B</td> <td>8, 16, 20, 24, or 32 bit Output Streams</td> </tr> <tr> <td>7Fh = 128B</td> <td>8, 16, 20, 24, or 32 bit Output Streams</td> </tr> <tr> <td>BFh = 192B</td> <td>8, 16, or 32 bit Output Streams (Default)</td> </tr> <tr> <td>FFh = 256B</td> <td>20 or 24 bit Output Streams (Default)</td> </tr> <tr> <td>17Fh = 384B</td> <td>8, 16, or 32 bit Output Streams</td> </tr> <tr> <td>1FFh = 512B</td> <td>20 or 24 bit Output Streams</td> </tr> </tbody> </table> <p>NOTES:</p> <ol style="list-style-type: none"> All other values not listed are not supported. When the output stream is programmed to an unsupported size, the hardware sets itself to the default value (BFh). Software must read the bit field to test if the value is supported after setting the bit field. <p><i>Input Stream RO value:</i></p> <table border="0"> <thead> <tr> <th>Value</th> <th>Input Streams</th> </tr> </thead> <tbody> <tr> <td>77h = 120B</td> <td>8, 16, 32 bit Input Streams</td> </tr> <tr> <td>9Fh = 160B</td> <td>20, 24 bit Input Streams</td> </tr> </tbody> </table> <p>NOTE: The default value is different for input and output streams, and reflects the default state of the BITS fields (in Stream Descriptor Format registers) for the corresponding stream.</p> | Value | Output Streams | 0Fh = 16B | 8, 16, 20, 24, or 32 bit Output Streams | 1Fh = 32B | 8, 16, 20, 24, or 32 bit Output Streams | 3Fh = 64B | 8, 16, 20, 24, or 32 bit Output Streams | 7Fh = 128B | 8, 16, 20, 24, or 32 bit Output Streams | BFh = 192B | 8, 16, or 32 bit Output Streams (Default) | FFh = 256B | 20 or 24 bit Output Streams (Default) | 17Fh = 384B | 8, 16, or 32 bit Output Streams | 1FFh = 512B | 20 or 24 bit Output Streams | Value | Input Streams | 77h = 120B | 8, 16, 32 bit Input Streams | 9Fh = 160B | 20, 24 bit Input Streams |
| Value | Output Streams | | | | | | | | | | | | | | | | | | | | | | | | |
| 0Fh = 16B | 8, 16, 20, 24, or 32 bit Output Streams | | | | | | | | | | | | | | | | | | | | | | | | |
| 1Fh = 32B | 8, 16, 20, 24, or 32 bit Output Streams | | | | | | | | | | | | | | | | | | | | | | | | |
| 3Fh = 64B | 8, 16, 20, 24, or 32 bit Output Streams | | | | | | | | | | | | | | | | | | | | | | | | |
| 7Fh = 128B | 8, 16, 20, 24, or 32 bit Output Streams | | | | | | | | | | | | | | | | | | | | | | | | |
| BFh = 192B | 8, 16, or 32 bit Output Streams (Default) | | | | | | | | | | | | | | | | | | | | | | | | |
| FFh = 256B | 20 or 24 bit Output Streams (Default) | | | | | | | | | | | | | | | | | | | | | | | | |
| 17Fh = 384B | 8, 16, or 32 bit Output Streams | | | | | | | | | | | | | | | | | | | | | | | | |
| 1FFh = 512B | 20 or 24 bit Output Streams | | | | | | | | | | | | | | | | | | | | | | | | |
| Value | Input Streams | | | | | | | | | | | | | | | | | | | | | | | | |
| 77h = 120B | 8, 16, 32 bit Input Streams | | | | | | | | | | | | | | | | | | | | | | | | |
| 9Fh = 160B | 20, 24 bit Input Streams | | | | | | | | | | | | | | | | | | | | | | | | |



18.2.42 SDFMT—Stream Descriptor Format Register (Intel® High Definition Audio Controller—D27:F0)

Memory Address: Input Stream[0]: HDBAR + 92h Attribute: R/W
 Input Stream[1]: HDBAR + B2h
 Input Stream[2]: HDBAR + D2h
 Input Stream[3]: HDBAR + F2h
 Output Stream[0]: HDBAR + 112h
 Output Stream[1]: HDBAR + 132h
 Output Stream[2]: HDBAR + 152h
 Output Stream[3]: HDBAR + 172h

Default Value: 0000h

Size: 16 bits

| Bit | Description |
|-------|------------------------------------------------------------------------------------------------------------------------------------------------------------------------------------------------------------------------------------------------------------------------------------------------------------------------------------------------------------------------------------------------------------------------------------------------------------------------------------------------------------------------------------------------|
| 15 | Reserved. |
| 14 | Sample Base Rate — R/W 0 = 48 kHz 1 = 44.1 kHz |
| 13:11 | Sample Base Rate Multiple — R/W 000 = 48 kHz, 44.1 kHz or less 001 = x2 (96 kHz, 88.2 kHz, 32 kHz) 010 = x3 (144 kHz) 011 = x4 (192 kHz, 176.4 kHz) Others = Reserved. |
| 10:8 | Sample Base Rate Divisor — R/W. 000 = Divide by 1 (48 kHz, 44.1 kHz) 001 = Divide by 2 (24 kHz, 22.05 kHz) 010 = Divide by 3 (16 kHz, 32 kHz) 011 = Divide by 4 (11.025 kHz) 100 = Divide by 5 (9.6 kHz) 101 = Divide by 6 (8 kHz) 110 = Divide by 7 111 = Divide by 8 (6 kHz) |
| 7 | Reserved. |
| 6:4 | Bits per Sample (BITS) — R/W. 000 = 8 bits. The data will be packed in memory in 8-bit containers on 16-bit boundaries 001 = 16 bits. The data will be packed in memory in 16-bit containers on 16-bit boundaries 010 = 20 bits. The data will be packed in memory in 32-bit containers on 32-bit boundaries 011 = 24 bits. The data will be packed in memory in 32-bit containers on 32-bit boundaries 100 = 32 bits. The data will be packed in memory in 32-bit containers on 32-bit boundaries Others = Reserved. |
| 3:0 | Number of Channels (CHAN) — R/W. Indicates number of channels in each frame of the stream. 0000 = 1 0001 = 2 1111 = 16 |



18.2.43 SDBDPL—Stream Descriptor Buffer Descriptor List Pointer Lower Base Address Register (Intel® High Definition Audio Controller—D27:F0)

Memory Address: Input Stream[0]: HDBAR + 98h Attribute: R/W,RO
 Input Stream[1]: HDBAR + B8h
 Input Stream[2]: HDBAR + D8h
 Input Stream[3]: HDBAR + F8h
 Output Stream[0]: HDBAR + 118h
 Output Stream[1]: HDBAR + 138h
 Output Stream[2]: HDBAR + 158h
 Output Stream[3]: HDBAR + 178h

Default Value: 00000000h Size: 32 bits

| Bit | Description |
|------|----------------------------------------------------------------------------------------------------------------------------------------------------------------------------------------------------------|
| 31:7 | Buffer Descriptor List Pointer Lower Base Address — R/W. Lower address of the Buffer Descriptor List. This value should only be modified when the RUN bit is 0, or DMA transfer may be corrupted. |
| 6:0 | Hardwired to 0 forcing alignment on 128-B boundaries. |

18.2.44 SBDPU—Stream Descriptor Buffer Descriptor List Pointer Upper Base Address Register (Intel® High Definition Audio Controller—D27:F0)

Memory Address: Input Stream[0]: HDBAR + 9Ch Attribute: R/W
 Input Stream[1]: HDBAR + BCh
 Input Stream[2]: HDBAR + DCh
 Input Stream[3]: HDBAR + FCh
 Output Stream[0]: HDBAR + 11Ch
 Output Stream[1]: HDBAR + 13Ch
 Output Stream[2]: HDBAR + 15Ch
 Output Stream[3]: HDBAR + 17Ch

Default Value: 00000000h Size: 32 bits

| Bit | Description |
|------|-----------------------------------------------------------------------------------------------------------------------------------------------------------------------------------------------------------------|
| 31:0 | Buffer Descriptor List Pointer Upper Base Address — R/W. Upper 32-bit address of the Buffer Descriptor List. This value should only be modified when the RUN bit is 0, or DMA transfer may be corrupted. |

§ §

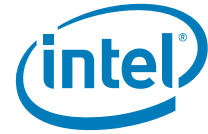

19 SMBus Controller Registers (D31:F3)

19.1 PCI Configuration Registers (SMBus—D31:F3)

Table 19-1. SMBus Controller PCI Register Address Map (SMBus—D31:F3)

| Offset | Mnemonic | Register Name | Default | Type |
|---------|----------|---------------------------------------------|--------------------------|---------|
| 00h–01h | VID | Vendor Identification | 8086 | RO |
| 02h–03h | DID | Device Identification | See register description | RO |
| 04h–05h | PCICMD | PCI Command | 0000h | R/W, RO |
| 06h–07h | PCISTS | PCI Status | 0280h | RO |
| 08h | RID | Revision Identification | See register description | RO |
| 09h | PI | Programming Interface | 00h | RO |
| 0Ah | SCC | Sub Class Code | 05h | RO |
| 0Bh | BCC | Base Class Code | 0Ch | RO |
| 10h | SMBMBAR0 | Memory Base Address Register 0 (Bit 31:0) | 00000004h | R/W |
| 14h | SMBMBAR1 | Memory Based Address Register 1 (Bit 63:32) | 00000000h | R/W |
| 20h–23h | SMB_BASE | SMBus Base Address | 00000001h | R/W, RO |
| 2Ch–2Dh | SVID | Subsystem Vendor Identification | 0000h | RO |
| 2Eh–2Fh | SID | Subsystem Identification | 0000h | R/WO |
| 3Ch | INT_LN | Interrupt Line | 00h | R/W |
| 3Dh | INT_PN | Interrupt Pin | See register description | RO |
| 40h | HOSTC | Host Configuration | 00h | R/W |

NOTE: Registers that are not shown should be treated as Reserved (See Section 9.2 for details).

19.1.1 VID—Vendor Identification Register (SMBus—D31:F3)

Address: 00h–01h
Default Value: 8086h

Attribute: RO
Size: 16 bits

| Bit | Description |
|------|-----------------------------------------------------------------|
| 15:0 | Vendor ID — RO. This is a 16-bit value assigned to Intel |



19.1.2 DID—Device Identification Register (SMBus—D31:F3)

Address: 02h–03h Attribute: RO
Default Value: See bit description Size: 16 bits

| Bit | Description |
|------|-------------------------------------------------------------------------------------------------------------------------------------------------------------------------------------------------------------------------|
| 15:0 | Device ID — RO. This is a 16-bit value assigned to the Intel® ICH10 SMBus controller. Refer to the <i>Intel® I/O Controller Hub (ICH10) Family Specification Update</i> for the value of the Device ID Register. |

19.1.3 PCICMD—PCI Command Register (SMBus—D31:F3)

Address: 04h–05h Attributes: RO, R/W
Default Value: 0000h Size: 16 bits

| Bit | Description |
|-------|------------------------------------------------------------------------------------------------------------------------------------------------------|
| 15:11 | Reserved |
| 10 | Interrupt Disable — R/W. 0 = Enable 1 = Disables SMBus to assert its PIRQB# signal. |
| 9 | Fast Back to Back Enable (FBE) — RO. Hardwired to 0. |
| 8 | SERR# Enable (SERR_EN) — R/W. 0 = Enables SERR# generation. 1 = Disables SERR# generation. |
| 7 | Wait Cycle Control (WCC) — RO. Hardwired to 0. |
| 6 | Parity Error Response (PER) — R/W. 0 = Disable 1 = Sets Detected Parity Error bit (D31:F3:06, bit 15) when a parity error is detected. |
| 5 | VGA Palette Snoop (VPS) — RO. Hardwired to 0. |
| 4 | Postable Memory Write Enable (PMWE) — RO. Hardwired to 0. |
| 3 | Special Cycle Enable (SCE) — RO. Hardwired to 0. |
| 2 | Bus Master Enable (BME) — RO. Hardwired to 0. |
| 1 | Memory Space Enable (MSE) — R/W. 0 = Disables memory mapped config space. 1 = Enables memory mapped config space. |
| 0 | I/O Space Enable (IOSE) — R/W. 0 = Disable 1 = Enables access to the SMBus I/O space registers as defined by the Base Address Register. |

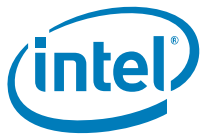

19.1.13 SID—Subsystem Identification Register (SMBus—D31:F2/F4)

Address Offset: 2Eh–2Fh Attribute: R/WO
Default Value: 0000h Size: 16 bits
Lockable: No Power Well: Core

| Bit | Description |
|------|----------------------------------------------------------------------------------------------------------------------------------------------------------------------------------------------------------------------------------------------------------------------------------------------------------------------------------------------------------------------------------------------------------------------------------|
| 15:0 | Subsystem ID (SID) — R/WO. The SID register, in combination with the SVID register, enables the operating system (OS) to distinguish subsystems from each other. The value returned by reads to this register is the same as that which was written by BIOS into the IDE SID register. NOTE: Software can write to this register only once per core well reset. Writes should be done as a single 16-bit cycle. |

19.1.14 INT_LN—Interrupt Line Register (SMBus—D31:F3)

Address Offset: 3Ch Attributes: R/W
Default Value: 00h Size: 8 bits

| Bit | Description |
|-----|------------------------------------------------------------------------------------------------------------------------------------------------------------------------------|
| 7:0 | Interrupt Line (INT_LN) — R/W. This data is not used by the ICH10. It is to communicate to software the interrupt line that the interrupt pin is connected to PIRQB#. |

19.1.15 INT_PN—Interrupt Pin Register (SMBus—D31:F3)

Address Offset: 3Dh Attributes: RO
Default Value: See description Size: 8 bits

| Bit | Description |
|-----|-----------------------------------------------------------------------------------------------------------|
| 7:0 | Interrupt PIN (INT_PN) — RO. This reflects the value of D31IP.SMIP in chipset configuration space. |



19.2 SMBus I/O and Memory Mapped I/O Registers

The following SMBus registers can be accessed through I/O BAR or Memory BAR registers in PCI configuration space. The offsets are the same for both I/O and Memory Mapped I/O registers.

Table 19-2. SMBus I/O and Memory Mapped I/O Register Address Map

| SMB_BASE + Offset | Mnemonic | Register Name | Default | Type |
|-------------------|----------------|------------------------------------------|--------------------------|----------|
| 00h | HST_STS | Host Status | 00h | R/WC, RO |
| 02h | HST_CNT | Host Control | 00h | R/W, WO |
| 03h | HST_CMD | Host Command | 00h | R/W |
| 04h | XMIT_SLVA | Transmit Slave Address | 00h | R/W |
| 05h | HST_D0 | Host Data 0 | 00h | R/W |
| 06h | HST_D1 | Host Data 1 | 00h | R/W |
| 07h | HOST_BLOCK_DB | Host Block Data Byte | 00h | R/W |
| 08h | PEC | Packet Error Check | 00h | R/W |
| 09h | RCV_SLVA | Receive Slave Address | 44h | R/W |
| 0Ah–0Bh | SLV_DATA | Receive Slave Data | 0000h | RO |
| 0Ch | AUX_STS | Auxiliary Status | 00h | R/WC, RO |
| 0Dh | AUX_CTL | Auxiliary Control | 00h | R/W |
| 0Eh | SMLINK_PIN_CTL | SMLink Pin Control (TCO Compatible Mode) | See register description | R/W, RO |
| 0Fh | SMBus_PIN_CTL | SMBus Pin Control | See register description | R/W, RO |
| 10h | SLV_STS | Slave Status | 00h | R/WC |
| 11h | SLV_CMD | Slave Command | 00h | R/W |
| 14h | NOTIFY_DADDR | Notify Device Address | 00h | RO |
| 16h | NOTIFY_DLOW | Notify Data Low Byte | 00h | RO |
| 17h | NOTIFY_DHIGH | Notify Data High Byte | 00h | RO |



19.2.1 HST_STS—Host Status Register (SMBus—D31:F3)

Register Offset: SMBASE + 00h Attribute: R/WC, RO
 Default Value: 00h Size: 8-bits

All status bits are set by hardware and cleared by the software writing a one to the particular bit position. Writing a 0 to any bit position has no effect.

| Bit | Description |
|-----|-------------------------------------------------------------------------------------------------------------------------------------------------------------------------------------------------------------------------------------------------------------------------------------------------------------------------------------------------------------------------------------------------------------------------------------------------------------------------------------------------------------------------------------------------------------------------------------------------------------------------------------------------------------------------------------------------------------------------------------------------------------------------------------------------------------------------------------------------------------------------------------------------------------------------------------------------------------------------------------------------------------------------------------------------------------------------------------------------------------------------------------------------------------------------------------------------------------------------------------------------------------------------------------------------------------------------------|
| 7 | <p>Byte Done Status (DS) — R/WC. 0 = Software can clear this by writing a 1 to it. 1 = Host controller received a byte (for Block Read commands) or if it has completed transmission of a byte (for Block Write commands) when the 32-byte buffer is not being used. Note that this bit will be set, even on the last byte of the transfer. This bit is not set when transmission is due to the LAN interface heartbeat. This bit has no meaning for block transfers when the 32-byte buffer is enabled.</p> <p>NOTE: When the last byte of a block message is received, the host controller will set this bit. However, it will not immediately set the INTR bit (bit 1 in this register). When the interrupt handler clears the DS bit, the message is considered complete, and the host controller will then set the INTR bit (and generate another interrupt). Thus, for a block message of n bytes, the ICH10 will generate n+1 interrupts. The interrupt handler needs to be implemented to handle these cases. When not using the 32 Byte Buffer, hardware will drive the SMBCLK signal low when the DS bit is set until SW clears the bit. This includes the last byte of a transfer. Software must clear the DS bit before it can clear the BUSY bit.</p> |
| 6 | <p>INUSE_STS — R/W. This bit is used as semaphore among various independent software threads that may need to use the ICH10's SMBus logic, and has no other effect on hardware. 0 = After a full PCI reset, a read to this bit returns a 0. 1 = After the first read, subsequent reads will return a 1. A write of a 1 to this bit will reset the next read value to 0. Writing a 0 to this bit has no effect. Software can poll this bit until it reads a 0, and will then own the usage of the host controller.</p> |
| 5 | <p>SMBALERT_STS — R/WC. 0 = Interrupt or SMI# was not generated by SMBALERT#. Software clears this bit by writing a 1 to it. 1 = The source of the interrupt or SMI# was the SMBALERT# signal. This bit is only cleared by software writing a 1 to the bit position or by RSMRST# going low. If the signal is programmed as a GPIO, then this bit will never be set.</p> |
| 4 | <p>FAILED — R/WC. 0 = Software clears this bit by writing a 1 to it. 1 = The source of the interrupt or SMI# was a failed bus transaction. This bit is set in response to the KILL bit being set to terminate the host transaction.</p> |
| 3 | <p>BUS_ERR — R/WC. 0 = Software clears this bit by writing a 1 to it. 1 = The source of the interrupt of SMI# was a transaction collision.</p> |
| 2 | <p>DEV_ERR — R/WC. 0 = Software clears this bit by writing a 1 to it. The ICH10 will then deassert the interrupt or SMI#. 1 = The source of the interrupt or SMI# was due to one of the following:</p> <ul style="list-style-type: none"> • Invalid Command Field, • Unclaimed Cycle (host initiated), • Host Device Time-out Error. |



| Bit | Description |
|-----|-----------------------------------------------------------------------------------------------------------------------------------------------------------------------------------------------------------------------------------------------------------------------------------------------------------------------------------------------------------------------------------------------------------------------------------------------------------------------------------------------------------------------------------------------------------------------------------------------------------------------------------------------|
| 1 | <p>INTR — R/WC. This bit can only be set by termination of a command. INTR is not dependent on the INTREN bit (offset SMBASE + 02h, bit 0) of the Host controller register (offset 02h). It is only dependent on the termination of the command. If the INTREN bit is not set, then the INTR bit will be set, although the interrupt will not be generated. Software can poll the INTR bit in this non-interrupt case.</p> <p>0 = Software clears this bit by writing a 1 to it. The ICH10 then deasserts the interrupt or SMI#.</p> <p>1 = The source of the interrupt or SMI# was the successful completion of its last command.</p> |
| 0 | <p>HOST_BUSY — R/WC.</p> <p>0 = Cleared by the ICH10 when the current transaction is completed.</p> <p>1 = Indicates that the ICH10 is running a command from the host interface. No SMB registers should be accessed while this bit is set, except the BLOCK DATA BYTE Register. The BLOCK DATA BYTE Register can be accessed when this bit is set only when the SMB_CMD bits in the Host Control Register are programmed for Block command or I²C Read command. This is necessary in order to check the DONE_STS bit.</p> |

19.2.2 HST_CNT—Host Control Register (SMBus—D31:F3)

Register Offset: SMBASE + 02h Attribute: R/W, WO
 Default Value: 00h Size: 8-bits

Note: A read to this register will clear the byte pointer of the 32-byte buffer.

| Bit | Description |
|-----|---------------------------------------------------------------------------------------------------------------------------------------------------------------------------------------------------------------------------------------------------------------------------------------------------------------------------------------------------------------------------------------------------------------------------------------------------------------------------------------------------------------------------------------------------------------------------------------------------------------------------------------------|
| 7 | <p>PEC_EN. — R/W.</p> <p>0 = SMBus host controller does not perform the transaction with the PEC phase appended.</p> <p>1 = Causes the host controller to perform the SMBus transaction with the Packet Error Checking phase appended. For writes, the value of the PEC byte is transferred from the PEC Register. For reads, the PEC byte is loaded in to the PEC Register. This bit must be written prior to the write in which the START bit is set.</p> |
| 6 | <p>START — WO.</p> <p>0 = This bit will always return 0 on reads. The HOST_BUSY bit in the Host Status register (offset 00h) can be used to identify when the Intel® ICH10 has finished the command.</p> <p>1 = Writing a 1 to this bit initiates the command described in the SMB_CMD field. All registers should be setup prior to writing a 1 to this bit position.</p> |
| 5 | <p>LAST_BYTE — WO. This bit is used for Block Read commands.</p> <p>1 = Software sets this bit to indicate that the next byte will be the last byte to be received for the block. This causes the ICH10 to send a NACK (instead of an ACK) after receiving the last byte.</p> <p>NOTE: Once the SECOND_TO_STS bit in TCO2_STS register (D31:F0, TCOBASE+6h, bit 1) is set, the LAST_BYTE bit also gets set. While the SECOND_TO_STS bit is set, the LAST_BYTE bit cannot be cleared. This prevents the ICH10 from running some of the SMBus commands (Block Read/Write, I²C Read, Block I²C Write).</p> |



| Bit | Description |
|-----|----------------------------------------------------------------------------------------------------------------------------------------------------------------------------------------------------------------------------------------------------------------------------------------------------------------------------------------------------------------------------------------------------------------------------------------------------------------------------------------------------------------------------------------------------------------------------------------------------------------------------------------------------------------------------------------------------------------------------------------------------------------------------------------------------------------------------------------------------------------------------------------------------------------------------------------------------------------------------------------------------------------------------------------------------------------------------------------------------------------------------------------------------------------------------------------------------------------------------------------------------------------------------------------------------------------------------------------------------------------------------------------------------------------------------------------------------------------------------------------------------------------------------------------------------------------------------------------------------------------------------------------------------------------------------------------------------------------------------------------------------------------------------------------------------------------------------------------------------------------------------------------------------------------------------------------------------------------------------------------------------------------------------------------------------------------------------------------------------------------------------------------------------------------------------------------------------------------------------------------------------------------------------------------------------------------------------------------------------------------------------------------------------------------------------------------------------------------------------------------------------------------------------------------------------------------------------------------------------------------------------------------------------------------------------------------------------------------------------------------------------------------------------------------------------------------------------------------------------------------------------------------------------------------------------------------------------------------------------------------------------------------------------------------------------------------------------------------------------------------------------------------------------------------------------------------------------------------------------------------------------------------|
| 4:2 | <p>SMB_CMD — R/W. The bit encoding below indicates which command the ICH10 is to perform. If enabled, the ICH10 will generate an interrupt or SMI# when the command has completed. If the value is for a non-supported or reserved command, the ICH10 will set the device error (DEV_ERR) status bit (offset SMBASE + 00h, bit 2) and generate an interrupt when the START bit is set. The ICH10 will perform no command, and will not operate until DEV_ERR is cleared.</p> <p>000 = Quick: The slave address and read/write value (bit 0) are stored in the transmit slave address register.</p> <p>001 = Byte: This command uses the transmit slave address and command registers. Bit 0 of the slave address register determines if this is a read or write command.</p> <p>010 = Byte Data: This command uses the transmit slave address, command, and DATA0 registers. Bit 0 of the slave address register determines if this is a read or write command. If it is a read, the DATA0 register will contain the read data.</p> <p>011 = Word Data: This command uses the transmit slave address, command, DATA0 and DATA1 registers. Bit 0 of the slave address register determines if this is a read or write command. If it is a read, after the command completes, the DATA0 and DATA1 registers will contain the read data.</p> <p>100 = Process Call: This command uses the transmit slave address, command, DATA0 and DATA1 registers. Bit 0 of the slave address register determines if this is a read or write command. After the command completes, the DATA0 and DATA1 registers will contain the read data.</p> <p>101 = Block: This command uses the transmit slave address, command, DATA0 registers, and the Block Data Byte register. For block write, the count is stored in the DATA0 register and indicates how many bytes of data will be transferred. For block reads, the count is received and stored in the DATA0 register. Bit 0 of the slave address register selects if this is a read or write command. For writes, data is retrieved from the first n (where n is equal to the specified count) addresses of the SRAM array. For reads, the data is stored in the Block Data Byte register.</p> <p>110 = I²C Read: This command uses the transmit slave address, command, DATA0, DATA1 registers, and the Block Data Byte register. The read data is stored in the Block Data Byte register. The ICH10 continues reading data until the NAK is received.</p> <p>111 = Block Process: This command uses the transmit slave address, command, DATA0 and the Block Data Byte register. For block write, the count is stored in the DATA0 register and indicates how many bytes of data will be transferred. For block read, the count is received and stored in the DATA0 register. Bit 0 of the slave address register always indicate a write command. For writes, data is retrieved from the first m (where m is equal to the specified count) addresses of the SRAM array. For reads, the data is stored in the Block Data Byte register.</p> <p>NOTE: E32B bit in the Auxiliary Control register must be set for this command to work.</p> |
| 1 | <p>KILL — R/W.</p> <p>0 = Normal SMBus host controller functionality.</p> <p>1 = Kills the current host transaction taking place, sets the FAILED status bit, and asserts the interrupt (or SMI#). This bit, once set, must be cleared by software to allow the SMBus host controller to function normally.</p> |
| 0 | <p>INTREN — R/W.</p> <p>0 = Disable.</p> <p>1 = Enable the generation of an interrupt or SMI# upon the completion of the command.</p> |



19.2.3 HST_CMD—Host Command Register (SMBus—D31:F3)

Register Offset: SMBASE + 03h Attribute: R/W
Default Value: 00h Size: 8 bits

| Bit | Description |
|-----|----------------------------------------------------------------------------------------------------------------------------------------|
| 7:0 | This 8-bit field is transmitted by the host controller in the command field of the SMBus protocol during the execution of any command. |

19.2.4 XMIT_SLVA—Transmit Slave Address Register (SMBus—D31:F3)

Register Offset: SMBASE + 04h Attribute: R/W
Default Value: 00h Size: 8 bits

This register is transmitted by the host controller in the slave address field of the SMBus protocol.

| Bit | Description |
|-----|----------------------------------------------------------------------------------|
| 7:1 | Address — R/W. This field provides a 7-bit address of the targeted slave. |
| 0 | RW — R/W. Direction of the host transfer. 0 = Write 1 = Read |

19.2.5 HST_D0—Host Data 0 Register (SMBus—D31:F3)

Register Offset: SMBASE + 05h Attribute: R/W
Default Value: 00h Size: 8 bits

| Bit | Description |
|-----|------------------------------------------------------------------------------------------------------------------------------------------------------------------------------------------------------------------------------------------------------------------------------------------------------------------------------------------------------------------------------------------------------------------------|
| 7:0 | Data0/Count — R/W. This field contains the 8-bit data sent in the DATA0 field of the SMBus protocol. For block write commands, this register reflects the number of bytes to transfer. This register should be programmed to a value between 1 and 32 for block counts. A count of 0 or a count above 32 will result in unpredictable behavior. The host controller does not check or log invalid block counts. |

19.2.6 HST_D1—Host Data 1 Register (SMBus—D31:F3)

Register Offset: SMBASE + 06h Attribute: R/W
Default Value: 00h Size: 8 bits

| Bit | Description |
|-----|--------------------------------------------------------------------------------------------------------------------------------------|
| 7:0 | Data1 — R/W. This 8-bit register is transmitted in the DATA1 field of the SMBus protocol during the execution of any command. |



19.2.7 Host_BLOCK_DB—Host Block Data Byte Register (SMBus—D31:F3)

Register Offset: SMBASE + 07h Attribute: R/W
 Default Value: 00h Size: 8 bits

| Bit | Description |
|-----|------------------------------------------------------------------------------------------------------------------------------------------------------------------------------------------------------------------------------------------------------------------------------------------------------------------------------------------------------------------------------------------------------------------------------------------------------------------------------------------------------------------------------------------------------------------------------------------------------------------------------------------------------------------------------------------------------------------------------------------------------------------------------------------------------------------------------------------------------------------------------------------------------------------------------------------------------------------------------------------------------------------------------------------------------------------------------------------------------------------------------------------------------------------------------------------------------------------------------------------------------------------------------------------------------------------------------------------------------------------------------------------------------------------------------------------------------------------------------------------------------------------------------------------------------------------------------------------------------------------------------------------------------------------------------------------------------------------------------------------------------------------------------------------------------------------------------------------------------------------------------------------------------------------------------------------------------------------------------------------------------------------------------------------------------------------------------------------------------------------------------------------------------------------------------------------------------------------------------------------------------------------------------------------------------------------|
| 7:0 | <p>Block Data (BDTA) — R/W. This is either a register, or a pointer into a 32-byte block array, depending upon whether the E32B bit is set in the Auxiliary Control register. When the E32B bit (offset SMBASE + 0Dh, bit 1) is cleared, this is a register containing a byte of data to be sent on a block write or read from on a block read, just as it behaved on the ICH3.</p> <p>When the E32B bit is set, reads and writes to this register are used to access the 32-byte block data storage array. An internal index pointer is used to address the array, which is reset to 0 by reading the HCTL register (offset 02h). The index pointer then increments automatically upon each access to this register. The transfer of block data into (read) or out of (write) this storage array during an SMBus transaction always starts at index address 0.</p> <p>When the E2B bit is set, for writes, software will write up to 32-bytes to this register as part of the setup for the command. After the Host controller has sent the Address, Command, and Byte Count fields, it will send the bytes in the SRAM pointed to by this register.</p> <p>When the E2B bit is cleared for writes, software will place a single byte in this register. After the host controller has sent the address, command, and byte count fields, it will send the byte in this register. If there is more data to send, software will write the next series of bytes to the SRAM pointed to by this register and clear the DONE_STS bit. The controller will then send the next byte. During the time between the last byte being transmitted to the next byte being transmitted, the controller will insert wait-states on the interface.</p> <p>When the E2B bit is set for reads, after receiving the byte count into the Data0 register, the first series of data bytes go into the SRAM pointed to by this register. If the byte count has been exhausted or the 32-byte SRAM has been filled, the controller will generate an SMI# or interrupt (depending on configuration) and set the DONE_STS bit. Software will then read the data. During the time between when the last byte is read from the SRAM to when the DONE_STS bit is cleared, the controller will insert wait-states on the interface.</p> |

19.2.8 PEC—Packet Error Check (PEC) Register (SMBus—D31:F3)

Register Offset: SMBASE + 08h Attribute: R/W
 Default Value: 00h Size: 8 bits

| Bit | Description |
|-----|-------------------------------------------------------------------------------------------------------------------------------------------------------------------------------------------------------------------------------------------------------------------------------------------------------------------------------------------------------------------------------------------------------------------------------------|
| 7:0 | <p>PEC_DATA — R/W. This 8-bit register is written with the 8-bit CRC value that is used as the SMBus PEC data prior to a write transaction. For read transactions, the PEC data is loaded from the SMBus into this register and is then read by software. Software must ensure that the INUSE_STS bit is properly maintained to avoid having this field overwritten by a write transaction following a read transaction.</p> |



19.2.9 RCV_SLVA—Receive Slave Address Register (SMBus—D31:F3)

Register Offset: SMBASE + 09h Attribute: R/W
 Default Value: 44h Size: 8 bits
 Lockable: No Power Well: Resume

| Bit | Description |
|-----|-------------------------------------------------------------------------------------------------------------------------------------------------------------------------------------------------------------------------------------------------------------------------------------------------------------|
| 7 | Reserved |
| 6:0 | SLAVE_ADDR — R/W. This field is the slave address that the Intel® ICH10 decodes for read and write cycles. the default is not 0, so the SMBus Slave Interface can respond even before the processor comes up (or if the processor is dead). This register is cleared by RSMRST#, but not by PLTRST#. |

19.2.10 SLV_DATA—Receive Slave Data Register (SMBus—D31:F3)

Register Offset: SMBASE + 0Ah–0Bh Attribute: RO
 Default Value: 0000h Size: 16 bits
 Lockable: No Power Well: Resume

This register contains the 16-bit data value written by the external SMBus master. The processor can then read the value from this register. This register is reset by RSMRST#, but not PLTRST#

| Bit | Description |
|------|-----------------------------------------------------------------------------------------------------------------|
| 15:8 | Data Message Byte 1 (DATA_MSG1) — RO. See Section 5.20.7 for a discussion of this field. |
| 7:0 | Data Message Byte 0 (DATA_MSG0) — RO. See Section 5.20.7 for a discussion of this field. |

19.2.11 AUX_STS—Auxiliary Status Register (SMBus—D31:F3)

Register Offset: SMBASE + 0Ch Attribute: R/WC, RO
 Default Value: 00h Size: 8 bits
 Lockable: No Power Well: Resume

| Bit | Description |
|-----|------------------------------------------------------------------------------------------------------------------------------------------------------------------------------------------------------------------------------------------------------------------------------------------------------------------------------------------------------------------------------------------------------------------------------------------------------------------|
| 7:2 | Reserved |
| 1 | SMBus TCO Mode (STCO) — RO. This bit reflects the strap setting of TCO compatible mode vs. Advanced TCO mode. 0 = Intel® ICH10 is in the compatible TCO mode. 1 = ICH10 is in the advanced TCO mode. |
| 0 | CRC Error (CRCE) — R/WC. 0 = Software clears this bit by writing a 1 to it. 1 = This bit is set if a received message contained a CRC error. When this bit is set, the DERR bit of the host status register will also be set. This bit will be set by the controller if a software abort occurs in the middle of the CRC portion of the cycle or an abort happens after the ICH10 has received the final data bit transmitted by an external slave. |



19.2.12 AUX_CTL—Auxiliary Control Register (SMBus—D31:F3)

Register Offset: SMBASE + 0Dh Attribute: R/W
 Default Value: 00h Size: 8 bits
 Lockable: No Power Well: Resume

| Bit | Description |
|-----|--------------------------------------------------------------------------------------------------------------------------------------------------------------------------------------------------------------------------------------------------------------------------------------------------------------------------|
| 7:2 | Reserved |
| 1 | Enable 32-Byte Buffer (E32B) — R/W. 0 = Disable. 1 = Enable. When set, the Host Block Data register is a pointer into a 32-byte buffer, as opposed to a single register. This enables the block commands to transfer or receive up to 32-bytes before the ICH10 generates an interrupt. |
| 0 | Automatically Append CRC (AAC) — R/W. 0 = ICH10 will Not automatically append the CRC. 1 = The ICH10 will automatically append the CRC. This bit must not be changed during SMBus transactions or undetermined behavior will result. It should be programmed only once during the lifetime of the function. |

19.2.13 SMLINK_PIN_CTL—SMLink Pin Control Register (SMBus—D31:F3)

Register Offset: SMBASE + 0Eh Attribute: R/W, RO
 Default Value: See below Size: 8 bits

Note: This register is in the resume well and is reset by RSMRST#.

This register is only applicable in the TCO compatible mode.

| Bit | Description |
|-----|-----------------------------------------------------------------------------------------------------------------------------------------------------------------------------------------------------------------------------------------------------------------------------------------|
| 7:3 | Reserved |
| 2 | SMLINK_CLK_CTL — R/W. 0 = ICH10 will drive the SMLINK0 pin low, independent of what the other SMLINK logic would otherwise indicate for the SMLINK0 pin. 1 = The SMLINK0 pin is not overdriven low. The other SMLINK logic controls the state of the pin. (Default) |
| 1 | SMLINK1_CUR_STS — RO. This read-only bit has a default value that is dependent on an external signal level. This pin returns the value on the SMLINK1 pin. This allows software to read the current state of the pin. 0 = Low 1 = High |
| 0 | SMLINK0_CUR_STS — RO. This read-only bit has a default value that is dependent on an external signal level. This pin returns the value on the SMLINK0 pin. This allows software to read the current state of the pin. 0 = Low 1 = High |



19.2.14 SMBus_PIN_CTL—SMBus Pin Control Register (SMBus—D31:F3)

Register Offset: SMBASE + 0Fh Attribute: R/W, RO
 Default Value: See below Size: 8 bits

Note: This register is in the resume well and is reset by RSMRST#.

| Bit | Description |
|-----|--------------------------------------------------------------------------------------------------------------------------------------------------------------------------------------------------------------------------------------------------------------------------|
| 7:3 | Reserved |
| 2 | SMBCLK_CTL — R/W. 1 = The SMBCLK pin is not overdriven low. The other SMBus logic controls the state of the pin. 0 = ICH10 drives the SMBCLK pin low, independent of what the other SMB logic would otherwise indicate for the SMBCLK pin. (Default) |
| 1 | SMBDATA_CUR_STS — RO. This read-only bit has a default value that is dependent on an external signal level. This pin returns the value on the SMBDATA pin. This allows software to read the current state of the pin. 0 = Low 1 = High |
| 0 | SMBCLK_CUR_STS — RO. This read-only bit has a default value that is dependent on an external signal level. This pin returns the value on the SMBCLK pin. This allows software to read the current state of the pin. 0 = Low 1 = High |

19.2.15 SLV_STS—Slave Status Register (SMBus—D31:F3)

Register Offset: SMBASE + 10h Attribute: R/WC
 Default Value: 00h Size: 8 bits

Note: This register is in the resume well and is reset by RSMRST#.

All bits in this register are implemented in the 64 kHz clock domain. Therefore, software must poll this register until a write takes effect before assuming that a write has completed internally.

| Bit | Description |
|-----|----------------------------------------------------------------------------------------------------------------------------------------------------------------------------------------------------------------------------------------------------------------------------------------------------------------------------------------------------------------------------------------------------------------------------------------------------------------------------------------------------------------------------------------------------------------------------------------------------------------------------------------------------------------------------------------------------------------------------------------------------------------------------------------------------|
| 7:1 | Reserved |
| 0 | HOST_NOTIFY_STS — R/WC. The ICH10 sets this bit to a 1 when it has completely received a successful Host Notify Command on the SMLink (Consumer Only) or SMBus pins (Corporate Only). Software reads this bit to determine that the source of the interrupt or SMI# was the reception of the Host Notify Command. Software clears this bit after reading any information needed from the Notify address and data registers by writing a 1 to this bit. Note that the ICH10 will allow the Notify Address and Data registers to be over-written once this bit has been cleared. When this bit is 1, the ICH10 will NACK the first byte (host address) of any new "Host Notify" commands on the SMLink (Consumer Only) or SMBus pins (Corporate Only). Writing a 0 to this bit has no effect. |

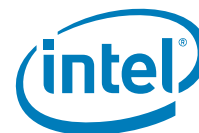

19.2.16 SLV_CMD—Slave Command Register (SMBus—D31:F3)

Register Offset: SMBASE + 11h Attribute: R/W
 Default Value: 00h Size: 8 bits

Note: This register is in the resume well and is reset by RSMRST#.

| Bit | Description |
|-----|------------------------------------------------------------------------------------------------------------------------------------------------------------------------------------------------------------------------------------------------------------------------------------------------------------------------------------------------------------------------------------------------------------------------------------------------------------------------------------------------------------------------------------------------------------------------------------------------------------------------------|
| 7:2 | Reserved |
| 2 | <p>SMBALERT_DIS — R/W.</p> <p>0 = Allows the generation of the interrupt or SMI#.</p> <p>1 = Software sets this bit to block the generation of the interrupt or SMI# due to the SMBALERT# source. This bit is logically inverted and ANDed with the SMBALERT_STS bit (offset SMBASE + 00h, bit 5). The resulting signal is distributed to the SMI# and/or interrupt generation logic. This bit does not effect the wake logic.</p> |
| 1 | <p>HOST_NOTIFY_WKEN — R/W. Software sets this bit to 1 to enable the reception of a Host Notify command as a wake event. When enabled this event is "OR'd" in with the other SMBus wake events and is reflected in the SMB_WAK_STS bit of the General Purpose Event 0 Status register.</p> <p>0 = Disable 1 = Enable</p> |
| 0 | <p>HOST_NOTIFY_INTREN — R/W. Software sets this bit to 1 to enable the generation of interrupt or SMI# when HOST_NOTIFY_STS (offset SMBASE + 10h, bit 0) is 1. This enable does not affect the setting of the HOST_NOTIFY_STS bit. When the interrupt is generated, either PIROB# or SMI# is generated, depending on the value of the SMB_SMI_EN bit (D31:F3:40h, bit 1). If the HOST_NOTIFY_STS bit is set when this bit is written to a 1, then the interrupt (or SMI#) will be generated. The interrupt (or SMI#) is logically generated by AND'ing the STS and INTREN bits.</p> <p>0 = Disable 1 = Enable</p> |

19.2.17 NOTIFY_DADDR—Notify Device Address Register (SMBus—D31:F3)

Register Offset: SMBASE + 14h Attribute: RO
 Default Value: 00h Size: 8 bits

Note: This register is in the resume well and is reset by RSMRST#.

| Bit | Description |
|-----|------------------------------------------------------------------------------------------------------------------------------------------------------------------------------------------------------------------------------------------------------------------------------|
| 7:1 | <p>DEVICE_ADDRESS — RO. This field contains the 7-bit device address received during the Host Notify protocol of the SMBus 2.0 Specification. Software should only consider this field valid when the HOST_NOTIFY_STS bit (D31:F3:SMBASE +10, bit 0) is set to 1.</p> |
| 0 | Reserved |



19.2.18 NOTIFY_DLOW—Notify Data Low Byte Register (SMBus—D31:F3)

Register Offset: SMBASE + 16h Attribute: RO
Default Value: 00h Size: 8 bits

Note: This register is in the resume well and is reset by RSMRST#.

| Bit | Description |
|-----|--------------------------------------------------------------------------------------------------------------------------------------------------------------------------------------------------------------------------------------------------------------------------|
| 7:0 | DATA_LOW_BYTE — RO. This field contains the first (low) byte of data received during the Host Notify protocol of the SMBus 2.0 specification. Software should only consider this field valid when the HOST_NOTIFY_STS bit (D31:F3:SMBASE +10, bit 0) is set to 1. |

19.2.19 NOTIFY_DHIGH—Notify Data High Byte Register (SMBus—D31:F3)

Register Offset: SMBASE + 17h Attribute: RO
Default Value: 00h Size: 8 bits

Note: This register is in the resume well and is reset by RSMRST#.

| Bit | Description |
|-----|-----------------------------------------------------------------------------------------------------------------------------------------------------------------------------------------------------------------------------------------------------------------------------|
| 7:0 | DATA_HIGH_BYTE — RO. This field contains the second (high) byte of data received during the Host Notify protocol of the SMBus 2.0 specification. Software should only consider this field valid when the HOST_NOTIFY_STS bit (D31:F3:SMBASE +10, bit 0) is set to 1. |

§ §



20 PCI Express* Configuration Registers

20.1 PCI Express* Configuration Registers (PCI Express—D28:F0/F1/F2/F3/F4/F5)

Note: Register address locations that are not shown in Table 20-1 and should be treated as Reserved.

Table 20-1. PCI Express* Configuration Registers Address Map (PCI Express—D28:F0/F1/F2/F3/F4/F5) (Sheet 1 of 3)

| Offset | Mnemonic | Register Name | Function 0–5 Default | Type |
|---------|----------|-----------------------------------------|--------------------------|----------|
| 00h–01h | VID | Vendor Identification | 8086h | RO |
| 02h–03h | DID | Device Identification | See register description | RO |
| 04h–05h | PCICMD | PCI Command | 0000h | R/W, RO |
| 06h–07h | PCISTS | PCI Status | 0010h | R/WC, RO |
| 08h | RID | Revision Identification | See register description | RO |
| 09h | PI | Programming Interface | 00h | RO |
| 0Ah | SCC | Sub Class Code | 04h | RO |
| 0Bh | BCC | Base Class Code | 06h | RO |
| 0Ch | CLS | Cache Line Size | 00h | R/W |
| 0Dh | PLT | Primary Latency Timer | 00h | RO |
| 0Eh | HEADTYP | Header Type | 81h | RO |
| 18h–1Ah | BNUM | Bus Number | 000000h | R/W |
| 1Bh | SLT | Secondary Latency Timer | 00h | RO |
| 1Ch–1Dh | IOBL | I/O Base and Limit | 0000h | R/W, RO |
| 1Eh–1Fh | SSTS | Secondary Status Register | 0000h | R/WC |
| 20h–23h | MBL | Memory Base and Limit | 00000000h | R/W |
| 24h–27h | PMBL | Prefetchable Memory Base and Limit | 00010001h | R/W, RO |
| 28h–2Bh | PMBU32 | Prefetchable Memory Base Upper 32 Bits | 00000000h | R/W |
| 2Ch–2Fh | PMLU32 | Prefetchable Memory Limit Upper 32 Bits | 00000000h | R/W |
| 34h | CAPP | Capabilities List Pointer | 40h | RO |
| 3Ch–3Dh | INTR | Interrupt Information | See bit description | R/W, RO |
| 3Eh–3Fh | BCTRL | Bridge Control Register | 0000h | R/W |
| 40h–41h | CLIST | Capabilities List | 8010 | RO |

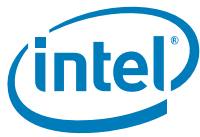

Table 20-1. PCI Express* Configuration Registers Address Map (PCI Express—D28:F0/F1/F2/F3/F4/F5) (Sheet 2 of 3)

| Offset | Mnemonic | Register Name | Function 0–5 Default | Type |
|--------------------------|----------|--------------------------------------------|----------------------|---------------|
| 42h–43h | XCAP | PCI Express* Capabilities | 0041 | R/WO, RO |
| 44h–47h | DCAP | Device Capabilities | 00000FE0h | RO |
| 48h–49h | DCTL | Device Control | 0000h | R/W, RO |
| 4Ah–4Bh | DSTS | Device Status | 0010h | R/WC, RO |
| 4Ch–4Fh | LCAP | Link Capabilities | See bit description | R/W, RO, R/WO |
| 50h–51h | LCTL | Link Control | 0000h | R/W, WO, RO |
| 52h–53h | LSTS | Link Status | See bit description | RO |
| 54h–57h | SLCAP | Slot Capabilities Register | 00000060h | R/WO, RO |
| 58h–59h | SLCTL | Slot Control | 0000h | R/W, RO |
| 5Ah–5Bh | SLSTS | Slot Status | 0000h | R/WC, RO |
| 5Ch–5Dh | RCTL | Root Control | 0000h | R/W |
| 60h–63h | RSTS | Root Status | 00000000h | R/WC, RO |
| 64h–67h (Corporate Only) | DCAP2 | Device Capabilities 2 Register | 00000016h | RO |
| 68h–69h (Corporate Only) | DCTL2 | Device Control 2 Register | 0000h | R/W, RO |
| 70h–71h (Corporate Only) | LCTL2 | Link Control 2 Register | 0001h | RO |
| 80h–81h | MID | Message Signaled Interrupt Identifiers | 9005h | RO |
| 82h–83h | MC | Message Signaled Interrupt Message Control | 0000h | R/W, RO |
| 84h–87h | MA | Message Signaled Interrupt Message Address | 00000000h | R/W |
| 88h–89h | MD | Message Signaled Interrupt Message Data | 0000h | R/W |
| 90h–91h | SVCAP | Subsystem Vendor Capability | A00Dh | RO |
| 94h–97h | SVID | Subsystem Vendor Identification | 00000000h | R/WO |
| A0h–A1h | PMCAP | Power Management Capability | 0001h | RO |
| A2h–A3h | PMC | PCI Power Management Capability | C802h | RO |
| A4–A7h | PMCS | PCI Power Management Control and Status | 00000000h | R/W, RO |
| D4–D7h | MPC2 | Miscellaneous Port Configuration 2 | 00000000h | R/W, RO |
| D8–DBh | MPC | Miscellaneous Port Configuration | 08110000h | R/W |



Table 20-1. PCI Express* Configuration Registers Address Map (PCI Express—D28:F0/F1/F2/F3/F4/F5) (Sheet 3 of 3)

| Offset | Mnemonic | Register Name | Function 0–5 Default | Type |
|-----------|----------|-----------------------------------------|----------------------|----------|
| DC–DFh | SMSCS | SMI/SCI Status Register | 00000000h | R/WC |
| E1h | RPDCGEN | Root Port Dynamic Clock Gating Enable | 00h | R/W |
| E8–EBh | PECR1 | PCI Express Configuration Register 1 | 00000020h | R/W |
| 100–103h | VCH | Virtual Channel Capability Header | 18010002h | R/WO |
| 104h–107h | — | Reserved | — | — |
| 108h–10Bh | VCAP2 | Virtual Channel Capability 2 | 00000001h | RO |
| 10Ch–10Dh | PVC | Port Virtual Channel Control | 0000h | R/W |
| 10Eh–10Fh | PVS | Port Virtual Channel Status | 0000h | RO |
| 110h–113h | VOCAP | Virtual Channel 0 Resource Capability | 00000001h | RO |
| 114–117h | VOCTL | Virtual Channel 0 Resource Control | 800000FFh | R/W, RO |
| 11A–11Bh | VOSTS | Virtual Channel 0 Resource Status | 0000h | RO |
| 11Ch–143h | — | Reserved | — | — |
| 144h–147h | UES | Uncorrectable Error Status | See bit description | R/WC, RO |
| 148h–14Bh | UEM | Uncorrectable Error Mask | 00000000h | R/WO, RO |
| 14Ch–14Fh | UEV | Uncorrectable Error Severity | 00060011h | RO |
| 150h–153h | CES | Correctable Error Status | 00000000h | R/WC |
| 154h–157h | CEM | Correctable Error Mask | 00000000h | R/WO |
| 158h–15Bh | AECC | Advanced Error Capabilities and Control | 00000000h | RO |
| 170h–173h | RES | Root Error Status | 00000000h | R/WC, RO |
| 180h–183h | RCTCL | Root Complex Topology Capability List | 00010005h | RO |
| 184h–187h | ESD | Element Self Description | See bit description | RO |
| 190h–193h | ULD | Upstream Link Description | 00000001h | RO |
| 198h–19Fh | ULBA | Upstream Link Base Address | See bit description | RO |
| 300–303h | PECR2 | PCI Express Configuration Register 2 | 60005007h | R/W |
| 318h | PEETM | PCI Express Extended Test Mode Register | See bit description | RO |
| 324h–327h | PEC1 | PCI Express Configuration Register 1 | 00000000h | RO, R/W |



20.1.3 PCICMD—PCI Command Register (PCI Express—D28:F0/F1/F2/F3/F4/F5)

Address Offset: 04h–05h
Default Value: 0000h

Attribute: R/W, RO
Size: 16 bits

| Bit | Description |
|-------|-----------------------------------------------------------------------------------------------------------------------------------------------------------------------------------------------------------------------------------------------------------------------------------------------------------------------------------------------------------------------------------------------------------------------------------------------------------------------------------------------------------------------------------------------------------------------------------------------|
| 15:11 | Reserved |
| 10 | <p>Interrupt Disable — R/W. This disables pin-based INTx# interrupts on enabled Hot-Plug and power management events. This bit has no effect on MSI operation.</p> <p>0 = Internal INTx# messages are generated if there is an interrupt for Hot-Plug or power management and MSI is not enabled.</p> <p>1 = Internal INTx# messages will not be generated.</p> <p>This bit does not affect interrupt forwarding from devices connected to the root port. Assert_INTx and Deassert_INTx messages will still be forwarded to the internal interrupt controllers if this bit is set.</p> |
| 9 | Fast Back to Back Enable (FBE) — Reserved per the <i>PCI Express* Base Specification</i> . |
| 8 | <p>SERR# Enable (SEE) — R/W.</p> <p>0 = Disable.</p> <p>1 = Enables the root port to generate an SERR# message when PSTS.SSE is set.</p> |
| 7 | Wait Cycle Control (WCC) — Reserved per the <i>PCI Express Base Specification</i> . |
| 6 | <p>Parity Error Response (PER) — R/W.</p> <p>0 = Disable.</p> <p>1 = Indicates that the device is capable of reporting parity errors as a master on the backbone.</p> |
| 5 | VGA Palette Snoop (VPS) — Reserved per the <i>PCI Express* Base Specification</i> . |
| 4 | Postable Memory Write Enable (PMWE) — Reserved per the <i>PCI Express* Base Specification</i> . |
| 3 | Special Cycle Enable (SCE) — Reserved per the <i>PCI Express* Base Specification</i> . |
| 2 | <p>Bus Master Enable (BME) — R/W.</p> <p>0 = Disable. All cycles from the device are master aborted</p> <p>1 = Enable. Allows the root port to forward cycles onto the backbone from a PCI Express* device.</p> |
| 1 | <p>Memory Space Enable (MSE) — R/W.</p> <p>0 = Disable. Memory cycles within the range specified by the memory base and limit registers are master aborted on the backbone.</p> <p>1 = Enable. Allows memory cycles within the range specified by the memory base and limit registers can be forwarded to the PCI Express device.</p> |
| 0 | <p>I/O Space Enable (IOSE) — R/W. This bit controls access to the I/O space registers.</p> <p>0 = Disable. I/O cycles within the range specified by the I/O base and limit registers are master aborted on the backbone.</p> <p>1 = Enable. Allows I/O cycles within the range specified by the I/O base and limit registers can be forwarded to the PCI Express device.</p> |



20.1.4 PCISTS—PCI Status Register (PCI Express—D28:F0/F1/F2/F3/F4/F5)

Address Offset: 06h–07h Attribute: R/WC, RO
 Default Value: 0010h Size: 16 bits

| Bit | Description |
|------|-------------------------------------------------------------------------------------------------------------------------------------------------------------------------------------------------------------------------------------------------------------------------------------------------------------------------------------------------------------------------------------------------|
| 15 | Detected Parity Error (DPE) — R/WC. 0 = No parity error detected. 1 = Set when the root port receives a command or data from the backbone with a parity error. This is set even if PCIMD.PER (D28:F0/F1/F2/F3:04, bit 6) is not set. |
| 14 | Signaled System Error (SSE) — R/WC. 0 = No system error signaled. 1 = Set when the root port signals a system error to the internal SERR# logic. |
| 13 | Received Master Abort (RMA) — R/WC. 0 = Root port has not received a completion with unsupported request status from the backbone. 1 = Set when the root port receives a completion with unsupported request status from the backbone. |
| 12 | Received Target Abort (RTA) — R/WC. 0 = Root port has not received a completion with completer abort from the backbone. 1 = Set when the root port receives a completion with completer abort from the backbone. |
| 11 | Signaled Target Abort (STA) — R/WC. 0 = No target abort received. 1 = Set whenever the root port forwards a target abort received from the downstream device onto the backbone. |
| 10:9 | DEVSEL# Timing Status (DEV_STS) — Reserved per the <i>PCI Express* Base Specification</i> . |
| 8 | Master Data Parity Error Detected (DPED) — R/WC. 0 = No data parity error received. 1 = Set when the root port receives a completion with a data parity error on the backbone and PCIMD.PER (D28:F0/F1/F2/F3:04, bit 6) is set. |
| 7 | Fast Back to Back Capable (FB2BC) — Reserved per the <i>PCI Express* Base Specification</i> . |
| 6 | Reserved |
| 5 | 66 MHz Capable — Reserved per the <i>PCI Express* Base Specification</i> . |
| 4 | Capabilities List — RO. Hardwired to 1. Indicates the presence of a capabilities list. |
| 3 | Interrupt Status — RO. Indicates status of Hot-Plug and power management interrupts on the root port that result in INTx# message generation. 0 = Interrupt is deasserted. 1 = Interrupt is asserted. This bit is not set if MSI is enabled. If MSI is not enabled, this bit is set regardless of the state of PCICMD.Interrupt Disable bit (D28:F0/F1/F2/F3/F4/F5:04h:bit 10). |
| 2:0 | Reserved |



20.1.15 SSTS—Secondary Status Register (PCI Express—D28:F0/F1/F2/F3/F4/F5)

Address Offset: 1Eh–1Fh
Default Value: 0000h

Attribute: R/WC
Size: 16 bits

| Bit | Description |
|------|------------------------------------------------------------------------------------------------------------------------------------------------------------------------------------------------------------------------------------------------------------------------------------------------------------------------------------------------------------------------------|
| 15 | Detected Parity Error (DPE) — R/WC. 0 = No error. 1 = The port received a poisoned TLP |
| 14 | Received System Error (RSE) — R/WC. 0 = No error. 1 = The port received an ERR_FATAL or ERR_NONFATAL message from the device. |
| 13 | Received Master Abort (RMA) — R/WC. 0 = Unsupported Request not received. 1 = The port received a completion with “Unsupported Request” status from the device. |
| 12 | Received Target Abort (RTA) — R/WC. 0 = Completion Abort not received. 1 = The port received a completion with “Completion Abort” status from the device. |
| 11 | Signaled Target Abort (STA) — R/WC. 0 = Completion Abort not sent. 1 = The port generated a completion with “Completion Abort” status to the device. |
| 10:9 | Secondary DEVSEL# Timing Status (SDTS): Reserved per <i>PCI Express* Base Specification</i> . |
| 8 | Data Parity Error Detected (DPD) — R/WC. 0 = Conditions below did not occur: 1 = Set when the BCTRL.PERE (D28:F0/F1/F2/F3/F4/F5:3E: bit 0) is set, and either of the following two conditions occurs: <ul style="list-style-type: none">• Port receives completion marked poisoned.• Port poisons a write request to the secondary side. |
| 7 | Secondary Fast Back to Back Capable (SFBC): Reserved per <i>PCI Express* Base Specification</i> . |
| 6 | Reserved |
| 5 | Secondary 66 MHz Capable (SC66): Reserved per <i>PCI Express* Base Specification</i> . |
| 4:0 | Reserved |

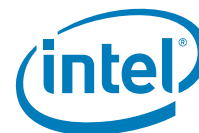

20.1.16 MBL—Memory Base and Limit Register (PCI Express—D28:F0/F1/F2/F3/F4/F5)

Address Offset: 20h–23h Attribute: R/W
 Default Value: 00000000h Size: 32 bits

Accesses that are within the ranges specified in this register will be sent to the attached device if CMD.MSE (D28:F0/F1/F2/F3/F4/F5:04:bit 1) is set. Accesses from the attached device that are outside the ranges specified will be forwarded to the backbone if CMD.BME (D28:F0/F1/F2/F3/F4/F5:04:bit 2) is set. The comparison performed is $MB \geq AD[31:20] \leq ML$.

| Bit | Description |
|-------|---------------------------------------------------------------------------------------------------------------------------------------------------------|
| 31:20 | Memory Limit (ML) — R/W. These bits are compared with bits 31:20 of the incoming address to determine the upper 1-MB aligned value of the range. |
| 19:16 | Reserved |
| 15:4 | Memory Base (MB) — R/W. These bits are compared with bits 31:20 of the incoming address to determine the lower 1-MB aligned value of the range. |
| 3:0 | Reserved |

20.1.17 PMBL—Prefetchable Memory Base and Limit Register (PCI Express—D28:F0/F1/F2/F3/F4/F5)

Address Offset: 24h–27h Attribute: R/W, RO
 Default Value: 00010001h Size: 32 bits

Accesses that are within the ranges specified in this register will be sent to the device if CMD.MSE (D28:F0/F1/F2/F3/F4/F5;04, bit 1) is set. Accesses from the device that are outside the ranges specified will be forwarded to the backbone if CMD.BME (D28:F0/F1/F2/F3/F4/F5;04, bit 2) is set. The comparison performed is $PMBU32:PMB \geq AD[63:32]:AD[31:20] \leq PMLU32:PML$.

| Bit | Description |
|-------|-----------------------------------------------------------------------------------------------------------------------------------------------------------------------|
| 31:20 | Prefetchable Memory Limit (PML) — R/W. These bits are compared with bits 31:20 of the incoming address to determine the upper 1-MB aligned value of the range. |
| 19:16 | 64-bit Indicator (I64L) — RO. Indicates support for 64-bit addressing |
| 15:4 | Prefetchable Memory Base (PMB) — R/W. These bits are compared with bits 31:20 of the incoming address to determine the lower 1-MB aligned value of the range. |
| 3:0 | 64-bit Indicator (I64B) — RO. Indicates support for 64-bit addressing |

20.1.18 PMBU32—Prefetchable Memory Base Upper 32 Bits Register (PCI Express—D28:F0/F1/F2/F3/F4/F5)

Address Offset: 28h–2Bh Attribute: R/W
 Default Value: 00000000h Size: 32 bits

| Bit | Description |
|------|-------------------------------------------------------------------------------------------------------------|
| 31:0 | Prefetchable Memory Base Upper Portion (PMBU) — R/W. Upper 32-bits of the prefetchable address base. |

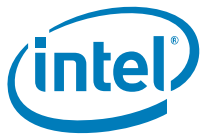

20.1.19 PMLU32—Prefetchable Memory Limit Upper 32 Bits Register (PCI Express—D28:F0/F1/F2/F3/F4/F5)

Address Offset: 2Ch–2Fh Attribute: R/W
 Default Value: 00000000h Size: 32 bits

| Bit | Description |
|------|---------------------------------------------------------------------------------------------------------------|
| 31:0 | Prefetchable Memory Limit Upper Portion (PMLU) — R/W. Upper 32-bits of the prefetchable address limit. |

20.1.20 CAPP—Capabilities List Pointer Register (PCI Express—D28:F0/F1/F2/F3/F4/F5)

Address Offset: 34h Attribute: RO
 Default Value: 40h Size: 8 bits

| Bit | Description |
|-----|---------------------------------------------------------------------------------------------------------------------------------------------------|
| 7:0 | Capabilities Pointer (PTR) — RO. Indicates that the pointer for the first entry in the capabilities list is at 40h in configuration space. |

20.1.21 INTR—Interrupt Information Register (PCI Express—D28:F0/F1/F2/F3/F4/F5)

Address Offset: 3Ch–3Dh Attribute: R/W, RO
 Default Value: See bit description Size: 16 bits
 Function Level Reset: No (Bits 7:0 only)

| Bit | Description | | | | | | | | | | | | |
|------|-------------------------------------------------------------------------------------------------------------------------------------------------------------------------------------------------------------------------------------------------------------------------------------------------------------------------------------------------------------------------------------------------------------------------------------------------------------------------------------------------------------------------------------------------------------------------------------------------------------------------------------------------------------------|------|-------------|---|------------|---|------------|---|------------|---|------------|---|------------|
| 15:8 | <p>Interrupt Pin (IPIN) — RO. Indicates the interrupt pin driven by the root port. At reset, this register takes on the following values, which reflect the reset state of the D28IP register in chipset config space:</p> <table border="1"> <thead> <tr> <th>Port</th> <th>Reset Value</th> </tr> </thead> <tbody> <tr> <td>1</td> <td>D28IP.P1IP</td> </tr> <tr> <td>2</td> <td>D28IP.P2IP</td> </tr> <tr> <td>3</td> <td>D28IP.P3IP</td> </tr> <tr> <td>4</td> <td>D28IP.P4IP</td> </tr> <tr> <td>5</td> <td>D28IP.P5IP</td> </tr> </tbody> </table> <p>NOTE: The value that is programmed into D28IP is always reflected in this register.</p> | Port | Reset Value | 1 | D28IP.P1IP | 2 | D28IP.P2IP | 3 | D28IP.P3IP | 4 | D28IP.P4IP | 5 | D28IP.P5IP |
| Port | Reset Value | | | | | | | | | | | | |
| 1 | D28IP.P1IP | | | | | | | | | | | | |
| 2 | D28IP.P2IP | | | | | | | | | | | | |
| 3 | D28IP.P3IP | | | | | | | | | | | | |
| 4 | D28IP.P4IP | | | | | | | | | | | | |
| 5 | D28IP.P5IP | | | | | | | | | | | | |
| 7:0 | Interrupt Line (ILINE) — R/W. Default = 00h. Software written value to indicate which interrupt line (vector) the interrupt is connected to. No hardware action is taken on this register. These bits are not reset by FLR. | | | | | | | | | | | | |



20.1.22 BCTRL—Bridge Control Register (PCI Express—D28:F0/F1/F2/F3/F4/F5)

Address Offset: 3Eh–3Fh
Default Value: 0000h

Attribute: R/W
Size: 16 bits

| Bit | Description |
|-------|-------------------------------------------------------------------------------------------------------------------------------------------------------------------------------------------------------------------------------------------------------------------------------------------------------------------------------------------------------------------------------------------------------------------------------------------------|
| 15:12 | Reserved |
| 11 | Discard Timer SERR# Enable (DTSE): Reserved per <i>PCI Express* Base Specification</i> , Revision 1.0a |
| 10 | Discard Timer Status (DTS): Reserved per <i>PCI Express* Base Specification</i> , Revision 1.0a. |
| 9 | Secondary Discard Timer (SDT): Reserved per <i>PCI Express* Base Specification</i> , Revision 1.0a. |
| 8 | Primary Discard Timer (PDT): Reserved per <i>PCI Express* Base Specification</i> , Revision 1.0a. |
| 7 | Fast Back to Back Enable (FBE): Reserved per <i>PCI Express* Base Specification</i> , Revision 1.0a. |
| 6 | Secondary Bus Reset (SBR) — R/W. Triggers a hot reset on the PCI Express* port. |
| 5 | Master Abort Mode (MAM): Reserved per Express specification. |
| 4 | VGA 16-Bit Decode (V16) — R/W. 0 = VGA range is enabled. 1 = The I/O aliases of the VGA range (see BCTRL:VE definition below), are not enabled, and only the base I/O ranges can be decoded |
| 3 | VGA Enable (VE) — R/W. 0 = The ranges below will not be claimed off the backbone by the root port. 1 = The following ranges will be claimed off the backbone by the root port: <ul style="list-style-type: none"> Memory ranges A0000h–BFFFFh I/O ranges 3B0h – 3BBh and 3C0h – 3DFh, and all aliases of bits 15:10 in any combination of 1s |
| 2 | ISA Enable (IE) — R/W. This bit only applies to I/O addresses that are enabled by the I/O Base and I/O Limit registers and are in the first 64 KB of PCI I/O space. 0 = The root port will not block any forwarding from the backbone as described below. 1 = The root port will block any forwarding from the backbone to the device of I/O transactions addressing the last 768 bytes in each 1-KB block (offsets 100h to 3FFh). |
| 1 | SERR# Enable (SE) — R/W. 0 = The messages described below are not forwarded to the backbone. 1 = ERR_COR, ERR_NONFATAL, and ERR_FATAL messages received are forwarded to the backbone. |
| 0 | Parity Error Response Enable (PERE) — R/W. 0 = Poisoned write TLPs and completions indicating poisoned TLPs will not set the SSTS.DPD (D28:F0/F1/F2/F3/F4/F5:1E, bit 8). 1 = Poisoned write TLPs and completions indicating poisoned TLPs will set the SSTS.DPD (D28:F0/F1/F2/F3/F4/F5:1E, bit 8). |



20.1.23 CLIST—Capabilities List Register (PCI Express—D28:F0/F1/F2/F3/F4/F5)

Address Offset: 40–41h Attribute: RO
Default Value: 8010h Size: 16 bits

| Bit | Description |
|------|----------------------------------------------------------------------------------------------|
| 15:8 | Next Capability (NEXT) — RO. Value of 80h indicates the location of the next pointer. |
| 7:0 | Capability ID (CID) — RO. Indicates this is a PCI Express* capability. |

20.1.24 XCAP—PCI Express* Capabilities Register (PCI Express—D28:F0/F1/F2/F3/F4/F5)

Address Offset: 42h–43h Attribute: R/WO, RO
Default Value: 0041h Size: 16 bits

| Bit | Description |
|-------|--------------------------------------------------------------------------------------------------------------------------------------------------------------------------------------------------------|
| 15:14 | Reserved |
| 13:9 | Interrupt Message Number (IMN) — RO. The Intel® ICH10 does not have multiple MSI interrupt numbers. |
| 8 | Slot Implemented (SI) — R/WO. Indicates whether the root port is connected to a slot. Slot support is platform specific. BIOS programs this field, and it is maintained until a platform reset. |
| 7:4 | Device / Port Type (DT) — RO. Indicates this is a PCI Express* root port. |
| 3:0 | Capability Version (CV) — RO. Indicates PCI Express 1.0. |



20.1.26 DCTL—Device Control Register (PCI Express—D28:F0/F1/F2/F3/F4/F5)

Address Offset: 48h–49h Attribute: R/W, RO
 Default Value: 0000h Size: 16 bits

| Bit | Description |
|-------|-----------------------------------------------------------------------------------------------------------------------------------------------------------------------------------------------------------------------------------------------------------------------------------------------------------------------------------------------------------------------------------------------------------------------------------------------------------------------------------------------------------------------------------------|
| 15 | Reserved |
| 14:12 | Max Read Request Size (MRRS) — RO. Hardwired to 0. |
| 11 | Enable No Snoop (ENS) — RO. Not supported. The root port will never issue non-snoop requests. |
| 10 | Aux Power PM Enable (APME) — R/W. The OS will set this bit to 1 if the device connected has detected aux power. It has no effect on the root port otherwise. |
| 9 | Phantom Functions Enable (PFE) — RO. Not supported. |
| 8 | Extended Tag Field Enable (ETFE) — RO. Not supported. |
| 7:5 | Max Payload Size (MPS) — R/W. The root port only supports 128-B payloads, regardless of the programming of this field. |
| 4 | Enable Relaxed Ordering (ERO) — RO. Not supported. |
| 3 | Unsupported Request Reporting Enable (URE) — R/W. 0 = The root port will ignore unsupported request errors. 1 = Allows signaling ERR_NONFATAL, ERR_FATAL, or ERR_COR to the Root Control register when detecting an unmasked Unsupported Request (UR). An ERR_COR is signaled when a unmasked Advisory Non-Fatal UR is received. An ERR_FATAL, ERR_or_NONFATAL, is sent to the Root Control Register when an uncorrectable non-Advisory UR is received with the severity set by the Uncorrectable Error Severity register. |
| 2 | Fatal Error Reporting Enable (FEE) — R/W. 0 = The root port will ignore fatal errors. 1 = Enables signaling of ERR_FATAL to the Root Control register due to internally detected errors or error messages received across the link. Other bits also control the full scope of related error reporting. |
| 1 | Non-Fatal Error Reporting Enable (NFE) — R/W. 0 = The root port will ignore non-fatal errors. 1 = Enables signaling of ERR_NONFATAL to the Root Control register due to internally detected errors or error messages received across the link. Other bits also control the full scope of related error reporting. |
| 0 | Correctable Error Reporting Enable (CEE) — R/W. 0 = The root port will ignore correctable errors. 1 = Enables signaling of ERR_CORR to the Root Control register due to internally detected errors or error messages received across the link. Other bits also control the full scope of related error reporting. |



20.1.27 DSTS—Device Status Register (PCI Express—D28:F0/F1/F2/F3/F4/F5)

Address Offset: 4Ah–4Bh
Default Value: 0010h

Attribute: R/WC, RO
Size: 16 bits

| Bit | Description |
|------|----------------------------------------------------------------------------------------------------------------------------------------------------------------------------------------------------------------------------------------------------------------------------------------------------|
| 15:6 | Reserved |
| 5 | Transactions Pending (TDP) — RO. This bit has no meaning for the root port since only one transaction may be pending to the Intel® ICH10, so a read of this bit cannot occur until it has already returned to 0. |
| 4 | AUX Power Detected (APD) — RO. The root port contains AUX power for wakeup. |
| 3 | Unsupported Request Detected (URD) — R/WC. Indicates an unsupported request was detected. |
| 2 | Fatal Error Detected (FED) — R/WC. Indicates a fatal error was detected. 0 = Fatal has not occurred. 1 = A fatal error occurred from a data link protocol error, link training error, buffer overflow, or malformed TLP. |
| 1 | Non-Fatal Error Detected (NFED) — R/WC. Indicates a non-fatal error was detected. 0 = Non-fatal has not occurred. 1 = A non-fatal error occurred from a poisoned TLP, unexpected completions, unsupported requests, completer abort, or completer timeout. |
| 0 | Correctable Error Detected (CED) — R/WC. Indicates a correctable error was detected. 0 = Correctable has not occurred. 1 = The port received an internal correctable error from receiver errors / framing errors, TLP CRC error, DLLP CRC error, replay num rollover, replay timeout. |



20.1.28 LCAP—Link Capabilities Register (PCI Express—D28:F0/F1/F2/F3/F4/F5)

Address Offset: 4Ch–4Fh Attribute: R/WO, RO
 Default Value: See bit description Size: 32 bits

| Bit | Description | | | | | | | | | | | | | | | | | | | | | |
|------------------------|----------------------------------------------------------------------------------------------------------------------------------------------------------------------------------------------------------------------------------------------------------------------------------------------------------------------------------------------------------------------------------------------------------------------------------------------------------------------------------------------------------------------------------------------------------------------------------------------|-------------------|---------------------------|-------------------|------------------------------------------|---|------------------------------------------|--------|---|-----|--------|---|-----|--------|---|-----|--------|---|-----|--------|---|-----|
| 31:24 | <p>Port Number (PN) — RO. Indicates the port number for the root port. This value is different for each implemented port:</p> <table border="1"> <thead> <tr> <th>Function</th> <th>Port #</th> <th>Value of PN Field</th> </tr> </thead> <tbody> <tr> <td>D28:F0</td> <td>1</td> <td>01h</td> </tr> <tr> <td>D28:F1</td> <td>2</td> <td>02h</td> </tr> <tr> <td>D28:F2</td> <td>3</td> <td>03h</td> </tr> <tr> <td>D28:F3</td> <td>4</td> <td>04h</td> </tr> <tr> <td>D28:F4</td> <td>5</td> <td>05h</td> </tr> <tr> <td>D28:F5</td> <td>6</td> <td>06h</td> </tr> </tbody> </table> | Function | Port # | Value of PN Field | D28:F0 | 1 | 01h | D28:F1 | 2 | 02h | D28:F2 | 3 | 03h | D28:F3 | 4 | 04h | D28:F4 | 5 | 05h | D28:F5 | 6 | 06h |
| Function | Port # | Value of PN Field | | | | | | | | | | | | | | | | | | | | |
| D28:F0 | 1 | 01h | | | | | | | | | | | | | | | | | | | | |
| D28:F1 | 2 | 02h | | | | | | | | | | | | | | | | | | | | |
| D28:F2 | 3 | 03h | | | | | | | | | | | | | | | | | | | | |
| D28:F3 | 4 | 04h | | | | | | | | | | | | | | | | | | | | |
| D28:F4 | 5 | 05h | | | | | | | | | | | | | | | | | | | | |
| D28:F5 | 6 | 06h | | | | | | | | | | | | | | | | | | | | |
| 23:22 | Reserved | | | | | | | | | | | | | | | | | | | | | |
| 21 (Corporate Only) | <p>Link Bandwidth Notification Capability (LBNC) – RO. 0 = Indicates root port can only support x1 link widths. 1 = Indicates root port can support link widths greater than x1. NOTE: Ports 1, 3, and 5 are required to set this bit. Ports 2, 4 and 6 can optionally set this bit.</p> | | | | | | | | | | | | | | | | | | | | | |
| 21 (Consumer Only) | Reserved | | | | | | | | | | | | | | | | | | | | | |
| 20 | <p>Link Active Reporting Capable (LARC) — RO. Hardwired to 1 to indicate that this port supports the optional capability of reporting the DL_Active state of the Data Link Control and Management State Machine.</p> | | | | | | | | | | | | | | | | | | | | | |
| 19:18 | Reserved | | | | | | | | | | | | | | | | | | | | | |
| 17:15 | <p>L1 Exit Latency (EL1) — RO. Set to 010b to indicate an exit latency of 2 μs to 4 μs.</p> | | | | | | | | | | | | | | | | | | | | | |
| 14:12 | <p>L0s Exit Latency (ELO) — RO. Indicates as exit latency based upon common-clock configuration.</p> <table border="1"> <thead> <tr> <th>LCLT.CCC</th> <th>Value of ELO (these bits)</th> </tr> </thead> <tbody> <tr> <td>0</td> <td>MPC.UCEL (D28:F0/F1/F2/F3:D8h:bits20:18)</td> </tr> <tr> <td>1</td> <td>MPC.CCEL (D28:F0/F1/F2/F3:D8h:bits17:15)</td> </tr> </tbody> </table> <p>NOTE: LCLT.CCC is at D28:F0/F1/F2/F3/F4/F5:50h:bit 6</p> | LCLT.CCC | Value of ELO (these bits) | 0 | MPC.UCEL (D28:F0/F1/F2/F3:D8h:bits20:18) | 1 | MPC.CCEL (D28:F0/F1/F2/F3:D8h:bits17:15) | | | | | | | | | | | | | | | |
| LCLT.CCC | Value of ELO (these bits) | | | | | | | | | | | | | | | | | | | | | |
| 0 | MPC.UCEL (D28:F0/F1/F2/F3:D8h:bits20:18) | | | | | | | | | | | | | | | | | | | | | |
| 1 | MPC.CCEL (D28:F0/F1/F2/F3:D8h:bits17:15) | | | | | | | | | | | | | | | | | | | | | |

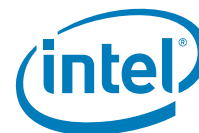

| Bit | Description | | | | | | | | | | | | | | | | | | | | | | | | | | | | | | | | |
|--------------------|--------------------------------------------------------------------------------------------------------------------------------------------------------------------------------------------------------------------------------------------------------------------------------------------------------------------------------------------------------------------------------------------------------------------------------------------------------------------------------------------------------------------------------------------------------------------------------------------------------------------------------------------------------------------------------------------------------------------------------------------------------------------------------------------------------------------------------------------------------------------------------------------------------------------------------------------------------------------------------------------------------------------------------------------------------------------------------------------------------------------------------------------------------------------------------------------------------------------------------------------------------------------------------------------------------------------------------------------------------------------------------------------------------------------------------------------------------------------------------------------------------------------------------------------------------------------------|--------------------|------------|-----|----------------------------------|--------|---------------------|-------------|--------------------|-----|---------------------------------|-----|--|---|-----|-----|--|---|-----|-----|--|---|-----|-----|--|--------|-------------|-------------|--|---|-----|-----|--|
| 11:10 | <p>Active State Link PM Support (APMS) — R/WO. Indicates what level of active state link power management is supported on the root port.</p> <table border="1"> <thead> <tr> <th data-bbox="597 386 651 407">Bits</th> <th data-bbox="716 386 834 407">Definition</th> </tr> </thead> <tbody> <tr> <td data-bbox="597 426 639 447">00b</td> <td data-bbox="716 426 1070 447">Neither L0s nor L1 are supported</td> </tr> <tr> <td data-bbox="597 466 639 487">01b</td> <td data-bbox="716 466 935 487">L0s Entry Supported</td> </tr> <tr> <td data-bbox="597 506 639 527">10b</td> <td data-bbox="716 506 924 527">L1 Entry Supported</td> </tr> <tr> <td data-bbox="597 546 639 567">11b</td> <td data-bbox="716 546 1070 567">Both L0s and L1 Entry Supported</td> </tr> </tbody> </table> | Bits | Definition | 00b | Neither L0s nor L1 are supported | 01b | L0s Entry Supported | 10b | L1 Entry Supported | 11b | Both L0s and L1 Entry Supported | | | | | | | | | | | | | | | | | | | | | | |
| Bits | Definition | | | | | | | | | | | | | | | | | | | | | | | | | | | | | | | | |
| 00b | Neither L0s nor L1 are supported | | | | | | | | | | | | | | | | | | | | | | | | | | | | | | | | |
| 01b | L0s Entry Supported | | | | | | | | | | | | | | | | | | | | | | | | | | | | | | | | |
| 10b | L1 Entry Supported | | | | | | | | | | | | | | | | | | | | | | | | | | | | | | | | |
| 11b | Both L0s and L1 Entry Supported | | | | | | | | | | | | | | | | | | | | | | | | | | | | | | | | |
| 9:4 | <p>Maximum Link Width (MLW) — RO. For the root ports, several values can be taken, based upon the value of the chipset config register field RPC.PC1 (Chipset Config Registers: Offset 0224h: bits1:0) for Ports 1-4 and RPC.PC2 (Chipset Config Registers: Offset 0224h: bits1:0) for Ports 5 and 6</p> <table border="1"> <thead> <tr> <th colspan="4" data-bbox="748 730 976 751">Value of MLW Field</th> </tr> <tr> <th data-bbox="578 770 651 791">Port #</th> <th data-bbox="737 770 899 791">RPC.PC1=00b</th> <th colspan="2" data-bbox="980 770 1143 791">RPC.PC1=11b</th> </tr> </thead> <tbody> <tr> <td data-bbox="610 810 618 831">1</td> <td data-bbox="797 810 834 831">01h</td> <td colspan="2" data-bbox="1040 810 1078 831">04h</td> </tr> <tr> <td data-bbox="610 850 618 871">2</td> <td data-bbox="797 850 834 871">01h</td> <td colspan="2" data-bbox="1040 850 1078 871">01h</td> </tr> <tr> <td data-bbox="610 890 618 911">3</td> <td data-bbox="797 890 834 911">01h</td> <td colspan="2" data-bbox="1040 890 1078 911">01h</td> </tr> <tr> <td data-bbox="610 930 618 951">4</td> <td data-bbox="797 930 834 951">01h</td> <td colspan="2" data-bbox="1040 930 1078 951">01h</td> </tr> <tr> <th data-bbox="578 970 651 991">Port #</th> <th data-bbox="737 970 899 991">RPC.PC2=00b</th> <th colspan="2" data-bbox="980 970 1143 991">RPC.PC2=11b</th> </tr> <tr> <td data-bbox="610 1010 618 1031">5</td> <td data-bbox="797 1010 834 1031">01h</td> <td colspan="2" data-bbox="1040 1010 1078 1031">N/A</td> </tr> </tbody> </table> | Value of MLW Field | | | | Port # | RPC.PC1=00b | RPC.PC1=11b | | 1 | 01h | 04h | | 2 | 01h | 01h | | 3 | 01h | 01h | | 4 | 01h | 01h | | Port # | RPC.PC2=00b | RPC.PC2=11b | | 5 | 01h | N/A | |
| Value of MLW Field | | | | | | | | | | | | | | | | | | | | | | | | | | | | | | | | | |
| Port # | RPC.PC1=00b | RPC.PC1=11b | | | | | | | | | | | | | | | | | | | | | | | | | | | | | | | |
| 1 | 01h | 04h | | | | | | | | | | | | | | | | | | | | | | | | | | | | | | | |
| 2 | 01h | 01h | | | | | | | | | | | | | | | | | | | | | | | | | | | | | | | |
| 3 | 01h | 01h | | | | | | | | | | | | | | | | | | | | | | | | | | | | | | | |
| 4 | 01h | 01h | | | | | | | | | | | | | | | | | | | | | | | | | | | | | | | |
| Port # | RPC.PC2=00b | RPC.PC2=11b | | | | | | | | | | | | | | | | | | | | | | | | | | | | | | | |
| 5 | 01h | N/A | | | | | | | | | | | | | | | | | | | | | | | | | | | | | | | |
| 3:0 | <p>Maximum Link Speed (MLS) — RO. Set to 1h to indicate the link speed is 2.5 Gb/s.</p> | | | | | | | | | | | | | | | | | | | | | | | | | | | | | | | | |



| Bit | Description |
|-----|------------------------------------------------------------------------------------------------------------------------------------------------------------------------------------------------------------------------------------------------------------------------------------------------------------------------------------|
| 2:1 | Reserved. |
| 0 | Attention Button Pressed Enable (ABE) — R/W. When set, enables the generation of a Hot-Plug interrupt when the attention button is pressed. 0 = Hot plug interrupts based on the attention button being pressed is disabled. 1 = Enables the generation of a Hot-Plug interrupt when the attention button is pressed. |

20.1.33 SLSTS—Slot Status Register (PCI Express—D28:F0/F1/F2/F3/F4/F5)

Address Offset: 5Ah–5Bh
Default Value: 0000h

Attribute: R/WC, RO
Size: 16 bits

| Bit | Description |
|-----------------------|------------------------------------------------------------------------------------------------------------------------------------------------------------------------------------------------------------------------------------------------------------------------------------------------------------------------------------------------------------------------------------------------------------------------------------------------------------|
| 15:9 | Reserved |
| 8 | Link Active State Changed (LASC) — R/WC. 1 = This bit is set when the value reported in Data Link Layer Link Active field of the Link Status register (D28:F0/F1/F2/F3/F4/F5:52h:bit 13) is changed. In response to a Data Link Layer State Changed event, software must read Data Link Layer Link Active field of the Link Status register to determine if the link is active before initiating configuration cycles to the hot plugged device. |
| 7 | Reserved |
| 6 | Presence Detect State (PDS) — RO. If XCAP.SI (D28:F0/F1/F2/F3/F4/F5:42h:bit 8) is set (indicating that this root port spawns a slot), then this bit: 0 = Indicates the slot is empty. 1 = Indicates the slot has a device connected. Otherwise, if XCAP.SI is cleared, this bit is always set (1). |
| 5 | MRL Sensor State (MS) — Reserved as the MRL sensor is not implemented. |
| 4 (Corporate Only) | Reserved |
| 4 (Consumer Only) | Command Completed (CC) — R/WC. 0 = Issued command not completed. 1 = The Hot-Plug controller completed an issued command. This is set when the last message of a command is sent and indicates that software can write a new command to the slot controller. |
| 3 | Presence Detect Changed (PDC) — R/WC. 0 = No change in the PDS bit. 1 = The PDS bit changed states. |
| 2 | MRL Sensor Changed (MSC) — Reserved as the MRL sensor is not implemented. |
| 1 | Power Fault Detected (PFD) — Reserved as a power controller is not implemented. |
| 0 (Corporate Only) | Reserved |
| 0 (Consumer Only) | Attention Button Pressed (ABP) — R/WC. 0 = The attention button has not been pressed. 1 = The attention button is pressed. |



20.1.34 RCTL—Root Control Register (PCI Express—D28:F0/F1/F2/F3/F4/F5)

Address Offset: 5Ch–5Dh Attribute: R/W
 Default Value: 0000h Size: 16 bits

| Bit | Description |
|------|------------------------------------------------------------------------------------------------------------------------------------------------------------------------------------------------------------------------------------------------------------------------------------------------------------------------------------------|
| 15:4 | Reserved |
| 3 | PME Interrupt Enable (PIE) — R/W. 0 = Interrupt generation disabled. 1 = Interrupt generation enabled when PCISTS.Inerrupt Status (D28:F0/F1/F2/F3/F4/F5:60h, bit 16) is in a set state (either due to a 0 to 1 transition, or due to this bit being set with RSTS.IS already set). |
| 2 | System Error on Fatal Error Enable (SFE) — R/W. 0 = An SERR# will not be generated. 1 = An SERR# will be generated, assuming CMD.SEE (D28:F0/F1/F2/F3/F4/F5:04, bit 8) is set, if a fatal error is reported by any of the devices in the hierarchy of this root port, including fatal errors in this root port. |
| 1 | System Error on Non-Fatal Error Enable (SNE) — R/W. 0 = An SERR# will not be generated. 1 = An SERR# will be generated, assuming CMD.SEE (D28:F0/F1/F2/F3/F4/F5:04, bit 8) is set, if a non-fatal error is reported by any of the devices in the hierarchy of this root port, including non-fatal errors in this root port. |
| 0 | System Error on Correctable Error Enable (SCE) — R/W. 0 = An SERR# will not be generated. 1 = An SERR# will be generated, assuming CMD.SEE (D28:F0/F1/F2/F3/F4/F5:04, bit 8) if a correctable error is reported by any of the devices in the hierarchy of this root port, including correctable errors in this root port. |

20.1.35 RSTS—Root Status Register (PCI Express—D28:F0/F1/F2/F3/F4/F5)

Address Offset: 60h–63h Attribute: R/WC, RO
 Default Value: 00000000h Size: 32 bits

| Bit | Description |
|-------|--------------------------------------------------------------------------------------------------------------------------------------------------------------------------------------------------------------------------------------------------|
| 31:18 | Reserved |
| 17 | PME Pending (PP) — RO. 0 = When the original PME is cleared by software, it will be set again, the requestor ID will be updated, and this bit will be cleared. 1 = Indicates another PME is pending when the PME status bit is set. |
| 16 | PME Status (PS) — R/WC. 0 = PME was not asserted. 1 = Indicates that PME was asserted by the requestor ID in RID. Subsequent PMEs are kept pending until this bit is cleared. |
| 15:0 | PME Requestor ID (RID) — RO. Indicates the PCI requestor ID of the last PME requestor. Valid only when PS is set. |



20.1.36 DCAP2—Device Capabilities 2 Register (Corporate Only) (PCI Express—D28:F0/F1/F2/F3/F4/F5)

Address Offset: 64h–67h Attribute: RO
Default Value: 00000016h Size: 32 bits

| Bit | Description |
|------|----------------------------------------------------------------------------------------------------------------------------------------------------------------------------------------------------------------------------------------------------------------------------------------------------------------|
| 31:5 | Reserved |
| 4 | Completion Timeout Disable Supported (CTDS) — RO. A value of 1b indicates support for the Completion Timeout Disable mechanism. |
| 3:0 | Completion Timeout Ranges Supported (CTRS) — RO. This field indicates device support for the optional Completion Timeout programmability mechanism. This mechanism allows system software to modify the Completion Timeout value. This field is hardwired to support 10 ms to 250 ms and 250 ms to 4 s. |

20.1.37 DCTL2—Device Control 2 Register (Corporate Only) (PCI Express—D28:F0/F1/F2/F3/F4/F5)

Address Offset: 68h–69h Attribute: RO, R/W
Default Value: 0000h Size: 16 bits

| Bit | Description |
|------|------------------------------------------------------------------------------------------------------------------------------------------------------------------------------------------------------------------------------------------------------------------------------------------------------------------------------------------------------------------------------------------------------------------------------------------------------------------------------------------------------------------------------------------------------------------------------------------------------------------------------------------------------------------------------------------------------------------------------------------------------------------------------------------------------------------------------------------------------------------------------------|
| 15:5 | Reserved |
| 4 | Completion Timeout Disable (CTD) — RW. When set to 1b, this bit disables the Completion Timeout mechanism. If there are outstanding requests when the bit is cleared, it is permitted but not required for hardware to apply the completion timeout mechanism to the outstanding requests. If this is done, it is permitted to base the start time for each request on either the time this bit was cleared or the time each request was issued. |
| 3:0 | Completion Timeout Value (CTV) — RW. This field allows system software to modify the Completion Timeout value. 0000b = 40–50 ms (Default) (specification range 50 us to 50 ms) 0101b = 40–50 ms (specification range is 16 ms to 55 ms) 0110b = 160–170 ms (specification range is 65 ms to 210 ms) 1001b = 400–500 ms (specification range is 260 ms to 900 ms) 1010b = 1.6–1.7 s (specification range is 1 s to 3.5 s) All other values are Reserved. NOTE: Software is permitted to change the value in this field at any time. For requests already pending when the Completion Timeout Value is changed, hardware is permitted to use either the new or the old value for the outstanding requests, and is permitted to base the start time for each request either on when this value was changed or on when each request was issued. |



20.1.41 MA—Message Signaled Interrupt Message Address Register (PCI Express—D28:F0/F1/F2/F3/F4/F5)

Address Offset: 84h–87h Attribute: R/W
Default Value: 00000000h Size: 32 bits

| Bit | Description |
|------|--------------------------------------------------------------------------------------------------------|
| 31:2 | Address (ADDR) — R/W. Lower 32 bits of the system specified message address, always DW aligned. |
| 1:0 | Reserved |

20.1.42 MD—Message Signaled Interrupt Message Data Register (PCI Express—D28:F0/F1/F2/F3/F4/F5)

Address Offset: 88h–89h Attribute: R/W
Default Value: 0000h Size: 16 bits

| Bit | Description |
|------|---------------------------------------------------------------------------------------------------------------------------------------------------------------------------------------------------------------------|
| 15:0 | Data (DATA) — R/W. This 16-bit field is programmed by system software if MSI is enabled. Its content is driven onto the lower word (PCI AD[15:0]) during the data phase of the MSI memory write transaction. |

20.1.43 SVCAP—Subsystem Vendor Capability Register (PCI Express—D28:F0/F1/F2/F3/F4/F5)

Address Offset: 90h–91h Attribute: RO
Default Value: A00Dh Size: 16 bits

| Bit | Description |
|------|-------------------------------------------------------------------------------------------------------------------|
| 15:8 | Next Capability (NEXT) — RO. Indicates the location of the next pointer in the list. |
| 7:0 | Capability Identifier (CID) — RO. Value of 0Dh indicates this is a PCI bridge subsystem vendor capability. |

20.1.44 SVID—Subsystem Vendor Identification Register (PCI Express—D28:F0/F1/F2/F3/F4/F5)

Address Offset: 94h–97h Attribute: R/WO
Default Value: 00000000h Size: 32 bits

| Bit | Description |
|-------|-------------------------------------------------------------------------------------------------------------------------------------------------------------------------------------------------|
| 31:16 | Subsystem Identifier (SID) — R/WO. Indicates the subsystem as identified by the vendor. This field is write once and is locked down until a bridge reset occurs (not the PCI bus reset). |
| 15:0 | Subsystem Vendor Identifier (SVID) — R/WO. Indicates the manufacturer of the subsystem. This field is write once and is locked down until a bridge reset occurs (not the PCI bus reset). |



20.1.47 PMCS—PCI Power Management Control and Status Register (PCI Express—D28:F0/F1/F2/F3/F4/F5)

Address Offset: A4h–A7h Attribute: R/W, RO
 Default Value: 00000000h Size: 32 bits

| Bit | Description |
|-------|-------------------------------------------------------------------------------------------------------------------------------------------------------------------------------------------------------------------------------------------------------------------------------------------------------------------------------------------------------------------------------------------------------------------------------------------------------------------------------------------------------------------------------------------------------------------------------------------------------------------------------------------|
| 31:24 | Reserved |
| 23 | Bus Power / Clock Control Enable (BPCE) — Reserved per <i>PCI Express* Base Specification, Revision 1.0a</i> . |
| 22 | B2/B3 Support (B23S) — Reserved per <i>PCI Express* Base Specification, Revision 1.0a</i> . |
| 21:16 | Reserved |
| 15 | PME Status (PMES) — RO. 1 = Indicates a PME was received on the downstream link. |
| 14:9 | Reserved |
| 8 | PME Enable (PMEE) — R/W. 1 = Indicates PME is enabled. The root port takes no action on this bit, but it must be R/W for some legacy operating systems to enable PME# on devices connected to this root port. This bit is sticky and resides in the resume well. The reset for this bit is RSMRST# which is not asserted during a warm reset. |
| 7:2 | Reserved |
| 1:0 | Power State (PS) — R/W. This field is used both to determine the current power state of the root port and to set a new power state. The values are: 00 = D0 state 11 = D3 _{HOT} state NOTE: When in the D3 _{HOT} state, the controller's configuration space is available, but the I/O and memory spaces are not. Type 1 configuration cycles are also not accepted. Interrupts are not required to be blocked as software will disable interrupts prior to placing the port into D3 _{HOT} . If software attempts to write a '10' or '01' to these bits, the write will be ignored. |



20.1.49 MPC—Miscellaneous Port Configuration Register (PCI Express—D28:F0/F1/F2/F3/F4/F5)

Address Offset: D8h–DBh Attribute: R/W, RO
 Default Value: 08110000h Size: 32 bits

| Bit | Description |
|-----|-----------------------------------------------------------------------------------------------------------------------------------------------------------------------------------------------------------------------------------------------------------------------------------------------------------------------------------------------------------------------------------------------------------------------------------------------------------------------------------------------------------------------------------------------------------|
| 31 | Power Management SCI Enable (PMCE) — R/W. 0 = SCI generation based on a power management event is disabled. 1 = Enables the root port to generate SCI whenever a power management event is detected. |
| 30 | Hot Plug SCI Enable (HPCE) — R/W. 0 = SCI generation based on a Hot-Plug event is disabled. 1 = Enables the root port to generate SCI whenever a Hot-Plug event is detected. |
| 29 | Link Hold Off (LHO) — R/W. 1 = Port will not take any TLP. This is used during loopback mode to fill up the downstream queue. |
| 28 | Address Translator Enable (ATE) — R/W. This bit is used to enable address translation via the AT bits in this register during loopback mode. 0 = Disable 1 = Enable |
| 27 | Lane Reversal (LR) — R/O. Consumer Only: This register reads the setting of the SATALED# strap. Corporate Only: This register reads the setting of the PCIELR1 Soft Strap. 0 = PCI Express Lanes 0-3 are reversed. 1 = No Lane reversal (default). NOTE: The port configuration straps must be set such that Port 1 is configured as a x4 port using lanes 0-3 when Lane Reversal is enabled. x2 lane reversal is not supported. NOTE: This register is only valid on port 1. |
| 26 | Invalid Receive Bus Number Check Enable (IRBNCE) — R/W. When set, the receive transaction layer will signal an error if the bus number of a Memory request does not fall within the range between SCBN and SBBN. If this check is enabled and the request is a memory write, it is treated as an Unsupported Request. If this check is enabled and the request is a non-posted memory read request, the request is considered a Malformed TLP and a fatal error. Messages, I/O, Config, and Completions are never checked for valid bus number. |
| 25 | Invalid Receive Range Check Enable (IRRCE) — R/W. When set, the receive transaction layer will treat the TLP as an Unsupported Request error if the address range of a Memory request does not outside the range between prefetchable and non-prefetchable base and limit. Messages, I/O, Configuration, and Completions are never checked for valid address ranges. |
| 24 | BME Receive Check Enable (BMERCE) — R/W. When set, the receive transaction layer will treat the TLP as an Unsupported Request error if a memory read or write request is received and the Bus Master Enable bit is not set. Messages, IO, Config, and Completions are never checked for BME. |
| 23 | Reserved |



| Bit | Description | | | | | | | | | | | | | | |
|--------|-------------------------------------------------------------------------------------------------------------------------------------------------------------------------------------------------------------------------------------------------------------------------------------------------------------------------------------------------------------------------------------------------------------------------------------------------------------------------------------------------------------------------------------------------------------------------------------------------------------------------------------------------|--------|---------|---|-------------------------|---|-------------------------|---|-------------------------|---|-------------------------|---|-------------------------|---|-------------------------|
| 22 | <p>Detect Override (FORCEDET) — R/W.</p> <p>0 = Normal operation. Detected output from AFE is sampled for presence detection.</p> <p>1 = Override mode. Ignores AFE detect output and link training proceeds as if a device were detected.</p> | | | | | | | | | | | | | | |
| 21 | <p>Flow Control During L1 Entry (FCDL1E) — R/W.</p> <p>0 = No flow control update DLLPs sent during L1 Ack transmission.</p> <p>1 = Flow control update DLLPs sent during L1 Ack transmission as required to meet the 30 μs periodic flow control update.</p> | | | | | | | | | | | | | | |
| 20:18 | <p>Unique Clock Exit Latency (UCEL) — R/W. This value represents the L0s Exit Latency for unique-clock configurations (LCTL.CCC = 0) (D28:F0/F1/F2/F3/F4/F5:Offset 50h:bit 6). It defaults to 512 ns to less than 1 μs, but may be overridden by BIOS.</p> | | | | | | | | | | | | | | |
| 17:15 | <p>Common Clock Exit Latency (CCEL) — R/W. This value represents the L0s Exit Latency for common-clock configurations (LCTL.CCC = 1) (D28:F0/F1/F2/F3/F4/F5:Offset 50h:bit 6). It defaults to 128 ns to less than 256 ns, but may be overridden by BIOS.</p> | | | | | | | | | | | | | | |
| 14:8 | Reserved | | | | | | | | | | | | | | |
| 7 | <p>Port I/OxApic Enable (PAE) — R/W.</p> <p>0 = Hole is disabled.</p> <p>1 = A range is opened through the bridge for the following memory addresses:</p> <table border="1" style="margin-left: 40px;"> <thead> <tr> <th>Port #</th> <th>Address</th> </tr> </thead> <tbody> <tr> <td>1</td> <td>FEC1_0000h – FEC1_7FFFh</td> </tr> <tr> <td>2</td> <td>FEC1_8000h – FEC1_FFFFh</td> </tr> <tr> <td>3</td> <td>FEC2_0000h – FEC2_7FFFh</td> </tr> <tr> <td>4</td> <td>FEC2_8000h – FEC2_FFFFh</td> </tr> <tr> <td>5</td> <td>FEC3_0000h – FEC3_7FFFh</td> </tr> <tr> <td>6</td> <td>FEC3_8000h – FEC3_FFFFh</td> </tr> </tbody> </table> | Port # | Address | 1 | FEC1_0000h – FEC1_7FFFh | 2 | FEC1_8000h – FEC1_FFFFh | 3 | FEC2_0000h – FEC2_7FFFh | 4 | FEC2_8000h – FEC2_FFFFh | 5 | FEC3_0000h – FEC3_7FFFh | 6 | FEC3_8000h – FEC3_FFFFh |
| Port # | Address | | | | | | | | | | | | | | |
| 1 | FEC1_0000h – FEC1_7FFFh | | | | | | | | | | | | | | |
| 2 | FEC1_8000h – FEC1_FFFFh | | | | | | | | | | | | | | |
| 3 | FEC2_0000h – FEC2_7FFFh | | | | | | | | | | | | | | |
| 4 | FEC2_8000h – FEC2_FFFFh | | | | | | | | | | | | | | |
| 5 | FEC3_0000h – FEC3_7FFFh | | | | | | | | | | | | | | |
| 6 | FEC3_8000h – FEC3_FFFFh | | | | | | | | | | | | | | |
| 6:3 | Reserved | | | | | | | | | | | | | | |
| 2 | <p>Bridge Type (BT) — RO. This register can be used to modify the Base Class and Header Type fields from the default P2P bridge to a Host Bridge. Having the root port appear as a Host Bridge is useful in some server configurations.</p> <p>0 = The root port bridge type is a P2P Bridge, Header Sub-Class = 04h, and Header Type = Type 1.</p> <p>1 = The root port bridge type is a P2P Bridge, Header Sub-Class = 00h, and Header Type = Type 0.</p> | | | | | | | | | | | | | | |
| 1 | <p>Hot Plug SMI Enable (HPME) — R/W.</p> <p>0 = SMI generation based on a Hot-Plug event is disabled.</p> <p>1 = Enables the root port to generate SMI whenever a Hot-Plug event is detected.</p> | | | | | | | | | | | | | | |
| 0 | <p>Power Management SMI Enable (PMME) — R/W.</p> <p>0 = SMI generation based on a power management event is disabled.</p> <p>1 = Enables the root port to generate SMI whenever a power management event is detected.</p> | | | | | | | | | | | | | | |

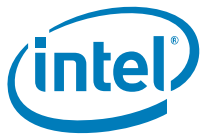

20.1.53 VCH—Virtual Channel Capability Header Register (PCI Express—D28:F0/F1/F2/F3/F4/F5)

Address Offset: 100h–103h Attribute: RWO
 Default Value: 18010002h Size: 32 bits

| Bit | Description |
|-------|------------------------------------------------------------------------------------------------------------------------------------------------------------------------------------------------------------------------------------------------------------------------------------------------------------------------------------------|
| 31:20 | Next Capability Offset (NCO) — R/WO. Indicates the next item in the list. 000h = Does not support Root Complex Topology Capability Structure. 180h = Supports Root Complex Topology Capability Structure. |
| 19:16 | Capability Version (CV) — R/WO. Indicates the version of the capability structure by the PCI SIG. 0h = Does not support PCI Express virtual Channel capability and the Root complex topology Capability Structure. 1h = Supports PCI Express virtual Channel capability and the Root complex topology Capability Structure. |
| 15:0 | Capability ID (CID) — R/WO. Indicates this is the Virtual Channel capability item. 0000h = Does not support PCI Express virtual Channel capability and the Root complex topology Capability Structure. 0002h = Supports PCI Express virtual Channel capability and the Root complex topology Capability Structure. |

20.1.54 VCAP2—Virtual Channel Capability 2 Register (PCI Express—D28:F0/F1/F2/F3/F4/F5)

Address Offset: 108h–10Bh Attribute: RO
 Default Value: 00000001h Size: 32 bits

| Bit | Description |
|-------|-------------------------------------------------------------------------------------------------------------------------|
| 31:24 | VC Arbitration Table Offset (ATO) — RO. Indicates that no table is present for VC arbitration since it is fixed. |
| 23:0 | Reserved. |

20.1.55 PVC—Port Virtual Channel Control Register (PCI Express—D28:F0/F1/F2/F3/F4/F5)

Address Offset: 10Ch–10Dh Attribute: R/W
 Default Value: 0000h Size: 16 bits

| Bit | Description |
|------|---------------------------------------------------------------------------------------------------------------------------------------------------------------------------------------------------------------|
| 15:4 | Reserved. |
| 3:1 | VC Arbitration Select (AS) — R/W. Indicates which VC should be programmed in the VC arbitration table. The root port takes no action on the setting of this field since there is no arbitration table. |
| 0 | Load VC Arbitration Table (LAT) — R/W. Indicates that the table programmed should be loaded into the VC arbitration table. This bit always returns 0 when read. |



20.1.56 PVS—Port Virtual Channel Status Register (PCI Express—D28:F0/F1/F2/F3/F4/F5)

Address Offset: 10Eh–10Fh Attribute: RO
 Default Value: 0000h Size: 16 bits

| Bit | Description |
|------|---------------------------------------------------------------------------------------------------------------------------------------------------------------------------------------------------------------------|
| 15:1 | Reserved. |
| 0 | VC Arbitration Table Status (VAS) — RO. Indicates the coherency status of the VC Arbitration table when it is being updated. This field is always 0 in the root port since there is no VC arbitration table. |

20.1.57 VOCAP—Virtual Channel 0 Resource Capability Register (PCI Express—D28:F0/F1/F2/F3/F4/F5)

Address Offset: 110h–113h Attribute: RO
 Default Value: 00000001h Size: 32 bits

| Bit | Description |
|-------|---------------------------------------------------------------------------------------------------------------------------------------|
| 31:24 | Port Arbitration Table Offset (AT) — RO. This VC implements no port arbitration table since the arbitration is fixed. |
| 23 | Reserved. |
| 22:16 | Maximum Time Slots (MTS) — RO. This VC implements fixed arbitration; therefore, this field is not used. |
| 15 | Reject Snoop Transactions (RTS) — RO. This VC must be able to take snoopable transactions. |
| 14 | Advanced Packet Switching (APS) — RO. This VC is capable of all transactions, not just advanced packet switching transactions. |
| 13:8 | Reserved. |
| 7:0 | Port Arbitration Capability (PAC) — RO. Indicates that this VC uses fixed port arbitration. |



20.1.58 VOCTL—Virtual Channel 0 Resource Control Register (PCI Express—D28:F0/F1/F2/F3/F4/F5)

Address Offset: 114h–117h Attribute: R/W, RO
 Default Value: 800000FFh Size: 32 bits

| Bit | Description |
|----------------------------------------------------|-----------------------------------------------------------------------------------------------------------------------------------------------------------------------------------------------------------------|
| 31 | Virtual Channel Enable (EN) — RO. Always set to 1. Virtual Channel 0 cannot be disabled. |
| 30:27 | Reserved. |
| 26:24 | Virtual Channel Identifier (VCID) — RO. Indicates the ID to use for this virtual channel. |
| 23:20 | Reserved. |
| 19:17 | Port Arbitration Select (PAS) — R/W. Indicates which port table is being programmed. The root complex takes no action on this setting since the arbitration is fixed and there is no arbitration table. |
| 16 | Load Port Arbitration Table (LAT) — RO. The root port does not implement an arbitration table for this virtual channel. |
| 15:8 | Reserved. |
| 7:1 | Transaction Class / Virtual Channel Map (TVM) — R/W. Indicates which transaction classes are mapped to this virtual channel. When a bit is set, this transaction class is mapped to the virtual channel. |
| | Bit Transaction Class |
| | 7 Transaction Class 7 |
| | 6 Transaction Class 6 |
| | 5 Transaction Class 5 |
| | 4 Transaction Class 4 |
| | 3 Transaction Class 3 |
| 2 Transaction Class 2 | |
| 1 Transaction Class 1 | |
| 0 | Reserved. Transaction class 0 must always mapped to VC0. |

20.1.59 VOSTS—Virtual Channel 0 Resource Status Register (PCI Express—D28:F0/F1/F2/F3/F4/F5)

Address Offset: 11Ah–11Bh Attribute: RO
 Default Value: 0000h Size: 16 bits

| Bit | Description |
|------|----------------------------------------------------------------------------------------------------------------------------------------------------------------|
| 15:2 | Reserved. |
| 1 | VC Negotiation Pending (NP) — RO. 0 = Negotiation is not pending. 1 = Indicates the Virtual Channel is still being negotiated with ingress ports. |
| 0 | Port Arbitration Tables Status (ATS) . There is no port arbitration table for this VC, so this bit is reserved as 0. |



20.1.60 UES—Uncorrectable Error Status Register (PCI Express—D28:F0/F1/F2/F3/F4/F5)

Address Offset: 144h–147h Attribute: R/WC, RO
 Default Value: 0000000000x0xxx0x0x0000000x0000b Size: 32 bits

This register maintains its state through a platform reset. It loses its state upon suspend.

| Bit | Description |
|-------|-----------------------------------------------------------------------------------------------------------------------------------------------------------------------------------------------------------------------------|
| 31:21 | Reserved |
| 20 | Unsupported Request Error Status (URE) — R/WC. Indicates an unsupported request was received. |
| 19 | ECRC Error Status (EE) — RO. ECRC is not supported. |
| 18 | Malformed TLP Status (MT) — R/WC. Indicates a malformed TLP was received. |
| 17 | Receiver Overflow Status (RO) — R/WC. Indicates a receiver overflow occurred. |
| 16 | Unexpected Completion Status (UC) — R/WC. Indicates an unexpected completion was received. |
| 15 | Completion Abort Status (CA) — R/WC. Indicates a completer abort was received. |
| 14 | Completion Timeout Status (CT) — R/WC. Indicates a completion timed out. This bit is set if Completion Timeout is enabled and a completion is not returned within the time specified by the Completion Timeout Value |
| 13 | Flow Control Protocol Error Status (FCPE) — RO. Flow Control Protocol Errors not supported. |
| 12 | Poisoned TLP Status (PT) — R/WC. Indicates a poisoned TLP was received. |
| 11:5 | Reserved |
| 4 | Data Link Protocol Error Status (DLPE) — R/WC. Indicates a data link protocol error occurred. |
| 3:1 | Reserved |
| 0 | Training Error Status (TE) — RO. Training Errors not supported. |



20.1.61 UEM—Uncorrectable Error Mask (PCI Express—D28:F0/F1/F2/F3/F4/F5)

Address Offset: 148h–14Bh Attribute: R/WO, RO
Default Value: 00000000h Size: 32 bits

When set, the corresponding error in the UES register is masked, and the logged error will cause no action. When cleared, the corresponding error is enabled.

| Bit | Description |
|-------|------------------------------------------------------------------------------------------------------------------------------------------------------------------------------------------------------------------------------------------|
| 31:21 | Reserved |
| 20 | Unsupported Request Error Mask (URE) — R/WO. 0 = The corresponding error in the UES register (D28:F0/F1/F2/F3/F4/F5:144) is enabled. 1 = The corresponding error in the UES register (D28:F0/F1/F2/F3/F4/F5:144) is masked. |
| 19 | ECRC Error Mask (EE) — RO. ECRC is not supported. |
| 18 | Malformed TLP Mask (MT) — R/WO. 0 = The corresponding error in the UES register (D28:F0/F1/F2/F3/F4/F5:144) is enabled. 1 = The corresponding error in the UES register (D28:F0/F1/F2/F3/F4/F5:144) is masked. |
| 17 | Receiver Overflow Mask (RO) — R/WO. 0 = The corresponding error in the UES register (D28:F0/F1/F2/F3/F4/F5:144) is enabled. 1 = The corresponding error in the UES register (D28:F0/F1/F2/F3/F4/F5:144) is masked. |
| 16 | Unexpected Completion Mask (UC) — R/WO. 0 = The corresponding error in the UES register (D28:F0/F1/F2/F3/F4/F5:144) is enabled. 1 = The corresponding error in the UES register (D28:F0/F1/F2/F3/F4/F5:144) is masked. |
| 15 | Completion Abort Mask (CA) — R/WO. 0 = The corresponding error in the UES register (D28:F0/F1/F2/F3/F4/F5:144) is enabled. 1 = The corresponding error in the UES register (D28:F0/F1/F2/F3/F4/F5:144) is masked. |
| 14 | Completion Timeout Mask (CT) — R/WO. 0 = The corresponding error in the UES register (D28:F0/F1/F2/F3/F4/F5:144) is enabled. 1 = The corresponding error in the UES register (D28:F0/F1/F2/F3/F4/F5:144) is masked. |
| 13 | Flow Control Protocol Error Mask (FCPE) — RO. Flow Control Protocol Errors not supported. |
| 12 | Poisoned TLP Mask (PT) — R/WO. 0 = The corresponding error in the UES register (D28:F0/F1/F2/F3/F4/F5:144) is enabled. 1 = The corresponding error in the UES register (D28:F0/F1/F2/F3/F4/F5:144) is masked. |
| 11:5 | Reserved |



| Bit | Description |
|-----|------------------------------------------------------------------------------------------------------------------------------------------------------------------------------------------------------------------------------------------|
| 4 | Data Link Protocol Error Mask (DLPE) — R/WO. 0 = The corresponding error in the UES register (D28:F0/F1/F2/F3/F4/F5:144) is enabled. 1 = The corresponding error in the UES register (D28:F0/F1/F2/F3/F4/F5:144) is masked. |
| 3:1 | Reserved |
| 0 | Training Error Mask (TE) — RO. Training Errors not supported |

20.1.62 UEV — Uncorrectable Error Severity (PCI Express—D28:F0/F1/F2/F3/F4/F5)

Address Offset: 14Ch–14Fh Attribute: RO
 Default Value: 00060011h Size: 32 bits

| Bit | Description |
|-------|---------------------------------------------------------------------------------------------------------------------------|
| 31:21 | Reserved |
| 20 | Unsupported Request Error Severity (URE) — RO. 0 = Error considered non-fatal. (Default) 1 = Error is fatal. |
| 19 | ECRC Error Severity (EE) — RO. ECRC is not supported. |
| 18 | Malformed TLP Severity (MT) — RO. 0 = Error considered non-fatal. 1 = Error is fatal. (Default) |
| 17 | Receiver Overflow Severity (RO) — RO. 0 = Error considered non-fatal. 1 = Error is fatal. (Default) |
| 16 | Unexpected Completion Severity (UC) — RO. 0 = Error considered non-fatal. (Default) 1 = Error is fatal. |
| 15 | Completion Abort Severity (CA) — RO. 0 = Error considered non-fatal. (Default) 1 = Error is fatal. |
| 14 | Completion Timeout Severity (CT) — RO. 0 = Error considered non-fatal. (Default) 1 = Error is fatal. |
| 13 | Flow Control Protocol Error Severity (FCPE) — RO. Flow Control Protocol Errors not supported. |
| 12 | Poisoned TLP Severity (PT) — RO. 0 = Error considered non-fatal. (Default) 1 = Error is fatal. |
| 11:5 | Reserved |
| 4 | Data Link Protocol Error Severity (DLPE) — RO. 0 = Error considered non-fatal. 1 = Error is fatal. (Default) |
| 3:1 | Reserved |
| 0 | Training Error Severity (TE) — RO. TE is not supported. |



20.1.63 CES — Correctable Error Status Register (PCI Express—D28:F0/F1/F2/F3/F4/F5)

Address Offset: 150h–153h Attribute: R/WC
 Default Value: 00000000h Size: 32 bits

| Bit | Description |
|-------|--------------------------------------------------------------------------------------------------------------------------------------------------|
| 31:14 | Reserved |
| 13 | Advisory Non-Fatal Error Status (ANFES) — R/WC. 0 = Advisory Non-Fatal Error did not occur. 1 = Advisory Non-Fatal Error did occur. |
| 12 | Replay Timer Timeout Status (RTT) — R/WC. Indicates the replay timer timed out. |
| 11:9 | Reserved |
| 8 | Replay Number Rollover Status (RNR) — R/WC. Indicates the replay number rolled over. |
| 7 | Bad DLLP Status (BD) — R/WC. Indicates a bad DLLP was received. |
| 6 | Bad TLP Status (BT) — R/WC. Indicates a bad TLP was received. |
| 5:1 | Reserved |
| 0 | Receiver Error Status (RE) — R/WC. Indicates a receiver error occurred. |

20.1.64 CEM — Correctable Error Mask Register (PCI Express—D28:F0/F1/F2/F3/F4/F5)

Address Offset: 154h–157h Attribute: R/WO
 Default Value: 00000000h Size: 32 bits

When set, the corresponding error in the CES register is masked, and the logged error will cause no action. When cleared, the corresponding error is enabled.

| Bit | Description |
|-------|--------------------------------------------------------------------------------------------------------------------------------------------------------------------------------------------------------------------------------------------------------------------------------------------------------------------------------------------------------------------------------------------------------------------------------------------------------------------------------------------------------------------------------------------------------------------|
| 31:14 | Reserved |
| 13 | Advisory Non-Fatal Error Mask (ANFEM) — R/WO. 0 = Does not mask Advisory Non-Fatal errors. 1 = Masks Advisory Non-Fatal errors from (a) signaling ERR_COR to the device control register and (b) updating the Uncorrectable Error Status register. This register is set by default to enable compatibility with software that does not comprehend Role-Based Error Reporting. NOTE: The correctable error detected bit in device status register is set whenever the Advisory Non-Fatal error is detected, independent of this mask bit. |
| 12 | Replay Timer Timeout Mask (RTT) — R/WO. Mask for replay timer timeout. |
| 11:9 | Reserved |
| 8 | Replay Number Rollover Mask (RNR) — R/WO. Mask for replay number rollover. |
| 7 | Bad DLLP Mask (BD) — R/WO. Mask for bad DLLP reception. |
| 6 | Bad TLP Mask (BT) — R/WO. Mask for bad TLP reception. |
| 5:1 | Reserved |
| 0 | Receiver Error Mask (RE) — R/WO. Mask for receiver errors. |



20.1.65 AECC — Advanced Error Capabilities and Control Register (PCI Express—D28:F0/F1/F2/F3/F4/F5)

Address Offset: 158h–15Bh Attribute: RO
 Default Value: 00000000h Size: 32 bits

| Bit | Description |
|------|------------------------------------------------------------|
| 31:9 | Reserved |
| 8 | ECRC Check Enable (ECE) — RO. ECRC is not supported. |
| 7 | ECRC Check Capable (ECC) — RO. ECRC is not supported. |
| 6 | ECRC Generation Enable (EGE) — RO. ECRC is not supported. |
| 5 | ECRC Generation Capable (EGC) — RO. ECRC is not supported. |
| 4:0 | First Error Pointer (FEP) — RO. |

20.1.66 RES — Root Error Status Register (PCI Express—D28:F0/F1/F2/F3/F4/F5)

Address Offset: 170h–173h Attribute: R/WC, RO
 Default Value: 00000000h Size: 32 bits

| Bit | Description |
|-------|----------------------------------------------------------------------------------------------------------------------------------------------------|
| 31:27 | Advanced Error Interrupt Message Number (AEMN) — RO. There is only one error interrupt allocated. |
| 26:4 | Reserved |
| 3 | Multiple ERR_FATAL/NONFATAL Received (MENR) — RO. For Intel® ICH10, only one error will be captured. |
| 2 | ERR_FATAL/NONFATAL Received (ENR) — R/WC. 0 = No error message received. 1 = Either a fatal or a non-fatal error message is received. |
| 1 | Multiple ERR_COR Received (MCR) — RO. For ICH10, only one error will be captured. |
| 0 | ERR_COR Received (CR) — R/WC. 0 = No error message received. 1 = A correctable error message is received. |

20.1.67 RCTCL — Root Complex Topology Capability List Register (PCI Express—D28:F0/F1/F2/F3/F4/F5)

Address Offset: 180–183h Attribute: RO
 Default Value: 00010005h Size: 32 bits

| Bit | Description |
|-------|-----------------------------------------------------------------------------------------------------|
| 31:20 | Next Capability (NEXT) — RO. Indicates the next item in the list, in this case, end of list. |
| 19:16 | Capability Version (CV) — RO. Indicates the version of the capability structure. |
| 15:0 | Capability ID (CID) — RO. Indicates this is a root complex topology capability. |



20.1.68 ESD—Element Self Description Register (PCI Express—D28:F0/F1/F2/F3/F4/F5)

Address Offset: 184h–187h Attribute: RO
 Default Value: See Description Size: 32 bits

| Bit | Description | | | | | | | | | | | | | | |
|--------|---------------------------------------------------------------------------------------------------------------------------------------------------------------------------------------------------------------------------------------------------------------------------------------------------------------------------------------------------------------------------------------------------------------------------------------------------------|--------|-------|---|-----|---|-----|---|-----|---|-----|---|-----|---|-----|
| 31:24 | <p>Port Number (PN) — RO. Indicate the ingress port number for the root port. There is a different value per port:</p> <table border="1"> <thead> <tr> <th>Port #</th> <th>Value</th> </tr> </thead> <tbody> <tr> <td>1</td> <td>01h</td> </tr> <tr> <td>2</td> <td>02h</td> </tr> <tr> <td>3</td> <td>03h</td> </tr> <tr> <td>4</td> <td>04h</td> </tr> <tr> <td>5</td> <td>05h</td> </tr> <tr> <td>6</td> <td>06h</td> </tr> </tbody> </table> | Port # | Value | 1 | 01h | 2 | 02h | 3 | 03h | 4 | 04h | 5 | 05h | 6 | 06h |
| Port # | Value | | | | | | | | | | | | | | |
| 1 | 01h | | | | | | | | | | | | | | |
| 2 | 02h | | | | | | | | | | | | | | |
| 3 | 03h | | | | | | | | | | | | | | |
| 4 | 04h | | | | | | | | | | | | | | |
| 5 | 05h | | | | | | | | | | | | | | |
| 6 | 06h | | | | | | | | | | | | | | |
| 23:16 | <p>Component ID (CID) — RO. This field returns the value of the ESD.CID field (Chipset Config Space: Offset 0104h:bits 23:16) of the chip configuration section, that is programmed by platform BIOS, since the root port is in the same component as the RCRB.</p> | | | | | | | | | | | | | | |
| 15:8 | <p>Number of Link Entries (NLE) — RO. The default value of 01h indicates one link entry (corresponding to the RCRB).</p> | | | | | | | | | | | | | | |
| 7:4 | Reserved. | | | | | | | | | | | | | | |
| 3:0 | <p>Element Type (ET) — RO. The default value of 0h indicates that the element type is a root port.</p> | | | | | | | | | | | | | | |

20.1.69 ULD — Upstream Link Description Register (PCI Express—D28:F0/F1/F2/F3/F4/F5)

Address Offset: 190h–193h Attribute: RO
 Default Value: 00000001h Size: 32 bits

| Bit | Description |
|-------|------------------------------------------------------------------------------------------------------------------------------------------------------------------------------------------------------------------------------------------------------------------------------------|
| 31:24 | <p>Target Port Number (PN) — RO. Indicates the port number of the RCRB.</p> |
| 23:16 | <p>Target Component ID (TCID) — RO. This field returns the value of the ESD.CID field (Chipset Config Space: Offset 0104h:bits 23:16) of the chip configuration section, that is programmed by platform BIOS, since the root port is in the same component as the RCRB.</p> |
| 15:2 | Reserved. |
| 1 | <p>Link Type (LT) — RO. Indicates that the link points to the Intel® ICH10 RCRB.</p> |
| 0 | <p>Link Valid (LV) — RO. Indicates that this link entry is valid.</p> |



21 High Precision Event Timer Registers

The timer registers are memory-mapped in a non-indexed scheme. This allows the processor to directly access each register without having to use an index register. The timer register space is 1024 bytes. The registers are generally aligned on 64-bit boundaries to simplify implementation with IA64 processors. There are four possible memory address ranges beginning at 1) FED0_0000h, 2) FED0_1000h, 3) FED0_2000h, 4) FED0_3000h. The choice of address range will be selected by configuration bits in the High Precision Timer Configuration Register (Chipset Config Registers: Offset 3404h).

Behavioral Rules:

1. Software must not attempt to read or write across register boundaries. For example, a 32-bit access should be to offset x0h, x4h, x8h, or xCh. 32-bit accesses should not be to 01h, 02h, 03h, 05h, 06h, 07h, 09h, 0Ah, 0Bh, 0Dh, 0Eh, or 0Fh. Any accesses to these offsets will result in an unexpected behavior, and may result in a master abort. However, these accesses should not result in system hangs. 64-bit accesses can only be to x0h and must not cross 64-bit boundaries.
2. Software should not write to read-only registers.
3. Software should not expect any particular or consistent value when reading reserved registers or bits.

21.1 Memory Mapped Registers

Table 21-1. Memory-Mapped Registers (Sheet 1 of 2)

| Offset | Mnemonic | Register | Default | Type |
|----------|-----------|-----------------------------------------|-----------------------|-----------|
| 000–007h | GCAP_ID | General Capabilities and Identification | 0429B17F8 086A201h | RO |
| 008–00Fh | — | Reserved | — | — |
| 010–017h | GEN_CONF | General Configuration | 00000000 00000000h | R/W |
| 018–01Fh | — | Reserved | — | — |
| 020–027h | GINTR_STA | General Interrupt Status | 00000000 00000000h | R/WC, R/W |
| 028–0EFh | — | Reserved | — | — |
| 0F0–0F7h | MAIN_CNT | Main Counter Value | N/A | R/W |
| 0F8–0FFh | — | Reserved | — | — |
| 100–107h | TIMO_CONF | Timer 0 Configuration and Capabilities | N/A | R/W, RO |
| 108–10Fh | TIMO_COMP | Timer 0 Comparator Value | N/A | R/W |
| 110–11Fh | — | Reserved | — | — |
| 120–127h | TIM1_CONF | Timer 1 Configuration and Capabilities | N/A | R/W, RO |



Table 21-1. Memory-Mapped Registers (Sheet 2 of 2)

| Offset | Mnemonic | Register | Default | Type |
|------------------------------|-----------|----------------------------------------|---------|---------|
| 128–12Fh | TIM1_COMP | Timer 1 Comparator Value | N/A | R/W |
| 130–13Fh | — | Reserved | — | — |
| 140–147h | TIM2_CONF | Timer 2 Configuration and Capabilities | N/A | R/W, RO |
| 148–14Fh | TIM2_COMP | Timer 2 Comparator Value | N/A | R/W |
| 150–15Fh | — | Reserved | — | — |
| 160–167h | TIM3_CONG | Timer 3 Configuration and Capabilities | N/A | R/W, RO |
| 168–16Fh | TIM3_COMP | Timer 3 Comparator Value | N/A | R/W |
| 170–3FFh (Consumer Only) | — | Reserved | — | — |
| 180–187h (Corporate Only) | TIM4_CONG | Timer 4 Configuration and Capabilities | N/A | R/W, RO |
| 188–18Fh (Corporate Only) | TIM4_COMP | Timer 4 Comparator Value | N/A | R/W |
| 190–19Fh (Corporate Only) | — | Reserved | — | — |
| 1A0–1A7h (Corporate Only) | TIM5_CONG | Timer 5 Configuration and Capabilities | N/A | R/W, RO |
| 1A8–1AFh (Corporate Only) | TIM5_COMP | Timer 5 Comparator Value | N/A | R/W |
| 1B0–1BFh (Corporate Only) | — | Reserved | — | — |
| 1C0–1C7h (Corporate Only) | TIM6_CONG | Timer 6 Configuration and Capabilities | N/A | R/W, RO |
| 1C8–1CFh (Corporate Only) | TIM6_COMP | Timer 6 Comparator Value | N/A | R/W |
| 1D0–1DFh (Corporate Only) | — | Reserved | — | — |
| 1E0–1E7h (Corporate Only) | TIM7_CONG | Timer 7 Configuration and Capabilities | N/A | R/W, RO |
| 1E8–1EFh (Corporate Only) | TIM7_COMP | Timer 7 Comparator Value | N/A | R/W |
| 1F0–19Fh (Corporate Only) | — | Reserved | — | — |
| 200–3FFh (Corporate Only) | — | Reserved | — | — |

NOTES:

1. Reads to reserved registers or bits will return a value of 0.
2. Software must not attempt locks to the memory-mapped I/O ranges for High Precision Event Timers. If attempted, the lock is not honored, which means potential deadlock conditions may occur.



21.1.1 GCAP_ID—General Capabilities and Identification Register

Address Offset: 00h Attribute: RO
 Default Value: 0429B17F8086A201h Size: 64 bits

| Bit | Description |
|-------|-----------------------------------------------------------------------------------------------------------------------------------------------------------------------------------------------------------------------------------------------------------------|
| 63:32 | Main Counter Tick Period (COUNTER_CLK_PER_CAP) — RO. This field indicates the period at which the counter increments in femptoseconds (10^{-15} seconds). This will return 0429B17F when read. This indicates a period of 69841279 fs (69.841279 ns). |
| 31:16 | Vendor ID Capability (VENDOR_ID_CAP) — RO. This is a 16-bit value assigned to Intel. |
| 15 | Legacy Replacement Rout Capable (LEG_RT_CAP) — RO. Hardwired to 1. Legacy Replacement Interrupt Rout option is supported. |
| 14 | Reserved. This bit returns 0 when read. |
| 13 | Counter Size Capability (COUNT_SIZE_CAP) — RO. Hardwired to 1. Counter is 64-bit wide. |
| 12:8 | Number of Timer Capability (NUM_TIM_CAP) — RO. This field indicates the number of timers in this block. 03h = Four timers. (Consumer Only) 07h = Eight timers. (Corporate Only) |
| 7:0 | Revision Identification (REV_ID) — RO. This indicates which revision of the function is implemented. Default value will be 01h. |



| Bit | Description |
|-----|------------------------------------------------------------------------------------------------------------------------------------------------------------------------------------------------------------------------------------------------------------------------------------------------------------------------------------------------------------------------------------------------------------------------------------------------------------------------------------------------------------------------------------------------------------------------------------------------------------------------------------------------------------------------------------------------------------------|
| 2 | Timer 2 Interrupt Active (T02_INT_STS) — R/W. Same functionality as Timer 0. |
| 1 | Timer 1 Interrupt Active (T01_INT_STS) — R/W. Same functionality as Timer 0. |
| 0 | <p>Timer 0 Interrupt Active (T00_INT_STS) — R/WC. The functionality of this bit depends on whether the edge or level-triggered mode is used for this timer. (default = 0)</p> <p>If set to level-triggered mode: This bit will be set by hardware if the corresponding timer interrupt is active. Once the bit is set, it can be cleared by software writing a 1 to the same bit position. Writes of 0 to this bit will have no effect.</p> <p>If set to edge-triggered mode: This bit should be ignored by software. Software should always write 0 to this bit.</p> <p>NOTE: Defaults to 0. In edge triggered mode, this bit will always read as 0 and writes will have no effect.</p> |

21.1.4 MAIN_CNT—Main Counter Value Register

Address Offset: 0F0h
Default Value: N/A

Attribute: R/W
Size: 64 bits

| Bit | Description |
|------|--------------------------------------------------------------------------------------------------------------------------------------------------------------------------------------------------------------------------------------------------------------------------------------------------------------------------------------------------------------------------------------------------------------------------------------------------------------------------------------------------------------------------------------------------------------------------------------------------------------------------------------------------------------------------------------------------------------------------------------------------------------------------------------------------------------------------------------------------------------------------------------------------------------------------------------------------------------------------------|
| 63:0 | <p>Counter Value (COUNTER_VAL[63:0]) — R/W. Reads return the current value of the counter. Writes load the new value to the counter.</p> <p>NOTES:</p> <ol style="list-style-type: none"> Writes to this register should only be done while the counter is halted. Reads to this register return the current value of the main counter. 32-bit counters will always return 0 for the upper 32-bits of this register. If 32-bit software attempts to read a 64-bit counter, it should first halt the counter. Since this delays the interrupts for all of the timers, this should be done only if the consequences are understood. It is strongly recommended that 32-bit software only operate the timer in 32-bit mode. Reads to this register are monotonic. No two consecutive reads return the same value. The second of two reads always returns a larger value (unless the timer has rolled over to 0). |

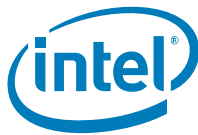

21.1.5 TIMn_CONF—Timer n Configuration and Capabilities Register

Address Offset: Timer 0: 100–107h Attribute: RO, R/W
 Timer 1: 120–127h
 Timer 2: 140–147h
 Timer 3: 160–167h
 Timer 4: 180–187h (Corporate Only)
 Timer 5: 1A0–1A7h (Corporate Only)
 Timer 6: 1C0–1C7h (Corporate Only)
 Timer 7: 1E0–1E7h (Corporate Only)

Default Value: N/A Size: 64 bit

Note: The letter n can be 0, 1, 2, 3, 4, 5, 6, or 7 (4, 5, 6, 7 Corporate Only) referring to Timer 0, 1, 2, 3, 4, 5, 6, or 7(4,5,6,7 Corporate Only).

| Bit | Description |
|---------------------|---------------------------------------------------------------------------------------------------------------------------------------------------------------------------------------------------------------------------------------------------------------------------------------------------------------------------------------------------------------------------------------------------------------------------------------------------------------------------------------------------------------------------------------------------------------------------------------------------------------------------------------------------------------------------------------------------------------------------------------------------------------------------------------------------------------------------------------------------------------------------------------------------------------------------------------------------------------------------------------------------------------------------------------|
| 63:56 | Reserved. These bits will return 0 when read. |
| 55:52, 43 | <p>Timer Interrupt Rout Capability (TIMERn_INT_ROUT_CAP) — RO.</p> <p>Timer 0, 1: Bits 52, 53, 54, and 55 in this field (corresponding to IRQ 20, 21, 22, and 23) have a value of 1. Writes will have no effect.</p> <p>Timer 2: Bits 43, 52, 53, 54, and 55 in this field (corresponding to IRQ 11, 20, 21, 22, and 23) have a value of 1. Writes will have no effect.</p> <p>Timer 3: Bits 44, 52, 53, 54, and 55 in this field (corresponding to IRQ 11, 20, 21, 22, and 23) have a value of 1. Writes will have no effect.</p> <p>Timer 4, 5, 6, 7 (Corporate Only). This field is always 0 as interrupts from these timers can only be delivered via direct FSB interrupt messages.</p> <p>NOTE: If IRQ 11 is used for HPET #2, software should ensure IRQ 11 is not shared with any other devices to ensure the proper operation of HPET #2.</p> <p>NOTE: If IRQ 12 is used for HPET #3, software should ensure IRQ 12 is not shared with any other devices to ensure the proper operation of HPET #3.</p> |
| 51:45, 42:16 | Reserved. These bits return 0 when read. |
| 15 (Corporate Only) | <p>TIMERn_FSB_INT_DEL_CAP: FSB Interrupt Delivery: (where n is the timer number: 00 to 07). If this read-only bit is 1, then the hardware supports a direct front-side bus delivery of this timer’s interrupt.</p> <p>Intel Specific: This bit is always read as 1, since the Intel ICH10 HPET implementation supports the direct FSB interrupt delivery.</p> |
| 15 (Consumer Only) | Reserved. This bit returns 0 when read. |
| 14 (Corporate Only) | <p>TIMERn_FSB_EN_CNF: (where n is the timer number: 00 to 07). If the TIMERn_FSB_INT_DEL_CAP bit is set for this timer, then the software can set the TIMERn_FSB_EN_CNF bit to force the interrupts to be delivered directly as FSB messages, rather than using the 8259 or I/O (x) APIC. In this case, the TIMERn_INT_ROUT_CNF field in this register will be ignored. The TIMERn_FSB_ROUT register will be used instead.</p> <p>Intel and Timer 0, 1, 2, 3 Specific: This bit is a read/write bit.</p> <p>Intel and Timer 4, 5, 6, 7 Specific: This bit is always Read Only 1 as interrupt from these timers can only be delivered via direct FSB interrupt messages.</p> |
| 14 (Consumer Only) | Reserved. This bit returns 0 when read. |



| Bit | Description |
|------|-------------------------------------------------------------------------------------------------------------------------------------------------------------------------------------------------------------------------------------------------------------------------------------------------------------------------------------------------------------------------------------------------------------------------------------------------------------------------------------------------------------------------------------------------------------------------------------------------------------------------------------------------------------------------------------------------------------------------------------------------------------------------------------------------------------------------------------------------------------------------------------------------------------------------------------------------------------------------------------------------------------------------------------------------------------------------------------------------------------------------------------------------------------------------------------------------------------------------------------------------------------------------------------------------------------------------------------------------------------------------------------------------------------------------------------------------------------------------------------------------------------------------------|
| 13:9 | <p>Interrupt Rout (TIMERn_INT_ROUT_CNF) — R/W. This 5-bit field indicates the routing for the interrupt to the 8259 or I/O (x) APIC. Software writes to this field to select which interrupt in the 8259 or I/O (x) will be used for this timer's interrupt. If the value is not supported by this particular timer, then the value read back will not match what is written. The software must only write valid values.</p> <p>Timer 4, 5, 6, 7 (Corporate Only): This field is Read-only and reads will return 0.</p> <p>NOTES:</p> <ol style="list-style-type: none"> 1. If the interrupt is handled via the 8259, only interrupts 0-15 are applicable and valid. Software must not program any value other than 0-15 in this field. 2. If the Legacy Replacement Rout bit is set, then Timers 0 and 1 will have a different routing, and this bit field has no effect for those two timers. 3. Timer 0,1: Software is responsible to make sure it programs a valid value (20, 21, 22, or 23) for this field. The ICH10 logic does not check the validity of the value written. 4. Timer 2: Software is responsible to make sure it programs a valid value (11, 20, 21, 22, or 23) for this field. The ICH10 logic does not check the validity of the value written. 5. Timer 3: Software is responsible to make sure it programs a valid value (12, 20, 21, 22, or 23) for this field. The ICH10 logic does not check the validity of the value written. |
| 8 | <p>Timer n 32-bit Mode (TIMERn_32MODE_CNF) — R/W or RO. Software can set this bit to force a 64-bit timer to behave as a 32-bit timer.</p> <p>Timer 0: Bit is read/write (default to 0). 0 = 64 bit; 1 = 32 bit</p> <p>Timers 1, 2, 3, 4, 5, 6, 7 (4, 5, 6, 7 Corporate Only): Hardwired to 0. Writes have no effect (since these two timers are 32-bits).</p> <p>NOTE: When this bit is set to 1, the hardware counter will do a 32-bit operation on comparator match and rollovers, thus the upper 32-bit of the Timer 0 Comparator Value register is ignored. The upper 32-bit of the main counter is not involved in any rollover from lower 32-bit of the main counter and becomes all zeros.</p> |
| 7 | Reserved. This bit returns 0 when read. |
| 6 | <p>Timer n Value Set (TIMERn_VAL_SET_CNF) — R/W. Software uses this bit only for Timer 0 if it has been set to periodic mode. By writing this bit to a 1, the software is then allowed to directly set the timer's accumulator. Software does not have to write this bit back to 1 (it automatically clears).</p> <p>Software should not write a 1 to this bit position if the timer is set to non-periodic mode.</p> <p>NOTE: This bit will return 0 when read. Writes will only have an effect for Timer 0 if it is set to periodic mode. Writes will have no effect for Timers 1, 2, 3, 4, 5, 6, 7 (4, 5, 6, 7 Corporate Only).</p> |
| 5 | <p>Timer n Size (TIMERn_SIZE_CAP) — RO. This read only field indicates the size of the timer.</p> <p>Timer 0: Value is 1 (64-bits).</p> <p>Timers 1, 2, 3, 4, 5, 6, 7 (4, 5, 6, 7 Corporate Only): Value is 0 (32-bits).</p> |
| 4 | <p>Periodic Interrupt Capable (TIMERn_PER_INT_CAP) — RO. If this bit is 1, the hardware supports a periodic mode for this timer's interrupt.</p> <p>Timer 0: Hardwired to 1 (supports the periodic interrupt).</p> <p>Timers 1, 2, 3, 4, 5, 6, 7 (4, 5, 6, 7 Corporate Only): Hardwired to 0 (does not support periodic interrupt).</p> |



| Bit | Description |
|-----|------------------------------------------------------------------------------------------------------------------------------------------------------------------------------------------------------------------------------------------------------------------------------------------------------------------------------------------------------------------------------------------------------------------------------------------------------------------------------------------------------------------------------------------------------------------------------------------------------------------------------------------------------------|
| 3 | Timer n Type (TIMERn_TYPE_CNF) — R/W or RO. Timer 0: Bit is read/write. 0 = Disable timer to generate periodic interrupt; 1 = Enable timer to generate a periodic interrupt. Timers 1, 2, 3, 4, 5, 6, 7 (4, 5, 6, 7 Corporate Only): Hardwired to 0. Writes have no affect. |
| 2 | Timer n Interrupt Enable (TIMERn_INT_ENB_CNF) — R/W. This bit must be set to enable timer n to cause an interrupt when it times out. 0 = Disable (Default). The timer can still count and generate appropriate status bits, but will not cause an interrupt. 1 = Enable. |
| 1 | Timer Interrupt Type (TIMERn_INT_TYPE_CNF) — R/W. 0 = The timer interrupt is edge triggered. This means that an edge-type interrupt is generated. If another interrupt occurs, another edge will be generated. 1 = The timer interrupt is level triggered. This means that a level-triggered interrupt is generated. The interrupt will be held active until it is cleared by writing to the bit in the General Interrupt Status Register. If another interrupt occurs before the interrupt is cleared, the interrupt will remain active. Timer 4, 5, 6, 7 (4, 5, 6, 7 Corporate Only): This bit is Read-Only, and will return 0 when read |
| 0 | Reserved. These bits will return 0 when read. |

NOTE: Reads or writes to unimplemented timers should not be attempted. Read from any unimplemented registers will return an undetermined value.





22 Serial Peripheral Interface (SPI)

The Serial Peripheral Interface resides in memory mapped space. This function contains registers that allow for the setup and programming of devices that reside on the SPI interface.

Note: All registers in this function (including memory-mapped registers) must be addressable in byte, word, and dword quantities. The software must always make register accesses on natural boundaries (i.e., DWord accesses must be on dword boundaries; word accesses on word boundaries, etc.) In addition, the memory-mapped register space must not be accessed with the LOCK semantic exclusive-access mechanism. If software attempts exclusive-access mechanisms to the SPI memory-mapped space, the results are undefined.

22.1 Serial Peripheral Interface Memory Mapped Configuration Registers

The SPI Host Interface registers are memory-mapped in the RCRB (Root Complex Register Block) Chipset Register Space with a base address (SPIBAR) of 3800h and are located within the range of 3800h to 39FFh. The address for RCRB can be found in RCBA Register see [Section 13.1.36](#). The individual registers are then accessible at SPIBAR + Offset as indicated [Table 22-1](#).

These memory mapped registers must be accessed in byte, word, or dword quantities.

Table 22-1. Serial Peripheral Interface (SPI) Register Address Map (SPI Memory Mapped Configuration Registers) (Sheet 1 of 2)

| SPIBAR + Offset | Mnemonic | Register Name | Default | Type |
|-----------------|----------|-----------------------------------|-----------|---------------|
| 00h–03h | BFPR | BIOS Flash Primary Region | 00000000h | RO |
| 04h–05h | HSFSTS | Hardware Sequencing Flash Status | 0000h | RO, R/WC, R/W |
| 06h–07h | HSFCTL | Hardware Sequencing Flash Control | 0000h | R/W, R/WS |
| 08h–0Bh | FADDR | Flash Address | 00000000h | R/W |
| 0Ch–0Fh | Reserved | Reserved | 00000000h | |
| 10h–13h | FDATA0 | Flash Data 0 | 00000000h | R/W |
| 14h–4Fh | FDATAN | Flash Data N | 00000000h | R/W |
| 50h–53h | FRACC | Flash Region Access Permissions | 0000202h | RO, R/W |
| 54h–57h | FREG0 | Flash Region 0 | 00000000h | RO |
| 58h–5Bh | FREG1 | Flash Region 1 | 00000000h | RO |
| 5Ch–5F | FREG2 | Flash Region 2 | 00000000h | RO |
| 60h–63h | FREG3 | Flash Region 3 | 00000000h | RO |
| 64h–67h | FREG3 | Flash Region 4 | 00000000h | RO |
| 67h–73h | Reserved | Reserved for Future Flash Regions | | |



Table 22-1. Serial Peripheral Interface (SPI) Register Address Map (SPI Memory Mapped Configuration Registers) (Sheet 2 of 2)

| SPIBAR + Offset | Mnemonic | Register Name | Default | Type |
|-----------------|----------|---------------------------------------------------|-----------------------|----------|
| 74h–77h | FPR0 | Flash Protected Range 0 | 00000000h | R/W |
| 78h–7Bh | FPR1 | Flash Protected Range 1 | 00000000h | R/W |
| 7Ch–7Fh | FPR2 | Flash Protected Range 2 | 00000000h | R/W |
| 80–83h | FPR3 | Flash Protected Range 3 | 00000000h | R/W |
| 84h–87h | FPR4 | Flash Protected Range 4 | 00000000h | R/W |
| 88h–8Fh | — | Reserved | — | |
| 90h | SSFSTS | Software Sequencing Flash Status | 00h | RO, R/WC |
| 91h–93h | SSFCTL | Software Sequencing Flash Control | 0000h | R/W |
| 94h–95h | PREOP | Prefix Opcode Configuration | 0000h | R/W |
| 96h–97h | OPTYPE | Opcode Type Configuration | 0000h | R/W |
| 98h–9Fh | OPMENU | Opcode Menu Configuration | 00000000 00000000h | R/W |
| A0h | BBAR | BIOS Base Address Configuration | 00000000h | R/W, RO |
| B0h–B3h | FDOC | Flash Descriptor Observability Control | 00000000h | R/W |
| B4h–B7h | FDOD | Flash Descriptor Observability Data | 00000000h | RO |
| B8h–C3h | — | Reserved | — | |
| C0h–C3h | AFC | Additional Flash Control | 00000000h | RO, R/W |
| C4–C7h | LVSCC | Host Lower Vendor Specific Component Capabilities | 00000000h | RO, R/WL |
| C8–C11h | UVSCC | Host Upper Vendor Specific Component Capabilities | 00000000h | RO, R/WL |
| D0–D3h | FPB | Flash Partition Boundary | 00000000h | RO |



22.1.1 BFPR –BIOS Flash Primary Region Register (SPI Memory Mapped Configuration Registers)

Memory Address: SPIBAR + 00h Attribute: RO
 Default Value: 00000000h Size: 32 bits

Note: This register is only applicable when SPI device is in descriptor mode.

| Bit | Description |
|-------|------------------------------------------------------------------------------------------------------------------------------------------------------------------------------------------------------------------------|
| 31:29 | Reserved |
| 28:16 | BIOS Flash Primary Region Limit (PRL) — RO. This specifies address bits 24:12 for the Primary Region Limit. The value in this register loaded from the contents in the Flash Descriptor.FLREG1.Region Limit. |
| 15:13 | Reserved |
| 12:0 | BIOS Flash Primary Region Base (PRB) — RO. This specifies address bits 24:12 for the Primary Region Base The value in this register is loaded from the contents in the Flash Descriptor.FLREG1.Region Base. |

22.1.2 HSFS—Hardware Sequencing Flash Status Register (SPI Memory Mapped Configuration Registers)

Memory Address: SPIBAR + 04h Attribute: RO, R/WC, R/W
 Default Value: 0000h Size: 16 bits

| Bit | Description |
|------|------------------------------------------------------------------------------------------------------------------------------------------------------------------------------------------------------------------------------------------------------------------------------------------------------------------------------------------------------------------------------------------------------------------------------------------------------------------------------------------------------------------------------------------------------------------------------------------------|
| 15 | Flash Configuration Lock-Down (FLOCKDN) — R/W/L. When set to 1, those Flash Program Registers that are locked down by this FLOCKDN bit cannot be written. Once set to 1, this bit can only be cleared by a hardware reset due to a global reset or host partition reset in an Intel ME enabled system. |
| 14 | Flash Descriptor Valid (FDV) — RO. This bit is set to a 1 if the Flash Controller read the correct Flash Descriptor Signature. If the Flash Descriptor Valid bit is not 1, software cannot use the Hardware Sequencing registers, but must use the software sequencing registers. Any attempt to use the Hardware Sequencing registers will result in the FCERR bit being set. |
| 13 | Flash Descriptor Override Pin-Strap Status (FDOPSS) — RO: This register reflects the value the Flash Descriptor Override Pin-Strap. 0 = The Flash Descriptor Override strap is set 1 = No override |
| 12:6 | Reserved |
| 5 | SPI Cycle In Progress (SCIP) — RO. Hardware sets this bit when software sets the Flash Cycle Go (FGO) bit in the Hardware Sequencing Flash Control register. This bit remains set until the cycle completes on the SPI interface. Hardware automatically sets and clears this bit so that software can determine when read data is valid and/or when it is safe to begin programming the next command. Software must only program the next command when this bit is 0. NOTE: This field is only applicable when in Descriptor mode and Hardware sequencing is being used. |



| Bit | Description |
|-----|----------------------------------------------------------------------------------------------------------------------------------------------------------------------------------------------------------------------------------------------------------------------------------------------------------------------------------------------------------------------------------------------------------------------------------------------------------------------------------------------------------------------------------------------------------------------------------------------------------------------------------------------------------------------------|
| 4:3 | <p>Block/Sector Erase Size (BERASE) — RO. This field identifies the erasable sector size for all Flash components.</p> <p>Valid Bit Settings:</p> <p>00 = 256 Byte</p> <p>01 = 4 K Byte</p> <p>10 = 8 K Byte</p> <p>11 = 64 K Byte</p> <p>If the FLA is less than FPBA then this field reflects the value in the LVSCC.LBES register. If the FLA is greater or equal to FPBA then this field reflects the value in the UVSCC.UBES register.</p> <p>NOTE: This field is only applicable when in Descriptor mode and Hardware sequencing is being used.</p> |
| 2 | <p>Access Error Log (AEL) — R/W/C. Hardware sets this bit to a 1 when an attempt was made to access the BIOS region using the direct access method or an access to the BIOS Program Registers that violated the security restrictions. This bit is simply a log of an access security violation. This bit is cleared by software writing a 1.</p> <p>NOTE: This field is only applicable when in Descriptor mode and Hardware sequencing is being used.</p> |
| 1 | <p>Flash Cycle Error (FCERR) — R/W/C. Hardware sets this bit to 1 when an program register access is blocked to the FLASH due to one of the protection policies or when any of the programmed cycle registers is written while a programmed access is already in progress. This bit remains asserted until cleared by software writing a 1 or until hardware reset occurs due to a global reset or host partition reset in an Intel ME enabled system. Software must clear this bit before setting the FLASH Cycle GO bit in this register.</p> <p>NOTE: This field is only applicable when in Descriptor mode and Hardware sequencing is being used.</p> |
| 0 | <p>Flash Cycle Done (FDONE) — R/W/C. The ICH sets this bit to 1 when the SPI Cycle completes after software previously set the FGO bit. This bit remains asserted until cleared by software writing a 1 or hardware reset due to a global reset or host partition reset in an Intel ME enabled system. When this bit is set and the SPI SMI# Enable bit is set, an internal signal is asserted to the SMI# generation block. Software must make sure this bit is cleared prior to enabling the SPI SMI# assertion for a new programmed access.</p> <p>NOTE: This field is only applicable when in Descriptor mode and Hardware sequencing is being used.</p> |



22.1.3 HSFC—Hardware Sequencing Flash Control Register (SPI Memory Mapped Configuration Registers)

Memory Address: SPIBAR + 06h Attribute: R/W, R/WS
 Default Value: 0000h Size: 16 bits

Note: This register is only applicable when SPI device is in descriptor mode.

| Bit | Description |
|------|------------------------------------------------------------------------------------------------------------------------------------------------------------------------------------------------------------------------------------------------------------------------------------------------------------------------------------------------------------------------------------------------------------------------------------------------------------------------------------------------------------------------------------------------------------------------------------------------------------------------------------------------------------------------------------------------------------------------------------|
| 15 | Flash SPI SMI# Enable (FSMIE) — R/W. When set to 1, the SPI asserts an SMI# request whenever the Flash Cycle Done bit is 1. |
| 14 | Reserved |
| 13:8 | Flash Data Byte Count (FDBC) — R/W. This field specifies the number of bytes to shift in or out during the data portion of the SPI cycle. The contents of this register are 0s based with 0b representing 1 byte and 111111b representing 64 bytes. The number of bytes transferred is the value of this field plus 1. This field is ignored for the Block Erase command. |
| 7:3 | Reserved |
| 2:1 | FLASH Cycle (FCYCLE) — R/W. This field defines the Flash SPI cycle type generated to the FLASH when the FGO bit is set as defined below: 00 = Read (1 up to 64 bytes by setting FDBC) 01 = Reserved 10 = Write (1 up to 64 bytes by setting FDBC) 11 = Block Erase |
| 0 | Flash Cycle Go (FGO) — R/W/S. A write to this register with a 1 in this bit initiates a request to the Flash SPI Arbiter to start a cycle. This register is cleared by hardware when the cycle is granted by the SPI arbiter to run the cycle on the SPI bus. When the cycle is complete, the FDONE bit is set. Software is forbidden to write to any register in the HSFLCTL register between the FGO bit getting set and the FDONE bit being cleared. Any attempt to violate this rule will be ignored by hardware. Hardware allows other bits in this register to be programmed for the same transaction when writing this bit to 1. This saves an additional memory write. This bit always returns 0 on reads. |

22.1.4 FADDR—Flash Address Register (SPI Memory Mapped Configuration Registers)

Memory Address: SPIBAR + 08h Attribute: R/W
 Default Value: 00000000h Size: 32 bits

| Bit | Description |
|-------|-----------------------------------------------------------------------------------------------------------------------------------------------------------------------------------------------------------------------------------------------------------------------------------------------------------------------------------------------------------------------------------|
| 31:25 | Reserved |
| 24:0 | Flash Linear Address (FLA) — R/W. The FLA is the starting byte linear address of a SPI Read or Write cycle or an address within a Block for the Block Erase command. The Flash Linear Address must fall within a region for which BIOS has access permissions. Hardware must convert the FLA into a Flash Physical Address (FPA) before running this cycle on the SPI bus. |

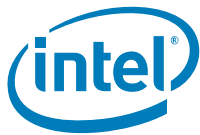

22.1.5 FDATA0—Flash Data 0 Register (SPI Memory Mapped Configuration Registers)

Memory Address: SPIBAR + 10h Attribute: R/W
 Default Value: 00000000h Size: 32 bits

| Bit | Description |
|------|------------------------------------------------------------------------------------------------------------------------------------------------------------------------------------------------------------------------------------------------------------------------------------------------------------------------------------------------------------------------------------------------------------------------------------------------------------------------------------------------------------------------------------------------------------------------------------------------------------------------------------------------------------------------------------------------------------------------------------------------------------------------------------------------------------------------------------------------------------------------------------------------------------------------------------|
| 31:0 | <p>Flash Data 0 (FDO) — R/W. This field is shifted out as the SPI Data on the Master-Out Slave-In Data pin during the data portion of the SPI cycle.</p> <p>This register also shifts in the data from the Master-In Slave-Out pin into this register during the data portion of the SPI cycle.</p> <p>The data is always shifted starting with the least significant byte, msb to lsb, followed by the next least significant byte, msb to lsb, etc. Specifically, the shift order on SPI in terms of bits within this register is: 7-6-5-4-3-2-1-0-15-14-13-...8-23-22-...16-31...24 Bit 24 is the last bit shifted out/in. There are no alignment assumptions; byte 0 always represents the value specified by the cycle address.</p> <p>Note that the data in this register may be modified by the hardware during any programmed SPI transaction. Direct Memory Reads do not modify the contents of this register.</p> |

22.1.6 FDATAN—Flash Data [N] Register (SPI Memory Mapped Configuration Registers)

Memory Address: SPIBAR + 14h Attribute: R/W
 SPIBAR + 18h
 SPIBAR + 1Ch
 SPIBAR + 20h
 SPIBAR + 24h
 SPIBAR + 28h
 SPIBAR + 2Ch
 SPIBAR + 30h
 SPIBAR + 34h
 SPIBAR + 38h
 SPIBAR + 3Ch
 SPIBAR + 40h
 SPIBAR + 44h
 SPIBAR + 48h
 SPIBAR + 4Ch
 Default Value: 00000000h Size: 32 bits

| Bit | Description |
|------|---------------------------------------------------------------------------------------------------------------------------------------------------------------------------------|
| 31:0 | <p>Flash Data N (FD[N]) — R/W. Similar definition as Flash Data 0. However, this register does not begin shifting until FD[N-1] has completely shifted in/out.— R/W.</p> |



22.1.7 FRAP—Flash Regions Access Permissions Register (SPI Memory Mapped Configuration Registers)

Memory Address: SPIBAR + 50h Attribute: RO, R/W
 Default Value: 00000202h Size: 32 bits

Note: This register is only applicable when SPI device is in descriptor mode.

| Bit | Description |
|-------|---------------------------------------------------------------------------------------------------------------------------------------------------------------------------------------------------------------------------------------------------------------------------------------------------------------------------------------------------------------------------------------------------------------------------------------------------------------------------------------|
| 31:24 | <p>BIOS Master Write Access Grant (BMWAG) — R/W. Each bit [31:29] corresponds to Master[7:0]. BIOS can grant one or more masters write access to the BIOS region 1 overriding the permissions in the Flash Descriptor.</p> <p>Master[1] is Host processor/BIOS, Master[2] is Intel Management Engine, Master[3] is Host processor/GbE. Master[0] and Master[7:4] are reserved.</p> <p>The contents of this register are locked by the FLOCKDN bit.</p> |
| 23:16 | <p>BIOS Master Read Access Grant (BMRAG) — R/W. Each bit [28:16] corresponds to Master[7:0]. BIOS can grant one or more masters read access to the BIOS region 1 overriding the read permissions in the Flash Descriptor.</p> <p>Master[1] is Host processor/BIOS, Master[2] is Intel Management Engine, Master[3] is Host processor/GbE. Master[0] and Master[7:4] are reserved.</p> <p>The contents of this register are locked by the FLOCKDN bit.</p> |
| 15:8 | <p>BIOS Region Write Access (BRWA) — RO. Each bit [15:8] corresponds to Regions [7:0]. If the bit is set, this master can erase and write that particular region through register accesses.</p> <p>The contents of this register are that of the Flash Descriptor. Flash Master 1 Master Region Write Access OR a particular master has granted BIOS write permissions in their Master Write Access Grant register or the Flash Descriptor Security Override strap is set.</p> |
| 7:0 | <p>BIOS Region Read Access (BRRR) — RO. Each bit [7:0] corresponds to Regions [7:0]. If the bit is set, this master can read that particular region through register accesses.</p> <p>The contents of this register are that of the Flash Descriptor. Flash Master 1 Master Region Write Access OR a particular master has granted BIOS read permissions in their Master Read Access Grant register or the Flash Descriptor Security Override strap is set.</p> |



22.1.8 FREG0—Flash Region 0 (Flash Descriptor) Register (SPI Memory Mapped Configuration Registers)

Memory Address: SPIBAR + 54h Attribute: RO
Default Value: 00000000h Size: 32 bits

Note: This register is only applicable when SPI device is in descriptor mode.

| Bit | Description |
|-------|-----------------------------------------------------------------------------------------------------------------------------------------------------------------------------------------------------------------------------------------|
| 31:29 | Reserved |
| 28:16 | Region Limit (RL) — RO. This specifies address bits 24:12 for the Region 0 Limit. The value in this register is loaded from the contents in the Flash Descriptor.FLREG0.Region Limit |
| 15:13 | Reserved |
| 12:0 | Region Base (RB) / Flash Descriptor Base Address Region (FDBAR) — RO. This specifies address bits 24:12 for the Region 0 Base. The value in this register is loaded from the contents in the Flash Descriptor.FLREG0.Region Base |

22.1.9 FREG1—Flash Region 1 (BIOS Descriptor) Register (SPI Memory Mapped Configuration Registers)

Memory Address: SPIBAR + 58h Attribute: RO
Default Value: 00000000h Size: 32 bits

Note: This register is only applicable when SPI device is in descriptor mode.

| Bit | Description |
|-------|---------------------------------------------------------------------------------------------------------------------------------------------------------------------------------------------|
| 31:29 | Reserved |
| 28:16 | Region Limit (RL) — RO. This specifies address bits 24:12 for the Region 1 Limit. The value in this register is loaded from the contents in the Flash Descriptor.FLREG1.Region Limit |
| 15:13 | Reserved |
| 12:0 | Region Base (RB) — RO. This specifies address bits 24:12 for the Region 1 Base. The value in this register is loaded from the contents in the Flash Descriptor.FLREG1.Region Base |



22.1.10 FREG2—Flash Region 2 (ME) Register (SPI Memory Mapped Configuration Registers)

Memory Address: SPIBAR + 5Ch Attribute: RO
 Default Value: 00000000h Size: 32 bits

Note: This register is only applicable when SPI device is in descriptor mode.

| Bit | Description |
|-------|---------------------------------------------------------------------------------------------------------------------------------------------------------------------------------------------|
| 31:29 | Reserved |
| 28:16 | Region Limit (RL) — RO. This specifies address bits 24:12 for the Region 2 Limit. The value in this register is loaded from the contents in the Flash Descriptor.FLREG2.Region Limit |
| 15:13 | Reserved |
| 12:0 | Region Base (RB) — RO. This specifies address bits 24:12 for the Region 2 Base. The value in this register is loaded from the contents in the Flash Descriptor.FLREG2.Region Base |

22.1.11 FREG3—Flash Region 3 (GbE) Register (SPI Memory Mapped Configuration Registers)

Memory Address: SPIBAR + 60h Attribute: RO
 Default Value: 00000000h Size: 32 bits

Note: This register is only applicable when SPI device is in descriptor mode.

| Bit | Description |
|-------|---------------------------------------------------------------------------------------------------------------------------------------------------------------------------------------------|
| 31:29 | Reserved |
| 28:16 | Region Limit (RL) — RO. This specifies address bits 24:12 for the Region 3 Limit. The value in this register is loaded from the contents in the Flash Descriptor.FLREG3.Region Limit |
| 15:13 | Reserved |
| 12:0 | Region Base (RB) — RO. This specifies address bits 24:12 for the Region 3 Base. The value in this register is loaded from the contents in the Flash Descriptor.FLREG3.Region Base |



22.1.12 FREG4—Flash Region 4 (Platform Data) Register (SPI Memory Mapped Configuration Registers)

Memory Address: SPIBAR + 64h Attribute: RO
 Default Value: 00000000h Size: 32 bits

Note: This register is only applicable when SPI device is in descriptor mode.

| Bit | Description |
|-------|---------------------------------------------------------------------------------------------------------------------------------------------------------------------------------------------|
| 31:29 | Reserved |
| 28:16 | Region Limit (RL) — RO. This specifies address bits 24:12 for the Region 4 Limit. The value in this register is loaded from the contents in the Flash Descriptor.FLREG4.Region Limit |
| 15:13 | Reserved |
| 12:0 | Region Base (RB) — RO. This specifies address bits 24:12 for the Region 4 Base. The value in this register is loaded from the contents in the Flash Descriptor.FLREG4.Region Base |

22.1.13 PR0—Protected Range 0 Register (SPI Memory Mapped Configuration Registers)

Memory Address: SPIBAR + 74h Attribute: R/W
 Default Value: 00000000h Size: 32 bits

Note: This register can not be written when the FLOCKDN bit is set to 1.

| Bit | Description |
|-------|------------------------------------------------------------------------------------------------------------------------------------------------------------------------------------------------------------------------------------------------------------------------------------------------------------------|
| 31 | Write Protection Enable — R/W. When set, this bit indicates that the Base and Limit fields in this register are valid and that writes and erases directed to addresses between them (inclusive) must be blocked by hardware. The base and limit fields are ignored when this bit is cleared. |
| 30:29 | Reserved |
| 28:16 | Protected Range Limit — R/W. This field corresponds to FLA address bits 24:12 and specifies the upper limit of the protected range. Address bits 11:0 are assumed to be FFFh for the limit comparison. Any address greater than the value programmed in this field is unaffected by this protected range. |
| 15 | Read Protection Enable — R/W. When set, this bit indicates that the Base and Limit fields in this register are valid and that read directed to addresses between them (inclusive) must be blocked by hardware. The base and limit fields are ignored when this bit is cleared. |
| 14:13 | Reserved |
| 12:0 | Protected Range Base — R/W. This field corresponds to FLA address bits 24:12 and specifies the lower base of the protected range. Address bits 11:0 are assumed to be 000h for the base comparison. Any address less than the value programmed in this field is unaffected by this protected range. |



22.1.14 PR1—Protected Range 1 Register (SPI Memory Mapped Configuration Registers)

Memory Address: SPIBAR + 78h Attribute: R/W
 Default Value: 00000000h Size: 32 bits

Note: This register can not be written when the FLOCKDN bit is set to 1.

| Bit | Description |
|-------|------------------------------------------------------------------------------------------------------------------------------------------------------------------------------------------------------------------------------------------------------------------------------------------------------------------|
| 31 | Write Protection Enable — R/W. When set, this bit indicates that the Base and Limit fields in this register are valid and that writes and erases directed to addresses between them (inclusive) must be blocked by hardware. The base and limit fields are ignored when this bit is cleared. |
| 30:29 | Reserved |
| 28:16 | Protected Range Limit — R/W. This field corresponds to FLA address bits 24:12 and specifies the upper limit of the protected range. Address bits 11:0 are assumed to be FFFh for the limit comparison. Any address greater than the value programmed in this field is unaffected by this protected range. |
| 15 | Read Protection Enable — R/W. When set, this bit indicates that the Base and Limit fields in this register are valid and that read directed to addresses between them (inclusive) must be blocked by hardware. The base and limit fields are ignored when this bit is cleared. |
| 14:13 | Reserved |
| 12:0 | Protected Range Base — R/W. This field corresponds to FLA address bits 24:12 and specifies the lower base of the protected range. Address bits 11:0 are assumed to be 000h for the base comparison. Any address less than the value programmed in this field is unaffected by this protected range. |



22.1.15 PR2—Protected Range 2 Register (SPI Memory Mapped Configuration Registers)

Memory Address: SPIBAR + 7Ch Attribute: R/W
Default Value: 00000000h Size: 32 bits

Note: This register can not be written when the FLOCKDN bit is set to 1.

| Bit | Description |
|-------|------------------------------------------------------------------------------------------------------------------------------------------------------------------------------------------------------------------------------------------------------------------------------------------------------------------|
| 31 | Write Protection Enable — R/W. When set, this bit indicates that the Base and Limit fields in this register are valid and that writes and erases directed to addresses between them (inclusive) must be blocked by hardware. The base and limit fields are ignored when this bit is cleared. |
| 30:29 | Reserved |
| 28:16 | Protected Range Limit — R/W. This field corresponds to FLA address bits 24:12 and specifies the upper limit of the protected range. Address bits 11:0 are assumed to be FFFh for the limit comparison. Any address greater than the value programmed in this field is unaffected by this protected range. |
| 15 | Read Protection Enable — R/W. When set, this bit indicates that the Base and Limit fields in this register are valid and that read directed to addresses between them (inclusive) must be blocked by hardware. The base and limit fields are ignored when this bit is cleared. |
| 14:13 | Reserved |
| 12:0 | Protected Range Base — R/W. This field corresponds to FLA address bits 24:12 and specifies the lower base of the protected range. Address bits 11:0 are assumed to be 000h for the base comparison. Any address less than the value programmed in this field is unaffected by this protected range. |

22.1.16 PR3—Protected Range 3 Register (SPI Memory Mapped Configuration Registers)

Memory Address: SPIBAR + 80h Attribute: R/W
Default Value: 00000000h Size: 32 bits

Note: This register can not be written when the FLOCKDN bit is set to 1.

| Bit | Description |
|-------|------------------------------------------------------------------------------------------------------------------------------------------------------------------------------------------------------------------------------------------------------------------------------------------------------------------|
| 31 | Write Protection Enable — R/W. When set, this bit indicates that the Base and Limit fields in this register are valid and that writes and erases directed to addresses between them (inclusive) must be blocked by hardware. The base and limit fields are ignored when this bit is cleared. |
| 30:29 | Reserved |
| 28:16 | Protected Range Limit — R/W. This field corresponds to FLA address bits 24:12 and specifies the upper limit of the protected range. Address bits 11:0 are assumed to be FFFh for the limit comparison. Any address greater than the value programmed in this field is unaffected by this protected range. |
| 15 | Read Protection Enable — R/W. When set, this bit indicates that the Base and Limit fields in this register are valid and that read directed to addresses between them (inclusive) must be blocked by hardware. The base and limit fields are ignored when this bit is cleared. |
| 14:13 | Reserved |
| 12:0 | Protected Range Base — R/W. This field corresponds to FLA address bits 24:12 and specifies the lower base of the protected range. Address bits 11:0 are assumed to be 000h for the base comparison. Any address less than the value programmed in this field is unaffected by this protected range. |



22.1.17 PR4—Protected Range 4 Register (SPI Memory Mapped Configuration Registers)

Memory Address: SPIBAR + 84h Attribute: R/W
 Default Value: 00000000h Size: 32 bits

Note: This register can not be written when the FLOCKDN bit is set to 1.

| Bit | Description |
|-------|------------------------------------------------------------------------------------------------------------------------------------------------------------------------------------------------------------------------------------------------------------------------------------------------------------------|
| 31 | Write Protection Enable — R/W. When set, this bit indicates that the Base and Limit fields in this register are valid and that writes and erases directed to addresses between them (inclusive) must be blocked by hardware. The base and limit fields are ignored when this bit is cleared. |
| 30:29 | Reserved |
| 28:16 | Protected Range Limit — R/W. This field corresponds to FLA address bits 24:12 and specifies the upper limit of the protected range. Address bits 11:0 are assumed to be FFFh for the limit comparison. Any address greater than the value programmed in this field is unaffected by this protected range. |
| 15 | Read Protection Enable — R/W. When set, this bit indicates that the Base and Limit fields in this register are valid and that read directed to addresses between them (inclusive) must be blocked by hardware. The base and limit fields are ignored when this bit is cleared. |
| 14:13 | Reserved |
| 12:0 | Protected Range Base — R/W. This field corresponds to FLA address bits 24:12 and specifies the lower base of the protected range. Address bits 11:0 are assumed to be 000h for the base comparison. Any address less than the value programmed in this field is unaffected by this protected range. |

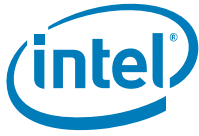

22.1.18 SSFS—Software Sequencing Flash Status Register (SPI Memory Mapped Configuration Registers)

Memory Address: SPIBAR + 90h Attribute: RO, R/WC
Default Value: 00h Size: 8 bits

Note: The Software Sequencing control and status registers are reserved if the hardware sequencing control and status registers are used.

| Bit | Description |
|-----|-------------------------------------------------------------------------------------------------------------------------------------------------------------------------------------------------------------------------------------------------------------------------------------------------------------------------------------------------------------------------------------------------------------------------------------------------------------------------------------------------------------------------------------------------------|
| 7:5 | Reserved |
| 4 | Access Error Log (AEL) — RO. This bit reflects the value of the Hardware Sequencing Status AEL register. |
| 3 | Flash Cycle Error (FCERR) — R/WC. Hardware sets this bit to 1 when a programmed access is blocked from running on the SPI interface due to one of the protection policies or when any of the programmed cycle registers is written while a programmed access is already in progress. This bit remains asserted until cleared by software writing a 1 or hardware reset due to a global reset or host partition reset in an Intel ME enabled system. |
| 2 | Cycle Done Status — R/WC. The ICH sets this bit to 1 when the SPI Cycle completes (i.e., SCIP bit is 0) after software sets the GO bit. This bit remains asserted until cleared by software writing a 1 or hardware reset due to a global reset or host partition reset in an Intel ME enabled system. When this bit is set and the SPI SMI# Enable bit is set, an internal signal is asserted to the SMI# generation block. Software must make sure this bit is cleared prior to enabling the SPI SMI# assertion for a new programmed access. |
| 1 | Reserved |
| 0 | SPI Cycle In Progress (SCIP) — RO. Hardware sets this bit when software sets the SPI Cycle Go bit in the Command register. This bit remains set until the cycle completes on the SPI interface. Hardware automatically sets and clears this bit so that software can determine when read data is valid and/or when it is safe to begin programming the next command. Software must only program the next command when this bit is 0. |



22.1.19 SSFC—Software Sequencing Flash Control Register (SPI Memory Mapped Configuration Registers)

Memory Address: SPIBAR + 91h Attribute: R/W
 Default Value: 000000h Size: 24 bits

| Bit | Description |
|-------|-------------------------------------------------------------------------------------------------------------------------------------------------------------------------------------------------------------------------------------------------------------------------------------------------------------------------------------------------------------------------------------------------------------------------------------------------------------------------------------------------------------------------------------------------------------------------------------------------------------------------------------------------------------------------------------------------------------|
| 23:19 | Reserved |
| 18:16 | <p>SPI Cycle Frequency (SCF) — R/W. This register sets frequency to use for all SPI software sequencing cycles (write, erase, fast read, read status, etc.) except for the read cycle which always run at 20 MHz.</p> <p>000 = 20 MHz 001 = 33 MHz All other values reserved.</p> <p>This register is locked when the SPI Configuration Lock-Down bit is set.</p> |
| 15 | <p>SPI SMI# Enable (SME) — R/W. When set to 1, the SPI asserts an SMI# request whenever the Cycle Done Status bit is 1.</p> |
| 14 | <p>Data Cycle (DS) — R/W. When set to 1, there is data that corresponds to this transaction. When 0, no data is delivered for this cycle, and the DBC and data fields themselves are don't cares</p> |
| 13:8 | <p>Data Byte Count (DBC) — R/W. This field specifies the number of bytes to shift in or out during the data portion of the SPI cycle. The valid settings (in decimal) are any value from 0 to 63. The number of bytes transferred is the value of this field plus 1.</p> <p>Note that when this field is 00_0000b, then there is 1 byte to transfer and that 11_1111b means there are 64 bytes to transfer.</p> |
| 7 | Reserved |
| 6:4 | <p>Cycle Opcode Pointer (COP) — R/W. This field selects one of the programmed opcodes in the Opcode Menu to be used as the SPI Command/Opcod. In the case of an Atomic Cycle Sequence, this determines the second command.</p> |
| 3 | <p>Sequence Prefix Opcode Pointer (SPOP) — R/W. This field selects one of the two programmed prefix opcodes for use when performing an Atomic Cycle Sequence. A value of 0 points to the opcode in the least significant byte of the Prefix Opcodes register. By making this programmable, the ICH supports flash devices that have different opcodes for enabling writes to the data space vs. status register.</p> |
| 2 | <p>Atomic Cycle Sequence (ACS) — R/W. When set to 1 along with the SCGO assertion, the ICH10 will execute a sequence of commands on the SPI interface without allowing the LAN component to arbitrate and interleave cycles. The sequence is composed of:</p> <ul style="list-style-type: none"> • Atomic Sequence Prefix Command (8-bit opcode only) • Primary Command specified below by software (can include address and data) • Polling the Flash Status Register (opcode 05h) until bit 0 becomes 0b. <p>The SPI Cycle in Progress bit remains set and the Cycle Done Status bit remains unset until the Busy bit in the Flash Status Register returns 0.</p> |
| 1 | <p>SPI Cycle Go (SCGO) — R/WS. This bit always returns 0 on reads. However, a write to this register with a 1 in this bit starts the SPI cycle defined by the other bits of this register. The "SPI Cycle in Progress" (SCIP) bit gets set by this action. Hardware must ignore writes to this bit while the Cycle In Progress bit is set. Hardware allows other bits in this register to be programmed for the same transaction when writing this bit to 1. This saves an additional memory write.</p> |
| 0 | Reserved |



22.1.20 PREOP—Prefix Opcode Configuration Register (SPI Memory Mapped Configuration Registers)

Memory Address: SPIBAR + 94h Attribute: R/W
 Default Value: 0000h Size: 16 bits

| Bit | Description |
|------|----------------------------------------------------------------------------------------------------------------------------------------------------------|
| 15:8 | Prefix Opcode 1 — R/W. Software programs an SPI opcode into this field that is permitted to run as the first command in an atomic cycle sequence. |
| 7:0 | Prefix Opcode 0 — R/W. Software programs an SPI opcode into this field that is permitted to run as the first command in an atomic cycle sequence. |

NOTE: This register is not writable when the Flash Configuration Lock-Down bit (SPIBAR + 04h:15) is set.

22.1.21 OPTYPE—Opcode Type Configuration Register (SPI Memory Mapped Configuration Registers)

Memory Address: SPIBAR + 96h Attribute: R/W
 Default Value: 0000h Size: 16 bits

Entries in this register correspond to the entries in the Opcode Menu Configuration register.

Note: The definition below only provides write protection for opcodes that have addresses associated with them. Therefore, any erase or write opcodes that do not use an address should be avoided (for example, “Chip Erase” and “Auto-Address Increment Byte Program”)

| Bit | Description |
|-------|------------------------------------------------------------------------------------------------------------------------------------------------------------------------------------------------------------------------------------------------------------------------------------------------------------------------------------------------------------------------------------------------------------------------------------------------------------------------------------------------------|
| 15:14 | Opcode Type 7 — R/W. See the description for bits 1:0 |
| 13:12 | Opcode Type 6 — R/W. See the description for bits 1:0 |
| 11:10 | Opcode Type 5 — R/W. See the description for bits 1:0 |
| 9:8 | Opcode Type 4 — R/W. See the description for bits 1:0 |
| 7:6 | Opcode Type 3 — R/W. See the description for bits 1:0 |
| 5:4 | Opcode Type 2 — R/W. See the description for bits 1:0 |
| 3:2 | Opcode Type 1 — R/W. See the description for bits 1:0 |
| 1:0 | Opcode Type 0 — R/W. This field specifies information about the corresponding Opcode 0. This information allows the hardware to 1) know whether to use the address field and 2) provide BIOS and Shared Flash protection capabilities. The encoding of the two bits is: 00 = No address associated with this Opcode; Read cycle type 01 = No address associated with this Opcode; Write cycle type 10 = Address required; Read cycle type 11 = Address required; Write cycle type |

NOTE: This register is not writable when the SPI Configuration Lock-Down bit (SPIBAR + 00h:15) is set.



22.1.22 OPMENU—Opcode Menu Configuration Register (SPI Memory Mapped Configuration Registers)

Memory Address: SPIBAR + 98h Attribute: R/W
 Default Value: 0000000000000000h Size: 64 bits

Eight entries are available in this register to give BIOS a sufficient set of commands for communicating with the flash device, while also restricting what malicious software can do. This keeps the hardware flexible enough to operate with a wide variety of SPI devices.

Note: It is recommended that BIOS avoid programming Write Enable opcodes in this menu. Malicious software could then perform writes and erases to the SPI flash without using the atomic cycle mechanism. This could cause functional failures in a shared flash environment. Write Enable opcodes should only be programmed in the Prefix Opcodes.

| Bit | Description |
|-------|-----------------------------------------------------------------------------------------------------------------------------------------------------|
| 63:56 | Allowable Opcode 7 — R/W. See the description for bits 7:0 |
| 55:48 | Allowable Opcode 6 — R/W. See the description for bits 7:0 |
| 47:40 | Allowable Opcode 5 — R/W. See the description for bits 7:0 |
| 39:32 | Allowable Opcode 4 — R/W. See the description for bits 7:0 |
| 31:24 | Allowable Opcode 3 — R/W. See the description for bits 7:0 |
| 23:16 | Allowable Opcode 2 — R/W. See the description for bits 7:0 |
| 15:8 | Allowable Opcode 1 — R/W. See the description for bits 7:0 |
| 7:0 | Allowable Opcode 0 — R/W. Software programs an SPI opcode into this field for use when initiating SPI commands through the Control Register. |

This register is not writable when the SPI Configuration Lock-Down bit (SPIBAR + 00h:15) is set.



22.1.23 BBAR—BIOS Base Address Configuration Register (SPI Memory Mapped Configuration Registers)

Memory Address: SPIBAR + A0h Attribute: R/W, RO
 Default Value: 00000000h Size: 32 bits

Eight entries are available in this register to give BIOS a sufficient set of commands for communicating with the flash device, while also restricting what malicious software can do. This keeps the hardware flexible enough to operate with a wide variety of SPI devices.

| Bit | Description |
|-------|------------------------------------------------------------------------------------------------------------------------------------------------------------------------------------------------------------------------------------------------------------------------------------------------------------------------------------------------------------------------------------------------------------------------------------------------------------------------------------------------------------------------------------------------------------------------------------------------------------------------------------------------------------------------------------------------------------------|
| 31:24 | Reserved |
| 23:8 | <p>Bottom of System Flash— R/W. This field determines the bottom of the System BIOS. The ICH10 will not run programmed commands nor memory reads whose address field is less than this value. this field corresponds to bits 23:8 of the 3-byte address; bits 7:0 are assumed to be 00h for this vector when comparing to a potential SPI address.</p> <p>NOTE: The SPI host controller prevents any programmed cycle using the address register with an address less than the value in this register. Some flash devices specify that the Read ID command must have an address of 0000h or 0001h. If this command must be supported with these device, it must be performed with the BIOS Bar</p> |
| 7:0 | Reserved |

22.1.24 FDOC—Flash Descriptor Observability Control Register (SPI Memory Mapped Configuration Registers)

Memory Address: SPIBAR + B0h Attribute: R/W
 Default Value: 00000000h Size: 32 bits

Note: This register that can be used to observe the contents of the Flash Descriptor that is stored in the ICH10 Flash Controller. This register is only applicable when SPI device is in descriptor mode.

| Bit | Description |
|-------|-------------------------------------------------------------------------------------------------------------------------------------------------------------------------------------------------------------------------------------------------------------------------------------------------------|
| 31:15 | Reserved |
| 14:12 | <p>Flash Descriptor Section Select (FDSS) — R/W. Selects which section within the loaded Flash Descriptor to observe.</p> <p>000 = Flash Signature and Descriptor Map 001 = Component 010 = Region 011 = Master 111 = Reserved</p> |
| 11:2 | <p>Flash Descriptor Section Index (FDSI) — R/W. Selects the DW offset within the Flash Descriptor Section to observe.</p> |
| 1:0 | Reserved |



22.1.25 FDOD—Flash Descriptor Observability Data Register (SPI Memory Mapped Configuration Registers)

Memory Address: SPIBAR + B4h Attribute: RO
 Default Value: 00000000h Size: 32 bits

Note: This register that can be used to observe the contents of the Flash Descriptor that is stored in the ICH10 Flash Controller.

| Bit | Description |
|------|------------------------------------------------------------------------------------------------------------------------------------------------|
| 31:0 | Flash Descriptor Section Data (FDSD) — RO. Returns the DW of data to observe as selected in the Flash Descriptor Observability Control. |

22.1.26 AFC—Additional Flash Control Register (SPI Memory Mapped Configuration Registers)

Memory Address: SPIBAR + C0h Attribute: RO, R/W
 Default Value: 00000000h Size: 32 bits.

| Bit | Description |
|------|-------------------------------------------------------------------------------------------------------------------------------------------------------------------------------------------------------------------------------------------------|
| 31:3 | Reserved. |
| 2:1 | Flash Controller Interface Dynamic Clock Gating Enable — R/W. 0 = Flash Controller Interface Dynamic Clock Gating is Disabled 1 = Flash Controller Interface Dynamic Clock Gating is Enabled Other configurations are Reserved. |
| 0 | Flash Controller Core Dynamic Clock Gating Enable — R/W. 0 = Flash Controller Core Dynamic Clock Gating is Disabled 1 = Flash Controller Core Dynamic Clock Gating is Enabled |

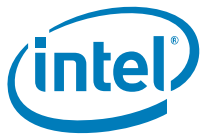

22.1.27 LVSCC— Host Lower Vendor Specific Component Capabilities Register (SPI Memory Mapped Configuration Registers)

Memory Address: SPIBAR + C4h Attribute: RO, RWL
 Default Value: 00000000h Size: 32 bits

Note: All attributes described in LVSCC must apply to all flash space below the FPBA, even if it spans between two separate flash parts. This register is only applicable when SPI device is in descriptor mode.

| Bit | Description |
|-------|-------------------------------------------------------------------------------------------------------------------------------------------------------------------------------------------------------------------------------------------------------------------------------------------------------------------------------------------------------------------------------------------------------------------------------------------------------------------------------------------------------------------------------------------------------------------------------------------------------------------------------------------------------------------------------------------------------------------------------------------------------------------------------------|
| 31:24 | Reserved. |
| 23 | Vendor Component Lock (LVCL) — RW. This register locks itself when set. 0 = The lock bit is not set 1 = The Vendor Component Lock bit is set. |
| 22:16 | Reserved |
| 15:8 | Lower Erase Opcode (LEO) — RW. This register is programmed with the Flash erase instruction opcode required by the vendor’s Flash component. This register is locked by the Vendor Component Lock (LVCL) bit. |
| 7:5 | Reserved |
| 4 | Write Enable on Write Status (LWEWS) — RW. This register is locked by the Vendor Component Lock (LVCL) bit. 0 = No requirement to write to the Status Register prior to a write 1 = A write of 00h to the SPI flash’s status register is required prior to write and erase to unlock the flash component. 06h is the opcode used to unlock the Status register. NOTES: 1. This is not an atomic sequence. If the SPI component’s status register is non-volatile, then BIOS should issue an atomic software sequence cycle to unlock the flash part. 2. This bit should not be set to 1 if the SPI flash status register is non-volatile. This may lead to premature flash wear out. 3. Bit 3 and bit 4 should NOT be both set to 1. |
| 3 | Lower Write Status Required (LWSR) — RW. This register is locked by the Vendor Component Lock (LVCL) bit. 0 = No requirement to write to the Status Register prior to a write 1 = A write of 00h to the SPI flash’s status register is required prior to write and erase to unlock the flash component. 50h is the opcode used to unlock the Status register. NOTES: 1. This is not an atomic sequence. If the SPI component’s status register is non-volatile, then an atomic software sequencing should be used to unlock the flash part. NOTE: This bit should not be set to 1 if the SPI flash status register is non-volatile. This may lead to premature flash wear out. NOTE: Bit 3 and bit 4 should NOT be both set to 1. |



| Bit | Description |
|-----|--------------------------------------------------------------------------------------------------------------------------------------------------------------------------------------------------------------------------------------------------------------------------------------------------------------------------------------------------------------------------------------------------------------------------------------------------------------------------------------------------------------------------------------------------------------------------------------------------------------------------------------|
| 2 | <p>Lower Write Granularity (LWG) — RW. This register is locked by the Vendor Component Lock (LVCL) bit.</p> <p>0 = 1 Byte 1 = 64 Byte</p> <p>NOTES:</p> <ol style="list-style-type: none"> If more than one Flash component exists, this field must be set to the lowest common write granularity of the different Flash components. If using 64 B write, BIOS must ensure that multiple byte writes do not occur over 256 B boundaries. This will lead to corruption as the write will wrap around the page boundary on the SPI flash part. This is a a feature page writeable SPI flash. |
| 1:0 | <p>Lower Block/Sector Erase Size (LBES)— RW. This field identifies the erasable sector size for all Flash components.</p> <p>00 = 256 Byte 01 = 4 KB 10 = 8 KB 11 = 64 KB</p> <p>This register is locked by the Vendor Component Lock (LVCL) bit.</p> <p>Hardware takes no action based on the value of this register. The contents of this register are to be used only by software and can be read in the HSFSTS.BERASE register in both the BIOS and the GbE program registers if FLA is less than FPBA.</p> |

22.1.28 UVSCC— Host Upper Vendor Specific Component Capabilities Register (SPI Memory Mapped Configuration Registers)

Memory Address: SPIBAR + C8h Attribute: RO, RWL
Default Value: 00000000h Size: 32 bits

Note: All attributes described in UVSCC must apply to all flash space equal to or above the FPBA, even if it spans between two separate flash parts. This register is only applicable when SPI device is in descriptor mode.

| Bit | Description |
|-------|-----------------------------------------------------------------------------------------------------------------------------------------------------------------------------------------------------------------------------------|
| 31:24 | Reserved. |
| 23 | <p>Vendor Component Lock (UVCL) — RW.</p> <p>0 = The lock bit is not set 1 = The Vendor Component Lock bit is set.</p> <p>This register locks itself when set.</p> |
| 22:16 | Reserved |
| 15:8 | <p>Upper Erase Opcode (UEO)— RW. This register is programmed with the Flash erase instruction opcode required by the vendor's Flash component.</p> <p>This register is locked by the Vendor Component Lock (UVCL) bit.</p> |
| 7:5 | Reserved |



| Bit | Description |
|-----|---------------------------------------------------------------------------------------------------------------------------------------------------------------------------------------------------------------------------------------------------------------------------------------------------------------------------------------------------------------------------------------------------------------------------------------------------------------------------------------------------------------------------------------------------------------------------------------------------------------------------------------------------------------------------------------------------------------------------------------------------------------------------------------------------------------------------------------------------|
| 4 | <p>Write Enable on Write Status (UWEWS) — RW. This register is locked by the Vendor Component Lock (UVCL) bit.</p> <p>0 = No requirement to write to the Status Register prior to a write 1 = A write of 00h to the SPI flash's status register is required prior to write and erase to unlock the flash component. 06h is the opcode used to unlock the Status register.</p> <p>NOTES:</p> <ol style="list-style-type: none"> This is not an atomic sequence. If the SPI component's status register is non-volatile, then BIOS should issue an atomic software sequence cycle to unlock the flash part. This bit should not be set to 1 if the SPI flash status register is non-volatile. This may lead to premature flash wear out. Bit 3 and bit 4 should NOT be both set to 1. |
| 3 | <p>Upper Write Status Required (UWSR) — RW. This register is locked by the Vendor Component Lock (UVCL) bit.</p> <p>0 = No requirement to write to the Status Register prior to a write 1 = A write of 00h to the SPI flash's status register is required prior to write and erase to unlock the flash component. 50h is the opcode used to unlock the Status register.</p> <p>NOTES:</p> <ol style="list-style-type: none"> This is not an atomic sequence. If the SPI component's status register is non-volatile, then an atomic software sequencing should be used to unlock the flash part. This bit should not be set to 1 if the SPI flash status register is non-volatile. This may lead to premature flash wear out. Bit 3 and bit 4 should NOT be both set to 1. |
| 2 | <p>Upper Write Granularity (UWG) — RW. This register is locked by the Vendor Component Lock (UVCL) bit.</p> <p>0 = 1 Byte 1 = 64 Byte</p> <p>NOTES:</p> <ol style="list-style-type: none"> If more than one Flash component exists, this field must be set to the lowest common write granularity of the different Flash components. If using 64 B write, BIOS must ensure that multiple byte writes do not occur over 256 B boundaries. This will lead to corruption as the write will wrap around the page boundary on the SPI flash part. This is a feature page writeable SPI flash. |
| 1:0 | <p>Upper Block/Sector Erase Size (UBES)— RW. This field identifies the erasable sector size for all Flash components.</p> <p>Valid Bit Settings:</p> <p>00 = 256 Byte 01 = 4 KB 10 = 8 KB 11 = 64 KB</p> <p>This register is locked by the Vendor Component Lock (UVCL) bit.</p> <p>Hardware takes no action based on the value of this register. The contents of this register are to be used only by software and can be read in the HSFSTS.BERASE register in both the BIOS and the GbE program registers if FLA is greater or equal to FPBA.</p> |



22.1.29 FPB — Flash Partition Boundary (SPI Memory Mapped Configuration Registers)

Memory Address: SPIBAR + D0h Attribute: RO
 Default Value: 00000000h Size: 32 bits

Note: This register is only applicable when SPI device is in descriptor mode.

| Bit | Description |
|-------|---------------------------------------------------------------------------------------------------------------------------------|
| 31:13 | Reserved. |
| 12:0 | Flash Partition Boundary Address (FPBA) — RO. This register reflects the value of Flash Descriptor Component FPBA field. |



22.2.1.3 FLMAP1—Flash Map 1 Register (Flash Descriptor Registers)

Memory Address: FDBAR + 008h Default Value: h
 Size: 32 bits

| Bits | Description |
|-------|-------------------------------------------------------------------------------------------------------------------------------------------------------------------------------------------------------------------------------|
| 31:24 | ICH Strap Length (ISL) . Identifies the 1s based number of Dwords of ICH Straps to be read, up to 255 DWs (1KB) max. A setting of all 0's indicates there are no ICH DW straps. |
| 23:16 | Flash ICH Strap Base Address (FISBA) . This identifies address bits [11:4] for the ICH Strap portion of the Flash Descriptor. Bits [24:12] and bits [3:0] are 0. For validation purposes, the recommended FISBA is 10h |
| 15:11 | Reserved |
| 10:08 | Number Of Masters (NM) . This field identifies the total number of Flash Regions. This number is 0's based. |
| 7:0 | Flash Master Base Address (FMBA) . This identifies address bits [11:4] for the Master portion of the Flash Descriptor. Bits [24:12] and bits [3:0] are 0. A recommended FMBA is 06h. |

22.2.1.4 FLMAP2—Flash Map 2 Register (Flash Descriptor Registers)

Memory Address: FDBAR + 00Ch Default Value: h
 Size: 32 bits

| Bits | Description |
|-------|-----------------------------------------------------------------------------------------------------------------------------------------------------------------------------------------------------------|
| 31:16 | Reserved |
| 15:08 | MCH Strap Length (MSL) . Identifies the 1's based number of Dwords of (G)MCH Straps to be read, up to 255 DWs (1KB) max. A setting of all 0's indicates there are no (G)MCH DW straps. |
| 7:0 | Flash (G)MCH Strap Base Address (FMSBA) . This identifies address bits [11:4] for the (G)MCH Strap portion of the Flash Descriptor. Bits [24:12] and bits [3:0] are 0. A recommended FMSBA is 20h. |

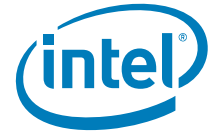

| Bits | Description |
|-------|-----------------------------------------------------------------------------------------------------------------------------------------------------------------------------------------------------------------------------------------------------------------------------------------------------------------------------------------------------------------------------------------------------------------------------------------------------------------------------|
| 19:17 | <p>Read Clock Frequency. 000 = 20 MHz All other Settings = Reserved</p> <p>NOTE: If more than one Flash component exists, this field must be set to the lowest common frequency of the different Flash components.</p> |
| 16:6 | Reserved |
| 5:3 | <p>Component 2 Density. This field identifies the size of the 2nd Flash component. If there is not 2nd Flash component, the contents of this field are undefined.</p> <p>000 = 512 KB 001 = 1 MB 010 = 2 MB 011 = 4 MB 100 = 8 MB 101 = 16 MB 111 = Reserved</p> |
| 2:0 | <p>Component 1 Density. This field identifies the size of the 1st or only Flash component.</p> <p>000 = 512 KB 001 = 1 MB 010 = 2 MB 011 = 4 MB 100 = 8 MB 101 = 16 MB 111 = Reserved</p> <p>This field is defaulted to "101b" (16 MB) after reset. In non-descriptor mode, only one flash component is supported and all accesses to flash will be to this component.</p> |



22.2.3.3 FLREG2—Flash Region 2 (ME) Register (Flash Descriptor Registers)

Memory Address: FRBA + 008h Default Value: h
Size: 32 bits

| Bits | Description |
|-------|------------------------------------------------------------------------------------------------------------------------------------------------------------------------------------------------------------------------------------------------|
| 31:29 | Reserved |
| 28:16 | Region Limit. This specifies address bits 24:12 for the Region Limit. |
| 15:13 | Reserved |
| 12:0 | Region Base. This specifies address bits 24:12 for the Region Base. NOTE: If the Intel Management Engine region is not used, the Region Base must be programmed to 1FFFh and the Region Limit to 0000h to disable the region. |

22.2.3.4 FLREG3—Flash Region 3 (GbE) Register (Flash Descriptor Registers)

Memory Address: FRBA + 00Ch Default Value: h
Size: 32 bits

| Bits | Description |
|-------|----------------------------------------------------------------------------------------------------------------------------------------------------------------------------------------------------------------------------|
| 31:29 | Reserved |
| 28:16 | Region Limit. This specifies address bits 24:12 for the Region Limit. NOTE: The maximum Region Limit is 128KB above the region base. |
| 15:13 | Reserved |
| 12:0 | Region Base. This specifies address bits 24:12 for the Region Base. NOTE: If the GbE region is not used, the Region Base must be programmed to 1FFFh and the Region Limit to 0000h to disable the region. |

22.2.3.5 FLREG4—Flash Region 4 (Platform Data) Register (Flash Descriptor Registers)

Memory Address: FRBA + 010h Default Value: h
Size: 32 bits

| Bits | Description |
|-------|--------------------------------------------------------------------------------------------------------------------------------------------------------------------------------------------------------------------------------------|
| 31:29 | Reserved |
| 28:16 | Region Limit. This specifies address bits 24:12 for the Region Limit. NOTE: The maximum Region Limit is 128KB above the region base. |
| 15:13 | Reserved |
| 12:0 | Region Base. This specifies address bits 24:12 for the Region Base. NOTE: If the Platform Data region is not used, the Region Base must be programmed to 1FFFh and the Region Limit to 0000h to disable the region. |



22.2.4 Flash Descriptor Master Section

22.2.4.1 FLMSTR1—Flash Master 1 (Host CPU/ BIOS) (Flash Descriptor Registers)

Memory Address: FMBA + 000h Default Value: h
 Size: 32 bits

| Bits | Description |
|-------|----------------------------------------------------------------------------------------------------------------------------------------------------------------------------------------------------------------------------------------------------------------|
| 31:29 | Reserved, must be zero |
| 28 | Platform Data Region Write Access. If the bit is set, this master can erase and write that particular region through register accesses. |
| 27 | GbE Region Write Access. If the bit is set, this master can erase and write that particular region through register accesses. |
| 26 | ME Region Write Access. If the bit is set, this master can erase and write that particular region through register accesses. |
| 25 | Host CPU/BIOS Master Region Write Access. If the bit is set, this master can erase and write that particular region through register accesses. Bit 25 is a don't care as the primary master always has read/write permissions to it's primary region |
| 24 | Flash Descriptor Region Write Access. If the bit is set, this master can erase and write that particular region through register accesses. |
| 23:21 | Reserved, must be zero |
| 20 | Platform Data Region Read Access. If the bit is set, this master can read that particular region through register accesses. |
| 19 | GbE Region Read Access. If the bit is set, this master can read that particular region through register accesses. |
| 18 | ME Region Read Access. If the bit is set, this master can read that particular region through register accesses. |
| 17 | Host CPU/BIOS Master Region Read Access. If the bit is set, this master can read that particular region through register accesses. Bit 17 is a don't care as the primary master always has read/write permissions to it's primary region |
| 16 | Flash Descriptor Region Read Access. If the bit is set, this master can read that particular region through register accesses. |
| 15:0 | Requester ID. This is the Requester ID of the Host processor. This must be set to 0000h. |



22.2.4.2 FLMSTR2—Flash Master 2 (ME) (Flash Descriptor Registers)

Memory Address: FMBA + 004h
Size: 32 bits

Default Value: h

| Bits | Description |
|-------|----------------------------------------------------------------------------------------------------------------------------------------------------------------------------------------------------------------------------------------------------|
| 31:29 | Reserved, must be zero |
| 28 | Platform Data Region Write Access. If the bit is set, this master can erase and write that particular region through register accesses. |
| 27 | GbE Region Write Access. If the bit is set, this master can erase and write that particular region through register accesses. |
| 26 | ME Master Region Write Access. If the bit is set, this master can erase and write that particular region through register accesses. Bit 26 is a don't care as the primary master always has read/write permissions to its primary region |
| 25 | Host CPU/BIOS Region Write Access. If the bit is set, this master can erase and write that particular region through register accesses. |
| 24 | Flash Descriptor Region Write Access. If the bit is set, this master can erase and write that particular region through register accesses. |
| 23:21 | Reserved, must be zero |
| 20 | Platform Data Region Read Access. If the bit is set, this master can read that particular region through register accesses. |
| 19 | GbE Region Read Access. If the bit is set, this master can read that particular region through register accesses. |
| 18 | ME Master Region Read Access. If the bit is set, this master can read that particular region through register accesses. Bit 18 is a don't care as the primary master always has read/write permissions to its primary region |
| 17 | Host CPU/BIOS Region Read Access. If the bit is set, this master can read that particular region through register accesses. |
| 16 | Flash Descriptor Region Read Access. If the bit is set, this master can read that particular region through register accesses. |
| 15:0 | Requester ID. This is the Requester ID of the Intel Management Engine. This must be set to 0000h. |



22.2.4.3 FLMSTR3—Flash Master 3 (GbE) (Flash Descriptor Registers)

Memory Address: FMBA + 008h Default Value: h
 Size: 32 bits

| Bits | Description |
|-------|------------------------------------------------------------------------------------------------------------------------------------------------------------------------------------------------------------------------------------------------------|
| 31:29 | Reserved, must be zero |
| 28 | Platform Data Region Write Access. If the bit is set, this master can erase and write that particular region through register accesses. |
| 27 | GbE Master Region Write Access. If the bit is set, this master can erase and write that particular region through register accesses. Bit 27 is a don't care as the primary master always has read/write permissions to it's primary region |
| 26 | ME Region Write Access. If the bit is set, this master can erase and write that particular region through register accesses. |
| 25 | Host CPU/BIOS Region Write Access. If the bit is set, this master can erase and write that particular region through register accesses. |
| 24 | Flash Descriptor Region Write Access. If the bit is set, this master can erase and write that particular region through register accesses. |
| 23:21 | Reserved, must be zero |
| 20 | Platform Data Region Read Access. If the bit is set, this master can read that particular region through register accesses. |
| 19 | GbE Master Region Read Access. If the bit is set, this master can read that particular region through register accesses. Bit 19 is a don't care as the primary master always has read/write permissions to it's primary region |
| 18 | ME Region Read Access. If the bit is set, this master can read that particular region through register accesses. |
| 17 | Host CPU/BIOS Region Read Access. If the bit is set, this master can read that particular region through register accesses. |
| 16 | Flash Descriptor Region Read Access. If the bit is set, this master can read that particular region through register accesses. |
| 15:0 | Requester ID. This is the Requester ID of the GbE. This must be set to 0218h. |



22.2.5 Descriptor Upper Map Section

22.2.5.1 FLUMAP1—Flash Upper Map 1 (Flash Descriptor Registers)

Memory Address: FDBAR + EFCh Default Value: 0000FFFFh
 Size: 32 bits

| Bits | Default | Description |
|-------|---------|---------------------------------------------------------------------------------------------------------------------------------------------------------------------------------------------------------------------------------------------------------------------------------------------------------------------------------------------------------------------------|
| 31:16 | 0 | Reserved |
| 15:8 | 1 | ME VSCC Table Length (VTL). Identifies the 1s based number of DWORDS contained in the VSCC Table. Each SPI component entry in the table is 2 DWORDS long. |
| 7:0 | 1 | ME VSCC Table Base Address (VTBA). This identifies address bits [11:4] for the VSCC Table portion of the Flash Descriptor. Bits [24:12] and bits [3:0] are 0. NOTE: VTBA should be above the offset for MCHSTRP0 and below FLUMAP1. It is recommended that this address is set based on the anticipated maximum number of different flash parts entries. |

22.2.6 Intel ME Vendor Specific Component Capabilities Table

Entries in this table allow support for a SPI flash part for Intel® Quiet System Technology. BIOS will still need to set up the proper VSCC registers for BIOS and Integrated Gigabit Ethernet usage.

Each VSCC table entry is composed of two 32 bit fields: JEDEC ID and the corresponding VSCC value.

22.2.6.1 JID0—JEDEC-ID 0 Register (Flash Descriptor Registers)

Memory Address: VTBA + 000h Default Value:
 Size: 32 bits

| Bits | Description |
|-------|-------------------------------------------------------------------------------------------------------------------------------------------------------------------------------------------------|
| 31:24 | Reserved |
| 23:16 | SPI Component Device ID 1. This field identifies the second byte of the Device ID of the SPI Flash Component. This is the third byte returned by the Read JEDEC-ID command (opcode 9Fh). |
| 15:8 | SPI Component Device ID 0. This field identifies the first byte of the Device ID of the SPI Flash Component. This is the second byte returned by the Read JEDEC-ID command (opcode 9Fh). |
| 7:0 | SPI Component Vendor ID. This field identifies the one byte Vendor ID of the SPI Flash Component. This is the first byte returned by the Read JEDEC-ID command (opcode 9Fh). |



22.2.6.2 VSCCO—Vendor Specific Component Capabilities 0 (Flash Descriptor Registers)

Memory Address: VTBA + 004h Default Value:
Size: 32 bits

Note: In this table “Lower” applies to characteristics of all flash space below the Flash Partition Boundary Address (FPBA). “Upper” applies to characteristics of all flash space above the FPBA.

| Bits | Description |
|-------|-----------------------------------------------------------------------------------------------------------------------------------------------------------------------------------------------------------------------------------------------------------------------------------------------------------------------------------------------------------------------------------------------------------------------------------------------------------------------------------------------------------------------------|
| 31:16 | Lower Erase Opcode (LEO). This register must be programmed with the Flash erase instruction opcode that corresponds to the erase size that is in LBES. |
| 23:21 | Reserved |
| 20 | Lower Write Enable on Write Status (LWEWS). 0 = No write to the SPI flash’s status register required prior to a write 1 = A write of 00h to the SPI flash’s status register is required prior to write and erase to unlock the flash component. 06h is the opcode used to unlock the Status register. NOTES: 1. This bit should not be set to 1 if the SPI flash status register is non-volatile. This may lead to premature flash wear out. 2. Bit 20 and bit 19 should NOT be both set to 1. |
| 19 | Lower Write Status Required (LWSR). 0 = No requirement to write to the Status Register prior to a write 1 = A write of 00h to the SPI flash’s status register is required prior to write and erase to unlock the flash component. 50h is the opcode used to unlock the Status register. NOTES: 1. Bit 20 and bit 19 should NOT be both set to 1. 2. Bit 19 should not be set if the flash part does not support the opcode 50h to unlock the status register. |
| 18 | Lower Write Granularity (LWG). 0 = 1 Byte 1 = 64 Byte |
| 17:16 | Lower Block/Sector Erase Size (LBES). This field identifies the erasable sector size for all Flash space below the flash partition boundary address. 00 = 256 Byte 01 = 4 KB 10 = 8 KB 11 = 64 KB |
| 15:8 | Upper Erase Opcode (UEO). This register must be programmed with the Flash erase instruction opcode that corresponds to the erase size that is in LBES. |
| 7:5 | Reserved |



| Bits | Description |
|------|-------------------------------------------------------------------------------------------------------------------------------------------------------------------------------------------------------------------------------------------------------------------------------------------------------------------------------------------------------------------------------------------------------------------------------------------------------------------------------------------------------------------------------------------------------------------------------------------------------------|
| 4 | <p>Upper Write Enable on Write Status (UWEWS). 0 = No write to the SPI flash's status register required prior to a write 1 = A write of 00h to the SPI flash's status register is required prior to write and erase to unlock the flash component. 06h is the opcode used to unlock the Status register.</p> <p>NOTES:</p> <ol style="list-style-type: none"> This bit should not be set to 1 if the SPI flash status register is non-volatile. This may lead to premature flash wear out. Bit 4 and bit 3 should NOT be both set to 1. |
| 3 | <p>Upper Write Status Required (UWSR). 0 = No requirement to write to the Status Register prior to a write 1 = A write of 00h to the SPI flash's status register is required prior to write and erase to unlock the flash component. 50h is the opcode used to unlock the Status register.</p> <p>NOTES:</p> <ol style="list-style-type: none"> Bit 4 and bit 3 should NOT be both set to 1. Bit 3 should not be set if the flash part does not support the opcode 50h to unlock the status register. |
| 2 | <p>Upper Write Granularity (UWG). 0 = 1 Byte 1 = 64 Bytes</p> |
| 1:0 | <p>Upper Block/Sector Erase Size (UBES). This field identifies the erasable sector size for all Flash components.</p> <p>00 = 256 Bytes 01 = 4 KB 10 = 8 KB 11 = 64 KB</p> |

22.2.6.3 JIDn—JEDEC-ID Register n (Flash Descriptor Registers)

Memory Address: VTBA + (n*8)h Default Value:
 Size: 32 bits

Note: "n" is an integer denoting the index of the Intel ME VSCC table.

| Bits | Description |
|-------|-------------------------------------------------------------------------------------------------------------------------------------------------------------------------------------------------|
| 31:24 | Reserved |
| 23:16 | SPI Component Device ID 1. This field identifies the second byte of the Device ID of the SPI Flash Component. This is the third byte returned by the Read JEDEC-ID command (opcode 9Fh). |
| 15:8 | SPI Component Device ID 0. This field identifies the first byte of the Device ID of the SPI Flash Component. This is the second byte returned by the Read JEDEC-ID command (opcode 9Fh). |
| 7:0 | SPI Component Vendor ID. This field identifies the one byte Vendor ID of the SPI Flash Component. This is the first byte returned by the Read JEDEC-ID command (opcode 9Fh). |



22.2.6.4 VSCCn—Vendor Specific Component Capabilities n (Flash Descriptor Registers)

Memory Address: VTBA + 004h + (n*8)h Default Value:
Size: 32 bits

Note: “n” is an integer denoting the index of the Intel ME VSCC table.

Note: In this table “Lower” applies to characteristics of all flash space below the Flash Partition Boundary Address (FPBA). “Upper” applies to characteristics of all flash space above the FPBA.

| Bits | Description |
|-------|-----------------------------------------------------------------------------------------------------------------------------------------------------------------------------------------------------------------------------------------------------------------------------------------------------------------------------------------------------------------------------------------------------------------------------------------------------------------------------------------------------------------------------|
| 31:16 | Lower Erase Opcode (LEO). This field must be programmed with the Flash erase instruction opcode that corresponds to the erase size that is in LBES. |
| 23:21 | Reserved |
| 20 | Lower Write Enable on Write Status (LWEWS). 0 = No write to the SPI flash’s status register required prior to a write 1 = A write of 00h to the SPI flash’s status register is required prior to write and erase to unlock the flash component. 06h is the opcode used to unlock the Status register. NOTES: 1. This bit should not be set to 1 if the SPI flash status register is non-volatile. This may lead to premature flash wear out. 2. Bit 20 and bit 19 should NOT be both set to 1. |
| 19 | Lower Write Status Required (LWSR). 0 = No requirement to write to the Status Register prior to a write 1 = A write of 00h to the SPI flash’s status register is required prior to write and erase to unlock the flash component. 50h is the opcode used to unlock the Status register. NOTES: 1. Bit 20 and bit 19 should NOT be both set to 1. 2. Bit 19 should not be set if the flash part does not support the opcode 50h to unlock the status register. |
| 18 | Lower Write Granularity (LWG). 0 = 1 Byte 1 = 64 Byte |
| 17:16 | Lower Block/Sector Erase Size (LBES). This field identifies the erasable sector size for all Flash space below the flash partition boundary address. Valid Bit Settings: 00 = 256 Byte 01 = 4 KB 10 = 8 KB 11 = 64 KB |
| 15:8 | Upper Erase Opcode (UEO). This field must be programmed with the Flash erase instruction opcode that corresponds to the erase size that is in LBES. |
| 7:5 | Reserved |



| Bits | Description |
|------|---------------------------------------------------------------------------------------------------------------------------------------------------------------------------------------------------------------------------------------------------------------------------------------------------------------------------------------------------------------------------------------------------------------------------------------------------------------------------------------------------------------------------|
| 4 | Upper Write Enable on Write Status (UWEWS). 0 = No write to the SPI flash's status register required prior to a write 1 = A write of 00h to the SPI flash's status register is required prior to write and erase to unlock the flash component. 06h is the opcode used to unlock the Status register. NOTES: 1. This bit should not be set to 1 if the SPI flash status register is non-volatile. This may lead to premature flash wear out. 2. Bit 4 and bit 3 should NOT be both set to 1. |
| 3 | Upper Write Status Required (UWSR). 0 = No requirement to write to the Status Register prior to a write 1 = A write of 00h to the SPI flash's status register is required prior to write and erase to unlock the flash component. 50h is the opcode used to unlock the Status register. NOTES: 1. Bit 4 and bit 3 should NOT be both set to 1. 2. Bit 3 should not be set if the flash part does not support the opcode 50h to unlock the status register. |
| 2 | Upper Write Granularity (UWG). 0 = 1 Byte 1 = 64 Bytes |
| 1:0 | Upper Block/Sector Erase Size (UBES). This field identifies the erasable sector size for all Flash components. 00 = 256 Bytes 01 = 4 KB 10 = 8 KB 11 = 64 KB |



22.4.1 GLFPR –Gigabit LAN Flash Primary Region Register (GbE LAN Memory Mapped Configuration Registers)

Memory Address: MBARB + 00h Attribute: RO
Default Value: 00000000h Size: 32 bits

| Bit | Description |
|-------|----------------------------------------------------------------------------------------------------------------------------------------------------------------------------------------------------------------------|
| 31:29 | Reserved |
| 28:16 | GbE Flash Primary Region Limit (PRL) — RO. This specifies address bits 24:12 for the Primary Region Limit. The value in this register loaded from the contents in the Flash Descriptor.FLREG3.Region Limit |
| 15:13 | Reserved |
| 12:0 | GbE Flash Primary Region Base (PRB) — RO. This specifies address bits 24:12 for the Primary Region Base The value in this register is loaded from the contents in the Flash Descriptor.FLREG3.Region Base |



22.4.2 HSFS—Hardware Sequencing Flash Status Register (GbE LAN Memory Mapped Configuration Registers)

Memory Address: MBARB + 04h Attribute: RO, R/WC, R/W
 Default Value: 0000h Size: 16 bits

| Bit | Description |
|------|----------------------------------------------------------------------------------------------------------------------------------------------------------------------------------------------------------------------------------------------------------------------------------------------------------------------------------------------------------------------------------------------------------------------------------------------------------------------------------------------------------------------------------------------------|
| 15 | Flash Configuration Lock-Down (FLOCKDN) — R/W. When set to 1, those Flash Program Registers that are locked down by this FLOCKDN bit cannot be written. Once set to 1, this bit can only be cleared by a hardware reset due to a global reset or host partition reset in an Intel ME enabled system. |
| 14 | Flash Descriptor Valid (FDV) — RO. This bit is set to a 1 if the Flash Controller read the correct Flash Descriptor Signature. If the Flash Descriptor Valid bit is not '1', software cannot use the Hardware Sequencing registers, but must use the software sequencing registers. Any attempt to use the Hardware Sequencing registers will result in the FCERR bit being set. |
| 13 | Flash Descriptor Override Pin Strap Status (FDOPSS) — RO. This bit reflects the value the Flash Descriptor Override Pin-Strap. 0 = No override 1 = The Flash Descriptor Override strap is set |
| 12:6 | Reserved |
| 5 | SPI Cycle In Progress (SCIP) — RO. Hardware sets this bit when software sets the Flash Cycle Go (FGO) bit in the Hardware Sequencing Flash Control register. This bit remains set until the cycle completes on the SPI interface. Hardware automatically sets and clears this bit so that software can determine when read data is valid and/or when it is safe to begin programming the next command. Software must only program the next command when this bit is 0. |
| 4:3 | Block/Sector Erase Size (BERASE) — RO. This field identifies the erasable sector size for all Flash components. 00 = 256 Byte 01 = 4 K Byte 10 = 8 K Byte 11 = 64 K Byte If the FLA is less than FPBA then this field reflects the value in the LVSCC.LBES register. If the FLA is greater or equal to FPBA then this field reflects the value in the UVSCC.UBES register. |
| 2 | Access Error Log (AEL) — R/W/C. Hardware sets this bit to a 1 when an attempt was made to access the BIOS region using the direct access method or an access to the BIOS Program Registers that violated the security restrictions. This bit is simply a log of an access security violation. This bit is cleared by software writing a '1' |
| 1 | Flash Cycle Error (FCERR) — R/W/C. Hardware sets this bit to 1 when an program register access is blocked to the FLASH due to one of the protection policies or when any of the programmed cycle registers is written while a programmed access is already in progress. This bit remains asserted until cleared by software writing a 1 or until hardware reset occurs due to a global reset or host partition reset in an Intel ME enabled system. Software must clear this bit before setting the FLASH Cycle GO bit in this register. |
| 0 | Flash Cycle Done (FDONE) — R/W/C. The ICH sets this bit to 1 when the SPI Cycle completes after software previously set the FGO bit. This bit remains asserted until cleared by software writing a 1 or hardware reset due to a global reset or host partition reset in an Intel ME enabled system. When this bit is set and the SPI SMI# Enable bit is set, an internal signal is asserted to the SMI# generation block. Software must make sure this bit is cleared prior to enabling the SPI SMI# assertion for a new programmed access. |



22.4.3 HSFC—Hardware Sequencing Flash Control Register (GbE LAN Memory Mapped Configuration Registers)

Memory Address: MBARB + 06h Attribute: R/W, R/WS
 Default Value: 0000h Size: 16 bits

| Bit | Description |
|-------|--------------------------------------------------------------------------------------------------------------------------------------------------------------------------------------------------------------------------------------------------------------------------------------------------------------------------------------------------------------------------------------------------------------------------------------------------------------------------------------------------------------------------------------------------------------------------------------------------------------------------------------------------------------------------------------------------------------------------------------|
| 15:10 | Reserved |
| 9:8 | Flash Data Byte Count (FDBC) — R/W. This field specifies the number of bytes to shift in or out during the data portion of the SPI cycle. The content's of this register are 0s based with 0b representing 1 byte and 11b representing 4 bytes. The number of bytes transferred is the value of this field plus 1. This field is ignored for the Block Erase command. |
| 7:3 | Reserved |
| 2:1 | FLASH Cycle (FCYCLE) — R/W. This field defines the Flash SPI cycle type generated to the FLASH when the FGO bit is set as defined below: 00 = Read (1 up to 4 bytes by setting FDBC) 01 = Reserved 10 = Write (1 up to 4 bytes by setting FDBC) 11 = Block Erase |
| 0 | Flash Cycle Go (FGO) — R/W/S. A write to this register with a '1' in this bit initiates a request to the Flash SPI Arbiter to start a cycle. This register is cleared by hardware when the cycle is granted by the SPI arbiter to run the cycle on the SPI bus. When the cycle is complete, the FDONE bit is set. Software is forbidden to write to any register in the HSFLCTL register between the FGO bit getting set and the FDONE bit being cleared. Any attempt to violate this rule will be ignored by hardware. Hardware allows other bits in this register to be programmed for the same transaction when writing this bit to 1. This saves an additional memory write. This bit always returns 0 on reads. |

22.4.4 FADDR—Flash Address Register (GbE LAN Memory Mapped Configuration Registers)

Memory Address: MBARB + 08h Attribute: R/W
 Default Value: 00000000h Size: 32 bits

| Bit | Description |
|-------|-----------------------------------------------------------------------------------------------------------------------------------------------------------------------------------------------------------------------------------------------------------------------|
| 31:25 | Reserved |
| 24:0 | Flash Linear Address (FLA) — R/W. The FLA is the starting byte linear address of a SPI Read or Write cycle or an address within a Block for the Block Erase command. The Flash Linear Address must fall within a region for which BIOS has access permissions. |



22.4.5 FDATA0—Flash Data 0 Register (GbE LAN Memory Mapped Configuration Registers)

Memory Address: MBARB + 10h Attribute: R/W
 Default Value: 00000000h Size: 32 bits

| Bit | Description |
|------|---------------------------------------------------------------------------------------------------------------------------------------------------------------------------------------------------------------------------------------------------------------------------------------------------------------------------------------------------------------------------------------------------------------------------------------------------------------------------------------------------------------------------------------------------------------------------------------------------------------------------------------------------------------------------------------------------------------------------------------------------------------------------------------------------------------------------------------------------------------------------------------------------------------------------------------|
| 31:0 | <p>Flash Data 0 (FDO) — R/W. This field is shifted out as the SPI Data on the Master-Out Slave-In Data pin during the data portion of the SPI cycle.</p> <p>This register also shifts in the data from the Master-In Slave-Out pin into this register during the data portion of the SPI cycle.</p> <p>The data is always shifted starting with the least significant byte, msb to lsb, followed by the next least significant byte, msb to lsb, etc. Specifically, the shift order on SPI in terms of bits within this register is: 7-6-5-4-3-2-1-0-15-14-13-...-8-23-22-...-16-31...24. Bit 24 is the last bit shifted out/in. There are no alignment assumptions; byte 0 always represents the value specified by the cycle address.</p> <p>Note that the data in this register may be modified by the hardware during any programmed SPI transaction. Direct Memory Reads do not modify the contents of this register.</p> |



22.4.6 FRAP—Flash Regions Access Permissions Register (GbE LAN Memory Mapped Configuration Registers)

Memory Address: MBARB + 50h Attribute: RO, R/W
 Default Value: 00000808h Size: 32 bits

| Bit | Description |
|-------|---------------------------------------------------------------------------------------------------------------------------------------------------------------------------------------------------------------------------------------------------------------------------------------------------------------------------------------------------------------------------------------------------------------------------------------------------------------------------------|
| 31:28 | Reserved |
| 27:25 | <p>GbE Master Write Access Grant (GMWAG) — R/W. Each bit 27:25 corresponds to Master[3:1]. GbE can grant one or more masters write access to the GbE region 3 overriding the permissions in the Flash Descriptor.</p> <p>Master[1] is Host CPU/BIOS, Master[2] is Intel Management Engine, Master[3] is Host processor/GbE.</p> <p>The contents of this register are locked by the FLOCKDN bit.</p> |
| 24:20 | Reserved |
| 19:17 | <p>GbE Master Read Access Grant (GMRAG) — R/W. Each bit 19:17 corresponds to Master[3:1]. GbE can grant one or more masters read access to the GbE region 3 overriding the read permissions in the Flash Descriptor.</p> <p>Master[1] is Host processor/BIOS, Master[2] is Intel Management Engine, Master[3] is GbE.</p> <p>The contents of this register are locked by the FLOCKDN bit</p> |
| 16:12 | Reserved |
| 11:8 | <p>GbE Region Write Access (GRWA) — RO. Each bit 11:8 corresponds to Regions 3:0. If the bit is set, this master can erase and write that particular region through register accesses.</p> <p>The contents of this register are that of the Flash Descriptor. Flash Master 3.Master Region Write Access OR a particular master has granted GbE write permissions in their Master Write Access Grant register OR the Flash Descriptor Security Override strap is set.</p> |
| 7:4 | Reserved |
| 3:0 | <p>GbE Region Read Access (GRRR) — RO. Each bit 3:0 corresponds to Regions 3:0. If the bit is set, this master can read that particular region through register accesses.</p> <p>The contents of this register are that of the Flash Descriptor. Flash Master 3.Master Region Write Access OR a particular master has granted GbE read permissions in their Master Read Access Grant register.</p> |



22.4.7 FREG0—Flash Region 0 (Flash Descriptor) Register (GbE LAN Memory Mapped Configuration Registers)

Memory Address: MBARB + 54h Attribute: RO
 Default Value: 00000000h Size: 32 bits

| Bit | Description |
|-------|---------------------------------------------------------------------------------------------------------------------------------------------------------------------------------------------|
| 31:29 | Reserved |
| 28:16 | Region Limit (RL) — RO. This specifies address bits 24:12 for the Region 0 Limit. The value in this register is loaded from the contents in the Flash Descriptor.FLREG0.Region Limit |
| 15:13 | Reserved |
| 12:0 | Region Base (RB) — RO. This specifies address bits 24:12 for the Region 0 Base. The value in this register is loaded from the contents in the Flash Descriptor.FLREG0.Region Base |

22.4.8 FREG1—Flash Region 1 (BIOS Descriptor) Register (GbE LAN Memory Mapped Configuration Registers)

Memory Address: MBARB + 58h Attribute: RO
 Default Value: 00000000h Size: 32 bits

| Bit | Description |
|-------|----------------------------------------------------------------------------------------------------------------------------------------------------------------------------------------------|
| 31:29 | Reserved |
| 28:16 | Region Limit (RL) — RO. This specifies address bits 24:12 for the Region 1 Limit. The value in this register is loaded from the contents in the Flash Descriptor.FLREG1.Region Limit. |
| 15:13 | Reserved |
| 12:0 | Region Base (RB) — RO. This specifies address bits 24:12 for the Region 1 Base. The value in this register is loaded from the contents in the Flash Descriptor.FLREG1.Region Base. |

22.4.9 FREG2—Flash Region 2 (ME) Register (GbE LAN Memory Mapped Configuration Registers)

Memory Address: MBARB + 5Ch Attribute: RO
 Default Value: 00000000h Size: 32 bits

| Bit | Description |
|-------|----------------------------------------------------------------------------------------------------------------------------------------------------------------------------------------------|
| 31:29 | Reserved |
| 28:16 | Region Limit (RL) — RO. This specifies address bits 24:12 for the Region 2 Limit. The value in this register is loaded from the contents in the Flash Descriptor.FLREG2.Region Limit. |
| 15:13 | Reserved |
| 12:0 | Region Base (RB) — RO. This specifies address bits 24:12 for the Region 2 Base. The value in this register is loaded from the contents in the Flash Descriptor.FLREG2.Region Base. |



22.4.10 FREG3—Flash Region 3 (GbE) Register (GbE LAN Memory Mapped Configuration Registers)

Memory Address: MBARB + 60h Attribute: RO
Default Value: 00000000h Size: 32 bits

| Bit | Description |
|-------|----------------------------------------------------------------------------------------------------------------------------------------------------------------------------------------------|
| 31:29 | Reserved |
| 28:16 | Region Limit (RL) — RO. This specifies address bits 24:12 for the Region 3 Limit. The value in this register is loaded from the contents in the Flash Descriptor.FLREG3.Region Limit. |
| 15:13 | Reserved |
| 12:0 | Region Base (RB) — RO. This specifies address bits 24:12 for the Region 3 Base. The value in this register is loaded from the contents in the Flash Descriptor.FLREG3.Region Base. |

22.4.11 FPR0—Flash Protected Range 0 Register (GbE LAN Memory Mapped Configuration Registers)

Memory Address: MBARB + 74h Attribute: R/W
Default Value: 00000000h Size: 32 bits

Note: This register can not be written when the FLOCKDN bit is set to 1.

| Bit | Description |
|-------|------------------------------------------------------------------------------------------------------------------------------------------------------------------------------------------------------------------------------------------------------------------------------------------------------------------|
| 31 | Write Protection Enable — R/W. When set, this bit indicates that the Base and Limit fields in this register are valid and that writes and erases directed to addresses between them (inclusive) must be blocked by hardware. The base and limit fields are ignored when this bit is cleared. |
| 30:29 | Reserved |
| 28:16 | Protected Range Limit — R/W. This field corresponds to FLA address bits 24:12 and specifies the upper limit of the protected range. Address bits 11:0 are assumed to be FFFh for the limit comparison. Any address greater than the value programmed in this field is unaffected by this protected range. |
| 15 | Read Protection Enable — R/W. When set, this bit indicates that the Base and Limit fields in this register are valid and that read directed to addresses between them (inclusive) must be blocked by hardware. The base and limit fields are ignored when this bit is cleared. |
| 14:13 | Reserved |
| 12:0 | Protected Range Base — R/W. This field corresponds to FLA address bits 24:12 and specifies the lower base of the protected range. Address bits 11:0 are assumed to be 000h for the base comparison. Any address less than the value programmed in this field is unaffected by this protected range. |



22.4.12 FPR1—Flash Protected Range 1 Register (GbE LAN Memory Mapped Configuration Registers)

Memory Address: MBARB + 78h Attribute: R/W
 Default Value: 00000000h Size: 32 bits

Note: This register can not be written when the FLOCKDN bit is set to 1.

| Bit | Description |
|-------|------------------------------------------------------------------------------------------------------------------------------------------------------------------------------------------------------------------------------------------------------------------------------------------------------------------|
| 31 | Write Protection Enable — R/W. When set, this bit indicates that the Base and Limit fields in this register are valid and that writes and erases directed to addresses between them (inclusive) must be blocked by hardware. The base and limit fields are ignored when this bit is cleared. |
| 30:29 | Reserved |
| 28:16 | Protected Range Limit — R/W. This field corresponds to FLA address bits 24:12 and specifies the upper limit of the protected range. Address bits 11:0 are assumed to be FFFh for the limit comparison. Any address greater than the value programmed in this field is unaffected by this protected range. |
| 15 | Read Protection Enable — R/W. When set, this bit indicates that the Base and Limit fields in this register are valid and that read directed to addresses between them (inclusive) must be blocked by hardware. The base and limit fields are ignored when this bit is cleared. |
| 14:13 | Reserved |
| 12:0 | Protected Range Base — R/W. This field corresponds to FLA address bits 24:12 and specifies the lower base of the protected range. Address bits 11:0 are assumed to be 000h for the base comparison. Any address less than the value programmed in this field is unaffected by this protected range. |



22.4.13 SSFS—Software Sequencing Flash Status Register (GbE LAN Memory Mapped Configuration Registers)

Memory Address: MBARB + 90h Attribute: RO, R/WC
Default Value: 00h Size: 8 bits

Note: The Software Sequencing control and status registers are reserved if the hardware sequencing control and status registers are used.

| Bit | Description |
|-----|-------------------------------------------------------------------------------------------------------------------------------------------------------------------------------------------------------------------------------------------------------------------------------------------------------------------------------------------------------------------------------------------------------------------------------------------------------------------------------------------------------------------------------------------------------|
| 7:5 | Reserved |
| 4 | Access Error Log (AEL) — RO. This bit reflects the value of the Hardware Sequencing Status AEL register. |
| 3 | Flash Cycle Error (FCERR) — R/WC. Hardware sets this bit to 1 when a programmed access is blocked from running on the SPI interface due to one of the protection policies or when any of the programmed cycle registers is written while a programmed access is already in progress. This bit remains asserted until cleared by software writing a 1 or hardware reset due to a global reset or host partition reset in an Intel ME enabled system. |
| 2 | Cycle Done Status — R/WC. The ICH sets this bit to 1 when the SPI Cycle completes (i.e., SCIP bit is 0) after software sets the GO bit. This bit remains asserted until cleared by software writing a 1 or hardware reset due to a global reset or host partition reset in an Intel ME enabled system. When this bit is set and the SPI SMI# Enable bit is set, an internal signal is asserted to the SMI# generation block. Software must make sure this bit is cleared prior to enabling the SPI SMI# assertion for a new programmed access. |
| 1 | Reserved |
| 0 | SPI Cycle In Progress (SCIP) — RO. Hardware sets this bit when software sets the SPI Cycle Go bit in the Command register. This bit remains set until the cycle completes on the SPI interface. Hardware automatically sets and clears this bit so that software can determine when read data is valid and/or when it is safe to begin programming the next command. Software must only program the next command when this bit is 0. |



22.4.14 SSFC—Software Sequencing Flash Control Register (GbE LAN Memory Mapped Configuration Registers)

Memory Address: MBARB + 91h Attribute: R/W
 Default Value: 000000h Size: 24 bits

| Bit | Description |
|-------|-----------------------------------------------------------------------------------------------------------------------------------------------------------------------------------------------------------------------------------------------------------------------------------------------------------------------------------------------------------------------------------------------------------------------------------------------------------------------------------------------------------------------------------------------------------------------------------------------------------------------------------------------------------------------------------------------------------|
| 23:19 | Reserved |
| 18:16 | <p>SPI Cycle Frequency (SCF) — R/W. This register sets frequency to use for all SPI software sequencing cycles (write, erase, fast read, read status, etc.) except for the read cycle which always run at 20MHz.</p> <p>000 = 20 MHz 001 = 33 MHz All other values = Reserved.</p> <p>This register is locked when the SPI Configuration Lock-Down bit is set.</p> |
| 15 | Reserved |
| 14 | <p>Data Cycle (DS) — R/W. When set to 1, there is data that corresponds to this transaction. When 0, no data is delivered for this cycle, and the DBC and data fields themselves are don't cares</p> |
| 13:8 | <p>Data Byte Count (DBC) — R/W. This field specifies the number of bytes to shift in or out during the data portion of the SPI cycle. The valid settings (in decimal) are any value from 0 to 3. The number of bytes transferred is the value of this field plus 1. Note that when this field is 00b, then there is 1 byte to transfer and that 11b means there are 4 bytes to transfer.</p> |
| 7 | Reserved |
| 6:4 | <p>Cycle Opcode Pointer (COP) — R/W. This field selects one of the programmed opcodes in the Opcode Menu to be used as the SPI Command/Opcod. In the case of an Atomic Cycle Sequence, this determines the second command.</p> |
| 3 | <p>Sequence Prefix Opcode Pointer (SPOP) — R/W. This field selects one of the two programmed prefix opcodes for use when performing an Atomic Cycle Sequence. A value of 0 points to the opcode in the least significant byte of the Prefix Opcodes register. By making this programmable, the ICH supports flash devices that have different opcodes for enabling writes to the data space vs. status register.</p> |
| 2 | <p>Atomic Cycle Sequence (ACS) — R/W. When set to 1 along with the SCGO assertion, the ICH will execute a sequence of commands on the SPI interface without allowing the LAN component to arbitrate and interleave cycles. The sequence is composed of:</p> <ul style="list-style-type: none"> • Atomic Sequence Prefix Command (8-bit opcode only) • Primary Command specified below by software (can include address and data) • Polling the Flash Status Register (opcode 05h) until bit 0 becomes 0b. <p>The SPI Cycle in Progress bit remains set and the Cycle Done Status bit remains unset until the Busy bit in the Flash Status Register returns 0.</p> |
| 1 | <p>SPI Cycle Go (SCGO) — R/WS. This bit always returns 0 on reads. However, a write to this register with a '1' in this bit starts the SPI cycle defined by the other bits of this register. The "SPI Cycle in Progress" (SCIP) bit gets set by this action. Hardware must ignore writes to this bit while the Cycle In Progress bit is set.</p> <p>Hardware allows other bits in this register to be programmed for the same transaction when writing this bit to 1. This saves an additional memory write.</p> |
| 0 | Reserved |



22.4.15 PREOP—Prefix Opcode Configuration Register (GbE LAN Memory Mapped Configuration Registers)

Memory Address: MBARB + 94h Attribute: R/W
Default Value: 0000h Size: 16 bits

| Bit | Description |
|------|----------------------------------------------------------------------------------------------------------------------------------------------------------|
| 15:8 | Prefix Opcode 1 — R/W. Software programs an SPI opcode into this field that is permitted to run as the first command in an atomic cycle sequence. |
| 7:0 | Prefix Opcode 0 — R/W. Software programs an SPI opcode into this field that is permitted to run as the first command in an atomic cycle sequence. |

NOTE: This register is not writable when the SPI Configuration Lock-Down bit (MBARB + 00h: 15) is set.

22.4.16 OPTYPE—Opcode Type Configuration Register (GbE LAN Memory Mapped Configuration Registers)

Memory Address: MBARB + 96h Attribute: R/W
Default Value: 0000h Size: 16 bits

Entries in this register correspond to the entries in the Opcode Menu Configuration register.

Note: The definition below only provides write protection for opcodes that have addresses associated with them. Therefore, any erase or write opcodes that do not use an address should be avoided (for example, “Chip Erase” and “Auto-Address Increment Byte Program”).

| Bit | Description |
|-------|------------------------------------------------------------------------------------------------------------------------------------------------------------------------------------------------------------------------------------------------------------------------------------------------------------------------------------------------------------------------------------------------------------------------------------------------------------------------------------------------------|
| 15:14 | Opcode Type 7 — R/W. See the description for bits 1:0 |
| 13:12 | Opcode Type 6 — R/W. See the description for bits 1:0 |
| 11:10 | Opcode Type 5 — R/W. See the description for bits 1:0 |
| 9:8 | Opcode Type 4 — R/W. See the description for bits 1:0 |
| 7:6 | Opcode Type 3 — R/W. See the description for bits 1:0 |
| 5:4 | Opcode Type 2 — R/W. See the description for bits 1:0 |
| 3:2 | Opcode Type 1 — R/W. See the description for bits 1:0 |
| 1:0 | Opcode Type 0 — R/W. This field specifies information about the corresponding Opcode 0. This information allows the hardware to 1) know whether to use the address field and 2) provide BIOS and Shared Flash protection capabilities. The encoding of the two bits is: 00 = No address associated with this Opcode; Read cycle type 01 = No address associated with this Opcode; Write cycle type 10 = Address required; Read cycle type 11 = Address required; Write cycle type |

NOTE: This register is not writable when the SPI Configuration Lock-Down bit (MBARB + 00h: 15) is set.



22.4.17 OPMENU—Opcode Menu Configuration Register (GbE LAN Memory Mapped Configuration Registers)

Memory Address: MBARB + 98h Attribute: R/W
 Default Value: 0000000000000000h Size: 64 bits

Eight entries are available in this register to give GbE a sufficient set of commands for communicating with the flash device, while also restricting what malicious software can do. This keeps the hardware flexible enough to operate with a wide variety of SPI devices.

Note: It is recommended that GbE avoid programming Write Enable opcodes in this menu. Malicious software could then perform writes and erases to the SPI flash without using the atomic cycle mechanism. This could cause functional failures in a shared flash environment. Write Enable opcodes should only be programmed in the Prefix Opcodes.

| Bit | Description |
|-------|-----------------------------------------------------------------------------------------------------------------------------------------------------|
| 63:56 | Allowable Opcode 7 — R/W. See the description for bits 7:0 |
| 55:48 | Allowable Opcode 6 — R/W. See the description for bits 7:0 |
| 47:40 | Allowable Opcode 5 — R/W. See the description for bits 7:0 |
| 39:32 | Allowable Opcode 4 — R/W. See the description for bits 7:0 |
| 31:24 | Allowable Opcode 3 — R/W. See the description for bits 7:0 |
| 23:16 | Allowable Opcode 2 — R/W. See the description for bits 7:0 |
| 15:8 | Allowable Opcode 1 — R/W. See the description for bits 7:0 |
| 7:0 | Allowable Opcode 0 — R/W. Software programs an SPI opcode into this field for use when initiating SPI commands through the Control Register. |

This register is not writable when the SPI Configuration Lock-Down bit (MBARB + 00h:15) is set.

§ §





23 Thermal Sensor Registers (D31:F6)

23.1 PCI Bus Configuration Registers

Table 23-1. Thermal Sensor Register Address Map

| Offset | Mnemonic | Register Name | Default | Type |
|---------|----------|-------------------------------------|-----------|----------|
| 00h–01h | VID | Vendor Identification | 8086h | RO |
| 02h–03h | DID | Device Identification | TBD | RO |
| 04h–05h | CMD | Command Register | 0000h | R/W, RO |
| 06h–07h | STS | Device Status | 0010h | R/WC, RO |
| 08h | RID | Revision ID | 00h | RO |
| 09h | PI | Programming Interface | 00h | RO |
| 0Ah | SCC | Sub Class Code | 80h | RO |
| 0Bh | BCC | Base Class Code | 11h | RO |
| 0Ch | CLS | Cache Line Size | 00h | RO |
| 0Dh | LT | Latency Timer | 00h | RO |
| 0Eh | HTYPE | Header Type | 00h | RO |
| 0Fh | BIST | Built-in Self Test | 00h | RO |
| 10h–13h | TBAR | Thermal Base Address (Memory) | 00000004h | R/W, RO |
| 14h–17h | TBARH | Thermal Base Address High DWord | 00000000h | RO |
| 2Ch–2Dh | SVID | Subsystem Vendor Identifier | 0000h | R/WO |
| 2Eh–2Fh | SID | Subsystem Identifier | 0000h | R/WO |
| 34h | CAP_PTR | Capabilities Pointer | 50h | RO |
| 3Ch | INTLN | Interrupt Line | 00h | RW |
| 3Dh | INTPN | Interrupt Pin | TBD | RO |
| 40h–43h | TBARB | BIOS Assigned Thermal Base Address | 00000004h | R/W, RO |
| 44h–47h | TBARBH | BIOS Assigned BA High DWord | 00000000h | R/W |
| 50h–51h | PID | Power Management Identifiers | 0001h | RO |
| 52h–53h | PC | Power Management Capabilities | 0022h | RO |
| 54h–57h | PCS | Power Management Control and Status | 0000h | R/W, RO |



23.1.1 VID—Vendor Identification

Offset Address: 00h–01h Attribute: RO
Default Value: 8086h Size: 16 bit
Lockable: No Power Well: Core

| Bit | Description |
|------|------------------------------------------------------------------------------------|
| 15:0 | Vendor ID — RO. This is a 16-bit value assigned to Intel. Intel VID = 8086h |

23.1.2 DID—Device Identification

Offset Address: 02h–03h Attribute: RO
Default Value: TBD Size: 16 bit

| Bit | Description |
|------|-------------------------------------------------------------------------------|
| 15:0 | Device ID (DID) — RO. Indicates the device number assigned by the SIG. |

23.1.3 CMD—Command

Address Offset: 04h–05h Attribute: RO, R/W
Default Value: 0000h Size: 16 bits

| Bit | Description |
|-------|----------------------------------------------------------------------------------------------------------------------------------------------------------------------------------------------------------|
| 15:11 | Reserved |
| 10 | Interrupt Disable (ID) — RW. Enables the device to assert an INTx#. 0 = When cleared, the INTx# signal may be asserted. 1 = When set, the Thermal logic's INTx# signal will be de-asserted. |
| 9 | FBE (Fast Back to Back Enable) — RO. Not implemented. Hardwired to 0. |
| 8 | SEN (SERR Enable) — RO. Not implemented. Hardwired to 0. |
| 7 | WCC (Wait Cycle Control) — RO. Not implemented. Hardwired to 0. |
| 6 | PER (Parity Error Response) — RO. Not implemented. Hardwired to 0. |
| 5 | VPS (VGA Palette Snoop) — RO. Not implemented. Hardwired to 0. |
| 4 | MWI (Memory Write and Invalidate Enable) — RO. Not implemented. Hardwired to 0. |
| 3 | SCE (Special Cycle Enable) — RO. Not implemented. Hardwired to 0. |
| 2 | BME (Bus Master Enable) — RO. Not implemented. Hardwired to 0. |
| 1 | Memory Space Enable (MSE) — RW. 0 = Disable 1 = Enable. Enables memory space accesses to the Thermal registers. |
| 0 | IOS (I/O Space) — RO. The Thermal logic does not implement IO Space; therefore, this bit is hardwired to 0. |

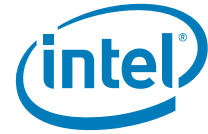

23.1.4 STS—Status

Address Offset: 06h–07h
Default Value: 0010h

Attribute: R/WC, RO
Size: 16 bits

| Bit | Description |
|------|---------------------------------------------------------------------------------------------------------------------------------------------------------------------------------------------------------------------------------------------------------------------------------------------------|
| 15 | Detected Parity Error (DPE) — R/WC. This bit is set whenever a parity error is seen on the internal interface for this function, regardless of the setting of bit 6 in the command register. Software clears this bit by writing a '1' to this bit location. |
| 14 | SERR# Status (SERRS) — RO. Not implemented. Hardwired to 0. |
| 13 | Received Master Abort (RMA) — RO. Not implemented. Hardwired to 0. |
| 12 | Received Target Abort (RTA) — RO. Not implemented. Hardwired to 0. |
| 11 | Signaled Target-Abort (STA) — RO. Not implemented. Hardwired to 0. |
| 10:9 | DEVSEL# Timing Status (DEVT) — RO. Does not apply. Hardwired to 0. |
| 8 | Master Data Parity Error (MDPE) — RO. Not implemented. Hardwired to 0. |
| 7 | Fast Back to Back Capable (FBC) — RO. Does not apply. Hardwired to 0. |
| 6 | Reserved |
| 5 | 66 MHz Capable (C66) — RO. Does not apply. Hardwired to 0. |
| 4 | Capabilities List Exists (CLIST) — RO. Indicates that the controller contains a capabilities pointer list. The first item is pointed to by looking at configuration offset 34h. |
| 3 | Interrupt Status (IS) — RO. Reflects the state of the INTx# signal at the input of the enable/disable circuit. This bit is a 1 when the INTx# is asserted. This bit is a 0 after the interrupt is cleared (independent of the state of the Interrupt Disable bit in the command register). |
| 2:0 | Reserved |

23.1.5 RID—Revision Identification

Address Offset: 08h
Default Value: 00h

Attribute: RO
Size: 8 bits

| Bit | Description |
|-----|-----------------------------------------------------------------------------------|
| 7:0 | Revision ID (RID) — RO. Indicates the device specific revision identifier. |

23.1.6 PI— Programming Interface

Address Offset: 09h
Default Value: 00h

Attribute: RO
Size: 8 bits

| Bit | Description |
|-----|--------------------------------------------------------------------------------------------------|
| 7:0 | Programming Interface (PI) — RO. ICH Thermal logic has no standard programming interface. |



23.1.14 SVID—Subsystem Vendor ID

Address Offset: 2Ch–2Dh Attribute: R/WO
Default Value: 0000h Size: 16 bits

This register should be implemented for any function that could be instantiated more than once in a given system. The SVID register, in combination with the Subsystem ID register, enables the operating environment to distinguish one subsystem from the other(s).

Software (BIOS) will write the value to this register. After that, the value can be read, but writes to the register will have no effect. The write to this register should be combined with the write to the SID to create one 32-bit write. This register is not affected by D3_{HOT} to D0 reset.

| Bit | Description |
|------|------------------------------------------------------------------------|
| 15:0 | SVID (SVID) — R/WO. These RWO bits have no ICH10 functionality. |

23.1.15 SID—Subsystem ID

Address Offset: 2Eh–2Fh Attribute: R/WO
Default Value: 0000h Size: 16 bits

This register should be implemented for any function that could be instantiated more than once in a given system. The SID register, in combination with the Subsystem Vendor ID register make it possible for the operating environment to distinguish one subsystem from the other(s).

Software (BIOS) will write the value to this register. After that, the value can be read, but writes to the register will have no effect. The write to this register should be combined with the write to the SVID to create one 32-bit write. This register is not affected by D3_{HOT} to D0 reset.

| Bit | Description |
|------|-----------------------------------------------------------------------|
| 15:0 | SID (SAID) — R/WO. These RWO bits have no ICH10 functionality. |

23.1.16 CAP_PTR —Capabilities Pointer

Address Offset: 34h Attribute: RO
Default Value: 50h Size: 8 bits

| Bit | Description |
|-----|--------------------------------------------------------------------------------------------------------------------------------------|
| 7:0 | Capability Pointer (CP) — RO. Indicates that the first capability pointer offset is offset 50h (Power Management Capability). |

23.1.17 Offset 3Ch – INTLN—Interrupt Line

Address Offset: 3Ch Attribute: RW
Default Value: 00h Size: 8 bits

| Bit | Description |
|-----|-------------------------------------------------------------------------------------------------------------------------------------------------------------------------------|
| 7:0 | Interrupt Line — RW. ICH10 hardware does not use this field directly. It is used to communicate to software the interrupt line that the interrupt pin is connected to. |



23.1.21 PID—PCI Power Management Capability ID

Address Offset: 50h–51h Attribute: RO
Default Value: 0001h Size: 16 bits

| Bit | Description |
|------|-------------------------------------------------------------------------------------------------------|
| 15:8 | Next Capability (NEXT) — RO. Indicates that this is the last capability structure in the list. |
| 7:0 | Cap ID (CAP) — RO. Indicates that this pointer is a PCI power management capability |

23.1.22 PC—Power Management Capabilities

Address Offset: 52h–53h Attribute: RO
Default Value: 0022h Size: 16 bits

| Bit | Description |
|-------|-----------------------------------------------------------------------------------------------------------------|
| 15:11 | PME_Support — RO. Indicates PME# is not supported |
| 10 | D2_Support — RO. The D2 state is not supported. |
| 9 | D1_Support — RO. The D1 state is not supported. |
| 8:6 | Aux_Current — RO. PME# from D3COLD state is not supported, therefore this field is 000b. |
| 5 | Device Specific Initialization (DSI) — RO. Indicates that device-specific initialization is required. |
| 4 | Reserved |
| 3 | PME Clock (PMEC) — RO. Does not apply. Hardwired to 0. |
| 2:0 | Version (VS) — RO. Indicates support for Revision 1.2 of the <i>PCI Power Management Specification</i> . |



23.2 Thermal Memory Mapped Configuration Registers (Thermal Sensor - D31:F26)

The base memory for these thermal memory mapped configuration registers is specified in the TBARB (D31:F6:Offset 40h). The individual registers are then accessible at TBARB + Offset.

There are two sensors in the ICH10. Each sensor has a separate configuration register set. Both sensors must be configured together.

Table 23-2. Thermal Memory Mapped Configuration Register Address Map

| Offset | Mnemonic | Register Name | Default | Type |
|--------|----------|------------------------------------------|-----------|------|
| 1h | TS0E | Thermal Sensor 0 Enable | 00h | R/W |
| 2h | TS0S | Thermal Sensor 0 Enable | 00h | R/W |
| 4h | TS0TTP | Thermal Sensor 0 Catastrophic Trip Point | 00000000h | R/W |
| 8h | TS0C0 | Thermal Sensor 0 Catastrophic Lock Down | 00h | R/W |
| 0Eh | TS0PC | Thermal Sensor 0 Policy Control | 00h | R/W |
| 41h | TS1E | Thermal Sensor 1 Enable | 00h | R/W |
| 42h | TS1S | Thermal Sensor 1 Enable | 00h | R/W |
| 44h | TS1TTP | Thermal Sensor 1 Catastrophic Trip Point | 00000000h | R/W |
| 48h | TS1C0 | Thermal Sensor 1 Catastrophic Lock Down | 00h | R/W |
| 4Eh | TS1PC | Thermal Sensor 1 Policy Control | 00h | R/W |
| 83h | TS0LOCK | Thermal Sensor 0 Register Lock Control | 00h | R/W |
| C3h | TS1LOCK | Thermal Sensor 1 Register Lock Control | 00h | R/W |

23.2.1 TSxE—Thermal Sensor [1:0] Enable

Offset Address: Sensor 0: TBARB+01h Attribute: R/W
 Sensor 1: TBARB+41h
 Default Value: 00h Size: 8 bit

| Bit | Description |
|-----|-----------------------------------------------------------------------------------------------------------------------------------------------------------------|
| 7:0 | Thermal Sensor Enable (TSE) — R/W. BIOS shall always program this register to the value BAh to enable the thermal sensor. All other values are reserved. |



23.2.2 TSxS—Thermal Sensor[1:0] Status

Offset Address: Sensor 0: TBARB+02h Attribute: RO
 Sensor 1: TBARB+42h
 Default Value: 00h Size: 8 bit

| Bit | Description |
|-----|--------------------------------------------------------------------------------------------------------------------------------------------------------------------|
| 7 | Catastrophic Trip Indicator (CTI) — RO. 0 = The temperature is below the catastrophic setting. 1 = The temperature is above the catastrophic setting. |
| 6:0 | Reserved |

23.2.3 TSxTTP—Thermal Sensor [1:0] Catastrophic Trip Point

Offset Address: Sensor 0: TBARB+04h Attribute: R/W
 Sensor 1: TBARB+44h
 Default Value: 00h Size: 32 bit

| Bit | Description |
|------|------------------------------------------------------------------------------------------------------------------------------------------------------------------------------|
| 31:8 | Reserved |
| 7:0 | Catastrophic Trip Point Setting (CTPS) — R/W. These bits set the catastrophic trip point. BIOS will program these bits. These bits are lockable via TSCO.bit 7. |

23.2.4 TSxCO—Thermal Sensor [1:0] Catastrophic Lock-Down

Offset Address: Sensor 0: TBARB+08h Attribute: R/W
 Sensor 1: TBARB+48h
 Default Value: 00h Size: 8 bit

| Bit | Description |
|-----|-----------------------------------------------------------------------------------------------------------------------------------------------------------------------------------------------------------------------------------------------------------------------------------|
| 7 | Lock bit for Catastrophic (LBC) — R/W. 0 = Catastrophic programming interface is unlocked 1 = Locks the Catastrophic programming interface including TSTTP.bits[7:0]. This bit may only be set to a 0 by a hardware reset. Writing a 0 to this bit has no effect. |
| 6:0 | Reserved |



23.2.5 TSxPC—Thermal Sensor [1:0] Policy Control

Offset Address: Sensor 0: TBARB+0Eh Attribute: R/W
 Sensor 1: TBARB+4Eh
Default Value: 00h Size: 8 bit

| Bit | Description |
|-----|--------------------------------------------------------------------------------------------------------------------------------------------------------------------------------------------------------------------------------------------------------------------------------------------------------------------------|
| 7 | Policy Lock-Down Bit — R/W. 0 = This register can be programmed and modified. 1 = Prevents writes to this register. NOTE: TSCO.bit 7 and TSLOCK.bit2 must also be 1 when this bit is set to 1. This bit may only be set to a 0 by a hardware reset. Writing a 0 to this bit has no effect. |
| 6 | Catastrophic Power-Down Enable — R/W. 1 = When set to 1, the power management logic unconditionally transitions to the S5 state when a catastrophic temperature is detected by the sensor. |
| 5:0 | Reserved |

23.2.6 TSxLOCK—Thermal Sensor [1:0] Register Lock Control

Offset Address: Sensor 0: TBARB+83h Attribute: R/W
 Sensor 1: TBARB+C3h
Default Value: 00h Size: 8 bit

| Bit | Description |
|-----|----------------------------------------------------------------------------------|
| 7:3 | Reserved |
| 2 | Lock Control — R/W. This bit must be set to 1 when TSPC.bit7 is set to 1. |
| 1:0 | Reserved |

§ §