



8272A

SINGLE/DOUBLE DENSITY FLOPPY DISK CONTROLLER

- IBM Compatible in Both Single and Double Density Recording Formats
- Programmable Data Record Lengths: 128, 256, 512, or 1024 Bytes/Sector
- Multi-Sector and Multi-Track Transfer Capability
- Drives Up to 4 Floppy or Mini-Floppy Disks
- Controls 8", 5 1/4" and 3 1/2" Floppy Disk Drives
- Data Transfers in DMA or Non-DMA Mode
- Parallel Seek Operations on Up to Four Drives
- Compatible with all Intel and Most Other Microprocessors
- Single-Phase 8 MHz Clock
- Single +5V Power Supply (± 10%)
- Plastic 40 Pin DIP or 40 Pin Cerdip Packages

The 8272A is an LSI Floppy Disk Controller (FDC) Chip, which contains the circuitry and control functions for interfacing a processor to 4 Floppy Disk Drives. It is capable of supporting either IBM 3740 single density format (FM), or IBM System 34 Double Density format (MFM) including double sided recording. The 8272A provides control signals which simplify the design of an external phase locked loop and write precompensation circuitry. The FDC simplifies and handles most of the burdens associated with implementing a Floppy Disk Drive Interface. The 8272A is a pin-compatible upgrade to the 8272.

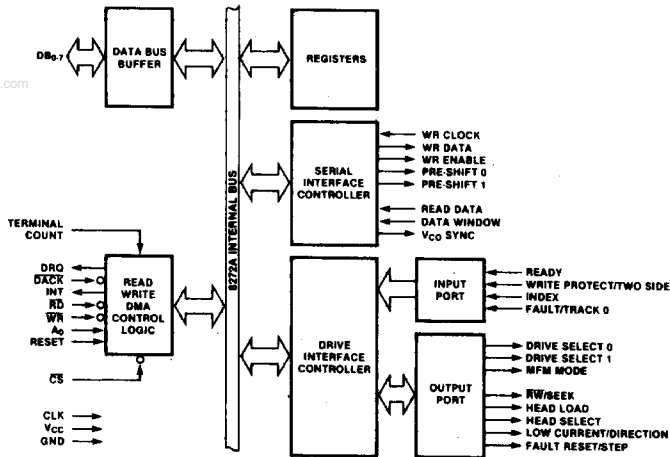

Figure 1. 8272A Internal Block Diagram

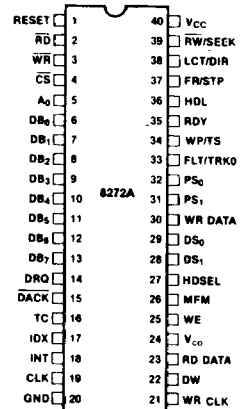

Figure 2. Pin Configuration

Table 1. Pin Description

Symbol	Pin No.	Type	Connection To	Name and Function
RESET	1	I	μ P	RESET: Places FDC in idle state. Resets output lines to FDD to "0" (low). Does not clear the last specify command.
\overline{RD}	2	I(1)	μ P	READ: Control signal for transfer of data from FDC to Data Bus, when "0" (low).
\overline{WR}	3	I(1)	μ P	WRITE: Control signal for transfer of data to FDC via Data Bus, when "0" (low).
CS	4	I	μ P	CHIP SELECT: IC selected when "0" (low) allowing \overline{RD} and \overline{WR} to be enabled.
A ₀	5	I(1)	μ P	DATA/STATUS REGISTER SELECT: Selects Data Reg (A ₀ = 1) or Status Reg (A ₀ = 0) contents to be sent to Data Bus.
DB ₀ -DB ₇	6-13	I/O(1)	μ P	DATA BUS: Bidirectional 8-Bit Data Bus.
DRQ	14	O	DMA	DATA DMA REQUEST: DMA Request is being made by FDC when DRQ "1", (3)
\overline{DACK}	15	I	DMA	DMA ACKNOWLEDGE: DMA cycle is active when "0" (low) and Controller is performing DMA transfer.
TC	16	I	DMA	TERMINAL COUNT: Indicates the termination of a DMA transfer when "1" (high)(2).
IDX	17	I	FDD	INDEX: Indicates the beginning of a disk track.
INT	18	O	μ P	INTERRUPT: Interrupt Request Generated by FDC.
CLK	19	I		CLOCK: Single Phase 8 MHz (4 MHz for mini floppies) Squarewave Clock.
GND	20			GROUND: D.C. Power Return.
V _{CC}	40			D.C. POWER: +5V
$\overline{RW/SEEK}$	39	O	FDD	READ WRITE/SEEK: When "1" (high) Seek mode selected and when "0" (low) Read/Write mode selected.
LCT/DIR	38	O	FDD	LOW CURRENT/DIRECTION: Lowers Write current on inner tracks in Read/Write mode, determines direction head will step in Seek mode.
FR/STP	37	O	FDD	FAULT RESET/STEP: Resets fault FF in FDD in Read/Write mode, provides step pulses to move head to another cylinder in Seek mode.
HDL	36	O	FDD	HEAD LOAD: Command which causes Read/Write head in FDD to contact diskette.
RDY	35	I	FDD	READY: Indicates FDD is ready to send or receive data. Must be tied high (gated by the index pulse) for mini floppies which do not normally have a Ready line.
WP/TS	34	I	FDD	WRITE PROTECT/TWO-SIDE: Senses Write Protect status in Read/Write mode, and Two Side Media in Seek mode.
FLT/TRK0	33	I	FDD	FAULT/TRACK 0: Senses FDD fault condition in Read/Write mode and Track 0 condition in Seek mode.
PS ₁ , PS ₀	31, 32	O	FDD	PRECOMPENSATION (PRE-SHIFT): Write precompensation status during MFM mode. Determines early, late, and normal times.
WR DATA	30	O	FDD	WRITE DATA: Serial clock and data bits to FDD.
DS ₁ , DS ₀	28, 29	O	FDD	DRIVE SELECT: Selects FDD unit.

Table 1. Pin Description (Continued)

Symbol	Pin No.	Type	Connection To	Name and Function
HDSEL	27	O	FDD	HEAD SELECT: Head 1 selected when "1" (high) Head 0 selected when "0" (low).
MFM	26	O	PLL	MFM MODE: MFM mode when "1," FM mode when "0".
WE	25	O	FDD	WRITE ENABLE: Enables write data into FDD.
VCO	24	O	PLL	VCO SYNC: Inhibits VCO in PLL when "0" (low), enables VCO when "1."
RD DATA	23	I	FDD	READ DATA: Read data from FDD, containing clock and data bits.
DW	22	I	PLL	DATA WINDOW: Generated by PLL, and used to sample data from FDD.
WR CLK	21	I		WRITE CLOCK: Write data rate to FDD FM = 500 kHz, MFM = 1 MHz, with a pulse width of 250 ns for both FM and MFM. Must be enabled for all operations, both Read and Write.

NOTES:

1. Disabled when $\overline{CS} = 1$.
2. TC must be activated to terminate the Execution Phase of any command.
3. DRQ is also an input for certain test modes. It should have a 5 kΩ pull-up resistor to prevent activation.

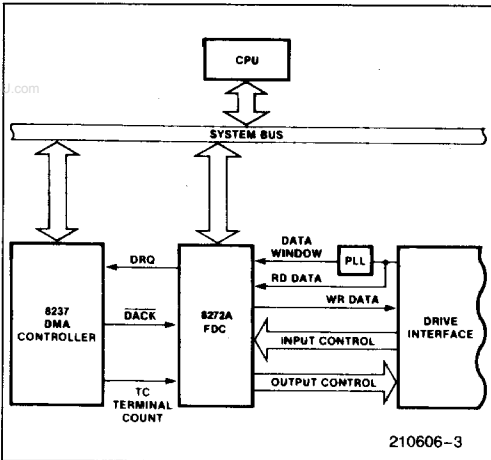

Figure 3. 8272A System Block Diagram

load a command into the FDC and all data transfers occur under control of the 8272A and DMA controller.

There are 15 separate commands which the 8272A will execute. Each of these commands require multiple 8-bit bytes to fully specify the operation which the processor wishes the FDC to perform. The following commands are available.

- | | |
|--------------------|----------------------------------|
| Read Data | Write Data |
| Read ID | Format a Track |
| Read Deleted Data | Write Deleted Data |
| Read a Track | Seek |
| Scan Equal | Recalibrate (Restore to Track 0) |
| Scan High or Equal | Sense Interrupt Status |
| Scan Low or Equal | Sense Drive Status |
| Specify | |

For more information see the Intel Application Notes AP-116 and AP-121.

DESCRIPTION

Hand-shaking signals are provided in the 8272A which make DMA operation easy to incorporate with the aid of an external DMA Controller chip, such as the 8237A. The FDC will operate in either DMA or Non-DMA mode. In the Non-DMA mode, the FDC generates interrupts to the processor for every transfer of a data byte between the CPU and the 8272A. In the DMA mode, the processor need only

FEATURES

Address mark detection circuitry is internal to the FDC which simplifies the phase locked loop and read electronics. The track stepping rate, head load time, and head unload time may be programmed by the user. The 8272A offers many additional features such as multiple sector transfers in both read and write modes with a single command, and full IBM compatibility in both single (FM) and double density (MFM) modes.

8272A ENHANCEMENTS

On the 8272A, after detecting the Index Pulse, the VCO Sync output stays low for a shorter period of time. See Figure 4a.

On the 8272 there can be a problem reading data when Gap 4A is 00 and there is no IAM. This occurs on some older floppy formats. The 8272A cures this problem by adjusting the VCO Sync timing so that it is not low during the data field. See Figure 4b.

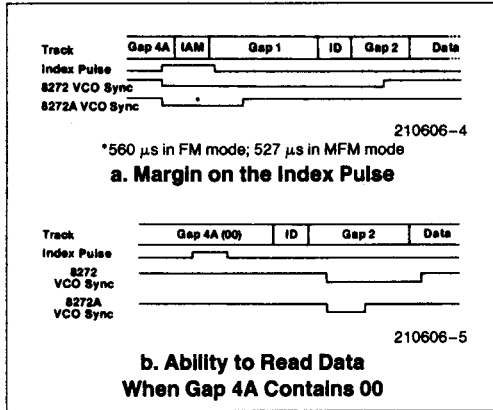

Figure 4. 8272A Enhancements over the 8272

8272A REGISTERS—CPU INTERFACE

The 8272A contains two registers which may be accessed by the main system processor; a Status Register and a Data Register. The 8-bit Main Status Register contains the status information of the FDC, and may be accessed at any time. The 8-bit Data Register (actually consists of several registers in a stack with only one register presented to the data bus at a time), stores data, commands, parameters, and FDD status information. Data bytes are read out of, or written into, the Data Register in order to program or obtain the results after execution of a command. The Status Register may only be read and is used to facilitate the transfer of data between the processor and 8272A.

The relationship between the Status/Down registers and the signals \overline{RD} , \overline{WR} , and A_0 is shown in Table 2.

Table 2. A_0 , \overline{RD} , \overline{WR} Decoding for the Selection of Status/Data Register Functions.

A_0	\overline{RD}	\overline{WR}	Function
0	0	1	Read Main Status Register
0	1	0	Illegal ⁽¹⁾
0	0	0	Illegal ⁽¹⁾
1	0	0	Illegal ⁽¹⁾
1	0	1	Read from Data Register
1	1	0	Write into Data Register

NOTE:

1. Design must guarantee that the 8272A is not subjected to illegal inputs.

The Main Status Register bits are defined in Table 3.

Table 3. Main Status Register Bit Description

Bit Number	Name	Symbol	Description
D ₀	FDD 0 Busy	D ₀ B	FDD number 0 is in the Seek mode.
D ₁	FDD 1 Busy	D ₁ B	FDD number 1 is in the Seek mode.
D ₂	FDD 2 Busy	D ₂ B	FDD number 2 is in the Seek mode.
D ₃	FDD 3 Busy	D ₃ B	FDD number 3 is in the Seek mode.
D ₄	FDC Busy	CB	A read or write command is in process.
D ₅	Non-DMA Mode	NDM	The FDC is in the non-DMA mode. This bit is set only during the execution phase in non-DMA mode. Transition to "0" state indicates execution phase has ended.
D ₆	Data Input/Output	DIO	Indicates direction of data transfer between FDC and Data Register. If DIO = "1" then transfer is from Data Register to the Processor. If DIO = "0", then transfer is from the Processor to Data Register.
D ₇	Request for Master	RQM	Indicates Data Register is ready to send or receive data to or from the Processor. Both bits DIO and RQM should be used to perform the handshaking functions of "ready" and "direction" to the processor.

The DIO and RQM bits in the Status Register indicate when Data is ready and in which direction data will be transferred on the Data Bus.

NOTE:

There is a 12 μs or 24 μs RQM flag delay when using an 8 or 4 MHz clock respectively.

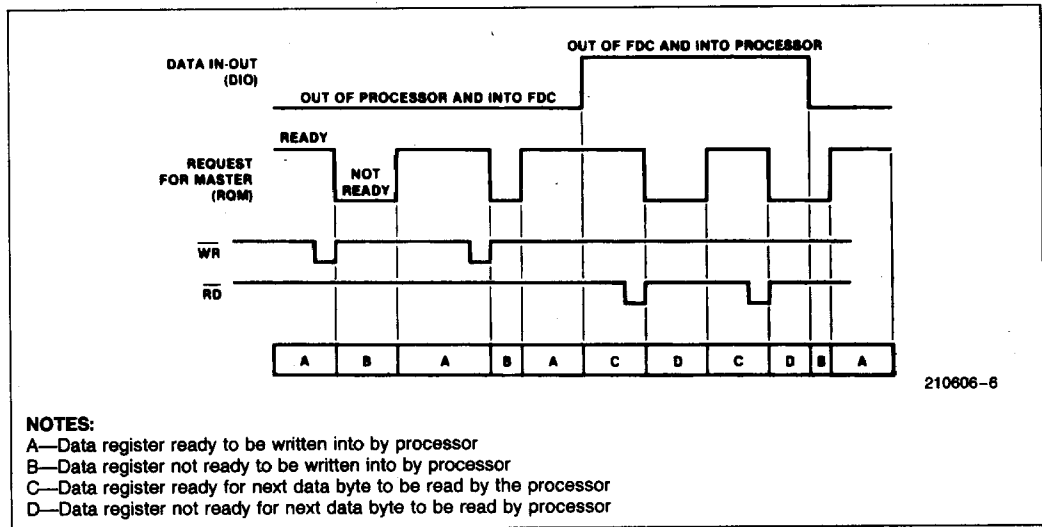

210606-6

NOTES:

- A—Data register ready to be written into by processor
- B—Data register not ready to be written into by processor
- C—Data register ready for next data byte to be read by the processor
- D—Data register not ready for next data byte to be read by processor

Figure 5. Status Register Timing

The 8272A is capable of executing 15 different commands. Each command is initiated by a multi-byte transfer from the processor, and the result after execution of the command may also be a multi-byte transfer back to the processor. Because of this multi-byte interchange of information between the 8272A and the processor, it is convenient to consider each command as consisting of three phases:

Command Phase: The FDC receives all information required to perform a particular operation from the processor.

Execution Phase: The FDC performs the operation it was instructed to do.

Result Phase: After completion of the operation, status and other house-keeping information are made available to the processor.

During Command or Result Phases the Main Status Register (described in Table 3) must be read by the processor before each byte of information is written into or read from the Data Register. Bits D6 and D7 in the Main Status Register must be in a 0 and 1 state, respectively, before each byte of the command word may be written into the 8272A. Many of the commands require multiple bytes, and as a result the Main Status Register must be read prior to each byte transfer to the 8272A. On the other hand, during the Result Phase, D6 and D7 in the Main Status Register must both be 1's (D6 = 1 and D7 = 1) before reading each byte from the Data Register.

NOTE:

This reading of the Main Status Register before each byte transfer to the 8272A is required in only the Command and Result Phases, and NOT during the Execution Phase.

During the Execution Phase, the Main Status Register need not be read. If the 8272A is in the non-DMA Mode, then the receipt of each data byte (if 8272A is reading data from FDD) is indicated by an interrupt signal on pin 18 (INT = 1). The generation of a Read signal (RD = 0) will reset the interrupt as well as output the Data onto the Data Bus. For example, if the processor cannot handle Interrupts fast enough (every 13 μ s for MFM mode) then it may poll the Main Status Register and then bit D7 (RQM) functions just like the Interrupt signal. If a Write Command is in process, then the WR signal performs the reset to the Interrupt signal.

The 8272A always operates in a multi-sector transfer mode. It continues to transfer data until the TC input is active. In Non-DMA Mode, the system must supply the TC input.

If the 8272A is in the DMA Mode, no Interrupts are generated during the Execution Phase. The 8272A generates DRQ's (DMA Requests) when each byte of data is available. The DMA Controller responds to this request with both a DACK = 0 (DMA Acknowledge) and a \overline{RD} = 0 (Read signal). When the DMA Acknowledge signal goes low (DACK = 0) then the DMA Request is reset (DRQ = 0). If a Write Command has been programmed then a WR signal will appear instead of \overline{RD} . After the Execution Phase has been completed (Terminal Count has occurred) then an Interrupt will occur (INT = 1). This signifies the beginning of the Result Phase. When the first byte of data is read during the Result Phase, the Interrupt is automatically reset (INT = 0).

It is important to note that during the Result Phase all bytes shown in the Command Table must be read. The Read Data Command, for example has seven bytes of data in the Result Phase. All seven bytes must be read in order to successfully complete the Read Data Command. The 8272A will not accept a new command until all seven bytes have been read. Other commands may require fewer bytes to be read during the Result Phase.

The 8272A contains five Status Registers. The Main Status Register mentioned above may be read by the processor at any time. The other four Status Registers (ST0, ST1, ST2, and ST3) are only available during the Result Phase, and may be read only after successfully completing a command. The particular command which has been executed determines how many of the Status Registers will be read.

The bytes of data which are sent to the 8272A to form the Command Phase, and are read out of the 8272A in the Result Phase, must occur in the order shown in the Table 4. That is, the Command Code must be sent first and the other bytes sent in the prescribed sequence. No foreshortening of the Command or Result Phases are allowed. After the last byte of data in the Command Phase is sent to the 8272A, the Execution Phase automatically starts. In a similar fashion, when the last byte of

Table 4. 8272A Command Set

Phase	R/W	Data Bus								Remarks		
		D ₇	D ₆	D ₅	D ₄	D ₃	D ₂	D ₁	D ₀			
READ DATA												
Command	W	MT	MFM	SK	0	0	1	1	0	Command Codes		
	W	0	0	0	0	0	HDS	DS1	DS0			
	W					C					Sector ID Information Prior to Command Execution	
	W					H						
	W					R						
	W					N						
	W					EOT						
W					GPL							
Execution	W					DTL				Data Transfer Between the FDD and Main-System		
	Result	R				ST 0					Status Information After Command Execution	
		R				ST 1						
		R				ST 2						
		R				C						
		R				H						Sector ID Information After Command Execution
		R				R						
R					N							
READ DELETED DATA												
Command	W	MT	MFM	SK	0	1	1	0	0	Command Codes		
	W	0	0	0	0	0	HDS	DS1	DS0			
	W					C					Sector ID Information Prior to Command Execution	
	W					H						
	W					R						
	W					N						
	W					EOT						
W					GPL							
Execution	W					DTL				Data Transfer Between the FDD and Main-System		
	Result	R				ST 0					Status Information After Command Execution	
		R				ST 1						
		R				ST 2						
		R				C						
		R				H						Sector ID Information After Command Execution
		R				R						
R					N							

Table 4. 8272A Command Set (Continued)

Phase	R/W	Data Bus								Remarks			
		D7	D6	D5	D4	D3	D2	D1	D0				
WRITE DATA													
Command	W	MT	MFM	0	0		0	1	0	1	Command Codes		
	W	0	0	0	0		0	HDS	DS1	DS0			
	W					C						Sector ID Information Prior to Command Execution	
	W					H							
	W					R							
	W					N							
	W					EOT							
	W					GPL							
Execution	W					DTL					Data Transfer Between the Main- System and FDD		
	Result	R				ST 0						Status Information After Command Execution	
		R				ST 1							
		R				ST 2							
		R				C							
		R				H							Sector ID Information After Command Execution
		R				R							
R					N								
WRITE DELETED DATA													
Command	W	MT	MFM	0	0		1	0	0	1	Command Codes		
	W	0	0	0	0		0	HDS	DS1	DS0			
	W					C						Sector ID Information Prior to Command Execution	
	W					H							
	W					R							
	W					N							
	W					EOT							
	W					GPL							
Execution	W					DTL					Data Transfer Between the FDD and Main-System		
	Result	R				ST 0						Status Information After Command Execution	
		R				ST 1							
		R				ST 2							
		R				C							
		R				H							Sector ID Information After Command Execution
		R				R							
R					N								

www.DataSheet4U.com

Table 4. 8272A Command Set (Continued)

Phase	R/W	Data Bus								Remarks			
		D ₇	D ₆	D ₅	D ₄	D ₃	D ₂	D ₁	D ₀				
READ A TRACK													
Command	W	0	MFM	SK	0		0	0	1	0	Command Codes		
	W	0	0	0	0		0	HDS	DS1	DS0			
	W					C						Sector ID Information Prior to Command Execution	
	W					H							
	W					R							
	W					N							
	W					EOT							
	W					GPL							
	W					DTL							
	Execution												Data Transfer Between the FDD and Main-System. FDC Reads all of Cylinders Contents from Index Hole to EOT
Result		R				ST 0					Status Information After Command Execution		
		R				ST 1							
		R				ST 2							
		R				C							
		R				H						Sector ID Information After Command Execution	
		R				R							
	R				N								
READ ID													
Command	W	0	MFM	0	0		1	0	1	0	Commands		
	W	0	0	0	0		0	HDS	DS1	DS0			
Execution											The First Correct ID Information on the Cylinder is Stored in Data Register		
	Result	R				ST 0						Status Information After Command Execution	
		R				ST 1							
		R				ST 2							
		R				C							
		R				H							Sector ID Information During Execution Phase
		R				R							
R					N								

www.DataSheet4U.com

Table 4. 8272A Command Set (Continued)

Phase	R/W	Data Bus								Remarks		
		D ₇	D ₆	D ₅	D ₄	D ₃	D ₂	D ₁	D ₀			
FORMAT A TRACK												
Command	W	0	MFM	0	0		1	1	0	1	Command Codes	
	W	0	0	0	0		0	HDS	DS1	DS0		
	W					N						Bytes/Sector
	W					SC						Sectors/Cylinder
	W					GPL						Gap 3
Execution	W					D					Filler Byte	
											FDC Formats an Entire Cylinder	
Result	R					ST 0					Status Information After Command Execution	
	R					ST 1						
	R					ST 2						
	R					C						
	R					H						In This Case, the ID Information has no Meaning
	R					R						
	R					N						

Table 4. 8272A Command Set (Continued)

Phase	R/W	Data Bus								Remarks	
		D7	D6	D5	D4	D3	D2	D1	D0		
SCAN EQUAL											
Command	W	MT	MFM	SK	1		0	0	0	1	Command Codes
	W	0	0	0	0		0	HDS	DS1	DS0	
	W		_____			C		_____			Sector ID Information
	W		_____			H		_____			Prior to Command
	W		_____			R		_____			Execution
	W		_____			N		_____			
	W		_____			EOT		_____			
	W		_____			GPL		_____			
Execution	W		_____			STP		_____			Data Compared
											Between the FDD
											and Main-System
Result	R		_____			ST 0		_____			Status Information
	R		_____			ST 1		_____			After Command
	R		_____			ST 2		_____			Execution
	R		_____			C		_____			
	R		_____			H		_____			Sector ID Information
	R		_____			R		_____			After Command
	R		_____			N		_____			Execution
SCAN LOW OR EQUAL											
Command	W	MT	MFM	SK	1		1	0	0	1	Command Codes
	W	0	0	0	0		0	HDS	DS1	DS0	
	W		_____			C		_____			Sector ID Information
	W		_____			H		_____			Prior to Command
	W		_____			R		_____			Execution
	W		_____			N		_____			
	W		_____			EOT		_____			
	W		_____			GPL		_____			
Execution	W		_____			STP		_____			Data Compared
											Between the FDD
											and Main-System
Result	R		_____			ST 0		_____			Status Information
	R		_____			ST 1		_____			After Command
	R		_____			ST 2		_____			Execution
	R		_____			C		_____			
	R		_____			H		_____			Sector ID Information
	R		_____			R		_____			After Command
	R		_____			N		_____			Execution

www.DataSheet4U.com

Table 4. 8272A Command Set (Continued)

Phase	R/W	Data Bus								Remarks		
		D ₇	D ₆	D ₅	D ₄	D ₃	D ₂	D ₁	D ₀			
SCAN HIGH OR EQUAL												
Command	W	MT	MFM	SK	1		1	1	0	1	Command Codes	
	W	0	0	0	0		0	HDS	DS1	DS0		
	W		_____			C		_____				Sector ID Information Prior to Command Execution
	W		_____			H		_____				
	W		_____			R		_____				
	W		_____			N		_____				
	W		_____			EOT		_____				
W		_____			GPL		_____					
W		_____			STP		_____			Data Compared Between the FDD and Main-System		
Execution												
Result	R		_____			ST 0		_____			Status Information After Command Execution	
	R		_____			ST 1		_____				
	R		_____			ST 2		_____				
	R		_____			C		_____				
	R		_____			H		_____				Sector ID Information After Command Execution
	R		_____			R		_____				
R		_____			N		_____					
RECALIBRATE												
Command	W	0	0	0	0		0	1	1	1	Command Codes	
Execution	W	0	0	0	0		0	0	DS1	DS0	Head Retracted to Track 0	
SENSE INTERRUPT STATUS												
Command	W	0	0	0	0		1	0	0	0	Command Codes	
Result	R		_____			ST 0		_____			Status Information at the End of Each Seek Operation About the FDC	
	R		_____			PCN		_____				

www.DataSheet4U.com

Table 4. 8272A Command Set (Continued)

Phase	R/W	Data Bus								Remarks
		D ₇	D ₆	D ₅	D ₄	D ₃	D ₂	D ₁	D ₀	
SPECIFY										
Command	W	0	0	0	0	0	0	1	1	Command Codes
	W	—	SRT	→		←		HUT	—	
	W	—	HLT	→					ND	
SENSE DRIVE STATUS										
Command	W	0	0	0	0	0	1	0	0	Command Codes
Result	W	0	0	0	0	0	HDS	DS1	DS0	Status Information about FDD
	R	_____			ST 3	_____				
SEEK										
Command	W	0	0	0	0	1	1	1	1	Command Codes
	W	0	0	0	0	0	HDS	DS1	DS0	
	W	_____			NCN	_____				
Execution										Head is Positioned Over Proper Cylinder on Diskette
INVALID										
Command	W	_____ Invalid Codes _____								Invalid Command Codes (NoOp—FDC Goes Into Standby State) ST 0 = 80 (16)
Result	R	_____			ST 0	_____				

www.DataSheet4U.com

Table 5. Command Mnemonics

Symbol	Name	Description
A ₀	Address Line 0	A ₀ controls selection of Main Status Register (A ₀ = 0) or Data Register (A ₀ = 1).
C	Cylinder Number	C stands for the current selected Cylinder track number 0 through 76 of the medium.
D	Data	D stands for the data pattern which is going to be written into a Sector.
D ₇ -D ₀	Data Bus	8-bit Data bus where D ₇ is the most significant bit, and D ₀ is the least significant bit.
DS0, DS1	Drive Select	DS stands for a selected drive number 0 or 1.
DTL	Data Length	When N is defined as 00, DTL stands for the data length which users are going to read out or write into the Sector.
EOT	End of Track	EOT stands for the final Sector number of a Cylinder.
GPL	Gap Length	GPL stands for the length of Gap 3 (spacing between Sectors excluding VCO Sync Field).
H	Head Address	H stands for head number 0 or 1, as specified in ID field.
HDS	Head Select	HDS stands for a selected head number 0 or 1 (H = HDS in all command words).
HLT	Head Load Time	HLT stands for the head load time in the FDD (2 to 254 ms in 2 ms increments).
HUT	Head Unload Time	HUT stands for the head unload time after a read or write operation has occurred (16 to 240 ms in 16 ms increments).
MFM	FM or MFM Mode	If MF is low, FM mode is selected and if it is high, MFM mode is selected.
MT	Multi-Track	If MT is high, a multi-track operation is to be performed (a cylinder under both HD0 and HD1 will be read or written).
N	Number	N stands for the number of data bytes written in a Sector.
NCN	New Cylinder Number	NCN stands for a new Cylinder number, which is going to be reached as a result of the Seek operation. Desired position of Head.
ND	Non-DMA Mode	ND stands for operation in the Non-DMA Mode.
PCN	Present Cylinder Number	PCN stands for the Cylinder number at the completion of SENSE INTERRUPT STATUS Command. Position of Head at present time.
R	Record	R stands for the Sector number, which will be read or written.
R/W	Read/Write	R/W stands for either Read (R) or Write (W) signal.
SC	Sector	SC indicates the number of Sectors per Cylinder.
SK	Skip	SK stands for Skip Deleted Data Address Mark.
SRT	Step Rate Time	SRT stands for the Stepping Rate for the FDD (1 to 16 ms in 1 ms increments). The same Stepping Rate applies to all drives (F = 1 ms, E = 2 ms, etc.).

Table 5. Command Mnemonics (Continued)

Symbol	Name	Description
ST 0 ST 1 ST 2 ST 3	Status 0 Status 1 Status 2 Status 3	ST 0–3 stand for one of four registers which store the status information after a command has been executed. This information is available during the result phase after command execution. These registers should not be confused with the main status register (selected by $A_0 = 0$). ST 0–3 may be read only after a command has been executed and contain information relevant to that particular command.
STP		During a Scan operation, if STP = 1, the data in contiguous sectors is compared byte by byte with data sent from the processor (or DMA), and if STP = 2, then alternate sectors are read and compared.

data is read out in the Result Phase, the command is automatically ended and the 8272A is ready for a new command. A command may be aborted by simply sending a Terminal Count signal to pin 16 (TC = 1). This is a convenient means of ensuring that the processor may always get the 8272A's attention even if the disk system hangs up in an abnormal manner.

POLLING FEATURE OF THE 8272A

After power-up RESET, the Drive Select Lines DS0 and DS1 will automatically go into a polling mode. In between commands (and between step pulses in the SEEK command) the 8272A polls all four FDDs looking for a change in the Ready line from any of the drives. If the Ready line changes state (usually due to a door opening or closing) then the 8272A will generate an interrupt. When Status Register 0 (ST0) is read (after Sense Interrupt Status is issued), Not Ready (NR) will be indicated. The polling of the Ready line by the 8272A occurs continuously between instructions, thus notifying the processor which drives are on or off line. Approximate scan timing is shown in Table 6.

Table 6. Scan Timing

DS1	DS0	Approximate Scan Timing
0	0	220 μ s
0	1	220 μ s
1	0	220 μ s
1	1	440 μ s

COMMAND DESCRIPTIONS

During the Command Phase, the Main Status Register must be polled by the CPU before each byte is

written into the Data Register. The DIO (DB6) and RQM (BD7) bits in the Main Status Register must be in the "0" and "1" states respectively, before each byte of the command may be written into the 8272A. The beginning of the execution phase for any of these commands will cause DIO and RQM to switch to "1" and "0" states respectively.

READ DATA

A set of nine (9) byte words are required to place the FDC into the Read Data Mode. After the Read Data command has been issued the FDC loads the head (if it is in the unloaded state), waits the specified head settling time (defined in the Specify Command), and begins reading ID Address Marks and ID fields. When the current sector number ("R") stored in the ID Register (IDR) compares with the sector number read off the diskette, then the FDC outputs data (from the data field) byte-by-byte to the main system via the data bus.

After completion of the read operation from the current sector, the Sector Number is incremented by one, and the data from the next sector is read and output on the data bus. This continuous function is called a "Multi-Sector Read Operation." The Read Data Command must be terminated by the receipt of a Terminal Count signal. Upon receipt of this signal, the FDC stops outputting data to the processor, but will continue to read data from the current sector, check CRC (Cyclic Redundancy Count) bytes, and then at the end of the sector terminate the Read Data Command.

The amount of data which can be handled with a single command to the FDC depends upon MT (multi-track), MFM (MFM/FM), and N (Number of Bytes/Sector). Table 7 on the next page shows the Transfer Capacity.

Table 7. Transfer Capacity

Multi-Track MT	MFM/FM MFM	Bytes/Sector N	Maximum Transfer Capacity (Bytes/Sector)(Number of Sectors)	Final Sector Read from Diskette
0	0	00	(128) (26) = 3,328	26 at Side 0
0	1	01	(256) (26) = 6,656	or 26 at Side 1
1	0	00	(128) (52) = 6,656	26 at Side 1
1	1	01	(256) (52) = 13,312	
0	0	01	(256) (15) = 3,840	15 at Side 0
0	1	02	(512) (15) = 7,680	or 15 at Side 1
1	0	01	(256) (30) = 7,680	15 at Side 1
1	1	02	(512) (30) = 15,360	
0	0	02	(512) (8) = 4,096	8 at Side 0
0	1	03	(1024) (8) = 8,192	or 8 at Side 1
1	0	02	(512) (16) = 8,192	8 at Side 1
1	1	03	(1024) (16) = 16,384	

The "multi-track" function (MT) allows the FDC to read data from both sides of the diskette. For a particular cylinder, data will be transferred starting at Sector 1, Side 0 and completing at Sector L, Side 1 (Sector L = last sector on the side).

NOTE:

This function pertains to only one cylinder (the same track) on each side of the diskette.

When N = 0, then DTL defines the data length which the FDC must treat as a sector. If DTL is smaller than the actual data length in a Sector, the data beyond DTL in the Sector is not sent to the Data Bus. The FDC reads (internally) the complete Sector performing the CRC check, and depending upon the manner of command termination, may perform a Multi-Sector Read Operation. When N is non-zero, then DTL has no meaning and should be set to 0FFH.

At the completion of the Read Data Command, the head is not unloaded until after Head Unload Time Interval (specified in the Specify Command) has elapsed. If the processor issues another command before the head unloads then the head settling time may be saved between subsequent reads. This time out is particularly valuable when a diskette is copied from one drive to another.

If the FDC detects the Index Hole twice without finding the right sector, (indicated in "R"), then the FDC sets the ND (No Data) flag in Status Register 1 to a 1 (high), and terminates the Read Data Command. (Status Register 0 also has bits 7 and 6 set to 0 and 1 respectively.)

After reading the ID and Data Fields in each sector, the FDC checks the CRC bytes. If a read error is detected (incorrect CRC in ID field), the FDC sets the DE (Data Error) flag in Status Register 1 to a 1 (high), and if a CRC error occurs in the Data Field the FDC also sets the DD (Data Error in Data Field) flag in Status Register 2 to a 1 (high), and terminates the Read Data Command. (Status Register 0 also has bits 7 and 6 set to 0 and 1 respectively.)

If the FDC reads a Deleted Data Address Mark off the diskette, and the SK bit (bit D5 in the first Command Word) is not set (SK = 0), then the FDC sets the CM (Control Mark) flag in Status Register 2 to a 1 (high), and terminates the Read Data Command, after reading all the data in the Sector. If SK = 1, the FDC skips the sector with the Deleted Data Address Mark and reads the next sector.

During disk data transfers between the FDC and the processor, via the data bus, the FDC must be serviced by the processor every 27 μ s in the FM Mode, and every 13 μ s in the MFM Mode, or the FDC sets the OR (Over Run) flag in Status Register 1 to a 1 (high), and terminates the Read Data Command.

If the processor terminates a read (or write) operation in the FDC, then the ID Information in the Result Phase is dependent upon the state of the MT bit and EOT byte. Table 5 shows the values for C, H, R, and N, when the processor terminates the Command.

Table 8. ID Information When Processor Terminates Command

MT	EOT	Final Sector Transferred to Processor	ID Information at Result Phase			
			C	H	R	N
0	1A 0F 08	Sector 1 to 25 at Side 0 Sector 1 to 14 at Side 0 Sector 1 to 7 at Side 0	NC	NC	R + 1	NC
	1A 0F 08	Sector 26 at Side 0 Sector 15 at Side 0 Sector 8 at Side 0	C + 1	NC	R = 01	NC
	1A 0F 08	Sector 1 to 25 at Side 1 Sector 1 to 14 at Side 1 Sector 1 to 7 at Side 1	NC	NC	R + 1	NC
	1A 0F 08	Sector 26 at Side 1 Sector 15 at Side 1 Sector 8 at Side 1	C + 1	NC	R = 01	NC
1	1A 0F 08	Sector 1 to 25 at Side 0 Sector 1 to 14 at Side 0 Sector 1 to 7 at Side 0	NC	NC	R + 1	NC
	1A 0F 08	Sector 26 at Side 0 Sector 15 at Side 0 Sector 8 at Side 0	NC	LSB	R = 01	NC
	1A 0F 08	Sector 1 to 25 at Side 1 Sector 1 to 14 at Side 1 Sector 1 to 7 at Side 1	NC	NC	R + 1	NC
	1A 0F 08	Sector 26 at Side 1 Sector 15 at Side 1 Sector 8 at Side 1	C + 1	LSB	R = 01	NC

NOTES:

1. NC (No Change): The same value as the one at the beginning of command execution.
2. LSB (Least Significant Bit): The least significant bit of H is complemented.

WRITE DATA

A set of nine (9) bytes are required to set the FDC into the Write Data mode. After the Write Data command has been issued the FDC loads the head (if it is in the unloaded state), waits the specified head settling time (defined in the Specify Command), and begins reading ID Fields. When the current sector number ("R"), stored in the ID Register (IDR) compares with the sector number read off the diskette, then the FDC takes data from the processor byte-by-byte via the data bus, and outputs it to the FDD.

After writing data into the current sector, the Sector Number stored in "R" is incremented by one, and the next data field is written into. The FDC continues this "Multi-Sector Write Operation" until the issu-

ance of a Terminal Count signal. If a Terminal Count signal is sent to the FDC it continues writing into the current sector to complete the data field. If the Terminal Count signal is received while a data field is being written then the remainder of the data field is filled with 00 (zeros).

The FDC reads the ID field of each sector and checks the CRC bytes. If the FDC detects a read error (incorrect CRC) in one of the ID Fields, it sets the DE (Data Error) flag of Status Register 1 to a 1 (high), and terminates the Write Data Command. (Status Register 0 also has bits 7 and 6 set to 0 and 1 respectively.)

The Write Command operates in much the same manner as the Read Command. The following items

are the same; refer to the Read Data Command for details:

- Transfer Capacity
- EN (End of Cylinder) Flag
- ND (No Data) Flag
- Head Unload Time Interval
- ID Information when the processor terminates command (see Table 2)
- Definition of DTL when $N = 0$ and when $N \neq 0$

In the Write Data mode, data transfers between the processor and FDC must occur every $31 \mu\text{s}$ in the FM mode, and every $15 \mu\text{s}$ in the MFM mode. If the time interval between data transfers is longer than this then the FDC sets the OR (Over Run) flag in Status Register 1 to a 1 (high), and terminates the Write Data Command.

For mini-floppies, multiple track writes are usually not permitted. This is because of the turn-off time of the erase head coils—the head switches tracks before the erase head turns off. Therefore the system should typically wait 1.3 ms before attempting to step or change sides.

WRITE DELETED DATA

This command is the same as the Write Data Command except a Deleted Data Address Mark is written at the beginning of the Data Field instead of the normal Data Address Mark.

READ DELETED DATA

This command is the same as the Read Data Command except that when the FDC detects a Data Address Mark at the beginning of a Data Field (and $SK = 0$ (low)), it will read all the data in the sector and set the CM flag in Status Register 2 to a 1 (high), and then terminate the command. If $SK = 1$, then the FDC skips the sector with the Data Address Mark and reads the next sector.

READ A TRACK

This command is similar to READ DATA Command except that the entire data field is read continuously from each of the sectors of a track. Immediately after encountering the INDEX HOLE, the FDC starts reading all data fields on the track as continuous blocks of data. If the FDC finds an error in the ID or DATA CRC check bytes, it continues to read data from the track. The FDC compares the ID information read from each sector with the value stored in the IDR, and sets the ND flag of Status Register 1 to

a 1 (high) if there is no comparison. Multi-track or skip operations are not allowed with this command.

This command terminates when EOT number of sectors have been read. If the FDC does not find an ID Address Mark on the diskette after it encounters the INDEX HOLE for the second time, then it sets the MA (missing address mark) flag in Status Register 1 to a 1 (high), and terminates the command. (Status Register 0 has bits 7 and 6 set to 0 and 1 respectively.)

READ ID

The READ ID Command is used to give the present position of the recording head. The FDC stores the values from the first ID Field it is able to read. If no proper ID Address Mark is found on the diskette, before the INDEX HOLE is encountered for the second time then the MA (Missing Address Mark) flag in Status Register 1 is set to a 1 (high), and if no data is found then the ND (No Data) flag is also set in Status Register 1 to a 1 (high) and the command is terminated.

FORMAT A TRACK

The Format Command allows an entire track to be formatted. After the INDEX HOLE is detected, Data is written on the Diskette: Gaps, Address Marks, ID Fields and Data Fields, all per the IBM System 34 (Double Density) or System 3740 (Single Density) Format are recorded. The particular format which will be written is controlled by the values programmed into N (number of bytes/sector), SC (sectors/cylinder), GPL (Gap Length), and D (Data Pattern) which are supplied by the processor during the Command Phase. The Data Field is filled with the Byte of data stored in D. The ID Field for each sector is supplied by the processor; that is, four data requests per sector are made by the FDC for C (Cylinder Number), H (Head Number), R (Sector Number) and N (Number of Bytes/Sector). This allows the diskette to be formatted with nonsequential sector numbers, if desired.

After formatting each sector, the processor must send new values for C, H, R, and N to the 8272A for each sector on the track. The contents of the R Register is incremented by one after each sector is formatted, thus, the R register contains a value of $R + 1$ when it is read during the Result Phase. This incrementing and formatting continues for the whole track until the FDC encounters the INDEX HOLE for the second time, whereupon it terminates the command.

If a FAULT signal is received from the FDD at the end of a write operation, then the FDC sets the EC flag of Status Register 0 to a 1 (high), and terminates the command after setting bits 7 and 6 of Status Register 0 to 0 and 1 respectively. Also the loss of a READY signal at the beginning of a com-

mand execution phase causes command termination.

Table 9 shows the relationship between N, SC, and GPL for various sector sizes:

Table 9. Sector Size Relationships

Format	Bytes/ Sector	8" Floppy				Bytes/ Sector	5 1/4" Floppy				Bytes/ Sector	3 1/2" Mini Floppy			
		N	SC	GPL(1)	GPL(2)		N	SC	GPL(1)	GPL(2)		N	SC	GPL(1)	GPL(2)
FM Mode	128	00	1A	07	1B	128	00	12	07	09	128	0	0F	07	1B
	256	01	0F	0E	2A	128	00	10	10	19	—	—	—	—	—
	512	02	08	1B	3A	256	01	08	18	30	256	1	09	0F	2A
	1024	03	04	47	8A	512	02	04	46	87	512	2	05	1B	3A
	2048	04	02	C8	FF	1024	03	02	C8	FF	—	—	—	—	—
4096	05	01	C8	FF	2048	04	01	C8	FF	—	—	—	—	—	—
MPM Mode	256	01	1A	0E	36	256	01	12	0A	0C	256	1	0F	CE	36
	512	02	0F	1B	54	256	01	10	20	32	—	—	—	—	—
	1024	03	08	35	74	512	02	08	2A	50	512	2	09	1B	54
	2048	04	04	99	FF	1024	03	04	80	F0	1024	3	05	35	74
	4096	05	02	C8	FF	2048	04	02	C8	FF	—	—	—	—	—
8192	06	01	C8	FF	4096	05	01	C8	FF	—	—	—	—	—	—

NOTES:

1. Suggested values of GPL in Read or Write Commands to avoid splice point between data field and ID field of contiguous sections.
2. Suggested values of GPL in format command.

SCAN COMMANDS

The SCAN Commands allow data which is being read from the diskette to be compared against data which is being supplied from the main system (Processor in NON-DMA mode, and DMA Controller in DMA mode). The FDC compares the data on a byte-by-byte basis, and looks for a sector of data which meets the conditions of $D_{FDD} = D_{Processor}$, $D_{FDD} < D_{Processor}$, or $D_{FDD} \geq D_{Processor}$. Ones complement arithmetic is used for comparison (FF = largest number, 00 = smallest number). After a whole

sector of data is compared, if the conditions are not met, the sector number is incremented ($R + STP \rightarrow R$), and the scan operation is continued. The scan operation continues until one of the following conditions occur; the conditions for scan are met (equal, low, or high), the last sector on the track is reached (EOT), or the terminal count signal is received.

If the conditions for scan are met then the FDC sets the SH (Scan Hit) flag of Status Register 2 to a 1 (high), and terminates the Scan Command. If the

Table 10. Scan Status Codes

Command	Status Register 2		Comments
	Bit 2 = SN	Bit 3 = SH	
Scan Equal	0	1	$D_{FDD} = D_{Processor}$
	1	0	$D_{FDD} \neq D_{Processor}$
Scan Low or Equal	0	1	$D_{FDD} = D_{Processor}$
	0	0	$D_{FDD} < D_{Processor}$
	1	0	$D_{FDD} > D_{Processor}$
Scan High or Equal	0	1	$D_{FDD} = D_{Processor}$
	0	0	$D_{FDD} > D_{Processor}$
	1	0	$D_{FDD} < D_{Processor}$

conditions for scan are not met between the starting sector (as specified by R) and the last sector on the cylinder (EOT), then the FDC sets the SN (Scan Not Satisfied) flag of Status Register 2 to a 1 (high), and terminates the Scan Command. The receipt of a TERMINAL COUNT signal from the Processor or DMA Controller during the scan operation will cause the FDC to complete the comparison of the particular byte which is in process, and then to terminate the command. Table 10 shows the status of bits SH and SN under various conditions of SCAN.

If the FDC encounters a Deleted Data Address Mark on one of the sectors (and SK = 0), then it regards the sector as the last sector on the cylinder, sets CM (Control Mark) flag of Status Register 2 to a 1 (high) and terminates the command. If SK = 1, the FDC skips the sector with the Deleted Address Mark, and reads the next sector. In the second case (SK = 1), the FDC sets the CM (Control Mark) flag of Status Register 2 to a 1 (high) in order to show that a Deleted Sector had been encountered.

When either the STP (contiguous sectors STP = 01, or alternate sectors STP = 02 sectors are read) or the MT (Multi-Track) are programmed, it is necessary to remember that the last sector on the track must be read. For example, if STP = 02, MT = 0, the sectors are numbered sequentially 1 through 26, and we start the Scan Command at sector 21; the following will happen. Sectors 21, 23, and 25 will be read, then the next sector (26) will be skipped and the Index Hole will be encountered before the EOT value of 26 can be read. This will result in an abnormal termination of the command. If the EOT had been set at 25 or the scanning started at sector 20, then the Scan Command would be completed in a normal manner.

During the Scan Command data is supplied by either the processor or DMA Controller for comparison against the data read from the diskette. In order to avoid having the OR (Over Run) flag set in Status Register 1, it is necessary to have the data available in less than 27 μ s (FM Mode) or 13 μ s (MFM Mode). If an Overrun occurs the FDC terminates the command.

SEEK

The read/write within the FDD is moved from cylinder to cylinder under control of the Seek Command. The FDC compares the PCN (Present Cylinder Number) which is the current head position with the NCN

(New Cylinder Number), and performs the following operation if there is a difference:

PCN < NCN: Direction signal to FDD set to a 1 (high), and Step Pulses are issued. (Step In.)

PCN > NCN: Direction signal to FDD set to a 0 (low), and Step Pulses are issued. (Step Out.)

The rate at which Step Pulses are issued is controlled by SRT (Stepping Rate Time) in the SPECIFY Command. After each Step Pulse is issued NCN is compared against PCN, and when NCN = PCN, then the SE (Seek End) flag is set in Status Register 0 to a 1 (high), and the command is terminated.

During the Command Phase of the Seek operation the FDC is in the FDC BUSY state, but during the Execution Phase it is in the NON BUSY state. While the FDC is in the NON BUSY state, another Seek Command may be issued, and in this manner parallel seek operations may be done on up to 4 Drives at once.

If an FDD is in a NOT READY state at the beginning of the command execution phase or during the seek operation, then the NR (NOT READY) flag is set in Status Register 0 to a 1 (high), and the command is terminated.

Note that the 8272A Read and Write Commands do not have implied Seeks. Any R/W command should be preceded by: 1) Seek Command; 2) Sense Interrupt Status; and 3) Read ID.

RECALIBRATE

This command causes the read/write head within the FDD to retract to the Track 0 position. The FDC clears the contents of the PCN counter, and checks the status of the Track 0 signal from the FDD. As long as the Track 0 signal is low, the Direction signal remains 1 (high) and Step Pulses are issued. When the Track 0 signal goes high, the SE (SEEK END) flag in Status Register 0 is set to a 1 (high) and the command is terminated. If the Track 0 signal is still low after 77 Step Pulses have been issued, the FDC sets the SE (SEEK END) and EC (EQUIPMENT CHECK) flags of Status Register 0 to both 1s (highs), and terminates the command.

The ability to overlap RECALIBRATE Commands to multiple FDDs, and the loss of the READY signal, as described in the SEEK Command, also applies to the RECALIBRATE Command.

SENSE INTERRUPT STATUS

An Interrupt signal is generated by the FDC for one of the following reasons:

- 1) Upon entering the Result Phase of:
 - a) Read Data Command
 - b) Read a Track Command
 - c) Read ID Command
 - d) Read Deleted Data Command
 - e) Write Data Command
 - f) Format a Cylinder Command
 - g) Write Deleted Data Command
 - h) Scan Commands
- 2) Ready Line of FDD changes state
- 3) End of Seek or Recalibrate Command
- 4) During Execution Phase in the NON-DMA Mode

Interrupts caused by reasons 1 and 4 above occur during normal command operations and are easily discernible by the processor. However, interrupts caused by reasons 2 and 3 above may be uniquely identified with the aid of the Sense Interrupt Status Command. This command when issued resets the interrupt signal and via bits 5, 6, and 7 of Status Register 0 identifies the cause of the interrupt.

Neither the Seek or Recalibrate Command have a Result Phase. Therefore, it is mandatory to use the Sense Interrupt Status Command after these commands to effectively terminate them and to provide verification of the head position (PCN).

Table 11. Seek, Interrupt Codes

Seek End Bit 5	Interrupt Code		Cause
	Bit 6	Bit 7	
0	1	1	Ready Line Changed State, Either Polarity
1	0	0	Normal Termination of Seek or Recalibrate Command
1	1	0	Abnormal Termination of Seek or Recalibrate Command

SPECIFY

The Specify Command sets the initial values for each of the three internal timers. The HUT (Head Unload Time) defines the time from the end of the Execution Phase of one of the Read/Write Com-

mands to the head unload state. This timer is programmable from 16 to 240 ms in increments of 16 ms (01 = 16 ms, 02 = 32 ms OF = 240 ms). The SRT (Step Rate Time) defines the time interval between adjacent step pulses. This timer is programmable from 1 to 16 ms in increments of 1 ms (F = 1 ms, E = 2 ms, D = 3 ms, etc.). The HLT (Head Load Time) defines the time between when the Head Load signal goes high and when the Read/Write operation starts. This timer is programmable from 2 to 254 ms in increments of 2 ms (01 = 2 ms, 02 = 4 ms, 03 = 6 ms FE = 254 ms).

The step rate should be programmed 1 ms longer than the minimum time required by the drive.

The time intervals mentioned above are a direct function of the clock (CLK on pin 19). Times indicated above are for an 8 MHz clock, if the clock was reduced to 4 MHz (mini-floppy application) then all time intervals are increased by a factor of 2.

The choice of DMA or NON-DMA operation is made by the ND (NON-DMA) bit. When this bit is high (ND = 1) the NON-DMA mode is selected, and when ND = 0 the DMA mode is selected.

SENSE DRIVE STATUS

This command may be used by the processor whenever it wishes to obtain the status of the FDDs. Status Register 3 contains the Drive Status information.

INVALID

If an invalid command is sent to the FDC (a command not defined above), then the FDC will terminate the command. No interrupt is generated by the 8272A during this condition. Bit 6 and bit 7 (DIO and RQM) in the Main Status Register are both high ("1") indicating to the processor that the 8272A is in the Result Phase and the contents of Status Register 0 (ST0) must be read. When the processor reads Status Register 0 it will find an 80H indicating an invalid command was received.

A Sense Interrupt Status Command must be sent after a Seek or Recalibrate interrupt, otherwise the FDC will consider the next command to be an Invalid Command.

In some applications the user may wish to use this command as a No-Op command, to place the FDC in a standby or no operation state.

Table 12. Status Registers

Bit			Description
No.	Name	Symbol	
STATUS REGISTER 0			
D ₇	Interrupt Code	IC	D ₇ = 0 and D ₆ = 0 Normal Termination of Command, (NT). Command was completed and properly executed.
D ₆			D ₇ = 0 and D ₆ = 1 Abnormal Termination of Command, (AT). Execution of Command was started, but was not successfully completed.
			D ₇ = 1 and D ₆ = 0 Invalid Command issue, (IC). Command which was issued was never started.
			D ₇ = 1 and D ₆ = 1 Abnormal Termination because during command execution the ready signal from FDD changed state.
D ₅	Seek End	SE	When the FDC completes the SEEK Command, this flag is set to 1 (high).
D ₄	Equipment Check	EC	If a fault Signal is received from the FDD, or if the Track 0 Signal fails to occur after 77 Step Pulses (Recalibrate Command) then this flag is set.
D ₃	Not Ready	NR	When the FDD is in the not-ready state and a read or write command is issued, this flag is set. If a read or write command is issued to Side 1 of a single sided drive, then this flag is set.
D ₂	Head Address	HD	This flag is used to indicate the state of the head at Interrupt.
D ₁	Unit Select 1	US 1	These flags are used to indicate a Drive Unit Number at Interrupt.
D ₀	Unit Select 0	US 0	
STATUS REGISTER 1			
D ₇	End of Cylinder	EN	When the FDC tries to access a Sector beyond the final Sector of a Cylinder, this flag is set.
D ₆			Not used. This bit is always 0 (low).
D ₅	Data Error	DE	When the FDC detects a CRC error in either the ID field or the data field, this flag is set.
D ₄	Over Run	OR	If the FDC is not serviced by the main-systems during data transfers, within a certain time interval, this flag is set.
D ₃			Not used. This bit always 0 (low).
D ₂	No Data	ND	During execution of READ DATA, WRITE DELETED DATA or SCAN Command, if the FDC cannot find the Sector specified in the IDR Register, this flag is set.
			During executing the READ ID Command, if the FDC cannot read the ID field without an error, then this flag is set.
			During the execution of the READ A Cylinder Command, if the starting sector cannot be found, then this flag is set.

Table 12. Status Register (Continued)

Bit			Description
No.	Name	Symbol	
STATUS REGISTER 1 (Continued)			
D ₁	Not Writable	NW	During execution of WRITE DATA, WRITE DELETED DATA or Format A Cylinder Command, if the FDC detects a write protect signal from the FDD, then this flag is set.
D ₀	Missing Address Mark	MA	If the FDC cannot detect the ID Address Mark after encountering the index hole twice, then this flag is set.
			If the FDC cannot detect the Data Address Mark or Deleted Data Address Mark, this flag is set. Also at the same time, the MD (Missing Address Mark in Data Field) of Status Register 2 is set.
STATUS REGISTER 2			
D ₇			Not used. This bit is always 0 (low).
D ₆	Control Mark	CM	During executing the READ DATA or SCAN Command, if the FDC encounters a Sector which contains a Deleted Data Address Mark, this flag is set.
D ₅	Data Error in Data Field	DD	If the FDC detects a CRC error in the data field then this flag is set.
D ₄	Wrong Cylinder	WC	This bit is related with the ND bit, and when the contents of C on the medium is different from that stored in the IDR, this flag is set.
D ₃	Scan Equal Hit	SH	During execution, the SCAN Command, if the condition of "equal" is satisfied, this flag is set.
D ₂	Scan Not Satisfied	SN	During executing the SCAN Command, if the FDC cannot find a Sector on the cylinder which meets the condition, then this flag is set.
D ₁	Bad Cylinder	BC	This bit is related with the ND bit, and when the content of C on the medium is different from that stored in the IDR and the content of C is FF, then this flag is set.
D ₀	Missing Address Mark in Data Field	MD	When data is read from the medium, if the FDC cannot find a Data Address Mark or Deleted Data Address Mark, then this flag is set.
STATUS REGISTER 3			
D ₇	Fault	FT	This bit is used to indicate the status of the Fault signal from the FDD.
D ₆	Write Protected	WP	This bit is used to indicate the status of the Write Protected signal from the FDD.
D ₅	Ready	RDY	This bit is used to indicate the status of the Ready signal from the FDD.
D ₄	Track 0	T0	This bit is used to indicate the status of the Track 0 signal from the FDD.
D ₃	Two Side	TS	This bit is used to indicate the status of the Two Side signal from the FDD.
D ₂	Head Address	HD	This bit is used to indicate the status of Side Select signal to the FDD.
D ₁	Unit Select 1	US 1	This bit is used to indicate the status of the Unit Select 1 signal to the FDD.
D ₀	Unit Select 0	US 0	This bit is used to indicate the status of the Unit Select 0 signal to the FDD.

ABSOLUTE MAXIMUM RATINGS*

Operating Temperature0°C to +70°C
Storage Temperature-40°C to +125°C
All Output Voltages-0.5 to +7V
All Input Voltages-0.5 to +7V
Supply Voltage V_{CC}-0.5 to +7V
Power Dissipation1 Watt
* $T_A = 25^\circ\text{C}$	

**Notice: Stresses above those listed under "Absolute Maximum Ratings" may cause permanent damage to the device. This is a stress rating only and functional operation of the device at these or any other conditions above those indicated in the operational sections of this specification is not implied. Exposure to absolute maximum rating conditions for extended periods may affect device reliability.*

D.C. CHARACTERISTICS $T_A = 0^\circ\text{C}$ to $+70^\circ\text{C}$, $V_{CC} = +5V \pm 10\%$

Symbol	Parameter	Limits		Unit	Test Conditions
		Min	Max		
V_{IL}	Input Low Voltage	-0.5	0.8	V	
V_{IH}	Input High Voltage	2.0	$V_{CC} + 0.5$	V	
V_{OL}	Output Low Voltage		0.45	V	$I_{OL} = 2.0\text{ mA}$
V_{OH}	Output High Voltage	2.4	V_{CC}	V	$I_{OH} = -400\ \mu\text{A}$
I_{CC}	V_{CC} Supply Current		120	mA	
I_{IL}	Input Load Current (All Input Pins)		10 -10	μA μA	$V_{IN} = V_{CC}$ $V_{IN} = 0V$
I_{LOH}	High Level Output Leakage Current		10	μA	$V_{OUT} = V_{CC}$
I_{OFL}	Output Float Leakage Current		± 10	μA	$0.45V \leq V_{OUT} \leq V_{CC}$

CAPACITANCE $T_A = 25^\circ\text{C}$, $f_c = 1\text{ MHz}$, $V_{CC} = 0V$

Symbol	Parameter	Limits		Unit	Test Conditions
		Min	Max		
$C_{IN(\phi)}$	Clock Input Capacitance		20	pF	All Pins Except Pin Under Test Tied to AC Ground
C_{IN}	Input Capacitance		10	pF	
$C_{I/O}$	Input/Output Capacitance		20	pF	

A.C. CHARACTERISTICS $T_A = 0^\circ\text{C to } +70^\circ\text{C}$, $V_{CC} = +5.0\text{V} \pm 10\%$

Symbol	Parameter	Typ ⁽¹⁾	Min	Max	Unit	Notes
CLOCK TIMING						
t_{CY}	Clock Period		120	500	ns	(Note 5)
t_{CH}	Clock High Period		40		ns	(Note 4, 5)
t_{RST}	Reset Width		14		t_{CY}	
READ CYCLE						
t_{AR}	Select Setup to $\overline{RD} \downarrow$		0		ns	
t_{RA}	Select Hold from $\overline{RD} \uparrow$		0		ns	
t_{RR}	\overline{RD} Pulse Width		250		ns	
t_{RD}	Data Delay from $\overline{RD} \downarrow$			200	ns	
t_{DF}	Output Float Delay		20	100	ns	
WRITE CYCLE						
t_{AW}	Select Setup to $\overline{WR} \downarrow$		0		ns	
t_{WA}	Select Hold from $\overline{WR} \uparrow$		0		ns	
t_{WW}	\overline{WR} Pulse Width		250		ns	
t_{DW}	Data Setup to $\overline{WR} \uparrow$		150		ns	
t_{WD}	Data Hold from $\overline{WR} \uparrow$		5		ns	
INTERRUPTS						
t_{RI}	INT Delay from $\overline{RD} \uparrow$			500	ns	(Note 6)
t_{WI}	INT Delay from $\overline{WR} \uparrow$			500	ns	(Note 6)
DMA						
t_{RQCY}	DRQ Cycle Period		13		μs	(Note 6)
t_{AKRQ}	$\overline{DACK} \downarrow$ to DRQ \downarrow			200	ns	
t_{RQR}	DRQ \uparrow to $\overline{RD} \downarrow$		800		ns	(Note 6)
t_{RQW}	DRQ \uparrow to $\overline{WR} \downarrow$		250		ns	(Note 6)
t_{RQRW}	DRQ \uparrow to $\overline{RD} \uparrow$ or $\overline{WR} \uparrow$			12	μs	(Note 6)

A.C. CHARACTERISTICS $T_A = 0^\circ\text{C}$ to $+70^\circ\text{C}$, $V_{CC} = +5.0\text{V} \pm 10\%$ (Continued)

Symbol	Parameter	Typ ⁽¹⁾	Min	Max	Unit	Notes
FDD INTERFACE						
t_{WCY}	WCK Cycle Time	2 or 4 1 or 2			μs	MFM = 0 MFM = 1 (Note 2)
t_{WCH}	WCK High Time	250	80	350	ns	
t_{CP}	Pre-Shift Delay from WCK \uparrow		20	100	ns	
t_{CD}	WDA Delay from WCK \uparrow		20	100	ns	
t_{WDD}	Write Data Width		$t_{WCH} - 50$		ns	
t_{WE}	WE \uparrow to WCK \uparrow or WE \downarrow to WCK \downarrow Delay		20	100	ns	
t_{WWCY}	Window Cycle Time	2 1			μs	MM = 0 MFM = 1
t_{WRD}	Window Setup to RDD \uparrow		15		ns	
t_{RDW}	Window Hold from RDD \downarrow		15		ns	
t_{RDD}	RDD Active Time (HIGH)		40		ns	
FDD SEEK/DIRECTION/STEP						
t_{US}	US _{0,1} Setup to \overline{RW} /SEEK \uparrow		12		μs	(Note 6)
t_{SU}	US _{0,1} Hold after \overline{RW} /SEEK \downarrow		15		μs	(Note 6)
t_{SD}	\overline{RW} /SEEK Setup to LCT/DIR		7		μs	(Note 6)
t_{DS}	\overline{RW} /SEEK Hold from LCT/DIR		30		μs	(Note 6)
t_{DST}	LCT/DIR Setup to FR/STEP \uparrow		1		μs	(Note 6)
t_{STD}	LCT/DIR Hold from FR/STEP \downarrow		24		μs	(Note 6)
t_{STU}	DS _{2,1} Hold from FR/Step \downarrow		5		μs	(Note 6)
t_{STP}	STEP Active Time (High)	5			μs	(Note 6)
t_{SC}	STEP Cycle Time		33		μs	(Note 3, 6)
t_{FR}	FAULT RESET Active Time (High)		8	10	μs	(Note 6)
t_{IDX}	INDEX Pulse Width	10			t_{CY}	
t_{TC}	Terminal Count Width		1		t_{CY}	

NOTES:

- Typical values for $T_A = 25^\circ\text{C}$ and nominal supply voltage.
- The former values are used for standard floppy and the latter values are used for mini-floppies.
- $t_{SC} = 33 \mu\text{s}$ min. is for different drive units. In the case of same unit, t_{SC} can be ranged from 1 ms to 16 ms with 8 MHz clock period, and 2 ms to 32 ms with 4 MHz clock, under software control.
- From 2.0V to +2.0V.
- At 4 MHz, the clock duty cycle may range from 16% to 76%. Using an 8 MHz clock the duty cycle can range from 32% to 52%. Duty cycle is defined as: D.C. = $100 (t_{CH} \div t_{CY})$ with typical rise and fall times of 5 ns.
- The specified values listed are for an 8 MHz clock period. Multiply timings by 2 when using a 4 MHz clock period.

A.C. TESTING INPUT, OUTPUT WAVEFORM

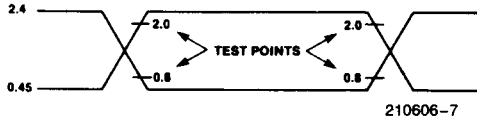

A.C. Testing: Inputs are driven at 2.4V for a Logic "1" and 0.45V for a Logic "0". Timing measurements are made at 2.0V for a Logic "1" and 0.8V for a Logic "0".

A.C. TESTING LOAD CIRCUIT

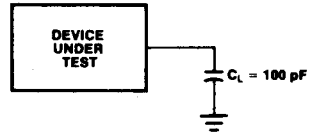

$C_L = 100 \text{ pF}$
 C_L Includes Jig Capacitance

210606-8

WAVEFORMS

PROCESSOR READ OPERATION

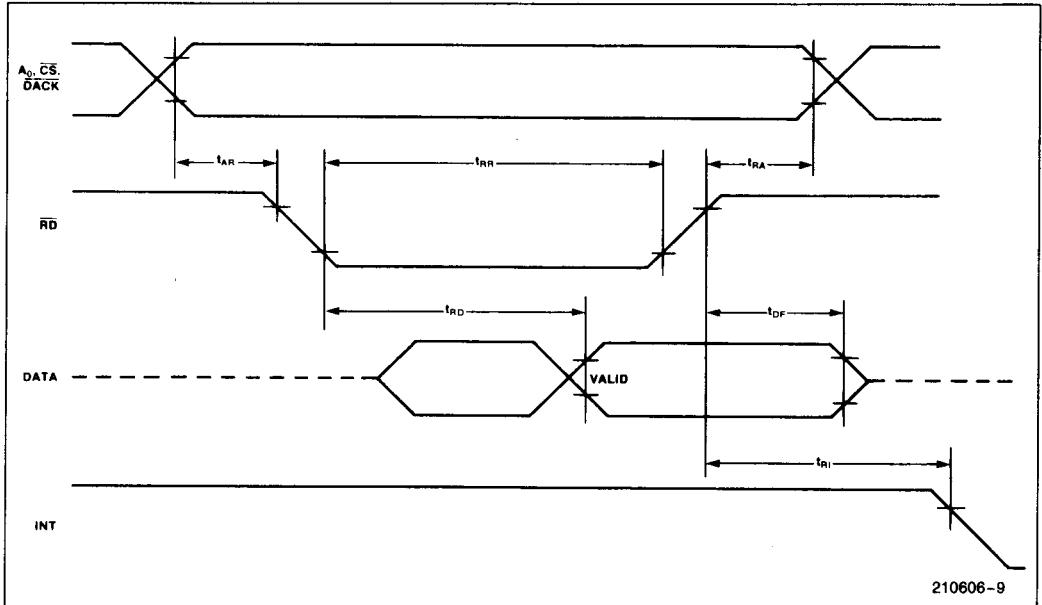

www.DataSheet4U.com

WAVEFORMS (Continued)

PROCESSOR WRITE OPERATION

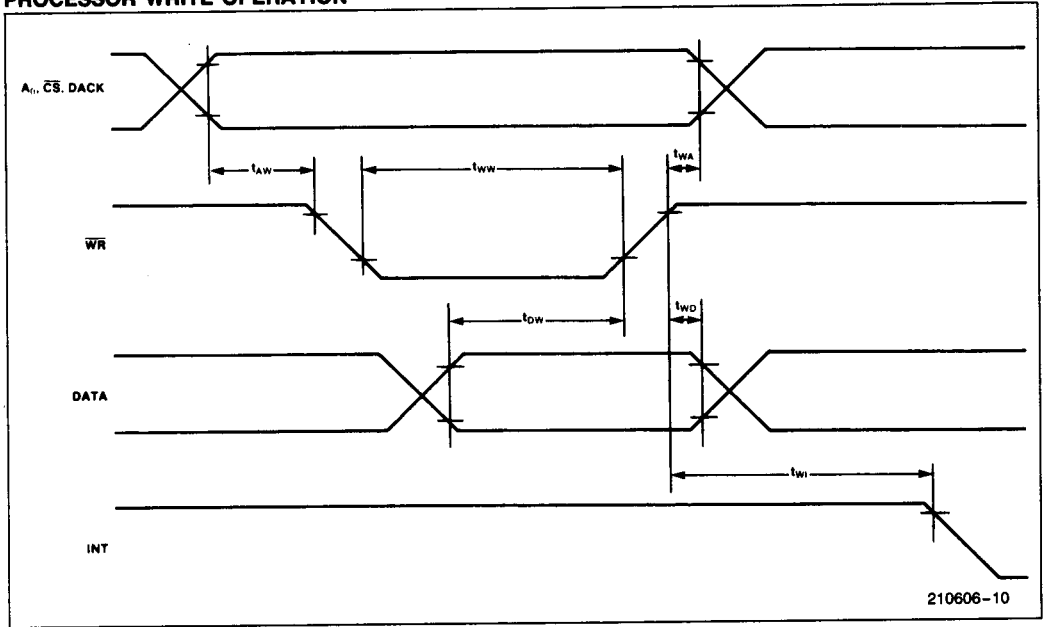

DMA OPERATION

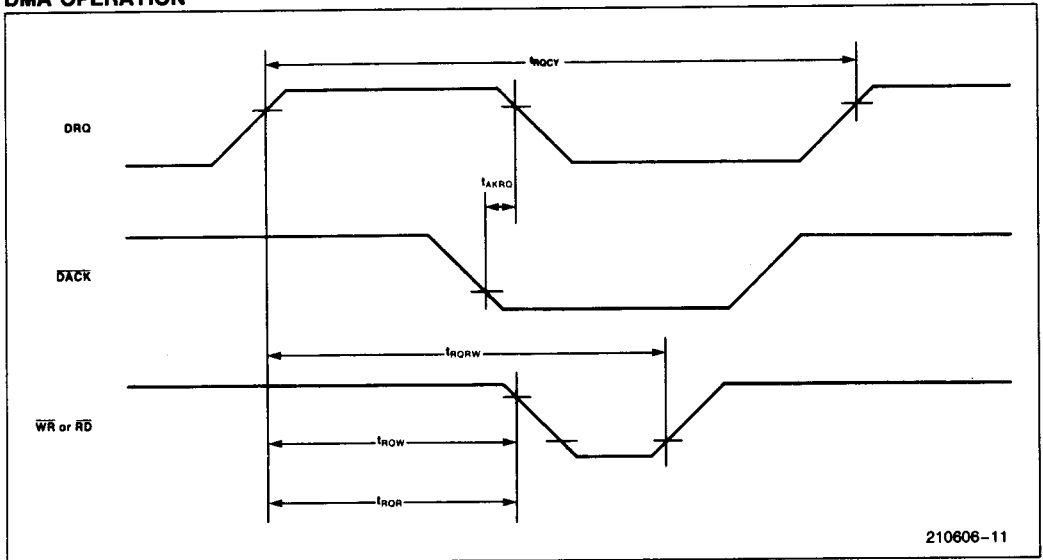

WAVEFORMS (Continued)

CLOCK TIMING

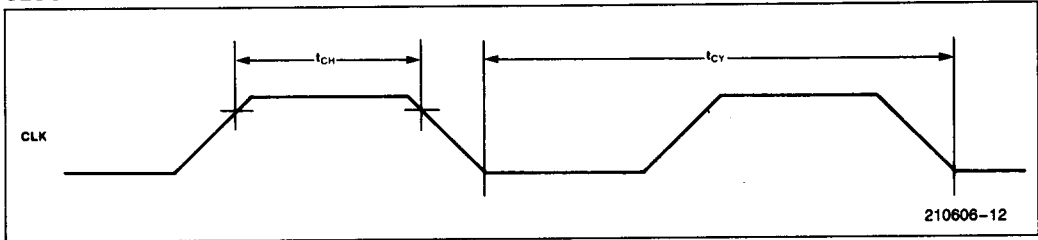

210606-12

FDD WRITE OPERATION

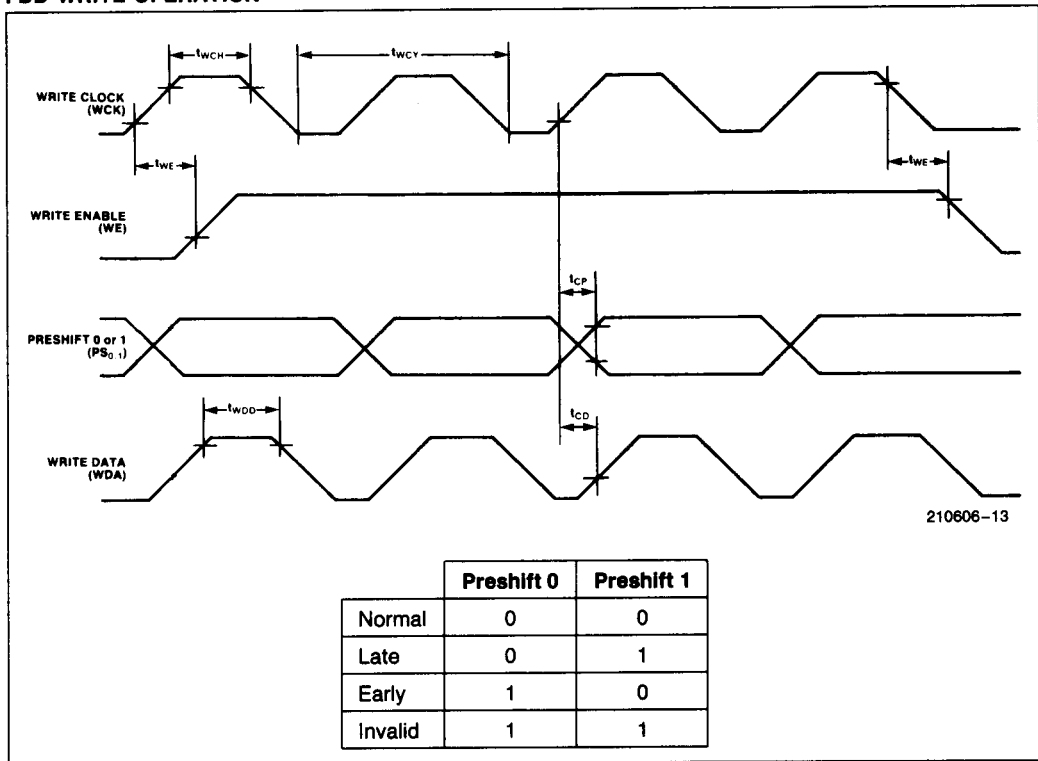

210606-13

	Preshift 0	Preshift 1
Normal	0	0
Late	0	1
Early	1	0
Invalid	1	1

WAVEFORMS (Continued)

SEEK OPERATION

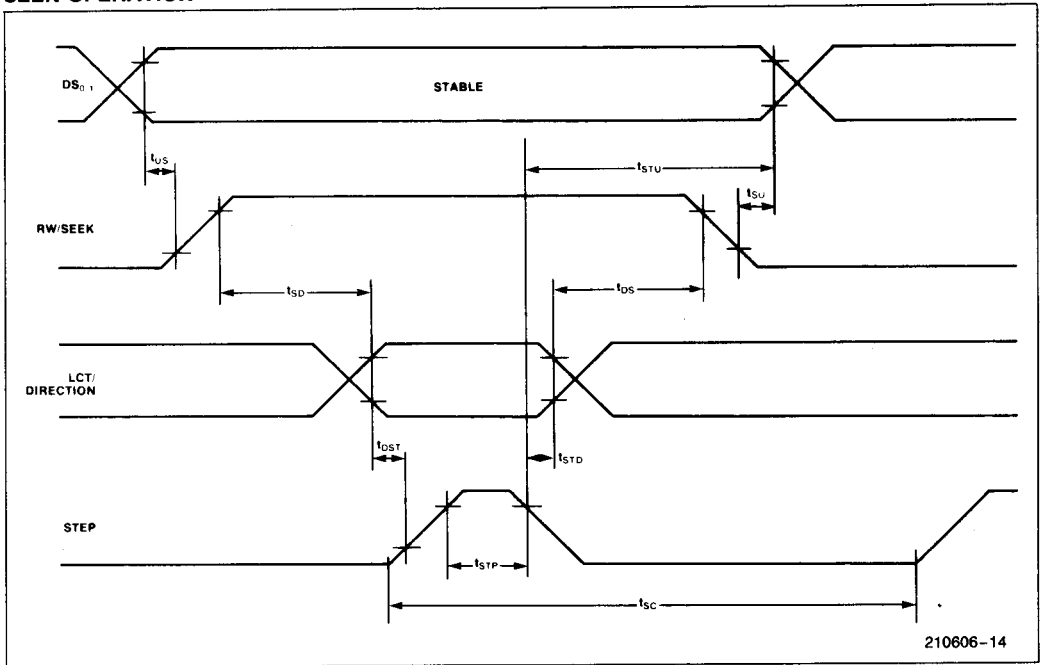

FLT RESET

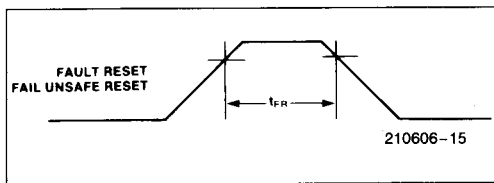

INDEX

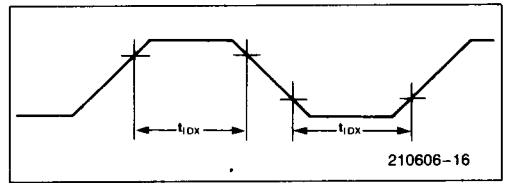

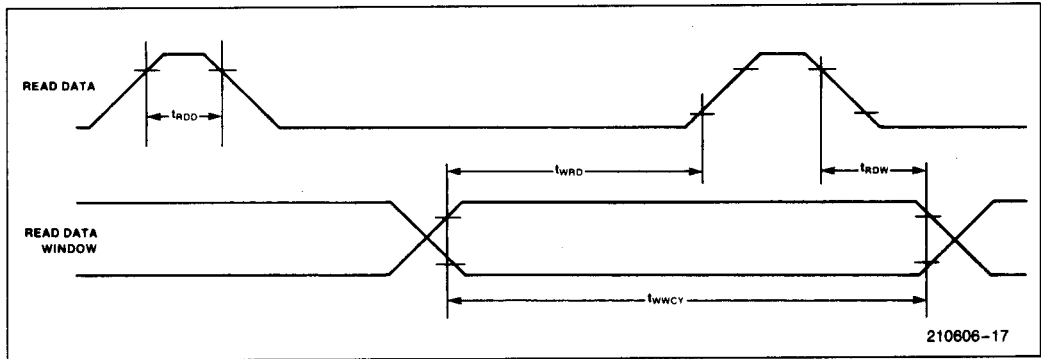
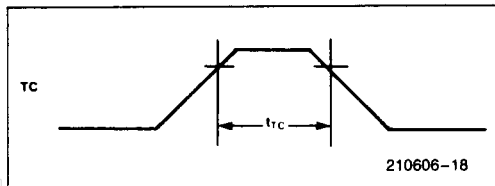
WAVEFORMS (Continued)**FDD READ OPERATION****TERMINAL COUNT****RESET**